

HANDBOOK OF PREPARATIVE INORGANIC CHEMISTRY

VOLUME 1 · SECOND EDITION

Edited by **GEORG BRAUER**

PROFESSOR OF INORGANIC CHEMISTRY
UNIVERSITY OF FREIBURG

TRANSLATED BY **SCRIPTA TECHNICA, INC.**

TRANSLATION EDITOR

REED F. RILEY

ASSOCIATE PROFESSOR OF CHEMISTRY
POLYTECHNIC INSTITUTE OF BROOKLYN

1963



ACADEMIC PRESS • New York • London

COPYRIGHT © 1963 BY ACADEMIC PRESS INC.

ALL RIGHTS RESERVED

NO PART OF THIS BOOK MAY BE REPRODUCED IN ANY FORM
BY PHOTOSTAT, MICROFILM, OR ANY OTHER MEANS,
WITHOUT WRITTEN PERMISSION FROM THE PUBLISHERS.

ACADEMIC PRESS INC.

111 FIFTH AVENUE

NEW YORK 3, N. Y.

United Kingdom Edition

Published by

ACADEMIC PRESS INC. (LONDON) LTD.

BERKELEY SQUARE HOUSE, LONDON W. 1

Library of Congress Catalog Card Number: 63-14307

Translated from the German

HANDBUCH DER PRÄPARATIVEN ANORGANISCHEN CHEMIE

BD. 1, 884 pp., 1960

Published by

FERDINAND ENKE VERLAG, STUTTGART

PRINTED IN THE UNITED STATES OF AMERICA

From the Preface to the First Edition

For many years, the inorganic section of the "Handbook of Preparative Chemistry" by L. Vanino was a laboratory standard. By 1940, however, the third (and last) edition of the handbook was no longer in print. Rather than simply reissue the Vanino manual, the Ferdinand Enke Press projected a completely new book: in contrast to the old, the new work would be written by a number of inorganic chemists, each a specialist in the given field.

As editor, the publishers were able to obtain the services of Prof. Robert Schwartz. It was Prof. Schwartz who laid down what was to be the fundamental guideline for all subsequent work: that only those procedures were to be included which had been tested and confirmed in laboratory practice. Concerning the choice of substances, while not pretending to be exhaustive, the book would cover most of the compounds of inherent scientific interest or of importance for purposes of instruction. At the same time, it was clearly apparent that the common commercial chemicals, as well as those whose preparations require only the simplest chemical operations, need not be included.

The organization of the work took account of the broad scope and varied nature of contemporary preparative inorganic chemistry. The increasingly rigorous purity requirements, the use of unstable substances and those sensitive to air and moisture, the employment of ultralow and ultrahigh temperatures and pressures, etc., have increasingly complicated the experimental apparatus and techniques. Thus, in the introductory part (Preparative Methods) the authors have endeavored to assemble a number of experimental techniques and special apparatus that can be extended to applications much more general than the original purposes for which they were designed. This is complemented by an Index of Techniques at the end of the work. This index links the contents of Part I with the various experimental procedures distributed throughout the work. Space considerations have forced abridgments in several places. Thus, a literature reference must often take the place of a more detailed description. Occasionally, different researchers have solved a given problem by different experimental techniques. Here again a reference to the literature is in order. Naturally, the choice of preferred method is always a subjective decision of the individual experimenter. Thus, our own selection may not always seem correct or adequate to every inorganic chemist. As is customary, please forward any pertinent criticism to either the editor or publisher. It will be gratefully received.

What has been said above also holds true for Part II (Elements and Compounds) and even more so for Part III (Special Groups of Substances). In every case the decision as to inclusion or omission was dictated by considerations of available space. Here, again, the editor would be grateful for any suggestions or criticisms.

Preface to the Second Edition

The first edition of the Handbook of Preparative Inorganic Chemistry was intended to fill a gap in the existing literature. Because it accomplished its mission so well, it has won wide respect and readership. Thus, the authors have been persuaded to issue a second, revised and enlarged edition, even though a relatively brief period has elapsed since the appearance of the first.

The present edition is much more than a revision of the previous work.

Several sections had to be completely rewritten; in a number of cases, the choice of compounds to be included has been changed; above all, recently developed processes, methods and apparatus could not be neglected. The reader will note also that several new authors have cooperated in this venture.

Thus, we are presenting what is in many respects a completely new work. Most of the preparative methods presented here have either been verified by repetition in the author's own laboratory or checked and rechecked in those of our collaborators. We trust that the reader will benefit from the improved reliability and reproducibility that this affords.

The editorial work could not have been completed without the invaluable help of Dr. H. Bärninghausen, Miss G. Boos, and my wife, Doris Brauer. Credit for the careful layout of the more than eighty new or revised drawings found in the book goes to Mrs. U. Sporkert. To all of my co-workers, advisers, colleagues and friends who have given their assistance, I wish to extend my heartfelt thanks.

Translation Editor's Preface

The Handbook of Preparative Inorganic Chemistry by G. Brauer has been a valuable addition to the detailed preparative literature for some years largely because of the number and diversity of methods which are contained in its pages. The translation of this work, therefore, will simplify the task of synthesis for chemists whose German is less than proficient.

Because laboratory practice, as outlined in Part I of the Handbook, is in some ways different from laboratory practice in the United States a number of additions and omissions have been made in the translated text. These include: (1) the removal of the names of German suppliers and trade names and the substitution of American trade names and suppliers, the latter only occasionally, (2) conversion of German glass and ground-glass joint sizes to their American equivalents, (3) substitution throughout the text of "liquid nitrogen" for "liquid air", (4) improvement in the nomenclature where it was judged unclear. In addition, certain brief sections have been omitted or rewritten when the practice or equipment described was outmoded or so different as to be inapplicable in the United States.

It is hoped that these changes have been consistent and wise despite the diffusion of responsibility for the production of a book of this size.

Reed F. Riley

Brooklyn, New York
August, 1963

Conversion of Concentration Units

D_{st} = density of solvent
 D_{sn} = density of solution
 D_{se} = density of solute
 M_{st} = molecular weight of solvent
 M_{se} = molecular weight of solute

	Unit	a	b	c	d
a	g./100 ml. solvent	a	$b \cdot D_{st}$	$\frac{100 \cdot c \cdot D_{st}}{(100 \cdot D_{sn}) - c}$	$\frac{100 \cdot d \cdot D_{st}}{100 - d}$
b	g./100 g. solvent	$\frac{a}{D_{st}}$	b	$\frac{100 \cdot c}{(100 \cdot D_{sn}) - c}$	$\frac{100 \cdot d}{100 - d}$
c	g./100 ml. solution	$\frac{100 \cdot a \cdot D_{sn}}{(100 \cdot D_{st}) + a}$	$\frac{100 \cdot b \cdot D_{sn}}{100 + b}$	c	$d \cdot D_{sn}$
d	g./100 g. solution (wt. %)	$\frac{100 \cdot a}{(100 \cdot D_{st}) + a}$	$\frac{100 \cdot b}{100 + b}$	$\frac{c}{D_{sn}}$	d

		d	e	f
d	g./100 g. solution (wt. %)	d	$\frac{e \cdot D_{se}}{D_{sn}}$	$\frac{100}{1 + \left(\frac{100-f}{f}\right) \frac{M_{st}}{M_{se}}}$
e	ml./100 ml. solution (vol. %)	$\frac{d \cdot D_{sn}}{D_{se}}$	e	$\frac{100 \cdot D_{sn}/D_{se}}{1 + \left(\frac{100-f}{f}\right) \frac{M_{st}}{M_{se}}}$
f	moles/100 moles solution (mole %)	$\frac{100}{1 + \left(\frac{100-d}{d}\right) \frac{M_{se}}{M_{st}}}$	$\frac{100}{1 + \left(\frac{100 \cdot D_{sn}}{e \cdot D_{se}} - 1\right) \frac{M_{se}}{M_{st}}}$	f

$$\text{mole fraction} = \frac{\text{moles of solute}}{\text{total moles}} = \frac{f}{100}$$

$$\text{molality} = \frac{\text{moles of solute}}{1000 \text{ g. of solvent}} = \frac{10 \cdot b}{M_{se}}$$

$$\text{molarity} = \frac{\text{moles of solute}}{1000 \text{ ml. of solution}} = \frac{10 \cdot c}{M_{se}}$$

Example: The concentration of a solution of sulfur in carbon disulfide (15°C, given $D_{sn} = 1.35$, $D_{st} = 1.26$, $D_{se} = 2.07$) is 24.0 g. S/100 ml. CS_2 or 19.05 g. S/100 g. CS_2 or 21.6 g. S/100 ml. solution or 16.0 g. S/100 g. solution or 16.0 wt. % or 10.4 vol. % or 31.2 mole %.

Contents

FROM THE PREFACE TO THE FIRST EDITION.	v
PREFACE TO THE SECOND EDITION.	vi
TRANSLATION EDITOR'S PREFACE	vii
CONVERSION OF CONCENTRATION UNITS.	viii

Part I

Preparative Methods

PREPARATIVE METHODS	3
Assembly of Apparatus	4
Glass	5
Ceramic Materials	12
Metals	17
Plastics	25
Pure Solvents	25
Mercury	27
Sealing Materials and Lubricants	28
High Temperatures	32
Low Temperatures	42
Constant Temperature	45
Temperature Measurement	49
High Vacuum and Exclusion of Air	53
Special Vacuum Systems	66
Gases	77
Liquefied Gases as Solvent Media	86
Electrical Discharges	90
Purification of Substances	91
Analysis of Purity	100
Powder Reactions	103

Part II

Elements and Compounds

SECTION I. HYDROGEN, DEUTERIUM, WATER	111
Hydrogen H ₂	111
Pure Water	117
Deuterium and Deuterium Compounds	119
Deuterium D ₂	121

Hydrogen Deuteride HD	126
Deuterium Fluoride DF	127
Deuterium Chloride DCl	129
Deuterium Bromide DBr	131
Deuterium Iodide DI	133
Deuterium Sulfide D ₂ S	134
Deuteriosulfuric Acid D ₂ SO ₄	135
Deuteroammonia ND ₃	137
Deuterophosphoric Acid D ₃ PO ₄	138
SECTION 2. HYDROGEN PEROXIDE	140
Hydrogen Peroxide H ₂ O ₂	140
SECTION 3. FLUORINE, HYDROGEN FLUORIDE	143
Fluorine F ₂	143
Hydrogen Fluoride HF	145
SECTION 4. FLUORINE COMPOUNDS	150
General Remarks	150
Chlorine Monofluoride ClF	153
Chlorine Trifluoride ClF ₃	155
Bromine Trifluoride BrF ₃	156
Bromine Pentafluoride BrF ₅	158
Iodine Pentafluoride IF ₅	159
Iodine Heptafluoride IF ₇	160
Dioxygen Difluoride O ₂ F ₂	162
Oxygen Difluoride OF ₂	163
Chlorine Dioxide Fluoride ClO ₂ F	165
Chlorine Trioxide Fluoride ClO ₃ F	166
Chlorine Tetroxide Fluoride ClO ₄ F	167
Sulfur Tetrafluoride SF ₄	168
Sulfur Hexafluoride SF ₆	169
Thionyl Fluoride SOF ₂	170
Thionyl Tetrafluoride SOF ₄	171
Sulfuryl Fluoride SO ₂ F ₂	173
Trisulfuryl Fluoride S ₃ O ₃ F ₃	174
Thionyl Chloride Fluoride SOClF	174
Sulfuryl Chloride Fluoride SO ₂ ClF	175
Sulfuryl Bromide Fluoride SO ₂ BrF	176
Fluorosulfonic Acid HSO ₃ F	177
Potassium Fluorosulfinate KSO ₂ F	178
Selenium Hexafluoride SeF ₆	179
Selenium Tetrafluoride SeF ₄	180
Tellurium Hexafluoride TeF ₆	180
Nitrogen Trifluoride NF ₃	181
Ammonium Fluoride NH ₄ F	183
Ammonium Hydrogen Fluoride NH ₄ F · HF	183

Nitrosyl Fluoride NOF	184
Nitrososulfuryl Fluoride FSO ₂ NO	186
Nitryl Fluoride NO ₂ F	186
Fluorine Nitrate NO ₃ F	187
Phosphorus (III) Fluoride PF ₃	189
Phosphorus (V) Fluoride PF ₅	190
Phosphorus Dichloride Fluoride PCl ₂ F	191
Phosphorus Dichloride Trifluoride PCl ₂ F ₃	192
Phosphorus Oxide Trifluoride POF ₃	193
Tetrachlorophosphonium Hexafluorophosphate (V) PCl ₄ · PF ₆	193
Phosphonitric Fluorides (PNF ₂) ₃ , (PNF ₂) ₄	194
Ammonium Hexafluorophosphate (V) NH ₄ PF ₆	195
Ammonium Difluorophosphate (V) NH ₄ PO ₂ F ₂	196
Potassium Hexafluorophosphate (V) KPF ₆	196
Arsenic (III) Fluoride AsF ₃	197
Arsenic (V) Fluoride AsF ₅	198
Antimony (III) Fluoride SbF ₃	199
Antimony (V) Fluoride SbF ₅	200
Antimony Dichloride Trifluoride SbCl ₂ F ₃	200
Bismuth (III) Fluoride BiF ₃	201
Bismuth (V) Fluoride BiF ₅	202
Carbon Tetrafluoride CF ₄	203
Trifluoromethane CHF ₃	204
Trifluoroiodomethane CIF ₃	205
Carbonyl Fluoride COF ₂	206
Carbonyl Chlorofluoride COClF	208
Carbonyl Bromofluoride COBrF	210
Carbonyl Iodofluoride COIF	211
Silicon Tetrafluoride SiF ₄	212
Trifluorosilane SiHF ₃	214
Hexafluorosilicic Acid H ₂ SiF ₆	214
Germanium Tetrafluoride GeF ₄	215
Potassium Hexafluorogermanate K ₂ GeF ₆	216
Tin (II) Fluoride SnF ₂	217
Tin (IV) Fluoride SnF ₄	217
Lead (II) Fluoride PbF ₂	218
Lead (IV) Fluoride PbF ₄	219
Boron Trifluoride BF ₃	219
Fluoroboric Acid HBF ₄	221
Sodium Fluoroborate NaBF ₄	222
Potassium Fluoroborate KBF ₄	223
Potassium Hydroxyfluoroborate KBF ₃ OH	223
Nitrosyl Fluoroborate NOBF ₄	224
Aluminum Fluoride	225
Ammonium Hexafluoroaluminate (NH ₄) ₃ AlF ₆	226
Ammonium Tetrafluoroaluminate NH ₄ AlF ₄	227

Gallium (III) Fluoride GaF_3	227
Ammonium Hexafluorogallate $(\text{NH}_4)_3(\text{GaF}_6)$	228
Indium (III) Fluoride InF_3	228
Ammonium Hexafluoroindate $(\text{NH}_4)_3(\text{InF}_6)$	229
Thallium (I) Fluoride TlF	230
Thallium (III) Fluoride TlF_3	230
Beryllium Fluoride BeF_2	231
Ammonium Tetrafluoroberyllate $(\text{NH}_4)_2\text{BeF}_4$	232
Magnesium Fluoride MgF_2	232
Calcium Fluoride CaF_2	233
Strontium Fluoride SrF_2	234
Barium Fluoride BaF_2	234
Lithium Fluoride LiF	235
Sodium Fluoride NaF	235
Potassium Fluoride KF	236
Potassium Hydrogen Fluoride $\text{KF} \cdot \text{HF}$	237
Potassium Tetrafluorobromate (III) KBrF_4	237
Potassium Hexafluoroiodate (V) KIF_6	238
Copper (II) Fluoride CuF_2	238
Silver Subfluoride Ag_2F	239
Silver Fluoride AgF	240
Silver (II) Fluoride AgF_2	241
Zinc Fluoride ZnF_2	242
Cadmium Fluoride CdF_2	243
Mercury (I) Fluoride Hg_2F_2	243
Mercury (II) Fluoride HgF_2	244
Scandium Fluoride ScF_3	245
Yttrium Fluoride YF_3	246
Lanthanum Fluoride LaF_3	246
Cerium (III) Fluoride CeF_3	247
Cerium (IV) Fluoride CeF_4	247
Europium (II) Fluoride EuF_2	248
Titanium (III) Fluoride TiF_3	248
Titanium (IV) Fluoride TiF_4	250
Zirconium (IV) Fluoride ZrF_4	251
Vanadium (III) Fluoride VF_3	252
Vanadium (IV) Fluoride VF_4	252
Vanadium (V) Fluoride VF_5	253
Niobium (V) Fluoride NbF_5	254
Potassium Heptafluoroniobate (V) K_3NbF_7	255
Tantalum (V) Fluoride TaF_5	255
Potassium Heptafluorotantalate (V) K_2TaF_7	256
Chromium (II) Fluoride CrF_2	256
Chromium (III) Fluoride CrF_3	257
Chromium (IV) Fluoride CrF_4	258
Chromyl Fluoride CrO_2F_2	258
Molybdenum (VI) Fluoride MoF_6	259

Tungsten (VI) Fluoride WF_6	260
Uranium (IV) Fluoride UF_4	261
Uranium (VI) Fluoride UF_6	262
Manganese (II) Fluoride MnF_2	262
Manganese (III) Fluoride MnF_3	263
Potassium Hexafluoromanganate (IV) K_2MnF_6	264
Rhenium (VI) Fluoride ReF_6	264
Iron (II) Fluoride FeF_2	266
Iron (III) Fluoride FeF_3	266
Cobalt (II) Fluoride CoF_2	267
Cobalt (III) Fluoride CoF_3	268
Nickel (II) Fluoride NiF_2	269
Potassium Hexafluoronickelate (IV) K_2NiF_6	269
Iridium (VI) Fluoride IrF_6	270
SECTION 5. CHLORINE, BROMINE, IODINE	272
Chlorine Cl_2	272
Chlorine Hydrate $Cl_2 \cdot 6 H_2O$	274
Bromine Br_2	275
Bromine Hydrate $Br_2 \cdot 8 H_2O$	276
Iodine I_2	277
Hydrogen Chloride HCl	280
Hydrogen Bromide HBr	282
Hydrogen Iodide HI	286
Ammonium Iodide NH_4I	289
Potassium Iodide KI	290
Iodine Monochloride ICl	290
Iodine Monobromide IBr	291
Iodine Trichloride ICl_3	292
Polyhalides	293
Potassium Triiodide $KI_3 \cdot H_2O$	294
Cesium Dichlorobromide $CsBrCl_2$	294
Potassium Dichloriodide $KICl_2$	295
Cesium Dichloriodide $CsICl_2$	296
Potassium Dibromiodide $KIBr_2$	296
Cesium Dibromiodide $CsIBr_2$	297
Potassium Tetrachloriodide $KICl_4$	298
Tetrachloriodic Acid $HICl_4 \cdot 4 H_2O$	299
Dichlorine Oxide Cl_2O	299
Chlorine Dioxide ClO_2	301
Dichlorine Hexoxide Cl_2O_6	303
Dichlorine Heptoxide Cl_2O_7	304
Bromine Oxides	306
Diiodine Pentoxide I_2O_5	307
Hypochlorous Acid $HClO$	308
Sodium Hypochlorite $NaClO \cdot 5 H_2O$	309
Sodium Hypobromite $NaBrO \cdot 5 H_2O$	310

Potassium Hypobromite $\text{KBrO} \cdot 3 \text{H}_2\text{O}$	311
Sodium Chlorite $\text{NaClO}_2 \cdot 3 \text{H}_2\text{O}$	312
Chloric Acid HClO_3	312
Ammonium Chlorate NH_4ClO_3	313
Barium Chlorate $\text{Ba}(\text{ClO}_3)_2 \cdot \text{H}_2\text{O}$	314
Bromic Acid HBrO_3	315
Barium Bromate $\text{Ba}(\text{BrO}_3)_2 \cdot \text{H}_2\text{O}$	316
Iodic Acid HIO_3	316
Perchloric Acid HClO_4	318
Alkaline Earth Perchlorates	320
Nitrosyl Perchlorate NOClO_4	320
Nitryl Perchlorate NO_2ClO_4	321
Periodic Acid H_5IO_6	322
Sodium Periodates $\text{Na}_3\text{H}_2\text{IO}_6$, NaIO_4	323
Potassium Periodate KIO_4	325
Barium Periodate $\text{Ba}_3\text{H}_4(\text{IO}_6)_2$	326
Chlorine Nitrate ClNO_3	326
Dipyridineiodine (I) Perchlorate $[\text{I}(\text{C}_5\text{H}_5\text{N})_2]\text{ClO}_4$	327
Bromine (III) Nitrate $\text{Br}(\text{NO}_3)_3$	328
Iodine (III) Nitrate $\text{I}(\text{NO}_3)_3$	329
Iodine (III) Sulfate $\text{I}_2(\text{SO}_4)_3$	329
Iodine (III) Perchlorate $\text{I}(\text{ClO}_4)_3$	330
Iodine (III) Iodate $\text{I}(\text{IO}_3)_3$ or I_4O_9	331
Oxiodine (III) Sulfate $(\text{IO})_2\text{SO}_4 \cdot \text{H}_2\text{O}$	332
Diiodine Tetroxide $\text{IO} \cdot \text{IO}_3$ or I_2O_4	333
SECTION 6. OXYGEN, OZONE	334
Oxygen O_2	334
Ozone O_3	337
SECTION 7. SULFUR, SELENIUM, TELLURIUM	341
Sulfur S	341
Hydrogen Sulfide H_2S	344
Crude Sulfane H_2S_x	346
Pure Sulfanes	349
Ammonium Hydrogen Sulfide NH_4HS	357
Sodium Hydrogen Sulfide NaHS	357
Sodium Sulfide Na_2S	358
Potassium Sulfide K_2S	360
Sodium Disulfide Na_2S_2	361
Potassium Disulfide K_2S_2	363
Potassium Trisulfide K_2S_3	364
Sodium Tetrasulfide Na_2S_4	365
Potassium Tetrasulfide K_2S_4	366
Sodium Pentasulfide Na_2S_5	367
Potassium Pentasulfide K_2S_5	367
Potassium Hexasulfide K_2S_6	368

Ammonium Pentasulfide $(\text{NH}_4)_2\text{S}_5$	369
Dichloromonosulfane SCl_2	370
Dichlorodisulfane S_2Cl_2	371
Dichlorotri-, -tetra-, -penta-, -hexa-, -hepta- and -octa- sulfane S_3Cl_2 , S_4Cl_2 , S_5Cl_2 , S_6Cl_2 , S_7Cl_2 , S_8Cl_2	372
Dichlorotrisulfane S_3Cl_2	373
Dichlorotetrasulfane S_4Cl_2	375
Sulfur Tetrachloride SCl_4	376
Dibromodisulfane S_2Br_2	377
Dibromotri-, -tetra-, -penta-, -hexa-, -hepta- and -octa- sulfane S_3Br_2 , S_4Br_2 , S_5Br_2 , S_6Br_2 , S_7Br_2 , S_8Br_2	379
Lower Sulfur Oxides S_2O , SO	379
Disulfur Trioxide S_2O_3	380
Polysulfur Peroxide $(\text{SO}_{3-4})_x$	382
Thionyl Chloride SOCl_2	382
Sulfuryl Chloride SO_2Cl_2	383
Chlorosulfonic Acid HSO_3Cl	385
Pyrosulfuryl Chloride $\text{S}_2\text{O}_5\text{Cl}_2$	386
Thionyl Bromide SOBr_2	387
Peroxymonosulfuric Acid H_2SO_5	388
Peroxydisulfuric Acid $\text{H}_2\text{S}_2\text{O}_8$	389
Ammonium Peroxydisulfate $(\text{NH}_4)_2\text{S}_2\text{O}_8$	390
Potassium Peroxydisulfate $\text{K}_2\text{S}_2\text{O}_8$	392
Cobalt Sulfoxylate $\text{CoSO}_2 \cdot 3 \text{H}_2\text{O}$	393
Sodium Dithionite $\text{Na}_2\text{S}_2\text{O}_4 \cdot 2 \text{H}_2\text{O}$	393
Zinc Dithionite ZnS_2O_4	394
Sodium Dithionate $\text{Na}_2\text{S}_2\text{O}_6 \cdot 2 \text{H}_2\text{O}$	395
Barium Dithionate $\text{BaS}_2\text{O}_6 \cdot 2 \text{H}_2\text{O}$	397
Potassium Trithionate $\text{K}_2\text{S}_3\text{O}_6$	398
Potassium Tetrathionate $\text{K}_2\text{S}_4\text{O}_6$	399
Potassium Pentathionate $\text{K}_2\text{S}_5\text{O}_6 \cdot 1.5 \text{H}_2\text{O}$	401
Potassium Hexathionate $\text{K}_2\text{S}_6\text{O}_6$	403
Wackenroder Liquid	405
Polythionic Acids $\text{H}_2\text{S}_x\text{O}_3$, $\text{H}_2\text{S}_x\text{O}_6$	405
Nitrosyl Hydrogen Sulfate $(\text{NO})\text{HSO}_4$	406
Tetrasulfur Tetranitride S_4N_4	406
Tetrasulfur Dinitride S_4N_2	408
Disulfur Dinitride S_2N_2	409
Sulfur Nitride Tetrahydride $\text{S}_4(\text{NH})_4$	411
Heptasulfur Imide S_7NH	411
α -Sulfanuric Chloride $[\text{OS}(\text{N})\text{Cl}]_3$	412
Trisulfur Dinitrogen Dioxide $\text{S}_3\text{N}_2\text{O}_2$	413
Trisulfur Dinitrogen Pentoxide $\text{S}_3\text{N}_2\text{O}_5$	414
Selenium Se.	415
Hydrogen Selenide H_2Se	418
Sodium Hydrogen Selenide NaHSe	419
Sodium Selenide, Potassium Selenide Na_2Se , K_2Se	421

Sodium Diselenide Na_2Se_2	421
Diselenium Dichloride Se_2Cl_2	422
Selenium Tetrachloride SeCl_4	423
Hexachloroselenium Salts	425
Diselenium Dibromide Se_2Br_2	426
Selenium Tetrabromide SeBr_4	427
Selenium Dioxide SeO_2	428
Selenium Oxychloride SeOCl_2	429
Selenous Acid (anhydrous) H_2SeO_3	430
Sodium Selenite $\text{Na}_2\text{SeO}_3 \cdot 5 \text{H}_2\text{O}$	431
Selenic Acid H_2SeO_4	432
Sodium Selenate Na_2SeO_4	433
Sodium Selenopentathionate $\text{Na}_2\text{SeS}_4\text{O}_8 \cdot 3 \text{H}_2\text{O}$	434
Selenium Sulfur Trioxide SeSO_3	435
Selenium Nitride Se_4N_4	435
Tellurium Te	437
Colloidal Tellurium Solution	438
Hydrogen Telluride H_2Te	438
Sodium Telluride, Potassium Telluride Na_2Te , K_2Te	441
Sodium Ditetelluride Na_2Te_2	442
Tellurium Tetrachloride TeCl_4	442
Hexachlorotellurium Salts	444
Tellurium Tetrabromide TeBr_4	445
Tellurium Tetraiodide TeI_4	447
Tellurium Dioxide TeO_2	447
Tellurous Acid H_2TeO_3	449
Sodium Tellurite Na_2TeO_3	449
Tellurium Trioxide TeO_3	450
Telluric Acid H_6TeO_6	451
Sodium Tetrahydrogentellurate (VI) $\text{Na}_2\text{H}_4\text{TeO}_6$	453
Sodium Orthotellurate Na_6TeO_6	453
Sodium Telluropentathionate $\text{Na}_2\text{TeS}_4\text{O}_8 \cdot 2 \text{H}_2\text{O}$	454
Tellurium Sulfur Trioxide TeSO_3	455
SECTION 8. NITROGEN	457
Nitrogen N_2	457
Ammonia NH_3	460
Lithium Amide LiNH_2	463
Lithium Imide Li_2NH	464
Sodium Amide NaNH_2	465
Hydrazinium Sulfate $\text{N}_2\text{H}_6\text{SO}_4$	468
Hydrazine Hydrate $\text{N}_2\text{H}_4 \cdot \text{H}_2\text{O}$	469
Hydrazine N_2H_4	469
Hydrazoic Acid HN_3	472
Azides	474
Chlorine Azide ClN_3	476

Monochloramine ClNH_2	477
Nitrogen Trichloride NCl_3	479
Nitrogen Triiodide and Tribromide, Monobromamine . . .	480
Thionyl Imide SONH	480
Sulfamide $\text{SO}_2(\text{NH}_2)_2$	482
Trisulfimide and Its Silver Salt $(\text{SO}_2\text{NH})_3 (\text{SO}_2\text{N})_3\text{Ag}_3 \cdot 3 \text{H}_2\text{O}$	483
Nitrous Oxide N_2O	484
Nitric Oxide NO	485
Nitrogen Trioxide N_2O_3	487
Nitrogen Dioxide NO_2 , N_2O_4	488
Nitrogen Pentoxide N_2O_5	489
Nitric Acid HNO_3	491
Hyponitrous Acid $\text{H}_2\text{N}_2\text{O}_2$	492
Silver Hyponitrite $\text{Ag}_2\text{N}_2\text{O}_2$	493
Sodium Hyponitrite $\text{Na}_2\text{N}_2\text{O}_2 \cdot 9 \text{H}_2\text{O}$	495
Nitramide NH_2NO_2	496
Hydroxylammonium Chloride $(\text{NH}_3\text{OH})\text{Cl}$	498
Hydroxylammonium Salts.	500
Hydroxylamine NH_2OH	501
Potassium Hydroxylamine Disulfonate $\text{HON}(\text{SO}_3\text{K})_2$	503
Potassium Dinitrososulfite $\text{K}_2\text{SO}_3 \cdot (\text{NO})_2$	504
Potassium Nitrosodisulfonate $\text{ON}(\text{SO}_3\text{K})_2$	504
Potassium Nitrilosulfonate $\text{N}(\text{SO}_3\text{K})_3 \cdot 2 \text{H}_2\text{O}$	506
Potassium Imidosulfonate $\text{HN}(\text{SO}_3\text{K})_2$	506
Potassium Amidosulfonate $\text{H}_2\text{NSO}_3\text{K}$	507
Potassium Chloroimidosulfonate $\text{ClN}(\text{SO}_3\text{K})_2$	508
Amidosulfonic acid $\text{H}_2\text{NSO}_3\text{H}$	508
Potassium Hydrazinedisulfonate $\text{H}_2\text{N}_2(\text{SO}_3\text{K})_2$	509
Potassium Azodisulfonate $\text{N}_2(\text{SO}_3\text{K})_2$	510
Hydroxylamineisomonosulfonic Acid NH_3SO_4	510
Nitrosyl Chloride NOCl	511
Nitrosyl Bromide NOBr	513
Nitryl Chloride NO_2Cl	513
Sodium Nitrosyl NaNO	514
Sodium Nitroxylate Na_2NO_2	515
Sodium Hyponitrate $\text{Na}_2\text{N}_2\text{O}_3$	517
SECTION 9. PHOSPHORUS	518
White Phosphorus P_4	518
Red Phosphorus	519
Black Phosphorus	522
Colloidal Phosphorus	524
Phosphine and Diphosphine PH_3 P_2H_4	525
Sodium Dihydrogenphosphide NaPH_2	530
Phosphonium Iodide PH_4I	531

Thiophosphoryl Chloride PSCl_3	532
Phosphoryl (V) Bromide POBr_3	534
Thiophosphoryl (V) Bromide PSBr_3	535
Diphosphoric Acid Tetrachloride $\text{P}_2\text{O}_3\text{Cl}_4$	536
Diphosphorus Tetraiodide P_2I_4	539
Phosphorus (III) Iodide PI_3	540
Phosphorus (V) Oxide P_2O_5 (P_4O_{10})	541
Orthophosphoric Acid H_3PO_4	543
Sodium Dihydrogen Phosphate $\text{NaH}_2\text{PO}_4 \cdot 2\text{H}_2\text{O}$	544
Potassium Phosphate $\text{K}_3\text{PO}_4 \cdot 8\text{H}_2\text{O}$	545
Hydroxyapatite $\text{Ca}_{10}(\text{PO}_4)_6(\text{OH})_2$	545
Condensed Orthophosphates	546
Polyphosphates	549
Metaphosphates	552
Orthophosphorous Acid H_3PO_3	554
Hypophosphorous Acid H_3PO_2	555
Barium Hypophosphite $\text{Ba}(\text{H}_2\text{PO}_2)_2 \cdot \text{H}_2\text{O}$	557
Hypophosphoric Acid $\text{H}_4\text{P}_2\text{O}_6$	558
Disodium Dihydrogen Hypophosphate $\text{Na}_2\text{H}_2\text{P}_2\text{O}_6 \cdot 6\text{H}_2\text{O}$	560
Tetrasodium Hypophosphate $\text{Na}_4\text{P}_2\text{O}_6 \cdot 10\text{H}_2\text{O}$	561
Barium Dihydrogen Hypophosphite $\text{BaH}_2\text{P}_2\text{O}_6 \cdot 2\text{H}_2\text{O}$	562
Potassium Peroxydiphosphate $\text{K}_4\text{P}_2\text{O}_8$	562
Phosphorus Trisulfide P_4S_3	563
Phosphorus Pentasulfide P_4S_5	565
Phosphorus Heptasulfide P_4S_7	566
Diphosphorus Pentasulfide P_2S_5	567
Monothiophosphoric Acid $\text{H}_3\text{PO}_3\text{S}$	568
Sodium Monothiophosphate $\text{Na}_3\text{PO}_3\text{S} \cdot 12\text{H}_2\text{O}$	569
Sodium Dithiophosphate $\text{Na}_3\text{PO}_2\text{S}_2 \cdot 11\text{H}_2\text{O}$	570
Barium Dithiophosphate $\text{Ba}_3(\text{PO}_2\text{S}_2)_2 \cdot 8\text{H}_2\text{O}$	571
Sodium Trithiophosphate $\text{Na}_3\text{POS}_3 \cdot 11\text{H}_2\text{O}$	571
Sodium Tetrathiophosphate $\text{Na}_3\text{PS}_4 \cdot 8\text{H}_2\text{O}$	572
Tetraphosphorus Triselenide P_4Se_3	573
Triphosphorus Pentanitride P_3N_5	574
Phosphonitrilic Chlorides $(\text{PNCl}_2)_n$	575
Phosphonitrilic Bromides $(\text{PNBr}_2)_n$	578
Monoamidophosphoric Acid $\text{H}_2\text{PO}_3\text{NH}_2$	579
Disodium Monoamidophosphate $\text{Na}_2\text{PO}_3\text{NH}_2 \cdot 6\text{H}_2\text{O}$	581
Diamidophosphoric Acid $\text{HPO}_2(\text{NH}_2)_2$	582
Phosphoryl Triamide $\text{PO}(\text{NH}_2)_3$	584
Thiophosphoryl Triamide $\text{PS}(\text{NH}_2)_3$	587
Pyrophosphoryl Tetramide $\text{P}_2\text{O}_3(\text{NH}_2)_4$	588
Tetrasodium Imidodiphosphate $\text{Na}_4\text{P}_2\text{O}_6\text{NH} \cdot 10\text{H}_2\text{O}$	589
SECTION 10. ARSENIC, ANTIMONY, BISMUTH	591
Arsenic As	591

Arsine AsH_3	593
Sodium Dihydrogen Arsenide NaAsH_2	595
Arsenic Trichloride AsCl_3	596
Arsenic Tribromide AsBr_3	597
Arsenic Triiodide AsI_3	597
Arsenic Diiodide AsI_2	598
Diarsenic Trioxide As_2O_3 (As_4O_6)	600
Orthoarsenic Acid H_3AsO_4	601
Sodium Dihydrogen Orthoarsenate $\text{NaH}_2\text{AsO}_4 \cdot \text{H}_2\text{O}$	602
Ammonium Orthoarsenate $(\text{NH}_4)_3\text{AsO}_4 \cdot 3 \text{H}_2\text{O}$	602
Tetraarsenic Tetrasulfide As_4S_4	603
Diarsenic Pentasulfide As_2S_5	603
Ammonium Thioarsenate $(\text{NH}_4)_3\text{AsS}_4$	604
Sodium Thioarsenate $\text{Na}_3\text{AsS}_4 \cdot 8 \text{H}_2\text{O}$	604
Sodium Monothioorthoarsenate $\text{Na}_3\text{AsO}_3\text{S} \cdot 12 \text{H}_2\text{O}$	605
Sodium Dithioorthoarsenate $\text{Na}_3\text{AsO}_2\text{S}_2 \cdot 11 \text{H}_2\text{O}$	605
Antimony Sb	606
Stibine (Antimony Hydride) SbH_3	606
Antimony (III) Chloride SbCl_3	608
Antimony (V) Chloride SbCl_5	610
Antimony (III) Oxide Chloride SbOCl	611
Hexachloroantimonic (V) Acid $\text{HSbCl}_6 \cdot 4.5 \text{H}_2\text{O}$	611
Nitrosyl Chloroantimonate (V) $\text{NO}(\text{SbCl}_6)$	612
Antimony (III) Bromide SbBr_3	613
Antimony (III) Iodide SbI_3	614
Ammonium Hexabromoantimonate (IV) $(\text{NH}_4)_2\text{SbBr}_6$	615
Antimony (III) Oxide Sb_2O_3	615
Antimony (V) Oxide Sb_2O_5	616
Hydrated Antimony (V) Oxide $\text{Sb}_2\text{O}_5 \cdot (\text{H}_2\text{O})_x$	617
Diantimony Tetroxide Sb_2O_4	618
Antimony (III) Sulfate $\text{Sb}_2(\text{SO}_4)_3$	618
Antimony (III) Oxide Sulfate $(\text{SbO})_2\text{SO}_4$	619
Sodium Thioantimonate (V) $\text{Na}_3\text{SbS}_4 \cdot 9 \text{H}_2\text{O}$	619
Bismuth Bi	620
Bismuth (III) Chloride BiCl_3	621
Bismuth Dichloride BiCl_2	622
Bismuth Oxide Chloride BiOCl	622
Bismuth (III) Bromide BiBr_3	623
Bismuth Oxide Bromide BiOBr	624
Bismuth (III) Iodide BiI_3	624
Bismuth Oxide Iodide BiOI	625
Bismuth Oxide Nitrite BiONO_2	626
Bismuth (III) Phosphate BiPO_4	626
Bismuth (III) Borate $\text{BiBO}_3 \cdot 2 \text{H}_2\text{O}$	627
Sodium Bismuthate KBiO_3	627
Potassium Bismuthate KBiO_3	628
Dibismuth Tetroxide Bi_2O_4	629

SECTION II. CARBON	630
A) ELEMENTAL CARBON	630
Pure Carbon	630
Special Carbon Preparations	631
Surface Compounds of Carbon	633
B) GRAPHITE COMPOUNDS	635
Alkali Graphite Compounds	635
Alkali Ammine Graphite Compounds	637
Graphite Oxide	638
Carbon Monofluoride	640
Tetracarbon Monofluoride	641
Graphite Salts	642
Bromine Graphite	643
Metal Halide Graphite Compounds	644
C) VOLATILE CARBON COMPOUNDS	645
Carbon Monoxide CO	645
Carbon Dioxide CO ₂	647
Tricarbon Dioxide C ₃ O ₂	648
Carbonyl Chloride COCl ₂	650
Carbon Disulfide CS ₂	652
Tricarbon Disulfide C ₃ S ₂	653
Carbonyl Sulfide COS	654
Carbonyl Selenide COSe	655
Carbon Diselenide CSe ₂	656
Hydrogen Cyanide HCN	658
Cyanogen (CN) ₂	660
Cyanogen Chloride CNCl	662
Cyanogen Bromide CNBr	665
Cyanogen Iodide CNI	666
Cyanic Acid HNCO	667
Hydrogen Thiocyanate HNCS	669
Thiocyanogen (SCN) ₂	671
Ammonium Trithiocarbonate (NH ₄) ₂ CS ₃	674
Barium Trithiocarbonate BaCS ₃	674
SECTION 12. SILICON AND GERMANIUM	676
Silicon Si	676
Silanes SiH ₄ (Si ₂ H ₆ , Si ₃ H ₈)	679
Polysilanes (SiH) _x , (SiH ₂) _x	681
Silicon Tetrachloride SiCl ₄	682
Higher Silicon Chlorides	684
Silicon Tetrabromide SiBr ₄	686
Silicon (II) Bromide SiBr ₂	687
Silicon Tetraiodide SiI ₄	689
Chlorosilanes SiHCl ₃ , SiH ₂ Cl ₂ , SiH ₃ Cl	691
Tribromosilane SiHBr ₃	692
Dimethyldichlorosilane (CH ₃) ₂ SiCl ₂	694

Chlorosiloxanes $\text{Si}_4\text{O}_4\text{Cl}_8$, $\text{Si}_n\text{O}_{n-1}\text{Cl}_{2n+2}$	695
Silicon Monoxide SiO	696
Silicic Acids	697
Silicon Oxyhydride $\text{H}_2\text{Si}_2\text{O}_3$	699
Silicon Disulfide SiS_2	700
Silicon Tetraacetate $\text{Si}(\text{CH}_3\text{COO})_4$	701
Silicon Cyanate and Silicon Isocyanate $\text{Si}(\text{OCN})_4$, $\text{Si}(\text{NCO})_4$	702
Tetraethoxysilane, Tetramethoxysilane $\text{Si}(\text{OC}_2\text{H}_5)_4$, $\text{Si}(\text{OCH}_3)_4$	702
Silicates	704
Germanium	706
Germanium (IV) Oxide GeO_2	706
Germanium (II) Oxide GeO	711
Metallic Germanium Ge	712
Germanium Hydrides GeH_4 (Ge_2H_6 , Ge_3H_8)	713
Germanium (IV) Chloride GeCl_4	715
Germanium Dichloride GeCl_2	716
Germanium (IV) Bromide GeBr_4	718
Germanium (IV) Iodide GeI_4	719
Germanium Diiodide GeI_2	720
Trichlorogermane	721
Methylgermanium Triiodide CH_3GeI_3	722
Germanium Nitride Ge_3N_4	722
Germanium Disulfide GeS_2	723
Germanium Monosulfide GeS	724
Tetraethoxygermane $\text{Ge}(\text{OC}_2\text{H}_5)_4$	725
Germanium Tetraacetate $\text{Ge}(\text{CH}_3\text{COO})_4$	726
SECTION 13. TIN AND LEAD.	727
Tin Sn	727
Tin (II) Chloride SnCl_2	728
Tin (IV) Chloride SnCl_4	729
Hexachlorostannic Acid $\text{H}_2\text{SnCl}_6 \cdot 6\text{H}_2\text{O}$	730
Ammonium Hexachlorostannate, Potassium Hexachlorostannate $(\text{NH}_4)_2\text{SnCl}_6$, K_2SnCl_6	731
Tin (II) Bromide SnBr_2	732
Tin (IV) Bromide SnBr_4	733
Tin (II) Iodide SnI_2	734
Tin (IV) Iodide SnI_4	735
Tin (II) Oxide SnO	736
Stannic Acids $\text{SnO}_2 \cdot n\text{H}_2\text{O}$	737
Sodium Orthostannate Na_4SnO_4	739
Tin (II) Sulfide SnS	739
Tin (IV) Sulfide SnS_2	741
Sodium Metathioannate $\text{Na}_2\text{SnS}_3 \cdot 8\text{H}_2\text{O}$	742
Sodium Tetrathioannate (IV) $\text{Na}_4\text{SnS}_4 \cdot 18\text{H}_2\text{O}$	743

Tin (IV) Sulfate $\text{Sn}(\text{SO}_4)_2 \cdot 2 \text{H}_2\text{O}$	744
Tetramethyltin $\text{Sn}(\text{CH}_3)_4$	744
Tetraethyltin $\text{Sn}(\text{C}_2\text{H}_5)_4$	746
Tin (IV) Acetate $\text{Sn}(\text{CH}_3\text{COO})_4$	747
Lead Pb	748
Lead (IV) Chloride PbCl_4	750
Ammonium Hexachloroplumbate $(\text{NH}_4)_2\text{PbCl}_6$	751
Potassium Hexachloroplumbate K_2PbCl_6	753
Potassium Iodoplumbite $\text{KPbI}_3 \cdot 2 \text{H}_2\text{O}$	754
Lead (II, IV) Oxide Pb_3O_4	755
Lead (IV) Oxide PbO_2	757
Sodium Metaplumbate Na_2PbO_3	758
Sodium Orthoplumbate Na_4PbO_4	759
Calcium Orthoplumbate Ca_2PbO_4	760
Lead Sulfide PbS	760
Lead (IV) Sulfate $\text{Pb}(\text{SO}_4)_2$	761
Lead Azide $\text{Pb}(\text{N}_3)_2$	763
Tetramethyllead $\text{Pb}(\text{CH}_3)_4$	763
Tetraethyllead $\text{Pb}(\text{C}_2\text{H}_5)_4$	765
Neutral and Basic Lead Carbonate	
$\text{PbCO}_3, 2 \text{PbCO}_3 \cdot \text{Pb}(\text{OH})_2$	766
Lead (IV) Acetate $\text{Pb}(\text{CH}_3\text{COO})_4$	767
Lead Thiocyanate $\text{Pb}(\text{SCN})_2$	769
SECTION 14. BORON	770
Boron	770
Aluminum Boride $\text{AlB}_2, \text{AlB}_{12}$	772
Diborane B_2H_6	773
Lithium Borohydride LiBH_4	775
Sodium Borohydride NaBH_4	776
Sodium Trimethoxyborohydride $\text{NaHB}(\text{OCH}_3)_3$	777
Borine Trimethylamine $\text{BH}_3 \cdot \text{N}(\text{CH}_3)_3$	778
Borazole $(\text{HBNH})_3$	779
s-Trichloroborazole $(\text{ClBNH})_3$	779
Boron Trichloride BCl_3	780
Boron Tribromide BBr_3	781
Boron Triiodide BI_3	782
Boron Trifluoride Dihydrate $\text{BF}_3 \cdot 2 \text{H}_2\text{O}$	784
Dihydroxyfluoroboric Acid $\text{H}[\text{BF}_2(\text{OH})_2]$	784
Boron Trifluoride Ammoniate $\text{BF}_3 \cdot \text{NH}_3$	785
Boron Trifluoride Etherate $\text{BF}_3 \cdot \text{O}(\text{C}_2\text{H}_5)_2$	786
Boron (III) Oxide B_2O_3	787
Boron (III) Sulfide B_2S_3	788
Boron Nitride BN	789
Sodium Orthoborate Na_3BO_3	790
Metaboric Acid HBO_2	791
Sodium Metaborate NaBO_2	791

Sodium Tetraborate $\text{Na}_2\text{B}_4\text{O}_7$	793
Sodium Pentaborate $\text{NaB}_5\text{O}_9 \cdot 5 \text{H}_2\text{O}$	795
Sodium Perborate $\text{NaBO}_3 \cdot 4 \text{H}_2\text{O}$	795
Lindemann Glass (Lithium Beryllium Borate)	796
Boron Phosphate BPO_4	796
Boron Arsenate BASO_4	797
Boron Methoxide $\text{B}(\text{OCH}_3)_3$	797
Trimethylboron $\text{B}(\text{CH}_3)_3$	798
Triethylboron $\text{B}(\text{C}_2\text{H}_5)_3$	799
Trimethylborazine $(\text{CH}_3\text{BO})_3$	800
Tri-n-Butylboroxine $(n\text{-C}_4\text{H}_9\text{BO})_3$	801
n-Butylboronic Acid $n\text{-C}_4\text{H}_9\text{B}(\text{OH})_2$	801
n-Butylboron Difluoride $n\text{-C}_4\text{H}_9\text{BF}_2$	802
Sodium Tetraphenylborate $\text{Na}[\text{B}(\text{C}_6\text{H}_5)_4]$	803
SECTION 15. ALUMINUM	805
Lithium Aluminum Hydride LiAlH_4	805
Calcium Aluminum Hydride $\text{Ca}(\text{AlH}_4)_2$	806
Polymeric Aluminum Hydride $(\text{AlH}_3)_n \cdot x \text{O}(\text{C}_2\text{H}_5)_2$	807
Aluminum Chlorohydride $\text{Al}_2\text{Cl}_3\text{H}_3$	808
Aluminum Hydride Trimethylamine	
$\text{AlH}_3 \cdot 2 \text{N}(\text{CH}_3)_3$, $\text{AlH}_3 \cdot \text{N}(\text{CH}_3)_3$	809
Diethylaluminum Bromide $\text{Al}(\text{C}_2\text{H}_5)_2\text{Br}$	809
Triethylaluminum $\text{Al}(\text{C}_2\text{H}_5)_3$	810
Triethylaluminum Etherate $\text{Al}(\text{C}_2\text{H}_5)_3 \cdot \text{O}(\text{C}_2\text{H}_5)_2$	811
Diethylaluminum Hydride $\text{Al}(\text{C}_2\text{H}_5)_2\text{H}$	811
Aluminum Chloride AlCl_3	812
Aluminum Bromide AlBr_3	813
Aluminum Iodide AlI_3	814
Aluminum Chloride Hydrate $\text{AlCl}_3 \cdot 6 \text{H}_2\text{O}$	815
Sodium Tetrachloroaluminate NaAlCl_4	816
Tetrachloroaluminic Acid Dietherate $\text{HAlCl}_4 \cdot 2 \text{O}(\text{C}_2\text{H}_5)_2$	816
Aluminum Chloride Ammoniate $\text{AlCl}_3 \cdot \text{NH}_3$	817
Aluminum Chloride-Sulfur Dioxide Adduct $\text{AlCl}_3 \cdot \text{SO}_2$	817
Aluminum Chloride-Thionyl Chloride Adduct	
$\text{Al}_2\text{Cl}_6 \cdot \text{SOCl}_2$	818
Aluminum Chloride-Phosphorus Pentachloride Adduct	
$\text{AlCl}_3 \cdot \text{PCl}_5$	818
Aluminum Bromide-Hydrogen Sulfide Adduct	
$\text{AlBr}_3 \cdot \text{H}_2\text{S}$	819
Aluminum Iodide Hexaammoniate $\text{AlI}_3 \cdot 6 \text{NH}_3$	819
Aluminum Hydroxide	820
Aluminum Oxide	822
Aluminum Sulfide Al_2S_3	823
Aluminum Sulfite	824
Aluminum Selenide Al_2Se_3	825
Aluminum Telluride Al_2Te_3	826

Aluminum Nitride AlN	827
Lithium Aluminum Nitride Li_3AlN_2	828
Aluminum Azide $\text{Al}(\text{N}_3)_3$	829
Aluminum Phosphide AlP	829
Lithium Aluminum Phosphide Li_3AlP_2	830
Aluminum Orthophosphate AlPO_4	831
Aluminum Arsenide AlAs	831
Aluminum Carbide Al_4C_3	832
Lithium Aluminum Cyanide $\text{LiAl}(\text{CN})_4$	833
Aluminum Methoxide $\text{Al}(\text{OCH}_3)_3$	833
Aluminum Ethoxide $\text{Al}(\text{OC}_2\text{H}_5)_3$	834
Aluminum Triethanolamine $\text{Al}(\text{OC}_2\text{H}_4)_3\text{N}$	835
Aluminum Acetate $\text{Al}(\text{O}_2\text{CCH}_3)_3$	835
Aluminum Acetylacetonate $\text{Al}(\text{C}_5\text{H}_7\text{O}_2)_3$	836
SECTION 16. GALLIUM, INDIUM, THALLIUM	837
Gallium Ga	837
Trimethylgallium, Tetramethyldigallane, Digallane $\text{Ga}(\text{CH}_3)_3$, $\text{Ga}_2\text{H}_2(\text{CH}_3)_4$, Ga_2H_6	840
Lithium Tetrahydrogallate LiGaH_4	842
Gallium (III) Chloride GaCl_3	843
Gallium (III) Bromide GaBr_3	845
Gallium (III) Iodide GaI_3	846
Gallium (II) Chloride and Gallium (II) Bromide GaCl_2 , GaBr_2	846
Gallium Hydroxide $\text{Ga}(\text{OH})_3$, $\text{GaO}(\text{OH})$	847
Gallium (III) Oxide $\alpha\text{-Ga}_2\text{O}_3$, $\beta\text{-Ga}_2\text{O}_3$	848
Gallium (I) Oxide Ga_2O	849
Gallium (III) Sulfide Ga_2S_3	850
Gallium (II) Sulfide GaS	851
Gallium (I) Sulfide Ga_2S	852
Ammonium Gallium (III) Sulfate $\text{NH}_4\text{Ga}(\text{SO}_4)_2 \cdot 12\text{H}_2\text{O}$	854
Gallium Selenide Ga_2Se_3 , GaSe , Ga_2Se	854
Gallium Telluride Ga_2Te_3 , GaTe	855
Gallium Nitride GaN	855
Gallium Nitrate $\text{Ga}(\text{NO}_3)_3$	856
Gallium Phosphide, Arsenide and Antimonide GaP , GaAs , GaSb	857
Indium In	857
Indium (III) Chloride InCl_3	858
Indium (III) Bromide InBr_3	859
Indium (III) Iodide InI_3	860
Indium (II) Chloride, Bromide and Iodide InCl_2 , InBr_2 , InI_2	861
Indium (I) Chloride, Bromide and Iodide InCl , InBr , InI	862
Indium Hydroxide $\text{In}(\text{OH})_3$	862
Indium (III) Oxide In_2O_3	863
Indium (I) Oxide In_2O	863

Indium Sulfides In_2S_3 , InS , In_2S	864
Indium Selenides and Tellurides In_2Se_3 , InSe , In_2Se and In_2Te_3 , InTe , In_2Te	865
Indium Nitride InN	866
Indium Phosphide, Arsenide and Antimonide InP , InAs , InSb	867
Thallium Tl	867
Thallium (I) Chloride, Bromide and Iodide TlCl , TlBr , TlI	869
Thallium (III) Chloride TlCl_3 , $\text{TlCl}_3 \cdot 4 \text{H}_2\text{O}$	870
Tetrachlorothallium (III) Acid $\text{H}(\text{TlCl}_4) \cdot 3 \text{H}_2\text{O}$	872
Thallium (I) Tetrachlorothallate (III) $\text{Tl}(\text{TlCl}_4)$	872
Thallium (I) Hexachlorothallate (III) $\text{Tl}_3(\text{TlCl}_6)$	873
Potassium Hexachlorothallate (III) $\text{K}_3(\text{TlCl}_6) \cdot 2 \text{H}_2\text{O}$...	873
Potassium Pentachloroquoathallate (III) $\text{K}_2(\text{TlCl}_5\text{H}_2\text{O}) \cdot \text{H}_2\text{O}$	874
Cesium Nonachlorodithallate (III) $\text{Cs}_3(\text{Tl}_2\text{Cl}_9)$	874
Thallium (III) Bromide $\text{TlBr}_3 \cdot 4 \text{H}_2\text{O}$	874
Thallium (I) Tetrabromothallate (III) $\text{Tl}(\text{TlBr}_4)$	875
Thallium (I) Hexabromothallate (III) $\text{Tl}_3(\text{TlBr}_6)$	875
Rubidium Hexabromothallate (III) $\text{Rb}_3(\text{TlBr}_6) \cdot \frac{9}{7} \text{H}_2\text{O}$..	876
Thallium Triiodide $\text{TlI} \cdot \text{I}_2$, TlI_3	876
Thallium (I) Oxide Tl_2O	877
Thallium (I) Hydroxide TlOH	877
Thallium (II) Oxide Tl_2O_3 , $\text{Tl}_2\text{O}_3 \cdot x \text{H}_2\text{O}$	879
Thallium Sulfides	880
Thallium (I, III) Selenide $\text{Tl}_2\text{Se} \cdot \text{Tl}_2\text{Se}_3$, TlSe	881
Thallium (I) Sulfate Tl_2SO_4	881
Disulfatothallate (III) Acid $\text{HTl}(\text{SO}_4)_2 \cdot 4 \text{H}_2\text{O}$	882
Thallium (III) Hydroxide Sulfate $\text{Tl}(\text{OH})\text{SO}_4 \cdot 2 \text{H}_2\text{O}$...	882
Thallium (I) Nitride Tl_3N	883
Thallium (I) Nitrate TlNO_3	883
Thallium (I) Carbonate Tl_2CO_3	884
Thallium (II) Formate, Thallium (I) Malonate, Clerici's Solution	884
SECTION 17. ALKALINE EARTH METALS	887
Beryllium Be	887
Beryllium Chloride BeCl_2	889
Beryllium Bromide BeBr_2	891
Beryllium Iodide BeI_2	892
Beryllium Oxide and Beryllium Carbonate BeO , BeCO_3 ..	893
Beryllium Hydroxide $\text{Be}(\text{OH})_2$	894
Sodium Beryllates	895
Beryllium Sulfide BeS	895
Beryllium Selenide and Beryllium Telluride BeSe , BeTe ..	897
Beryllium Nitride Be_3N_2	898
Beryllium Azide $\text{Be}(\text{N}_3)_2$	899

Beryllium Carbides Be_2C , BeC_2	899
Beryllium Acetate $\text{Be}(\text{CH}_3\text{COO})_2$	901
Basic Beryllium Acetate $\text{Be}_4\text{O}(\text{CH}_3\text{COO})_8$	901
Magnesium Mg	903
Magnesium Hydride MgH_2	905
Magnesium Chloride MgCl_2	905
Magnesium Bromide MgBr_2	909
Magnesium Iodide MgI_2	910
Magnesium Oxide MgO	911
Magnesium Hydroxide $\text{Mg}(\text{OH})_2$	912
Magnesium Sulfide MgS	913
Magnesium Selenide MgSe	915
Magnesium Telluride MgTe	915
Magnesium Nitride Mg_3N_2	916
Magnesium Azide $\text{Mg}(\text{N}_3)_2$	917
Magnesium Phosphide and Magnesium Arsenide Mg_3P_2 , Mg_3As_2	917
Magnesium Carbides MgC_2 , Mg_2C_3	920
Magnesium Silicide Mg_2Si	921
Magnesium Germanide Mg_2Ge	922
Calcium, Strontium, Barium Metals	922
Calcium Strontium and Barium Hydrides CaH_2 , SrH_2 , BaH_2	929
Calcium, Strontium, Barium Halides	930
Calcium Oxide CaO	931
Strontium Oxide SrO	932
Barium Oxide BaO	933
Calcium Hydroxide $\text{Ca}(\text{OH})_2$	934
Strontium Hydroxide $\text{Sr}(\text{OH})_2 \cdot 8 \text{H}_2\text{O}$, $\text{SrO} \cdot 9 \text{H}_2\text{O}$	935
Calcium, Strontium, Barium Peroxides CaO_2 , SrO_2 , BaO_2	936
Calcium, Strontium, Barium Sulfides CaS , SrS , BaS	938
Calcium, Strontium, Barium Selenides CaSe , SrSe , BaSe	939
Calcium, Strontium, Barium Nitrides Ca_3N_2 , Sr_3N_2 , Ba_3N_2	940
Barium Azide $\text{Ba}(\text{N}_3)_2$	942
Calcium Phosphide Ca_3P_2	942
Calcium Carbide CaC_2	943
Calcium Cyanamide CaCN_2	946
Calcium Silicides CaSi , CaSi_2	946
Calcium Germanide CaGe	948
SECTION 18. ALKALI METALS	950
Alkali Metal Compounds from Minerals	950
Free Alkali Metals	956
Alkali Hydrides NaH , KH , RbH , CsH and LiH	971
Alkali Metal Oxides Li_2O , Na_2O , K_2O , Rb_2O , Cs_2O	974
Lithium and Sodium Peroxides Li_2O_2 and Na_2O_2	979
Alkali Dioxides	980
Lithium Hydroxide $\text{LiOH} \cdot \text{H}_2\text{O}$, LiOH	982

Rubidium and Cesium Hydroxides RbOH, CsOH	983
Lithium Nitride Li_3N	984
Phosphides, Arsenides, Antimonides and Bismuthides of Alkali Metals from the Elements	985
Sodium and Lithium Carbides Na_2C_2 , Li_2C_2	987
Alkali Metal Carbonates of Highest Purity	987
Silicides and Germanides of Alkali Metals from the Ele- ments NaSi, KSi, RbSi, CsSi, NaGe, KGe, RbGe, CsGe .	989
FORMULA INDEX	993

Part I

Preparative Methods

Preparative Methods

P. W. SCHENK AND G. BRAUER

This part of the book describes special methods and devices for inorganic preparations. We do not intend to present a comprehensive, thorough compilation of all the known methods of preparative inorganic chemistry, such as given in handbooks. An enterprise of that kind would require too much space, and the appropriate books are already available. Even through the several-volume treatise by Stock, Staehler, Tiede and Richter is by now partly outdated, many references, methods and descriptions of apparatus, useful for solving experimental problems, can be found in specialized books, such as those by Von Angerer, Dodd and Robinson, Grubitsch, Klemenc, Kohlrausch, Lux and Ostwald-Luther [1], to name but a few. These texts can thus be consulted when the need arises.

In Part I, only a more or less subjective selection of methods and devices is presented. This selection was governed by certain principles. Increased emphasis on greater purity of preparations and the advent of extreme experimental conditions have imposed more rigorous demands on the experimental equipment. Porcelain dishes and beakers must increasingly be complemented or replaced by more complicated apparatus for the preparation of unstable or oxidizable substances. Such special demands placed on individual preparatory steps have often led to the development of general procedures which can be applied to a larger number of preparations than was originally contemplated. An effort has been made to extract such standard methods and techniques from later sections and to summarize them in this first part. Whenever a too detailed description had to be omitted because of space limitations, at least the original literature reference is given. In addition to brief descriptions of the more commonly used and well-known special equipment, an attempt has also been made to describe some of the experimental "art," namely, those little tricks and short-cuts which with the passage of time have become traditional in almost every laboratory, but which somehow never seem to find their way into the literature.

Assembly of Apparatus

The classic Bunsen support with its clamps and brackets is still the most frequently used framework for assembling apparatus. There are various newer variations of it which eliminate the movement of the clamps when the brackets are tightened.

It is best to assemble a permanent support so that the entire structure can be easily carried about without having to dismantle it each time and so that it can be set aside when not in use. Such an arrangement is especially useful with the most commonly used pieces of apparatus, e.g., pump assemblies consisting of forepump, mercury traps and vacuum measuring instruments, or apparatus used for the preparation, purification and drying of inert or other frequently used gases. To construct more extensive assemblies, it is best to interconnect individual uprights with round steel rods 13 mm. in diameter, and to increase the stability of the whole, the uprights are fastened to similar rods, cemented into the wall. It is also very helpful to attach strong wooden strips, about 10 cm. wide, horizontally along the wall above the working benches (one strip about 30 cm., the other about 80 cm. above the bench surface). The rods holding the uprights in place can then be screwed into wall receptacles (1/4" size, available in hardware supply stores) which are fastened to the wooden strips. These round wall receptacles can also be fastened with screws to the work bench to hold the vertical rods, thus replacing the base plate of the support. The cross braces fastened to the wall, or else suitable clamps, allow the work bench supports to be eliminated, and the entire apparatus can then be mounted directly on the wall. This has the considerable advantage of leaving the table space free, so that it can be kept clean more easily, and so that spilled mercury can be readily wiped up. If the apparatus is very tall, a "gallows" frame (Fig. 1) can be used, mounted on a table about 60 cm. above the floor. This frame is free standing and, as a result, the experimental apparatus can easily be reached from all sides. Similar structures can be built on the free-standing center benches of the laboratory by attaching four vertical rods to the two short sides of a bench and connecting them horizontally with matching round rods. Suitable perforated structural steel angles with corresponding bolts and nuts are available for the various setups, even those built up from the floor. These perforated angles can be assembled into very stable structures resembling those which children build from Erector sets. Additional suggestions and details about frame materials can be found in G. C. Mönch [2]. In assembling the apparatus, special care is required in selecting the right location and the proper apparatus-supporting clamps. Too many clamps, causing stresses which are liable to break the apparatus, are just as bad as too few clamps.

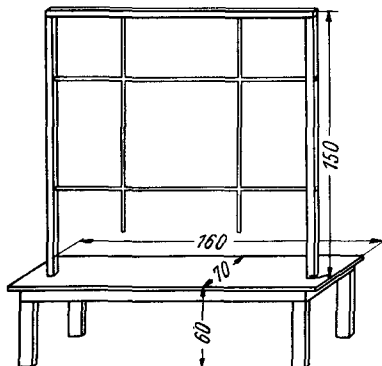

Fig. 1. Frame for setting up a free-standing experimental apparatus (measurements in cm.).

Glass

The important types of glass used in chemical work are shown in Table 1.

The chemical composition of the more frequently used types of glass is shown in Table 2.

The ordinary starting material for the manufacture of laboratory glassware and connectors consists of glass tubes of circular cross section. The tubing is designated as hand-drawn or machine-drawn; the size reproducibility of the machine-drawn tubing is considerably superior.

Glassware is identified by a special brand number and by the trademark of the firm manufacturing it. A helpful characteristic

Table 1

Type of glass	Linear coefficient of expansion
Flint glass (Kimble)	$93 \cdot 10^{-7}$ (25°C)
Pyrex glass	$33 \cdot 10^{-7}$ (0–300°)
Vycor glass	$8 \cdot 10^{-7}$ (0–300°)
Quartz glass	$5 \cdot 10^{-7}$ (0–300°)

is the color of the glass, the "hue," which can clearly be seen by transmitted light on a freshly broken end piece. The most common colors vary from yellow to green.

Table 2
Chemical Composition of Some Types of Glass

		SiO ₂	B ₂ O ₃	Na ₂ O	K ₂ O	CaO	BaO	MgO	Al ₂ O ₃	Fe ₂ O ₃
Soft	Flint glass (R-6) (Kimble Glass Co., Toledo, Ohio)	67.7	1.5	15.6	0.6	5.6	2.0	4.0	2.8	
	KG-33 (Kimble)	80	13	4	<0.1	<0.1			2	<0.1
Hard	Pyrex (Corning Glass Co., Corning, N. Y.)	80	13	4	<0.1	<0.1			2	<0.1
	Vycor (Corning)	96	3							

In terms of its chemical resistance to attack by aqueous solutions, laboratory glasses are generally classified according to (a) hydrolytic resistance, (b) resistance to acids and (c) resistance to alkali, as shown in Tables 3 and 4.

Many more details about the types of glass can be found in the descriptive literature of the manufacturers.

The various parts of a glass apparatus are assembled into a unit by using ground glass joints, rubber tubing, stoppers, adhesives and especially by sealing glass tubing together with hand torches. The handling of these torches can be easily learned even by one having no previous knowledge of glass blowing. A glass seal

Table 3

Hydrolytic Resistance

Glass	Conditions	Time	ml. of 0.02 N HCl/10 g. of powdered glass	Weight loss, mg./cm. ²
Flint glass (Kimble)	steam at 121°C	30 min.	7.8	0.002
Pyrex glass	water at 80°C	48 hr.		
KG - 33 (Kimble)	steam at 121°C	30 min.	0.26	negligible
Vycor	water at 80°C	48 hr.		

at the ends of two glass tubes often can be formed in a shorter time than is required for careful connection of the tubes with rubber tubing. The technique of glass blowing is best learned under the tutorship of an experienced individual; a description of manipulations can thus be omitted here. However, a few hints will be offered:

1. Use glass tubing and other necessary glass from the same manufacturer.

2. Protect glass from dust and store it horizontally; if it is necessary to store it vertically due to lack of space, cover the openings.

3. Before using, clean the glass tubing by pushing or blowing through a moist piece of cotton; clean tubes of larger diameters with a moist rag pulled through on a string; never clean the interior surfaces of glass tubing with an iron or steel wire or another piece of glass tubing. Ignoring this rule is a common cause of cracked tubing during heating.

4. Only freshly cut surfaces, not touched by fingers, should be sealed. When it is impossible to trim an end piece in order to obtain a freshly cut surface, heat the area with a torch and pull off some glass with the aid of a glass rod, or melt the glass, blow this area into a thin-wall bubble and strip it off.

5. When working with hard borosilicate glass (Pyrex), oxygen is added to the air stream through a tee-connector tube.* The difficulty of working at higher temperatures notwithstanding,

*Blowtorches and hand torches equipped with a valve for oxygen addition are commercially available.

borosilicate glasses are more amenable to glass blowing than the soft glasses because they are much less likely to crack when unevenly heated.

Table 4

Glass	Conditions	Time	Weight loss, mg./cm. ²
Acid resistance			
Pyrex glass	5% HCl at 100°C	24 hr.	0.0045
Vycor	5% HCl at 100°C	24 hr.	0.0005
Base Resistance			
Pyrex glass	5% NaOH at 100°C	6 hr.	1.4
Vycor	5% NaOH at 100°C	6 hr.	0.9

Industrial fusion of pure quartz yields clear quartz glass or vitreous silica. It has the following advantages: low temperature coefficient of expansion, transparency and relatively good, but strongly selective chemical resistance. Tubing, ground joints, etc., of quartz glass can also be made in the laboratory. Oxy-hydrogen or hydrogen-air flames with additional oxygen are used. In a pinch, a small industrial oxy-acetylene welding torch will suffice. Despite the high softening temperature of 1500°C, manipulation of quartz is no more difficult than that of ordinary glass. However, the following hints will be useful for those working with quartz glass:

1. Holes often do not close completely in the molten glass; fine capillaries usually remain open. Such spots must be repeatedly remelted or drawn together with a thin quartz rod.

2. Since SiO and SiO₂ vaporize, quartz glass becomes cloudy in the melted area. Remedy: After completing the main sealing operation, remelt the whole area until it is clear, using a large but not too hot oxy-hydrogen flame; if necessary, follow with a rinse of dilute hydrofluoric acid.

3. Rapid blowing is essential because the viscosity tends to increase rapidly on cooling; blowing is best done with a rubber tube.

4. On cooling or on prolonged exposure to heat, there exists the danger of devitrification; that is, conversion of the metastable, glassy form to cristobalite may occur. Once it has started, this process rapidly leads to mechanical failure of the apparatus. The failure starts preferentially at the externally adhering impurity

centers and proceeds very rapidly, especially at temperatures in excess of 1000°C . Consequently, those parts of quartz glassware which are to be heated and which have already been thoroughly cleaned (with aqueous solutions or organic liquids such as alcohol, acetone, etc.) must not be touched prior to heating because perspiration (NaCl) acts as a devitrifying agent.

The upper temperature limit, when quartz glass is used in the absence of a pressure differential, is 1250°C . Unfortunately, evacuated quartz glass flasks start to deform in the 1150°C region. The devitrification and warping phenomena make quartz glass vessels unsuitable for experiments in which they must be exposed to temperatures higher than 1000°C over long periods of time.

Glasses which cannot be directly sealed together can be interconnected by means of graded seals. Seals having diameters of 7–9 mm. (O.D.) are commercially available. They consist of a series of very short tubes, each with a slightly different coefficient of expansion. In this way, even soft glass can be connected to quartz glass.

Sealing wires into glass is described in detail elsewhere [2]. With quartz glass only molybdenum can be used.

Cleaning of glassware: Glass equipment is usually cleaned with $\text{CrO}_3\text{-H}_2\text{SO}_4$ cleaning solution by allowing it to stand in the solution for some time, and then rinsing with water. Laug [2] cautions, however, that the glass absorbs CrO_3 upon treatment with this cleaning solution. The CrO_3 cannot be completely removed, even by boiling with water. According to Laug, one gram of glass takes up about 5 mg. of CrO_3 , of which 0.2 mg. remains in the glass even after repeated boiling with water. In certain cases, it is preferable to clean the glassware with concentrated nitric acid. Treatment with alkaline permanganate solution, followed by successive rinsing with water, concentrated hydrochloric acid, and again with water is also very effective.

Glass tubing and apparatus parts which cannot be placed in a drying oven because of their size should not be dried by rinsing with organic solvents (alcohol-ether, acetone); such solvents are often contaminated with low-volatility impurities and these, if left on the glass walls, will cause trouble with sensitive substances, or at high vacuum. Instead, room air should be drawn through the tubes or apparatus by means of an aspirator, with only one opening accessible to the air. This opening should be protected against dust with a cotton wad or a piece of soft filter paper.

Apparatus that is to be taken apart should be provided with ground glass connections. One can use for this purpose standard tapered joints or ball joints. The latter are now manufactured with great precision and are being used more and more. In many cases flanged ground-face connections are advantageous (for details see Mönch [2]). The great advantage of ball joints is their flexibility

and easy detachability; they are held together by simple clamps. Their price, on the other hand, is greater than that of the corresponding tapered joints. Ball joints designation includes the diameter of the tube. The following sizes are available on the market:

12/5	18/7	18/9	28/12	28/15	35/20	35/25
	50/30	65/40	75/50	102/75		

In addition, the smallest size, with a ball 12 mm. in diameter, is available with capillaries of 1–3 mm.

The designation of the tapered joints has been changed several times. Table 5 lists the present standards for the different series. All joints are ground with a taper of 1:10 [(larger diameter minus smaller diameter): length of ground portion = 1:10].

The question of which part of the apparatus should carry the male joint, and which the female, is often hard to decide. The best general advice that can be given is to keep the reagents free from contamination. Thus, if the ground joint is to be greased, the female should be on top and the male below; in this case, however, cleaning of the joint is usually more difficult. A groove formed in the ground surface of the male ("two-zone grinding") is very useful in preventing penetration of the grease into the apparatus. Parts which are to be weighed on an analytical balance should carry the male, because it can be cleaned more easily. It is highly recommended that small hooks be attached to both parts of the joint, so that the latter may be held together with springs or rubber bands.

If joints of different materials are to be assembled and heat is to be applied, the female should always be made of the material with the higher expansion coefficient. This applies especially to glass-quartz joints. In an assembly consisting of a glass male and a quartz female, the latter will, as a rule, crack on immersion in boiling water.

Greasing of stopcocks and other ground joints, as well as suitable lubricants and adhesives, will be discussed later. In some cases, it is advantageous to make the connections by cementing and without using any ground joints. This method is especially useful when very large tubes are to be connected, since such cemented seals, if correctly prepared, can be removed without shifting the other parts of the apparatus. The seal is made with a glass sleeve, as shown in Fig. 2. It is best to polish the two butting edges (so that the cut on each is straight) and to interpose a narrow, annealed copper ring, especially if the apparatus is to be evacuated; otherwise, the glass edges may splinter due to the compressive force of atmospheric pressure. To secure sufficient adhesive strength, it is important that the cement be melted by warming the supporting glass. This is especially important with metal cements, since in this case leaks cannot be easily detected. To heat the places to be

Table 5

Designation and Measurements of American Standard Taper Ground Joints (CS 21-39)*

Long	Medium	Short
5/20	5/12	12/10
7/25	7/15	14/10
10/30	10/18	19/10
12/30	12/18	24/12
14/35	14/20	29/12
19/38	19/22	34/12
24/40	24/25	40/12
29/42	29/26	45/12
34/45	34/28	50/12
40/50	40/35	55/12
45/50		60/12
50/50		71/15
55/50		
60/50		
71/60		

* The first number in the designation indicates the larger diameter of the ground section; the second, the length of the ground section.

cemented, one can use a small pilot flame, 10-15 mm. long, created by a glass or metal tip.

If certain precautions are taken, metals can be easily and tightly sealed to glass. This is especially true of Kovar tubing, which can be sealed to Pyrex glass.



Fig. 2. Cementing large glass tubes

With rubber hose connections the edges of the glass tube should be fire-polished. If this is not done, small rubber particles may be scraped off and jammed between the hose and the glass wall, causing a leak. If the hose is lubricated with silicone grease, instead of glycerol or oil, it will not stick. "Frozen" rubber hoses should be cut off. Losing a piece of rubber tubing is preferable to breaking the glass. If one should have occasionally to remove a thermometer (or similar device) stuck in a valuable large rubber stopper, a cork

borer, well lubricated with glycerol, should be introduced between glass tube and stopper and the borer retracted several times, while adding more glycerol.

If rubber stoppers are to be bored, the borer should never be turned in one direction only; instead, the direction should be changed after each half turn, withdrawing the borer several times in order to add more glycerol. Otherwise, the hole gets continually narrower, since the rubber core inside the borer also turns. The hole is then not cut by the sharp edge of the borer but, instead, the rubber is torn out.

Ceramic Materials

The refractory ceramic materials used in the laboratory can be classified, as in Table 6, according to their properties and main ingredients. Unlike glass vessels, their shaping is finished before the high-temperature treatment (firing). Only limited subsequent treatment is possible and this is restricted to mechanical modification (grinding, cutting). Since firing is accompanied by shrinkage, close tolerances can be maintained to a limited extent only. These characteristics restrict ceramic laboratory ware to certain, usually standardized items, e.g., straight tubes, rods, crucibles, dishes, boats, etc.

Group 1. These materials, which consist essentially of Al_2O_3 and SiO_2 , are resistant to extended heating at higher temperatures, but are often not as gas-tight as pure SiO_2 , although some of them come close in this respect. Gas permeability depends very much on the temperature and increases with rising temperature. In addition to the well-known laboratory porcelain ware, some manufacturers have developed special items which have higher chemical or temperature resistances (cf. synopsis in Table 11). The maximum use temperature for these materials increases with the Al_2O_3 content. Again, because of the typical ceramic method of manufacture of these materials (shaping, firing), only some, usually standardized, laboratory items can be made (straight tubes, rods, crucibles, dishes, boats, etc.). Glazes are applied only to porcelain. Ability to withstand temperature changes is much lower than with pure silica.

Chemical resistance at high temperatures is poorest toward alkaline and strongly reducing materials (e.g., active metals). Again, chemical and thermal resistance increases in proportion to the Al_2O_3 content.

For special purposes (e.g., high chemical resistance), materials of Group 1 can be lined with substances which by themselves are not suitable for ceramic manufacture (for example, MgO , CaO). For example, according to Goehrens [3], one can apply to the vessel a paste made of a mixture of finely ground, weakly ignited and

Table 6

Group	Body composition	Designation
Dense		
1 a	Aluminum silicate (mullite) (silicate vitreous bond)	Lab. hard procelain (20-30% Al_2O_3)
1 b	As 1a, with special refractory additions, e.g., corundum, sillimanite, and others	Sillimanite 10a and other special porcelains
2	Sintered oxides with high m.p., "single phase materials" Al_2O_3 , MgO , BeO , ZrO_2 , ThO_2	Sintered alumina, magnesia, beryllia, zirconia and thoria
Porous		
3	Same as 1, but less strong vitreous bond; partly pure oxides	Fire clays, mullite, sillimantine, corundum (kaolin-bonded)
4	Carbon	Electrode carbon, retort graphite, graphite (clay-bonded)

coarse, strongly ignited magnesia in a saturated MgCl_2 solution. This is then transformed by drying and gradual heating into a well-adhering protective layer of MgO . In order to deposit a CaO layer (which, among others, can also be applied to ferrous vessels) calcium oxide is made into a paste with calcium nitrate; or, according to W. Jander [3], a paste of CaO and water is painted on to a thickness of 0.3–0.4 cm. Drying and subsequent heating should start at 40°C and be increased very slowly up to red heat.

Group 2. For work at very high temperatures, reaction vessels made of ceramic oxide compounds have proved especially suitable; this refers to vessels which have been made by sintering oxides of high purity and of very high melting point. Such materials excel in their resistance to high temperatures and in their remarkable tolerance of a wide range of materials at high temperatures. For almost every material to be melted there can be found an especially suitable ceramic oxide material, as is shown below. Because of the difficulties encountered in ceramic manufacture, the best thermal and chemical resistance characteristics can be achieved only at some sacrifice of flexibility in the choice of ceramic shapes.

In the following tables (7–11), which summarize the available practical experience and offer some suggestions for use, the meanings of the symbols are: +++ not attacked; ++ very slightly attacked; + slightly attacked; – strongly attacked; – – very strongly attacked; – – – completely destroyed.

In using the physical technique of vapor deposition of thin surface layers, some knowledge has been gathered about compatibility between the boat and crucible materials and the reagents heated in these vessels (cf. Auwärter [4]). Table 12 summarizes these data.

Group 3. Besides the materials of Groups 1 and 2, porous ceramics are important. These often are more resistant to

Table 7

Behavior of Ceramic Oxide Apparatus with Fused Metals

Metal	°C	Al ₂ O ₃	ZrO ₂	MgO	BeO
Li(H ₂)*	700	---	++*	---	---
Na(H ₂)	700	+++	+++		+++
K(H ₂)	800	++	+++		+++
Cu(ox)	1200	+++	+++	+	
Be(H ₂)	1500	---			+++
Mg(H ₂)	800	++	+++	+++	---
Ca(H ₂)	1000	+++	–	+	---
Al(H ₂)	1000	+++	+++	---	---
Si(H ₂)	1600	+++	+++	---	---
Ti(H ₂)	1800	+	+	---	
Zr(H ₂)	1700	–	++	+++	++
Sb	800	+++	+++		
Bi	600	+++	+++		
Cr(ox)	1900	---	---		
Cr(H ₂)	1900	+++	++	++	
Mn(ox)	1600	---	---	---	
Mn(H ₂)	1600	++	++	+	
Fe(ox)	1600	---	---		---
Fe(H ₂)	1700	+++	+++	+++**	
Ni	1600	+++	+++	+++**	
Co	1600	+++	+++	+++**	
Pb	600	+++	+++	+++	
Pt	1700	+++	+++	+++**	
Au	1100	+++	+++	+++**	

* Only after previous coating of the crucible with molten LiF.

** Vessels made of impure oxides are less resistant.

Table 8

Behavior of Ceramic Oxide Apparatus with Liquids

Agent	°C	Al ₂ O ₃	ZrO ₂	BeO
H ₂ SO ₄ conc.	338	++	+	---
HCl conc.	110	+	++	-
HNO ₃ conc.	122	+	++	+
HF conc.	120	++	+++	---
H ₃ PO ₄ conc.		++	++	---
NaOH 20%	103	++	++	++

temperature changes. This latter characteristic is sometimes combined with higher maximum use temperatures. Some of these materials are also available as pastes (insulating compounds).

Group 4. In this group, use is made of the extremely high melting point of carbon, which is usually not reached in practice.

Table 9

Behavior of Ceramic Oxide Apparatus with Oxides, Hydroxides, and Carbonates

Agent	°C	Al ₂ O ₃	ZrO ₂	MgO	BeO
Na ₂ O ₂	500	+++	++		++
NaOH	500	+++	+++	+++	++
KOH	500	+++	++	++	++
Li ₂ CO ₃	1000	+++	+++		
Na ₂ CO ₃	1000	+++	+++		+++
K ₂ CO ₃	1000	+++	---		
Cu ₂ O	1300	+++	+++	+++	
B ₂ O ₃	1250	+++	-	----	++
SiO ₂	1780	+	++	----	---
	1900	---			----
PbO	900	---	---	+++	
Sb ₂ O ₃	850	+++	+++		
Cr ₂ O ₃	1900	---	---	---	-
MoO ₃	800	+++	++		---
W ₂ O ₃	1600	-	++		-
Mn ₂ O ₃	1600	}			
Mn ₃ O ₄	1700				
FeO	1500				
Fe ₂ O ₃	1600				
P ₂ O ₅	600				
All of these materials are destroyed.					

Table 10

Behavior of Ceramic Oxide Apparatus with Molten Salts

Salt	°C	Al ₂ O ₃	ZrO ₂	Salt	°C	Al ₂ O ₃	ZrO ₂
LiCl	800	+++	+++	K ₂ SO ₄	1200	+++	+++
Li ₂ SiO ₃	1300	+++	+++	CuS	1300	++	++
NaCl	900	+++	+++	Cu ₂ SiO ₄	1400	---	++**
NaCN	700	+++	+++	MgSiO ₃	1750	---	++**
NaF	1200	---	++	CaCl ₂	900	+++	+++
Na ₂ MoO ₄	800	+++	+++	CaF ₂	1500	---	++***
NaNO ₃	600	+++	+++	Ca ₃ (PO ₄) ₂	1800	+++	
NaNO ₂	400	+++	+++	CaSiO ₃	1700	---	++
NaPO ₃	800	+++	+++	SrCl ₂	1000	+++	+++
Na ₄ P ₂ O ₇	1200	+++	+++	Sr(NO ₃) ₂	800	++	++
Na ₂ SiO ₃	1300	+++	+++	SrSO ₄	1750	+	++
Na ₂ SO ₄	1150	+++	+++	BaCl ₂	1100	+++	+++
Na ₂ SiF ₆	1200	—	++*	BaSO ₄	1650	++	+
Na ₂ B ₄ O ₇	1000	+++	+++	ZnCl ₂	500	+++	+++
Na ₂ WO ₄	700	+++	+++	ZnSiO ₃	1550	++	---
KHSO ₄	500	+++	++	PbB ₂ O ₄	1300	+++	+++
KCl	1000	+++	+++	PbSiO ₃	1300	+++	+++
KCN	800	+++	+	PbSO ₄	1300	++	++
KF	1000	—	++	PbS	1300	++	++
KBO ₂	1200	+++	+++	FeS	1300	+++	++
K ₄ P ₂ O ₇	1200	+++	---				

* MgO +++. ** BeO ----. *** MgO ----; BeO ++.

A number of apparatus components made of pure carbon, pure graphite or ceramic bonded carbon are commercially available. The additives, however, cause some reduction in refractive properties as compared to pure carbon.

Smaller utensils can easily be prepared in the laboratory from pieces of pure synthetic carbon or graphite. Tubes, plates, valves and other shapes made of pure graphite, as well as of graphite reinforced with synthetics, are commercially available.

Metals

Although glass and ceramics are the principal materials for chemical apparatus, metals and their alloys are indispensable for many applications. They are superior to glass and ceramics in their high thermal and electrical conductivity, mechanical properties and in their higher ability to withstand temperature changes. In addition, their specific chemical resistance may be important in certain cases. Thus, reactions with fluorine or free alkali metals require use of metal vessels. Metal vessels are also indispensable for high-pressure work.

COPPER

In addition to applications resulting from its electrical conductivity, copper is very useful as a material for vessels employed in work with fluorine (for details cf. Part II, 3 and 4). Aside from this, copper is frequently used for cooling coils and other heat exchangers. Copper tubing of many different sizes is available on the market. It is annealed before use, allowing it to be easily shaped. Since it hardens again on bending, a second annealing may be necessary. Flexible conduits, e.g., connections to steel cylinders, are best made of thin-walled copper tubing, which can be either soldered (hard or soft solder) to the connecting valves or fused to special glasses. Copper develops fissures when heated to red heat in a hydrogen stream. Seamless tombac (a zinc-copper alloy) tubing (also called "spring-tube," "metal-bellows tubing") is more flexible than copper for this purpose (cf. below, Fig. 50 a). Its flexibility is improved by corrugating the tubing walls. Tombac tubing should not be annealed or joined with hard solder. It is joined either with soft solder, or through a special commercially available threaded fitting. The inside grease coating, applied during manufacture, is removed by rinsing with ether and drawing air through while gently heating.

Where low heat conductivity is desired, German silver or similar alloys are employed (cf. Handbook of Chemistry and Physics, Chemical Rubber Publishing Co., Cleveland, Ohio).

Table 11. Summary of Properties and Usefulness

Material	Maximum use temp., °C	Max. allowable temp. under pressure of 2 kg./cm ² , °C	M.p., °C	Gas permeability	Ability to withstand temperature changes	Average thermal expansion coefficient	Density	Thermal conductivity
Quartz (Vitrosil) (fused silica)	1250		ca. 1500	very good	excellent	10 ⁻⁶	2.1	1.08 kcal./m. hr. °C
glazed Hard porcelain	1100							
unglazed	1300	ca. 1400	1680	very good	satisfactory	10 ⁻⁶	2.46	at 20°C 1.23 kcal./m. hr. °C
2005 FR 2107 Fire clay	1500	1540	1850 ca. 1730		fairly good fairly good		2.2	
HK 5	ca. 1750	ca. 1700	ca. 1850		fairly good		2.4	good
R Sillimantinite	1600 (1300)	1600	1825	porous	very good			good
60	1600			porous	very good			
Marquardt mass unglazed	1700		1825	porous	fairly good	10 ⁻⁵		
K-mass (high alumina) heat resistant porcelain	1700		ca. 1800	very good	fairly good	10 ⁻⁶	2.46	at 20°C 1.72 kcal./m. hr. °C
10 a Sillimanite	ca. 1700		above 1800	impermeable to gases	quite good	~0.5 · 10 ⁻⁵	2.85	depending on the temperature; 2.4 kcal./m. hr. °C
H	1700		1850	slightly porous	good	~0.6 · 10 ⁻⁵	~2.3	2.0 kcal./m. hr. °C
Pythagoras mass (a hard porcelain)	1700	ca. 1700	1820	very good	fairly good	10 ⁻⁵	2.9	1.2 kcal./m. hr. °C
Sintered zirconia (ZrSiO ₄)	1750	1600	not constant	slightly porous	good		4	low

Selection and data in this table were made for the purpose of general orientation only. Their properties cannot therefore be guaran-

of Some Important Ceramic Materials.

Chemical properties	Behavior toward other materials cited in this table	Range of application
Begins to devitrify above 1150°C. Resists all acids, except conc. phosphoric (above 300°C) and HF, up to the maximum temperatures of use; attacked by bases and basic oxides	Resistant to all raw materials mentioned here	Vessel material for metallic alloy and acid oxide melts. Attacked by Al, Te, Mg, and Mn at high temperatures.
Good chemical resistance, especially to acidic fluxes, except HF and H ₃ PO ₄ ; somewhat attacked by strongly alkaline fluxes		Vessel material for metallic, alloy and salt melts up to 1250°C
Resistant to basic steel melts fluxes; slightly attacked by acid steel melts Satisfactorily resists alkaline melts and acid fluxes		Vessels for metallic melts (steels)
Resistant to flue dust and furnace gases; reducing up to 1600 °C, oxidizing up to 1300°C Stable in reducing and oxidizing atmospheres	Not attacked by Al ₂ O ₃ . Caution required with basic oxides, especially MgO	Protective tubes for temperature measurements (thermocouples) and for furnaces
Similar to porcelain, but more basic		Vessels for metal melts
Considerably higher chemical resistance than that of porcelain; more basic than porcelain		Vessels for metallic, alloy, salt and glass melts
Good resistance to melts, especially acidic ones Resistant to attack by ash components and flue dust	Compatible with all other materials containing alumina and silica	Vessels for metallic and alloy melts (Tammann crucible), protective tubes for pyrometers. External protective tubes for pyrometers; sheathing tubes for electric-oven heating coils
More resistant than porcelain to all forms of chemical attack. Resistant up to 1600°C to most acid fluxes		Vessels for metallic, alloy, salt and glass melts
Resistant to acids; attacked by basic substances at high temperature	Least compatible with BeO, MgO	Vessels for metallic and alloy melts

ted and this table should not be interpreted as recommendation of specific products.

Table 11 (continued)

Material	Maximum use temp., °C	Max. allowable temp. under pressure of 2kg./cm ² , °C	M. p., °C	Gas permeability	Ability to withstand temperature changes	Average thermal expansion coefficient	Density	Thermal conductivity
Corundum bonded with kaolin, sintered (Al ₂ O ₃ + 5%SiO ₂)	1800	1700	under 2000	porous	good		3.5	good
Sintered alumina (Al ₂ O ₃)	1850, poss. more	1750	2050	good	good	10 ⁻⁷ to 10 ⁻⁶	3.4-3.9	good
Sintered beryllia (BeO)	under 2200	2150	2550	good	very good		2.9	very good
Sintered magnesia (fused MgO)	2200	2000	2700	porous	moderately good	10 ⁻⁵	2.8	good
Sintered zirconia (ZrO ₂)	2500	1900	2700	slightly porous	low	10 ⁻⁵	5.4	low
Sintered thoria (ThO ₂)	2700	1950	3000	good	poor	high thermal expansion coefficient	9.2	low
Carbon	above 3000	none	practically infusible	porous	very good	10 ⁻⁶	ca. 1.5	3.5-8 kcal./m. hr. °C
Electro-graphite	above 3000	none	practically infusible		very good	10 ⁻⁶	1.5-1.7	at 20°C 100 kcal./m. hr. °C

Chemical properties	Behavior toward other materials cited in this table	Range of application
Resistant to alkali, alkali metals and other metals as well as glass and slag fluxes. Not attacked by chlorine, carbon, carbon monoxide, hydrogen, hydrocarbons, etc., even at highest use temperature. Scarcely attacked by even the strong mineral acids, e.g., hydrofluoric or sulfuric	Incompatible with ZrO_2 , $ZrSiO_4$ and BeO ; compatible with other oxides. Caution recommended with ThO_2 at temperatures over $1500^\circ C$	Vessels for high-melting metallic and alloy melts
Resistant to alkaline materials and to reduction by molten metals, carbon, carbon monoxide and hydrogen. Attacked above $1800^\circ C$. Incompatible with SiO_2	Compatible with ZrO_2 up to about $1850^\circ C$; incompatible with other oxides	Vessels for high-melting metallic and alloy melts
Resistant to basic materials even at the highest temperatures. Not resistant to (strongly reducing) carbon at high temperatures	Least compatible with $ZrSiO_4$	Vessels for high-melting metallic and alloy melts
At the highest temperatures, resistant to a very wide range of acid and basic materials. Carbide formation with carbon at high temperature	Very poor compatibility with Al_2O_3	Vessels for high-melting metallic and alloy melts
Resistant at extremely high temperatures, especially to alkaline materials. Stable to reduction by high-melting metals. Carbide formation with carbon at high temperatures	Relatively good compatibility with all oxides; best with ZrO_2	Vessels for high-melting metallic and alloy melts
Resistant to acid and basic fluxes if these do not oxidize. Some surface contamination when metals are fused in vessels made of this material	Formation of SiC above $1400^\circ C$ on contact with silica-containing materials	Vessels for silicate melts, sinter processes, production of refractory metals and reduction of metal oxides
Highly resistant; attacked only by oxidizing agents, e.g., air above $550^\circ C$, steam and CO_2 above $900^\circ C$; stable to metals, if these do not form carbides. More suitable for melting experiments than carbon crucibles because less reactive	If the other material contains SiO_2 , silicon carbide is formed above about $1300^\circ C$. Stable Al_2O_3 , BeO , and MgO up to about $1800-1900^\circ C$	Same as carbon

Table 11 (continued)

Material	Maximum use temp., °C	Max. allowable temp. under pressure of 2kg./cm. ² , °C	M. p., °C	Gas permeability	Ability to withstand temperature changes	Average thermal expansion coefficient	Density	Thermal conductivity
Silicon carbide (SiC)	1500		1500°	slightly porous	very good	$0.5 \cdot 10^{-5}$	2.2	8.5—4.8 kcal./m. hr. °C
Graphite-bonded clay (crucible)	ca. 1700	1700—1800		almost impermeable to gases when glazed	excellent		1.6	very good

SILVER

Silver, like copper, is used for its high electrical and thermal conductivity and further, for its resistance to fused alkali. Pure silver crystallizes on extended heating at red heat and becomes brittle. An alloy with 0.1% nickel is free of this drawback.

GOLD

Pure gold is too soft for laboratory ware. Gold-platinum alloys are sometimes used for their alkali resistance.

PLATINUM GROUP METALS

The metals used include platinum, rhodium, iridium and palladium. Precautionary measures to be taken in handling platinum are well known through the literature circulated by firms producing noble metals (cf. also Part II, 29, Platinum Metals). Rhodium is ordinarily used only in alloys. However, it can also be used for extremely high-melting crucibles, provided appropriate steps are taken to compensate for its tendency to oxidize in air. Platinum-rhodium alloys can withstand very high temperatures because their vapor pressure is very low. They can thus be used for heat conductors and thermocouples. Although iridium has an appreciably higher melting point than platinum, its vapor pressure is more than ten times greater. In spite of this, it is suitable in special cases for vessels in which strongly basic oxides, like BaO, are to be heated in an oxygen-containing atmosphere. For example, it was used in the form of a channel heated by direct passage of

than platinum and is used as an alloying agent. The high permeability of red-hot Pd to hydrogen is used for the preparation of very pure hydrogen.

TUNGSTEN, MOLYBDENUM, TANTALUM, NIOBIUM

This group of metals possesses the highest melting points, lowest vapor pressures, high strengths and low coefficients of thermal expansion. They find many uses in the laboratory (tungsten and molybdenum furnaces, seals with quartz and other glasses, etc.). These metals are commercially available in large pieces, sheets, tubes, wires, etc. At higher temperatures a protective atmosphere or a vacuum is absolutely necessary. In the case of Mo and W, the protective blanket may consist either of inert gases or of hydrogen or a hydrogen-nitrogen mixture (synthesis gas). However, only the inert gases should be used for niobium and tantalum. Tantalum has a very high chemical resistance, with special resistance to hydrogen chloride. Molybdenum is stable to free alkali and alkaline earth metals even at high temperatures.

IRON AND NICKEL

Their use in the laboratory is well known. Very pure iron (e.g., carbonyl iron) and pure nickel, and sometimes also high-grade alloy steels, serve as crucible and boat materials. In particular, they are resistant to liquid and gaseous alkali and alkaline earth metals at high temperatures.

JOINING BY WELDING AND SOLDERING

Welded joints are the best for most uses. Platinum group metals are either welded directly in an oxy-hydrogen flame by melting together (thermocouple wires; see below under Thermocouples), or they are heated to bright-red heat and joined by a sharp hammer blow. Welding of other metals should be entrusted to an experienced specialized machine shop (see Angerer [1]).

Hard soldering is applicable in most cases. Spelter solder, silver solder (m.p. about 700°C) and pure silver (m.p. 960°C) are used. The cleaned junctions are sprinkled with a generous amount of borax, and when they are sufficiently hot the solder (as powder or as wire) is added. With a large amount of borax and pure silver, even Mo and W can be hard soldered.

Soft soldering with a lead-tin solder is common. This is usually done with a soldering fluid (a solution of $ZnCl_2$ in HCl) or soldering paste to deoxidize the junctions. However, a thorough mechanical cleaning of these junctions is also essential. Special solders for aluminum are also commercially available.

GLASS TO METAL SEALS

The compatibility of Pyrex and Kovar has already been mentioned. Platinum and Pyrex are also compatible as are tungsten and uranium with Nonex glasses. Other metals may be used with special glasses available from the Corning Glass Co., Corning, N. Y. Only those metals whose coefficients of thermal expansion between room temperature and the transition point of glass differ by not more than 10% can be used for making glass to metal seals.

For more information, see [5].

Plastics

Among the many kinds of plastics, some have secured a permanent place in the laboratory, mainly because their resistance to acids (especially HF) and to alkalis. Plastic tubing is transparent and very durable; its advantage over rubber tubing is that it is rather stiff and does not pinch. Plastic tubing should be slightly preheated before slipping onto a glass tube (by dipping into hot water, for example) and greased with a drop of oil. Thermoplastic materials (Plexiglas) are readily workable by bending (when heated), sawing, turning and cementing. They can be welded with a simple hot-air device constructed for this purpose. In this device, the temperature of the hot air is readily controlled and the welding rod is of the same material as the other parts.

Polyethylene is resistant to strong acids and bases. It is attacked by halogens. It can be used up to 70° C. On cooling with liquid nitrogen it invariably develops fissures. It is joined by heat sealing.

Polyvinyl chloride is resistant to strong acids and bases.

Teflon and Kel-F are especially resistant to boiling concentrated mineral acids, including aqua regia, and to free halogens and most organic solvents. (Teflon = polytetrafluoroethylene; Kel-F = polytrifluorochloroethylene.) While both of these materials are somewhat difficult to form and machine in the laboratory, they can be used up to almost 300°C.

Pure Solvents

VERY PURE WATER

See also Part II, 1. Many excellent devices for producing single and double distilled water are available. Ion exchange purification is suitable for many purposes. For small-scale conversion a make-shift apparatus of this nature can easily be constructed: e.g., a

glass tube 50 cm. long, 3-4 cm. diameter, filled with granulated ion exchange resin. Large-scale apparatus with electronic purity control is commercially available.

ALCOHOL

The customary method of dehydration with quicklime yields appr. 99.5% alcohol, which is satisfactory for most purposes. For a purer product, this can be further dehydrated by refluxing with calcium chips, followed by distillation. It is better to perform the regular distillation over lime not in a round-bottom flask but in a copper still, which can be heated in an oil bath to 150°C. Only in this way can the major part of the alcohol used be recovered, since without vigorous heating a considerable amount is retained by the lime. Such a still with a removable head pays for itself after a short time, since glass flasks frequently break when the solidly adhering lime cake is being removed. Even better, alcohol can be heated with lime in an autoclave for 1-2 hours at 100°C, and distilled off by opening the valve. Quick water removal can also be achieved by boiling with calcium carbide (175 g. CaC_2 per 1000 g. alcohol; reflux 30 min.; add 1 g. CuSO_4 ; reflux another 15 min., then distill off. Caution! Use only a water bath for heating; the copper acetylide formed is explosive. The product is almost 99.9% alcohol. Very pure alcohol can also be obtained by dehydration with magnesium. A small amount of lime-dehydrated absolute alcohol is added to a small excess of magnesium turnings in a flask equipped with a reflux condenser. The quantity of turnings (for binding the water) is calculated on the basis of the total amount of alcohol, according to the method of Grignard. Following the addition of a few grains of iodine, the flask is heated to boiling. After the start of the reaction, commercial 96% alcohol is added slowly through the condenser; the alcohol in the flask should, however, never become too diluted with water or the reaction will stop. Finally, the alcohol is distilled off. About 75-100 g. of Mg is required per liter of alcohol. Methanol can, of course, be dehydrated the same way. The troublesome heavy bumping encountered during distillation of alcohol from lime can be avoided if the alcohol is always kept at the boiling point. In other words, after the dehydration is completed, the condenser head should be switched from the reflux to the distilling position while the solution remains boiling. Another efficient dehydration procedure for predried alcohol is refluxing for two hours with an addition of sodium (7 g./liter) and diethyl phthalate or diethyl succinate (25 g./liter), followed by distillation of the alcohol from the high-boiling ester [Smith, J. Chem. Soc. London 1927, 1288; see also J. Amer. Chem. Soc. 53, 1106 (1931)]. The last method yields a product with a water content of less than 0.01%. For determination of water content, see E.

Eberius, "Water Determination with Karl Fischer Reagent," 2nd edition, Weinheim, 1958.

ETHER

Preparation of absolute ether by shaking with CaCl_2 , allowing it to stand over sodium wire and subsequent distilling is well known. Peroxides, which can be easily detected in ether with a titanium(IV)-sulfuric acid mixture, are removed by shaking with a solution of 600 g. FeSO_4 , 60 ml. H_2SO_4 and 1100 ml. water in a separatory funnel. Separation of the layers is followed by distillation. Equal volumes of ether and solution are used. It is then stored in well-filled bottles over sodium wire.

For the purification of other organic solvents, consult the well-known textbooks on methods of organic chemistry.*

Mercury

Mechanical impurities are removed by filtration through leather, a glass suction funnel, a porcelain filtering crucible or by the makeshift device of filtration through a paper filter, the apex of which has been pierced several times with a pin.

Dissolved base metals are removed by shaking with oxidizing agents or acids, or by aeration; these processes are preferably combined, as illustrated in Fig. 3. Shaking with 5% mercury nitrate solution containing 15-20% HNO_3 , then with very dilute HNO_3 , and finally with water is also recommended. Recently, treatment with cold, saturated KMnO_4 solution was indicated to be very effective. The mercury should be shaken repeatedly with fresh solution until the color of the KMnO_4 no longer changes over a period of half a minute. It is then washed with water, allowed to settle and acidified with a small amount of HNO_3 ; with this treatment the Hg coalesces. It is then washed, dried by heating in vacuum and finally distilled.

Suitable devices for distillation, for example, that shown in Fig. 4, are commercially available. Figures 5 and 6 illustrate types of apparatus readily made from Pyrex glass [cf. D. Goux, *Chim. Ind.* **70**, 216 (1953)]. The apparatus is attached to a suitable stand and a small red control lamp is connected in parallel to several coils of the electric heating element. Once the apparatus is evacuated at F , it will keep on continuously evacuating itself,

*For example, C. Weygand, *Organisch-chemische Experimentierkunst* [Technique of Experimental Organic Chemistry], Leipzig, 1948.

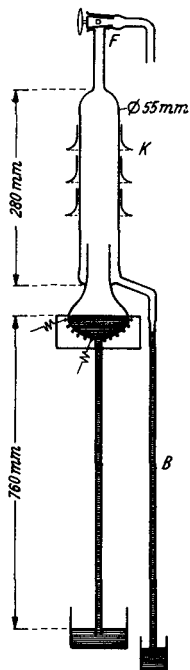

Fig. 4. Automatic distillation of mercury: *K*; cooling sleeves of slotted and bent aluminum foil.

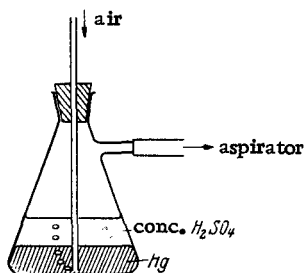

Fig. 3. Purification of mercury.

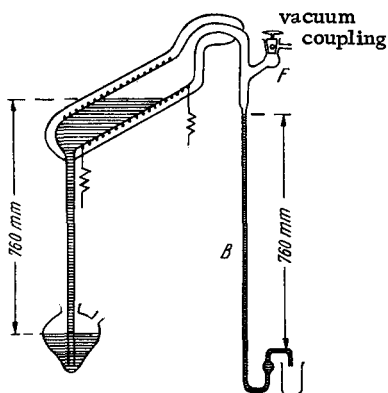

Fig. 5. Automatic distillation of mercury. (Length of distillation vessel 180 mm., diameter 35 mm.; the vessel is insulated with a thick layer of asbestos.)

should traces of gas enter along with the impure Hg, since tube B, assuming its diameter is not larger than approximately 2 mm., acts as the down pipe of a Sprengel pump.

Pure Hg should leave behind no "tail" on decanting. Mercury tongs or a mercury pipette (Fig. 7) may be used to pick up spilled Hg. The pipette is operated with an attached vacuum pump (water aspirator). With this device, spilled Hg can also be retrieved from cracks.

Sealing Materials and Lubricants

The choice of sealing materials and lubricants deserves particular consideration, especially since a great number of

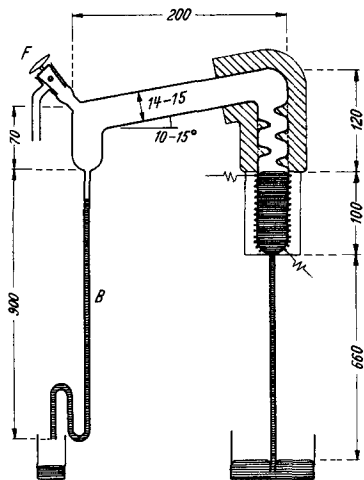

Fig. 6. Automatic distillation of mercury.



Fig. 7. Mercury pipette.

suitable substances are available today to meet even specialized requirements.

LUBRICANTS

These are principally used for ground joints and stopcocks. Numerous commercial products are available; of these, the following are most frequently used:

Ramsay grease has many uses and is commercially available in two forms: "viscous," chiefly for standard stopcocks and ground joints, and "soft," for large stopcocks and ground joints as well as desiccators, and for use at lower temperatures. This lubricant satisfies most of the requirements of preparative laboratory technique and even suffices for high-vacuum work. It can be prepared by mixing paraffin, vaseline and crude rubber (1:3:7 up to 1:8:16).

Apiezon greases are rather expensive, but indispensable for the most stringent conditions of high-vacuum work. Their vapor pressure is immeasurably low at room temperature. They are also rather resistant to halogens but, because of their greater fluidity, have the disadvantage of being more easily squeezed out of the lubricated surfaces when used for large stopcocks and ground joints. This can be prevented if a band of Ramsay grease is placed at the upper part of the stopcock or ground joint. The Ramsay

grease has less tendency to flow because of its rubber content. In this case, care must be taken that the Ramsay grease does not get into the apparatus to be evacuated. Apiezon grease is commercially available in two consistencies, P and R; P is the most widely used.

Silicone grease, which is chemically very resistant, is also recommended to prevent rubber from sticking to glass. Its vapor pressure at room temperature is immeasurably low. It is also serviceable at rather high temperatures. The author has observed that, with this grease, stopcocks that have not been used for a rather long time have a tendency to stick. When warmed, however, they can almost always be readily loosened again.

Greaseless lubricants. If ground joints or stopcocks come into contact with organic solvents, the use of the previously mentioned lubricants is inadvisable. In these cases, a mixture of melted sugar and glycerol can be useful. Kapsenberg recommends triturating 25-35 g. of dextrin in a porcelain dish with 35 ml. of glycerol, added gradually, and then heating the mixture over a free flame, with stirring, until a grease of honeylike consistency is formed. This is heated twice until it foams and is then filtered through cotton wool. It should be stored in a glass-stoppered bottle. It is hygroscopic and somewhat more viscous than vaseline. A paste made from very fine bentonite with glycerol is frequently useful.

Stopcock greases stable to chlorine can be obtained by chlorination of paraffin-stearin mixtures at 150°C and additional treatment with NOCl. The chlorinated mixtures are degassed by heating in vacuum. At higher temperatures perchloronaphthalene may also be used as a lubricant. Apiezon greases are also fairly stable to chlorine, even without preliminary treatment.

REMOVABLE CEMENTS

Suitable cements should have low vapor pressures and should not be too brittle.

Picein, vapor pressure approximately 10^{-4} mm. (20°C), is useful. It may be used up to approximately 60°C, and is readily soluble in benzene and toluene. Other waxes with low vapor pressures and variable hardnesses and usable up to 80°C are available from the J. G. Biddle Co., Philadelphia.

In place of the opaque, black picein, clear and transparent polyvinyl acetate may also be employed. Those polyvinyl acetates which soften at a low temperature are used in a manner similar to picein. It should be noted, however, that polyvinyl acetate chars rather easily when in contact with a free flame. Polyvinyl acetate is insoluble in water and aliphatic hydrocarbons but is soluble in esters, ketones, chlorinated hydrocarbons and benzene.

Polyethylene, in the form of a film placed between the previously heated surfaces of a ground joint, is especially suited as a sealing material for joints used at higher temperatures.

CEMENTS FOR HIGHER TEMPERATURES

Silver chloride, melting point 455°C , adheres excellently to glass, quartz and metals, but only if (according to Stasiw and also Von Wartenberg) a few small granules of Ag_2O have been dissolved in the previously fused AgCl ; the Ag_2O is dissolved essentially without decomposition. Mönch recommends lowering the melting point by addition of TlCl . A mixture of 27.2 g. of TlCl and 18.2 g. of AgCl melts at 210°C . A mixture of 3 g. of TlCl , 4 g. of AgCl and 6 g. of AgI melts still lower (131°C) [R. O. Herzog and H. M. Spurlich, Z. physik. Chem. (Bodenstein Anniversary Volume), 241 (1931)].

Alloys. Wood's metal, Rose's metal (see section on Alloys). Alloys of 40 parts Bi, 15 parts Hg, 25 parts Pb, 10 parts Sn and 10 parts Cd adhere especially well to glass. Pure indium metal (m.p. 155°C) and various indium alloys (for example, 50% In +50% Sn, m.p. 117°C) are suitable for joining metal to glass, quartz or ceramics. The surfaces of the parts must be very clean. Precautions should be taken with regard to the temperature ranges suitable for the various alloy cements and for the materials to be cemented.

PERMANENT CEMENTS

Glycerol-litharge cement. Glycerol is dehydrated as completely as possible by heating at a high temperature; litharge is likewise heated at 200 to 400°C . After cooling, 20 g. of litharge is stirred with 5 ml. of the anhydrous glycerol. The surfaces to be cemented are rubbed beforehand with glycerol. Setting time, approximately 1/2 hour. The cement withstands temperatures up to approximately 300°C . The cemented spots can be loosened with a strong sodium hydroxide solution.

Waterglass cements. Mixtures of feldspar and waterglass or of talc and waterglass are serviceable up to quite high temperatures. The two components are stirred together to form a thick paste and the cemented parts are then first allowed to dry in the air and later, slowly in the drying oven. The cement withstands quite high temperatures.

Zinc oxide cements. Zinc oxide, stirred with zinc chloride solution, hardens in a few minutes to a stonelike mass. Dental cement (obtainable from dental supply houses) also belongs to the class of zinc oxide cements; it consists of a solid and a liquid component and after trituration hardens in a few minutes. The fact that the volume remains constant on hardening is especially advantageous.

Bakelite cements. Bakelite lacquer is used as a cement and the cement is then heated in the drying oven. In this way, solidification to a very hard mass takes place. Mixtures of Bakelite with talc, prepared chalk or kaolin may also be used as cements.

Epoxy resins, when mixed with a hardening agent, cross link on gentle heating; in this way, very strong and even vacuum-tight joints between the following materials are obtained: metal, glass, porcelain, thermosetting (not thermoplastic) synthetics, vulcanized rubber. Epoxy cements can be cooled to very low temperatures without cracking and have very low vapor pressures (10^{-6} to 10^{-7} mm. at room temperature).

In conclusion, various commercially available household cements may be mentioned. It is not possible to enumerate all of these; however, they often prove to be very useful in the laboratory.

High Temperatures

COMBUSTION HEATING

Except in unusual circumstances, only gas burners need be considered for the laboratory; these are commercially available in a great variety of well-known types. With these burners, small crucibles may be heated to approximately $700-800^{\circ}\text{C}$, and using a Winkler clay forge, even to approximately 100°C higher. For still higher temperatures, the well-known blast burners are used; the compressed air necessary for their operation is produced either by a water or an electrically operated compressor. A very hot flame is produced by admixing O_2 to the blast in a mixing tee. Highly recommended blast burners with finely adjustable auxiliary connections for oxygen are also commercially available. It is not necessary here to go further into the subject of the numerous types of gas furnaces, of which the Rössler furnace is the best known. Furnaces based on the Schnabel principle of flameless combustion on thermostable packing material are very effective. Figure 8 schematically illustrates the construction of such a furnace (J. D'Ans, E. Ryschkewitsch, T. Diekmann and E. Houdremont [6]). With petroleum-oxygen mixtures, very high temperatures (up to 2600°C) can also be attained (H. von Wartenberg [6]).

Acetylene hardly needs to be considered for use in laboratory burners. On the other hand, special furnaces with oxy-acetylene burners reach very high temperatures (up to 3200°C).

ELECTRICAL HEATING

Electrical heating apparatus is becoming more and more popular in the laboratory, even for purposes for which only Bunsen burners

were previously used. Hot plates, flask heaters, etc., are offered by all distributors of laboratory supplies, but simple household hot plates are also frequently used. Unlike Bunsen burners, electrical heaters provide steady heat, not interrupted by occasional air draft, and may be controlled by small commercially available and inexpensive regulators. The latter are based on periodic current interruption, the timing of which is controlled with a dial knob. Naturally, one can also make use of transformers or rheostats; however, the latter cause power losses. Various types of immersion heaters, which for chemical work are available sheathed in quartz glass, must be especially mentioned.

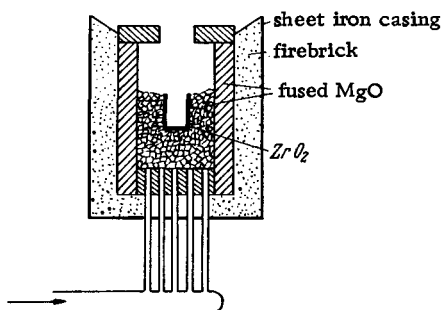

Fig. 8. Furnace for flameless combustion.

For rapid, loss-free surface evaporation of liquids, quartz heaters, also called surface irradiators, are used. Various electrically heated water baths and air baths are also on the market. Air baths in which the heating elements do not reach red heat are also assigned to the infrared heater class. They reduce the possibility of igniting highly flammable fumes. Heating units in the form of cushions, hoods or tape made from glass fabric with embedded heating wire are available. They are known as "mushroom" heating hoods or "electrothermal" mantles. These are especially useful for heating flasks or tubing filled with flammable liquids.

Many well-designed electrical crucible furnaces are priced so low and are so well known that detailed discussion of these is superfluous. Electrical furnaces for heating tubes are often made right in the laboratory because they have to be frequently adapted for special purposes, for which adequate equipment is not commercially always available. Loss of current and material can be avoided by using the correct dimensions. Good thermal insulation is particularly important, not only to save current, but for the workers' comfort, especially during the hot summer months.

The following furnaces are classified according to type of heating element:

1. Wire-wound furnaces.
2. Silicon carbide rod or tubular furnaces.
3. Carbon (graphite) tubular furnaces.
4. Special furnaces: iridium and tungsten wire furnaces, high-frequency heating furnaces, cathode ray ovens, arc furnaces, etc.

WIRE-WOUND FURNACES

The heating element consists of an alloy conductor in either wire or tape form (Nichrome, Kanthal, Megapyr, etc.). The conductor can also be platinum wire or tape or molybdenum wire.

Platinum-wound furnaces are commercially available. They are especially useful in specialized small units where constant high temperature is required. In such cases the furnaces are internally wound. The making of such furnaces is further described below. Furnaces with Nichrome, Kanthal, Megapyr, etc., elements are constructed as follows: After the size of the furnace for the intended application is determined, the tube on which the heating element is wound is selected. For temperatures below 500°C aluminum tubes are satisfactory. Steel tubes can be used up to 600-700°C. For higher temperatures only ceramic tubes are acceptable. Metal tubes help ensure even distribution of temperature throughout the furnace. Unglazed porcelain, Pythagoras mass, K-mass, Sillimanite, Sillimantite and sintered alumina can be used as ceramic tubes. The use of alumina is reserved for especially high temperatures. Construction of a furnace is simple when threaded tubes, on which the conductor is wound, are used. According to R. Fricke and F. R. Meyer [6], very neat furnaces, with the additional advantage of transparency, can be made from pieces of glass tubing (Pyrex, Vycor). These fine furnaces are restricted to the lower range of high temperatures. The tube is continuously wound with the conductor, which is held in place by the tightness of the winding.

To determine the length and cross section of the conductor, the surface of the tube is first measured. Then the wattage needed for reaching the desired temperature (assuming moderately good insulation) is estimated according to the following empirical rules.

Up to 300°C, 20 watts per dm^2 * are required; for each 100° increment up to 700°C, 20 additional watts per dm^2 over the basic figure; therefore, 100 watts/ dm^2 for 700°C. Between 700° and 1100°C, 30 watts are necessary for each additional 100°. Between 1100° and 1300°C: 40 watts. Between 1300° and 1500°C: 50 watts. Above 1600°C: 60 watts; accordingly for 200°C, 700 watts/ dm^2 are required.

*1 dm^2 = 15.5 in^2

The required amperage is then calculated from the available voltage. As a safety factor, the voltage figure should be reduced by 10%. Resistance in ohms and approximate wire length are then calculated. For smaller furnaces the distance between spirals is held to about 1 mm. Thus, about 2 mm. of tube length is required per turn. The wire length is calculated from the tube circumference. As most wire material has a resistance of 1 ohm/mm.² of cross section, an approximate figure for the cross section of the wire can now be determined. This figure is sufficiently accurate for laboratory purposes.

Sample calculations for a small laboratory tube furnace: the furnace is to reach 900°C; the tube diameter is to be 2 cm., the tube length 30 cm.; the available power supply is 220 volts. As mentioned before, the latter should be reduced by a factor of 10%. Therefore, the calculations are based on 200 volts, in order to assure the attainment of the required temperature, as well as permit some temperature regulation. The surface to be heated is about 2 dm.², and using the aforementioned empirical rule, 320 watts is required for 900°C. At 200 volts, 1.6 amp. is necessary. For 1.6 amp. at 200 volts the conductor resistance must be $200/1.6 = 125$ ohms. At a 2-mm. coil pitch and a 30-cm. tube length we arrive at 150 turns, or, at a circumference of 6 cm. a wire length of 9 m. The maximum load of the usual heating wire (Nichrome), 0.6 amp. for each 0.1 mm. of wire diameter, is normally assumed. Thus, a conductor of 1-mm. diameter will carry 6 amp. The resistance of such heating wire is generally indicated on the spool (Nichrome about 1.3 ohms/mm.²; see also the Handbook of Chemistry and Physics, Chemical Rubber Pub.) For wire of 0.3-mm. diameter, a wire length of 9 m. is required at a coil pitch of 2 mm.

If platinum wire is chosen as the conductor, the high temperature coefficient of resistance, which at 1000°C is 3 to 4 times that at room temperature, must be taken into account. Therefore, platinum furnaces should always be heated slowly, using a rheostat in series with the winding. Otherwise the furnace is in danger of burning out at the hot spots, since the heat transfer from the wire to the furnace wall is not uniform. When the length of the conductor has been determined, the winding of the wire can start. For use below 1000°C it is advantageous to first wrap the tube with a layer of moist asbestos paper. When that has dried, the wire is wound on top of it. In high-temperature furnaces the wire is wound directly around the tube. The wire cross section is increased at the ends by twisting the conductor around itself and the wire is fixed at each end by a loop or, even better, by a sleeve slipped over the tube. Both ends of the winding are secured in the same manner. In furnaces used up to 1000°C, a talc-waterglass paste is applied in a layer approximately 1 mm. thick over the surface of the conductor. For higher temperatures, an aqueous paste, made of

equal parts of carbonate-free MgO and silica-free Al_2O_3 , can be used (insulating compounds containing free silicic acid destroy the conductor rather quickly at higher temperatures). After air drying, the tube is dried in an oven and finally heated by passing current through the winding. Now the tube can be placed in a pipe or a sheet metal housing. The free space between the tube and the housing is filled with magnesia or diatomaceous earth. Ready made, easy to handle magnesia (plus additive) insulating material is commercially available. Adequate furnace insulation can also be easily made from asbestos pulp, cemented together with waterglass. The free spaces are filled with mineral wool, loose asbestos or MgO, if necessary in layers (MgO inside, mineral wool outside). For low temperatures, wrapping with several layers of asbestos cord is sufficient. The protruding wire ends leading to terminals are insulated with ceramic insulating beads (available from electric supply houses). A ribbon conductor can be advantageously used instead of wire. For even distribution of temperature in the furnace, we recommend closer winding at the ends than in the middle, as the ends always tend to be cooler than the middle of the furnace. However, it is difficult to find the right coil pitch without some careful experimentation. Therefore, it is sometimes desirable to add supplementary windings near the ends and control them separately.

Furnaces with uniform temperature distribution over the whole length of the tube, including the furnace ends, can be made from a single block of aluminum or bronze (wall thickness 15-20 mm. with a longitudinal hole drilled for a thermocouple). Heating wire, strung with insulating beads, is wound around the block.

The heating coil branches off at about 5-10 cm. from each end of the furnace. Each branch consists of a twisted wire, connected to the main coil. The middle portion of the coil, in which the current must be lower than in the end sections, is thus isolated. The branch wires can be connected via a suitable rheostat, thus regulating the current in the newly formed parallel circuit. Very good insulation, projecting over the block ends, is mandatory.

Stands equipped with mechanisms for raising and tilting the furnace are excellent for mounting purposes. This type of mounting also permits the furnace to operate in an inclined position (see Fig. 9).

FURNACES WITH INTERNAL HEATING COILS

These are not as difficult to make as it would seem at a first glance. With Pt wire, the wire length must be calculated based on the resistance at maximum temperature. A round wooden core, with a diameter 1-2 mm. smaller than that of the heating coil, is turned out on a lathe. This core is then cut lengthwise into three wedges as shown in Fig. 10. The parts are reassembled and wrapped

with a layer of tissue paper, and a thin string is tightly wound along the whole length of the assembly. The assembly is then wrapped with a few additional layers of tissue paper, the paper is lightly soaked with oil, and the assembly is finally wound with Pt wire. The wound assembly is coated with a water-dispersed ceramic powder and allowed to dry. It is recoated after drying and inserted into a suitable porcelain tube while still moist. Any free space is filled with insulating compound. After air drying, it should be dried thoroughly in an oven. The string is then carefully pulled out and the wooden core removed by extracting the middle wedge. Again the coreless assembly is thoroughly dried, and then slowly and cautiously heated until the tissue paper has been incinerated. After cooling, the inside of the furnace is coated with insulating compound, air dried, and then carefully baked until complete dryness. A heating coil can also be embedded in thermal insulation in the same manner as described above. Such furnaces can be used up to 1500°C without difficulty, whereas externally wound Pt furnaces cannot withstand temperatures above 1250°C for any length of time. Rhodium alloys should be used for higher temperatures.

MOLYBDENUM WIRE FURNACES

These can be used up to 1500°C. However, the heating coil must be protected against burnout by a constant, slow flow of protective gas (H_2 , water gas, i.e., $CO + H_2$, or $N_2 + H_2$). These furnaces are easy to regulate, and thermal insulation is no problem. Larger furnaces are rarely "home made" in the laboratory.

Tungsten, tantalum and molybdenum (more or less converted into $MoSi_2$) wires make excellent heating coils for specific applications. See R. Kieffer and F. Benesovsky [6] regarding compatibility of these metals with ceramic materials and insulating compounds at high temperatures.

Because of their low vapor pressure, Mo, W and Ta are well suited for building small high-vacuum furnaces. These furnaces are frequently operated under a glass bell. The available heating

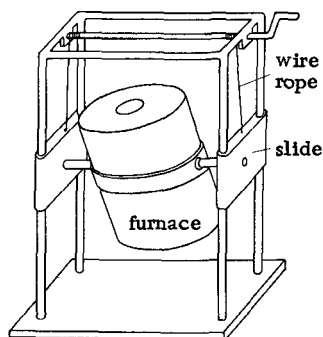

Fig. 9. Stand for electrical furnace.



Fig. 10. Wooden core for making furnaces with internal heating coils.

area is usually small, but very high temperatures can be reached. The heating elements of such furnaces are horizontally or vertically laid spirals of Mo, W or Ta wire. These must be well reinforced by a ceramic structure since these metals soften at high temperatures and are thus subject to plastic deformation. A heating element of this kind must be surrounded by metallic or ceramic radiation shields or by a cooled housing (similar to the apparatus shown in Fig. 12).

All apparatus parts are mounted on a horizontal base, drilled and fitted with vacuum-tight connections for cooling water and electric power. The base and the furnace are enclosed by a large glass or metal bell, making for a vacuum-tight assembly (Fig. 12) (K. B. Alberman; F. Davoine and R. Bernard [6]).

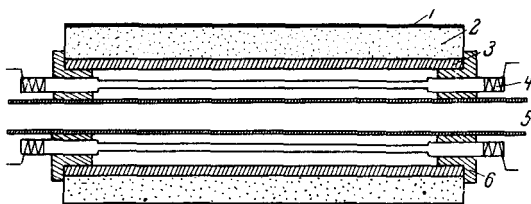

Fig. 11. Globar furnace: 1—External jacket (metal); 2—insulation layer (fireclay grit, MgO, diatomaceous earth); 3—insulation support tube (fireclay); 4—Globars; 5—inner tube (Sillimanite, hard porcelain); 6—end plates drilled for the inner tube and the Globars.

GLOBAR FURNACES

Globar furnaces are much sturdier than most others but are less easy to regulate and, as they cannot be provided with as good thermal insulation, are also less economical. The furnaces are usually made with silicon carbide rods, though pipes are also in use. They may be used without major problems up to a temperature of 1350°C and for short periods, even to 1500°C . Good electrical contact at the conductor terminals is most important. Generally, Globars are manufactured with tightly wound adhering wire or metal ring connectors. It is not difficult to make a Globar furnace in the laboratory, as suitable supports, tubes and outer shields can be obtained ready-made.

It should be remembered that silicon carbide, a nonmetallic conductor, has a lower resistance when heated than when cold. Therefore, the furnace must be heated slowly, using a rheostat or a transformer and an ammeter. With rising temperature, the

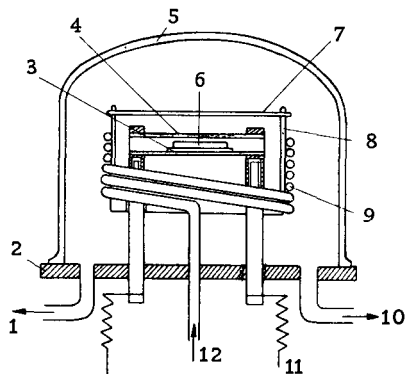

Fig. 12. Tungsten furnace.

1—McLeod gauge; 2—brass base; 3—tungsten plate; 4—tungsten tube; 5—glass bell; 6—sample; 7—screw cover; 8—copper jacket; 9—copper cooling coil; 10—vacuum pump; 11—power supply; 12—cooling water input.

voltage should be lowered to avoid an undesirably high current. A fuse or a circuit breaker should be included in the circuit.

CARBON TUBE FURNACES

The heating element of these furnaces, which were first constructed by Nernst and Tamman, is a carbon tube. Because of their low resistance, they are also called short circuit furnaces. The larger models have found wide industrial use. Thus, these furnaces are commercially available. It does not pay to attempt construction of such a unit in the laboratory. The most expensive part is the transformer, needed because of the low resistance of the carbon tube, and this must be purchased in any case. Depending on the size, these units require some 100-1000 amp. at approximately 10 volts. Careful construction of the unit permits easy replacement of the carbon tube (whose durability at high temperature is limited). Temperatures of over 2000°C can easily be reached. A reducing atmosphere must always be maintained inside the tube. Should this be undesirable, then protective insert tubes must be provided. For this purpose, alumina can be used up to 2000°C. At higher temperatures, only sintered BeO or ThO₂ is effective; MgO is subject to reduction.

A variation of this type of furnace, with slotted graphite tube, has been described by W. J. Kroll [6] and has given satisfactory performance in various tests. Graphite is more resistant to oxidation than carbon. The disadvantage of its lower electrical resistance

is overcome by dividing the tube into several current paths by appropriate longitudinal slots. This arrangement also functions in a vacuum or inert gas atmosphere.

TUBULAR TUNGSTEN FURNACES

Higher temperatures (up to 3000°C) are reached with tubular tungsten furnaces. Because tungsten is sensitive to O_2 , and because of the improved thermal insulation, these furnaces must be operated in a vacuum or at least in an H_2 or an inert gas atmosphere. A model with horizontal W tube is shown in Fig. 12. The tungsten tube, fixed in place with two sturdy, molybdenum-lined clamps, is supported by two heavy brass bus bars. The latter pass through a thick brass base plate, covered by a large glass bell.

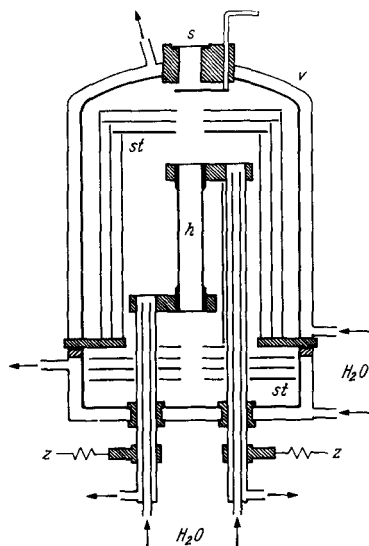

Fig. 13. Tungsten furnace: *h*—tungsten tube; *s*—sight glass; *st*—radiation shields; *v*—vacuum bell; *z*—power input; the necessary vacuum connections to the base are not shown.

One bus bar is insulated from the base plate. The tungsten tube is surrounded by a copper sheet box, to which a tightly wound cooling coil is soldered. The brass base plate is drilled for two other tubes, which serve as connections for a McLeod gauge and a vacuum pump.

The connection to the vacuum pump must be of a large diameter. This furnace will reach 3000°C at 10 volts and appr. 1000 amp. and at a vacuum of 10^{-5} to 10^{-7} mm. In other models, the tungsten tube is vertical (Fig. 13); alternatively, a tubular sleeve made of tungsten plate may serve as the heating element (Fig. 14). (H. Bückler; R. Kieffer and F. Benesovsky [6].) Instead of tungsten, tantalum can also be used; the maximum permissible temperatures with tantalum are not quite as high as with tungsten (not over 2200°C). However, tantalum has the advantage of not becoming brittle through recrystallization, even after prolonged heating.

An iridium furnace has been described by Von Wartenberg [6]. Since iridium has a considerable vapor pressure at high temperatures, the tube interior must be coated with a ceramic compound.

INDUCTION FURNACES

The energy of a high-frequency (for example, one megacycle) alternating current can be transferred through a large diameter coil to an electrical conductor, for instance, a metal or graphite crucible, which is placed inside the coil. The conductor is thereby heated. The ease of operation and the convenience of an induction furnace are unsurpassed. Thus, the red-hot crucible can be enclosed in a cooled quartz tube, in which a high vacuum or an inert gas atmosphere can easily be maintained. However, the pressure range of 10^{-2} to 10^1 mm. cannot be used because of the interfering glow discharge. With induction furnaces, temperatures of up to 3000°C can be reached very rapidly, in fact within seconds. Their disadvantage is the need for elaborate equipment, especially electrical apparatus, and the consequent high cost. Suitable current generators are commercially available. They are usually equipped with large transmitter tubes. It is best to make the furnace itself in the laboratory, designing it for the specific experimental purpose. Under special circumstances, a ceramic tube can be the energy receptor and thus serve as the heating element, provided the ceramic

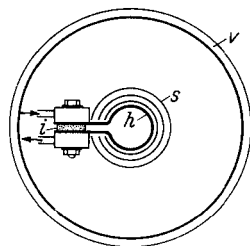

Fig. 14. High-vacuum furnace with a heating element made of tantalum plate (horizontal cross section). *h*—tantalum heating sleeve; *i*—insulator; *s*—radiation shield made of Ta or Mo plate; *v*—vacuum bell.

has a defect crystal lattice and consequently exhibits an intrinsic conductivity at high temperature (H. Davenport et al. [6]). Furnaces with the Nernst compound as a heating element and operated by direct current passage, which are sometimes recommended, have not proved to be satisfactory for normal chemical preparations.

ARC AND ELECTRONIC RADIATION FURNACES

Arc furnaces are useful in preparation of alloys and high-melting compounds with low volatility such as carbides, borides, lower oxides, etc. A small sample of the substance, a so-called button, is melted by a high-current arc under vacuum or in a suitable gas atmosphere at reduced pressure. The arc is struck between a suspended, cooled tungsten rod and a horizontal, cooled copper plate. The latter has cuplike depressions for melting the samples. Such furnaces are commercially available but can also be made without great difficulty in the laboratory (W. J. Kroll, G. Haegg and G. Kiessling [6]).

Several authors have described laboratory furnaces in which heat is transferred by electron bombardment (cathode rays). These are used for special applications [6].

Both furnace types have recently gained industrial importance for use with high-melting metals (Ti, Zr, Nb, Mo).

SOLAR FURNACES

Solar furnaces are suitable for special applications, e.g., for heating in a pure O_2 atmosphere, in which other types of heating elements are corroded very rapidly. In a solar furnace, the sunlight is focused by a large parabolic mirror (e.g., 1.5 m. diameter). Very high temperatures are reached at the focus which, of course, must cover a reasonably large area [6].

Low Temperatures

Freezing mixtures or low-temperature bath (cryostats), cooled with solid CO_2 or liquid nitrogen, are used for reaching temperatures below the ice point.

Ice is used for most freezing mixtures. Adequate crushing of the ice is important. This can be done in an ice mill or simply by pounding with a wooden mallet on an even concrete block 40 × 40 cm., framed by a 10-cm.-high wooden strip. Such a block should be set up next to the refrigerator in any case, even if an ice mill is available. In this way the ice can be easily broken up before using the ice mill. The bad habit of throwing large chunks

of ice into the mill and breaking them there with mallet blows will quickly ruin the most rugged ice mill.

Freezing mixtures based on ice:

3 parts ice + 1 part NaCl	temp. -21°C
3 parts ice + 2 parts $\text{MgCl}_2 \cdot 6\text{H}_2\text{O}$	temp. -27°C to -30°C
2 parts ice + 3 parts $\text{CaCl}_2 \cdot 6\text{H}_2\text{O}$	temp. -40°C
2 parts ice + 1 part conc. HNO_3	temp. -56°C

The temperatures indicated for the last two mixtures can be reached only when the CaCl_2 or HNO_3 is precooled in a refrigerator. In all cases, ice and salts must not consist of coarse chunks but must be well crushed and properly homogenized. If ice is not available, mixtures of NH_4NO_3 and water (1 : 1; cools from $+10^{\circ}$ to -20°C) or KSCN and water (2 : 1; cools from $+10^{\circ}$ to -25°C) can be used.

Lower temperatures may be obtained with solid CO_2 , which can be purchased in blocks as "Dry Ice." If bought in blocks, it must be well crushed, preferably with a mill; or it can be produced as "snow" from a CO_2 cylinder. To make "snow" a strong canvas bag is attached to the outlet valve of the cylinder. A short nozzle screwed onto the outlet is very practical. The cylinder is tilted downward and the valve opened as wide as possible. Strike the bag vigorously while the carbon dioxide flows into it (with a loud hissing noise) or the CO_2 snow accumulating on the inner surfaces of the bag will clog the pores.

Even more practical than this primitive contraption is a hardwood box of about 0.75 liter capacity with a screw-on cover (Fig. 15). The cover has a groove around its circumference and is cut out to the diameter of the wooden box. A conical canvas bag is tightly fastened to this ring-shaped cover with a wire in the groove. A metal tube with a female adapter fitting the cylinder outlet is attached to the top of the canvas bag. The use of this small device is obvious. When the cover is unscrewed, CO_2 snow can be easily removed from the box.

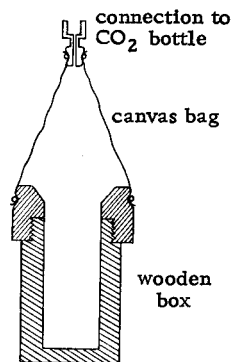

Fig. 15. Wooden box for producing CO_2 snow.

Solid CO_2 in blocks can be kept in brass-plated containers or in large Dewar flasks equipped with canvas bags, similar to those commercially available for food preservation with ice. Large glass flasks such as these Dewars are easily broken; thus, removal and insertion of a bag or container requires the greatest caution.

Since solid CO_2 is a poor heat transfer agent, it must be dispersed in a suitable liquid prior to use. Ether is not acceptable

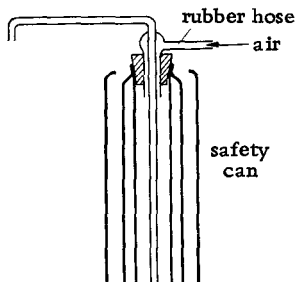

Fig. 16. Device for removing liquid nitrogen from transport vessel.

because of its high flammability. Acetone or the inexpensive methyl or ethyl alcohols are recommended. Trichloroethylene is especially suitable, because CO_2 floats on its surface, thus preventing the mixture from foaming.

Liquid nitrogen is available nearly everywhere.* Small liquefiers for laboratory use are also on the market. For transport, "safety cans" in various sizes are used. The liquid nitrogen is either decanted by means of a tilting mechanism or with a small siphon, which can be made by any glass blower (Fig. 16).

A small rubber bulb provides the necessary pressure for removing larger quantities.

A small rubber bulb provides the necessary pressure for removing larger quantities.

Dewar vessels made of Pyrex are preferred. In the long run, they are much cheaper than thermos bottles because the latter break so easily. However, if one must use flasks of ordinary glass, the unavoidable breakage factor will be considerably reduced by prior rinsing with CCl_4 and slow cooling, while rotating the flask. One should never decant from large Dewar flasks and those made of ordinary glass. Such vessels should always be emptied by scooping out the contents. An appropriate scoop is made by soldering a brass cup (40 mm. wide and 60 mm. high) to a brass wire 40 cm. long and about 3 mm. thick. Smaller thermos bottles are emptied by putting a wet filter on their inner edge. It will freeze on immediately, and the contents can then be decanted. The liquid should always be poured out as quickly as possible. After the experiment is completed, the liquid nitrogen is poured back into the transport container via a sheet metal funnel. Glass or plastic funnels will generally crack.

*Liquid air and liquid oxygen have been used in the past as laboratory coolants. This unsafe practice has by now disappeared almost completely in the U.S. Liquid air and liquid oxygen should never be used when a relatively inert coolant, such as liquid nitrogen, is equally suitable. This, of course, does not preclude laboratory use of liquid oxygen (for examples of the latter, see the section on Fluorine).

If one is forced to use liquid air in the presence of oxygen-sensitive compounds, the cooling flask should be covered with a protective jacket made of copper sheeting. The same protective measure should be taken when liquid air is used for cooling vessels containing activated charcoal (silica gel should preferably be used in these cases).

Cold baths (acetone, methylene chloride, petroleum ether, pentane) are cooled by means of a copper coil soldered to a copper can (Fig. 17). Liquid nitrogen is forced with a siphon through one of the tubes into the can, where it evaporates and cools the bath fluid. The evaporated cold nitrogen gas escapes through the coil.

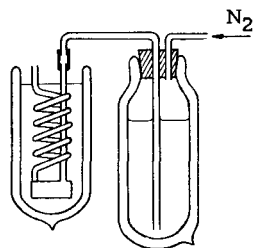

Fig. 17. Liquid N_2 cooling bath.

Constant temperature cooling baths, with temperatures ranging from -20 to -190°C , can be obtained with liquid nitrogen slurries. The liquid nitrogen is mixed with a liquid organic compound with suitable melting point, so that the latter partly solidifies. This slurry is capable of maintaining the melting point temperature for a considerable period of time. A few suitable materials are listed in Table 13.

Cooling blocks made of aluminum have many applications. These are machined as in Fig. 18 and provided with suitable wells for a thermometer and the vessel to be cooled. The block is suspended by a strong cord or in a gauze bag. The Dewar flask, filled with liquid nitrogen, is placed underneath the block, which then may be raised or lowered within the flask, depending on the temperature desired.

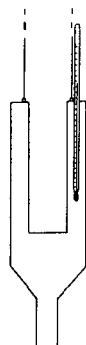

Fig. 18. Aluminum cooling block.

Constant Temperature

No particular difficulties are experienced in controlling temperatures in the region from room temperature up to 300°C . Bimetallic strip devices, Wheatstone bridge circuits (thermistor activated) or mercury thermometers with capacitance devices connected to relays can be used for control of bath temperatures. For good control, the immersion heater should have the lowest possible heat capacity and the bath should have as large a volume as possible. Should the bath volume be small for whatever reason, the heat capacity of the heater should also be low to prevent further bath temperature rise after the current is shut off. A thin Pt wire, wound around a frame, may be used as a heater in these cases; it may be placed directly in the bath without any insulation. Vigorous agitation of the liquid in the bath is important. Bath temperatures somewhat below room conditions may be maintained by means of an immersed copper coil with a constant

Table 13
Cold Baths of Low-Melting Materials

	M. p. , °C
Isopentane (viscous when cold) . . .	- 158.6
Pentane	- 130.8
Diethyl ether	- 116.3
Carbon disulfide	- 112.0
Toluene	- 95
Acetone	- 95
Chloroform	- 63.5
Chlorobenzene	- 45
Ethylene chloride	- 25.3
Carbon tetrachloride	- 23

flow of cool water and a heater which regulates the temperature. If necessary, the water may be precooled by embedding a second coil in ice. Cryostats are preferred for temperatures below 0°C.

CRYOSTATS

At temperatures slightly below 0°C, the well-known Hoeffler thermostat is supplemented by a Dry Ice-filled vessel. However, lower temperatures are generally required and can be attained with liquid nitrogen. Various methods have been described in the literature; almost all of these are based on the principle of allowing liquid nitrogen to evaporate into a cooling coil placed in a cryostat. If the temperature becomes too low, a mechanically or electrically controlled valve interrupts the input of liquid nitrogen. One such cryostat [Peters, Chem. Fabr. 7, 47 (1943)] has a mechanical regulator actuated by the difference in expansion between an aluminum tube and a quartz rod inserted in it. The regulator is contained in an aluminum cooling block and operates a small valve at the outlet of the liquid nitrogen-carrying cooling coil; the latter is also fused to the Al block. The inlet of the cooling coil is connected to the bottom outlet of a liquid-nitrogen-filled special Dewar flask. If the temperature falls below the desired level, the valve closes. No additional liquid nitrogen can then enter the cooling coil because of the pressure in it. When the temperature rises, this pressure is vented through the opened valve and more liquid nitrogen enters. The storage vessel may be too small for lengthy experiments. It may be replaced by a 5-liter Dewar flask and the cooling block may be replaced by a copper cooling coil (Fig. 19), in which

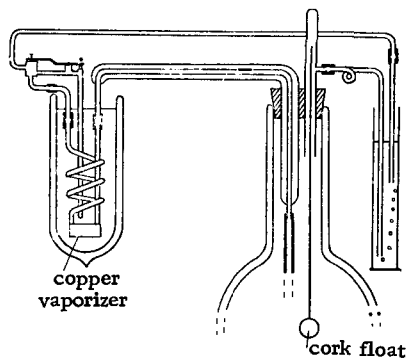

Fig. 19. Cryostat with mechanical regulator.

case the fresh liquid nitrogen flow is controlled by a double-walled siphon. The connection between the copper coil and the glass should be inside the bath to reduce coolant usage. A Mariotte-type bubbler bottle provides the pressure head required. This self-explanatory setup, shown in Fig. 19, works very well. The rubber stopper of the liquid-nitrogen feed vessel can be provided with a sheet metal funnel to facilitate filling. The funnel is stoppered by a cork. A cork float, attached to a thin glass rod, permits easy observation of the liquid level from the outside. Naturally, a vessel with a window can also be used. A similar device, but with electrical controls, has been described by Zintl and Neumayr [Ber. dtsh. chem. Ges. 63, 234 (1930)]. It differs from the above-described apparatus in that the vapor pressure thermometer actuates an electrical control system. The essentials of this device are shown in Fig. 20. The downpipe f to the vaporizer d must be larger than the inner tube of the siphon h so the liquid nitrogen is transferred drop by drop and is not sucked in by the siphon. The tubes of the copper vaporizer must be connected with glass tubes within the bath, using short pieces of rubber tubing. Metal projecting outside the bath would lead to serious thermal losses.

Using this equipment, temperatures such as -50°C can be maintained with a fluctuation of only $0.05\text{--}0.10^{\circ}$. To maintain a cold bath of 2.5 liters of acetone in an unsilvered Dewar flask at -50°C for four hours, about one liter of nitrogen is required.

Thermostats filled with boiling liquids at constant pressure are also quite versatile. Temperatures lower than -196°C can sometimes be reached by evaporating liquid nitrogen at reduced pressure. The temperature is held constant by maintaining a specific pressure with a manostat. Details of these devices may be found in Grubitsch [1].

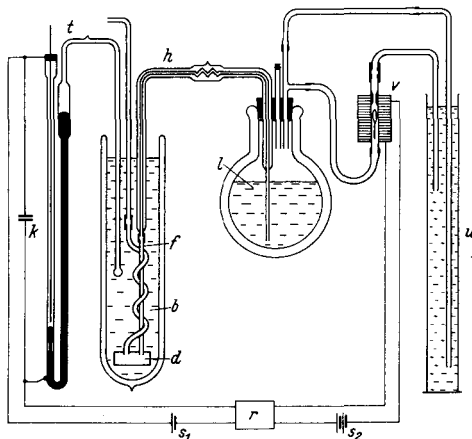

Fig. 20. Cryostat with electrical control: *b*) bath liquid; *d*) copper vaporizer; *f*) down pipe; *h*) siphon; *k*) condenser; *l*) liquid nitrogen; *r*) relay; *s*₁) power supply of about 2 volts; *s*₂) power supply of about 18 volts; *t*) vapor pressure thermometer; *u*) pressure head regulator (manostat); *v*) electromagnetic gas valve; the valve plunger must be sufficiently heavy not to stick in its seat.

HIGH-TEMPERATURE THERMOSTATS

Thermostats can be controlled to 300°C by contact thermometers; expansion regulators are used up to 500°C. The latter are based on the difference in linear expansion between a quartz rod and an aluminum or iron tube. Alternatively, a contact thermometer may be located in a cooler part of the furnace, provided a fairly constant temperature difference can be maintained between the hot reaction area and the cooler measurement section. The frequently recommended arrangement consisting of an auxiliary furnace in series with the main furnace, whereby the contact thermometer is placed inside the smaller furnace, can only work if both furnaces are very well insulated and have equal heat losses. This is not easily achieved in practice.

Detailed description of the great variety of readily available commercial devices for high-temperature control is beyond the scope of this book. These devices are well described in the catalogs of laboratory supply houses and instrument manufacturers.

The available instruments range from simple and inexpensive to highly sophisticated ones, designed to give very precise control. Their proper application depends on circumstances and must be left to the ingenuity and skill of the individual experimenter.

Temperature Measurement

LOW TEMPERATURES

Pentane and alcohol thermometers can be used only for gross measurements. They are too unreliable for accurate measurement, especially at low temperatures. The vapor pressure thermometer described by Stock is very exact and easy to make (Fig. 21). Since its dimensions are shown in the drawing, it is sufficient to describe the filling process. After washing with cleaning solution and water and drying in an air stream, just enough pure Hg is added to bulb *c* to fill the manometer. After the gas trap *g* and the thermometer stem have been closed off by fusion, vacuum is applied at *h* and the whole apparatus, including the Hg, is thoroughly heated. If the manometer is filled with a gas which can be completely condensed at the temperature of liquid nitrogen, the filling gas, from an apparatus sealed on to the vacuum flask, can be condensed at *a*. About 1 ml. of liquid is thus obtained. Opening *t* is then sealed off. The filling gas is then allowed to warm up to room temperature and evaporate. The excess escapes through *m*, so that the flask will now contain a gas atmosphere at a pressure exceeding atmospheric by about 25 mm. The gas is recondensed at *a* with liquid nitrogen. Opening *k* is now sealed off and the Hg is poured from bulb *c* into the manometer arm. The thermometer is now ready for use. If the filling gas cannot be completely condensed with liquid nitrogen, it is necessary to transfer the Hg before admitting the gas. The thermometer should be provided with a millimeter scale and attached to a suitable stand. Substances used for filling are:

CS₂ (+ 25 to -10 °C), SO₂ (-25 to -40 °C), NH₃ (-30 to -77 °C),
CO₂ (-75 to -100 °C), HCl (-85 to -111 °C), C₂H₆ (-100 to -150 °C);

and for even lower temperatures methane and oxygen may be used.

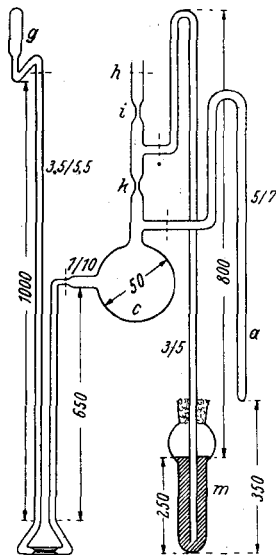

Fig. 21. Vapor pressure thermometer.

LIQUID-FILLED THERMOMETERS

These are suitable for temperature measurement up to 600°C. Their accuracy is poor at temperatures below the melting point of Hg. Mercury-filled thermometers are subject to minor changes during initial use; therefore, good thermometers should be artificially aged. Aside from this, the calibration should be checked from time to time, at least at the freezing and boiling points of water (correct for barometric pressure!). Ice must be finely ground and should be well agitated during the measurement. The boiling point of sulfur may be used as a high-temperature calibration point. Considerable inaccuracy may be caused by "emergent stem." This uncertainty is best avoided by bringing the whole thermometer to the measured temperature. If this is not possible, corrections must be made. The correction is $k = (\alpha - \beta) \cdot (t - t_0) \cdot h$. Here α = expansion coefficient of Hg, β = expansion coefficient of glass, t = indicated temperature, t_0 = average temperature of the emergent stem, in degrees. The value of $\alpha - \beta$ for common thermometer glass is approximately 0.00016. The main uncertainty present lies in the temperature t_0 . A "differential thermometer" is most useful for its determination. The material of this thermometer should be as close to that of the thermometer in use as possible. It is placed alongside the main thermometer in such a way that its indicated temperature is close to the final measurement. The differential thermometer is also provided with second, smaller scale below the first. It is positioned in such a way that the meniscus of the main thermometer and the point on the auxiliary scale of the differential thermometer which corresponds to that temperature, coincide. It is now easy to make the necessary corrections from the indicated data. The error can amount to several degrees.

RESISTANCE THERMOMETERS

These can be used over a very wide range. Their principle of operation is based on the large temperature coefficient of electrical resistance of Pt and Ni (for example, the resistance of Pt changes by 0.4% per degree). These thermometers are among the most accurate temperature measuring instruments. It is not difficult to make a resistance thermometer in the laboratory, but the commercial instruments are preferable. The high-temperature type consists of a mica cross inserted in a thin-wall quartz tube. A fine double Pt filament is wound around the mica cross.

Recently, instruments for measuring low temperatures have appeared on the market. In these, the Pt wire is fused into a fine groove of a glass tube and coated with a thin glass film. Such instruments have very low thermal inertia. For the most accurate measurements the wire should be aged artificially by heating it

at 100° above the intended use temperature until there is no further change in its resistance.

A Wheatstone bridge is used for resistance measurement. Details can be found in Kohlrausch [1].

THERMOCOUPLES

Thermocouples are used for higher temperatures, up to 1600°C. Table 14 gives the usual wire combinations.

Table 14

Couple	Usable range, °C	Thermo- electric output, +20°/ +100°C
Copper/Constantan	- 200 to + 400° (+ 600°)	3.45 mv.
Iron/Constantan	- 200 to + 600° (+ 900°)	4.32 mv.
Nickel-chromium/Constantan	20 to + 700° (+ 900°)	4.96 mv.
Nickel-chromium/nickel	20 to + 900° (+ 1200°)	3.22 mv.
Platinum-rhodium/platinum	20 to + 1300° (+ 1600°)	0.54 mv.

The figures in parentheses refer to permissible limits for intermittent use only; the other figures, to temperatures permissible for continuous use.

Please note: platinum thermocouples must not be heated in a hydrogen atmosphere to temperatures beyond 900°C in the presence of a Si-containing material (including quartz and ceramic substances), since their mechanical strength is greatly impaired by the uptake of impurities (K. W. Fröhlich, "On the stability of platinum at higher temperatures," *Degussa-Metallberichte* 1941, No. 7). For special purposes requiring higher temperatures, thermocouples consisting of, for example, combinations of tungsten and molybdenum alloys may be used. However, because of various complications encountered, optical or radiation pyrometers are usually preferred in this temperature range.

The lead wires of these thermocouples are usually made of 0.35 to 0.5 mm. diameter wire. Sometimes it is undesirable to have thermocouple wires sufficiently long to bring the connections (which also form the cold junctions) directly to constant temperature. In this case the so-called compensators are used. These may be considered lead wire lengtheners. Such compensating wire may be ordered from the companies that supply thermocouples.

The lead wires to the measuring instrument are then connected either directly to the thermocouples or to these compensators. The two wires are fastened together with screw clamps and the junction is kept at an exactly measured and carefully controlled constant temperature (0 or 20°C, glass capillary in a Dewar flask). Millivoltmeters equipped with a temperature scale are also supplied for most of the popular thermocouple combinations. The meter should have an internal resistance of a few hundred ohms, so as to make the lead wire resistance negligible. For more exact measurements the calibration should be checked from time to time against a few fixed reference points. Only when accuracy requirements are extremely high is it necessary to measure the thermocouple e.m.f. by means of compensation switches. Except when working with silicates (where the exposed junction may be immersed directly in the melt), the thermocouple is sheathed with a protective tube (quartz, unglazed procelain, mullite, alundum). The wires should be insulated from each other by thin quartz or ceramic tubes. Before use, the thermocouple should preferably be annealed for a short time by passing through it a sufficiently high electric current. Should the weld or the couple itself have been damaged, it can be rewelded with ease. The damaged part is removed and both ends of the wires are placed in a small, pointed natural gas-oxygen flame, and touched just when they begin to melt. A small bead of metal is formed and connects the two ends.

Should one of the lead wires have to be repaired, the resulting bead is carefully shaped with a hammer so that it will again fit into the insulation tube.* For calibration of thermocouples, the following reference points are used:

Naphthalene b. p.	217.96°C	Gold m. p.	1063.0°C
Tin m. p.	231.9 °C	Copper m. p.	1083 °C
Cadmium m. p.	320.9 °C	Lithium metasilicate	
Zinc m. p.	419.45°C	m. p.	1201 °C
Sulfur b. p.	444.60°C	Nickel m. p.	1453 °C
Antimony m. p.	630.5 °C	Palladium m. p.	1535 °C
Silver m. p.	960.8 °C	Platinum m. p.	1769.9°C

*The home-made and home-calibrated thermocouples described above should be used only if the commercially available products cannot be procured for one reason or another. Fabrication of a reliable and durable thermocouple, especially for use at high temperatures, is a delicate business and should preferably be left to the experts. Thermocouple manufacturers now supply literally hundreds of variations, with all kinds of shapes, lengths, diameters, protective sheaths and insulation. These thermocouples are also available in precalibrated form. Recently, special thermocouples with very fast response time and excellent stability, reproducibility

RADIATION PYROMETERS

For temperatures above 1600°C it is best to use radiation pyrometers, although these may certainly be used at temperatures above 800°C. Their operation is based on comparison of the intensity of the radiation emitted by the measured body with that of an appropriately chosen incandescent bulb. By adjustment of the (known) current fed to the bulb, the image of the filament, projected onto the image of the radiating object, is made to vanish. The temperature can then be read directly from the instrument scale.

Another instrument is based on focusing the total radiation emitted by the measured body on a blackened thermopile by means of a quartz lens. The e.m.f. of the thermopile then gives the temperature. Both the optical and the total radiation pyrometers are commercially available and are very convenient and easy to use.

High Vacuum and Exclusion of Air

The chemists' requirements for high vacuum frequently differ considerably from those of physicists. For a physicist, high vacuum starts only when the mean free path of the gas molecules corresponds approximately to the dimensions of the container (somewhat below 10^{-3} mm.), while chemists' requirements are much more modest. A chemist will frequently be satisfied with a good rotary oil pump. Among the many models commercially offered, those working with small, easily replaceable quantities of oil are preferred. Of these, the pumps operating on the "gas ballast" principle (that is, air is admitted during the compression cycle to prevent condensation) are very convenient, since they can also be used to remove easily condensable gases and vapors, without damaging the pump with condensate. These are perfectly satisfactory for simpler vacuum distillations, drying under vacuum, etc. When higher vacuum is needed they may be supplemented by jet ejectors or diffusion pumps. These last pumps require a forepump, since they work only at pressures ranging from 0.1-30 mm., depending on the type. The diffusion pumps are made of glass or steel and use Hg or a special oil (for example, silicone oil) for the vapor jet. Oil diffusion pumps have the great advantage of not diffusing Hg

and accuracy have been developed for missile and space use. These are usually metal-sheathed and the wires are insulated by compacted refractory powder. These sealed units, already provided with the necessary leads, are available in diameters as small as 0.5 mm. or less. Their cost is not exorbitant considering the many additional hours of stable operation gained by their use.

vapor into the vacuum, and thus do not need cooling devices for keeping the mercury out of the apparatus; however, they are more sensitive to reactive gases. Considering that in most cases the chemist working with high vacuum also uses Dry Ice or liquid nitrogen at the same time, he will derive no special advantage from oil diffusion pumps (even though those deliver a vacuum of less than 10^{-5} mm. without cooling). Thus, most chemical laboratories use Hg pumps exclusively, except for special purposes. Since pump throughputs are usually rather modest, except for work involving vacuum furnaces, electric discharges, or molecular or thin film distillation, the usual pumps made of glass or steel, with a suction capacity of 1-5 liters/second, are perfectly satisfactory. Glass pumps are best heated with electric heaters, and a safety pan should be set underneath. Steel pumps of course obviate the danger of breakage. However, cleaning of steel pumps is not as simple as that of glass pumps, which require only rinsing with concentrated HNO_3 , followed by rinsing with water.

The most frequent mistake made in planning vacuum equipment consists in choosing tubing or stopcocks of too small diameter. The connecting tube between the pump and the apparatus should have an internal diameter of at least 15-20 mm.; stopcocks used on this line must have at least a 10-mm. bore. A simple calculation of the pumping capacity will show that even with lines of such diameter, a conduit length of a foot or so will reduce this capacity, at pressures below 10^{-2} mm., by an order of magnitude or more! Therefore, the lines in vacuum equipment should be as short as possible, with the least possible number of stopcocks. The use of glass spirals, frequently recommended to make glass apparatus less rigid and more able to accommodate stresses, should be avoided as far as possible, since these spirals offer a high resistance to flow. To protect the pump in case of cooling water failure, a small, easily made device is used (Fig. 22). A small funnel with a small hole is pivoted and counterweighted. The cooling water passes through the funnel, keeping it constantly filled. Should the water flow fail, the funnel will be pulled up by the counterweight as soon as it is empty, thereby closing the stopcock on the suction side of the pump (this may be either a pinchcock or an ordinary gas stopcock). Alternatively, the lever movement may actuate an electric tumbler switch which then breaks the circuit. Other devices based, for example, on a mercury manometer, may of course be easily designed. Electric flow switches to guard against interruption of cooling water are also commercially available.

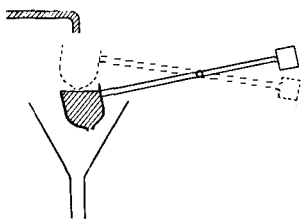

Fig. 22. Cooling water failure switch.

Should the water flow fail, the funnel will be pulled up by the counterweight as soon as it is empty, thereby closing the stopcock on the suction side of the pump (this may be either a pinchcock or an ordinary gas stopcock). Alternatively, the lever movement may actuate an electric tumbler switch which then breaks the circuit. Other devices based, for example, on a mercury manometer, may of course be easily designed. Electric flow switches to guard against interruption of cooling water are also commercially available.

PRESSURE MEASUREMENT

The first device is the ordinary U-tube manometer. Its two arms should be of equal diameter (not less than 10 mm.; for precision measurements, about 15-20 mm.) because of the meniscus depression. The calibration should preferably be etched directly on the tube and readings taken against a mirror mounted behind the tube so as to avoid parallax. In this way changes of 0.1 mm. may be estimated without difficulty. A cathetometer must be used for greater accuracy.

The construction of a good Hg manometer requires some care. The tube is first thoroughly washed with cleaning solution and distilled water and dried as described above under Cleaning of Glassware; then the filling unit is fused on (Fig. 23). The required quantity of carefully purified and distilled Hg is placed in the flask and constriction *a* is sealed off. The manometer is then evacuated with fore and diffusion pumps and the whole apparatus thoroughly heated by fanning with a flame, with the pump on. Following this, the mercury is heated until it starts to boil in the vacuum, and constriction *b* is fused. The assembly is then allowed to cool. The mercury should not be allowed to distill into the tube while the latter is being heated and evacuated, as otherwise it will obstruct the U-tube and an air bubble will be left behind. The manometer is then tilted to pour the Hg into the tube, and the fused spot at *b* is carefully filed open. Never break it off, for the onrushing air stream will push the Hg so violently that the shock will break the manometer. Even narrowing the diameter at *c*, which is very useful, would not be able to prevent breakage if such a violent impact of the mercury against the glass were to occur. This is the simplest and most reliable method of filling a manometer; it is preferable to the often recommended distillation of mercury into the tube, which does not always guarantee perfect filling. Filling with subsequent degassing, which is often done, requires considerable experience and patience and is unreliable; it also frequently cracks the manometer tubes.

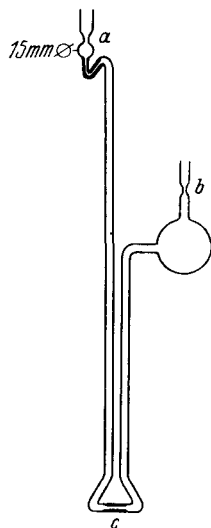

Fig. 23. Mercury manometer with filling device.

When working with gases at varying pressures (high vacuum to slightly above atmospheric pressure), a manometer of the type shown in Fig. 24 should be used. One side of this manometer is connected to the atmosphere via a mercury spray trap which

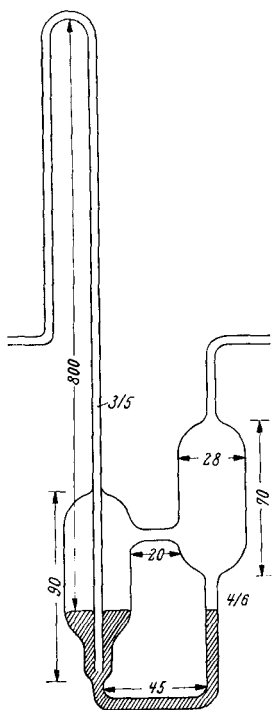

Fig. 24. Mercury manometer with pressure release valve. Dimensions in mm.

serves as a gas outlet and pressure release valve when the pressure in the apparatus is too high.

A very convenient addition is a barometer tube of the same diameter, mounted next to the manometer; its reading then furnishes the zero mark for the manometer reading (see p. 67, Fig. 41).

When working with reactive gases which can contaminate the Hg, it is best to use a "null manometer" rather than cover the Hg with a layer of paraffin oil, H_2SO_4 , etc., as has frequently been recommended. Such null manometers consist of a simple U tube filled with paraffin oil, H_2SO_4 , silicone oil or bromonaphthalene, both arms of which are connected on top by means of a stopcock (Fig. 25). For high temperatures, these U tubes can be filled with molten tin. The quartz spiral manometers of the Bodenstein type (Fig. 26) are highly recommended, for in their case only quartz is in contact with the gases. They are now commercially available completely assembled with microscope or mirror for reading and require only careful mounting in a vibration-free location. With good Bodenstein instruments, pressure differences of less than 0.1 mm. may be read. For shipping, such instruments are usually filled with glycerol so as to protect the very sensitive spiral from damage. Despite their fragility, most of these instruments will withstand even a one-atmosphere pressure difference between the inside and the outside of the spiral. Thus, there is usually no need to worry, should such differences occur as the result of a leak. Bodenstein gauges can safely tolerate temperatures up to $500^\circ C$ without a change of the zero point; if the temperature of the spiral goes higher, the constancy of the zero point is not assured, particularly if large pressure changes accompany the temperature rise. If large pressure changes are avoided, the zero point will remain almost unchanged, even at $700^\circ C$. To measure small pressure differences, inclined tube manometers filled with bromonaphthalene or silicone oil may also be used; Hg develops too much friction in inclined tube gauges, since very fine tubes must be used.

For shipping, such instruments are usually filled with glycerol so as to protect the very sensitive spiral from damage. Despite their fragility, most of these instruments will withstand even a one-atmosphere pressure difference between the inside and the outside of the spiral. Thus, there is usually no need to worry, should such differences occur as the result of a leak. Bodenstein gauges can safely tolerate temperatures up to $500^\circ C$ without a change of the zero point; if the temperature of the spiral goes higher, the constancy of the zero point is not assured, particularly if large pressure changes accompany the temperature rise. If large pressure changes are avoided, the zero point will remain almost unchanged, even at $700^\circ C$. To measure small pressure differences, inclined tube manometers filled with bromonaphthalene or silicone oil may also be used; Hg develops too much friction in inclined tube gauges, since very fine tubes must be used.

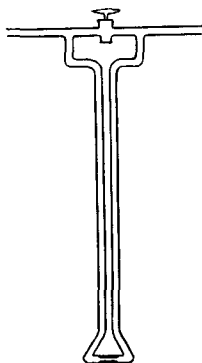

Fig. 25. Null manometer.

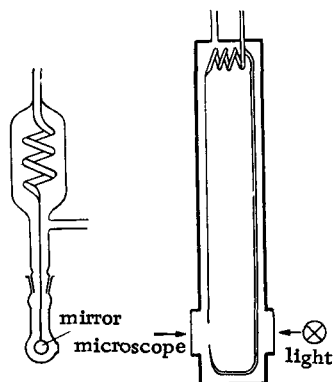

Fig. 26. Quartz-spiral manometer, Bodenstein type.

Figure 27 shows how to couple a null manometer to the system. In this case, a Bodenstein manometer connection is shown.

LOW PRESSURE MEASUREMENT

The pressure gauge designed by McLeod, usually called simply "the McLeod," has been in use for a long time for measurement of pressures down to 10^{-7} mm.; however, it registers pressures reliably only in the case of noncondensable gases. The Hg used in the gauge should be carefully purified and dried (heating in vacuum). The McLeod gauge is rarely used for preparatory work in its original form. Should the need for such a manometer

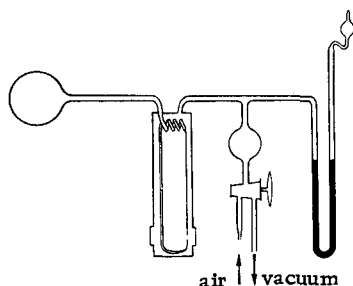

Fig. 27. Connection of a null manometer (Bodenstein manometer).

arise, the reader may refer to the pertinent literature (Kohlrausch, Grubitsch, Lux [1]). If measurement only serves for orientation purposes, the more convenient "Moser manometer" (Fig. 28 a, b)

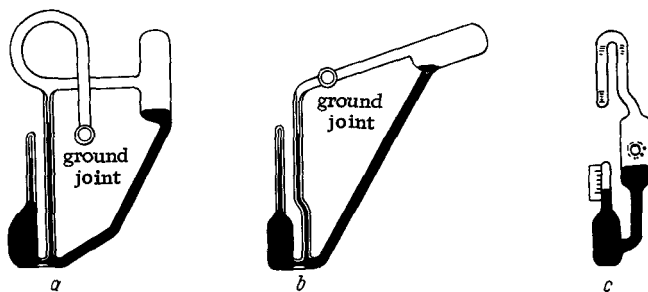

Fig. 28. Shortened McLeod gauges.

or a "Vakuscope" (Fig. 28 c) is preferred. Both of these versions of the McLeod gauge are commercially available. As far as other types of manometers are concerned, e.g., instruments based on gas friction, ionization, thermal conductivity,* etc., the reader should refer to the pertinent literature. These instruments are rarely important in preparative work. For rapid orientation as to the order of magnitude of vacuum in an apparatus, one can use a small discharge tube with two aluminum electrodes placed about 10 cm. from each other. (Alternatively, two aluminum foil pieces wrapped at the same distance around a glass tube in the apparatus may be used.) A high-frequency vacuum leak tester (or a spark coil) is connected to the electrodes; its discharge gives a green fluorescence at 0.05 mm., which disappears completely at <0.01 mm. Thermoelectric vacuum gauges (range 10^1 to 10^{-3} mm.) are also useful for many chemical purposes.

LEAKS

Hunting for leaks in vacuum equipment may sometimes prove extremely time consuming. Leaks are usually caused by careless cementing, poorly lubricated stopcocks or ground joints, or poorly fused glass connections. A small high-frequency apparatus is indispensable for detecting such spots in glass equipment. The equipment is evacuated to about 0.1-1 mm. and the suspected leak

*E. von Angerer, Technische Kunstgriffe bei physikalischen Untersuchungen [Industrial Techniques Applied to Physical Research], p. 165.

points are brushed with the leak tester electrode. The inside of the equipment will glow slightly. Wherever there is a leak, the discharge spark will follow it. The leak is thus easily discovered by the brightly glowing path of the current. However, thin fused spots should not be touched, since these may be broken by the discharge. Leaks in the glass must be resealed with a torch, or else sealed with a drop of sealing wax or picein. Leaks at the stopcocks are harder to find; thus all suspected stopcocks may have to be regreased as a preventive measure. If possible, one should try to limit the area of search by successive shutting of the stopcocks, if those are present between sections of the equipment. Larger leaks are easily detected by the noise made by the entering air, or by creating a positive pressure in the apparatus and painting the suspected spots with soap solution. Another recommended procedure consists in passing a CO_2 -releasing hose over the evacuated equipment while the latter is brushed with the high-frequency tester. The color of the discharge will change from reddish to white at the leak. Rubbing the equipment with a piece of cotton wool dipped in alcohol will also change the color of the discharge wherever the alcohol has directly touched a leaky spot and the vapor has thus entered the apparatus. This method will give results only if one makes sure that the CO_2 or the alcohol vapor which might have entered will come in the path of the discharge; therefore one should wait for a while before continuing with the testing of further suspected spots. Cemented metal-to-glass joints frequently are leak sites, as are pores in cast metal parts. Occasionally, substances that release gases may simulate a leak.

Excellent but expensive devices for locating leaks are commercially available; they blow a halogen-containing gas (for example Freon or difluorodichloromethane) from the outside onto the suspect spot; when this gas enters the evacuated apparatus through the leak, it creates an ionic current in an attached ionization tube equipped with a Pt anode. This signal is amplified and triggers optical or acoustical devices.

STOPCOCKS

An important factor in the choice of stopcocks is a sufficiently large sealing surface. In vacuum equipment, three-way stopcocks are a constant source of trouble and should be replaced either with two-way stopcocks or three individual ones. Stopcocks with hollow plugs are usually preferred to those with solid ones because they are lighter. The most important types of stopcocks are shown in Fig. 29. "Schiff" stopcocks (Fig. 29 a, b) should be used wherever possible; they stay more reliably leakproof, since no channels connecting the tubes can form.

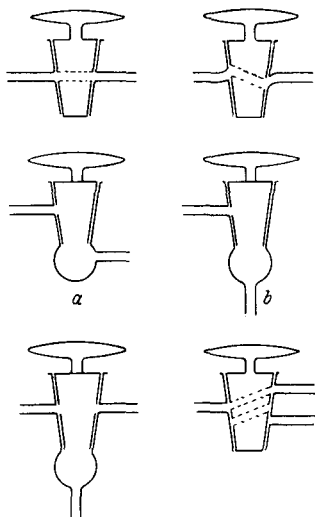

Fig. 29. Various stopcocks (a, b are Schiff type).

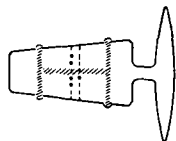

Fig. 30. Lubrication of stopcocks.

Before greasing, the stopcocks are carefully cleaned with benzene or ether and brought to body temperature (30–40°C); a thin ring of grease is then applied around the middle of the upper and the lower halves of the plug by means of a wooden rod. In somewhat larger stopcocks both rings are then connected with a thin strip of grease on a line 90° from the bore (Fig. 30). The plug is then pushed into the slightly warmed seat so that the stopcock is “open,” and turned back and forth with slight pressure. Never turn so far as to close it. Only when the grease has been evenly spread and the air bubbles have disappeared from the ground surfaces should the plug be turned all the way around. This is the only way to obtain lubrication free from streaks. Vacuum stopcocks should be moved gently and slowly, so as to keep the movement within the flow rate of the grease layer, and to prevent the “tearing” of the grease film; otherwise streaks and channels will form, resulting in unavoidable leaks. With some experience, imminent exceeding of this limit will be clearly felt by a somewhat increased resistance to turning. If streaks have formed, the stopcock should be carefully cleaned before applying fresh grease.

Pipe cleaners, which are thin, 10-cm.-long brushes obtainable from tobacconists, are very practical for cleaning small diameter stopcocks. A wad of cotton wrapped on a thin copper wire or a wooden stick may be substituted for the pipe cleaners.

When working with gases or vapors that attack stopcock grease, other greases (etherproof grease, P_2O_5 , H_2SO_4) may be used (but only temporarily in vacuum equipment, as the stopcocks rarely stay tight for a sufficiently long time). Sometimes this may be improved by sealing the upper and the lower part of the plug with grease, and applying the other sealing agent (P_2O_5) to the middle only. In general, it is best to use greaseless valves such as the diaphragm valves made of Cu, Ag or Pt, the Bodenstein glass valves, the Stock mercury valves and the “break-seal” valves.

STOCK MERCURY VALVES

Among the various Hg valves described by Stock the most important ones are the float and the frit valves: the float valves afford rapid passage of gases, but they function reliably only if made exactly to the measurements given by Stock. The float should be made of solid glass and have just one, very carefully machined, ring-shaped ground zone (Fig. 31 a). Opening the stopcock f will

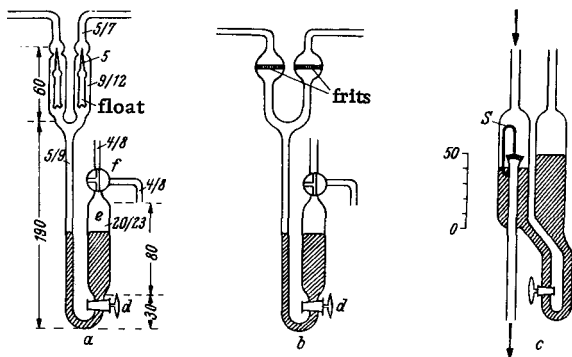

Fig. 31. Stock-type Hg valves. Stopcocks d may be omitted, to avoid contamination of the Hg by grease. In c , S is a fused-on glass rod, the point of which touches the glass frit from above and affords smoother downward flow of the Hg. Measurements in mm.

let the air into e , pushing up the Hg, which then lifts the floats. Evacuation of e will lower the level of Hg, thus releasing the floats, which will drop (if they stick, tap lightly against the glass) and open the way for the gas. The pressure difference between the two sides of the valve should preferably be low when opening. A tube attached to a vacuum source, and available at all times on the working table, is connected to the various valves when these have to be opened. The stopcock f is closed after each movement of the valve.

The frit valves may be opened even when there is a considerable pressure difference between the two sides of the valve. The frits, which are impermeable to Hg, thus replace the rising floats (Fig. 31 b). They have the disadvantage of offering considerable resistance to the gas flow. A modification of the frit valve, described by Wiberg (see also the original model with filter candle by A. Stock [1]), is also commercially available. Its functioning may be readily seen from Fig. 31 c. The gas should flow from the top to the bottom.

BODENSTEIN VALVES

These valves, which may be made either of glass or quartz and can be heated, certainly represent the neatest solution of the problem of greaseless valves, since only glass is in contact with the gases (Fig. 32). They consist of a capillary tube the opening of which matches perfectly with a carefully ground and polished sphere attached to a glass rod. A glass capsule, sealed to both the capillary and the rod, is sufficiently elastic to allow slight movement of the parts toward each other. A spring compresses both parts with a force of about 14 kg., thus closing the valve. The two working parts can be slightly pulled apart by a screw working against the spring; stop pins prevent breakage resulting from turning the screw too far. This valve may also be used to introduce liquids into a vacuum, provided no solid particles are suspended in the liquid. Even microscopically small particles pressed onto the ground surface are almost impossible to remove; they may also damage the ground surface (since the spring exerts a strong force) and thus create a leak in the valve. In this case even long rinsing with cleaning solution will be of no avail and the glass part must be replaced. Should the glass break, it can easily be replaced. Remove by melting the Wood's metal that holds the part in place; take the broken part out of the seat and replace with a new one in such a way that the glass rod with its fused-on

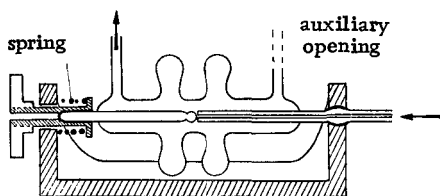

Fig. 32. Bodenstein valve.

glass bead is sealed in the screw and the enlargement on the capillary tube in the slot of the aluminum support. Immobilize both by slipping small pieces of asbestos paper into the remaining free space in the slot of the support. Then the whole unit is placed vertically with the screw down and freshly melted Wood's metal is poured into the preheated screw seat. After complete cooling (the screw should be at "open"), place the valve horizontally and pour Wood's metal into the slot containing the capillary feeder tube. Should the valve be used in a warm water bath, litharge-glycerol cement may be used instead of the Wood's metal.

A slightly modified, very rugged version of the Bodenstein valve has been developed by Kistiakowsky and described by Vaughn

[7]. The shutoff surfaces of this valve are not glass-on-glass but glass-on-AgCl, and the elastic sections of the glass capsule are concave rather than convex.

BREAK-SEAL VALVES

For preparatory work, the rather expensive Bodenstein valves may frequently be replaced by a combination of fusing of connections (closure) and break-seal valves (opening), if it is sufficient to open or close a connection only once.

Since one rarely succeeds in satisfactorily fusing large diameter glass tubes while these are under a vacuum, the tube spot to be fused later in the experiment should be slightly narrowed, thickening it at the same time by slightly compressing and then pulling it. This will make it possible to close the opening when the apparatus is under vacuum. To do this, the spot to be fused is simultaneously heated and pulled in the direction of the tube axis, or if this is impossible, it is pulled sideways with a glass rod.

Opening of a tube connection may be achieved by building in a break-seal valve (Figs. 33 and 34). This consists of a fairly large diameter glass tube with a fused-in smaller tube, whose tip has been pulled to a fine capillary bent into a hook. Alternatively, the inner tube end is blown out to a very thin-wall sphere. Before making such valves, one should practice making sufficiently thin-wall spheres or fine points, which can be reliably broken off later (however, it may be preferable to buy ready-made valves). Before enclosing the valve in the large tube, insert the "hammer,"

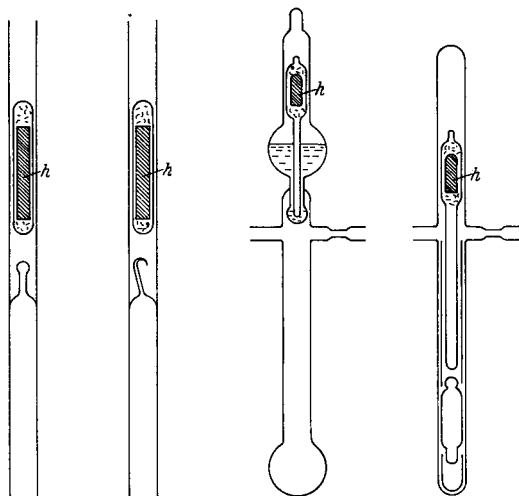

Fig. 33. Break-seal valves: *h*) magnetically operated hammer bar.

a piece of iron rod encased in a glass tube (for example, a piece of a large nail, fixed in the encasing tube with small pieces of asbestos wool before fusing). The valve is set vertically while the hammer bar is held by means of a strong electromagnet and set carefully on top of the break-off sphere or point. The valve is then ready to be fused to the tubes connecting with the other parts of the apparatus. When the valve is to be opened, the hammer is lifted a few centimeters with the electromagnet and dropped onto the point or the sphere, which will break, opening a path for the gas. The break-seal valve may also be set up horizontally, and the hammer appropriately directed by means of the magnet so as to shatter the point. In addition to this design, many other similar models have often been described, all based on shattering a capillary tube or sphere ([7], Figs. 35 and 36).

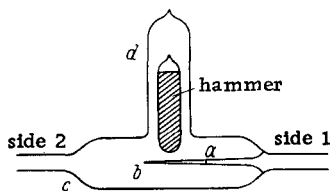

Fig. 34. Briscoe break-seal valve. The capillary point *b* is still open during sealing to side 1, but several scratches have been made at *a*. Then *b* is fused by means of a very small flame introduced through *c*, with air entering at *d*. Next the valve is sealed to the other side, the Hg-filled hammer bar is carefully introduced and *d* is sealed. A sharp movement applied from the outside will shatter the valve.

used as much as possible. The Bodenstein valve is also usable for fine control, although the adjustment is not exactly reproducible. A metal needle valve is the best means of control.

NEEDLE VALVES

If the presence of a packing gland is not objectionable, the usual Le Rossignol valve can be used for fine control. Packless metal

U-shaped capillary tubes may also be used to replace valves. Cooling with liquid nitrogen causes the formation of a small plug of frozen gas, which will obstruct the capillary. When low boiling substances, which do not solidify at liquid nitrogen temperatures, are used, a drop of Wood's metal is introduced; in this case a slight enlargement must be formed at both sides of the bend. Depending on whether the metal is made to solidify in the enlargement or in the capillary, the valve will be open or closed.

We can discuss here only a few of the numerous recommendations on how to introduce small quantities of gas into a vacuum, while retaining precise control over the flow. In many cases it is sufficient to file fine grooves in the plug of a glass stopcock, starting at the bore. In these cases, stopcocks with inclined bores (offset arms) should be

valves, in which a ground joint takes over the function of the gland and which can be attached to glass equipment by means of metal ground joints, can be readily made by a machine shop. Such a valve is shown in Fig. 37. The needle is attached to a screw stem *a*. A groove is cut in the stem in order to permit gas access. The top end of the valve stem is rectangular in cross section and fits into a slot in the ground section. The handle on the ground part permits rotation of the stem. If it is also desired to avoid stopcock grease for sealing, a tombac tube valve or a diaphragm valve, in which a tombac tube or a brass or copper diaphragm provides the seal, is well adapted for this service (Fig. 38). Further details on valves can be found in Mönch [2].

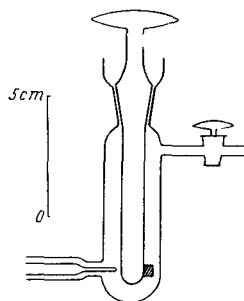

Fig. 35. Vacuum breaker, Stock type.

VACUUM APPARATUS

A vacuum apparatus consists of a pump section, vacuum-measuring devices, and a specialized part, the design of which depends on the problem at hand. A Toepler pump (Fig. 39) is installed in those cases when gases not condensed at the temperature of liquid nitrogen are to be removed from the system and measured or investigated. In that case, the pump section of the vacuum apparatus assembly takes the form shown in Fig. 40. It is useful to set up this section on a movable stand, and in such a fashion that the assembly is readily understandable. The gases aspirated by the Hg pump can be compressed into a gas burette, which is connected to the Toepler pump at *b*. Automatic Toepler pumps have also been devised by Stock. The level vessel on the Toepler pump permits the gases to be placed under positive pressure. A condensation trap installed before *a* prevents Hg vapor from reaching the apparatus and protects the pump from reactive gases or vapors. It is also advantageous to design the Toepler pump with an oblong cylindrical pump space instead of a spherical one, with the oblong section placed on a slant so that its shape and position is like the boiler of the Hg distillation apparatus in Fig. 5 [cf. E. Zintl and A. Harder, *Z. phys. Chem. (B)* 14, 265 (1931); also F. Seel, *Chem.-Ing.-Technik* 27, 542 (1955)].

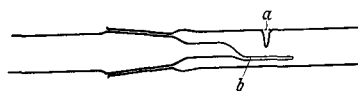

Fig. 36. Vacuum breaker, P. W. Schenk type: *a*) indentation in the tube wall; *b*) thin eccentric capillary tube which breaks on touching *a* when the ground joint is turned.

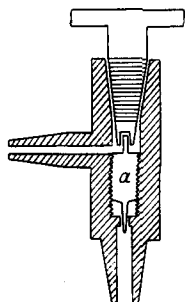

Fig. 37. Metal needle valve.

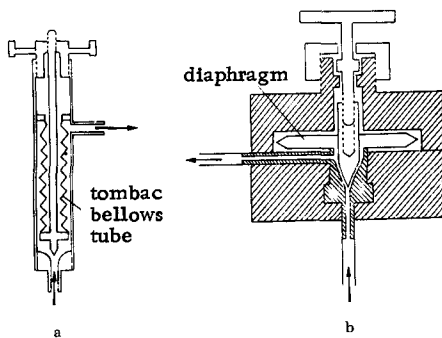

Fig. 38. a) Tombac tube valve; b) diaphragm valve.

Special Vacuum Systems

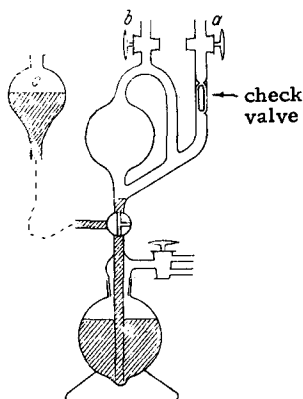

Fig. 39. Toepler pump.

Vacuum systems are used primarily for work with very volatile or with air- and moisture-sensitive materials. The apparatus developed by Stock for the investigation of boron and silicon hydrides is the prototype of a system which may be generally used when working with sensitive materials and, with modifications, also in many other related cases. Where greased stopcocks can be used, this system can naturally be simplified by installation of stopcocks instead of Hg valves. However, since stopcocks must be regreased from time to time, Stock valves are preferable. If

substances corrosive to Hg are present, Bodenstein valves or break-seal valves and sealing-off points may be used instead of mercury valves. Figure 41 shows the Stock "Universal System." Initially, the mixture of volatile substances to be studied is condensed in a gas trap by cooling the latter with liquid nitrogen. Such a trap consists of a U tube which is enlarged at the bend to form a cylindrical vessel with a capacity of 25-50 ml. (Fig. 43 b). Other condensation traps (Fig. 43 a-e) can also be used. The wash bottle type (Fig. 43 a, c, d) is especially recommended if it is connected properly; that is, the gases should not be brought in through the inner tube, which is usually very readily plugged. If the substance to be investigated is initially condensed in trap a (detail of the apparatus, Fig. 42), then the system is closed to the atmosphere and evacuated and finally the section between g and f is

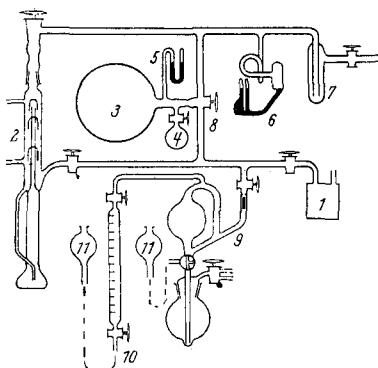

Fig. 40. Pump section containing a Toepler pump and gas burette. 1) forepump; 2) diffusion pump; 3) forevacuum flask (3-5 liters); 4) drying vessel (P_2O_5); 5) forevacuum manometer; 6) Moser manometer or McLeod gauge; 7) condensation trap for Hg; 8) two-way stopcock; 9) Toepler pump; 10) gas burette; 11) level vessel.

closed off. Then trap *a* is heated on a bath with slowly rising temperature until a vapor pressure of 30-50 mm. is registered at m_1 . The vapor pressure and temperature (vapor pressure thermometer) are noted, the valves *g* and *h* are opened while *r* is closed, and *l* is cooled with liquid nitrogen. Some material is allowed to

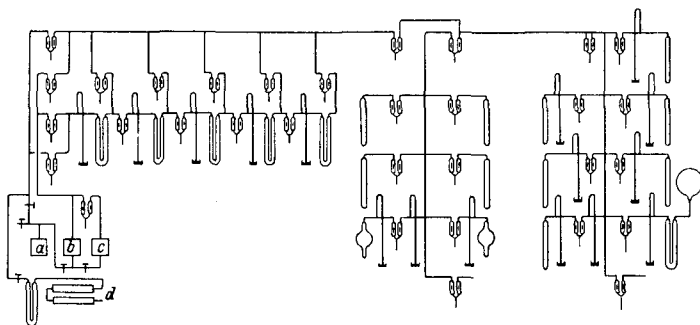

Fig. 41. Stock's Universal System. *a*) forevacuum pump; *b*) diffusion pump; *c*) forevacuum reservoir; *d*) drying agent.

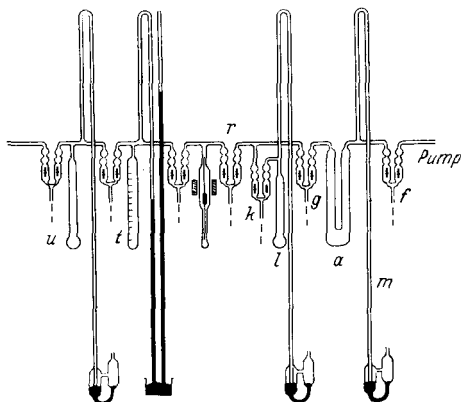

Fig. 42. Detail of the Stock Universal System.

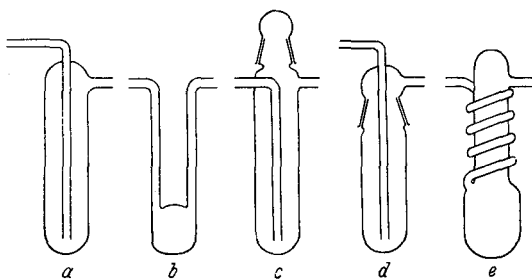

Fig. 43. Condensation traps (gas traps).

condense in l ; then k is closed, and the vapor pressure at m , is allowed to adjust at the same bath temperature. If the pressure is still the same as before, another portion is distilled into l . This is continued as long as the vapor pressure at a remains unchanged. When it decreases, one can distill into u and t . Thus the substance is split into different fractions, depending on the vapor pressure, without any loss of material. If an error has been made, all of the substance can be recondensed in the initial trap, again without loss, and fractionation started again. The collected fractions can be split further, those belonging together can be combined, etc. The constancy of vapor pressure at constant temperature from beginning to end of the distillation is the criterion of purity. In order to determine the vapor pressure, the distillation must, of course, be discontinuous and sufficient time allowed for complete temperature equalization. It may be mentioned that the vessels should be lightly tapped during distillation—Stock specified an electromagnetic

vibrator—and one should not distill too fast. Stock also described gas receivers (Fig. 44) for collection of materials which are gaseous at room temperature in order to avoid having to keep these continuously in liquid nitrogen. An ingenious withdrawal valve g permits removable storage vessels to be filled at various points of the system. This valve consists of two glass frits immersed in mercury. The gas can pass through only when their surfaces are pressed together.

Low-temperature distillation columns have been devised for improving fractionation. These greatly shorten the process and in very many cases are absolutely necessary for fractionation of mixtures of substances with very close boiling points. Clusius and Wolf [Z. Naturforsch. 2, 495 (1947)] have described such an apparatus, which is shown in Fig. 45. This micro-column is similar to those described by Clusius and Schanzer [Z. phys. Chem. (A) 192, 273 (1943)], but has a capacity of 6-10 ml.

Besides vapor pressure, melting point and molecular weight may be used for characterization of the fractions. Stock devised a very simple apparatus for determination of the melting point (Fig. 46). The thin glass rod with an iron core is first raised with an electromagnet, and enough substance is condensed in the lower half to fill it about halfway. It is thoroughly melted and solidified. Then the current to the magnet is shut off, leaving the point c of the glass rod resting on the surface of the solid substance. The rod is observed while the bulb k is slowly heated in a thermostatic bath. The temperature read at the point at which the tip of the rod begins to sink is the melting point. To render the movement of the rod readily visible, a red or black glass bead is fused at d . To determine the molecular weight, a preevacuated flask of known dimensions and weight is connected to the system via a stopcock and ground joints. It is filled at a measured gas pressure and weighed again after removal. The molecular weight is easily calculated from the pressure, volume and weight. The "Stock buoyancy weighing" method is more rapid. It is based on the buoyancy of a quartz bulb in the studied gas, the pressure of which is simultaneously and exactly measured. The buoyancy of the quartz bulb is compensated electromagnetically [cf. E. Lehrer and E. Kuss, Z. phys. Chem. 163, 73 (1933)].

While the Stock system, sometimes modified for special purposes, is the standard apparatus for manipulation of readily volatile

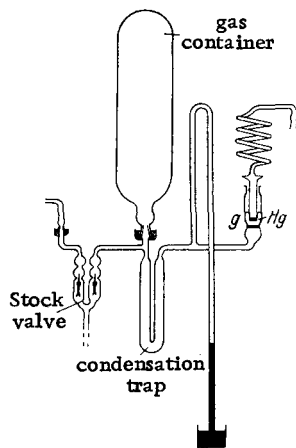

Fig. 44. Gas collection vessel.

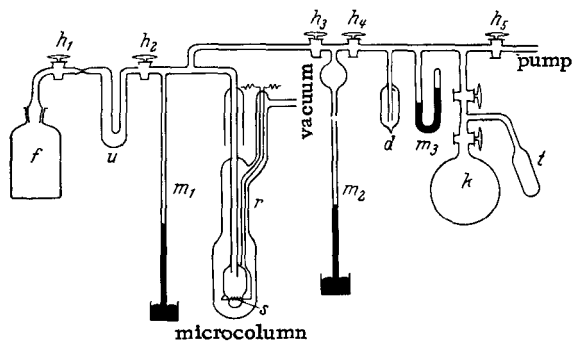

Fig. 45. Low-temperature fractionation system: h_1 - h_5) stopcocks (preferably vacuum stopcocks); m_1 - m_3) manometers; f) crude gas container; intermediate condensation in trap u ; r) microcolumn, capacity 6-10 ml., with a heating coil s of Pt-Ir wire, vacuum jacket and level limit for the cooling bath; r is shown enlarged in relation to the rest of the apparatus. The volume between h_3 and h_4 is known and serves for control of the withdrawal rate. The fractionated gas is frozen out in d and transferred to receiver k by cooling t to a low temperature.

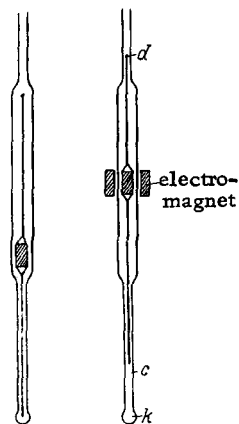

Fig. 46. Melting point apparatus.

substances, work with liquid or solid air-sensitive substances necessitates considerably closer attention to the specific problems at hand.

Moderate exclusion of atmospheric oxygen or moisture can be accomplished by working in a dry box or a dry bag, which are quite convenient. The dry box shown in Fig. 47 consists of a large gas-tight box with a well-closed opening for introduction of substances, tools and instruments. It is equipped with rubber gloved openings for the hands. Tube connections in the side walls allow the inner space to be filled or flushed with dry air or inert gas. An air lock can also be mounted on a side wall for introducing or removing the substances without disturbing the internal atmosphere. In order to observe the work, the box has a glass cover, or it can be completely built of clear, transparent plastic. These or similar boxes are sometimes commercially available; for example, they are also used for work with radioactive materials.

For many purposes one manages with the much simpler dry bags. A bag of thin elastic transparent plastic (e.g., polyethylene),

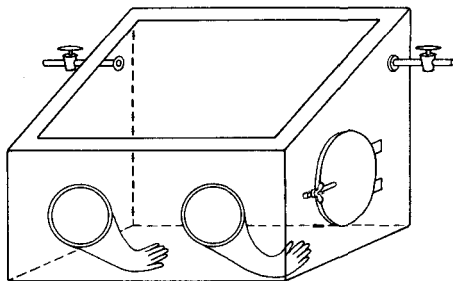

Fig. 47. Dry box.



Fig. 48. Dry bag.

open at one end, has a hole at the closed end. A glass tube with a stopcock is cemented into the hole and sealed in securely with rubber-stopper gaskets (Fig. 48). The materials and instruments, e.g., a weighing bottle, spatula, etc., are placed in the bag through the open end, which is then closed by folding over a narrow strip several times and clamping it between two wooden strips. The inside of the bag is evacuated through the glass tube and filled to a low pressure with protective gas. The items inside are manipulated from the outside; the tools and vessels are grasped through the soft walls of the bag [W. P. Pickhardt, L. W. Safranski, and J. Mitchell, *Analyt. Chem.* **30**, 1298 (1958); further references are also given there]. P. Ehrlich, H. J. Hein and H. Kühnl [*Chem. Ztg.* **81**, 329 (1957)] describe a similar apparatus in which the bag is mounted on a solid base plate.

For recrystallization of air-sensitive preparations and, in general, for production of pure preparations, an apparatus devised by Ulich (Fig. 49) is used more advantageously [H. Ulich, *Chem. Fabrik* **4**, 278 (1931); a similar apparatus but with standard ground joints is given by F.

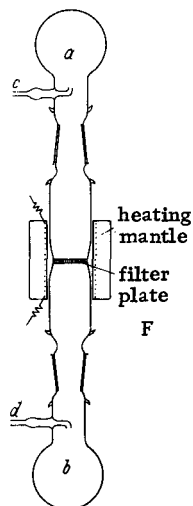

Fig. 49. Apparatus for dissolving and recrystallizing (the tube attachments *c* and *d* can also be located in the center sections).

Frierichs, Chem. Fabr. 4, 318 (1931)]. The apparatus, the construction of which is obvious from the figure, is filled with inert gas through tubes *c* and *d*, and flushed or evacuated, as neces-

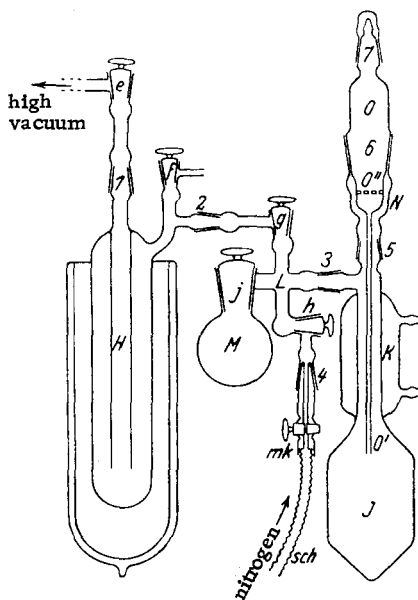

Fig. 50a. System for precipitation, purification and isolation in the absence of air: *H*) condensation trap of the vacuum system; *J*) reaction flask; *K*) condenser; *M*) flask with P_2O_5 ; *O*) filter tube with extension *O'* and glass frit *O''*; 1-7) ground joints; *e-j*) stopcocks; *mk*) metal stopcock on a tombac tube *sch*.

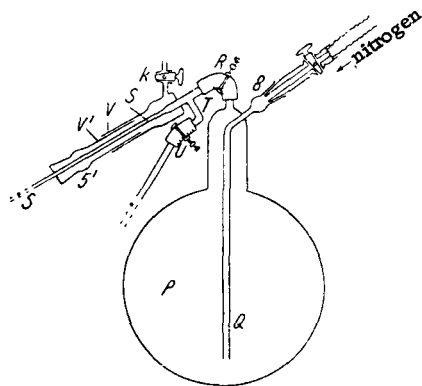

Fig. 50b. Water flask for precipitation and decantation: *G*) gas inlet tube; *S*) tube for connection with precipitation flask with ground joint *5'* and parallel ground joint *VV'*; *T*) drain tube for water; *R* and *U*) pressure tubes with pinchcocks.

sary. The substance to be purified is first dissolved in flask *b*. By inverting the apparatus, so that flask *a* is on the bottom, the undissolved material can be filtered off on frit *F*. The dissolving or filtration can be carried out either hot or cold. The middle section of the apparatus can be heated by solvent vapors from the heated flasks *a* (or *b*) or by a heating mantle, whichever is handier. The pure crystals are separated in flask *a* by cooling or by evaporation and removal of the solvent. The crystals and mother liquor are then separated by again inverting the apparatus and filtering through the frit. Washing, filtering and vacuum drying (cold or hot)

of the crystals collected on the filter plate can be easily effected via tubes *c* and *d*. Finally, the flask can be emptied in a stream of inert gas.

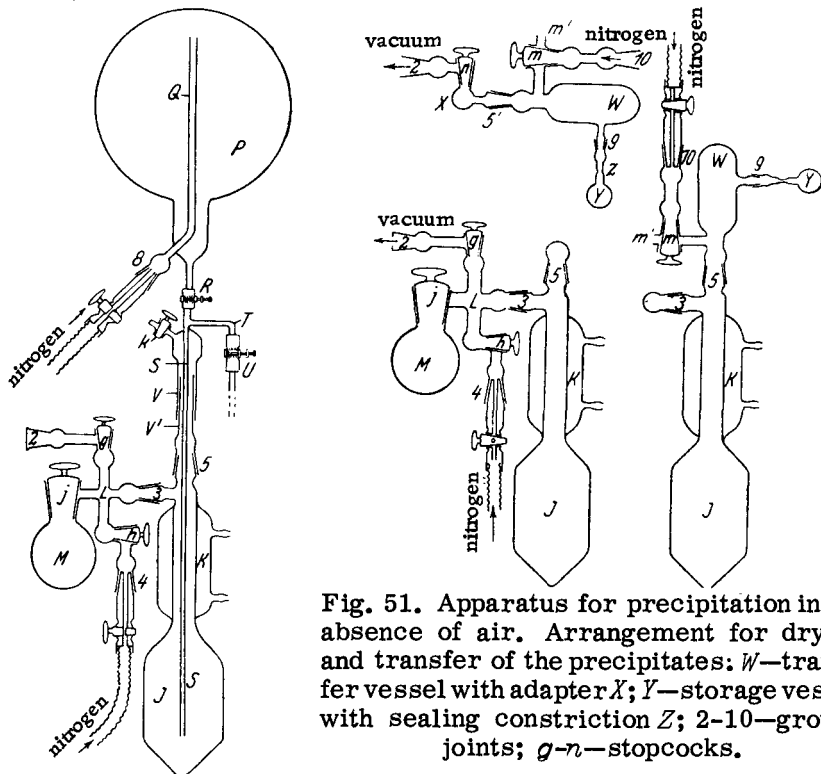

Fig. 51. Apparatus for precipitation in the absence of air. Arrangement for drying and transfer of the precipitates: *W*—transfer vessel with adapter *X*; *Y*—storage vessel with sealing constriction *Z*; 2-10—ground joints; *g-n*—stopcocks.

Fig. 50c. Apparatus for precipitation in the absence of air. A water flask for precipitation and washing is included.

A closed system for the precipitation, purification and isolation of highly sensitive substances [e.g., $\text{Fe}(\text{OH})_2$] from aqueous solution with complete exclusion of air was developed by Rihl and Fricke [Z. anorg. allg. Chem. **251**, 405 (1943)]. This system has proved itself in practice. The apparatus and use may be explained with reference to Figs. 50a, b, c and Fig. 51. First, looking at 55a, the system is filled with dry, O_2 -free N_2 through *m'k* (tombac tube with metal stopcock and metal joint). Now *h* and *j* are closed and the system is evacuated through *e*. Then *g* is closed, air is introduced through *f*, and *h* is removed from the apparatus at ground joint 2. Next, *J* is filled with N_2 through *m'k*, and cap 7 removed under a N_2 stream. Then vessel *J* is filled with the solution (which passes through the fritted glass filter to retain the solid particles). The filling port is at 7. Using N_2 pressure, the solution is forced

through the filter into J . In the meantime distilled H_2O is boiled in flask P (Fig. 50b) in a stream of N_2 . After closing R , the flask is inverted, and by brief openings of the pinchcocks at R and U , S and T are filled with pure, air-free water. Now the filtration sections N and O are removed and ground cap 5 is attached under a constant stream of N_2 . Thus, the apparatus reproduced in Fig. 50c is obtained. Since there is a steady stream of N_2 , no air can enter. Now water is permitted to enter J , thus precipitating the solution in the flask. This is permitted to settle; tube S is pushed close to the surface of the precipitate by moving the parallel joint V' and N_2 pressure is used to force the liquid outside the system via R and T . The precipitate is washed several times in a similar manner with water from P . Finally the large trap H is put back in place and the system is evacuated. The large trap is then cooled in liquid nitrogen or Dry Ice and the apparatus is left to stand overnight. This removes most of the water, which condenses in H . Next day the substance is usually quite dry. It is finally dried by opening the stopcock to flask M , filled with P_2O_5 . The apparatus is again filled with N_2 , and the supplementary section is added (Fig. 51, top). By inverting the apparatus, the powder is transferred to W . Nitrogen may be introduced at m , J removed, the vacuum stopcock X added, and Y filled after evacuation. Finally Y , containing the desired substance, can be separated from the system by sealing at constriction Z . I. and W. Noddack [Z. anorg. allg. Chem. 215, 134 (1933)] describe a similar apparatus. It is shown in Fig. 52. With it, material produced under N_2 and contained in filter crucible b may

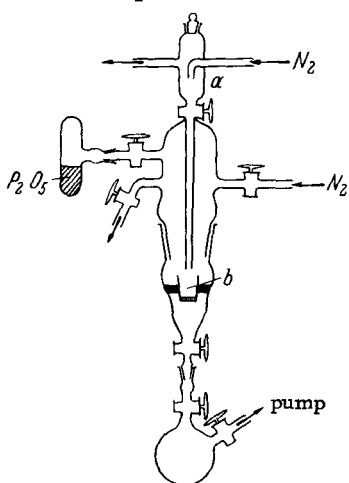

Fig. 52. Apparatus for filtration in the absence of air.

be washed with a solvent in an inert atmosphere and dried in vacuum. Wash liquid is added through a ; the system is later evacuated and the P_2O_5 vessel then connected.

An additional device—a dumbbell apparatus for precipitation and filtration in the absence of air—is found under the preparation of thiocyanogen in Part II, section on Carbon.

Numerous specialized types of apparatus have been described for carrying out reactions between solid and gaseous components or materials which are volatile at high temperature. In all these devices the reactions proceed in the absence of air. Many such reactions are carried out in apparatus which contains as its basic element a boat in a tube that can be evacuated or filled with

inert gas. Some operations can be carried out from outside the tube (heating, magnetization); others may require direct manipulation (introduction and removal of substance, crushing, etc.). This can be accomplished using long-handled tools manipulated through one opening in a stream of inert gas. Only one such opening should be present in the apparatus. Because of the positive pressure exerted by the gas stream, these reactions can be carried out inside the tube without danger of penetration by air.

For the numerous designs devised to meet these problems the reader is referred to the original literature [8].

Optical distortion of the interior by the curved glass walls can be troublesome; this can be alleviated by using flat glass ports which are cemented to short ground joints (Fig. 53), by which they are attached to the tube. The tubes shown in Fig. 54 can be generally used for storage and transfer of air-sensitive solids. The common principle on which these containers are based is that they can be evacuated and so opened that an inert gas flow protects the opening from air. Their design is based on the Schlenk tube, which was devised for such purposes.

The problem of pulverizing an air-sensitive substance produced in an inert atmosphere or in vacuum, in order to transfer it either to Mark capillaries for x-ray photographs or elsewhere for further reactions,

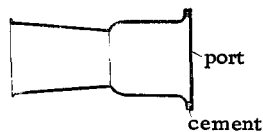

Fig. 53. Observation port for reaction tube.

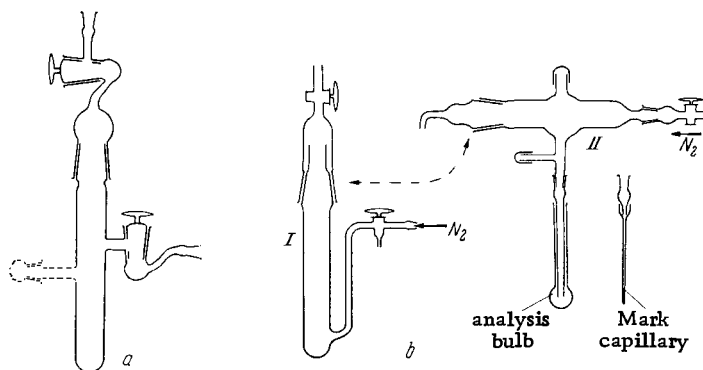

Fig. 54. Vessels for storage and filling of air-sensitive solids (Schlenk tube):

a—a model used in the laboratories of Darmstadt and Freiburg Universities; *b*—model of O. Schmitz-Dumont [Z. anorg. allg. Chem. 248, 196 (1941)]. Section I is for storage; Section II for transfer to glass containers or Mark capillaries.

was solved by Zintl and Morawietz with a vacuum ball mill. It consists of a hollow bulb (10 cm. in diameter, 4 mm. wall thickness) (Fig. 55) containing grinding balls (10-15 mm. diameter). At the left of S_2 the tube is constricted somewhat on one side so that it will not be closed off by a ball during removal of the milled material. The substance and the balls are introduced through S_1 while the mill is purged with an inert gas. Then the mill is evacuated and rotated in a suitable device. Naturally one can also mill in an inert atmosphere, but working in vacuum is recommended, since loosening of the joints is thus prevented and, in addition, the fine powder is not elutriated as much. The speed of rotation is 70-80 r.p.m.; the milling time, usually 1-2 hours [Z. anorg. allg. Chem. 236, 372 (1938) (in which an arrangement for filling Mark capillaries is also described)].

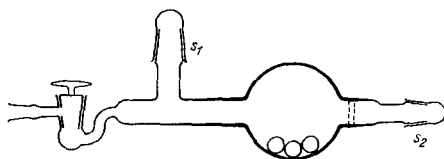

Fig. 55. Vacuum ball mill.

Pulverizing large, compact pieces of solid material or material solidified in a boat or crucible can be accomplished by use of a small dental grinding apparatus in an inert atmosphere. For these methods, developed chiefly for air-sensitive alloys, see Part III, 5, section on Alloys and Intermetallic Compounds.

"FARADAY SYSTEM" (TEMPERATURE GRADIENTS)

In some reactions between a slowly reacting metal and a volatile reagent, conducted in the absence of air, the metal must be heated as high as possible, but the pressure of the gaseous reactant must not reach a point at which it will burst the reaction vessel. For such experiments W. Biltz et al. have successfully introduced the "Faraday System" [E. F. Strotzer and W. Biltz, Z. anorg. allg. Chem. 238, 69 (1938)]. The apparatus consists simply of a sealed Vycor or quartz tube, with the metal and a supply of the other reactant (for example, S or P) at opposite ends of the tube. The "metal side" can then be heated to 700-1000°C, depending on the tube material, while the other half of the tube is held at 400-500°C, depending on the vapor pressure of the other reactant, until the reaction with the metal is completed to the desired extent. By subsequently lowering the temperature, the excess of the volatile component can be removed from the reaction product. By breaking the tube, if necessary

in an inert atmosphere, the reaction products can be removed. The extent of the reaction can then be determined by subsequent weight determinations.

Similar devices with sealed tubes, which are placed in a definite temperature gradient, have proved themselves in synthesis and decomposition of metal halides (cf. H. Schafer et al., *Z. anorg. allg. Chem.* 1952 and subsequently).

Gases

As is evident from the preceding, inert gases are frequently necessary for changing from vacuum to atmospheric pressure. Even though gas production and purification are described in a special section (Part II), a few general points will be discussed here. Inert gases, N_2 , CO_2 , H_2 , O_2 , Cl_2 , SO_2 , NH_3 , and many others are stored in steel cylinders. The valves of the steel cylinders are supplied with different threads: left hand threads for flammable gases, right hand threads for all others. Furthermore, the cylinder threads are not even always the same for all nonflammable gases. Thus, different valve designs may have to be used in each case. Usually, the cylinders are painted in code colors identifying particular gases. Confusion is minimized through these precautions.

Regulating valves are attached to the cylinder valves to provide flow control during delivery. One either uses simply a fine regulating valve, or a pressure reducing valve, whose spring-operated mechanism on the outlet side permits adjustment to a definite pressure, which is largely independent of the internal pressure in the cylinder. Such pressure-reducing valves are widely available. They sometimes are not able to assure a steady gas flow at the relatively low rates necessary in the laboratory. The flow itself is controlled by the needle valve at the outlet, after a pressure of about 0.5 atm. is established on the low-pressure side of the regulator, with the cylinder valve fully opened.

GAS GENERATING APPARATUS

The most widespread apparatus is still the Kipp generator. For production of air-free gas, e.g., CO_2 for driving gases into nitrometers, it can be provided with an attachment that keeps the upper chamber completely filled with the gas and prevents the penetration of air into the decomposition acid. The operation of this apparatus is shown in Fig. 56. Honisch's variant of the Kipp generator, which assures complete utilization of the acid and prevents mixing of the used with the fresh acid, is increasingly popular, although the somewhat complex stopcock construction is sometimes troublesome.

A gas generator equipped with standard ground glass joints, which permits complete utilization of the acid and easy replenishment, has recently been made commercially available.

All these devices have the disadvantage of not permitting efficient degassing of the substances used to generate the gas. The apparatus shown in Fig. 57 is a more effective producer of maximum purity gases. Using this apparatus, gases can be generated from a liquid and a solid, or from two liquids. A liquid is always placed in the upper bulb. The entire apparatus can be evacuated before opening stopcock *h* and, if necessary, the liquids can also be degassed by boiling. A modification of the apparatus which uses, instead of stopcock *h*, a ground-in stopper *s* operated by a glass rod, has been devised by Bodenstein (Fig. 58). If the stopper is grooved down to the midpoint and the seat has a vertical groove below the midpoint, the introduction of the liquid may be controlled simply by rotating the stopper instead of raising it. If degassing of the upper liquid by evacuation is desired, the glass rod of the stopper must obviously be sealed against the atmosphere by a rubber stopper.

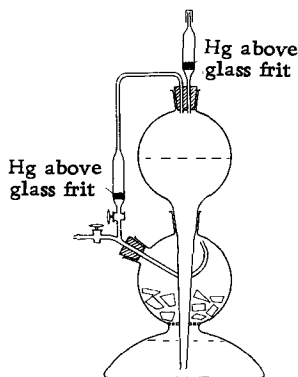

Fig. 56. Kipp generator for producing air-free gases.

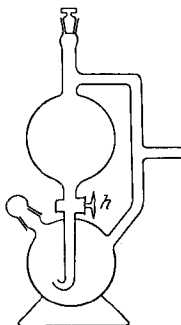

Fig. 57. Kipp generator for producing air-free gases.

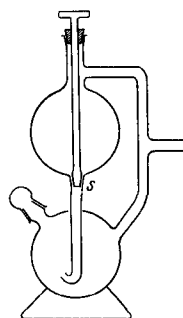

Fig. 58. Gas generator with Bodenstein dropping funnel. May be evacuated.

Special devices are used for the generation of a gas from two mixed liquids (see the preparation of HCl gas from concentrated hydrochloric acid and concentrated H₂SO₄, Part II, Fig. 143).

PURIFICATION OF GASES

The scrubbing action of an ordinary gas washing bottle is limited. In general, if the scrubbing liquid and the gas passed through it are to interact in a satisfactory manner, the flow rate

should not exceed 10 liters/hour. The flow rate can be roughly estimated from the frequency of the bubbles. With tube diameters of approximately 5-6 mm., one bubble per second corresponds approximately to a flow rate of one liter per hour in a simple wash bottle. A frequency of ten bubbles per second (i.e., that rate at which single bubbles can still be counted exactly with the naked eye) represents the upper limit for satisfactory interaction with the wash liquid. Wash bottles with fritted disks are considerably more efficient.

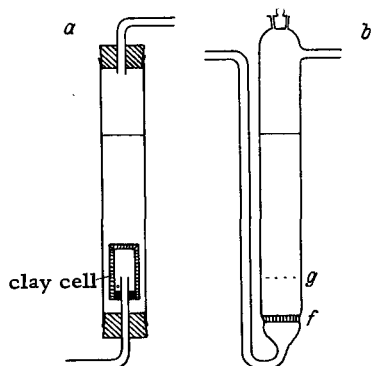

Fig. 59. Efficient gas washing tubes.

FRITTED-DISK WASH BOTTLES

The effectiveness of wash bottles can be greatly increased by good dispersion and subdivision of the bubbles. Such fine dispersion of gas bubbles is effected in fritted-disk wash bottles by means of a sintered glass disk through which the gas enters into the wash liquid. For especially efficient scrubbing, a fritted glass disk of medium or coarse porosity can also be inserted at the bottom of a long glass tube, which holds the wash liquid. The disk is held in place with a rubber stopper or by fusing to the tube. In a simpler device, such as shown in Fig. 59b, a plain fritted glass filter f is attached to a glass tube g of the same diameter.

Especially fine bubble dispersion can be attained with an unglazed clay cell used as a frit. The cell is attached to a glass tube with a rubber stopper, and the assembly is held at the bottom of a large-diameter glass tube by means of a second rubber stopper (Fig. 59a). The rubber stoppers are secured in place with wire or clamps. Finally, the scrubbing effect can also be increased by filling the wash vessel with glass fragments or glass beads.

For runs of longer duration, in which consumption of the wash liquid must be taken into account, a wash tower may be used. It is similar in design to that shown in Fig. 59b, but has a dropping

funnel on top instead of the stopper, and a stopcock for removal of spent wash liquid is fused on approximately at the level of g . It is then possible to add fresh wash liquid during the operation and to drain off a corresponding amount below.

DRYING OF GASES

Drying is carried out either with concentrated H_2SO_4 in wash bottles, or by passing the gases over a drying agent in drying tubes, or by cooling to low temperatures.

Table 15
Drying Agents for Gases

Drying agent	mg. H_2O /liter	Dew point, $^{\circ}C$	Remarks
$ZnCl_2$ $CaCl_2$	0.8 0.2	-33	Not to be used with NH_3 , amines, HF or alcohol.
$CaSO_4$	0.005	-63	Neutral. One of popular U. S. brands is Drierite.
CaO KOH	0.003 0.002	-67 -70	Not to be used with alkali-sensitive gases and those containing CO_2 .
Conc. H_2SO_4	0.003	-65	Not to be used with H_2S , NH_3 , HBr , C_2H_2 or HCN .
Silica gel	0.002	-70	Can be regenerated at $200-300^{\circ}C$.
Al_2O_3	0.0008	-75	Very effective.
$Mg(ClO_4)_2$	0.0005	-78	Caution when used with organic substances!
P_2O_5	0.00002	-96	Not to be used with NH_3 or hydrogen halides.

The drying agents listed before silica gel are virtually unusable in high vacuum.

The action of a drying agent is obviously limited. The degree of drying that can be attained with any drying agent depends to a great extent on the experimental conditions. The equilibrium state, i.e., the humidity corresponding to the partial pressure of water vapor in the drying agent, is practically never attained. For this reason, the data of different investigators on the degree of drying that can be attained with individual drying agents differ greatly. The values shown in Table 15 give a survey of the approximate effectiveness of the most commonly used drying agents.

In particular, the following drying agents should be mentioned:

CaCl_2 . The values in the table are valid only for the fresh, anhydrous salt. The drying efficiency can decrease greatly, especially at higher ambient temperature and on prolonged use.

Silica gel is available commercially as a blue gel containing a color indicator. With or without indicator, it is sold as gel pellets approximately 3 mm. in diameter. The indicator form offers many advantages. On exhaustion, a sudden color change from blue to light pink takes place. At the color change, the partial pressure of H_2O corresponds to approximately 1.5 mm.

It can be regenerated readily and as often as desired (drying oven at 200-250°C), but must be used with caution, since, like the even more active Al_2O_3 , it can also absorb large quantities of many gases other than H_2O , and this can be the unsuspected cause of many an unexplained experimental loss of material.

Phosphorus pentoxide generally contains traces of lower oxides of phosphorus, which can be troublesome, since they form PH_3 with H_2O . It can be tested by heating its solution with AgNO_3 or with HgCl_2 ; reduction occurs if lower oxides are present. More rigorous work requires P_2O_5 that has been sublimed in a current of O_2 before use, preferably directly into the drying tube. For more reliable oxidation of all impurities, the sublimation may be followed by short contact with a Pt catalyst. The drying tube is connected to an equally long and, if necessary, somewhat larger diameter glass tube. The connector is a small glass tube approximately 5 mm. in diameter and 6 cm. long. It is fused to the two larger tubes. The drying tube is filled very loosely with glass wool and dried at a high temperature in a stream of dry air (a CaCl_2 tube is sufficient). Some Pt foil is now placed in the empty tube and, following that, sufficient P_2O_5 is introduced in such a way that a free channel for gas passage is available over the entire length of the tube. A slow stream of O_2 is now passed through. The tube with the glass wool is heated somewhat and then the area of the Pt catalyst is heated almost to the softening point of the glass. By heating to 200-300°C, the P_2O_5 slowly sublimates and passes over the catalyst. The heating should start at the Pt foil and proceed gradually to the other end. The P_2O_5 is uniformly distributed in the heated tube containing the glass wool (Fig. 60).

Smaller drying tubes are also filled with glass beads or small pieces of glass tubing. Figure 61 shows a usable form which, because of the vertical position of the ground joints, can be readily interchanged. Loose magnesium perchlorate (without a carrier) as well as silicagel can be readily poured in, since these materials do not plug the tubes as readily as P_2O_5 .

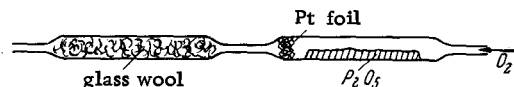

Fig. 60. Purification of phosphorus pentoxide by sublimation.

The neatest and most efficient solution of the problem of the drying of gases is cooling to low temperatures. In this procedure the gas is passed through a spiral condenser immersed in liquid nitrogen or in a Dry Ice-acetone mixture.

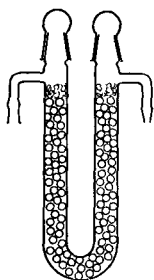

Fig. 61. Phosphorus pentoxide tube.

NOBLE GASES

While discussing purification operations, we should consider the purification of noble gases more specifically, since these are not treated in Part II. Of these gases, argon is an unexcelled protective gas for highly sensitive substances. Helium and neon are equally effective and are also used occasionally. These gases are stored in steel cylinders and can be freed of the usual impurities (H_2O , O_2 , CO_2) by the methods customarily used for other gases (e.g., N_2). A simple and very effective method for the removal of moisture and O_2 from inert gases and from N_2 or H_2 is given by Harrison [9]. In this method the gas is passed through a U tube (e.g., 40 cm. high, 2.5 cm. in diameter) partly filled with liquid Na-K (25% Na, 75% K).

In addition, the problem of the removal of small amounts of N_2 from the inert gases, particularly from Ar, requires special consideration here. The N_2 may be combined with metallic Ca, Mg, Ti or Zr; metallic U is also very useful.

Because of the low reaction rate, absorption on Ca, which is thus converted to Ca_3N_2 , must be carried out at 600-700°C, and requires an iron tube to hold the Ca turnings. The apparatus is shown in Fig. 62. The tube is approximately 70 cm. long and made of stainless steel. In addition, the Ca should be activated by a small amount of Ca_3N_2 to speed up the reaction (O. Ruff et al. [9]).

Similarly, Mg turnings can be activated with metallic Na; they quickly absorb N_2 at approximately $600^\circ C$. Several small pieces of Na are added to the Mg turnings before the first heating of the tube; the Na distributes itself automatically (Grube and Schlecht [9]).

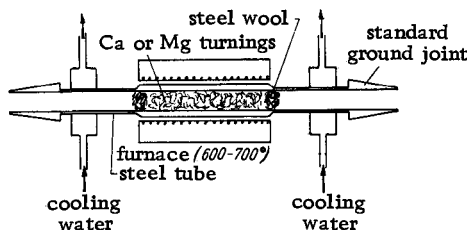

Fig. 62. Apparatus for absorbing nitrogen on metallic calcium or magnesium.

According to N. W. Mallet [9], N_2 can also be removed from inert gases by means of Ti, Zr or U. As shown in Fig. 63, a quartz tube, approximately 2.5 cm. in diameter and approximately 70 cm. long, is used. The Ar, predried over $Mg(ClO_4)_2$, is passed through it. The Ti powder is placed between two steel wool wads in a layer 25 cm. long, containing approximately 150 g. of metal. The particle size of the Ti powder should not be too low. The metal should be loosened up by pulverizing after use, the frequency of such treatment depending on how it is used. The sintered material should be regenerated and the entire tube packing should be treated after it has been in operation for a total of eight hours. Because of sintering, a working temperature above $850^\circ C$ is possible only if Ti is present in the form of coarse turnings. Before it is used, ordinary commercial Ti must be freed of its generally high H_2 content by heating in vacuum. When 30-40 ml. of N_2 (or O_2) per gram of Ti has been absorbed during a run, the absorptivity of the packing is greatly decreased and the material must be regenerated. A packing can be thoroughly exhausted, without any danger of N_2 breakthrough, if a similar second tube is installed after the first.

A more recent method for purification of inert gases, which can also be used for H_2 , consists in passing the gases through liquid

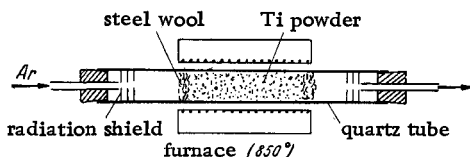

Fig. 63. Apparatus for absorption of nitrogen on titanium.

magnesium at 750°C. A steel apparatus is used, such as that shown in Fig. 64 (I. Jenkins and D. A. Robins, Third Plansee Seminar, Reutte 1958, and private communication).

FLOW RATE

Flow rate can be estimated through bubble counting. It is measured with a rotameter or a differential manometer. The rotameter is based on the displacement of a rotating float in a slightly tapered, calibrated tube. Both the tubes and the floats already properly calibrated, are commercially available.

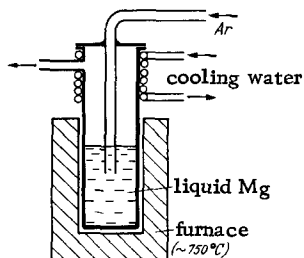

Fig. 64. Purification of inert gases with liquid magnesium.

In differential manometers, the two arms of a U tube are bridged by a calibrated capillary tube through which the gas flows (Fig. 65). Flow rate is proportional to the pressure difference between the two sides of the capillary.

For exact measurements, the temperature of the capillary should be constant. A glass stopcock is connected parallel to the capillary tube. Overflow of the manometer liquid can be prevented by opening the stopcock at the last minute; experience shows that attempts to prevent trouble by controlling the flow rate usually come too late. Addition of a filling tube to the manometer permits pouring in the liquid after installation and drying of the manometer. The lip is then sealed off. Suitable filling liquids include: concentrated H_2SO_4 , paraffin oil, silicone oil, bromonaphthalene, Hg or even stained water, depending on the purpose. By using inclined tube manometers, even very small flow rates can be measured quite well, employing only slightly constricted capillary tubes. Such devices are commercially available and can also be prepared in the laboratory.

The capillary tube shown in Fig. 65b can be readily interchanged. A calibration is required for each gas.

VOLUME MEASUREMENT

Calibrated gasometers or gas burettes are used. A constant-pressure gas burette was described by Schenk [Z. anorg. allg. Chem. 233, 393 (1937)]. Otherwise, wet test meters—commercially available in precision types—are used. They are especially useful in calibration of flow meters.

GAS RECEIVERS AND STORAGE VESSELS

Gases are stored in gasometers. The chief disadvantage of the simple gasometers is that, with the exception of bell-type devices,

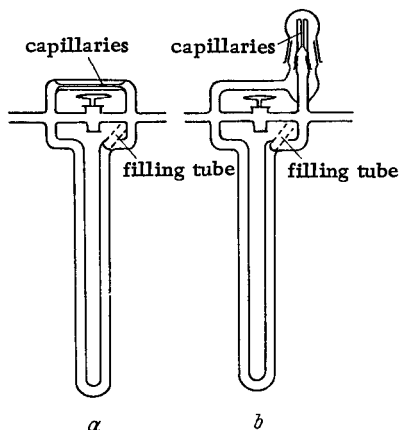

Fig. 65. Differential manometer.

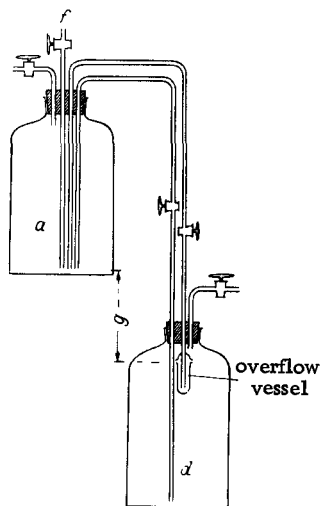

Fig. 66. Constant pressure gasometer.

they do not permit removal of the contents at a constant pressure. More recent models avoid this difficulty by having the feed line from the upper container connect to an overflow flask instead of reaching the bottom of the reservoir. Such gasometers can be easily improvised from large flat-bottom jars or even 60-liter flasks. The arrangement of the tubes can be seen in Fig. 66. Tube d , extending to the bottom of the bottle, serves for piping the sealing fluid back to a . This can be effected either by putting the lower container under positive pressure or by creating a vacuum in the upper one. An immersion tube f in the upper container makes this vessel a Mariotte flask. The gas pressure is determined by the difference in height g between the outlet of f and the overflow tube in the lower container. Such gasometers function very dependably. Once set, the flow rate remains completely constant for many hours. The one disadvantage is the necessity for large quantities of sealing liquid. The use of saturated, degassed common salt solution as sealing liquid reduces the danger of carry-over of impurities. For some purposes suitable paraffin oil may also be used. It must be heated and outgassed in vacuum prior to use. Bell gasometers in which the bell floats in a narrow, ring-shaped slot filled with Hg offer even better protection against impurities. Because of the considerable quantities of Hg, which they still require in spite of their special construction, they are limited in size. As can be seen in Fig. 67, a wooden shield serves to guide the bell.

When a rigid connection between gasometer and apparatus is desired, the gas can be removed via a glass tube fused at f (dashed lines, Fig. 67) instead of through h .

Storage is often simplified if the gas is forced into evacuated steel cylinders. A small pressure vessel, cooled with liquid nitrogen, is used for this purpose. The gas is liquefied in this container and then flows through a copper capillary into the evacuated steel cylinder (Fig. 68).

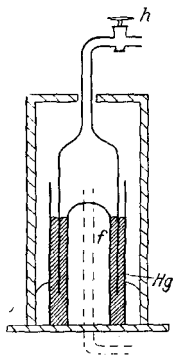

Fig. 67. Bell gasometer.

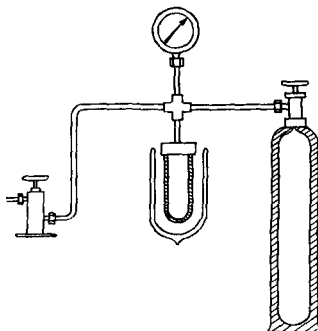

Fig. 68. Transfer of condensable gases into steel cylinders.

If it is desired to prepare a gas mixture in the steel cylinder (e.g., by filling it first with N_2 to 30 atm. and then adding H_2 until the pressure totals 120 atm., thus obtaining NH_3 synthesis gas) one should remember that gases under such high pressures have a considerable viscosity, which hinders complete mixing for days. Therefore, convective mixing should be induced through heating. This can be done by placing the cylinder in an inclined position, with the valve on the bottom, and heating it by irradiation with a 60-watt light bulb. Occasional analysis of the mixture serves as a useful check of the constancy of gas composition.

Liquefied Gases As Solvent Media

A great deal of equipment has been devised for work with liquefied gases, such as NH_3 , SO_2 , HF and others. This equipment permits carrying out such operations as precipitation, filtration, washing, drying, titration, etc., in complete absence of air and moisture. The operations proceed either in vacuum at the vapor pressure of the particular liquefied gas or in an inert atmosphere. The following brief description of equipment cannot make any claim to completeness.

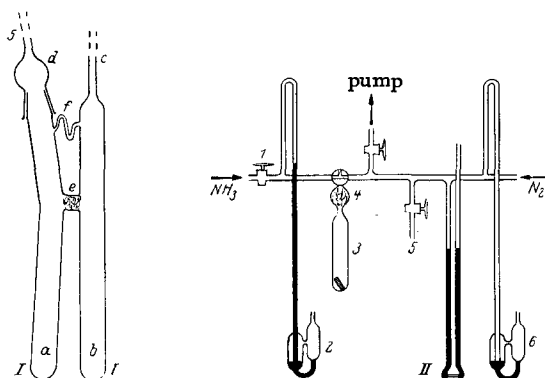

Fig. 69. Apparatus for reactions in liquid ammonia: I) reaction tube; II) condensation equipment; 2 and 6) pressure release valves; 3) condensation, drying and storage of NH_3 ; 4) protection against spray and fog—fritted glass or glass wool.

Zintl and Kohn [10] describe an apparatus for reaction of a salt with a solution of alkali metal in liquid NH_3 . This apparatus may be adapted to other similar uses (Fig. 69). The basic component is an H-shaped tube. Leg *b* contains the salt (this leg is later sealed off at *c*); leg *a* contains the alkali metal. A flexible connection (e.g., a tombac tube) to the other parts of the apparatus is provided at 5. After evacuation, the NH_3 is introduced through 1 and condensed in 3, which contains sodium for drying the NH_3 . From 3, the NH_3 is distilled into *a* and *b* and condensed there. Franklin and Kraus [10] showed that NH_3 distilled once over Na is completely clean and dry. When the Na in *a* has dissolved, the H tube is tipped and the solution is poured through *e* into *b*. The connecting tube *f* serves for pressure equalization. At the end of the reaction the NH_3 is evaporated, the apparatus evacuated, and *b* cooled in liquid nitrogen to loosen the substance from the walls. The apparatus is then filled with N_2 and cut open at *c*, and the substance is crushed with a stirring rod inserted through *c* while a stream of N_2 passes through. For washing, the substance is transferred in a stream of N_2 into a well-dried "washing tube" (Fig. 70) (A. Stock and B. Hoffman [10]), which contains a small inset tube surrounded by glass wool or small glass beads. After filling, the N_2 inlet tube is sealed off. The tube is evacuated, NH_3 is introduced and condensed, and then the top of the "washing tube" is sealed off. The tube is allowed to warm to room temperature and cooled on top with water or ice. The NH_3 refluxes condenses on top, flows down and extracts the substance on the glass wool. The extract

runs down through the wool while the fresh NH_3 distills upward through the small inset tube.

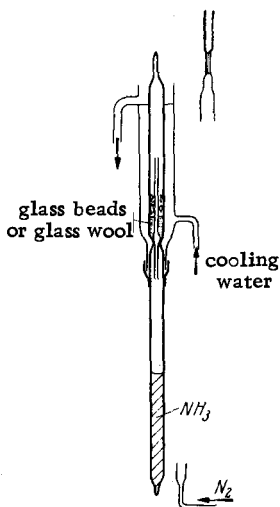

Fig. 70. Wash tube for extraction with liquid ammonia.

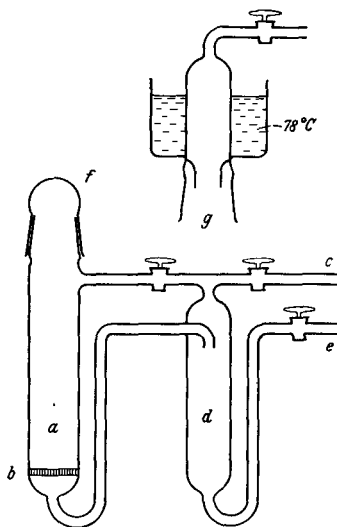

Fig. 71. Extraction with liquid ammonia.

To separate a mixture of solid substances with different solubilities in liquid NH_3 (or SO_2) by extraction, the apparatus pictured in Fig. 71 is used. It was devised by Biltz and Rahlfs and improved by G. Jander, Wendt and Hecht [10], as well as by Klement and Benek [10]. The solid starting material is placed in leg *a* on the fritted glass disk *b*. Purified NH_3 gas is then admitted through *c* and condensed in *a* by cooling. After the portion soluble in NH_3 has dissolved, the cooling bath is transferred to leg *d* and the NH_3 is forced by its own vapor pressure from *a* into *d*. The undissolved residue remains on filter *b* in *a*. Fresh NH_3 is condensed in *a* by cooling *a* instead of *d* and opening the connecting stopcock. By repeating the operation, the insoluble residue can be multiply extracted with NH_3 . The NH_3 can be either directly recycled to *a* or removed as a gas through *c*, condensed outside the apparatus, and recycled. By using the special head *g*, equipped with a cooling jacket holding Dry Ice-acetone mixture, instead of the ground glass cap *f*, the extraction can be carried out with NH_3 continuously trickling from *g* to *a*. The extract collects in *d* and can be removed through *e*.

No foreign gases are permitted in the free space of all such apparatus or the recondensation of NH_3 (or SO_2) will be appreciably hindered. Thus, the free space is evacuated from time to time,

while the liquid NH_3 (or SO_2) is held back by cooling one leg. The temperature should not be lowered to the point where the liquid freezes, because of the risk that the filter plate may shatter when rewetted.

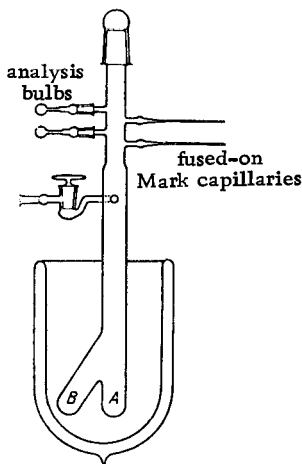

Fig. 72. Apparatus for reactions in liquid ammonia.

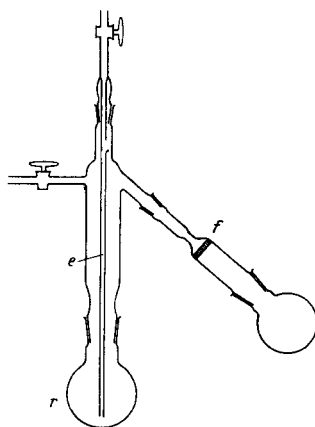

Fig. 73. Flask for reactions in liquefied gases: *e*—addition tube; *f*—fritted glass; *r*—reaction flask.

An apparatus for reaction of solutions of alkali metals in NH_3 with solid materials (G. Brauer and V. Stein [10]) is shown in Fig. 72. The alkali metal is sealed in a small ampoule which is provided with a small hook at one end. The seal point is broken off; the ampoule is suspended by the hook from a thin wire and introduced into the apparatus. The ampoule contents are melted in a stream of N_2 and flow to *B*. Then NH_3 is condensed in *B*. The solid is already in *A*, and both substances are combined by tipping the apparatus. After evaporation of the NH_3 the reaction product is transferred to analysis flasks, Mark capillaries, or to containers such as shown in Fig. 54a. From these it can be further transferred, as required.

The Jander and Schmid [10] apparatus shown in Fig. 73 has also proven useful in such reactions. The first condensation of NH_3 is greatly facilitated by the addition tube *e*; the frit *f* can be used for filtration in either direction. The greased ground joints remain gas tight even on immersion in a Dry Ice-methanol bath, so long as the pressure inside the apparatus does not fall below 50-100 mm. In a higher vacuum, fine channels form readily in the lubricant layer.

An apparatus for liquid—liquid NH_3 reactions yielding solid precipitates is described by Schwarz and Schenk and also by Schwarz and Jeanmaire [10].

A description of an apparatus for titrating liquid NH_3 solutions with standardized NH_3 solutions is given by Zintl, Goubeau and Dullenkopf [10]. Furthermore, similar devices for work with liquefied gases have been proposed by Juza, Schmitz-DuMont, F. Seel, G. W. Watt and others. A selection of the latest literature on the subject is given in [10]. The reader should also refer to the preparation of thiocyanogen in Part II, as well as to the section on Carbonyls and Nitrosyls in Part III.

Electrical Discharges

One distinguishes here between the so-called "silent" discharges at atmospheric pressure and glow discharges at reduced pressure. Other discharge types such as arcs are not considered here, since in those cases the specific discharge effects are masked by thermal ones.

Silent discharges are obtained in a Siemens ozonizer, which is a system of two concentric tubes. The gas flows through the annulus (see Part II, section on Oxygen and Ozone).

Glow discharges are produced at reduced pressure (< 10 mm.) between electrodes (Al, Fe) connected to a high-power, high-voltage source (about 6000 v., 100-200 ma.). "Electrodeless" discharges can be used when metal electrodes cannot. They are produced by inserting the discharge vessel (a sphere or short cylinder) into a coil made of a few windings of thick copper wire (primary winding of a Tesla coil) and using the latter as an oscillatory circuit connected to a high-frequency generator (quenched spark gap, emitter). Especially effective are direct current pulse discharges, which are produced by charging a high-capacitance condenser from a high-voltage transformer via a rectifier and high-resistance rheostat. After reaching the break through voltage, the condenser discharges across the spark gap and the discharge tube with an extremely intense current surge. For a short time (10^{-5} sec.), pulses of more than 100 amp. appear in the gap. Such apparatus is particularly suited for production of active nitrogen. A fuller description will be found in [11].

Aluminum foil is used for electrodes whenever possible. It is the least dust-forming material. In the case of halogens, water-cooled iron tubes (Schwab's apparatus [11]) must be used. The discharge tube is approximately 20 mm. I.D. and is enlarged at the end, where a 40-mm.-thick Al electrode is placed. If the electrodes are sufficiently close to the walls, the tube can carry a current of 200-300 ma. without special cooling. For higher currents a fan is

used for cooling. Two such discharge tubes are shown in Fig. 74. Good pumps are especially important when working with electrical discharges, particularly when one of the reagents is a gas that does not condense at the temperature of liquid nitrogen. For example, for a throughput of one mole of gas per hour at 1 mm. pressure, 17,000 liters of gas, i.e., 5 liters per second, must flow through the apparatus. Since in many cases one must work with still lower pressures (0.3–0.5 mm.), very high capacity pumps as well as tubes of at least 20 mm. I.D. are absolutely necessary.

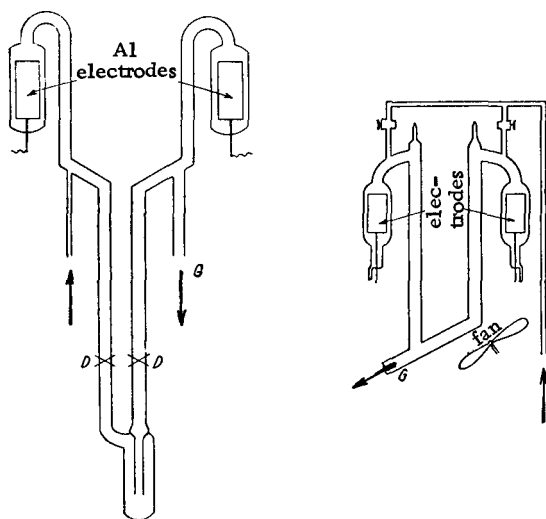

Fig. 74. Discharge tubes: *D*) sealing-off or cutting-off point (removal of reaction product frozen out in the trap); *G*) to the pump.

Purification of Substances

Purification is effected in most cases by distillation, sublimation or recrystallization. In many cases, the mechanical methods of elutriation and gravity separation are also useful. The progress of the purification is followed by checking either the analysis or the physical properties, especially melting point, boiling point and vapor pressure.

DISTILLATION

Distillation columns are used for greater separation or to accelerate the process. The disadvantage of a more or less considerable holdup, which formerly required large quantities of

substance in order to achieve effective fractionation, has been largely overcome by the development of modern columns. As a makeshift device, a 60-cm.-long column packed with metal or glass Raschig rings, and insulated by a glass jacket, can be used (Fig. 75). If the rate of distillation is adjusted so that for each drop collected at the top, two or three drops fall back into the boiler, then the separation is usually very good. Columns like Jantzen's or Podbielniak's are used when purity requirements are higher (Fig. 76). The principal component of the Jantzen column is a long, spiral

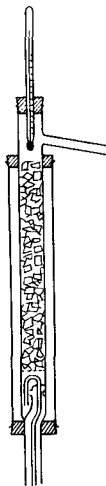

Fig. 75. Distillation column packed with Raschig rings.

riser tube, which is thermally insulated by a sealed-off, silvered, evacuated jacket. The ratio of distillate to reflux is controlled by the setting of the stopcock (cf., e.g., Bernhauer, *Einführung i.d. org. chem. Laboratoriumstechnik* [Introduction to Organic Chemistry Laboratory Technique], Vienna, 1944, p. 119). The Podbielniak column is used for fractionation of liquefied gases. Columns with a rotating metal core (also available as microcolumns) have very small holdups.

VACUUM DISTILLATION

The usual equipment for vacuum distillation is so familiar that it requires no special mention here. Although the main use of short-path, thin-layer distillation is in preparative organic work, this method is also useful in preparative inorganic work. In this type of distillation, the substance runs in a thin layer over a heater surface at extremely low pressure, and the more volatile components condense on a cooled wall directly above and a very short distance from the heater. A great many devices have been designed for this. One is presented in more detail in Part II, section on Sulfur, when dealing with the purification of polysulfanes.

SUBLIMATION

Besides the usual sublimation equipment (an example of the simplest type is a beaker covered with a water-filled flask) one should mention an apparatus for vacuum sublimation which can easily be assembled from a Pyrex evaporation vessel with a perforated cover. Figure 77 shows the construction.

Vacuum sublimation is used, above all, for purification of metals. Except for a high-capacity pump (most metals give off

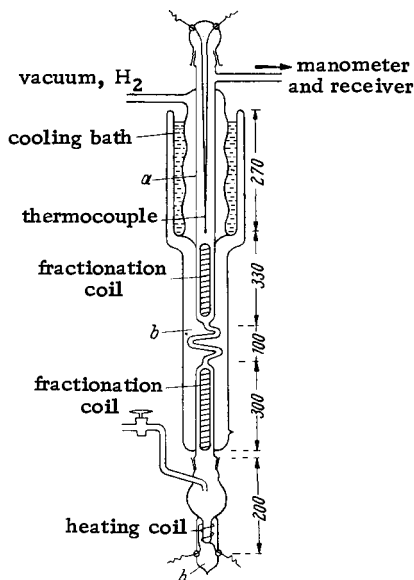

Fig. 76. Podbelniak distillation column: a) filled with hydrogen at various pressures; b) high vacuum; for the sake of clarity, the diameters of all parts of the apparatus have been enlarged three times in relation to the length.

considerable quantities of gas upon heating) the equipment required is relatively simple. All that is required is a large quartz, ceramic or suitable metal (e.g., steel) tube into which the metal to be sublimed is placed, either directly or in a boat, and a concentric cold finger cooled with running water, on which the sublimed metal deposits. The cold finger must be easily removable at the end of the sublimation. Figure 78 shows the principle of the setup. It may be modified somewhat, depending on the materials used [e.g., quartz in the apparatus of W. Klemm and H. U. von Vogel, *Z. anorg. allg. Chem.* **219**, 45 (1934)].

Less volatile metals can also be distilled, in smaller quantities, in a tungsten boat heated to a very high temperature. They deposit on an adjacent cooled surface. The layout corresponds

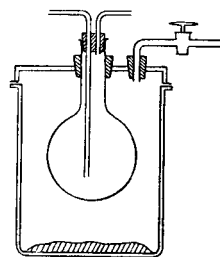

Fig. 77. Vacuum sublimation apparatus.

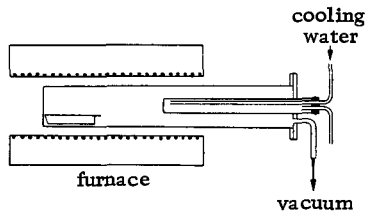

Fig. 78. Sublimation onto a cold finger.

very closely to the tubular tungsten furnace shown in Fig. 13. In this case, however, the heating element is an open boat, made by folding a sheet of tungsten, instead of the tube.

RECRYSTALLIZATION

Crystallization depends essentially on two factors; the crystallization rate and the number of centers of crystallization. With high supersaturation, the number of nucleation centers is large so that many small crystals are formed. With only slight supersaturation, the crystallization rate is controlling and only a few—and therefore larger—crystals are formed. Although the widely held notion that especially well-formed crystals are always highly pure is not valid (impurities can be occluded with the mother liquor), still, the production of large crystals for crystallographic purposes is so important that we shall discuss the subject briefly.

CRYSTAL GROWING

Larger single crystals can be obtained by recrystallization from the gas phase, from a solution, from a melt and in metals [12].

Growing from the gas phase (sublimation) is effected by enclosing the substance in an oblong glass or quartz ampoule and maintaining a temperature gradient along the ampoule for some time. The transport phenomena that occur during this process lead to crystallized deposits. The process is widely applicable and is sometimes very effective, even in reversible decomposition reactions with participation of a gas phase. It is, however, suitable only for small quantities.

Growing from a solution occurs through growth on already present crystallization centers or on crystal seeds. The following general rules are valid. The crystallization vessel should either be very well insulated to achieve extremely slow cooling and a supersaturated solution at a given temperature, or the vessel should be maintained at a constant temperature (Dewar flask, thermostatted bath with slowly decreasing temperature) while the solvent slowly

evaporates. Large crystals are obtained more easily in large diameter containers than in narrow ones. Crystallization centers on the bottom of the container disturb the growth of the crystal and should be avoided as much as possible, e.g., by polishing the surface. After each crystallization, the best crystals are selected for use as growth centers, and these are again inserted into a hot saturated solution. (However, the saturation should not be quite complete at the moment of insertion.) Some dissolution of the seed crystals in a new crystallization run is necessary for even growth. A single, well-shaped crystal can also be suspended in the solution on a thread or wire. Small crystals formed on the surface of the liquid should not be allowed to fall on the growing crystal; for this reason the latter is protected by a cover, made, for instance, of fibrous material.

Uniform growth is promoted to a large extent if either the crystal or solution is in continuous motion, since local concentration fluctuations are thus evened out. Freedom from vibration during cooling—previously considered important—is therefore not necessary in order to obtain large, well-formed crystals. Either the crystal is rotated in the still solution or the liquid is permitted to flow past the fixed crystal. For the first case, Johnson has devised a simple setup, which is shown in Fig. 79. A stream of air controls the evaporation rate of the solvent. There is a protective cover over the growing crystal. For the second case, that of moving liquid, the simplest setup is an inclined, round-bottom flask which rotates slowly about its axis in a thermostatted bath with gradually decreasing temperature. With more stringent requirements, the Nacken apparatus (shown in Fig. 80) is used. Constant change of the solution, which is always being saturated in the middle section of this apparatus, is achieved by means of the two check valves and a rubber bulb attached at a .

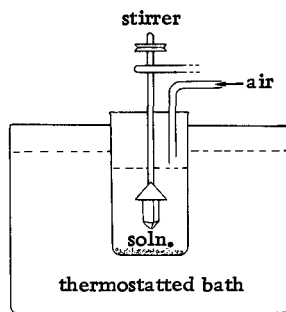

Fig. 79. Single crystal growing with movement of the growing crystal.

When crystals are grown from a melt, the simultaneous growth of a great many crystallization centers must be prevented. The growing crystal should always be the coldest part of the surroundings by being connected to a heat sink (a rod or a tube with good thermal conductivity).

An especially successful process for alkali halide crystals was devised by Kyropoulos [12]. The experimental arrangement can be seen in Fig. 81. The fused mass in the electrically heated crucible is heated to about 150° above the melting point, then cooled to about 70° above the melting point. The cooling rod is then

immersed. Only then is the cooling of the rod started. When a crystal forms at the tip of the rod, usually as a hemisphere, the rod is carefully lifted by a micrometer device so that it barely touches the surface of the fused mass. At this point there develops a large, very clean, round crystal, provided the cooling of the rod is adequate. Finally this crystal is lifted from the mass and very carefully cooled.

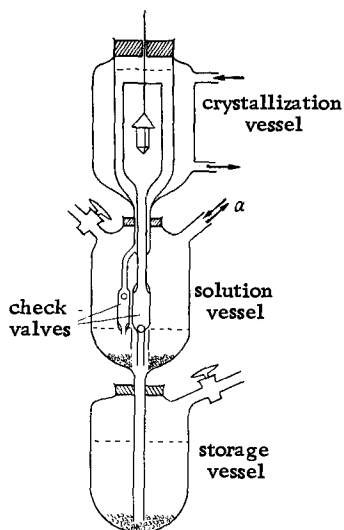

Fig. 80. Single crystal growth in a moving solution.

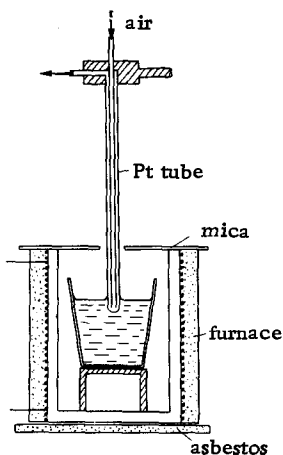

Fig. 81. Single crystal growth in a melt.

The growing of metal single crystals can be carried out via several methods. Tammann and Bridgman [12] have devised an apparatus for slow solidification of metallic melts. A tube filled with the melt is lowered slowly and at a uniform rate (e.g., by means of a clock mechanism) through a vertical, electrically heated tubular furnace. In order to force the crystallization process to occur at a fixed place and from only one crystallization center, the bottom of the tube is drawn out to a capillary point (Schubnikow; Straumanis [12]).

By pulling, a single crystal metal fiber is drawn out of the molten mass at a slow, uniform rate (e.g., 0.2 mm./sec.) while cooled and protected by a stream of inert gas (N_2 , CO_2). A small mica leaf with a hole in the middle, floating on the surface of the molten mass, serves as a die for the fiber and determines the thickness of the wire-shaped single crystal (Czochralsky; Von Gompertz; Mark, Polany and Schmid [12]).

Other special methods for growing metal single crystals are recrystallization with alternate mechanical deformation and annealing (systematically and successfully used till now with Al, Mg, and Fe) as well as a crystallization process in which a volatile metal compound decomposes thermally on a high-temperature filament and the metal deposits on it. This procedure may be used also for the preparation of some metals and very pure simple metal compounds. Some of these cannot be obtained as pure by any other method (Ti, Zr, Hf, Nb, Ta, etc.) (Koref; Van Arkel; Agte; Burgers; De Boer [12]).

Small crystals, required for powder pattern analyses, are often accidentally found in cavities of solidified melts. In some cases, this phenomenon can be artificially encouraged by inserting into the metal (or alloy) mass a honeycomb of folded strips of sheet iron, the nooks and crannies of which serve as cavities. In this case, the container must be moved to and fro during slow solidification, in contrast to other methods of crystal production (G. Brauer and R. Rudolph [12]).

Zone melting. In this method for metals and semimetals, developed by Pfann, a small heating device is passed along a rod-shaped sample of a solid, fusible substance in such a way that a narrow fused zone gradually moves along the whole length of the sample. Impurities are thus transported in one direction. Several such passes result in ultra high purity material. The method is usable for all substances (and compounds) with appropriate melting properties [13].

GRAVITY SEPARATION

Of the mechanical methods of separation, which can be used when chemical isolation of a product is either not possible or not practical, density separation requires some mention. A solid mixture of two components with different densities can be separated by means of a liquid of intermediate density. It is an essential prerequisite that the solid be pulverized until every particle is as homogeneous and free of inclusions as possible, but an unnecessarily fine powder should not be produced. Various "heavy liquids" and "heavy solutions" have been proposed as separation liquids, in which the lighter component rises and the heavier one sinks to the bottom. If somewhat elevated temperatures are permitted, then low-melting substances can be included in this group and the range of the usable density values widened a little more. Table 16 shows the substances used most often for gravity separations.

The following gravity separation procedures are of importance [14].

Dense liquids and solutions. In the simplest case, narrow, tall beakers or ordinary graduated cylinders are used; these are filled

with liquid and the solid is stirred in with a glass rod and left to separate. The light component can be decanted after settling or, better still, scooped out with a nickel wire sieve. Ordinary separatory funnels whose stopcock is mounted a few centimeters below the vessel are also recommended. The bore of the stopcock plug should be the same diameter as the funnel tube. For more thorough separations an apparatus such as shown in Fig. 82 I can be used. The mixture to be separated is poured into the large tube and liquid is allowed to run through the funnel until its level equals that of the upper side branch. By repeated stirring with a glass rod, the light components are elutriated toward the top. Then the main large opening is closed off with a cork and more liquid poured in through the funnel. This liquid sinks to the bottom, raises the lighter components to the top, and thus permits them to overflow. The operation should be repeated several times. For other recommended apparatus, see [17].

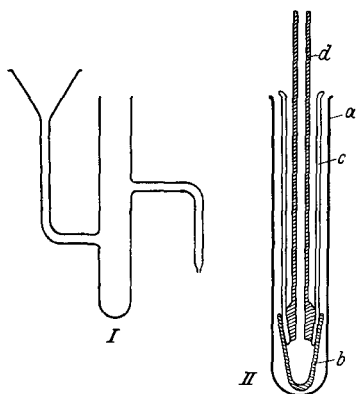

Fig. 82. Apparatus for gravity separation. I) after Brauer and Scheele; II) after Penfield.

Dense melts. The separation can be effected in a test tube, which after solidification can be broken and the cake split up into two parts containing the lighter and the heavier components. For more separation, Penfield's apparatus, shown in Fig. 82 II, is used. A small container *b* is placed in a Vycor or quartz test tube *a*. Vessel *b* is connected by a ground glass joint to an adapter *c*. The resulting tube (*b* plus *c*) is filled with a mixture of the powder to be separated and the substance serving as the melt. Then the entire vessel (*a*, *b* and *c*) is heated, e.g., in a water bath; the molten substances will rise fully into *c*. After separation has been accomplished, the closure tube *d*, provided with a male ground joint at the

bottom, is introduced to seal off *b*, as shown in Fig. 82 (II). The spatial separation of dense and light substances is so good that after solidification of the melt, *b* can be loosened without difficulty from *c* and *d* by brief heating.

Table 16a

Liquids for Gravity Separation. Dense Liquids [15]

Liquid	d_{\max}	Properties
Bromoform	2.9	Cheap, very mobile, transparent, inert to ores, slightly sensitive to light.
Iodoform solution in bromoform	2.9-4.0	Similar to bromoform, but strongly colored to the point of capacity. At high CHI_3 contents (m.p. 119°C) solid at room temperature.
Tetrabromoethylene	3.0	Similar to bromoform; more light-stable than bromoform. Evaporates relatively quickly.
Potassium iodomercurate solution (Thoulet solution)	3.2	Almost colorless, transparent, easily prepared. Poisonous! Attacks the skin! Hygroscopic, fairly viscous; decomposed by Fe and many oxides and sulfides, with Hg separation. Crystal powder removal difficult because of adsorption.
Methylene iodide	3.32	Pure material almost colorless; very mobile; easily washed with benzene; fairly inert when pure; sensitive to sunshine, heat and less noble metals (Al). Relatively expensive.
Cadmium borotungstate solution (saturated) (Klein solution)	3.36	Not poisonous, harmless; difficult to prepare; fairly viscous; decomposed by Fe, Zn, Pb and carbonates.
Barium iodomercurate solution (saturated) (Rohrbach solution)	3.59	Easily prepared; cannot be decomposed by carbonates; should be diluted with KI solution only.
Thallium formate solution (saturated)	3.17 (12°C) 4.76 (90°C)	Densest known aqueous solution; mobile; may be diluted with water. Light yellow when freshly prepared, becoming brown upon standing; the brown color can be removed with charcoal by heating the diluted solution. Somewhat difficult to prepare; marked changes in density with temperature and evaporation.
Thallium formate and malonate solution (1:1) (saturated) (Clerici solution)	4.07 (12°C) 4.65 (50°C) 5 (95°C)	

Table 16b

Dense Melts [16]

Melt	M.p.	d	Properties
Silver nitrate	198°C	4.1	Wide variety of uses. Can be diluted with KNO_3 or NaNO_3 . Decomposes on long melting; thus, addition of several drops of concentrated HNO_3 is advantageous. Risk of decomposition with free metals.
Mercury(I) nitrate	70°C	4.3	
Thallium nitrate	206°C	5.3	Prepared by dissolving proper amounts of Tl and Ag in HNO_3 . Can be diluted with water, with strong melting point depression. Colorless, mobile, transparent liquid. An Ag film forms under the influence of strong light. This can be redissolved with a little HNO_3 . Sulfides decompose the melt. Silicates are partially attacked.
Thallium nitrate-silver nitrate (in ratios depending on the powder to be separated) (Retgers)	75°C	4.5 to 4.9	
Thallium mercury(I) nitrate (Retgers)	76°C	5.3	

In all separations with dense melts, care should be taken to maintain a constant temperature.

Analysis of Purity

Although melting point determination is of special importance for organic analysis, it is often useful in inorganic preparative work as well. Of course, the usual methods, using a capillary in a thermostatted bath, cannot be used in most cases because of the high melting points. Higher temperatures can be reached with a copper or aluminum block [18]. For high temperatures, the crucible method is used, in which the cooling rate of the melt is followed with a thermocouple immersed in it. The method is greatly simplified by adding to the setup a second thermocouple placed next to the first and connected in a circuit with a third one placed in a second crucible, which stands beside the melt and contains a comparison substance (e.g., fine sand) (see Fig. 83, differential thermocouple). As long as the melt and comparison crucibles are at the same temperature, the two thermoelectric currents cancel. As soon as a temperature difference develops as a result of the heat of crystallization, the highly sensitive instrument deflects and the temperature corresponding to the first crystallization is read off from the proper thermocouple. This method of

differential thermal analysis is, in addition to melting point determination, also quite generally suitable for the investigation of all changes, reactions, etc., which are accompanied by thermal effects.

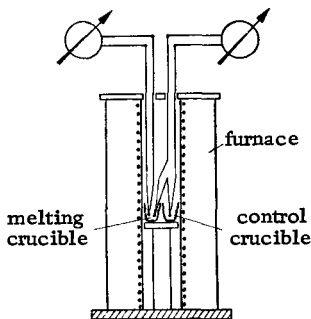

Fig. 83. Determination of solidification point with differential arrangement of the thermocouples

For very high temperatures, or if only very small amounts of material are available, Burgess's micropyrometer can be used [18].

Measurement of vapor pressure of low-boiling substances has already been treated in the discussion of Stock's apparatus. With substances boiling above room temperature, a heated manometer must be used. For instance, molten tin can be used as the manometer liquid and the flask containing the substance together with the short manometer lowered into the heated bath, while the second leg of the manometer is connected to a Hg manometer and a surge vessel. The pressure is then compensated for until the tin in both legs is at the same level, and the pressure is read off on the Hg manometer. Another very useful device is the isoteniscope of Smith and Menzies [18]. Here the substance itself serves as the manometer liquid. Figure 84 shows the apparatus. The substance is poured into the small flask α and the instrument is evacuated; the material is permitted to boil a little and the instrument is then tilted so that a portion of the substance flows

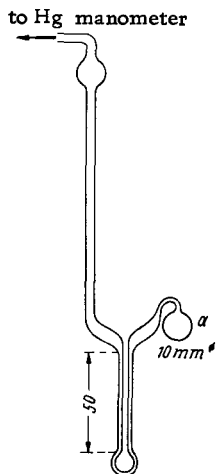

Fig. 84. Isoteniscope

into the manometer leg. Then the entire instrument is brought to the desired temperature and the pressure is so controlled that the liquid levels in both legs are the same. The pressure is then read off on the mercury manometer.

The best device, however, is the quartz coil manometer, the coil of which can be heated to 500°C (in special cases to $600\text{--}700^{\circ}\text{C}$). In all cases the null point of the instrument must be checked after each measurement. Therefore the manometer should be provided with a heating coil, which does not need to be at the test temperature but must nevertheless be at a sufficiently high temperature to prevent condensation in the coil and in the capillary connections (which are likewise provided with a heating coil). With compensation to zero, the pressure is read off on the Hg manometer. In those cases where it cannot be ascertained by the usual method (with a thermometer and distillation flask) the boiling point is determined more accurately by extrapolation of the vapor pressure curve.

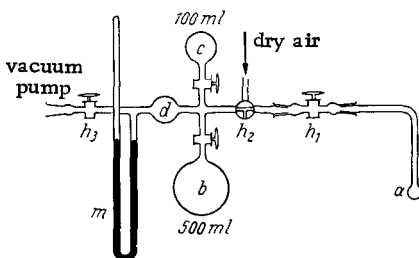

Fig. 85. Vapor pressure eudiometer.

Vapor pressure eudiometer. This apparatus was originally devised as a tool for analytical checking of the course of decomposition of amines or hydrates, but it is also useful for preparatory purposes, e.g., when determination of a definite stage of decomposition is desired. Figure 85 shows the construction of this device. The substance is enclosed in the smallest possible flask *a* and a definite quantity of the volatile component is removed from it. The right leg of the manometer *m* is calibrated in milliliters from the zero position (both legs at equilibrium) down. The volumes of *a*, of the various tube sections between stopcocks h_1 , h_2 and h_3 , and of the auxiliary flasks *b*, *c* and *d* are measured partly by direct weighing and partly determined indirectly, using the gas laws. The volatile component from *a* is removed intermittently and measured by means of auxiliary flasks *b* and *c*. The weight decrease of the substance is followed by weighing flask *a*, which is closed off by h_1 ; in order to be able to remove *a* at h_1 , dry air can be introduced at h_2 (G. F. Hüttig; G. Jander and H. Mesch [18]).

Powder Reactions

A certain mobility of the participating reagents as well as the largest possible contact surface are necessary for reactions between two solid substances. The mobility (rate of diffusion) and reactivity can be enhanced by raising the temperature or raising the energy content of the material by fine changes in the structure. According to a rule first advanced by Tamman—which is only approximately valid—reasonable conversions are obtained in normal experimentation times (order of magnitude: 1-100% conversion, 0.1-100 hours) only when at least one of the solid reagents is heated to over 2/3 of its absolute melting temperature [example: conversion of Al_2O_3 , m.p. 2320°K , is expected to be rapid only above 1550°K (about 1300°C)].

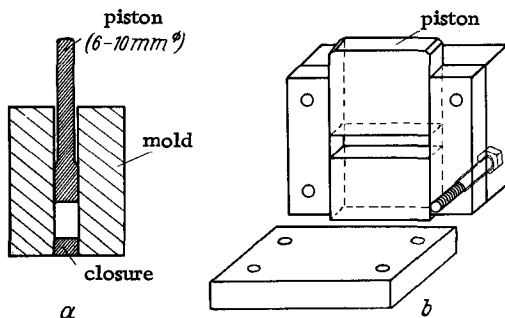

Fig. 86. Press forms for powder compression.

A large common surface of the reagents, which favors diffusion, is ensured by using a fine powder. The powders should be completely mixed and mechanically compressed into briquettes. A simple apparatus for the production of such briquettes (tablets) is shown in Fig. 86a. Such devices may be easily built in the laboratory from iron rods and are also available commercially (e.g., to make samples of combustible substances for calibration of calorimeters or KBr tablets for IR analysis). In simple cases, a screw press of suitable size suffices; for large cross sections and for high pressure, hydraulic presses are used. The contamination of the surface of the pressed object by traces of iron from the mold wall due to abrasion can scarcely be helped. If this is very troublesome, the surface of the finished pressed object can be ground or scraped off. Alternatively, a glass tube can be tightly fitted into the brass mold and the powder compressed with glass pistons inside this glass tube. Such an apparatus consisting of a sheathed glass tube (I.D. 5-6 mm., O. D. 7-8 mm.) can be operated at pressures of 100 kg./cm.^2 without breaking.

Figure 86b shows a mold that can be disassembled, devised by G. Grube and H. Schlecht [Z. Elektrochem. 44, 367 (1938)]. It is made of machined steel pieces and produces oblong, columnar wedges of compressed powder.

REFERENCES:

1. E. von Angerer. Technische Kunstgriffe bei physikalischen Untersuchungen [Industrial Techniques Applied to Physical Research], Braunschweig, 1952. R. E. Dodd and P. L. Robinson. Experimental Inorganic Chemistry. Amsterdam-London-New York, 1954. H. Grubitsch. Anorganisch-präparative Chemie [Preparative Inorganic Chemistry], Vienna, 1950. A. Klemenc. Behandlung und Reindarstellung von Gasen [Treatment and Purification of Gases], Vienna, 1948. F. Kohlrausch. Lehrbuch der praktischen Physik [Textbook of Applied Physics], Leipzig, 1944 and 1950. H. Lux. Anorganisch-chemische Experimentierkunst [Experimental Art in Inorganic Chemistry], Leipzig, 1954. Ostwald-Luther, Hand- und Hilfsbuch zur Ausführung physiko-chemischer Messungen [Handbook and Manual for Physico-chemical Measurements]. Leipzig, 1931.
2. Glass: G. Ch. Mönch. Hochvakuumtechnik [High-vacuum Technique], Pössneck, 1950 (pp. 225, 252). W. Espe and M. Knoll. Werkstoffkunde der Hochvakuumtechnik [Materials in High-Vacuum Technique], Berlin, 1936. H. Wilhelm. Glas-Instrumenten-Techn. [Glass Instrument Technique], 1, 11 (1957). E. P. Laug. Ind. Eng. Chem., Analyt. Ed. 6, 111 (1934); Chem. Fabr. 7, 241 (1934). Dechema-Erfahrungsaustausch-Blätter, Frankfurt a.M.
3. P. Goehrens. Einführung in die Metallographie [Introduction to Metallography], Halle, 1948, p. 164. W. Jander. Z. anorg. allg. Chem. 138, 321 (1924).
4. Ceramic Materials: E. Ryschkewitsch. Oxydkeramik der Einstoffsysteme [Single-Material Systems Oxide-Ceramics], Berlin, Göttingen-Heidelberg, 1948. P. Goehrens. Einführung in die Metallographie [Introduction to Metallography], Halle, 1948. Druckschriften der Deutschen Gold und Silberscheideanstalt, Frankfurt a.M. R. Winzer, Angew. Chem. 45, 429 (1932). Keramiker-Kalender, Berlin, 1940. E. Rabald. Dechema-Werkstofftabellen [Dechema Raw Material Tables], Frankfurt, 1948. M. Auwärter. Warmfeste und korrosionsbeständige Sinterwerkstoffe [Heat- and Corrosion-Resistant Sintered Materials], Plansee-Seminar, 1955, Reutte, p. 216.
5. Metals: Dechema-Werkstoff-Tabelle [Dechema Raw Material Tables], Weinheim, 1948 ff. E. Rabald. Werkstoffe [Raw Materials], in Ullmann, Enzyklopädie der Techn. Chem. 1, 935, Munich-Berlin, 1951. E. Rabald. Werkstoffe und Korrosion, Oberflächenschutz in Fortschr. Verfahrenstechnik [Raw

- Materials and Corrosion, Surface Area Protection in Advanced Chemical Engineering], 1952 - 53, 386 and 1954 - 55, p. 560. F. Ritter, Korrosions-tabellen metallischer Werkstoffe [Corrosion Tables of Metallic Raw Materials], Vienna, 1944.
6. High temperatures: J. D'Ans. Chem. Fabr. 3, 41 (1930). E. Ryschkewitsch. Chem. Fabr. 3, 61 (1930). Th. Diekmann and E. Houdremont. Z. anorg. allg. Chem. 120, 129 (1922). H. von Wartenberg. Z. anorg. allg. Chem. 176, 347 (1928). R. Fricke and F. R. Meyer. Chem. Ztg. 66, 53 (1942). R. Kieffer and F. Benesovsky. Planseeberichte 5, 56 (1957). K. B. Albermann. J. Sci. Instruments 27, 280 (1950). F. Davoine and R. Bernard. J. Physique Radium 13, 50 (1952). H. Bückle. Z. Metallforschung 1 (Z. Metallkde.), 53 (1946). H. von Wartenberg. Z. Elektrochem. 15, 708 (1909) (Iridium furnace). H. Davenport, S. S. Kistler, W. M. Wheildon and O. J. Wittemore. J. Amer. Ceram. Soc. 33, No. 11 (1950). W. J. Kroll. Z. Metallkde. 43, 259 (1952). G. Hägg and G. Kiessling. IVA (Sweden) 26, 105 (1955). —Cathode ray furnaces: H. von Wartenberg. Ber. dtsh. chem. Ges. 40, 3287 (1907). E. Tiede. Z. anorg. allg. Chem. 87, 129 (1914). H. Gerdien. Wiss. Veröff. Siemens 3, 226 (1923). —Solar furnaces: F. Trombe et al. A number of papers in Compt. Rend. Hebd. Séances Acad. Sci. since 1946. Proceedings of the 1957 Solar Furnace Symposium, J. Solar Energy Sci. Eng. 1, No. 2, 3 (1957).
7. Gas valves: A. Stock. Z. Elektrochem. 39, 256 (1933). A. Stock. Hydrides of Boron and Silicon, Ithaca N. Y.-London, 1933. W. E. Vaughan. Rev. Sci. Instruments 16, 254 (1945). P. W. Schenk. Private communication. H. Briscoe and A. Little. J. Chem. Soc. 105, 1321 (1914). E. H. Archibald. The Preparation of Pure Inorganic Substances, New York-London 1932. F. Seel, J. Nógrádi and R. Posse. Z. anorg. allg. Chem. 269, 197 (1952).
8. Methods for very air-sensitive solid materials: E. Zintl and H. H. von Baumbach. Z. anorg. allg. Chem. 198, 88 (1931). E. Zintl, A. Harder and S. Neumayr. Z. physik. Chem. (A) 154, 92 (1931). E. Zintl and A. Harder. Z. physik. Chem. (A) 154, 47 (1931); (B) 14, 265 (1931). E. Zintl and H. Kaiser. Z. anorg. allg. Chem. 211, 113 (1933). E. Zintl and E. Husemann. Z. physik. Chem. (B) 21, 138 (1933). E. Zintl and A. Harder. Z. Elektrochem. 41, 33 (1935). E. Zintl and G. Woltersdorf. Z. Elektrochem. 41, 876 (1935). E. Zintl and A. Harder. Z. physik. Chem. (B) 34, 238 (1936). E. Zintl and W. Morawietz. Z. anorg. allg. Chem. 236, 372 (1938). A. Helms and W. Klemm. Z. anorg. allg. Chem. 241, 97 (1939). W. Klemm and H. Sodomann. Z. anorg. allg. Chem. 225, 273 (1935). W. Klemm, H. Sodomann and P. Langmesser. Z. anorg. allg. Chem. 241, 281 (1939). A. Helms and W. Klemm.

- Z. anorg. allg. Chem. 242, 33 (1939). A. Helms and W. Klemm. Z. anorg. allg. Chem. 242, 201 (1939). E. Böhm and W. Klemm. Z. anorg. allg. Chem. 243, 69 (1939). W. Teichert and W. Klemm. Z. anorg. allg. Chem. 243, 86 (1939). W. Teichert and W. Klemm. Z. anorg. allg. Chem. 243, 138 (1939). W. Klemm and G. Mika. Z. anorg. allg. Chem. 248, 155 (1941). G. Brauer. Z. anorg. Chem. 255, 101 (1947).
9. Purification of inert gases: E. R. Harrison. J. Sci. Instruments 29, 295 (1952). O. Ruff and H. Hartmann. Z. anorg. allg. Chem. 121, 167 (1922). O. Ruff and E. Foerster. Z. anorg. allg. Chem. 131, 321 (1923). G. Grube and H. Schlecht. Z. Elektrochem. 44, 367 (1938). N. W. Mallet, Ind. Eng. Chem. 42, 2096 (1950).
10. Methods with liquefied gases (NH_3 , SO_2): E. C. Franklin and C. A. Kraus. J. Amer. Chem. Soc. 23, 277 (1900). A. Stock and B. Hoffmann. Ber. deutsch. chem. Ges. 36, 895 (1903). H. Biltz and E. Rahlfs. Z. anorg. allg. Chem. 166, 351 (1927). F. Weibke. Thesis, Hannover, 1928. E. Zintl and O. Kohn. Ber. deutsch. chem. Ges. 61, 195 (1928). E. Zintl, J. Goubeau and W. Dullenkopf. Z. physik. Chem. (A) 154, 1 (1931). E. Zintl and A. Harder. Z. physik. Chem. (A) 154, 47 (1931). R. Schwarz and P. W. Schenk. Ber. deutsch. chem. Ges. 63, 296 (1930). R. Schwarz and L. A. Jeanmaire. Ber. deutsch. chem. Ges. 65, 1443 (1932). R. Juza, K. Fasold and W. Kuhn. Z. anorg. allg. Chem. 234, 86 (1937). O. Schmitz-DuMont, J. Pilzecker and H. F. Piepenbrink. Z. anorg. allg. Chem. 248, 175 (1941). O. Schmitz-DuMont, H. Broja and H. F. Piepenbrink. Z. anorg. Chem. 253, 118 (1947). G. Jander, H. Wendt and H. Hecht. Ber. deutsch. chem. Ges. 72, 698 (1944). G. Brauer and V. Stein. Z. Naturforschung 2 b, 323 (1947). G. W. Watt and C. W. Keenan. J. Amer. Chem. Soc. 71, 3833 (1949). F. Seel and T. Gossel. Z. anorg. allg. Chem. 263, 253 (1950). F. Seel, J. Nógrádi and R. Tosse. Z. anorg. allg. Chem. 269, 197 (1952). F. Seel and D. Wesemann. Chem. Ber. 86, 1107 (1953). R. Klement and L. Benek. Z. anorg. allg. Chem. 287, 12 (1956). J. Jander and E. Schmid. Z. anorg. allg. Chem. 292, 178 (1957). J. Jander and E. Kurzbach. Z. anorg. allg. Chem. 296, 117 (1958).
11. Discharges: G. M. Schwab and H. Friess. Z. Elektrochem. 39, 586 (1933). R. Schwarz and M. Schmeisser. Ber. deutsch. chem. Ges. 70, 1163 (1937). K. H. Geib and P. H. Harteck. Ber. deutsch. chem. Ges. 66, 1815 (1933). P. W. Schenk and H. Jablonowski. Z. anorg. allg. Chem. 244, 397 (1940). P. W. Schenk. Angew. Chem. 50, 535 (1937). A. Stock, H. Martini and W. Sütterlin. Ber. deutsch. chem. Ges. 67, 396, 408 (1934).
12. Crystal growing. General summaries: W. Kwasnik. Chemie Arbeit 67, 217 (1944). H. E. Buckley. Crystal Growth, New

- York-London, 1951. A. Neuhaus. Chem.-Ing. Technik 28, 155 and 350 (1956). M. A. Short. The Industrial Chemist 33, 3 (1957). —Individual procedures: S. Kyropoulos. Z. anorg. allg. Chem. 154, 310 (1926). K. Korth. Z. Physik 84, 677 (1933). H. Schoeneck and H. Verleger. Metallwirtsch. 26, 576 (1939). G. Tammann. Lehrb. d. Metallographie [Text-book on Metallography], Leipzig, 1921, p. 13. P. W. Bridgman, Proc. Amer. Acad. Sci. 60, 306 (1925). I. Obremov and L. Schubnikow. Z. Physik 25, 31 (1924). M. Straumanis. Z. physik. Chem. (A) 147, 163 (1930). J. Czochralsky. Z. physik. Chem. 92, 219 (1918). E. von Gomperz. Z. Physik 8, 184 (1922). H. Mark, M. Polany and E. Schmid. Z. Physik 12, 60 (1923). F. Koref, H. Hoffmann and H. Fischvoigt. Z. Elektrochem. 28, 511 (1922). A. E. Van Arkel. Physica 3, 76 (1923). A. E. Van Arkel and J. H. de Boer. Z. anorg. allg. Chem. 148, 345 (1925). C. Agte and K. Moers. Z. anorg. allg. Chem. 198, 233 (1931). A. E. Van Arkel. Metallwirtsch. 13, 511 (1934). W. G. Burgers and J. C. M. Basart. Z. anorg. allg. Chem. 216, 209 (1934). A. E. Van Arkel. Reine Metalle [Pure Metals], Berlin, 1939.
13. Zone melting: H. Kleinknecht. Naturw. 39, 400 (1952). S. Muller. Z. Naturforschung 9 b, 504 (1954). F. Trendelenburg. Angew. Chem. 66, 520 (1954). W. G. Pfann. Metals 4, 747, 861 (1952); Chem. Eng. News 34, 1440 (1956). W. G. Pfann and K. M. Olsen. Bell Lab. Record 1955, 201. G. Hesse and H. Schildknecht. Angew. Chem. 68, 641 (1956). H. Schildknecht and A. Mannl. Angew. Chem. 69, 634 (1957).
14. Gravity separation. General: E. Kaiser, Mineralogisch-geologische Untersuchungsmethoden [Mineralogical-Geological Research Methods], in Keilhack, Praktische Geologie [Practical Geology], Vol. II, Stuttgart, 1922.
15. Liquids for gravity separation: Thoulet. Bull. Soc. min. France 2, 17 (1878). See also Hölde and Wervuert. Zentralbl. Min. 1909, 554. D. Klein. Compt. Rend. Hebd. Séances Acad. Sci. 93, 318 (1881). Rohrbach. Neues Jahrb. 2, 186 (1883). E. Clerici. Rend. Accad. Naz. Lincei 16, 187 (1907).
16. Melts for gravity separation: Retgers. Z. physik. Chem. 5, 451 (1890); Neues Jahrb. 2 (1889).
17. Apparatus for gravity separation: Thoulet. Bull. Soc. Min. France 2, 17 (1879). C. W. Brögger. Neues Jahrb. 1, 395 (1885). Laspeyres. Z. Kristallogr. 27, 44 (1896). Penfield. Z. Kristallogr. 26, 134 (1896).
18. Analysis of purity: H. Rassow. Z. anorg. allg. Chem. 114, 117 (1920). G. K. Burgess. Physik. Zeitschr. 14, 158 (1913). A. Smith and A. W. C. Menzies. Ann. Physik. 33, 971 (1910). G. F. Huttig. Z. anorg. allg. Chem. 114, 161 (1920). G. Jander and H. Mesech. Z. physik. Chem. (A) 183, 121 (1938).

Part II

Elements and Compounds

Hydrogen, Deuterium, Water

M. BAUDLER

Hydrogen



Commercial hydrogen, available in steel cylinders, is produced either by electrolysis or by the water shift reaction from water gas.

Electrolytic hydrogen contains 99.7-99.8% H_2 . The only impurity is air, with the oxygen amounting to less than 0.1%. This commercial hydrogen may be treated either by passage through a combustion tube filled with reduced CuO wire at 400°C , or by passage through the "active copper tower" of Meyer and Ronge (see section on Nitrogen), followed by drying with CaCl_2 or P_2O_5 . The gas obtained by either of these methods may be used for most laboratory applications, since its very small N_2 content (about 0.2%) is usually not harmful. If commercial electrolytic hydrogen is unavailable, it may be prepared in the apparatus described in the section on Nitrogen (the polarity is reversed, compared to oxygen preparation!).

On the other hand, commercial hydrogen produced from water gas is contaminated with considerable amounts of CO , CO_2 , O_2 and N_2 , and sometimes also with AsH_3 and $\text{Fe}(\text{CO})_5$. The CO_2 may be removed by absorption with KOH or soda lime; the AsH_3 is taken up by a fully saturated KMnO_4 solution (containing solid KMnO_4). The O_2 is separated out either by passage over heated copper wire or over red-hot Pt -asbestos (prepared according to the directions given in the section on Platinum Metals). The latter procedure also results in thermal decomposition of the $\text{Fe}(\text{CO})_5$. The removal of CO is more difficult, since neither absorption in acid or ammoniacal CuCl solution nor oxidation with HgO (or HIO_3) is quantitative. The most reliable method of removing CO is freezing out at the temperature of liquid nitrogen. In any case, pure H_2 is best prepared from electrolytic hydrogen.

Very pure, completely air-free hydrogen may be prepared by any of the following methods.

I. HEATING OF PALLADIUM SPONGE

Palladium sponge, prepared by the reduction of PdCl_2 solution (see section on Platinum Metals), is carefully washed with hot water, dried and well calcined by heating with a burner. The hot product is charged into a preheated combustion tube (provided with a manometer sealed to one end) and allowed to cool slowly in vacuum. When the sponge reaches room temperature, a carefully prepurified and predried H_2 stream is admitted into the tube and is to a large extent absorbed by the Pd. The absorption produces a slight glowing of the sponge. When the sponge is then heated to about 200°C , pure H_2 is liberated. A steady stream of the gas may be obtained with the aid of a small pump. In this way, 100 ml. (STP) of H_2 may be obtained per gram of palladium.

This method is especially useful in the preparation of small quantities of very pure hydrogen. E. von Angerer (*Technische Kunstgriffe bei physikalischen Untersuchungen* [Industrial Techniques Applied to Physical Experiments] 6th ed., Braunschweig, p. 92) shows an apparatus capable of continuous production of 100 ml. of pure H_2 per hour. It operates on the principle of hydrogen diffusion through electrically heated Pd tubes.

II. DIFFUSION THROUGH NICKEL

Commercial hydrogen may also be further purified by diffusion through nickel. This may be accomplished in the apparatus shown in Fig. 87, which yields a steady stream of very pure gas at atmospheric pressure.

The basic component is a pure nickel, precision ground, seamless tube (diameter 2 mm., length 5 m., wall thickness 0.1 mm.) soldered shut at one end. Five such tubes are needed. Each is coiled into a helix, the helices are intertwined, and the open end of each tube is soldered to a brass header, as shown. The header is provided with a standard tapered male joint n . For ease of handling, the tubes are heated in a H_2 stream at 1000°C for two hours, after which they may easily be bent by hand. The helix assembly is inserted into a quartz reactor tube 1 m. long and 35 mm. in diameter. The front and back headers are cemented to the quartz tube with picein, as shown. The back header is provided with a needle valve v , which serves for fine control of pressure in the tube and through which the gaseous impurities, which are contained in the hydrogen and which accumulate in the reactor, may be released and subsequently burned. The front header has a connection for a mercury manometer. Only the middle part of the quartz reactor is electrically heated. Thus, the soldered points of the nickel tubes remain in the cooler sections of the apparatus.

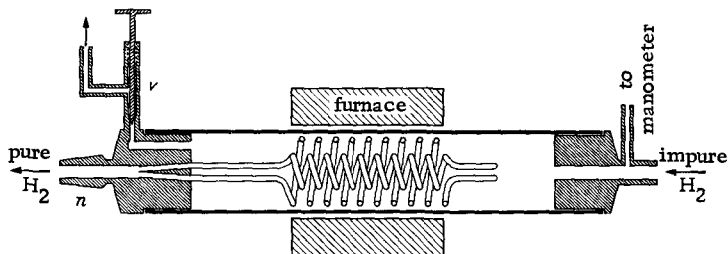

Fig. 87. Purification of hydrogen by diffusion through nickel: v is a needle valve for fine control of pressure in the apparatus.

Depending on the operating conditions, the apparatus is capable of delivering the following quantities of hydrogen:

°C	15	20	25	30	mm. Hg
750	20	27	34	41	} ml./min.
815	27	36	43	52	
860	34	45	55	68	
900	41	54	68	84	

The gas output is proportional to the pressure in the reactor but does not vary linearly with temperature. By varying the pressure, any desired gas output can be obtained almost instantaneously. Provided the feed gas cylinder has a good regulator, the reactor will give trouble-free operation for about 250 hours. However, it must be tested for leaks before each run.

III. DECOMPOSITION OF UH_3

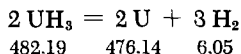

This procedure permits the production of very pure hydrogen free of noble gases. The gas may be obtained in any desired amount and at any time from previously made UH_3 .

The UH_3 may be prepared in the apparatus shown in Fig. 88. Commercial electrolytic hydrogen (from a cylinder) is prepurified by passage over copper shavings in tube b at $650\text{--}700^\circ\text{C}$ and drying with anhydrous $\text{Mg}(\text{ClO}_4)_2$ in tube c . The gas may be further purified at d by passage through pulverized uranium at $700\text{--}750^\circ\text{C}$.

This prepurified hydrogen may then be converted to UH_3 in the two-neck flask f , which is half filled with uranium turnings. These turnings must also be prepurified by treatment with dilute HNO_3 (to remove the oxide film), washing and drying. Flask f is heated either with a nitrate-nitrite salt bath or an electric furnace. The temperature in the flask is 250°C . Two wash bottles, one empty and one filled with concentrated H_2SO_4 , are attached to flask f .

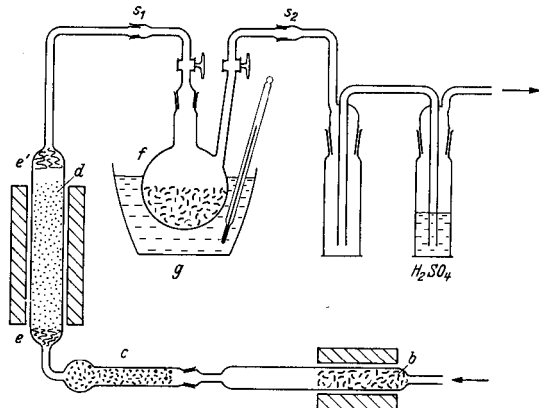

Fig. 88. Preparation of uranium hydride and purification of hydrogen. b) tube filled with copper shavings; c) tube filled with $\text{Mg}(\text{ClO}_4)_2$; d) tube containing uranium powder supported and covered by glass wool plugs e and e' ; f) flask with uranium turnings; g) heating bath; s_1, s_2) ground glass joints.

The apparatus must be thoroughly purged with hydrogen prior to the run, i.e., prior to heating b , d and f . The reaction is completed when the H_2SO_4 in the riser of the last wash bottle is no longer pulled upward by suction upon interruption of the H_2 stream.

The UH_3 product is a brown-black, spontaneously igniting powder. Very pure hydrogen may be liberated from it by heating, possibly at reduced pressure, to 400°C (or to a somewhat lower temperature). The uranium powder residue remaining after the decomposition reacts vigorously with H_2 at room temperature. The reaction is still quite vigorous at -80°C and ceases only at -200°C .

IV. DECOMPOSITION OF TITANIUM HYDRIDE

Titanium hydride is well suited for the production of larger quantities of very pure hydrogen. It has a relatively low decomposition temperature (400 - 900°C), a relatively high hydrogen content, and is easily regenerated. Aside from this, titanium oxide and nitride are completely stable at the required decomposition

temperatures. The decomposition is endothermic. Thus, the evolution of gas ceases whenever the flow of heat is reduced, and a continuous, well-controlled gas stream is obtained. It is advisable to use the apparatus shown in Fig. 89, so that the very pure H_2 product may be immediately used in hydrogenation reactions, which may be conducted in the space provided at g .

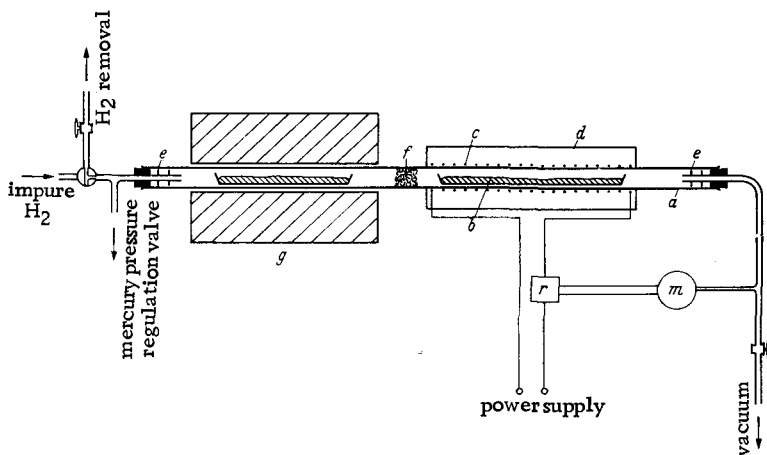

Fig. 89. Preparation of very pure hydrogen from titanium hydride. *a*) quartz reactor tube; *b*) molybdenum boat containing Ti; *c*) heating winding; *d*) radiation shield; *e*) radiation shields for protection of stoppers; *f*) glass wool; *g*) apparatus for conducting reactions with the very pure hydrogen product; the tube contains a boat for the reactants and is surrounded by an electric furnace. This part may be omitted if the hydrogen product is to be used elsewhere; *m*) pressure-sensing switch; *r*) relay.

A quartz reactor tube *a* (O.D. 34 mm., I.D. 30 mm., over-all length 1500 mm.) is wound over a length of 650 mm. with a heating coil *c*, which is cemented to the tube with a thin quartz-waterglass slurry. Molybdenum boat *b* is placed in the heated zone. The radiation shield *d* retards heat loss to the outside. Switch *m* controls the heat input to the winding, sensing the pressure developed by the hydrogen product stream.

The titanium hydride is prepared as follows: commercial titanium sponge of usual purity and medium grain size is placed in the molybdenum boat and dried in a stream of commercial hydrogen at 400°C . This step may sometimes be omitted. Following this, the temperature is raised to 700°C . The material is then heated for 30 minutes while maintaining the gas flow. Then, after thorough evacuation of the apparatus, the product (titanium hydride) is heated

until a pressure of 0.1 atm. gauge is registered on switch *m*, at which point the current is shut off. The pressure decreases due to the rapid drop in temperature and consequent gas volume contraction (and/or use of the gas for hydrogenation at *g*). When the control point pressure is reached, the current is again switched on. Despite this simple "on-off" control, pressure fluctuations are small.

After the desired amount of hydrogen has been liberated, the titanium hydride may be regenerated by heating in commercial hydrogen and subsequent cooling. A charge of 500 g. of titanium sponge will liberate 100 liters of pure H₂ per run.

V. ELECTROLYSIS IN THE ABSENCE OF AIR

An apparatus for electrolytic preparation of H₂ or O₂ (depending on polarity) in complete absence of air is described in the section on Nitrogen. The product gas contains less than $4 \cdot 10^{-6}\%$ air.

PROPERTIES:

Formula weight 2.016. Colorless, odorless, tasteless gas. Its reducing action is especially apparent at high temperatures. For this reason, hot H₂ should not be passed through concentrated H₂SO₄, since it then becomes easily contaminated by SO₂. M.p. -259.2°C, b.p. -252.8°C; *t*_{CR} -239.9°C, *p*_{CR} 12.8 atm. gauge; *d* (liquid) 0.070; weight of 1 liter H₂ at STP = 0.08987 g. Solubility in water at 760 mm.: 0.021 vol./vol. at 0°C, 0.018 vol./vol. at 20°C, 0.016 vol./vol. at 100°C. Solubility in other liquids is also very small.

REFERENCES:

- A. Klemenc. Die Behandlung und Reindarstellung von Gasen [Treatment and Purification of Gases], Leipzig, 1938, p. 97.
- I. L. Moser. Die Reindarstellung von Gasen [Purification of Gases], Stuttgart, 1920, p. 37.
- II. R. Schäfer and W. Klemm. J. prakt. Chem. (4) 5, 233 (1958); J. L. Snoek and E. J. Haes. Appl. Sci. Res. A 2, 326 (1950); see also: E. R. Harrison and L. C. W. Hobbs. Rev. Sci. Instruments 26, 305 (1955).
- III. F. H. Spedding, A. S. Newton, J. C. Warf, O. Johnson, R. W. Nottorf, I. B. Johns and A. H. Daane. Nucleonics 4, 4 (1949).
- IV. B. Lux. Planseeber. Pulvermetallurgie 4, 7 (1956).
- V. F. Paneth and K. Peters. Z. physik. Chem. 134, 364 (1928); G. Brauer. Z. anorg. Chem. 255, 105 (1947).

Pure Water

The usual laboratory distilled water contains considerable amounts of dissolved CO_2 and, occasionally, traces of NH_3 and organic substances.

This distilled water may be purified with CO_2 - and NH_3 -free air, which is allowed to bubble through at 90°C for 24 hours. The air should be drawn from outside the building, since laboratory air is often quite badly contaminated. Before contacting the water, the air passes successively through a wash bottle filled with concentrated H_2SO_4 , two bottles with NaOH , and one filled with pure water. Avoid long rubber tubing connections.

This prepurified water is then doubly distilled, first with addition of some NaOH and KMnO_4 and then in the presence of a small quantity of KHSO_4 . The condenser and its connections should be of Sn, Pt or quartz. Glass condensers must be avoided. It is advisable to bend the condenser outlet at a right angle and insert the leg directly into the neck of the receiver, using no sealing materials (see Fig. 90). To avoid condensate spraying, a vapor trap is installed before the receiver, as shown in the figure (b).

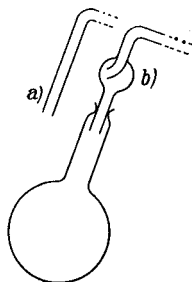

Fig. 90. Distillation of pure water. Adapters for transition from condenser to the receiver; a) simple and inexpensive; b) with a vapor trap.

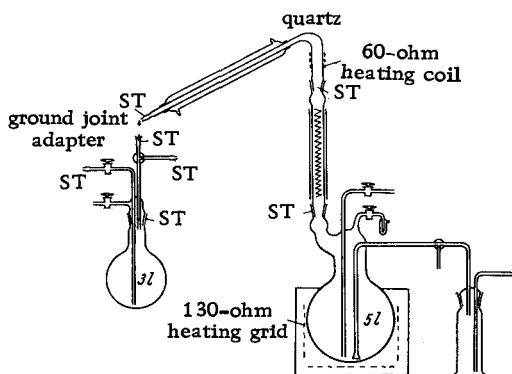

Fig. 91. Distillation of "conductivity" water. ST are standard ground joints.

The receivers should be of quartz, Pt or Pyrex and must be thoroughly steamed out before use. The distillation should be slow and large volumes of forerun and residue should be discarded. Contact with laboratory air should be avoided as much as possible.

The product may be tested for purity by the conductivity method. The freshly distilled product should have a conductivity of about $10^{-6}/\text{ohm}^{-1}\text{cm}^{-1}$. It may be tested for CO_2 with $\text{Ba}(\text{OH})_2$ solution and for NH_3 with Nessler's reagent.

Very pure water is stored in quartz or platinum containers. Pyrex vessels may be used, if properly steamed out and if employed only for water storage. The receiver neck should have a male ground joint and be closed by a cap with a female joint.

REFERENCES:

- O. Hönigschmid and R. Sachtleben. *Z. anorg. allg. Chem.*, **221**, 65 (1934); Ostwald-Luther. *Hand- und Hilfsbuch zur Ausführung physikochemischer Messungen [Handbook and Manual for Making Physicochemical Measurements]*, 5th Ed., Leipzig, 1931, p. 633.

"CONDUCTIVITY" WATER

Extremely pure water for conductivity measurements is obtained through very careful distillation of already thoroughly purified material. This prepurified water (conductivity at 25°C: $1-2 \cdot 10^{-6}$ ohm⁻¹) is obtained either via the method described above or through another double distillation procedure [the first distillation with $\text{KMnO}_4 + \text{H}_2\text{SO}_4$, the second with $\text{Ba}(\text{OH})_2$, using a Pyrex apparatus with a tin condenser].

I. Single-step distillation according to the method of Kortüm is done in the apparatus shown in Fig. 91. Except for the short quartz condenser, the apparatus is made of Pyrex. All connections are made with ground joints, except where indicated. The section between the reflux condenser and the quartz condenser is wound with a 60-ohm heating coil and heated to 100°C in order to avoid creepover of liquid water. The Pyrex reflux condenser is of the internal helix type. A ground joint adapter connects the condenser and the receiver. This adapter and the receivers must be thoroughly presoaked in hot, dilute acids (several days) to remove any impurities which may increase the conductivity of the product.

The pure water charge is distilled in a stream of air. Compressed air from a cylinder flows at a slow rate of 1 bubble/second through seven wash bottles. In succession, these are filled with concentrated H_2SO_4 (1 bottle), 50% KOH (3 bottles) and "conductivity" water (3 bottles, preferably with glass frits). The same compressed pure air is used to transfer the product water from the receivers to storage vessels. The three grids heating the distillation flask consume about 300 watts. In order to improve the rate and uniformity of heat transfer, the space between the heating grid and the distillation flask is filled with ceramic beads. The center tube of the distilling flask permits charging and emptying the contents.

A conductivity cell is attached to the three-way stopcock at the outlet of the condenser. The distillate is discarded until

its conductivity matches the desired value. Only then is the system connected to the receiver.

The apparatus delivers 100 ml./hr. of water having a κ (25°C) = $2 \cdot 10^{-7}$ ohm⁻¹. At very low distillation rates, water with a κ (25°C) = 10^{-8} ohm⁻¹ may be obtained.

II. "Conductivity" water with κ (25°C) = $6-8 \cdot 10^{-8}$ ohm⁻¹, in volumes larger than those provided by the apparatus of method I, can be obtained with the installation of Thiessen and Herrmann. This two- or three-step distillation does not require excessively complex equipment and is capable of delivering 400 ml./hr. of product.

REFERENCES:

- I. G. Kortüm. Chem. Fabrik 13, 143 (1940).
- II. P. A. Thiessen and K. Herrmann. Chem. Fabrik 10, 18 (1937); Z. Elektrochem. 43, 66 (1937).

"pH-PURE" WATER

The method for obtaining large quantities of water with pH = 7.00 is based on addition of NaOH and KMnO₄ during the first distillation and H₃PO₄ (to combine the NH₃) in the second distillation step. A third distillation in quartz apparatus (to remove traces of alkali) follows.

REFERENCE:

- E. Lux. Z. Elektrochem. 48, 215 (1942).

Deuterium and Deuterium Compounds

Deuterium and the simpler inorganic deuterium compounds are commercially available. Nevertheless, the research chemist may occasionally be called upon to prepare some of these compounds, starting with D₂O—the most available of the deuterium compounds.

Heavy water is manufactured in concentrations ranging from 5 to 99.5% D₂O and is sold in sealed glass ampoules. Pure heavy water is very hygroscopic; i.e., it loses D₂O vapor while simultaneously absorbing air moisture. Therefore, certain precautions must be taken when filling or emptying D₂O ampoules.

If only a portion of the ampoule content is to be used, the pointed end of the ampoule is heated in a small flame and drawn out to a capillary with tongs. The capillary end is then broken off and the desired quantity of D₂O driven out by gentle heating,

e.g., by hand. The receiver is closed off as soon as possible and the ampoule is immediately resealed with a flame. It is best to store it in a desiccator.

The D_2O contents of an ampoule may be preserved from contact with air moisture and still utilized only partially in the following way: the entire contents of the ampoule are transferred by the method given below to an elongated flask, closed off by a piercable, membrane-type rubber stopper, such as used for serum vials. Then the desired amounts of D_2O can be withdrawn from the closed flask by means of a hypodermic syringe and injected into other vessels, which can also be closed off with the same type of stopper. The very fine capillary produced in the rubber stopper by the needle closes immediately upon withdrawal of the latter.

If the entire contents of an ampoule are to be used in a reaction, it is best to break and empty it inside the reactor itself, thus avoiding transfer operations. To accomplish this, the ampoule is placed in a snugly fitting vessel, such as shown in Fig. 92. This vessel is then melt-sealed to the reactor. The apparatus is then connected to a high-vacuum system. If avoidance of dilution of the D_2O content is critical, the entire apparatus is heated by fanning with an open flame to remove the film of "light" water accumulated on the internal surfaces. The vacuum is then disconnected, the apparatus is closed off, and the vessel containing the ampoule is rapidly immersed in liquid nitrogen. The sudden freezing of the D_2O causes the ampoule to shatter. Cooling with an acetone-Dry Ice mixture is not sufficient, because the solidification of the D_2O tends to be slower and its crystals begin to grow mostly in the upper, empty part of the ampoule. Alternatively,

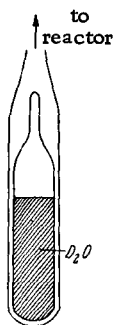

Fig. 92. Breaking D_2O ampoules by freezing with liquid nitrogen.

the ampoule may be broken by a sudden movement of a glass-enclosed iron bar, suspended inside the reactor and set in motion by an electromagnet.

All substances to be reacted with D_2O must be carefully freed of all traces of water. Hygroscopic compounds, in which the uptake of small amounts of H_2O during charging of the reactor is unavoidable, must be re-dehydrated in the reactor itself. This is done by heating (in high vacuum, if possible), distillation or resublimation, where applicable. Again, such hygroscopic compounds may be enclosed in sealed glass ampoules immediately after their preparation. These ampoules may then be inserted into the reactor and broken with a magnet-operated iron bar, as described above.

As far as possible, the apparatus should have fused connections and contain a minimum of stopcocks. If this is not possible, special care should be taken in sealing all possible leaks. Drying tubes should be inserted between the apparatus and its connections to the pumps (vacuum) or to the atmosphere. Better still, liquid-nitrogen-cooled gas traps should be used to prevent entrance of atmospheric moisture. Since in the presence of H₂O most inorganic D compounds exchange part of their D content for H, these precautions must be observed in all reactions described in later sections.

Large amounts of deuterium compounds are expensive. It is therefore advisable to practice each reaction with "light" starting material before attempting to use the D compounds.

REFERENCES:

1. Catalog of the Norsk Hydro-Elektrisk Kvaelstofaktieselskab, Oslo, Solligaten 7, Norway.
2. I. Wender, R. A. Friedel and M. Orchin. J. Amer. Chem. Soc. 71, 1140 (1949); M. Orchin and I. Wender. *Analyt. Chem.* 21, 875 (1949).
3. J. W. Knowlton and F. D. Rossini. J. Res. Nat. Bur. Standards 19, 605 (1937).

Deuterium

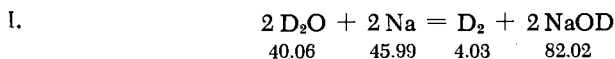
D₂

Flask *E* of the glass apparatus shown in Fig. 93 contains an Al crucible with excess metallic sodium. Vessel *V* contains the D₂O reagent. The latter is introduced (as described above) in the absence of atmospheric moisture. After cooling *V* with liquid nitrogen, the apparatus is carefully evacuated, with stopcocks 1 and 2 open. Stopcock 2 is then closed and the D₂O is distilled slowly onto the Na by cooling *E* with liquid nitrogen. To complete the reaction, *E* is then heated for several hours to 350°C. After opening stopcock 2, the D₂ produced is transferred for purification into a receptacle filled with degassed charcoal and left there for some time at -196°C. If fresh Na is used, the D₂ product will still contain some few percent of H₂ after the purification (this H₂ was dissolved in the metal and existed as NaOH). Pure D₂, containing less than 0.2% H₂ and other foreign gases, is only obtained in the second run with the same piece of Na.

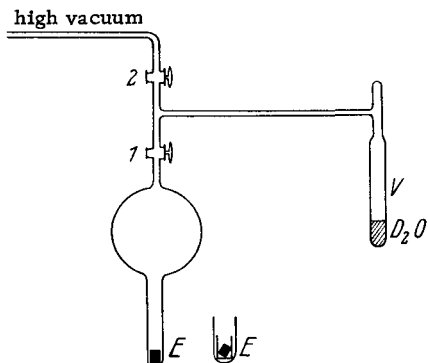
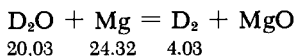

Fig. 93. Preparation of D_2 from D_2O and Na.

The gas is tested for purity by measurement of the thermal conductivity or vapor pressure. The yield of D_2 is quantitative.

The method is especially suitable for the preparation of small amounts of D_2 (up to one liter).

II.



In an elongated flask of a Pyrex apparatus, pre-evacuated to 10^{-4} mm., 20 g. of D_2O is slowly evaporated. The vapor passes through the reaction tube, set vertically on top of the flask. The tube (I.D. 2.4 cm. and 55 cm. long) contains 130 g. of Mg shavings of various sizes, with coarse particles on the bottom and loose powder on top. The column filling is supported by a perforated platinum disk which rests on glass lugs inside the tube. The Mg is heated to $480^\circ C$ by a tubular furnace.

After an extended period of time, some magnesium silicide will form on the walls of the heated glass tube. To avoid this, it is suggested that the Mg be placed in a tube of unglazed hard porcelain which is then inserted into a Pyrex or Vycor tube and melt-sealed to the latter at one end. With such an arrangement the Mg may even be heated to a somewhat higher temperature and its reactivity thus enhanced.

For purification, the D_2 product passes through a trap filled with glass wool and kept at $-196^\circ C$. It is taken out from the generator as quickly as possible, either by condensation with liquid H_2 or by forcing it into an attached storage container. An in-line flowmeter and a manometer allow constant checking of pressure. The rate of evolution can be controlled by varying the supply of heat to the D_2O flask. A maximum flow of 0.5 mole of D_2 /hour may be obtained. Since the first D_2 fraction may be

contaminated with some H_2 from the Mg and from the apparatus walls, it is advisable to collect some of the first D_2 fraction in a separate vessel. The D_2 formed later is very pure. The yield is quantitative.

This method allows rapid production of large amounts of D_2 and utilizes the entire D content of the heavy water.

III.

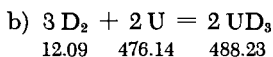
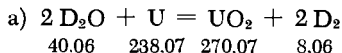

This method is especially useful in that it makes possible both the preparation (Eq. a) and the storage (as UD_3 —Eq. b) of D_2 . High-purity D_2 can then be liberated by thermal decomposition of the UD_3 . Any desired quantity of very pure D_2 can thus be obtained when needed.

The highly endothermic reaction of D_2O vapor with U may be carried out slowly and safely in the apparatus of Fig. 94. The 50-ml. flask *a* is connected by stopcock h_1 with manometer *b* and quartz reaction tube *d*. Reactor *d* is heated with an electric furnace to $600\text{--}700^\circ\text{C}$ and is connected to a liquid-nitrogen-cooled trap *f*. The latter is, in turn, connected to a high-vacuum pump and a flask *g* which may be heated to 250°C .

Flask *a* is about half filled with D_2O and *d* and *g* with uranium shavings (the uranium is pretreated with dilute HNO_3 to remove all oxide, then washed and dried). The shavings in reactor *d* are supported on and covered with glass wool plugs c_1 and c_2 . The D_2O in *a* is then frozen with a Dry Ice-methanol bath; this must be done slowly to avoid cracking the flask. The entire apparatus is then evacuated, while *g* and *d* are heated. The D_2O is then carefully melted and the reaction is slowly started by allowing the vapor to penetrate to the uranium in *d*. The first D_2 evolved is used to flush the apparatus, with stopcock h_3 closed. Only then is h_4 closed and h_3 opened. During the reaction, *a* is kept at about 30°C . The D_2 product passes through trap *f*, in which any entrained traces of D_2O are frozen out, and is absorbed by the uranium shavings in *g*, forming UD_3 . When all of the U is finally converted to UD_3 , the excess D_2 causes an increase in pressure which suppresses the evaporation of D_2O and thereby prevents any further D_2 formation. Thus, once started, the process is self-regulating and requires no special attention. Several grams of D_2O can be converted into UD_3 in one hour.

The UD_3 is a brown-black, spontaneously igniting powder. To prepare very pure D_2 , it is thermally decomposed either at atmospheric or reduced pressure (see also H_2 above: III). The U

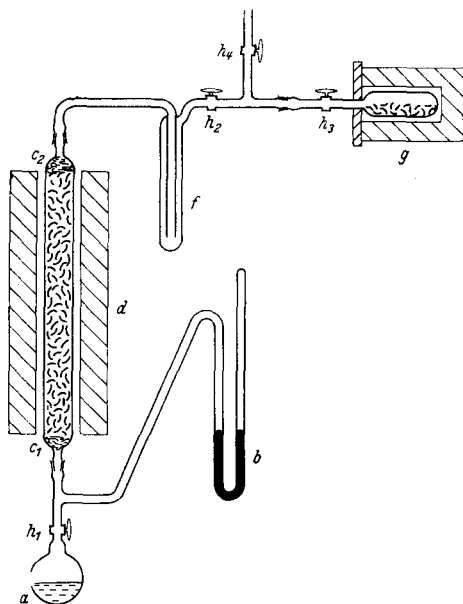
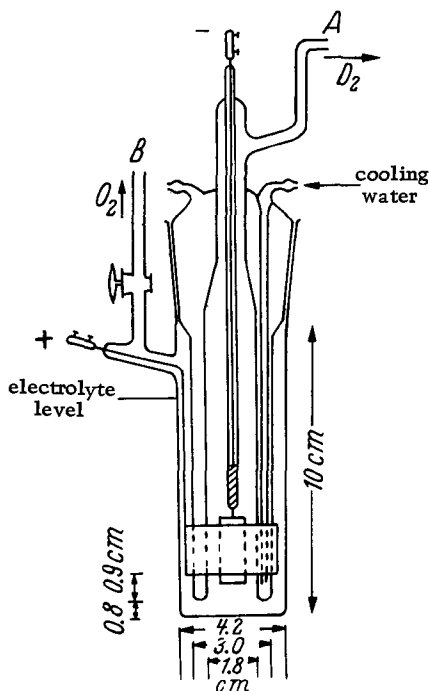

Fig. 94. Preparation and storage of deuterium. *a*) D_2O reservoir; *b*) manometer; c_1, c_2) ground joints; *d*) quartz tube containing U turnings; *f*) trap; *g*) reaction flask containing U turnings; h_1-h_4) stopcocks.

powder thus formed (at $400^\circ C$ or lower temperatures) reacts vigorously with H_2 (or D_2) at room temperature and still quite vigorously at $-80^\circ C$. Only at $-200^\circ C$ does the reaction cease.

IV. ELECTROLYSIS OF D_2O

An electrolytic cell, holding 60 ml. of liquid and made from a standard ground glass joint, is shown in Fig. 95. The male part of the ground joint continues into a cylindrical water jacket (only partly shown in the diagram) which surrounds the cathode. The Pt electrodes are also cylindrical and are prepared by fusing together a Pt wire with a Pt foil. The D_2O electrolyte is acidified with 25% D_2SO_4 . (If no D_2SO_4 is available, carefully dehydrated K_2SO_4 or Na_2CO_3 can also be used.) After evacuation of the cell at *A* and *B*, electrolysis is begun at a low current to prevent foaming at low pressures. After a short time, however, the current can be increased to 5 amp. The temperature of the electrolyte must not be allowed to rise. If the D_2 product gas is to overcome the pressure drop due to narrow tubes and a liquid head in the attached purification apparatus or reactor, the pressure in the cell must be maintained at a higher level by means of a throttling

Fig. 95. Electrolysis of D_2O .

valve in the O_2 outlet. The D_2 product still contains small amounts of O_2 and D_2O vapor. Very pure gas may be obtained by heating the electrolysis product over platinized asbestos, followed by drying with liquid nitrogen. At 5 amp., two liters of D_2 per hour is obtained.

Small quantities of D_2 are stored in sealed glass flasks or over mercury. Distilled water can also be used as a sealing liquid. Larger amounts may be condensed in a metal flask cooled with liquid H_2 . The liquid is then heated and thus forced through metal tubing into small steel cylinders.

Other equipment for electrolysis of D_2O , some of which is applicable to small-scale operation, is described by: F. Norling, *Physik. Z.* **36**, 711 (1935); C. M. Slack and L. F. Ehrke, *Rev. Sci. Instruments* (N.S.) **8**, 39 (1937); A. Sieverts and W. Danz, *Z. Phys. Chem. B* **38**, 46 (1937); M. M. Winn, *J. Sci. Instruments* **28**, 152 (1951); J. T. Lloyd, *J. Sci. Instruments* **29**, 164 (1952); R. W. Waniek, *Rev. Sci. Instruments* **21**, 262 (1950).

V. Other preparative methods: Reduction of D_2O with Fe or W at high temperatures.

SYNONYM:

Heavy hydrogen.

PROPERTIES:

Colorless, odorless gas. Chemical properties analogous to H_2 , but somewhat less reactive. In the absence of catalysts, mixtures of D_2 and H_2 are stable to about $500^\circ C$. In addition, no exchange with H_2O occurs at room temperature. M.p. $-254.6^\circ C$, b.p. $-249.7^\circ C$; d (liq., $-253.1^\circ C$) 0.171. Very slightly soluble in water and other liquids.

REFERENCES:

- I. G. N. Lewis and W. T. Hanson. J. Amer. Chem. Soc. 56, 1687 (1934).
- II. J. W. Knowlton and F. D. Rossini. J. Res. Nat. Bur. Standards 19, 605 (1937); unpublished experiments of G. Brauer.
- III. F. H. Spedding, A. S. Newton, J. C. Warf, O. Johnson, R. W. Nottorf, I. B. Johns and A. H. Daane, Nucleonics 4, 4 (1949).
- IV. C. L. Wilson and A. W. Wylie. J. Chem. Soc. (London) 1941, 596.
- V. E. Zintl and A. Harder. Z. phys. Chem. B 28, 480 (1935); A. Farkas and L. Farkas. Proc. Roy. Soc. London 144, 469 (1934).

Hydrogen Deuteride

HD

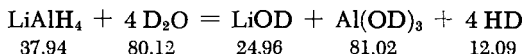

This reaction is conducted in a 250-ml. two-neck flask provided with a reflux condenser and a magnetic stirrer. The other neck of the flask is closed with a rubber cap. The reflux condenser is connected to a receiver and a diffusion pump via cold traps, where the entrained liquid is condensed. Gas inlet lines with stopcocks allow each part of the apparatus to be evacuated separately or, if desired, to be filled with air or N_2 .

About 150 ml. of n-butyl ether, dried over Na, is distilled into the reaction flask and 5.75 g. of $LiAlH_4$ (40% excess) is then added under a nitrogen blanket. The mixture is frozen with liquid N_2 . The apparatus is then evacuated, and the flask contents are brought to boiling by careful heating. After 1.5 hours, it is again

cooled with liquid N_2 , the evacuation is repeated, and 5 ml. of 99.5% D_2O (see above, D_2O) is added to the solidified mixture, using a hypodermic syringe to pierce the rubber cap. The gas evolution is started by melting the mixture and agitating with the magnetic stirrer. Because of the low reaction temperature, the flask becomes coated with ice on the outside. By repeated immersion in liquid N_2 , the temperature is controlled so that the ice on the outer wall of the flask does not melt. As soon as the reaction subsides somewhat, two additional portions of 6.5 ml. of D_2O each are added (for a total of 18 ml. or 150% excess). The yield is 10 liters of HD. The purity is 97-99%.

PROPERTIES:

Colorless, odorless gas. B.p. $-251.02^\circ C$; triple point $-256.55^\circ C$ (92.8 mm.).

REFERENCES:

- A. Fookson, P. Pomerantz and E. H. Rich. J. Res. Nat. Bur. Standards 47, 31 (1951); Science (New York) 112, 748 (1950).
 J. Wender, R. A. Friedel and M. Orchin. J. Amer. Chem. Soc. 71, 1140 (1949).
 R. B. Scott and F. G. Brickwedde. Phys. Rev. (2) 48, 483 (1935); 55, 672 (1939).

Deuterium Fluoride

DF

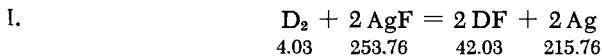

Some dry AgF is charged into a silver reaction flask provided with a manometer and an inlet tube that can be closed off. The AgF can also be produced by the action of F_2 on the inner walls of the flask itself. After evacuation, pure, carefully dried D_2 (see above, D_2) is admitted into the flask. The latter is then closed and heated to $110^\circ C$ until the pressure ceases to change. The DF formed is frozen out of the reaction mixture by cooling with liquid nitrogen, and excess D_2 is drawn off by suction after opening the flask. The product is purified by high-vacuum distillation in which all connections and receivers must be of Ag or Cu .

To date, this method has been used only for producing small amounts of DF. Deuterium fluoride may be stored in vessels made of platinum, silver or copper.

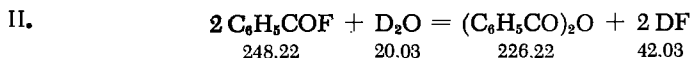

The reaction is carried out in the apparatus shown in Fig. 96. The latter is flushed out with dry N_2 , and atmospheric moisture is strictly excluded.

Silver flask *a* is charged with 168 g. (1.5 moles) of benzoyl fluoride and chilled with Dry Ice-acetone freezing mixture. Then 5 g. (0.25 mole) of 99.5% D_2O is added all at once under N_2 . The flask is then attached to the silver distillation apparatus. Brine at -15°C is circulated through the condenser *c*, and the quartz receiver is cooled with Dry Ice-acetone to -80°C . Cooling of

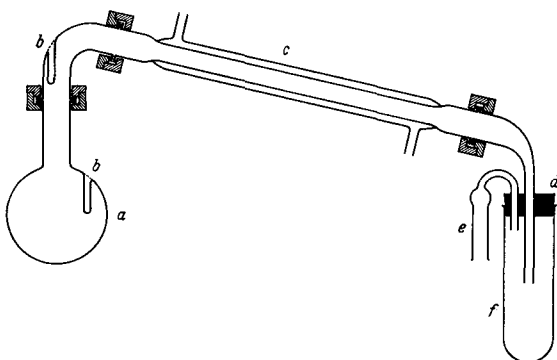

Fig. 96. Preparation of deuterium fluoride.
a) Silver flask; *b*) thermometer well; *c*) jacketed glass condenser; *d*) paraffin-coated stopper; *e*) calcium chloride tube; *f*) quartz receiver.

flask *a* is then ceased and the latter is slowly heated to room temperature: the evolving DF is then distilled on a water bath at $80-90^\circ\text{C}$. To achieve analytical purity and separate entrained benzoyl fluoride, the distillation is repeated twice. The yield is 9.7 g. of DF (92% of theoretical).

III. Larger quantities of DF can be prepared by synthesis from the elements according to a method described by H. von Wartenberg for the production of HF; however, this requires extensive equipment.

IV. Aqueous solutions of deuterated hydrofluoric acid can be prepared by the condensation of DF in D_2O or by the reaction of very pure CaF_2 with D_2SO_4 (see also preparation of pure hydrofluoric acid, p. 145 ff.).

PROPERTIES:

Formula weight 21.01. Colorless, waterlike liquid; pungent odor; fumes in moist air. The vapors are very toxic. Chemical properties analogous to HF. The deuterium is exchanged for hydrogen in the presence of H^+ . B.p. $+18.6^\circ C$. Very readily soluble in water.

REFERENCES:

- I. W. H. Clausen and J. H. Hildebrand. J. Amer. Chem. Soc. 56, 1820 (1934).
- II. G. Olah and S. Kuhn. Z. anorg. allg. Chem. 287, 282 (1956).
- III. H. von Wartenberg and O. Fitzner. Z. anorg. allg. Chem. 151, 313 (1926).

Deuterium Chloride

DCl

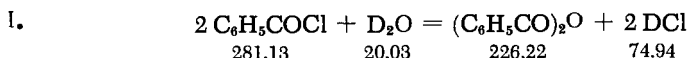

The apparatus shown in Fig. 97 may be enlarged if larger amounts of DCl are desired. The long capillary tube from dropping funnel *t*, which reaches into the reaction flask *r* through the condenser *k*, ensures uniform addition of D_2O to the benzoyl chloride in the flask in spite of small fluctuations of pressure during the reaction. In order to trap any benzoyl chloride entrained through the condenser by the DCl gas, trap *f* is cooled in an ice bath. Manometer *m* (with one arm open to the air) serves both as a safety valve and as a means for following the course of the reaction (if the outlet tube is closed off, the manometer will show whether the gas continues to evolve).

As an example of DCl preparation, 5 ml. of 99.6% D_2O is allowed to react with 210 g. of benzoyl chloride (2-3 molar excess) containing some porous boiling chips. At first, only a few drops of D_2O are added, while the mixture is carefully heated. This is continued until a moderate gas stream is developed. This temperature is maintained until all of the D_2O is added. By varying the heat input, gas formation can easily be regulated. As the flow decreases, the temperature is slowly increased to the boiling point of benzoyl chloride ($197^\circ C$) and kept there until no further gas is evolved. At the end of the reaction, a stream of dry air is slowly introduced into the apparatus through the dropping funnel, without interrupting the refluxing, to expel all the DCl. The product is analytically pure and the yield is almost quantitative.

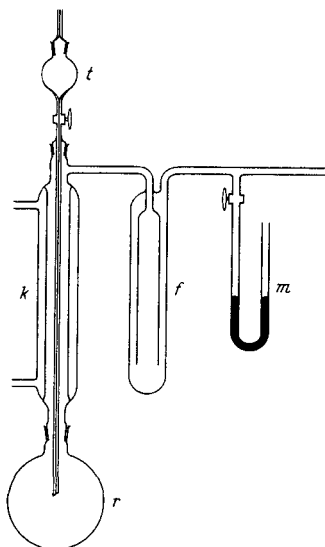

Fig. 97. Preparation of DCl from heavy water and benzoyl chloride. *f*) Condensation trap; *k*) reflux condenser; *m*) open arm manometer; *r*) reaction flask; *t*) dropping funnel with capillary stem.

V. Aqueous solutions of heavy hydrochloric acid are prepared by condensation of DCl in D_2O .

SYNONYM:

Heavy hydrogen chloride.

PROPERTIES:

Formula weight 37.47. Chemical properties analogous to HCl. In the absence of moisture and catalysts, no deuterium exchange occurs in gaseous mixtures of HCl and DCl. However, an exchange reaction occurs instantaneously in solvents containing H^+ . M.p. $-114.8^\circ C$, b.p. $-81.6^\circ C$, $t_{CR} +50.3^\circ C$.

REFERENCES:

- I. H. C. Brown and C. Groot. *J. Amer. Chem. Soc.* **64**, 2223 (1942).
- II. K. Clausius and G. Wolf. *Z. Naturforsch.* **2a**, 495 (1947).

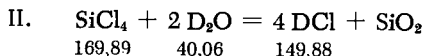

Two thin-wall, vacuum-sealed ampoules containing 18 g. of carefully purified SiCl_4 and 1.8 g. of D_2O are shattered by shaking in an evacuated five-liter flask provided with a glass stopper with a stopcock sealed in. After 24 hours the flask is sealed to a high-vacuum system and the crude gas condensed in a liquid-nitrogen-cooled trap. The product may be further purified as in I or, even better, with a low-temperature distillation column (see original literature for details).

Liquid deuterium chloride can be stored at low temperature. The gas may be stored in a sealed glass flask or over mercury.

Other preparative methods:

III. Reaction of anhydrous MgCl_2 with D_2O at $600^\circ C$:



Yields very pure DCl on distillation.

IV. Reaction of very pure NaCl with D_2SO_4 .

- III. G. N. Lewis, R. T. Macdonald and P. W. Schutz. J. Amer. Chem. Soc. 56, 494 (1934).
- IV. A. Smits, G. J. Muller and F. A. Kröger. Z. phys. Chem. B38, 177 (1937); see also O. E. Frivold, O. Hassel and S. Rustad. Phys. Z. 38, 191 (1937).

Deuterium Bromide

D₂Br



The glass apparatus shown in Fig. 98 is used. Prior to the run, it is evacuated for a considerable time via *P*. Flask *C* is charged with carefully purified Br₂ from *D* (see section on Br₂) by moving the plug *S* of the dropping funnel (which has no stopcock). The flask is then heated to 48°C. Dry D₂ (see p. 121) enters at *A* at a rate of about two liters/hour and passes through stopcock *B* (lubricated with phosphoric acid-graphite and sealed with mercury) into *C*, where it mixes with the bromine vapor from the dropping funnel. The D₂-Br₂ mixture flows into the Vycor combustion tube *R*, which is filled with

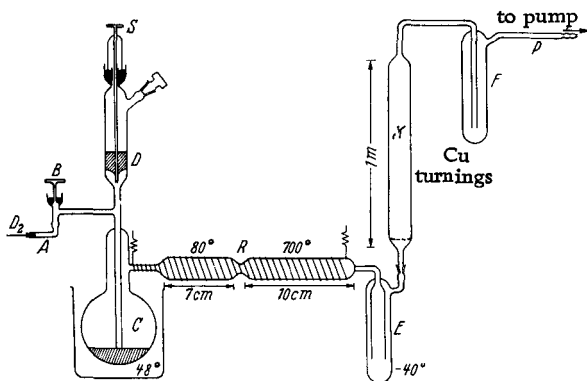
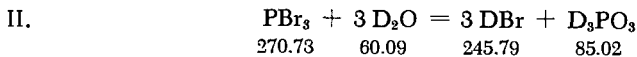

Fig. 98. Preparation of DBr. *B*) Hg seal stopcock, lubricated with graphite-phosphoric acid; *D*) bromine storage vessel; *C*) reaction flask; *R*) Vycor tube filled with porcelain chips; *E*, *F*) condensation traps; *K*) column with Cu turnings.

small pieces of porcelain and wound with heating wire so that the front part is heated to 80°C and the back to 700°C. Here, 99% of the D₂ is converted to DBr. Excess Br₂ is separated in trap *E*, kept at -40°C, and in column *K* filled with clean copper turnings. The DBr, condensed in the liquid nitrogen-cooled receiver *F*, can be purified several times by repeated fractional distillation in high vacuum (see purification of DI, p. 133, as well as method II). The yield is almost quantitative.



The vacuum-sealed ampoules with the starting materials are broken by vigorous shaking in an evacuated 5-liter flask closed by a ground glass stopper with a stopcock. To complete the deuterolysis, the mixture is left standing in the dark for two days, with occasional shaking. The reaction should not be accelerated by heating or disproportionation ($4 \text{D}_3\text{PO}_3 = 3 \text{D}_3\text{PO}_4 + \text{PD}_3$) will occur, and the DBr will be contaminated with PD₃. After sealing the flask to a high vacuum system, the impure gas is condensed in a receiver cooled with liquid nitrogen and purified by fractional distillation, using a low-temperature distillation flask (see Part I, p. 69).

Unlike method I, only half of the deuterium feed is converted to desired products.

Deuterium bromide is stored either as a liquid at a low temperature or as a gas in a sealed glass flask. Pure DBr reacts with Hg only on long exposure.

III. Aqueous solutions of heavy hydrobromic acid can be obtained by condensation of DBr in D₂O.

SYNONYM:

Heavy hydrogen bromide.

PROPERTIES:

Formula weight 81.93. Chemical properties analogous to those of HBr. In the presence of H⁺, exchange occurs. M.p. -87.5°C, b.p. -67°C; *t*_{CR} +88.8°C.

REFERENCES:

- I. C. L. Wilson and A. W. Wylie. J. Chem. Soc. (London) 1941, 596.
- II. K. Clusius and G. Wolf. Z. Naturforsch. 2a, 495 (1947).

Deuterium Iodide

DI

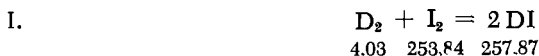

The glass apparatus of Fig. 99, in which all the joints are fused, is used. The 5-liter flask *A* contains some platinum sponge or platinized asbestos (see section on Platinum Metals) which is initially calcined for a few hours in high vacuum (evacuate through *C*) at 450°C. Dry, H₂-free air (in order to prevent adsorption of light hydrogen on the platinum) is allowed to flow in and 35 g. of carefully purified iodine (see that section) is added to the flask through *C*. Evacuation is then resumed until all of the air is displaced by I₂ vapor. Pure D₂ (see above) is then introduced by means of a Toepler pump, until a pressure of 120 mm. is reached. The system is then melt-sealed at *C*. The flask is heated in an air bath for six hours at 370°C; over 90% of the D₂ is converted to DI. The impure gas is separated from the

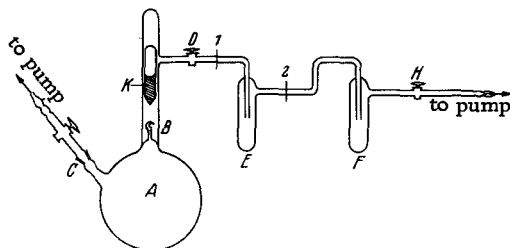

Fig. 99. Preparation of DI. *A*) 5-liter flask with catalyst; *B*) break-seal valve; *K*) seal breaker; *E*, *F*) condensation traps; 1,2) sealing points.

unconverted starting materials by fractional distillation. For this purpose, the right part of the apparatus, separated from the reactor by the seal *B*, is evacuated with stopcocks *H* and *D* open. Then *D* is closed and the tip at *B* is broken by moving the glass-covered iron slug *K* with an electromagnet. Trap *E* is chilled with liquid nitrogen and *D* can then be opened. With stopcock *H* closed, the contents of *A* are distilled into *E*. Next, the system is melt-sealed at 1 and evacuated briefly through *H*, and distillation from *E* to *F* is repeated, whereupon *E* is warmed to -79°C with a Dry Ice bath and *F* is cooled with liquid nitrogen. Finally, the tube is sealed off at 2. The DI contained in *F* is pure white, i.e., completely free from elemental iodine.

Deuterium iodide can only be stored in condensed form at low temperature.

Other preparative methods:

II. $P + 5I + 4 D_2O = 5 DI + D_3PO_4$. The readily formed side products PD_3 and PD_4I contaminate the DI. The method utilizes only about half of the deuterium introduced.

III. Solutions of heavy hydriodic acid are obtained by reaction of D_2S with iodine in the presence of D_2O : $D_2S + I_2 = 2 DI + S$.

Deuterium sulfide is introduced with shaking into an ice-cooled suspension of I_2 in D_2O placed in a closed recirculating glass apparatus with all joints melt-sealed. Unconverted D_2S is reintroduced into the reaction mixture. The heavy hydriodic acid formed is separated from the precipitated sulfur by filtration (in the absence of air) and separated from the dissolved D_2S by prolonged evacuation.

PROPERTIES:

Formula weight 128.93. Chemical properties analogous to HI. Deuterium is replaced by hydrogen in the presence of H^+ . M.p. $-52.0^\circ C$, b.p. $-36.2^\circ C$; $t_{CR} +148.6^\circ C$.

REFERENCES:

- I. D. Rittenberg and H. C. Urey. J. Amer. Chem. Soc. 56, 1885 (1934); J. R. Bates, J. O. Halford and L. C. Anderson. J. Chem. Phys. 3, 415 (1935).
- II. K. Clusius and G. Wolf. Z. Naturforsch. 2a, 495 (1947).
- III. H. Erlenmeyer and H. Gärtner. Helv. Chim. Acta 19, 146 (1936).

Deuterium Sulfide

D_2S

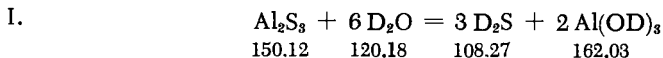

To prepare Al_2S_3 (see the section on Aluminum), a stoichiometric mixture of C.P. Al powder and C.P. S is placed in a sulfur-lined Hessian clay crucible. The commercial Al powder used must be washed several times with pure benzene to remove all oils; it is then heated for some time to $150^\circ C$ in high vacuum. The reaction mixture is ignited with the help of a Mg strip (caution—very violent reaction!) and the crucible is covered. The Al_2S_3 product is crushed while still hot, placed in ampoules, and degassed for several hours in high vacuum at 150 to $180^\circ C$. The

ampoules are sealed in vacuum. The D_2O reagent is also placed in small ampoules and carefully degassed in vacuum, and the ampoules are sealed.

To make D_2S , 20 g. of Al_2S_3 and 7 g. of D_2O in sealed ampoules (the excess Al_2S_3 is an excellent drying agent for the product gas) are placed in a 5-liter flask with a ground glass stopper provided with a stopcock. After evacuation to about 10^{-4} mm., the stopcock is closed and the connection to the vacuum source is sealed off. The ampoules are broken by shaking the flask, starting evolution of the gas. Heavy water vapor, which may condense in the upper part of the flask, is made to react by warming the walls or by coating them with unreacted Al_2S_3 . The flask is left standing in the dark, with occasional shaking, for about one week. After this, it is sealed to a vacuum system provided with several traps for fractional condensation (see Part I, p. 67 f.). Small amounts of D_2 are separated from the impure gas by condensing with liquid nitrogen and fractionating by repeated slow distillation (bath liquids; Dry Ice mixture and liquid nitrogen). The D_2S is then pure enough not to attack metallic Hg even after several weeks of contact. The yield is somewhat lower than stoichiometric.

The product may be stored in condensed form at low temperature or as a gas over dry paraffin oil.

II. *Other preparative methods*: Decomposition of CaS with D_2O in the presence of $MgCl_2$.

PROPERTIES:

Formula weight 36.10. Chemical properties analogous to H_2S . In solvents containing H^+ , deuterium is replaced with hydrogen. M.p. $-86^\circ C$, $t_{cr} +99.1^\circ C$.

REFERENCES:

- I. M. Fonzès-Diacon. Comptes Rendus Hebd. Séances Acad. Sci. 130, 1314 (1900); preparation of Al_2S_3 : A. Kruis and K. Clusius. Z. phys. Chem. B38, 156 (1937); see also H. Erlenmeyer and H. Gärtner. Helv. Chim. Acta 19, 146 (1936); O. E. Frivold, O. Hassel, et al. Phys. Z. 39, 224 (1938); 38, 191 (1937).
- II. T. Larsén. Z. Phys. 111, 391 (1938).

Deuteriosulfuric Acid

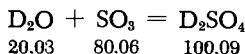

All joints of the glass apparatus, shown schematically in Fig. 100, are fused. Two ampoules, F_1 and F_2 , contain SO_3 , carefully pre-

purified by sublimation. The ampoules are placed in glass vessels A_1 and A_2 on top of sealed-in test tubes S_1 and S_2 so that their tips are directly below the glass-covered slugs K_2 or K_3 . This placement of ampoules on "stems" eases the job of the glass blower who must fuse the joints of the apparatus. After evacuation

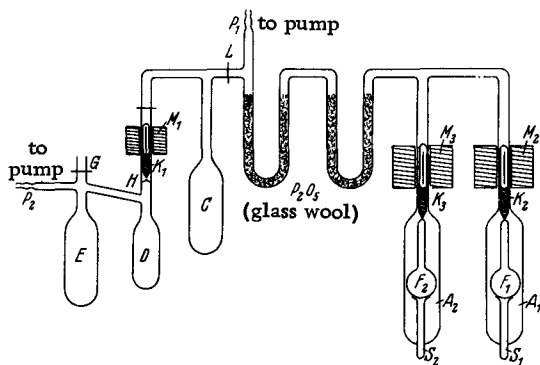

Fig. 100. Preparation of D_2S . F_1 , F_2) ampoules containing SO_3 ; A_1 , A_2) containers for SO_3 ampoules; K_1 , K_2 , K_3) seal breakers; M_1 , M_2 , M_3) electromagnets; H) break-seal valve; C , D , E) receivers (can be cooled); G , L) sealing points.

and sealing off at P_1 , ampoules F_1 and F_2 are broken by manipulation of K_2 and K_3 with the electromagnets M_2 and M_3 . The SO_3 passes through two U tubes filled with P_2O_5 -glass wool and is condensed in C by means of a Dry Ice bath. During this sublimation the left part of the apparatus, which is separated by the glass barrier H , is filled with D_2O through G and that inlet sealed, and the D_2O is frozen in E by means of a Dry Ice bath. The system is then evacuated at P_2 and sealed off by fusion. After the sublimation of the SO_3 , the tubing is also fused at L . The barrier H is now broken with the glass-encased iron slug K_1 moved by electromagnet M_1 , with the glass splinters falling into receiver D . The SO_3 is then condensed on the D_2O in E by slow heating of C . After careful melting of the reaction mixture, deuteriosulfuric acid of any desired concentration is obtained in E . The concentration is regulated by the proportion of D_2O and SO_3 . The yield is quantitative, based on D_2O .

The product is stored in glass vessels.

PROPERTIES:

Colorless liquid, with an oily consistency. Chemical properties analogous to H_2SO_4 ; the deuterium is ionic and exchangeable with light hydrogen. This should be kept in mind when mixing with solvents containing H^+ . Miscible with water in all proportions.

REFERENCE:

F. Fehér. Ber. dtsch. chem. Ges. 72, 1789 (1939).

Deuteroammonia

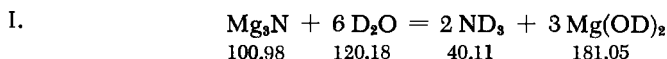
 ND_3 

The one-piece glass apparatus shown in Fig. 101 is used. The three U tubes are filled with 30 g. of Mg_3N_2 (see section on Magnesium for preparation), sealed to each other, and degassed at 400°C for some time in high vacuum. Meanwhile, flask *P*, separated from the rest of the apparatus by the glass wall *D*,

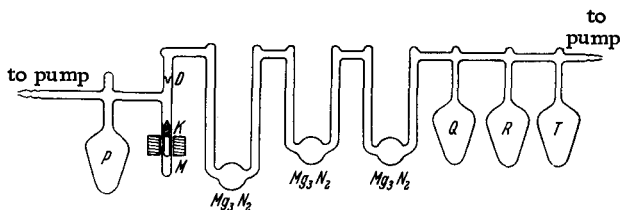

Fig. 101. Preparation of ND_3 . *P*, *Q*, *R*, *T*) receivers (can be cooled); *D*) break-seal valve; *K*) seal breaker; *M*) electromagnet.

is filled with 7 g. of D_2O which is freed of air by repeated freezing and melting in high vacuum. An excess of Mg_3N_2 will thoroughly dry the product gas. After both vacuum connections are fused, *Q* is cooled with liquid nitrogen and barrier *D* is broken by moving the glass-encased iron slug *K* with the electromagnet. Reaction between D_2O and Mg_3N_2 starts immediately, and the ND_3 formed condenses in *Q*. When the D_2O from *P* is completely evaporated, the U tubes are heated for some time by fanning with a flame. The product collected in *Q* is sublimed twice in high vacuum to free it from D_2O . To accomplish this, *R* is cooled

with liquid nitrogen and Q is warmed in a Dry Ice bath to -78°C . Then the connection between Q and R is sealed off, R is warmed to -78°C , and T is cooled with liquid nitrogen. The yield is almost quantitative, based on D_2O .

The product may be stored in condensed form at low temperatures or as a gas over Hg.

II. Aqueous solutions of heavy ammonia are prepared by condensing ND_3 in D_2O in high vacuum.

PROPERTIES:

Formula weight 20.05. Chemical properties analogous to NH_3 . In the presence of solvents containing H^+ , deuterium is replaced by hydrogen. M.p. -73.6°C , b.p. -31.1°C , $t_{\text{CR}} +132.3^{\circ}\text{C}$.

REFERENCES:

- A. Smits, G. J. Muller and F. A. Kröger. *Z. phys. Chem.* **B38**, 177 (1937); see also A. B. Hart and J. R. Partington. *J. Chem. Soc. (London)* **1943**, 104; O. E. Frivold, O. Hassel and S. Rustad. *Phys. Z.* **38**, 191 (1937); J. M. A. de Bruyne and C. P. Smyth. *J. Amer. Chem. Soc.* **57**, 1203 (1935).

Deuterophosphoric Acid

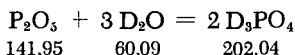

In the Simon and Schulze method, heavy phosphoric acid is prepared via the gas-phase reaction of pure D_2O and P_2O_5 in vacuum, using an apparatus consisting of flasks connected with

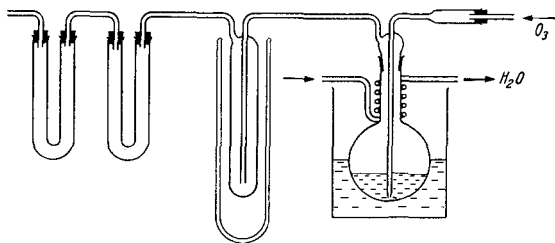

Fig. 102. Preparation of deuterophosphoric acid solution.

ground joints. The approximately 53% D_3PO_4 solution formed in the process is refluxed for 6.5 hours to produce orthophosphoric acid. Atmospheric moisture is blocked by a P_2O_5 tube on the condenser. The escaping D_2O is recovered by freezing it out in a trap cooled with a Dry Ice-ether bath, which is inserted between the condenser and the P_2O_5 tube.

The condenser is then replaced with an adapter provided with an inlet and an outlet tube (see Fig. 102) and O_3 is passed through the acid solution for one hour. During this treatment, the flask is kept in warm, $70^\circ C$ water. Most of the D_2O vapor produced is retained in the flask by chilling the neck with a condenser coil. Small amounts of vapor which escape are condensed in a trap. Two tubes filled with P_2O_5 shield against atmospheric moisture.

The purified 53% D_3PO_4 solution is concentrated to 83% at $45^\circ C$ in the apparatus shown in Fig. 195 (p. 543). No pyro acid should be produced at this temperature. The course of the concentration is observed by weighing the cooling trap. Further concentration by evaporation is impossible because partial conversion to the pyro acid occurs.

The purity of the acid thus prepared may be ascertained from a pure yellow precipitate of silver phosphate, which does not discolor even upon boiling.

REFERENCE:

A. Simon and G. Schulze. *Z. anorg. allg. Chem.* 242, 326 (1939).

Hydrogen Peroxide

M. SCHMEISSER

Hydrogen Peroxide

Staedel [1] was the first to describe a method, later altered in various ways by others [2-6], according to which 30% H_2O_2 solution is distilled to remove most of the water, the residual H_2O_2 is crystallized by cooling, and the crystals are separated from the mother liquor.

A 500-ml. distilling flask is provided with a standard male ground joint, onto which is placed a female glass cap, equipped with a distillation capillary. The side tube of the capillary is connected with ground joints to a spiral condenser, which empties into a receiver of about 200-ml. capacity. After the introduction of 180 ml. of Perhydrol (stored in bottles coated with paraffin wax), the flask is placed on a water bath (45 to 50°C) and the material is distilled over a period of about 3.5 hours at a pressure of 16 to 22 mm. Thus, about 150-160 ml. of water and some H_2O_2 are removed. The residue contains approximately 98% H_2O_2 . The volume of water to be distilled may be marked off on the previously tared receiving flask. (If the temperature of the water bath rises above 52°C, the concentrated H_2O_2 turns yellow and should be discarded.) The concentrated product may be removed from the flask without any danger of decomposition. (If a female ground joint were to be used at the neck of the flask, the decomposition on the rough surface would be appreciable.)

Further work-up to obtain 100% H_2O_2 is carried out in the following manner: A short, large-diameter test tube of 25-30 ml. capacity, coated inside with paraffin or ozokerite wax, is half filled with concentrated H_2O_2 , closed off with a paraffin-coated rubber stopper, and cooled at -35°C for half an hour. Meanwhile, seed crystals are prepared by freezing about 1 ml. of the same H_2O_2 in liquid nitrogen. (For the melting-point diagram of the system H_2O_2 - H_2O , see [7].) Colorless, needle-shaped crystals form immediately after seeding. After waiting for about a minute, the

crystals are quickly transferred to a precooled (-30°C) centrifuge tube such as that shown in Fig. 103. Following a brief centrifugation (either by hand or in a manually operated centrifuge) the crystals are transferred into another large-diameter test tube and remelted. In order to shorten the melting process, the tube with the H_2O_2 is placed in a beaker of warm water (30°C). When all the crystals have melted, the peroxide is again cooled to -35°C . On standing in the cold bath for about 10 minutes, the colorless, needle-shaped crystals re-form, usually spontaneously, and are again immediately separated from the mother liquor by centrifuging in an identical tube. If crystallization does not occur spontaneously, seeding is repeated.

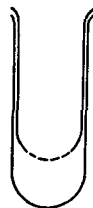

Fig. 103. Centrifuge tube for pure hydrogen peroxide.

The resultant crystals decompose very easily at room temperature, liberating O_2 . They are therefore stored in closed paraffin-coated containers, which must be kept cold.

The aqueous H_2O_2 solutions separated by centrifuging may be reconcentrated by distillation.

A single crystallization of the approximately 98% product in the test tube, followed by separation of the mother liquor, yields a product which is only about 99% pure.

According to Hurd and Puterbaugh [8], 80-90% H_2O_2 starting material can also be obtained by mixing 30% H_2O_2 solution with twice its amount of p-cymene, followed by distillation of the mixture at 50°C , using an aspirator vacuum. Most of the water and p-cymene is thus removed. After mechanical separation of the remaining p-cymene- H_2O_2 mixture, further processing is carried out as described above.

Additional preparative methods: For the preparation of H_2O_2 of spectroscopic purity, the process reported by Fehér [9] for D_2O_2 can be referred to. This process is based on the work of Pietzsch and Adolph [10] and involves the reaction of persulfate with steam.

A method for the production of single crystals of H_2O_2 has been described by Fehér [11].

PROPERTIES:

Formula weight 34.016. M.p. -1.7°C , b.p. (extrapolated) 157.8°C ; d(liq.) (0°C) 1.46, d (solid) 1.64.

REFERENCES:

1. W. Staedel. Z. angew. Chem. 15, 642 (1902).
2. H. Ahrle. Thesis, Darmstadt, 1908; J. prakt. Chem. 79, 139 (1909).
3. J. d'Ans and W. Friedrich. Z. anorg. allg. Chem. 73, 326 (1912).

4. O. Maas and W. H. Hatcher. J. Amer. Chem. Soc. 42, 2548 (1920).
5. E. Haschke. Thesis, Königsberg, 1943.
6. F. Fehér. Private communication.
7. O. Maas and O. W. Herzberg. J. Amer. Chem. Soc. 42, 2569 (1920).
8. C. D. Hurd and M. P. Puterbaugh. J. Amer. Chem. Soc. 52, 950 (1930).
9. F. Fehér. Ber. dtsh. chem. Ges. 72, 1789 (1939).
10. A. Pietzsch and G. Adolph. German Patents No. 241,702; 243,366; 256,148; 293,087.
11. F. Fehér and F. Klötzer. Z. Elektrochem. 43, 822 (1937).

Fluorine, Hydrogen Fluoride

H. von WARTENBERG

FluorineF₂

Fluorine is produced at present either by electrolysis of molten KHF_2 , being liberated at a graphite anode between 200 and 300°C (slight contamination by CF_4), or from molten $\text{KF} \cdot 3 \text{HF}$ at a Ni anode at approximately 100°C, according to the method of Lebeau (if the melt contains water, contamination by O_2). The latter method is the most tractable and has been tested extensively. The only suitable vessel materials are Fe (which develops a rust coating on the surface), Cu and Mg. The salt is available in a pot made entirely of brazed Cu with about 2-mm. wall thickness (Fig. 104). The cover rests lightly on three pieces of CaF_2 , placed in the upper trough, and held in place by a layer of cement. Alternatively, the cover rests on a gasket cut from 5-mm.-thick soft rubber sheet, which in turn rests on the flat lip of the pot. To slow down the penetration of humid air into the trough, the latter is also packed with CaF_2 powder. The anode, made of 3-mm. nickel wire, is attached only at its extreme end. Therefore, greater service life is obtained by coiling the electrode or attaching to it a 1-cm. nickel rod. Thus, the useful life of an electrode may be extended to the electrolysis of approximately two complete salt batches. After that, a new anode can easily be inserted into the connecting copper adapter. The melt usually spatters and creeps up the walls. This is the reason for placing the insulation so high in the thick-wall Cu adapter, which is cemented into the upper tube with litharge-glycerol. This adapter should preferably be taken out with strong pliers at the end of each electrolysis cycle and thoroughly washed. The sturdy fluorite stopper is secured with the same cement. It is even simpler to use a one-hole rubber stopper, coated with polytrifluorochloroethylene oil. The anode is surrounded by a copper or, better, a nickel tube. Three struts extend downward from the tube and are attached, by keyed copper connections, to a Cu plate. This plate acts as protection against

the H_2 rising from the wall of the pot. The pot serves as the cathode. This is the best arrangement since it leaves a large free cross section for the electrolyte salt. The Cu tube may become coated with an insulating layer of fluoride, which, however, sometimes dissolves if the temperature rises too high, making it necessary to replace the tube from time to time. The tube cannot be replaced with sintered alumina, which dissolves in the melt. This inconvenience is unfortunately encountered with all apparatus for production of fluorine. In order to generate the F_2 under a

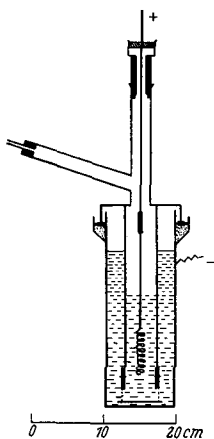

Fig. 104. Preparation of fluorine.

pressure of about 10 cm. of water, the pot is intentionally made tall. The outlet tubing must be at least 6 mm. inside diameter, since some electrolyte particles are always entrained with the gas. A single electrolysis batch requires 1.2 kg. of difluoride of the highest purity and 300 g. of freshly distilled, anhydrous HF. The apparatus is put on a hot plate which is placed on an ordinary platform scale, making it easy to determine from the loss in weight (300 g.) whether refilling is necessary and to avoid unnecessary overshooting of the temperature. At the beginning of the preparation a horizontally directed Bunsen flame is used as auxiliary heat, so that the salt is melted and heated to $70^{\circ}C$ in half an hour (attach a thermometer). No heat is applied during the electrolysis, which proceeds at about ten volts and about 4-5 amp. (with Ni rod anodes, 6 amp. yields

40 ml. of F_2 /min.). The hot plate serves only to keep the contents of the pot in the liquid state during interruptions in the run. After electrolyte depletion, the cover is removed and the residual salt is allowed to solidify while the container is being rotated, thus creating a cavity (work under a hood, wearing goggles; p_{HF} at $150^{\circ}C$ is 130 mm.). Fresh HF is added to the cavity, the vessel is covered with a piece of Cu sheet, and the HF is left to be absorbed by the salt overnight. After heating to $90^{\circ}C$, the cover with the anode can be replaced. In order to remove the small amounts of HF, the product gas is first led through a 10×50 mm., Dry Ice-cooled Cu bottle brazed to a tube of poorly heat-conducting nickel-silver alloy ($p_{HF} \sim 1$ mm.) and then through a Cu tube filled with granular NaF and provided with copper plug valves. Detection of F_2 in the exit stream (as well as at leaks) is easy. A jet of illuminating gas or a rag soaked in machine oil and attached to a wire will ignite on contact with F_2 . If the salt mass has been well dried, the traces of water disappear completely after the first hour of electrolysis. Any O_2 which may be formed cannot be

separated from the F_2 ; it may be determined, although not conveniently, by shaking with Hg [2].

With the packing materials now on the market, for example, Teflon, it is easy to build similar equipment made of somewhat thicker sheet copper or of cast magnesium by using Teflon-insulated gaskets and tightening the apparatus with screws. When a Cu pot with 5-mm.-thick walls, 35 cm. high and 15 cm. in diameter, containing 5 kg. of KHF_2 , is used, a current of 5 amp. may be applied. The HF gas can then be fed almost continuously to the outer chamber, thus replacing the raw material as it is consumed.

PROPERTIES:

Atomic weight 19.00. M.p. $-223^\circ C$, b.p. $-187^\circ C$; d (liq.) 1.11, d (gas) 1.31 (air = 1). Fluorine does not attack quartz and very dry glass. For heating in a F_2 atmosphere, Pt tubes are used, or even better, sintered alumina tubes (up to $600^\circ C$), while Cu tubes are useful up to $350^\circ C$ and Ni to 600 or $700^\circ C$. Teflon or Kel-F is used as gasketing material and Kel-F grease is used for lubrication of stopcocks and ground joints.

For commercial apparatus, see [3, 4].

REFERENCES:

1. H. v. Wartenberg. Z. anorg. allg. Chem. 193, 409 (1930); 244, 337 (1940).
2. H. v. Wartenberg. Z. anorg. allg. Chem. 242, 408 (1938); H. Schmitz and H. J. Schumacher. Z. anorg. allg. Chem. 245, 221 (1940).
3. Ind. Eng. Chem., Ind. Ed. 39, 244-286 (1946).
4. Angew. Chem. 19, 256 (1947).

Hydrogen Fluoride

HF

Precautionary measures: Since hydrogen fluoride solutions, particularly when concentrated, cause extremely painful and protracted burns, a paste made of magnesium oxide with a little glycerol should be kept on hand when working with larger quantities. The eyes must be protected and rubber gloves must be worn.

I. CRUDE HYDROFLUORIC ACID [1]

Laboratory preparation of this material will almost never be undertaken. To obtain 0.25 kg. of HF, 1 kg. of finely pulverized fluorite or, even better, cryolite (for Si-free HF) is vigorously

heated with 2.25 to 2.5 kg. of 97.5% As-free H_2SO_4 in a small autoclave placed on an air bath. A lead tube 1.5 meters long and 2 cm. in diameter, with an attached Liebig condenser, is soldered to the cover. Run duration, 4 hours. The product is collected in a copper flask cooled with ice-salt mixture. Impurities: H_2SiF_6 , HCl , H_2SO_3 , H_2SO_4 , HSO_3F , Pb .

II. PURE, 35% HYDROFLUORIC ACID

This solution is commercially available in polyethylene bottles and is already quite pure. For further purification, it is distilled from a NaF -containing Pt retort into a Pt receiver, leaving behind the SO_4^{2-} and SiF_6^{2-} ions. A little PbCO_3 is added to remove the Cl^- ; this yields PbClF , which is insoluble in concentrated HF . An excess of PbCO_3 does no harm, even in the presence of H_2SO_4 . Organic material is removed only when KMnO_4 is added (dropwise).

Vessel materials: Pt, Ag, Cu, Mg (but not Pb), celluloid (may be easily shaped in warm water), polyethylene, paraffin, metal dishes coated with Bakelite, Teflon, etc. See also section on F_2 .

Boiling points of various $\text{H}_2\text{O}/\text{HF}$ mixtures are given in [4].

III. ANHYDROUS HYDROGEN FLUORIDE

Distillation of 1.2 kg. of anhydrous KHF_2 at 500°C yields 250 g. of HF . Technical grade KHF_2 is dissolved in warm water, some PbCO_3 is added to eliminate Cl^- , the K_2SiF_6 and PbClF are allowed to settle, and the clear solution is evaporated in Cu or Mg dishes until crystallization occurs. Alternatively, a quantity of hydrofluoric acid is divided into two equal parts, one of which is neutralized with K_2CO_3 , mixed with the other part and evaporated. Filter hot through a Cu funnel. The crystals which separate on cooling are allowed to drain and are dried initially on filter paper, at 100°C . Further drying must be carried out with great care at 130 to 140°C . A thin layer of crystals is placed on a Mg or Cu sheet turned up 1-2 cm. along the edges, and the sheet is placed on a large hot plate. After 2-3 days the crystals are ground in a coffee mill and dried for another day, after which they are stored in paraffin-coated glass bottles. The dust from the salt is disagreeable. The compound can be obtained more readily by decomposition of NaHF_2 , but the decomposition starts already drying, and NaHF_2 is therefore not recommended as a raw material.

Distillation is carried out in a Cu flask, 24 cm. high, provided with a conical ground stopper, 4 cm. in diameter, held in place with screw clamps (Fig. 105). The cone is lubricated with graphite-paraffin oil or Kel-F grease to prevent freezing of the joint. The 1-m.-long Cu tube must be 2-2.5 cm. in diameter, since salt is carried over and inconvenient plugging can occur in the middle of

the run. The glass condenser is gasketed with a piece of rubber hose, and to slow down the decomposition, a few turns of water-cooled tin tubing are wound on it. The Cu tube is allowed to stand in HCl/Br_2 until it is bright, or the initial HF fraction will be brown. The retort should be provided with a Cu thermowell, projecting upward for 5 cm. from the bottom and externally brazed in place, to accommodate a copper-constantan thermocouple. The retort is heated either on a multiple burner in an iron jacket or, preferably, in an electric furnace. Before filling it should be cleaned with HCl until bright and dried carefully in a stream of CO_2 . The Cu receiver (250 ml.) is connected by a special coupling (Fig. 106) and must be cleaned with HCl until bright. It is then dried and reduced in a stream of H_2 at 300°C . During distillation, use an ice-salt mixture (-10°C) for cooling. A second container provides protection against overflow. The retort is first heated slowly for approximately $3/4$ hour to about 400 to 500°C , that is until HF begins to drip into a Pt dish below (leave the screw coupling at E open). Vapor pressures of KF and HF are given in [6]. After about 10 ml. has been collected, a test is made to determine whether a strip of filter paper gelatinizes immediately. If so, the acid is anhydrous. Now the coupling at E is tightened (use pliers and rubber gloves) and the freezing bath is put in place. Raising of the temperature to 500°C must be accomplished with great care, since at that temperature KF begins to separate from the melt and violent evolution of HF also occurs [2]. The operation is decidedly more convenient if a thick-walled Cu capillary (shown with dotted lines) is brazed to the Cu tube. The capillary should dip about 2 cm. into a Hg pool in a Pt dish. If this is done, the couplings on the receivers may be tightened before the run and the first few milliliters allowed to drip from the capillary until the paper test shows the absence of water. The capillary may then be sealed off simply by raising the level of the mercury. Should the evolution of HF be too violent, excess HF can escape through the capillary, accompanied, of course, by noxious fumes.

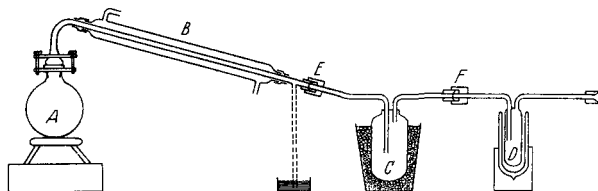

Fig. 105. Distillation of anhydrous hydrofluoric acid.

A) distillation retort (Cu); B) condenser (inner tube of Cu); C) receiver (Cu), -10°C ; D) second receiver, -10°C ; E, F) conical screw couplings.

The evolution subsides after about 3 hours and the heating is discontinued. Loosen *E* and *F* and close them off with Cu cones. If the distilled acid is to be stored, the tubes can be closed off at *E* and *F* with solid Cu cones equipped with screw caps. After cooling, the contents of the retort may be dissolved in boiling water and regenerated with aqueous HF.

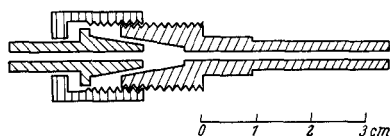

Fig. 106. Details of the conical copper coupling. The cones are interchangeable.

For regeneration, the solution is treated in a large Cu or Mg dish with sufficient pure, commercial (35-40%) HF to turn litmus completely red. The solution is then evaporated over an open flame but not to the point where spattering occurs. The salt mass is then crushed and dried as described previously.

The resultant HF still contains traces of entrained KF and can be redistilled at 30-35°C into the second receiver. For very pure HF, silver equipment should be used [2]. Since organic substances are immediately decomposed by HF vapor, joints can be made tight only by means of the Cu cones described. Alternatively fused sulfur may be used, with picein or a like substance covering cracks in the sulfur mass. As a temporary expedient, resulting in not quite anhydrous acid, the seal can be made with well-dried litharge-glycerol cement.

Liquid HF is available in steel tanks or cylinders. (Heat gently with flame to make it flow.)

In order to render the liquid HF completely anhydrous, fluorine may be bubbled through using a silver capillary. The F_2 gas decomposes traces of water. Thus a cylinder HF can be partially dried by somewhat loosening the main valve with a wrench in a cold room and then putting the cylinder in a container of appropriate height, filled with ice-salt mixture; after the cylinder has cooled down, the valve is removed completely and F_2 is bubbled through or half an hour from a fluorine cylinder through a silver capillary; the valve is then screwed back on and tightened with the wrench. The fluorine pressure produced in the usual laboratory generators is not sufficient for the HF cylinders. For all practical purposes, F_2 does not dissolve in liquid HF. Instead of using fluorine, the water may be removed by dropwise addition of thionyl chloride, which liberates gaseous HCl, SO_2 and SOF_2 , all insoluble in HF [K. Wiechert, Z. anorg. Chem. 261, 314 (1950)].

Pure HF for very small scale experiments be easily obtained (together with hydrogen) by placing a copper boat with well-dried PbF_2 in a platinum or copper tube in front of the compound to be reacted with the nascent HF. The boat is heated to red heat in a stream of hydrogen.

Conduits for HF gas are made of well-dried copper tubes provided with conical copper joints. In such tubes HF gas may be heated to 1000°C (of course, protection from the atmosphere must be provided). Sintered alumina tubes may be used up to 500°C . Copper caps, temporarily cemented on with litharge-glycerol, may serve as closures, but it is better to solder them onto the alumina tube. To accomplish this, the alumina tube is electrolytically coated with copper, and soft solder is used for attaching the caps. Completely anhydrous HF does not attack quartz. Lead and organic substances are destroyed, except for polymerized tetrafluoroethylene (Teflon) [5]. Copper (not brass) stopcocks or, preferably, platinum valves (Bodenstein design) serve to shut off the flow. It is advisable to make the stopcock body of copper and to turn out the plug from a Teflon block on a lathe. Such a plug turns easily and needs no lubrication.

PROPERTIES:

Formula weight 20.01. B.p. 19.5°C ; for b.p. at various pressures see [3]; m.p. -85°C ; d (liq.) 0.987. t_{CR} 188°C , p_{CR} 66.2 kg./cm.², d_{CR} 0.29.

REFERENCES:

1. O. Ruff. *Chemie des Fluors* [Fluorine Chemistry] Berlin, 1920, detailed description on the preparation of numerous compounds.
2. K. Fredenhagen. *Z. anorg. allg. Chem.* 178, 289 (1929); Ullmann, *Encyklopädie d. techn. Chem.* [Encyclopedia of Technical Chemistry] 3rd Ed., Vol. 7, p. 585 (1957).
3. K. Fredenhagen. *Z. anorg. allg. Chem.* 210, 220 (1933).
4. K. Fredenhagen. *Z. physik. Chem.* A 162, 464 (1932); Ullmann, *Encyklopädie d. techn. Chem.* [Encyclopedia of Technical Chemistry] 3rd Ed., Vol. 7, p. 585 (1957).
5. W. Hanford and R. Joyce. *J. Amer. Chem. Soc.* 68, 2082 (1946).
6. G. H. Cady. *J. Amer. Chem. Soc.* 56, 1431 (1934).

Fluorine Compounds

W. KWASNIK

General Remarks

In view of the special position occupied by fluorine among the halogens in the periodic system, the preparation of its compounds is so different from that of the other halogen compounds that it is fitting to consider the fluorine compounds in a separate section.

Inorganic fluorine compounds are prepared chiefly by the following methods:

1. Treatment of the oxides, hydroxides or carbonates with aqueous hydrogen fluoride. Most binary fluorides that do not undergo hydrolysis may be prepared in this way (e.g., alkali fluorides, alkali hydrogen fluorides, alkaline earth fluorides, AlF_3 , SbF_3 , ZnF_2 , PbF_2 , HgF , AgF).

2. Treatment of the appropriate anhydrous chlorides with anhydrous hydrogen fluoride (e.g., TiF_4 , ZrF_4 , NbF_5 , TaF_5 , VF_4 , SnF_4 , SbF_5 , POF_3 , SOF_2). This reaction is capable of much wider application than that given in the literature until now. This method has become increasingly important since anhydrous hydrogen fluoride became commercially available.

3. Treatment of elements, oxides or halides with elemental fluorine. This method is used chiefly for the preparation of those binary fluorides in which elements reach their highest valence (e.g., IF_7 , ReF_6 , UF_6 , SF_6 , BiF_5 , CF_4 , CoF_3 , AgF_2). The halogen fluorides may often be used instead of elemental fluorine. However, these fluorides can in turn be prepared only from elemental fluorine. There is a drawback in the use of halogen fluorides instead of elemental fluorine in that it is often difficult to separate the free halogen evolved in the reaction from the reaction product. On the other hand, most halogen fluorides are easier to handle in the laboratory (storage, measuring out) than elemental fluorine. Halogen fluorides are definitely to be preferred when, in addition to fluorine, one intends to add a second halogen to an unsaturated substance (e.g., COClF , COBrF , COIF , SO_2BrF). In general, halogen fluorides may be either more active (ClF_3) or less active (IF_5) fluorinating agents than the element itself.

4. Special reactions. These are so different from each other and occur so sporadically that they cannot be classified in any systematic way. For example, NF_3 may be prepared by electrolysis of molten ammonium hydrogen fluoride; OF_2 is produced by attack of F_2 on 2% sodium hydroxide solution; and O_2F_2 is formed from $\text{F}_2 + \text{O}_2$ in a glow discharge tube cooled with liquid nitrogen.

Some fluorine compounds may be prepared by any one of several methods (e.g., NOF from $\text{NO} + \text{F}_2$ or from $\text{NOBF}_4 + \text{NaF}$), so that the choice of a method of preparation may be based on the availability of starting materials or apparatus.

The preparation of organic fluorine compounds also requires methods different from those used for the other organic halogen compounds. Because of the high heat of formation of CF_4 (231 kcal.) and HF (64 kcal.), the treatment of organic substances with fluorine results mainly in the formation of CF_4 and HF , in addition to charred and tarry substances, while no appreciable quantities of normal substitution products are obtained. This method, which is used in industry for the production of perfluorocarbons, is not suitable for work on a laboratory scale. Organic fluorine compounds are prepared in reasonable yields chiefly by the following procedures.

1. Addition of HF to olefins (e.g., ethyl fluoride).

2. Treatment of a chlorine compound with anhydrous hydrogen fluoride (e.g., benzotrifluoride). This method is limited to compounds with three fluorine atoms on the carbon atom. Acid fluorides can also be produced from acid chlorides, using anhydrous hydrogen fluoride.

3. Treatment of chlorine compounds with antimony(III) fluoride (F. Swarts). This method is especially suited for compounds with less than three F atoms on the carbon atom (e.g., 2,2-difluoropropane).

4. Treatment of chlorine compounds with anhydrous hydrogen fluoride in the presence of antimony catalysts. This method is intermediate between the two mentioned above and is very broadly applicable (e.g., dichlorodifluoromethane).

5. Treatment of a halogen compound with a metal fluoride, such as AgF , HgF , HgF_2 (e.g., fluoroform).

6. Diazotization with nitrite in hydrofluoric acid medium. This method is used for the preparation of aromatic fluorine compounds (e.g., fluorobenzene).

7. Thermal decomposition of diazonium borofluorides (G. Balz and G. Schiemann). This procedure is also applicable to aromatic fluorine compounds, particularly on the laboratory scale (e.g., p-fluorotoluene).

The laboratory equipment of the fluorine chemist is unusual in that ordinary chemical glassware cannot be used in most cases. Apparatus made of nickel, iron, copper, lead, silver, platinum, fluorspar or sintered alumina is used instead. Where transparency is indispensable, quartz equipment is utilized.

To be able to produce fluorides at any time and avoid lengthy preparations, it is advisable to have on hand the following commonly used pieces of equipment:

- several nickel, fluorspar or sintered alumina boats;
- a nickel or Monel reaction tube (30 cm. long, 2.5 cm. diameter) with ground joints at both ends;
- an iron reaction tube;
- several cylindrical iron vessels;
- three to five quartz traps with attached ground joint seals;
- three Pyrex glass traps with attached ground joint seals;
- several quartz drying tubes;
- several quartz U tubes;
- two iron condensers;
- an iron trap;
- several steel cylinders, 0.5- to 5-liter capacity (for storage of gaseous fluorides).

For work with low-boiling fluorides it is useful to have on hand a part-glass, part-quartz vacuum system provided with a spiral quartz manometer.

Connection of the various parts of a quartz apparatus is best accomplished with normal, ungreased ground joints, which are made airtight by an exterior layer of cement (picein). Metal-to-quartz ground joint connections may also be made airtight with picein, but to ensure better adhesion of the cement the metal surface should be very hot. Stopcocks should be greased only lightly, preferably with viscous fluorocarbons; in difficult cases they may be replaced by copper diaphragm valves. Metal pieces may be connected with one another by means of threaded joints, flanges or ground joints. Lead rings with asbestos inserts or soft iron or copper washers may all be used as gaskets where flange connections are used. Needle valves with a steel stem, brass seat and lead-asbestos packing have proven suitable for use with steel cylinders and autoclaves.

Fluorspar apparatus is made by the following method: freshly precipitated CaF_2 is mixed with water to a thick paste. To obtain plasticity, hydrochloric acid is added until the acidity of the paste is about 0.02N. It is then poured into plaster molds. Two-part molds are used for boats, three-part molds for tubing. After removal from the molds, the pieces are scraped smooth with a spatula if necessary and then air dried for a few days. Since the strength is low, all subsequent handling must be very careful. If the fluorspar apparatus cannot be fired together with ordinary ceramic ware in a tunnel kiln at about 1250°C , then it should be fired in a Globar furnace. The pieces, embedded in ZrO_2 , are placed in a porcelain tube and the oven is slowly heated to 1250°C . During the firing, dry nitrogen is passed through the porcelain tube to remove water vapor and carbon dioxide. Fluorspar equipment prepared in

this way is nonporous and smooth. It can be worked on a wet emery wheel. In general, however, it is brittle and must be handled with great care. As a result of drying and firing the pieces shrink by about 1/3 and this should be taken into account in the design. Boats can always be made without difficulty, whereas tubes (say, of 15-cm. length, 1.5-cm. I.D., 2-mm. wall thickness) sometimes undergo deformation if the furnace temperature is somewhat too high. [O. Ruff and A. Riebeth, *Z. anorg. allg. Chem.* 173, 373 (1928); O. Ruff and J. Fischer, *Z. anorg. allg. Chem.* 179, 166 (1929); O. Ruff and W. Kwasnik, *Z. anorg. allg. Chem.* 209, 113 (1932).]

When quartz or glass equipment is used, one must always bear in mind that the reaction products may be contaminated with fluoro-silicates or H_2SiF_6 . Under these conditions, gaseous fluorides often contain SiF_4 .

Gaseous fluorides condensed by means of Dry Ice or liquid oxygen* dissolve air in appreciable quantities, as do almost all low-boiling substances. Care must therefore be taken to remove the dissolved air by repeated distillation of the product under vacuum. The air dissolved in these low-boiling compounds may lower their melting point by as much as 20° .

General equipment of a fluorine laboratory should include large, high-suction hoods, rubber gloves, protective goggles, a gas mask, and an H_2-O_2 torch for work with quartz apparatus. Dry Ice and liquid oxygen are practically indispensable for the preparation of low-boiling fluorides. One should have a bottle of 10% ammonium carbonate solution ready in case of accident. Skin injuries caused by HF or fluorides should be bathed immediately with this solution or treated with compresses containing this solution. This treatment should be administered even before medical assistance and should be continued for half an hour.

Chlorine Monofluoride

ClF

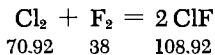

A vertical nickel or Monel cylinder encased in a furnace (Fig. 107) serves as reaction vessel. A metered stream of chlorine gas is introduced through a nozzle-type tube. Fluorine gas is fed

*Caution: liquid oxygen is dangerous in contact with oxidizable substances.

through a side tube. The lower part of the cylinder serves as a separator for the solid fluorides (NiF_2 , FeF_3) formed by corrosion of the container walls, so that plugging is avoided. The product gases are passed through a horizontal, tapwater-cooled iron condenser and through an iron trap immersed in Dry Ice (without acetone!), where chlorine and ClF_3 are condensed. The gases are then discharged into a second iron trap, immersed in liquid nitrogen. There the ClF is liquefied, while the excess fluorine escapes into the hood.

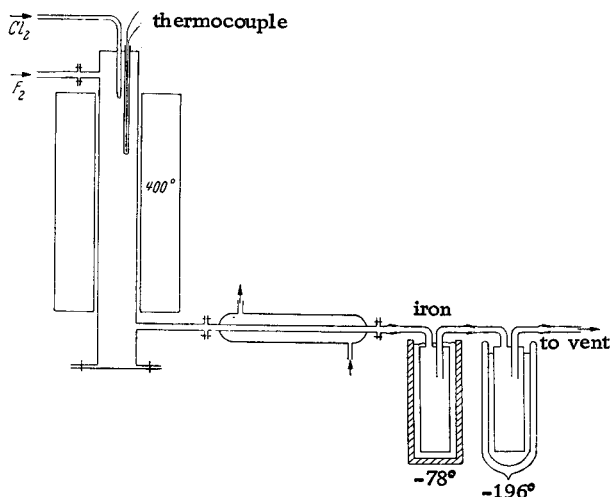

Fig. 107. Preparation of chlorine monofluoride.

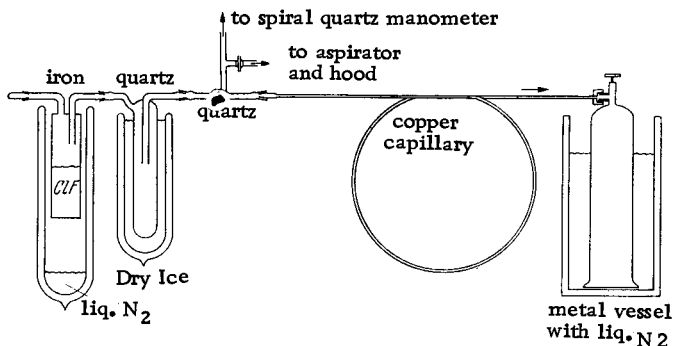

Fig. 108. Distillation of chlorine monofluoride.

The oven is heated to 400°C and F_2 is permitted to flow through the system until it is detected at the outlet of the apparatus through

ignition of an oil-soaked rag. The chlorine stream is then turned on. For a fluorine cell current of 70 amp., the rate should be 9 liters of Cl_2 /hr.

The chlorine monofluoride, still containing considerable amounts of ClF_3 and Cl_2 in solution, is collected in the trap cooled with liquid nitrogen.

After the fluorination is ended, the ClF is distilled into a steel cylinder. The arrangement of the distillation apparatus is shown in Fig. 108. The Dewar flask in which the feed vessel is placed is lowered away from the feed vessel as far as necessary to start the product boiling. The small forerun, consisting chiefly of F_2 , is removed by a water aspirator. Then the valve of the steel cylinder is opened and ClF is condensed at a rate such that the pressure in the system is maintained at about 1 atm. The distillation is ended as soon as sizable quantities of condensate (Cl_2 , ClF_3) accumulate in the quartz trap. The residue is also drawn off with the water aspirator. Yield 90% maximum, based on chlorine.

PROPERTIES:

Formula weight 54.46. Colorless gas, pale yellow liquid, white solid. Very reactive, destroys glass immediately and quartz in the presence of traces of moisture. Reacts vigorously with organic substances, usually with ignition. Very vigorous reaction with water. Attacks the bronchi very strongly.

M.p. -155.6°C , b.p. -100°C , $t_{\text{CR}} -14^\circ\text{C}$, d. (liq.) (-108°C) 1.67.

REFERENCES:

- O. Ruff, E. Ascher and F. Laas. *Z. anorg. allg. Chem.* **176**, 256 (1928).
 W. Kwasnik (unpublished).

Chlorine Trifluoride

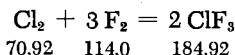

Chlorine trifluoride is prepared using the same apparatus and procedure as for ClF (Fig. 107, with the following exceptions, 1) The second liquid-nitrogen-cooled iron trap may be omitted (or left in the system without coolant). 2) The furnace is heated to 280°C instead of 400°C . 3) The chlorine flow rate is lower. For a 70-amp. current in the fluorine cell, a chlorine flow rate of

6.2 liters/hr. is advisable. If the ratio of fluorine to chlorine is too low, ClF will be the main product and the ClF₃ formed will be strongly contaminated with Cl₂.

After completion of the fluorination, the liquid ClF₃ is poured from the Dry Ice-cooled trap into a steel cylinder again cooled with Dry Ice (without acetone!) (use a good hood, protective goggles and rubber gloves) and a threaded shut-off valve is immediately screwed on. When the steel cylinder has warmed up to room temperature, an iron manometer and an additional valve are screwed on and the contents of the cylinder are allowed to escape until a gauge pressure of 1.2 atm. is reached. The ClF, Cl₂ and F₂ are thereby removed.

The yield is 60-80%, depending on the Cl₂:F₂ ratio; the remainder is always ClF.

Valves used for handling ClF₃ must be free of all grease. Lead asbestos is suitable as valve packing. Washers must be of copper. If liquid ClF₃ is inadvertently spilled, Dry Ice should be sprinkled over it; it absorbs the ClF₃ and dilutes it so as to render it relatively harmless.

PROPERTIES:

Formula weight 92.46. Colorless gas, suffocating odor; strongly attacks the bronchi. Extremely reactive, particularly as a liquid. Immediately destroys glass and, in presence of traces of moisture, quartz. Organic substances usually react with ignition. The reaction with water is explosive.

M.p. -83°C, b.p. 11.3°C, d. (liq.) (-78°C) 2.026.

REFERENCES:

- O. Ruff and H. Krug. Z. anorg. allg. Chem. 190, 270 (1930).
 W. Kwasnik. Naturforschung und Medizin in Deutschland 1939-1946 (FIAT-Review) 23, 168.

Bromine Trifluoride

BrF₃

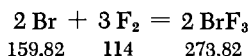

Bromine trifluoride is prepared by fluorination of bromine at +80°C. At this temperature appreciable quantities of BrF₅ are formed, which then react with the excess bromine according to the equation



thereby affording rapid and quantitative conversion of the bromine.

An inclined iron condenser (Fig. 109) serves as the reaction chamber. An iron tube, to which a dropping funnel is attached, opens into the condenser. The lower end of the condenser is joined to a wye (Y) adapter, preferably made of Monel. The adapter supports an iron reflux condenser at the top and its lower end is provided with a ground joint, to which the receiver (quartz) is connected.

Fluorine is passed through the apparatus; water at $+80^\circ\text{C}$ is fed to the inclined condenser and cooling brine at -18°C to the reflux condenser. Bromine is then added dropwise from the dropping funnel at such a rate that almost colorless BrF_3 is collected in the receiving flask. The reflux condenser prevents BrF_3 or BrF_5 from escaping with the fluorine stream.

At the end of the fluorination the receiver is heated for a short time to 100°C in order to remove any BrF_5 which might be dissolved. After cooling, the BrF_3 is poured into an iron vessel. The yield is quantitative, based on bromine, and 90%, based on fluorine. The purity is 98% (the remainder being BrF_5).

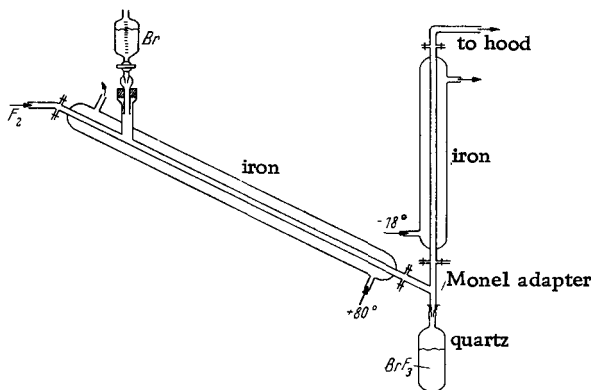

Fig. 109. Preparation of bromine trifluoride.

PROPERTIES:

Formula weight 136.91. Colorless liquid. Very reactive; fumes in air and strongly attacks the skin.

M.p. $+8.8^\circ\text{C}$, b.p. $+127^\circ\text{C}$; d. (liq.) 2.84. Crystal form: long prisms.

REFERENCE:

W. Kwasnik. *Naturforschung und Medizin in Deutschland 1939-1946* (FIAT-Review) 23, 168.

Bromine Pentafluoride

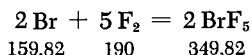

An iron reaction vessel is placed in a crucible furnace held at 200°C (Fig. 110). In addition to the inlet tube for F₂ and the outlet tube for BrF₅, the reaction vessel is provided with a thermometer well and a central wide T tube adapter, which holds a dropping funnel and permits the nitrogen to flow in from the side. (The nitrogen flow serves merely as a purge, to keep the fluorine penetrating the dropping funnel.) The gaseous reaction products are condensed in an iron condenser. The liquefied BrF₅ collects in an iron trap, which is cooled with an ice-salt mixture.

As soon as the apparatus is filled with fluorine, dropwise input of Br₂ into the reaction vessel is started. About one drop per second of bromine is introduced at a fluorine cell current of 150 amp. Care must be taken to maintain a steady excess of F₂.

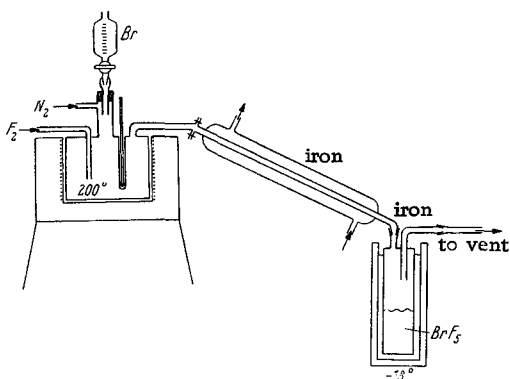

Fig. 110. Preparation of bromine pentafluoride.

The crude product consists of 95% BrF₅ and 5% BrF₃. After the fluorination is terminated, the product is distilled from an iron apparatus in a stream of fluorine. Condenser and receiver are cooled to about -18°C with an ice-salt mixture. The yield is 87%, based on bromine. Bromine pentafluoride is stored in iron or, preferably, in Monel vessels.

PROPERTIES:

Formula weight 174.91. Colorless liquid; fumes strongly in air. Completely stable up to 460°C.

M.p. -61.3°C , b.p. $+40.5^{\circ}\text{C}$; d. (liq.) (0°C) 2.57.

Very reactive; reacts with nearly all elements with ignition. Vigorous, nearly explosive reaction with water. At room temperature, dry glass is attacked slowly, quartz glass practically not at all. Mercury becomes coated with a brown film.

REFERENCES:

O. Ruff and W. Menzel, Z. anorg. allg. Chem. 202, 49 (1931).
W. Kwasnik (unpublished).

Iodine Pentafluoride

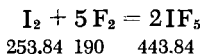

An iron drum (see Fig. 111) provided with a cooling jacket serves as reaction vessel. It connects to an inclined iron condenser, followed by two quartz traps.

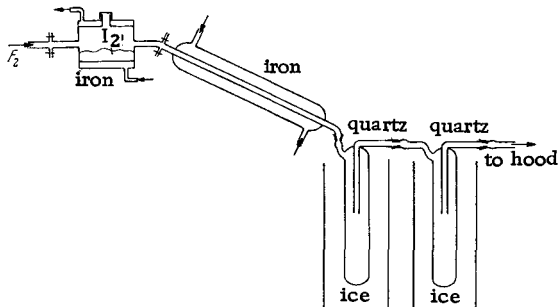

Fig. 111. Preparation of iodine pentafluoride.

The reaction vessel is filled with iodine, and F_2 (preferably HF-free) is passed through. The coolant removes the heat of reaction and prevents conversion of the IF_5 remaining in the vessel to IF_7 . As soon as F_2 is detected at the outlet of the system, the reaction should be terminated. Cooling of the reaction vessel is stopped, heat is applied with a gas burner so that the jacket serves as a water bath, and IF_5 is distilled off in a stream of fluorine. At a fluorine flow rate corresponding to a cell current of 80 amp., 10 hours are necessary for the conversion of 250 g. of iodine (including distillation). The yield is 90%, based on iodine.

Iodine pentafluoride is stored in iron flasks. It is well suited for the fluorination of organic compounds.

PROPERTIES:

Formula weight 221.92. Colorless liquid; fumes in air, reacts very vigorously with water.

M.p. $+9.6^{\circ}\text{C}$, b.p. $+98^{\circ}\text{C}$; d. (liq.) (15°C) 3.231, d. (solid) (0°C) 3.75.

REFERENCES:

F. Moissan. Bull. Soc. chim. France [3] 29, 6 (1930).

W. Kwasnik (unpublished).

Iodine Heptafluoride

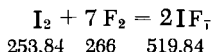

An iron cylinder provided with a cooling jacket (see Fig. 112) serves as the reaction vessel. The inlet opening is provided with a strainer to hold the iodine. The outlet opening has an appr. 30-cm.-long adapter to which an iron condenser is screwed on. An iron

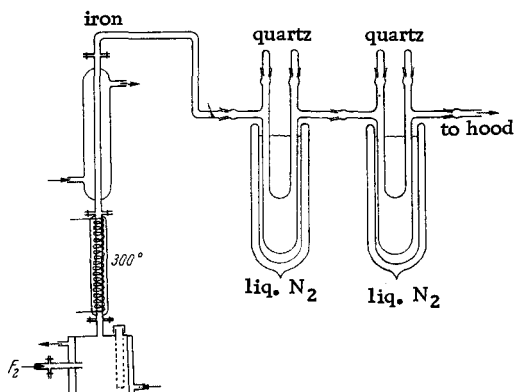

Fig. 112. Preparation of iodine heptafluoride.

tube leads from the latter to the U-shaped condensation traps. These are made of quartz and are closed at the top with loosely fitting quartz ground joints. The first U tube is used to trap the IF_7 , and

the second to exclude atmospheric moisture. Both tubes are cooled with liquid nitrogen.

The screen-type strainer in the reaction vessel is filled with iodine, and fluorine is passed through the system. The F_2 must be HF-free. This can best be achieved either by passing it through a Dry Ice-cooled iron coil or over freshly dehydrated KF. In the first stage of the reaction the iodine burns in the reaction vessel to IF_5 . While the reaction is in progress, a high water flow rate must be maintained in the cooling jacket. As soon as fluorine appears at the outlet of the system, the flow of water through the jacket is shut off, and the jacket is heated from the outside with a gas flame so that it acts as a water bath. The adapter above the reaction vessel is now electrically heated to about $300^\circ C$. The fluorine stream converts the IF_5 into IF_7 , which escapes through the vertical condenser into the quartz trap. This condenser must be very efficient so as to retain the unconverted IF_5 . At this stage of the reaction, fluorine must be present in excess.

The solid product collecting in the arms of the U tubes is melted down from time to time or pushed down with an iron wire. To do this, the ground stoppers must be removed for a few seconds.

The IF_7 is purified by distillation at atmospheric pressure and $+40^\circ C$ and is collected in quartz traps at $-196^\circ C$. The small residue is IF_5 , which is returned to the reactor. The IF_7 is then distilled into a steel cylinder. When the filled cylinder reaches room temperature, the valve is carefully opened, and the gas (chiefly SiF_4) is vented until a wad of alcohol-soaked cotton wool is ignited by the escaping IF_7 . The yield is 83%, based on iodine.

Ground joint connections easily freeze on contact with iodine fluorides. They should therefore be moved a little from time to time. The joints should not be greased nor should they be sealed with picein; they should only be loosely fitting.

PROPERTIES:

Formula weight 259.84. Colorless. In the solid state it appears as a loose powder, sometimes in the form of small crystals.

M.p. $5.5^\circ C$, subl. p. $4.5^\circ C$; d. (liq.) ($6^\circ C$) 2.8.

Very reactive. Similar in properties to ClF_3 , but considerably less reactive. Water dissolves gaseous IF_7 without detonation. Sodium hydroxide solution absorbs it with evolution of a large amount of heat. Sulfuric acid foams when IF_7 is bubbled through it. Attacks glass and quartz. Musty, acidic odor.

REFERENCES:

O. Ruff and R. Keim. Z. anorg. allg. Chem. 193, 176 (1930).
W. Kwasnik (not yet published).

Dioxygen Difluoride

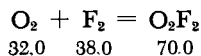

The gases are electrically excited in a discharge tube cooled with liquid nitrogen, and the unstable O_2F_2 thus formed is frozen out.

The fluorine is stored in a quartz trap cooled with liquid nitrogen and is aspirated into the apparatus through a copper diaphragm valve. If available, a steel cylinder with fluorine may be connected directly. The oxygen is also taken from a steel cylinder, which is connected to the system through an iron or copper capillary. The reaction vessel is a glass flask (see Fig. 113) immersed in a Dewar flask filled with liquid nitrogen; provisions are made for generation of a brush discharge. Copper wires, tightly cemented with picein into narrow glass tubes projecting about 10 cm. outside the apparatus, serve as electrodes. The gas discharge is generated by a large induction coil with either a Wehnelt interrupter or an a.c. transformer, whose secondary supplies 0.05 amp. at about 5000 v. A wide-arm quartz U tube is attached to the discharge tube. After completion of the reaction it serves as distillation receiver and storage container. A quartz trap, cooled to -196°C

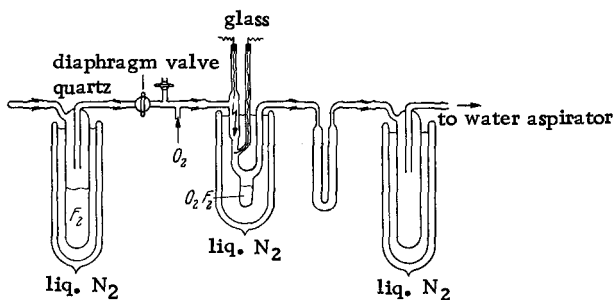

Fig. 113. Preparation of dioxygen difluoride.

to prevent access of atmospheric moisture, is attached to the U tube. A metal aspirator is best for the generation of a vacuum. A manometer for the measurement of the vacuum is not necessary, since the shape of the gas discharge gives a good indication of the vacuum attained. The best operating pressure range is 10-20 mm. In this range the discharge takes on a brushlike shape.

As soon as the Dewar flasks have been placed under the corresponding parts of the apparatus and the aspirator has been started,

the spark coil is switched on. The diaphragm valve is then carefully opened to allow fluorine to pass into the system. Only then is oxygen allowed to flow in, but at a lower than stoichiometric rate, for otherwise solid ozone (violet to blue) may form in the receiving flask. The O_2F_2 separates out on the walls of the discharge tube as a red-brown solid. From time to time the electric discharge is interrupted for a few minutes and the Dewar flask is lowered. This allows the O_2F_2 to melt and flow down into the lower tubular extension of the reaction vessel. If solid ozone is present, the melting should be done very carefully since explosions may sometimes occur.

As soon as enough O_2F_2 has accumulated in the bottom tip of the discharge tube, the spark coil is disconnected and the oxygen and fluorine streams are turned off. The U-shaped storage vessel is cooled with liquid nitrogen and the Dewar flask is removed from beneath the discharge tube. The O_2F_2 distills over (at about 15 mm.) with partial decomposition. To minimize decomposition, care should be taken not to let the O_2F_2 temperature exceed $-60^\circ C$ for more than a short time during the distillation. The O_2F_2 may be redistilled several times in this manner to ensure purity. The first cuts are mainly ozone and SiF_4 . Since the distillation always results in accumulation of O_2 and F_2 , the aspirator should be kept continuously in operation. For the same reason, difficulties are encountered in the distillation of O_2F_2 into ampoules.

After distillation is completed, the U-shaped storage vessel is melt-sealed at the bottom sections of the arms. Dioxygen difluoride can be stored only in liquid nitrogen. In emergencies, Dry Ice may be used.

PROPERTIES:

Brown gas, cherry-red liquid, and orange solid.

M.p. $-163.5^\circ C$, b.p. $-57^\circ C$; d (liq.) ($-57^\circ C$) 1.45, d (solid) ($-165^\circ C$) 1.912.

REFERENCES:

- O. Ruff and W. Menzel. Z. anorg. allg. Chem. 211, 204 (1933).
 O. Ruff and W. Menzel. Z. anorg. allg. Chem. 217, 85 (1934).

Oxygen Difluoride

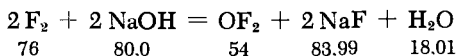

Fluorine gas is bubbled at a rate of 1 to 3 liters/hour from a platinum tube of appr. 2 mm. I.D. into a 2% solution of NaOH

contained in a glass reaction vessel. The NaOH solution flows through the reaction vessel at a rate of 1 liter/hour from an elevated storage container. The platinum tube dips about 2 cm. into the sodium hydroxide solution (Fig. 114).

The output gas mixture flows through wash bottle filled with water, which absorbs the unreacted fluorine. The OF_2 is then condensed in two glass traps immersed in liquid nitrogen.

After completion of the reaction, the crude product, condensed at -196°C in the traps, is evacuated with a water aspirator to a pressure of 20 mm., which removes the major portion of the oxygen dissolved in the OF_2 . To prevent simultaneous escape of the OF_2 into the atmosphere, a wash bottle containing KI solution is inserted before the aspirator. The OF_2 is then fractionated, with oxygen coming over first. The first distillation gives a 98.5% pure product. The yield is 45%, based on fluorine.

Oxygen difluoride is stored in glass flasks or steel cylinders.

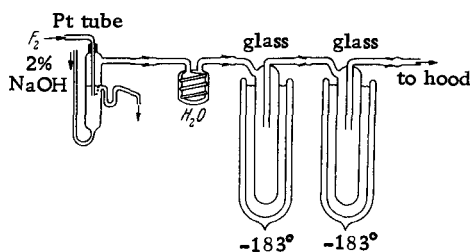

Fig. 114. Preparation of oxygen difluoride.

PROPERTIES:

Colorless gas; yellow, brownish-tinged liquid.

M.p. -223.8°C , b.p. -144.8°C ; $t_{\text{CR}} -58.0^\circ\text{C}$, $p_{\text{CR}} 48.0$ abs. atm, $c_{\text{CR}} 97.6$ ml./mole; d (liq.) (-223.8°C) 1.90, (-145.3°C) 1.521; ΔH (formation) -11 kcal. Solubility in water at 0°C : 6.8 ml. of gaseous OF_2 /100 ml.

Characteristic odor. Inhalation causes severe breathing difficulties, which often do not begin until several hours after inhalation and persist for hours. Does not attack glass. Reaction with water is hardly noticeable. Attacks mercury.

Stable to light, heat and electrical ignition. Remarkably unreactive compared to Cl_2O . Like all low-boiling fluorides, the liquid dissolves appreciable quantities of air.

REFERENCES:

- P. Lebeau and A. Damiens. *Compt. Rend. Hebd. Séances Acad. Sci.* 188, 1253 (1938).
 O. Ruff and W. Menzel. *Z. anorg. allg. Chem.* 190, 257 (1930).

Chlorine Dioxide Fluoride

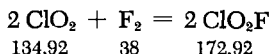

The apparatus, which must be made entirely of quartz, is set up as in Fig. 115. Fluorine flows at a rate of 500 ml./hr. into the first trap, in which a few milliliters of liquid ClO_2 at -50 to -55°C have been placed. The inlet tube dips a few millimeters into the liquid ClO_2 . The reaction progresses smoothly and steadily; most of the ClO_2F formed in the reactor remains there and only a small portion reaches the second trap. When the color of the liquid in the first trap becomes very faint, the reactor is allowed to warm and the ClO_2F is distilled into the second trap in a stream of fluorine, with gradually rising temperature. It collects as a pure, colorless substance requiring no further purification.

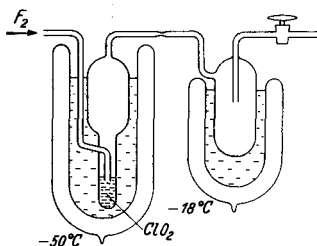

Fig. 115. Preparation of chlorine dioxide fluoride.

ClO_2 becomes a necessity and entails repeated rectification of the product.

According to M. Schmeisser, the procedure may be advantageously altered in the following way: ClO_2 is dissolved in CCl_3F at -78°C and fluorinated. The ClO_2F formed separates as a denser liquid phase when saturation is reached. The mixture is then cooled to -110°C and the less dense liquid phase is rapidly removed by vacuum through a capillary. The reaction may be performed in Pyrex glass apparatus. If absolutely pure ClO_2F is required, working in quartz apparatus without excess

SYNONYM:

Chloryl fluoride.

PROPERTIES:

Formula weight 86.46. Colorless, very sensitive to moisture, immediately forms a fog in moist air. Thermally much more stable than ClO_2 .

M.p. -115°C , b.p. -6°C .

REFERENCES:

- H. Schmitz and H. J. Schumacher. Z. anorg. allg. Chem. 249, 242 (1942).
 J. E. Sicre and H. J. Schumacher. Z. anorg. allg. Chem. 286, 232 (1956).
 M. Schmeisser and F. L. Ebenhöch. Angew. Chem. 66, 230 (1954).

Chlorine Trioxide Fluoride

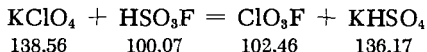

Ten grams of KClO_4 are dissolved in 100 g. of HSO_3F in a round-bottom glass flask provided with stirrer and reflux condenser. The reaction starts at 50°C and is complete at 85°C . The reaction gases are allowed to pass over a 10% sodium hydroxide solution containing 5% $\text{Na}_2\text{S}_2\text{O}_3$ and are then bubbled through a similar solution. The gas is dried with solid KOH and then condensed in a trap cooled with liquid nitrogen. During the reaction a stream of dry nitrogen is bubbled through the reaction mixture. The product contains 1% air and 0.4% CO_2 . This procedure is also suited to the production of ClO_3F in kilogram quantities.

SYNONYM:

Chloryl oxyfluoride.

PROPERTIES:

Colorless gas, with a characteristic odor reminiscent of OF_2 . M.p. -152.2°C , b.p. -48.1°C . Fairly stable thermally. May be heated in glass nearly to the softening point. Somewhat soluble in water. Reacts quite slowly with dilute aqueous alkali.

REFERENCES:

- G. Barth-Wehrenalp. J. Inorg. Nucl. Chem. 2, 266 (1956).

Chlorine Tetroxide Fluoride

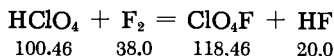

The apparatus (see Fig. 116) is best made of quartz. It consists of a cylindrical reaction tube appr. 50 cm. high, filled with quartz Raschig rings. The tube is surrounded by a cooling jacket fed with flowing water. The fluorine is introduced through a quartz tube reaching nearly to the bottom of the vessel, and 70% HClO_4 is added from a dropping funnel. The liquid is drained through a siphon, while the gaseous reaction products are drawn off by suction from the top of the reaction tube into a quartz trap immersed in liquid nitrogen. The system ends with a drying tube filled with anhydrous KF .

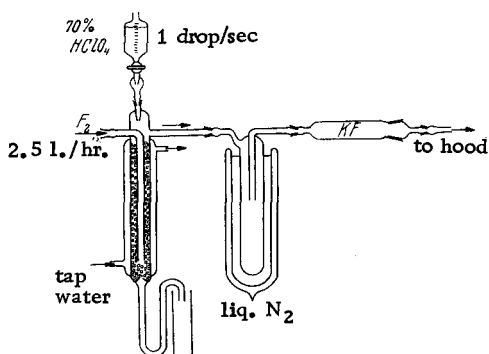

Fig. 116. Preparation of chlorine tetroxide fluoride.

The HClO_4 input is one dropper second, until the liquid begins to flow through the siphon. Fluorine is then introduced at a rate of 2.5 liters/hour. In addition to OF_2 , Cl_2 and SiF_4 , solid ClO_4F collects on the walls of the condensing trap. Because of the high explosion hazard, ClO_4F should never be made in quantities larger than 4 g. The product is purified by fractional vacuum distillation. It is stored in quartz ampoules cooled with liquid nitrogen. Explosions may easily occur when ClO_4F is melted and solidified. The yield is about 60%.

The highest yields (over 90%) are obtained with a platinum reaction vessel. Glass may be used as the apparatus material if other material is unavailable, but the product is then quite impure

and obtained in low yield. Carbon cannot be used as the construction material, since it catalytically decomposes ClO_4F .

PROPERTIES:

Colorless gas, very explosive; often explodes during melting or condensation. Gaseous ClO_4F explodes in a manner similar to NO_3F , through mere contact with dust, grease, rubber or 2N KI solution. In an open beaker, gaseous ClO_4F explodes upon contact with a flame or spark. It has a strongly acrid odor, irritates the throat and lungs, and causes persistent respiratory trouble.

M.p. -167.2°C , b.p. -15.9°C .

REFERENCES:

G. H. Rohrback and G. H. Cady. J. Amer. Chem. Soc. 69, 677 (1948).

Sulfur Tetrafluoride

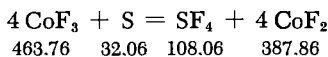

I. Sulfur (17 g.) is introduced into a quartz flask and covered with a layer of dry calcium fluoride powder (40 g., 0.025 to 0.05 mm. diameter grains), and 270 g. of CoF_3 is placed on top. The flask is connected with a short piece of tubing to a trap immersed in liquid nitrogen. This in turn is connected to a vacuum system. The apparatus is now evacuated and the quartz flask is shaken so that the two raw materials and the calcium fluoride are mixed together. Reaction begins during the mixing, with evolution of gas. The temperature is gradually raised to 130°C by means of an oil bath and maintained for two hours. A colorless product condenses in the trap during the run. This is subsequently fractionated, using a quartz spiral manometer to permit control at zero mm. gage. Sulfur hexafluoride (up to 6% of the total quantity) comes over in the first cut. The main cut is SF_4 , which contains small quantities of lower sulfur fluorides (SF_2 , S_2F_2). In order to obtain absolutely pure SF_4 , it is shaken with mercury in a platinum (not quartz) flask; this removes the lower sulfur fluorides. The degree of purity is ascertained by determining the molecular weight by the vapor density method. The boiling point is not decisive for estimating the degree of purity of SF_4 .

II. SF_4 may be obtained in smaller yields (40%), according to F. Brown and P. L. Robinson, by careful fluorination of sulfur with fluorine at -70°C ($\text{F}_2 : \text{N}_2 = 1 : 3$).

Sulfur tetrafluoride is stored in sealed quartz ampoules.

PROPERTIES:

Colorless gas, thermally stable up to -600°C ; reacts vigorously with water. Decomposed exothermally by concentrated H_2SO_4 . Attacks glass but not quartz or mercury.

M.p. -121.0°C , b.p. -40.4°C ; $d(\text{liq.})$ (-78°C) 1.95, (solid) (-183°C) 2.349. Readily soluble in benzene.

REFERENCES:

- I. W. Luchsinger. Thesis, Techn. Hochschule, Breslau, 1936, p. 23.
- II. F. Brown and P. L. Robinson. J. Chem. Soc. (London) 1955, 3147.

Sulfur Hexafluoride



The reactor is a nickel tube 300 mm. long and 25 mm. I.D. (Fig. 117) containing a nickel boat filled with sulfur. The ground joints of the reaction tube and of the quartz trap are best left ungreased and uncemented but only tightly compressed. The iron drying tube containing freshly dehydrated KF is for exclusion of moisture. The quartz trap is cooled with liquid nitrogen.

This apparatus is suitable for most fluorinations in which a solid raw material forms a gaseous fluoride (SeF_6 , TeF_6 , AsF_5 , CF_4 , GeF_4 , MoF_6 , WF_6). In the special case of SF_6 the apparatus may be made entirely of glass.

The sulfur burns with a bluish flame in the fluorine stream. The product collects in the condensation trap and is then passed

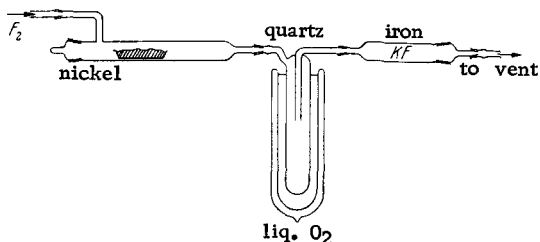
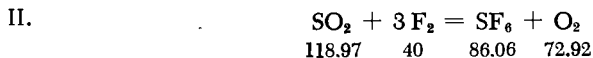

Fig. 117. Preparation of sulfur hexafluoride.

through fritted wash bottles containing hot 10% KOH (not NaOH) in order to remove impurities (HF, SF₂, SF₄, SOF₂, S₂F₁₀). Finally, the gas is dried in a P₂O₅ tube and is passed at room temperature over activated charcoal to remove S₂F₁₀. The yield is 87%.



Sulfur dioxide is burned with an excess of fluorine to SF₆ in the apparatus described for the preparation of COF₂ (p. 206 f). The temperature should be as high as possible, preferably about 650°C. The chief impurity in the crude SF₆ accumulating in the condensation trap is SO₂F₂. The SF₆ is passed through several fritted wash bottles filled with water and hot 10% KOH, and then dried over P₂O₅. The yield is 70%, based on SO₂.

Sulfur hexafluoride may be stored in a gasometer over water, in a glass flask provided with a stopcock, or, under pressure, in a steel cylinder.

PROPERTIES:

Colorless, odorless; thermally and chemically very stable.
M.p. -50.8°C (under pressure), subl. p. -63.8°C, t_{CR} +45.55°C,
p_{CR} 38.33 abs. atm; d (liq.) (-50.8°C) 1.88.
Very sparingly soluble in water, slightly soluble in alcohol.

REFERENCES:

- I. W. Klemm and P. Henkel. Z. anorg. allg. Chem. 207, 73 (1932).
- II. German Patent Application I. 72173 IV b/12 i, May 4, 1942;
W. Kwasnik, not yet published.

Thionyl Fluoride

SOF₂

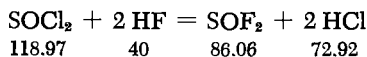

An iron bottle (Fig. 118) with a gas inlet tube serves as the reaction vessel. A second bottle is connected to the first, to retain the unreacted HF. This is joined to a glass gas trap immersed in liquid nitrogen or a Dry Ice-acetone bath. A drying tube filled with KF is attached to exclude atmospheric moisture.

The reaction vessel is filled with 500 g. of SOCl₂ and 50 g. of SbCl₅ (catalyst), and anhydrous gaseous HF is introduced through

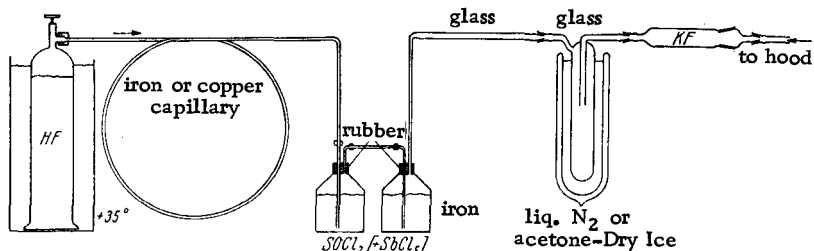

Fig. 118. Preparation of thionyl fluoride.

the inlet tube. The HF is thoroughly absorbed, causing a mixture of SOF_2 and HCl to be evolved, which then is collected in the condensation trap. The reaction is so endothermic that the outside of the reaction vessel gradually becomes covered with ice. When all the SOCl_2 has been consumed, more may be added without further addition of SbCl_5 .

Separation of the SOF_2 from the HCl may be achieved either by distillation or by rapid bubbling of the gas mixture through ice-cold water, in which HCl is completely absorbed, while the SOF_2 passes through with almost no decomposition. The gas is then dried over concentrated H_2SO_4 or over P_2O_5 .

Thionyl fluoride is stored under pressure in steel cylinders.

PROPERTIES:

Colorless gas, thermally stable up to red heat. Does not corrode Fe, Ni, Co, Hg, Si, Mn, B, Mg, Al or Zn below 125°C . Does not attack glass. Suffocating odor. Hydrolyzed very slowly in ice-cold water.

M.p. -110.5°C , b.p. -43.7°C , $t_{\text{CR}} +88^\circ\text{C}$; d. (liq.) (-100°C) 1.780, d. (solid) (-183°C) 2.095.

REFERENCES:

German Patent Application I. 53743 IV b/12 i.

J. Söll and W. Kwasnik, *Naturforschung und Medizin in Deutschland* 1939–1946 (FIAT-Review) 23, 192.

H. S. Booth and F. C. Merciola, *J. Amer. Chem. Soc.* 62, 640 (1940).

U. Wannagat and G. Mennicken, *Z. anorg. allg. Chem.* 278, 310 (1955).

Thionyl Tetrafluoride

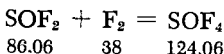

86.06 38 124.06

The apparatus (Fig. 119) is equipped with a nickel T tube for gas mixing. The T tube opens into a larger nickel tube, which is heated

in an electric furnace. The output reaction gases pass through two quartz traps. The product SOF_4 is frozen out in these traps at -196°C . The system ends in a drying tube filled with freshly dehydrated KF to exclude atmospheric moisture.

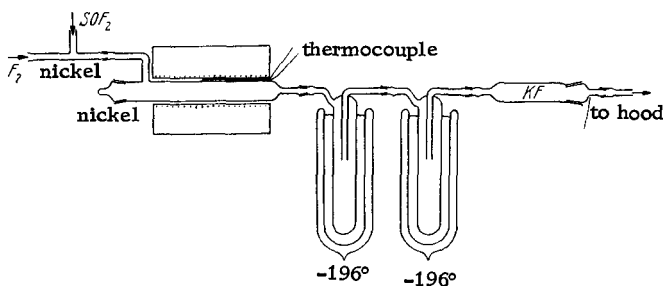

Fig. 119. Preparation of thionyl tetrafluoride.

This arrangement may be used for most fluorinations involving participation of two gases ($\text{NO} + \text{F}_2$, $\text{NO}_2 + \text{F}_2$, $\text{CrO}_2\text{Cl}_2 + \text{F}_2$, $\text{PF}_3 + \text{Cl}_2$).

A platinum wire-screen spiral is introduced into the reaction tube, and the furnace is heated to 150°C . If no screen is available, the reaction may still be carried out, but the furnace must then be held at 300°C . The reaction tube may be made of quartz, but nickel is definitely preferred. Fluorine and SOF_2 streams are mixed in a 1.1:1 ratio. An efficient way to do this is to calculate the quantity of F_2 per hour from the current load on the fluorine generator and to meter an appropriate quantity of SOF_2 per hour by means of a differential manometer flowmeter (cf. Part I, p. 85 or H. Lux, *Anorg. Chem. Experimentierkunst* [The Art of Experimentation in Inorganic Chemistry], Leipzig 1959, p. 450). Concentrated H_2SO_4 or, better, liquid paraffin are suitable as manometric fluids. The SOF_4 collects as a white solid in the condensation traps.

After completion of the reaction, the SOF_4 is purified by fractional distillation in a quartz apparatus.

Thionyl tetrafluoride is stored under pressure in steel cylinders or in glass ampoules cooled with Dry Ice or liquid nitrogen.

PROPERTIES:

Colorless gas, pungent odor. Highly exothermic reaction with water with formation of SO_2F_2 . Completely absorbed by NaOH solution. Pure SOF_4 does not attack glass.

M.p. -99.6°C , b.p. -48.5°C , $d(\text{liq.}) (-82^\circ\text{C}) 1.946$, $d(\text{solid}) (-183^\circ\text{C}) 2.55$.

REFERENCES:

- O. Ruff and H. Jonas. *Naturforschung und Medizin in Deutschland 1939—1946 (FIAT-Review)* 23, 192.
 German Patent Application R100449.
 H. Jonas. *Z. anorg. allg. Chem.* 265, 273 (1951).

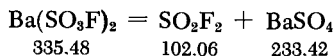
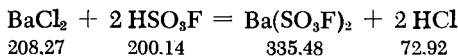
Sulfuryl Fluoride

Barium chloride is dehydrated by heating to 200°C and then pulverized. The powder (100 g.) is added little by little to 100 g. of HSO₃F, placed in an ice-cooled iron vessel (about 500-ml. capacity) with a screw lid and a gas outlet tube. The reaction is very vigorous, and a stream of HCl is evolved. As soon as all the BaCl₂ is added, the lid is screwed on and the vessel heated at 100°C until no more HCl vapor escapes. The iron vessel is then connected to a water aspirator and heated to 120–150°C under vacuum, to remove any excess of HSO₃F and the last traces of HCl.

A glass gas trap is now connected to the gas outlet tube and immersed in liquid nitrogen while the iron vessel is further heated. Decomposition of the barium fluorosulfonate begins at 400°C and becomes vigorous at 450–500°C.

The condensate accumulating in the trap is then passed through a wash bottle containing warm KMnO₄ solution (to remove SO₂), then through a second wash bottle with concentrated H₂SO₄, then through a drying tube containing P₂O₅, and finally is again condensed in a trap at –196°C. The product is now distilled, and the first and last cuts discarded. The yield is 60%, based on BaCl₂.

Sulfuryl fluoride is stored in a gas holder over concentrated H₂SO₄ or compressed into steel cylinders.

PROPERTIES:

Colorless, odorless gas, thermally stable up to 400°C; chemically very unreactive, not hydrolyzed by water, dissolves fairly rapidly in alkali hydroxide solution, with complete hydrolysis.

M.p. –121.4°C, b.p. –49.7°C; d. (liq.) about 1.7.

Solubility at 16.5°C

in water:	4- 5 ml. gaseous SO ₂ F ₂ /100 ml.
in alcohol:	24- 27 ml. gaseous SO ₂ F ₂ /100 ml.
in toluene:	210-220 ml. gaseous SO ₂ F ₂ /100 ml.
in CCl ₄ :	136-138 ml. gaseous SO ₂ F ₂ /100 ml.

REFERENCE:

M. Trautz and K. Ehrmann. *J. prakt. Chem. (N.S.)* 142, 91 (1935).

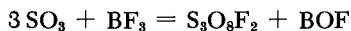
Trisulfuryl Fluoride

240.618	67.82	262.18	45.82
---------	-------	--------	-------

Liquid SO₃ is saturated with BF₃. The liquid becomes cloudy due to formation of a precipitate which is difficult to filter. The reaction mixture is then treated with 70% sulfuric acid, while being cooled with ice, and a heavy, colorless liquid phase separates. This is washed with concentrated H₂SO₄; it is then of reagent grade.

PROPERTIES:

Fumes in air, insoluble in concentrated H₂SO₄, hydrolyzes very slowly in dilute potassium hydroxide because of formation of a salt film of K₂SO₄ and KSO₃F at the contact area.

B.p. 120°C (dec.); d₂₅²⁵ 1.86.

REFERENCES:

H. A. Lehmann and L. Kolditz. *Z. anorg. allg. Chem.* 272, 73 (1953).

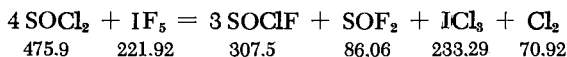
Thionyl Chloride Fluoride

A flask provided with a reflux condenser and a dropping funnel (all made of quartz) is filled with 60 g. of SOCl₂, and 45 g. of IF₅ is slowly added dropwise from the funnel. Heat is evolved and the color darkens. The gases escaping through the reflux condenser

are collected in a quartz trap immersed in liquid nitrogen. At the outlet of the system there is a drying tube, filled with anhydrous KF.

The product condensed in the gas trap is greenish-yellow from the entrained ICl_3 . It is distilled over antimony powder or mercury until colorless. It is then fractionated, with SiF_4 , HCl and SOF_2 coming over first and SOCl_2 last. The fraction collected between 10 and 18°C (760 mm.) is SO_2ClF . The yield is about 42%, based on SOCl_2 .

Thionyl chloride fluoride is best stored in glass ampoules cooled with liquid nitrogen; for short periods it may, if necessary, be kept at room temperature in glass flasks or steel cylinders.

PROPERTIES:

Colorless gas; decomposes at room temperature into SOCl_2 + SOF_2 ; choking odor similar to the sulfur fluorides. Disproportionates at room temperature in contact with Cu and Hg, and with Fe above 70°C. Water and sodium hydroxide solution cause hydrolysis. Does not attack glass.

Broad melting range between -110 and -139°C (mixture of two isomers), b.p. 12.3°C; d. (liq.) (0°C) 1.576.

REFERENCES:

- O. Ruff and H. Jonas. *Naturforschung und Medizin in Deutschland 1939—1946 (FIAT-Review)* 23, 192.
 German Patent Application R 100449.
 H. Jonas. *Z. anorg. allg. Chem.* 265, 273 (1951).

Sulfuryl Chloride Fluoride

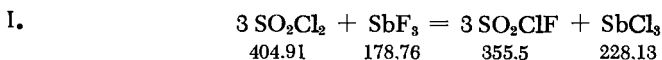

The reaction vessel is a one-liter autoclave or steel cylinder with a screwed-on water-cooled reflux condenser. The condenser is equipped at its upper end with a spring-type manometer and a blowoff valve. The equipment must be able to withstand a pressure of 10 atm. gage.

The blowoff valve is connected to two quartz traps immersed in liquid nitrogen. At the outlet there is a drying tube with anhydrous KF to exclude atmospheric moisture.

The reaction vessel is filled with 220 ml. (365 g.) of SO_2Cl_2 , 187 g. of finely divided SbF_5 , and 40 ml. of SbCl_5 (catalyst).

Heat is gradually applied up to 300°C, whereby a pressure of 7 atm. gage builds up. The reaction gases are allowed to escape slowly into the quartz traps by slowly opening the valve until the pressure in the reaction vessel is 6.3 atm. gage. In this way, about 80 ml. of condensate collects in the traps within two hours.

The product is then distilled, with HCl and SO₂ coming over as the first fraction while the last cut consists of unconverted SO₂Cl₂. The yield is 50 ml. of pure SO₂ClF.

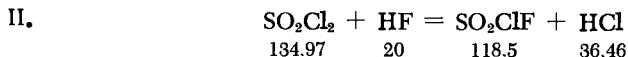

Technical grade SO₂Cl₂ (900 g.), 130 g. of anhydrous HF, 200 g. of SbF₃, and 40 ml. of SbCl₅ are introduced into an autoclave equipped with a fractionating column, and the contents are heated to 250-300°C. A pressure of 40 to 50 atm. gage builds up and is maintained by slowly releasing HCl through the water-cooled column. The reaction is complete after two to four hours of heating. The SO₂ClF is distilled from the autoclave into quartz traps, as described in method I. The SbCl₅ catalyst may be reused. The yield is 80 to 85%, based on SO₂Cl₂.

Sulfuryl chloride fluoride is stored in steel cylinders or glass flasks.

PROPERTIES:

Colorless gas, pungent odor similar to SO₂Cl₂, does not fume in air, reacts rapidly with water and alkali hydroxide solution, does not attack mercury or brass. Pure SO₂ClF does not attack glass. M.p. -124.7°C, b.p. 7.1°C; d. (liq.) (0°C) 1.623.

REFERENCES:

- I. H. S. Booth and V. Hermann. J. Amer. Chem. Soc. 58, 63 (1936).
- II. German Patent Application I. 53743.

Sulfuryl Bromide Fluoride

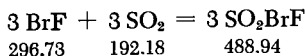
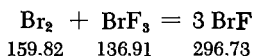

The rate of SO₂BrF formation depends upon the rate at which the following equilibrium is established: Br₂ + BrF₃ = 3 BrF.

Sulfur dioxide (120 g.) is gradually distilled at +12°C into an iron autoclave containing a mixture of 20 ml. of bromine and 21.2 ml. of BrF₃. After letting stand for several days, during which the autoclave is shaken once daily, the product is distilled from the pressure vessel and collected in a quartz trap at -196°C. For purification, the SO₂BrF is passed through a wash bottle filled with mercury (removal of traces of bromine and BrF₃), then over NaF (removal of HF), and finally over P₂O₅ (removal of water). The product is then fractionated and the first cut discarded. There is no residue. The yield is 88%, based on BrF₃.

Sulfuryl bromide fluoride is stored by melt-sealing in quartz ampoules.

PROPERTIES:

Formula weight 162.98. Colorless compound, choking odor similar to SO₂Cl₂, thermally stable, reacts slowly with glass at room temperature, unreactive with quartz. Reacts vigorously with water (hydrolysis). On contact with moist air, it acquires a slightly reddish color due to liberation of bromine.

M.p. -86°C, b.p. 40°C; d. (liq.) (0°C) 2.17, d. (solid) (-183°C) 3.16.

REFERENCES:

- O. Ruff and H. Jonas (in collaboration with W. Kwasnik). *Naturforschung und Medizin in Deutschland 1939-1946* (FIAT-Review) **23**, 193.
 H. Jonas, *Z. anorg. allg. Chem.* **265**, 273 (1951).

Fluorosulfonic Acid

HSO₃F

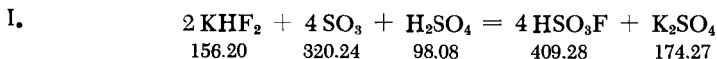

Dried, powdered KHF₂ (20 g.) is added with stirring and in small portions to 40 ml. of fuming sulfuric acid (about 60% SO₃) in a platinum or aluminum dish well cooled with ice-salt mixture. A viscous mass is obtained, which fumes in air. It is then slowly heated to 100°C to drive off unreacted SO₃ and HF.

The fluorosulfonic acid is then distilled in a glass apparatus with ground glass joints by gradual heating to 250°C. The acid is completely pure after a double distillation. The yield is 85%.



By means of a capillary made of type 304 stainless steel and dipping below the surface of the liquid, 200 g. of HF is added to 800 g. of

SO₃, kept at 30-35°C in an aluminum vessel. The absorption of HF is rapid but not explosive. The mixture is then heated to 100°C to drive off the excess SO₃ and HF.

The product is distilled twice in an aluminum apparatus.

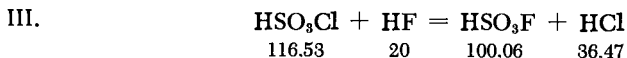

A silver distillation flask equipped with a silver dropping funnel is placed in an ice-salt bath. Anhydrous HF (50 g.) is distilled into the flask through the side arm. A copper drying tube filled with KF is then attached to the side arm, in order to absorb the entrained HF. Then HSO₃Cl is introduced from the dropping funnel into the flask. The reaction starts immediately and a uniform stream of HCl is given off. After completion of the reaction the excess HF and HCl are removed in a stream of dry air, while slowly heating to 110°C. The residue left in the flask is chlorine-free HSO₃F.

When very pure, HSO₃F may be stored by sealing into glass ampoules. Otherwise, it should be stored in aluminum vessels.

PROPERTIES:

Colorless liquid, completely stable up to 900°C. Reacts explosively with water. Fumes in air. At room temperature does not attack S, C, Se, Te, Pb, Ag, Cu, Zn, Fe, Cr or Mn, but does react with Sn with mild evolution of gas. Mercury is also slightly attacked. Rubber, cork and sealing wax are rapidly destroyed. Vigorously attacks S, Pb, Sn and Hg at higher temperatures. Reacts exothermically with acetone to give a dark red-brown color (color test for fluorosulfonic acid). Reacts with benzene and chloroform, splitting off HF. Ether reacts exothermically and with effervescence to form the ethyl ester. If pure, does not attack glass.

M.p. -87°C, b.p. 163°C; d. (liq.) (18°C) 1.740.

REFERENCES:

- I. J. Meyer and G. Schramm. Z. anorg. allg. Chem. 206, 25 (1932).
- II. German Patent Application I 52953 IV b/12 i, August 6, 1935.
- III. H. Weichert. Z. anorg. allg. Chem. 261, 310 (1950).

Potassium Fluorosulfinate

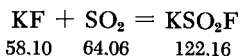

One kilogram of anhydrous, finely divided KF is slowly stirred at room temperature for five days with 2 kg. of liquid SO₂ in a

4-liter, agitated iron autoclave. Following that, the excess SO_2 is flushed out; about 2 kg. of 95% KSO_2F is obtained. The procedure may be altered in the following way: the KF is placed in the autoclave, a steel cylinder containing liquid SO_2 is connected via a capillary, the air in the autoclave is displaced by SO_2 , and the outlet valve of the autoclave is closed. When the agitator is started, there is vigorous absorption of the SO_2 by the KF . After about 1 kg. of SO_2 has been taken up, the rate of absorption begins to fall off.

Potassium fluorosulfinate may be used as "activated potassium fluoride." It reacts with many inorganic and organic acid halides to give the respective fluorides and may therefore often be used as a fluorinating agent in place of anhydrous HF (e.g., preparation of SOF_2 , PF_3 , POF_3 , AsF_3 , $\text{C}_6\text{H}_5\text{COF}$).

PROPERTIES:

Colorless solid, decomposes at $170\text{--}180^\circ\text{C}$. Solubility in liquid SO_2 (0°C) 3.85 mg./100 g. Dissolves in water with hydrolysis. Forms sulfuryl fluoride with Cl_2 , Br_2 or F_2 .

REFERENCE:

F. Seel and L. Riehl. *Z. anorg. allg. Chem.* 282, 293 (1955).

Selenium Hexafluoride

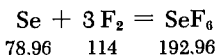

Selenium is fluorinated in the apparatus described for SF_6 (p. 169), which in this case may be made entirely of glass. The Se ignites in the fluorine stream without external heating. The reaction tube must be cooled from time to time. The product that accumulates in the condensation trap at -196°C is then passed through a fritted wash bottle containing 10% aqueous KOH and is dried over P_2O_5 . Finally, the SeF_6 is completely purified by fractionation.

Selenium hexafluoride may be stored in glass flasks or in a gasometer over water.

PROPERTIES:

Colorless gas, thermally very stable. Does not corrode glass, attacks mercury slightly. When inhaled, causes breathing difficulties and heart seizures.

M.p. -34.8°C , subl. t. -46.6°C , $t_{\text{CR}} 72^{\circ}\text{C}$; d. (liq.) (-10°C) 2.108, d. (solid) (-195°C) 3.478.

REFERENCES:

W. Klemm and P. Henkel. Z. anorg. allg. Chem. 207, 74 (1932).

Selenium Tetrafluoride

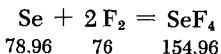

Selenium, dried at 200°C , is spread in a shallow layer in a large-diameter reaction vessel of glass or quartz. The vessel is ice cooled. A fluorine-nitrogen mixture (1 : 1 ratio) is passed over the solid at a rate of 1 liter/hour. Efficient cooling and careful fluorination are important, since otherwise SeF_6 is formed. Finally, the liquid product is vacuum distilled.

PROPERTIES:

Colorless liquid, miscible with sulfuric acid, alcohol, ether and IF_5 . Dissolves NaF , KF , RbF , CsF and TlF with formation of the complex MSeF_5 . Water decomposes SeF_4 vigorously. Forms HgSeF_4 when refluxed with mercury for several hours. Slowly attacks Pyrex glass.

M.p. -9.5°C , b.p. 106°C ; $d^{25} 2.72$.

REFERENCES:

E. E. Aynsler, R. D. Peacock and P. L. Robinson. J. Chem. Soc. (London) 1952, 1231.
R. D. Peacock, J. Chem. Soc. (London) 1953, 3617.

Tellurium Hexafluoride

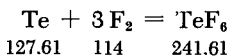

Tellurium is fluorinated in the apparatus described for SF_6 (p. 169), which in this case may be entirely of glass. The reaction

is exothermic, but ignition does not usually occur if the reaction is moderated with external cooling.

The product collecting in the trap at -196°C is fractionated. Preliminary washing of the gas with potassium hydroxide solution is not feasible since TeF_6 is hydrolytically cleaved by alkali.

Tellurium hexafluoride may be stored in glass flasks.

PROPERTIES:

Colorless gas, unpleasant odor, chemically not quite as inert as SeF_6 and SF_6 . Slowly but completely hydrolyzed by water. Attacks mercury. Causes breathing difficulties and heart seizures. After inhalation, the well known disagreeable odor of tellurium is noticeable.

M.p. -37.6°C , subl. t. -38.9°C , t_{CR} 83°C ; d. (liq.) (-10°C) 2.499, d. (solid) (-191°C) 4.006.

REFERENCES:

W. Klemm and P. Henkel. *Z. anorg. allg. Chem.* 207, 74 (1932).
D. M. Yost and W. H. Claussen. *J. Amer. Chem. Soc.* 55, 885 (1933).

Nitrogen Trifluoride

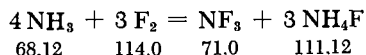

Nitrogen trifluoride is made by electrolysis of molten NH_4HF_2 , during which NH_3 is fluorinated by nascent fluorine.

Chlorine-free NH_4HF_2 , as dry as possible, is electrolyzed in an electrolytic cell such as that described for the preparation of F_2 (see section on Fluorine). The temperature is maintained at 130 - 140°C . Acheson graphite is used as the anode. The operating current is 10 amp., resulting in a voltage of 7 to 9 v. The current density at the anode is 0.05 to 0.1 amp./ cm^2 . (The current density does not influence the yield.)

The reaction gases from the electrolytic cell are passed through an iron drying tube containing freshly dehydrated KF to remove entrained HF and water. The apparatus ends in an iron drying tube containing KH.

After the start of the electrolysis, only solid, partly colorless, partly violet or blue products (N_2O , N_2O_3 , O_3) condense in the traps in the first few hours (or days), depending on the amount of moisture in the electrolyte. Explosions caused by ozone may

sometimes occur at the start of the electrolysis, and this must be taken into account. The rate of deposition of solids drops as the electrolysis removes the moisture from the melt, and increasing amounts of colorless, liquid NF_3 begin to appear. However, the yield of NF_3 , based on the current, never rises above 30% of theoretical.

It should be borne in mind that the nature of the products of electrolysis depends strongly on the anode material. Swedish graphite generates only N_2 , whereas aluminum carbide or nickel anodes produce only fluorine gas from the same melt.

American graphite yields a maximum of 30% NF_3 , arc carbon 16%, and carbon welding electrodes 18%. Various carbon anodes must be tried before optimum results are obtained.

The reaction mixture, condensed in the traps as a slurry, is first washed with potassium hydroxide solution to remove acidic components. The product is then fractionated to separate the greater part of the N_2O . At this stage, the NF_3 becomes a colorless liquid covered with a white layer of solid N_2O . In order to remove this, the NF_3 must be repeatedly and very carefully fractionated. The last traces of N_2O may be more conveniently separated by filtering the NF_3 at -196°C on a low-temperature filter. It is completely pure after only one filtration. Finally, the air dissolved in the NF_3 is removed, using an oil pump vacuum for several hours, while the trap with the product is immersed in liquid nitrogen. Purity is best ascertained by molecular weight determination (vapor density measurement).

Nitrogen trifluoride is stored in glass flasks, in a gasometer over water, or under pressure in steel cylinders. It may be used as filling material for vapor pressure thermometers [W. Menzel and F. Mohry, *Z. anorg. allg. Chem.* 210, 257 (1933)].

PROPERTIES:

Colorless, very stable at room temperature. Does not react with water or KOH solution at room temperature unless a spark is discharged. Does not attack glass and mercury. Characteristic decay odor. Not dangerous if pure and when not inhaled in high concentrations. Crude NF_3 , however, has a much more unpleasant effect because of its impurity content. Causes headache, nausea and diarrhea.

M.p. -208.5°C , b.p. -129°C ; ΔH (formation) +26 kcal; d. (liq.) (-129°C) 1.855.

REFERENCES:

O. Ruff, F. Luft and J. Fischer. *Z. anorg. allg. Chem.* 172, 417 (1928).

O. Ruff. Z. anorg. allg. Chem. 197, 273 (1931).

O. Ruff and L. Staub. Z. anorg. allg. Chem. 198, 32 (1931).

W. Kwasnik. Naturforschung und Medizin in Deutschland 1939—1946 (FIAT-Review) 23, 204.

Ammonium Fluoride

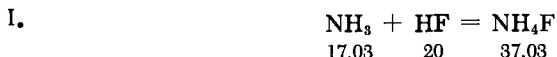

Excess gaseous ammonia is added to an ice-cooled platinum or lead dish containing 40% hydrofluoric acid. The ammonium fluoride that separates is suction filtered.

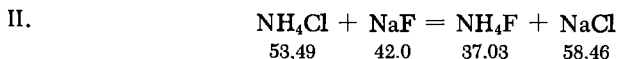

A mixture of 1 part NH_4Cl and $2\frac{1}{4}$ parts NaF is gently heated in a platinum crucible. Ammonium fluoride sublimes and is collected on the cooled crucible lid in the form of very small, prismatic, very pure crystals.

Solid ammonium fluoride cannot be obtained by evaporation of an NH_4F solution, since NH_3 splits off and NH_4HF_2 is formed. Ammonium fluoride is stored in iron vessels.

PROPERTIES:

White, deliquescent, crystalline flakes or needles, very soluble in water; decomposes on heating into NH_3 and HF . Attacks glass. Solubility in water at 0°C : 100 g./100 ml.

d. 1.015. Structure: hexagonal (wurtzite).

REFERENCE:

J. J. Berzelius. Lehrbuch der Chemie [Textbook of Chemistry], 5th ed., Vol. III, p. 282.

Ammonium Hydrogen Fluoride

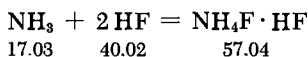
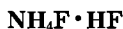

Gaseous ammonia is added to a platinum or lead dish containing 40% hydrofluoric acid until the color of Congo paper changes to

brown. The solution is then cooled with ice, whereupon NH_4HF_2 separates out. It is filtered off and dried by suction.

PROPERTIES:

White, rhombic crystals.
M.p. 124.6°C ; d 1.503.

REFERENCE:

O. Hassel and N. Luzanski. *Z. Kristallogr.* A 83, 440 (1932).

Nitrosyl Fluoride

NOF

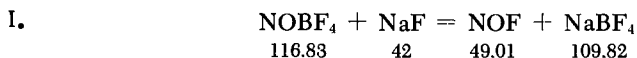

A nickel tube closed at one end serves as the reaction vessel. The tube end projecting out of the furnace is wrapped with a lead cooling coil through which cooling water flows (see Fig. 120). Two

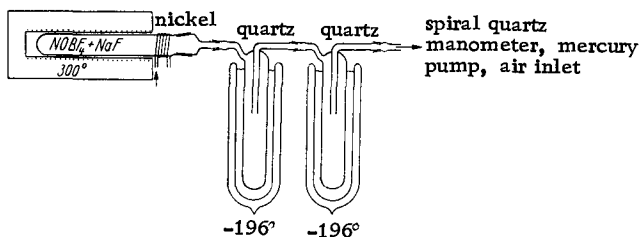

Fig. 120. Preparation of nitrosyl fluoride.

quartz liquid nitrogen-cooled condensation traps are connected to the outlet of the nickel tube. The reaction apparatus also includes a spiral quartz manometer and an air inlet protected by a P_2O_5 tube (stopcock lubricant: vaseline with graphite). The apparatus is connected to a mercury diffusion pump. A liquid nitrogen-cooled trap is inserted ahead of the pump to retain undesirable acid fumes.

The nickel tube is filled with NOBF_4 (as pure as possible) and an excess of dry NaF . This must be done under dry nitrogen. The quartz traps are then connected. The ground joints are not greased

but made airtight from outside with picein. Following this, the mercury pump is turned on and the system is brought down to a pressure of 0.01 mm. The furnace is then gradually heated to 300°C. The reaction begins at 100°C, at 200°C the rate is already considerable, and at 300°C it proceeds very vigorously. Blue NOF condenses in the first and, to some extent, also in the second trap. About 10 ml. of crude NOF is obtained from 30 g. of NOBF₄.

After completion of the reaction, the NOF is fractionated and collected in quartz receptacles. However, only rarely can it be made completely colorless, and in most cases it retains a slightly bluish color.

This procedure has the advantage of not requiring the use of elemental fluorine.



Dry NO at a rate of 55 ml./min. and fluorine at a rate of 26 ml./min. are mixed in the apparatus described for the preparation of SOF₄ (p. 172). There should always be excess NO. The reaction tube need not be heated, since the reaction between the two gases is slightly exothermic. The quartz traps are maintained at -120°C and the crude NOF condenses as a blue liquid.

After the fluorination, the crude NOF is fractionated several times and collected in quartz vessels. The first cuts consist of NO dissolved in liquid NOF and some SiF₄. The residue is N₂O₃.

Nitrosyl fluoride is best stored in quartz ampoules cooled with liquid nitrogen.

SYNONYM:

Nitrogen oxyfluoride.

PROPERTIES:

Colorless if pure, but owing to impurities the liquid often has a bluish hue. Dissolves in water, yielding a blue color, but decomposes rapidly into NO and HNO₃. Reacts vigorously with glass but less readily with quartz.

M.p. -132.5°C, b.p. -59.9°C; d. (liq.) (-59°C) 1.326, d. (solid) 1.719.

REFERENCES:

- I. G. Balz and E. Mailänder. *Z. anorg. allg. Chem.* **217**, 166 (1934).
- II. O. Ruff, W. Menzel and W. Neumann. *Z. anorg. allg. Chem.* **208**, 293 (1932).

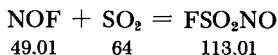
Nitrososulfuryl Fluoride

Sufficient SO_2 is condensed over NOF so that, after melting, a suspension of FSO_2NO in liquid SO_2 is obtained. The nitrososulfuryl fluoride is separated from the mixture by partial evaporation and condensation.

The compound is synthetically useful since it acts as "stabilized NOF." It can easily be prepared in pure form, and may be stored in glass containers in a Dry Ice chest. Polyethylene has proven to be an ideal container material for reactions with FSO_2NO .

PROPERTIES:

Colorless, scintillating crystalline flakes, easily sublimed. M.p. (under a pressure of 3100 mm. abs.) 8°C . At 19°C , the compound is 70% decomposed to its constituents.

REFERENCE:

F. Seel and H. Massat. Z. anorg. allg. Chem. 280, 186 (1955).

Nitryl Fluoride

Nitrogen dioxide is prepared from NO and excess oxygen. It is dried over P_2O_5 , condensed on an ice-salt mixture, and distilled once in a stream of oxygen.

A 25-ml./min. stream of fluorine and an 18.6-ml./min. stream of NO_2 are mixed in the apparatus described for the preparation of SOF_4 (p.172). The NO_2 from the storage vessel is introduced into the apparatus in a stream of oxygen. The reaction is slightly exothermic. The crude NO_2F collected in the condensation traps at -120°C is colorless. It is purified by fractional distillation and collected in quartz containers. The first cut consists of F_2 and some SiF_4 ; there is virtually no residue.

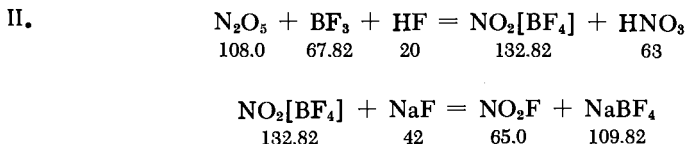

The following procedure is available if elemental fluorine cannot be used: stoichiometric quantities of anhydrous HF and BF_3 are added to a solution of N_2O_5 in nitromethane. Nitryl fluoroborate precipitates out of the nitromethane solution. The crystals are filtered with exclusion of moisture and then heated with NaF to 240°C in a platinum or nickel vessel, analogous to procedure I in the preparation of NOF (p. 184).

Since N_2O_5 decomposes easily, there is an advantage in stabilizing it. Thus, N_2O_5 and BF_3 are first allowed to react to give the compound $\text{N}_2\text{O}_5 \cdot \text{BF}_3$, which is stable at room temperature in a dry atmosphere. This compound may then be dissolved in nitromethane and allowed to react with anhydrous HF.

Nitryl fluoride is best stored in quartz ampoules cooled with liquid nitrogen.

PROPERTIES:

Formula weight 65.0. Colorless gas and liquid, white solid. Has a penetrating odor and strongly attacks the mucous membranes. Hydrolyzed by water. Absorbs mercury without leaving a residue. Reacts with most metals and nonmetals, and vigorously with alcohol, ether, benzene and chloroform.

M.p. -166.0°C , b.p. -72.4°C ; d. (liq.) (-72°C) 1.796, d. (solid) 1.924.

REFERENCES:

- I. O. Ruff, W. Menzel and W. Neumann. *Z. anorg. allg. Chem.* 208, 298 (1932).
- II. M. Schmeisser and S. Elischer. *Z. Naturforsch.* 7 b, 583 (1952).

Fluorine Nitrate

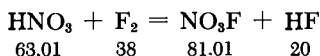

Fluorine, held ready in a quartz trap immersed in liquid nitrogen, is aspirated into the apparatus through a copper diaphragm valve

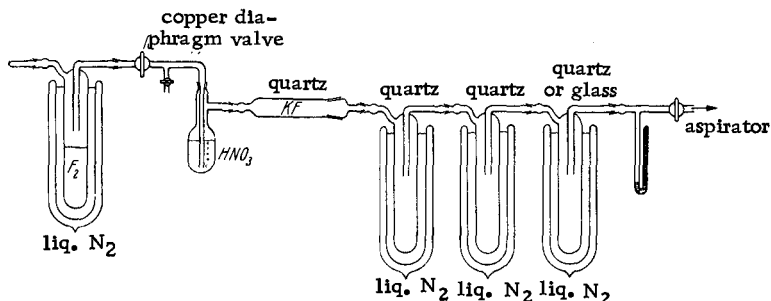

Fig. 121. Preparation of fluorine nitrate.

(see Fig. 121). The fluorine can, of course, also be taken directly from a steel cylinder. The quartz reaction vessel contains 100% HNO_3 , which has been prepared by distilling a mixture of fuming nitric acid and concentrated sulfuric acid at 20 mm. at room temperature. It is protected from decomposition by storage in liquid nitrogen. A quartz drying tube containing freshly dehydrated KF for removal of HF is connected to the reaction vessel. This is followed by a train of three quartz traps, which are cooled with liquid nitrogen. The first two serve as receivers; the third merely to keep out moisture. To help regulate the vacuum, a glass manometer is included. The system ends in a glass stopcock. A metal aspirator produces the vacuum.

The fluorine rate is controlled by the diaphragm valve so that two or three gas bubbles per second are delivered to the reaction vessel at a pressure of 20 mm. At this flow rate there is no noticeable rise in the temperature. In order to prevent plugging of the condensation traps, the coolant should be removed for a short while every 15 minutes, so that the accumulated solid NO_3F may melt and collect at the bottom.

Care should be taken to use completely grease-free apparatus for this reaction, since otherwise there is a risk of explosion.

After completion of the reaction the NO_3F is purified by fractional distillation in a quartz column at a pressure of 100 mm. The fraction boiling at -79°C (99 mm.) is pure NO_3F . The first cut consists of SiF_4 ; the residue, chiefly of H_2SiF_6 and HF .

Fluorine nitrate may be stored by sealing it under vacuum (less than 0.1 mm.) into quartz or glass ampoules, but caution is necessary, since explosions do sometimes occur. The safest way to store the compound is to keep the ampoules in liquid nitrogen.

PROPERTIES:

Colorless; has a repellent, musty odor; causes severe irritation of the respiratory tract, headaches and breathing difficulties, which

persist for several days. Liquid NO_3F explodes when vigorously shaken. Hydrolyzed by water to OF_2 , O_2 , HF and HNO_3 . Apparently quite soluble in acetone. Explodes immediately on contact with alcohol, ether and aniline.

M.p. -175°C , b.p. -45.9°C ; d.(liq.)(-45.9°C) 1.507, d.(solid) (-193.2°C) 1.951.

REFERENCE:

O. Ruff and W. Kwasnik. *Angew. Chem.* **48**, 238 (1935).

Phosphorus (III) Fluoride

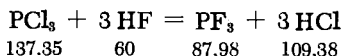

A 70-cm.-long, 4-cm. diameter quartz or iron tube closed at one end serves as the reaction vessel (Fig. 122). An iron capillary, reaching nearly to the bottom of the vessel, is inserted through the rubber stopper. An iron or quartz reflux condenser is attached above the reaction tube. From there a connection leads to the condensation trap (quartz or glass), which is cooled with liquid nitrogen.

The reaction vessel is filled with PCl_3 , and gaseous HF is added. At 50 to 60°C the reaction proceeds smoothly. After

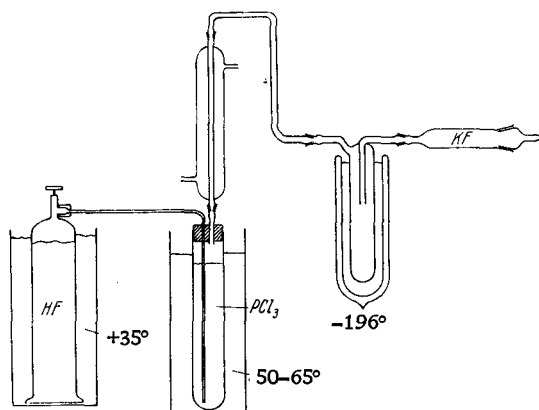

Fig. 122. Preparation of phosphorus trifluoride.

completion of the reaction the mixture of PF_3 and HCl collecting in the condensation trap is rapidly passed through wash bottles containing ice-cold water (where the HCl is absorbed), dried over P_2O_5 , and distilled. The yield is greater than 90%, based on PCl_3 .

For larger-scale preparations, the apparatus shown on p. 171 (SOF_2) may be used.

Phosphorus (III) fluoride is stored in steel cylinders or in glass flasks. It may also be stored in a gasometer over mercury.

PROPERTIES:

Colorless gas, does not fume in air, almost odorless, poisonous (causes difficulty in breathing, chest pains, nausea). Only slowly hydrolyzed by water; does not attack glass.

M.p. -151.5°C , b.p. -101.8°C , $t_{\text{CR}} -2^\circ\text{C}$, $p_{\text{CR}} 42.7$ atm.

REFERENCE:

W. Kwasnik. *Naturforschung und Medizin in Deutschland 1939—1946 (FIAT-Review)* 23, 213.

Phosphorus (V) Fluoride

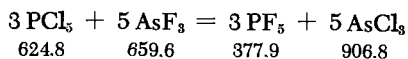

Arsenic trifluoride from a dropping funnel is allowed to flow in drops into a glass flask containing PCl_5 (see Fig. 123). A trap immersed in liquid nitrogen (the PF_5 receiver) is connected by a ground glass joint to the outlet of the flask. At the system outlet there is a drying tube filled with anhydrous KF for exclusion of atmospheric moisture.

The reaction starts without warming. Phosphorus (V) fluoride contaminated with AsF_3 accumulates as a white solid in the trap. After completion of the conversion the crude PF_5 is purified by fractionation.

The product may be stored under pressure in steel cylinders or in glass flasks.

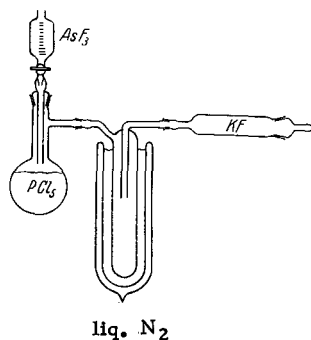

Fig. 123. Preparation of phosphorus pentafluoride.

PROPERTIES:

Formula weight 125.98. Colorless gas, strongly fuming in air; attacks the skin and lungs. Rapidly hydrolyzed by water. Does not attack dry glass at room temperature.

M.p. -83°C , b.p. -75°C .

REFERENCE:

- O. Ruff. Die Chemie des Fluors [Fluorine Chemistry], Berlin 1920, p. 29.

Phosphorus Dichloride Fluoride

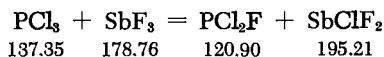

A two-liter, three-neck, round-bottom flask is used as the reaction vessel (Fig. 124). A vacuum-tight stirring arrangement

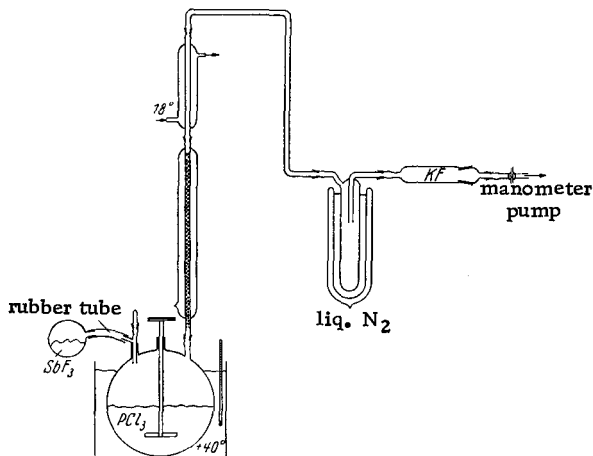

Fig. 124. Preparation of phosphorus dichloride fluoride.

is inserted into the middle neck. The first neck is for introducing SbF_3 , either by means of a worm-screw conveyor arrangement or, more simply, by a flexible rubber tube from a round-bottom flask. The third neck supports a 1-m.-long glass column to which

a partial condenser is affixed. The reaction gases flow from the condenser into a trap immersed in liquid nitrogen. Next, there is a drying tube filled with freshly dehydrated KF, followed by a stopcock, which allows the system to be separated from the manometer and the aspirator.

The reaction flask is filled with 130 g. of PCl_3 and 2 g. of PCl_5 (catalyst). The system is then evacuated to 250 mm., and this pressure is maintained during the entire synthesis. The partial condenser is fed with flowing water. Then 175 g. of dry, powdered SbF_3 is gradually added to the reaction vessel over a period of three hours. By cooling or heating, as necessary, a constant temperature of about 40°C is maintained.

The crude PCl_2F is collected in the trap. After completion of the reaction, it is fractionated. The yield is 60%.

Phosphorus dichloride fluoride is best stored by sealing into glass ampoules at -78°C ; if necessary, it may be kept for short periods in steel cylinders at room temperature.

SYNONYM:

Dichlorofluorophosphine.

PROPERTIES:

Colorless gas, unstable at room temperature. Does not fume in air; hydrolyzed by water; absorbed completely by sodium hydroxide solution with evolution of heat.

M.p. -144°C , b.p. 13.85°C ; d 1.507.

REFERENCE:

H. S. Booth and A. R. Bozart. J. Amer. Chem. Soc. 61, 2927 (1939).

Phosphorus Dichloride Trifluoride

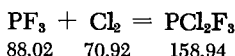

Equal metered volumes of PF_3 and Cl_2 flow into a 1-m.-long quartz tube. This serves as the reaction vessel (the apparatus is similar to that shown in Fig. 119), where the exothermic addition of Cl_2 to PF_3 takes place. The quartz tube is connected via a ground joint to a quartz trap immersed in liquid nitrogen. A drying tube with KF is attached to the trap to exclude atmospheric moisture.

The product accumulating in the condensation trap is fractionated after completion of the reaction.

Phosphorus dichloride trifluoride may be stored in glass flasks.

PROPERTIES:

Colorless gas, very pungent odor, attacks the respiratory organs, forms a thick white fog in air. Disproportionates on heating to 200°C. Excess water absorbs PCl_2F_3 without residue, producing H_3PO_4 , HF and HCl. With little water, POF_3 and HCl are formed and a rise in volume is observed. Alcohol solvolyzes the gas.

REFERENCES:

- C. Poulenc. Compt. Rend. hebdomadaire des Séances Acad. Sci. 113, 75 (1891).
V. Schomaker and J. B. Hatscher. J. Amer. Chem. Soc. 60, 1837 (1938).

Phosphorus Oxide Trifluoride

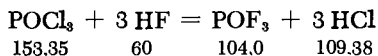

Gaseous HF is introduced into the apparatus described for PF_3 (p. 189), containing POCl_3 at 65°C. Antimony pentachloride (5 wt. %) is added as catalyst.

The product ($\text{POF}_3 + 3 \text{ HCl}$) accumulating in the condensation trap is separated by repeated fractionation. The yield is greater than 90%, based on POCl_3 .

Phosphorus oxide trifluoride is stored in glass flasks or steel cylinders.

PROPERTIES:

Colorless, pungent gas; fumes slightly in air.

M.p. -39.4°C, subl. t. -39.8°C, t_{CR} 73.3°C, p_{CR} 41.8 atm.

REFERENCE:

- W. Kwasnik. Naturforschung und Medizin in Deutschland 1939-1946 (FIAT-Review) 23, 213.

Tetrachlorophosphonium Hexafluorophosphate (V)

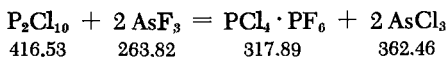
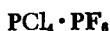

Phosphorus pentachloride (46 g.) is dissolved in 300 ml. of AsCl_3 . The solution is stirred and slightly cooled while 29.8 g. of

AsF₃ is added dropwise. The product (PCl₄ · PF₅) precipitates as fine white crystals. The end point of the reaction is indicated by the formation of PF₅ (thick white fog). The precipitate is filtered with exclusion of moisture on a fritted glass filter, washed with AsCl₃, and freed of adhering AsCl₃ in a stream of dry air. The yield is 35 g. (quantitative).

The compound is a convenient starting material for the preparation of hexafluorophosphates (hydrolysis with the respective hydroxides; see p. 196 under KPF₆) and of PF₅ (thermal decomposition at 80°C).

PROPERTIES:

White, hygroscopic salt, very slightly soluble in AsCl₃.
M.p. 160°C (partial dec.), subl. t. 135°C (partial dec.).

REFERENCE:

L. Kolditz. Z. anorg. allg. Chem. 284, 144 (1956).

Phosponitrilic Fluorides

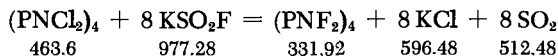
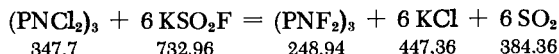
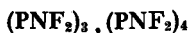

Powdered trimeric or tetrameric phosponitrilic chloride is reacted with potassium fluorosulfinate at 120 to 150°C. The degree of polymerization is not altered by the reaction.

PROPERTIES:

Both phosponitrilic fluorides are solid, colorless, volatile substances at room temperature. They are thermally stable up to 300°C. The trimer boils at 51.8°C and crystallizes in monoclinic prisms. Triple point 27.1°C. It polymerizes to a rubbery form by heating for 15 hours at 350°C. The tetramer boils at 89.7°C and forms triclinic-pinacoidal crystals. Triple point 30.4°C.

REFERENCE:

F. Seel and J. Langer. Angew. Chem. 68, 461 (1956).

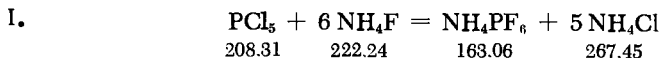
Ammonium Hexafluorophosphate (V)

A mixture of 9.4 g. of PCl_5 and 11.6 g. of dry NH_4F is prepared by shaking in a test tube. The open test tube is fastened to a stand in near-horizontal position and the mixture is heated with a small flame near the open end until the reaction starts (use hood, goggles). The reaction then progresses spontaneously until the bottom of the test tube is reached and fuming, heavier-than-air vapors are liberated. After cooling, the solid mass formed in the test tube is dissolved in two liters of water. An acetic acid solution (100 ml.) containing 9 g. of nitron is slowly poured with stirring into the solution, so that nitron hexafluorophosphate precipitates out.

After cooling with ice for two hours the salt is filtered, washed several times with a little ice-cold water and, while still moist, shaken with chloroform and 25% ammonia solution in a separatory funnel. After the nitron has thus been removed, the aqueous solution is evaporated to dryness in a platinum dish on a water bath. The yield is 4 g. of NH_4PF_6 .

For purification the salt is dissolved in a small amount of water, filtered and reevaporated in a platinum dish, but only until a wet mass of crystals appears. This is spread in a clay dish and left to dry in the air.

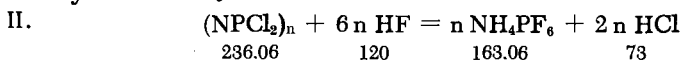

Phosphonitrilic chloride is wetted with hydrofluoric acid in a platinum dish. An exothermic reaction occurs. The mixture is evaporated to dryness on a water bath. The yield is quantitative. In comparison with method I, this procedure has the advantage that it leads directly to a pure product. The purification using nitron hexafluorophosphate is therefore omitted.

This compound may be used for the preparation of many salts of hexafluorophosphoric acid.

PROPERTIES:

Colorless, mostly square, rarely rectangular flakes or thick plates, readily soluble in water; also soluble in acetone, methyl and ethyl alcohols; decomposes on heating to a relatively high temperature without prior melting. Does not attack glass at room temperature. Slowly hydrolyzed by boiling with strong acids.

d_4^{25} 2.180. Solubility in water at 20°C: 74.8 g./100 ml. Structure: cubic.

REFERENCES:

- I. W. Lange and E. Müller. Ber. dtsh. chem. Ges. 63, 1063 (1930); W. Lange and G. v. Krueger. Ber. dtsh. chem. Ges. 65, 1265 (1932).
- II. H. Bode and H. Clausen. Z. anorg. allg. Chem. 265, 229 (1951).

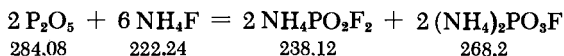
Ammonium Difluorophosphate (V)

Phosphorus pentoxide (23.5 g.) is heated with 185 g. of NH_4F in a 300-ml. nickel or copper crucible until the reaction starts. It progresses by itself, but the mixture should be well stirred. After cooling, the mass is pulverized and boiled in a glass flask with 600 ml. of absolute alcohol. The mixture is filtered hot through a fluted filter; the filtrate is immediately cooled and neutralized with ammoniacal alcohol. Ammonium difluorophosphate (V) (8.3 g.) separates out and is removed by filtration. The filtrate is evaporated to dryness in a platinum dish on a water bath. The yield is 11.6 g. (70% of theoretical) of crude salt. This $\text{NH}_4\text{PO}_2\text{F}_2$ is still contaminated with NH_4F but is suitable for many purposes.

The salt is purified by rapid recrystallization from 6 ml. of hot water and drying over H_2SO_4 . The yield is 3.2 g. (20% of theoretical) of analytically pure salt. It is stored in a glass container with exclusion of atmospheric moisture.

PROPERTIES:

Formula weight 134.1. Colorless; gives a neutral reaction in water at first but hydrolyzes with time. Readily soluble in water, ethyl and methyl alcohols and acetone.

M.p. 213°C without decomposition. Structure: rhombic.

REFERENCE:

W. Lange. Ber. dtsh. chem. Ges. 62, 790 (1929).

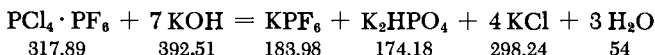
Potassium Hexafluorophosphate (V)

Hydrolysis of 0.78 g. of $\text{PCl}_4 \cdot \text{PF}_6$ in 20 ml. of 11N potassium hydroxide yields a solution, which is concentrated under vacuum at

45°C to 3 ml. The crystalline precipitate that separates out is filtered, washed with alcohol, and dried.

PROPERTIES:

Square and rectangular thick plates, face-centered cubic lattice. Melts at red heat with partial decomposition. On heating with solid NaOH, a vigorous reaction starts above 400°C, giving the fluoride and the phosphate.

REFERENCE:

L. Kolditz. Z. anorg. allg. Chem. 284, 144 (1956).

Arsenic (III) Fluoride

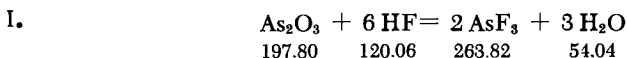

At a bath temperature of 140°C, anhydrous HF is fed into As_2O_3 contained in a distillation apparatus made entirely of iron (see Fig. 125). The steel cylinder with the HF is immersed in a water bath at +35°C. The AsF_3 distilling off is condensed in a brine-cooled condenser maintained at -18°C. The rate of HF addition is regulated in such a way that a smooth stream of liquid AsF_3 flows out of the condenser.

After shutting off the flow of HF, the reaction vessel is removed, and 10% of H_2SO_4 (by volume) is added to the crude AsF_3 . The vessel is then used as a distillation flask and the product is distilled. The main fraction (between 50°C and about 85°C) is AsF_3 . The yield is 80%, based on As_2O_3 . Six kilograms can readily be prepared in a day.

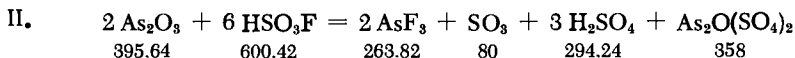

A mixture of 144 g. of As_2O_3 and 247 g. of HSO_3F (40% excess) is prepared in a glass round-bottom flask provided with a ground-glass joint. The latter supports a large-diameter, air-cooled reflux condenser. An inclined condenser and an ice-cooled receiver are attached to the reflux condenser. A noticeable temperature rise results from the mixing. While an air flow into the flask

(through the reflux condenser) is induced by suction in order to retain the HSO_3F , the flask is heated on an open flame. In less than 1.5 hours, about 60 g. of AsF_3 distills over at 58 to 62°C. The yield is 78%, based on As_2O_3 .

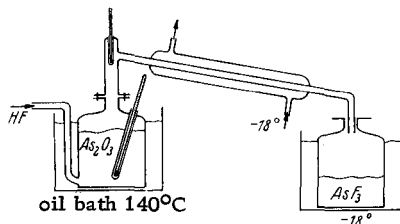

Fig. 125. Preparation of arsenic (III) fluoride.

Arsenic (III) fluoride is stored in iron vessels.

PROPERTIES:

Formula weight 131.9. Colorless, mobile, very poisonous liquid. Fumes in air, attacks glass. Decomposed by water as soon as the stoichiometric ratio is reached. Soluble in alcohol, ether and benzene.

M.p. -8.5°C , b.p. $+63^\circ\text{C}$; d. (liq.) (15°C) 2.73.

REFERENCES:

- I. W. Kwasnik. Not yet published.
- II. A. Engelbrecht, A. Aignesberger and E. Hayek. *Mh. Chem.* 86, 470 (1955).

Arsenic (V) Fluoride

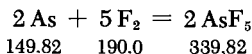

Arsenic is fluorinated in a nickel or alumina boat, using the apparatus described for SF_6 (p. 169). The product condensed in the traps is distilled several times in a quartz apparatus.

Arsenic (V) fluoride is stored in steel cylinders.

PROPERTIES:

Formula weight 169.91. Colorless gas. Forms white clouds in moist air. Immediately hydrolyzed by water. Soluble in alcohol, ether and benzene.

M.p. -79.8°C , b.p. -52.9°C ; d. (liq.) (-52.8°C) 2.33.

REFERENCE:

- O. Ruff, W. Menzel and H. Plaut. *Z. anorg. allg. Chem.* 206, 61 (1932).

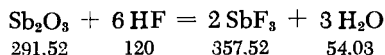
Antimony (III) Fluoride

I. Antimony (III) oxide is dissolved in excess aqueous hydrofluoric acid and the solution evaporated to dryness on a hot plate.

The product is then distilled in a copper apparatus. The distillation vessel is conical at the top, and a short, large-diameter head is used. The head must be kept sufficiently warm during the distillation to prevent plugging.

II. Gaseous HF is added through a silver capillary tube to Sb_2O_3 contained in a conical vessel made of Mg sheet and covered with an Mg cover; the vessel is heated gently with a gas flame during the addition. When no further HF is absorbed, the heating is increased to evaporate the accumulated H_2O . The addition of HF and evaporation of H_2O are repeated until no further aqueous hydrofluoric acid is formed. The solid is then melted, poured onto in Mg sheet, crushed and stored in a tightly closed can. In addition, SbF_3 can be distilled as described in method I.

Antimony (III) fluoride is kept in glass vessels or iron containers.

PROPERTIES:

Formula weight 178.76. Colorless, deliquescent crystals, readily soluble in water with partial hydrolysis. Solubility in water (20°C) 443 g./100 ml.; (30°C) 562 g./100 ml.

M.p. 292°C, b.p. 376°C; d. (solid) (20°C) 4.379.

Structure: rhombic.

REFERENCES:

- I. O. Ruff. *Die Chemie des Fluors* [Fluorine Chemistry], 1920, p. 39.
- II. J. Söll. *Naturforschung und Medizin in Deutschland 1939-1946* (FIAT-Review) 23, 276.

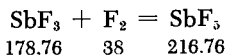
Antimony (V) Fluoride

Fluorine is fed into a quartz apparatus (Fig. 126) containing gaseous SbF_3 . The apparatus is heated with a Bunsen burner to bring the SbF_3 to gentle boiling. A fluorine stream of at least 10 g./hour is added through an aluminum tube. The antimony (V) fluoride reacts, at times igniting, and SbF_5 distills. It can then be fractionated in a quartz apparatus.

Antimony (V) fluoride is kept in sealable Al bottles or, if necessary, in quartz vessels. Platinum bottles can also be used.

PROPERTIES:

Colorless, viscous liquid; very reactive. Fizzes when poured into water; is caustic to the skin. Attacks glass, but is only slightly corrosive to Cu and Pb. Inert to quartz, Pt and Al.

M.p. 6°C , b.p. 150°C ; d.(liq.)(22°C) 2.993.

REFERENCE:

J. Söll. Naturforschung und Medizin in Deutschland 1939-1946 (FIAT-Review) 23, 276.

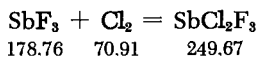
Antimony Dichloride Trifluoride

A weighed amount of SbF_3 is placed in a steel cylinder equipped with a manometer and a needle valve. The container is evacuated, its valve closed, and the container weighed. A Cl_2 cylinder is then

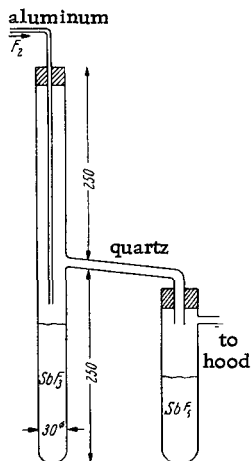

Fig. 126. Preparation of antimony (V) fluoride.

connected through a steel capillary, the valve is opened, and Cl_2 is allowed to enter the reaction vessel. The Cl_2 is quickly absorbed by the SbF_3 , with evolution of heat. From time to time the connection with the Cl_2 cylinder is loosened and the reaction vessel is shaken. The Cl_2 addition is then resumed. The reaction is terminated as soon as the calculated amount of Cl_2 has been absorbed.

Antimony dichloride trifluoride is stored in iron vessels.

Useful as a catalyst for the preparation of numerous organic fluorine compounds.

PROPERTIES:

Viscous liquid.

REFERENCE:

A. L. Henne. *Organic Reactions* II, p. 61.

Bismuth (III) Fluoride

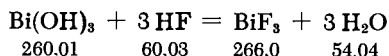

Freshly precipitated bismuth hydroxide is evaporated to dryness several times in a Pt dish, using an excess of hydrofluoric acid. It is then calcined in a covered Pt crucible until the HF has completely evaporated. A grayish product remains.

Chemically pure BiF_3 is white. Such high-purity material can be obtained by the reduction of BiF_5 with hydrogen. The H_2 is greatly diluted with CO_2 ; the reaction takes place in a Pt tube at 80–150°C.

Use: Preparation of BiF_5 .

PROPERTIES:

Heavy, white (gray if impure) crystalline powder, practically insoluble in water.

M.p. 725–730°C; d. 8.3. Cubic (dimorphous).

REFERENCES:

Muir, Hoffmeister and Robb. *J. Chem. Soc. (London)* 39, 33 (1881).
H. v. Wartenberg. *Z. anorg. allg. Chem.* 244, 344 (1940).

Bismuth (V) Fluoride

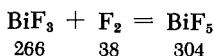

A boat made of sintered alumina and containing BiF_3 is pushed with a nickel wire into a sintered alumina tube (see Fig. 127).

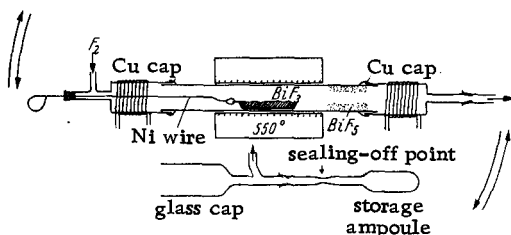

Fig. 127. Preparation of bismuth (V) fluoride.

Both ends of the tube are covered with copper caps, which are water cooled and sealed on with picein. The apparatus is best arranged in such a way that it can be rotated approximately 90° into a position perpendicular to the axis of the furnace. The F_2 is added through a flexible, 5-m.-long copper capillary. A fluorine stream is passed through the tube at the rate of 20 ml./min., while the oven is heated to about 550°C . At 460°C the BiF_5 starts to sublime from the boat and crystallizes at the end of the reaction tube in thin white needles about 3 mm. long. The sublimation proceeds best at 500°C , since at higher temperatures it is so fast that BiF_5 diffuses upstream and crystallizes even at the inlet to the tube.

After the fluorination is finished, the F_2 stream is replaced with a stream of CO_2 or oxygen-free N_2 . The boat is removed from the reaction tube by pulling it with a Ni wire in the direction opposite to the gas flow and placed in the Cu cap. The Cu cap at the other end is replaced by a glass cap (see Fig. 127). The apparatus is now rotated 90° , so that the far end is at the bottom and the gas inlet on top. The clumps of BiF_5 needles in the reaction vessel are scraped off with a Ni wire. They fall through the glass cap into the collecting ampoule, which is then melt-sealed.

The material is best analyzed by reduction of a weighed amount with H_2 . The hydrogen is greatly diluted with CO_2 and the reaction proceeds at $80\text{--}150^\circ\text{C}$ (1 hour) in a Pt tube. The freshly formed BiF_3 is weighed.

PROPERTIES:

White crystals, highly sensitive to moisture. In humid air immediately turns yellow-brown. Reacts with water, sometimes with ignition, forming ozone and BiF_3 . Reacts with kerosene above 50°C . Subl. t. appr. 550°C .

REFERENCE:

H. v. Wartenberg. Z. anorg. allg. Chem. 224, 344 (1940).

Carbon Tetrafluoride

Degassed activated carbon or carbon black, contained in a nickel boat, is burned in a F_2 stream in the apparatus described for SF_6 (page 169). The reaction must be externally controlled by cooling. The crude CF_4 collects as a liquid in the liquid-oxygen-cooled quartz trap. After the fluorination, while the trap remains cooled with liquid O_2 , the product is removed by suction, using an aspirator. Most of the dissolved gases are thus removed. The product is then passed through a series of fritted gas scrubber bottles containing 20% KOH solution (not NaOH); this extracts COF_2 , SiF_4 and HF. Finally, the CF_4 is passed over P_2O_5 and recondensed with liquid O_2 . The liquid is carefully fractionated to remove the higher homologs of CF_4 (C_2F_6 , C_3F_8). Then the last traces of dissolved air are removed, using an oil pump, while the trap is cooled with liquid O_2 .

All the apparatus used for the operations following the fluorination can be made of glass.

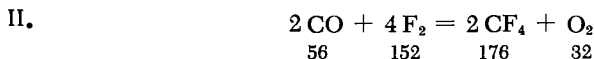

This preparation of CF_4 from CO and F_2 has the advantage over method I that the CF_4 obtained is completely free of higher homologs. The preparation is the same as described for COF_2 (page 207). To obtain good yields of CF_4 and as little COF_2 as possible, the CO must be preheated to as high a temperature as possible (appr. 400°C). With a 1000-amp. current in the fluorine cell, the yield is 80-85%, based on CO. With considerably lower currents, for instance, with a current of 10 amp., the yield of CF_4 is no greater than 15%.

The crude CF_4 is purified in the same way as described above. The degree of purity of the product can be easily checked by the melting point since this is considerably lowered by dissolved air or C_2F_6 .

Carbon tetrafluoride is stored in glass or steel cylinders. It can be used in vapor-pressure thermometers [W. Menzel and F. Mohry, *Z. anorg. allg. Chem.* 210, 256 (1933)].

PROPERTIES:

Colorless, odorless, thermally very stable gas. Chemically very inert at room temperature.

M.p. -183.6°C , b.p. -127°C ; d. (solid) (-195°C) 1.98, d. (liq.) (-183°C) 1.89.

REFERENCES:

- I. O. Ruff and R. Keim. *Z. anorg. allg. Chem.* 192, 249 (1930); 201, 255 (1931).
- II. W. Kwasnik, *Naturforschung und Medizin in Deutschland 1939-1946 (FIAT-Review)* 23, 168; J. Goubeau, W. Bues and W. Kampmann. *Z. anorg. allg. Chem.* 283, 123 (1956).

Trifluoromethane

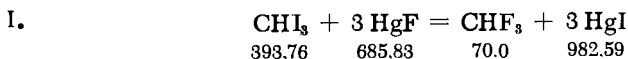

Iodoform, and powdered CaF_2 (as diluent) are ground together in a 20 : 33.4 : 40 ratio and placed in a 100-ml. glass flask, the outlet of which is joined to a liquid nitrogen-cooled trap, which in turn is connected to a drying tube containing P_2O_5 .

The flask is now heated by means of a sulfuric acid bath. The exothermic reaction starts at appr. 80°C and the temperature rises to appr. 180°C . Crude CHF_3 , colored by iodine, is collected in the trap.

After completion of the reaction, the product is fractionated. The cut coming over at a bath temperature between -40 and -30°C is practically pure CHF_3 . It is washed with 2N NaOH and dried over P_2O_5 . The yield is 45%.

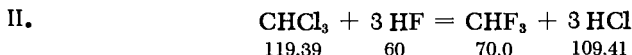

A stirred stainless steel autoclave, equipped with an iron reflux condenser, is filled with 360 g. of CHCl_3 and 600 g. of SbCl_5

(catalyst). Then 200 g. of anhydrous HF is injected under pressure and the system is heated for 1.5 hours at 130°C. The pressure increases to 75 atm. gage. The pressure is now gradually released through a valve above the condenser. The vented gases are passed through ice water and dilute NaOH, dried over P₂O₅, and fractionated.

The experiment can be repeated with the same catalyst if each charge subsequently added to the autoclave consists of 360 g. of CHCl₃ and 60 g. of HF. The yield is 95%.

This fluorination method, in which the catalyst is SbF₃Cl₂ · 2HF, formed as an intermediate, is widely applicable. It can also be used for the preparation of CClF₃, CCl₂F₂, C₂Cl₃F₃, C₂Cl₂F₄ and C₂HCl₃F₂.

Trifluoromethane can be stored in a glass flask or a gasometer over water.

SYNONYM:

Fluoroform

PROPERTIES:

Colorless gas, thermally stable up to 1150°C. Chemically unusually stable.

M.p. -160°C, b.p. -84.4°C; d. (liq.) (-100°C) 1.52, d. (solid) 1.935.

REFERENCES:

- I. O. Ruff. Ber. dtsch. chem. Ges. 69, 299 (1936).
- II. B. Whallay. J. Soc. Chem. Ind. 66, 429 (1947).

Trifluoroiodomethane

CFI₃

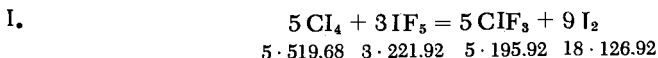

A glass flask provided with a gas outlet is filled with 80 g. (0.153 mole) of Cl₄ and 30 g. (0.135 mole) of IF₅. The gas outlet is connected via short rubber tubes to several gas traps cooled with liquid nitrogen. Agitation of the vessel produces vigorous evolution of gas. When the reaction subsides, the system is heated for 30 min. at 90-100°C. The condensate in the gas traps is then washed with 5% NaOH and fractionated. The yield is 90%.

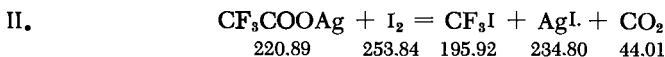

The starting material, silver trifluoroacetate, is first produced by adding Ag₂O to 50% trifluoroacetic acid solution and

evaporating the mixture to dryness under vacuum.

The powdered silver trifluoroacetate (100 g.) is mixed with 110-300 g. of powdered iodine and poured into a glass tube closed at one end. The tube is placed horizontally and the open end connected to a trap cooled with ice water; this in turn is connected to two Dry-Ice-cooled traps and a water-filled bubble counter. The mixture is then gradually heated with a gas flame to above 100°C; the rate of heating should be controlled by observing the flow through the bubble counter. Iodine collects in the first trap; ClF_3 in the last. The latter is washed with dilute NaOH and purified by fractionation. The yield is 80-95%.

Trifluoroiodomethane is stored in glass ampoules.

PROPERTIES:

Colorless, light-sensitive gas. Evolves $\text{CF}_3\cdot$ radicals when heated or irradiated with UV light and is therefore useful in the synthesis of numerous compounds of the type $\text{CF}_3(\text{CF}_2)_n \cdot \text{X}$, as well as organometallic and organometalloid compounds.

REFERENCES:

- I. A. A. Banks, H. J. Emeléus, R. N. Haszeldine and V. Kerrigan. *J. Chem. Soc. (London)* 1948, 2188.
- II. R. N. Haszeldine. *J. Chem. Soc. (London)* 1951, 584; A. L. Henne and W. G. Finnegan. *J. Am. Chem. Soc.* 72, 3806 (1950).

Carbonyl Fluoride



A copper cylinder, equipped at the bottom with a detachable burner, is used as the reaction vessel. Two observation tubes, each consisting of a 30-cm.-long copper tube with a quartz window (rubber gasket seal), allow observation of the flame. The vessel is wrapped with towels or muslin bandages to permit thorough wetting of the apparatus wall by the cooling water running over it.

The reaction products pass through a short condenser for initial cooling. This in turn is connected to two quartz traps cooled with liquid O_2 (Fig. 128).

The input CO is purified by washing with pyrogallol solution and concentrated H_2SO_4 ; it is then passed through a P_2O_5 drying

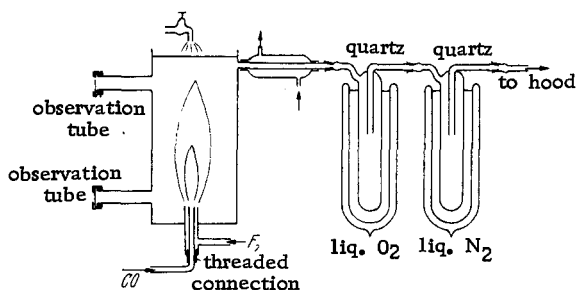

Fig. 128. Preparation of carbonyl fluoride.

tube and a flowmeter. Finally a safety relief vessel to accommodate excess pressure is connected to help recognize immediately any plugging of the apparatus.

The F_2 is taken directly from an electrolysis cell and passed through an iron condenser coil, cooled to $-78^\circ C$ with Dry Ice in order to separate any HF.

To start the operation, F_2 is passed through the entire apparatus until a gas flame or, better, an oil-soaked piece of fabric can be ignited by the exit gases. Then the burner is quickly unscrewed and the CO stream ignited. The burner is replaced in the reactor with its flame adjusted to a small size so that the CO continues to burn in the fluorine stream. The CO and F_2 streams are then controlled to give a constant excess of fluorine. A CO flow of 2.5 liters/hour per 10 amp. of current in the fluorine cell is optimum.

If the opposite procedure is used and the F_2 stream is burned in a CO atmosphere, there is a risk of a violent explosion should the flame go out unexpectedly.

Carbon tetrafluoride can be prepared in the same apparatus (see page 203). However, to obtain high yields of CF_4 , a high flow rate of the input gases is necessary (for instance, 1000 amp. current in the F_2 cell and 250 liters of CO/hour) and the CO must be pre-heated to appr. $400^\circ C$. This is best accomplished by heating the CO inlet tube with a Bunsen burner.

At the temperature of liquid O_2 , the product condensed in the first quartz trap is part solid and part liquid (CF_4). To isolate the COF_2 , the product should be distilled into a small steel cylinder after stripping from it the major part of the dissolved gases (F_2 , air) at $-183^\circ C$ for 1/2 hour with a water aspirator. Following the distillation the cylinder is turned upside down and the liquid portion (CF_4) pumped out with an oil pump. The solid COF_2 remains in the steel container. This procedure is accomplished in appr. two minutes and yields 85% pure COF_2 . If a low-temperature filter is

available, the separation of COF_2 and CF_4 can also be accomplished at -183°C . Finally, the material is fractionated in a quartz apparatus. A 97% pure product is obtained.

Carbonyl fluoride is stored in steel cylinders.

II. COF_2 is also conveniently prepared in a completely CF_4 -free form via the reaction of BrF_3 with CO . This procedure is described in detail under the preparation of carbonyl bromofluoride (p. 210).

To isolate the COF_2 , the reaction product, which is colored yellow by the bromine, is passed over Sb powder and recondensed. The mixture is then fractionated at atmospheric pressure, and pure COF_2 comes over between -85 and -60°C . This procedure is very convenient since it can be left virtually unattended.

SYNONYM:

Fluoroformyl fluoride, carbonyl difluoride.

PROPERTIES:

Colorless gas, very hygroscopic, pungent odor. Instantly hydrolyzed by water.

M.p. -114.0°C , b.p. -83.1°C ; $d(\text{solid}) (-190^\circ\text{C}) 1.388$, $d(\text{liq.}) (-114^\circ\text{C}) 1.139$.

REFERENCES:

- I. O. Ruff and G. Miltschitsky. *Z. anorg. allg. Chem.* **221**, 154 (1935); W. Kwasnik. *Naturforschung und Medizin in Deutschland 1939—1946 (FIAT-Review)* **23**, 168.
- II. W. Kwasnik. *Naturforschung und Medizin in Deutschland 1939—1946 (FIAT-Review)* **23**, 242.

Carbonyl Chlorofluoride

COCIF

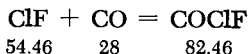

Streams of ClF and CO are mixed at -18°C in an iron reaction vessel (see Fig. 129). The CO must always be present in excess. The slower the rate of reaction the greater the yield of COCIF . The reaction gases are condensed in a quartz trap at -196°C . The second quartz trap is used to exclude atmospheric moisture.

After the reaction is finished, the yellow product is repeatedly passed over Sb powder and finally distilled over the Sb . The white

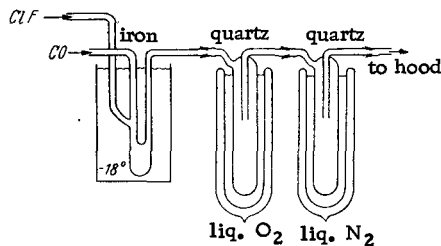

Fig. 129. Preparation of carbonyl chlorofluoride.

product is then fractionated at atmospheric pressure. The first cut is COF_2 , the last COCl_2 . The middle fraction (-50° to -30°C) is COClF . It can be made extremely pure by repeated fractionation. The yield is 85-90%, based on ClF .

Carbonyl chlorofluoride is preferably stored in quartz ampoules cooled in liquid nitrogen. It can also be stored under pressure in cylinders made of type 316 stainless steel.

SYNONYM:

Chlorofluorophosgene.

PROPERTIES:

Colorless. Odor almost indistinguishable from phosgene.

M.p. -148°C , b.p. -47.2°C ; d (liq.) (-78°C) 1.506, (0°C) 1.323, (18°C) 1.277. V. p. (19°C) 12 atm. gage; t_{cr} $+85^\circ\text{C}$.

Stable at room temperature both as a gas and a liquid. Hydrolyzed by water within half an hour. Absorbed immediately by NaOH solution, evolving heat and leaving no residue. Glass is stable to it for weeks but becomes covered with a cloudy film. Quartz is more stable but is also slowly covered with a cloudy film. Attacks Hg . After exposure for a week, rubber becomes somewhat hard. Stainless steels 304 and 316, brass and aluminum are inert to COClF ; Ni , Monel, Sn , Zn and electron ($\text{Mg}-\text{Al}$) alloys have moderate resistance; Fe , Cu , Pb and Ag show little resistance.

REFERENCE:

W. Kwasnik. *Naturforschung und Medizin in Deutschland 1939-1946 (FIAT-Review)* 23, 242.

Carbonyl Bromofluoride

COBrF

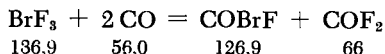

An iron wash bottle (Fig. 130) with a screw cap is filled with BrF_3 , the cover is screwed on, and the vessel is cooled with ice water. Two quartz traps cooled with liquid N_2 are then connected to it. The first trap is the usual condensation vessel; the second is used solely to exclude atmospheric moisture. The CO , which has been purified by passage through pyrogallol solution, concentrated H_2SO_4 and P_2O_5 , is bubbled through the BrF_3 . The system evolves heat. The CO flow is so regulated that the temperature of the BrF_3 is kept between $+8$ and $+30^\circ\text{C}$. The BrF_3 freezes below 8°C and the reaction proceeds explosively at too high a temperature. The product condensing in the first trap is yellowish. After the reaction is complete the product is passed over Sb powder and then fractionated in a quartz apparatus. Pure COF_2 comes over in the first fraction (see p. 208) between -85 and -60°C , and COBrF is collected from -30 to -15°C . The latter can be purified by refractionation. The yield is greater than 90% based on BrF_3 .

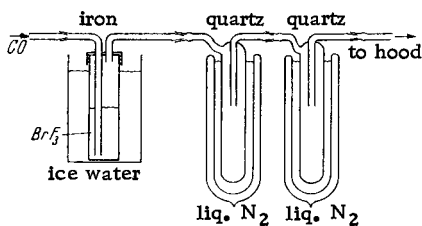

Fig. 130. Preparation of carbonyl bromofluoride.

Carbonyl bromofluoride is preferably stored in quartz ampoules kept in liquid nitrogen. It can also be kept at room temperature in quartz containers or type 304 stainless steel cylinders, but it becomes yellow-brown with time and must be redistilled before use.

SYNONYMS:

Bromofluorophosgene.

PROPERTIES:

Colorless gas.

M.p. -120°C , b.p. -20.6°C ; v.p. (18°C) 3.65 atm. gage; $t_{\text{cr}} +124^{\circ}\text{C}$, p_{cr} appr. 61 atm.; d (liq.) (0°C) 1.944.

Gaseous COBrF is thermally stable up to 125°C . Liquid COBrF decomposes slowly at room temperature. Water causes quantitative hydrolysis to $\text{CO}_2 + \text{HBr} + \text{HF}$ in appr. 30 minutes. Instantly absorbed by NaOH solution. Glass is stable to it for some time. Attack by liquid COBrF causes rubber to become black and brittle. Attacks Fe and Hg.

Odor similar to that of phosgene, but with some experience it can readily be differentiated.

REFERENCE:

- W. Kwasnik. *Naturforschung und Medizin in Deutschland 1939-1946 (FIAT-Review)* 23, 242.

Carbonyl Iodofluoride

COIF

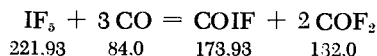

A one-liter rocker bomb is charged with 50 g. of IF_5 ; it is pressurized to 120 atm. with CO and rocked in an inclined position for a week. The pressure is then relieved until atmospheric pressure is reached, thus removing the COF_2 and the excess CO. Next, a quartz trap containing some Sb powder and cooled with liquid N_2 is connected at the valve of the autoclave. The system is evacuated for an hour to about 200 mm. The COIF thus distills over and is condensed in the trap. The autoclave can then be refilled with CO without recharging the IF_5 .

The collected condensate is distilled from the Sb in the trap. The COF_2 is removed below -15°C . The distillation is then continued at reduced pressure (appr. 300 mm.) because of the instability of the COIF. It comes over between -15 and $+20^{\circ}\text{C}$. It is redistilled at reduced pressure over Sb. The main products of this reaction are I_2 and COF_2 . The yield is 12%, based on IF_5 .

Carbonyl iodofluoride can be stored only in quartz ampoules under Dry Ice or, better, liquid nitrogen.

SYNONYM:

Iodofluorophosgene.

PROPERTIES:

Colorless if pure. Choking odor, similar to COBrF, quite distinct from COCl₂.

M.p. -120°C , b.p. -20.6°C ; v.p. (18°C) 3.65 atm. gage; t_{cr} 124°C , p_{cr} appr. 61 atm.; d (liq.) (0°C) 1.944.

Above -20°C , COIF decomposes perceptibly with liberation of iodine. Gaseous COIF also decomposes at room temperature. Slowly hydrolyzed by water, similarly to COBrF. Absorbed completely by NaOH. Quartz and glass become coated with a yellow substance on contact with the liquid at room temperature.

REFERENCE:

W. Kwasnik. Naturforschung und Medizin in Deutschland 1939-1946 (FIAT-Review) 23, 242.

Silicon Tetrafluoride

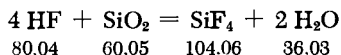
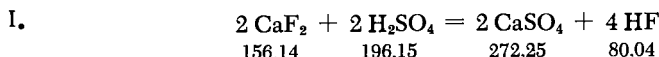

Powdered calcium fluoride is fumed with HF in a Pt dish in order to remove carbonates.

A stoichiometric mixture of calcium fluoride powder, an excess of quartz sand of highest purity (99.9%), and concentrated H₂SO₄ are placed in the reaction flask of an all-glass apparatus (see Fig. 131), and gently warmed on a sand bath. The evaporating SiF₄ passes through a vertical water-cooled condenser and a trap cooled with Dry Ice-acetone mixture to remove possible impurities (HF), and is finally condensed in a trap cooled with liquid nitrogen. In order to exclude moist air, a P₂O₅ drying tube is connected to the system. The product can be purified by sublimation in a closed glass vessel or distillation under slight pressure, in which case the first and last cuts can be discarded.

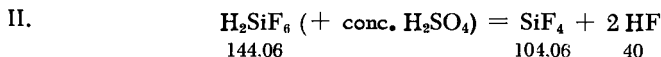

An iron vessel (Fig. 132) is substituted for the glass reaction flask of method I. The wrought-iron container holds one liter of

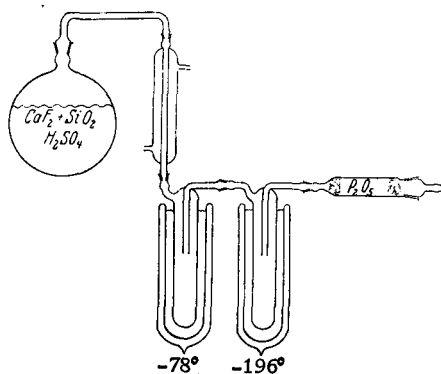

Fig. 131. Preparation of silicon tetrafluoride (I).

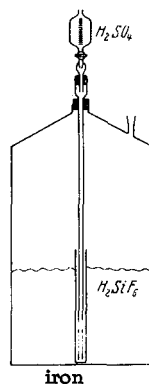

Fig. 132. Preparation of silicon tetrafluoride (II).

60% H_2SiF_6 . Two liters of concentrated H_2SO_4 are added dropwise through a dropping funnel inserted into the container via a rubber stopper. The iron extension tube of the funnel extends into an iron tube which is closed at the bottom and from the top of which the H_2SO_4 overflows. The HF formed during the reaction is completely retained by the concentrated H_2SO_4 .

Silicon tetrafluoride can be stored in a glass flask with a stopcock, in gasometers over Hg or concentrated H_2SO_4 , or in steel cylinders.

SYNONYM:

Tetrafluorosilane.

PROPERTIES:

Colorless gas, very hygroscopic, forms a dense fog in humid air, is rapidly cleaved by water, does not attack stopcock grease.

Subl. t. -95°C , m.p. (under pressure) -90.2°C ; d. (liq.) (-88°C) 1.590; $t_{\text{cr}} -1.5^\circ\text{C}$; p_{cr} 50 atm. gage.

REFERENCES:

- I. L. Lebouché, W. Fischer and W. Biltz. Z. anorg. allg. Chem. 207, 64 (1932); O. Ruff and E. Ascher. Z. anorg. allg. Chem. 196, 413 (1931).
- II. J. Söll. Naturforschung und Medizin in Deutschland 1939—1946 (FIAT-Review) 23, 257.

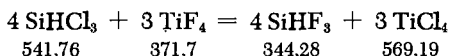
Trifluorosilane

Trichlorosilane and TiF_4 are heated for 18 hours in an autoclave on an oil bath at 100–200°C. If necessary, the reaction can be carried out in a sealed pressure tube. After cooling, the autoclave is slowly vented and the exit gases are collected in a quartz or glass trap cooled in liquid N_2 . The mixture is then fractionated. The residue in the autoclave consists of TiF_4 and TiCl_4 . Since pure SiHF_3 decomposes slowly even at room temperature it should be kept in Dry Ice or liquid N_2 .

SYNONYM:

Silicofluoroform.

PROPERTIES:

Formula weight 86.07. Colorless, flammable gas; forms an explosive mixture with air. Decomposes slowly at room temperature; decomposes rapidly to H_2 , Si and SiF_4 if heated to 400°C. Hydrolyzed by water. Decomposes alcohol and ether; reduces concentrated nitric acid.

M.p. -110°C , b.p. -80°C .

REFERENCE:

O. Ruff and C. Albert. Ber. dtsh. chem. Ges. 38, 56 (1905).

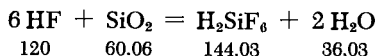
Hexafluorosilicic Acid

I. Small portions of quartz powder (99.9%) are added to 70–95% hydrofluoric acid, containing a small amount of H_2SiF_6 . The addition is carried out in an iron vessel and proceeds until no further dissolution of the quartz occurs. The reaction must be moderated by cooling with ice. The addition of H_2SiF_6 is necessary for a smooth initiation of the reaction. After the reaction is terminated, the

excess of quartz powder is left to settle and the 60-70% H_2SiF_6 is decanted. The material is best stored in iron containers. Concentrated hexafluorosilicic acid solidifies at appr. 19°C ; the tetrahydrate crystallizes out and must be melted by gentle warming before the container can be emptied.

Other preparative methods: II. Addition of SiF_4 to water.
III. Reaction of concentrated H_2SO_4 with BaSiF_6 .

Use: Preparation of fluorosilicates and SiF_4 .

SYNONYMS:

Fluosilicic acid, fluorosilicic acid, silicofluoric acid.

PROPERTIES:

Colorless liquid. Anhydrous H_2SiF_6 is 50% dissociated to SiF_4 and HF even at room temperature. Can be distilled without decomposition only as a 13.3% aqueous solution. Aqueous H_2SiF_6 does not attack glass.

Specific gravity of aqueous solutions at 17.5°C : 6%, 1.049; 20%, 1.173; 34%, 1.314.

REFERENCES:

- I. J. Söll. *Naturforschung und Medizin in Deutschland 1939-1946 (FIAT-Review)* **23**, 257.
- II. W. Hempel. *Ber. dtsh. chem. Ges.* **18**, 1438 (1885).
- III. E. Baur and A. Glaessner. *Ber. dtsh. chem. Ges.* **36**, 4215 (1903).

Germanium Tetrafluoride

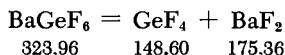

The complex salt BaGeF_6 is precipitated in a Pt dish by adding BaCl_2 to a solution of GeO_2 in hydrofluoric acid. The granular precipitate is washed, dried, placed in a quartz tube and heated in a N_2 stream. Formation of GeF_4 starts at appr. 500°C and proceeds vigorously at 700°C (apparatus for SF_6 , p.169). The temperature is slowly increased to 1000°C . The exit gases are passed through a quartz trap cooled with liquid N_2 so that the GeF_4 condenses and solidifies. The product is then fractionated in a quartz apparatus; the first cut is SiF_4 . The yield is 87%.

Germanium tetrafluoride is stored in glass bottles or, better, sealed under pressure in quartz ampoules.

PROPERTIES:

Colorless gas, thermally stable to 1000°C; fumes strongly in air; has a pungent garlic odor; attacks the respiratory organs and causes hoarseness. Hydrolyzed in water to GeO_2 and H_2GeF_6 . Attacks Hg, but not glass, if absolutely anhydrous. Attacks stop-cock grease.

M.p. -15°C , subl. t. -36.5°C ; $d(\text{liq.}) (0^\circ\text{C})$ 2.162, $d(\text{solid}) (-195^\circ\text{C})$ 3.148.

REFERENCES:

- L. M. Dennis and A. W. Laubengayer. *Z. phys. Chem.* 130, 520 (1927).
 L. M. Dennis. *Z. anorg. allg. Chem.* 174, 119 (1928).
 L. Le Boucher, W. Fischer and W. Biltz. *Z. anorg. allg. Chem.* 207, 65 (1932).

Potassium Hexafluorogermanate

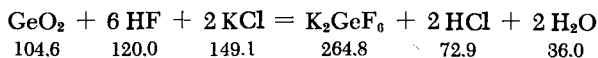

Two parts of GeO_2 are dissolved in 12 parts of 20% HF in a Pt dish and 3 parts of a concentrated KCl solution are added. The liquid solidifies to a gel which on stirring again becomes liquid and precipitates as a dense crystalline powder. The solid is filtered, washed consecutively with small amounts of water and alcohol, and dried. A solution of K_2CO_3 can be employed instead of KCl.

PROPERTIES:

White crystalline powder, nonhygroscopic. Recrystallization from water yields plates.

M.p. $\sim 730^\circ\text{C}$; b.p. $\sim 835^\circ\text{C}$; Solubility: 1 g. in 184.6 g. H_2O (18°C), in 34.0 g. H_2O (100°C). Crystalline form: hexagonal.

REFERENCES:

- C. Winkler, *J. prakt. Chem.* [2] 36, 199 (1887).
 J. H. Müller, *J. Amer. Chem. Soc.* 43, 1089 (1921).
 G. Kruss and O. Nilson. *Ber. dtsh. chem. Ges.* 20, 1697 (1887).

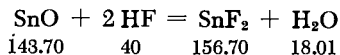
Tin (II) Fluoride

Tin (II) oxide is dissolved in 40% HF in a Pt dish and evaporated to dryness with exclusion of air.

Better defined crystals are obtained if 67.4 g. of SnO (0.5 mole) is dissolved in 15-20 ml. of degassed water in a 200-ml. polyethylene beaker. The contents are heated on a steam bath to 60°C in an O₂-free nitrogen atmosphere and 46 g. of 48% hydrofluoric acid (1.1 moles) is added slowly and dropwise while the beaker is rotated. The reaction evolves heat. When all the solid is dissolved, the beaker is placed in a desiccator and cooled, so that crystals separate. After two hours, the mother liquor is decanted into a second beaker. Both beakers are then placed in a desiccator over a mixture of CaCl₂ and KOH (1 : 1). After two days, this drying agent is removed and Mg (ClO₄)₂ is substituted. After an additional four days, the mother liquor is again decanted and a second crop of crystals thus obtained. It is dried in the same manner as the first. The yield is 86%.

PROPERTIES:

Colorless prisms, soluble in water, yielding a clear solution. Crystal structure: monoclinic.

M.p. 210-215°C.

REFERENCES:

- J. L. Gay-Lussac and L. J. Thénard. *Mém. phys. Chim.* 2, 317 (1809).
 H. Nebergall, J. C. Muhler and H. G. Day. *J. Amer. Chem. Soc.* 74, 1604 (1952).

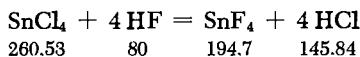
Tin (IV) Fluoride

In the same way as described for TiF₄ (page 250), SnCl₄ is added dropwise to double the theoretical amount of anhydrous HF,

thus forming the complex $\text{SnCl}_4 \cdot \text{SnF}_4$. A copper reflux condenser (ice-salt mixture is used as cooling agent) is attached to the reaction vessel and the system is heated in the presence of excess HF until HCl ceases to evolve. The HF is then distilled off through an inclined condenser. The temperature is finally raised to 130-220°C so that the complex $\text{SnCl}_4 \cdot \text{SnF}_4$ is cleaved and SnCl_4 distills over. A distillation head is then placed on the reaction vessel and SnF_4 is sublimed at red heat. The inclined section of the head should preferably be covered with wet asbestos paper. The SnF_4 is immediately charged into closed Fe or Cu containers.

PROPERTIES:

Snow-white, starlike crystal clumps; extremely hygroscopic; dissolves in water with vigorous fizzing.

Subl. t. 705°C; d(19°C) 4.78.

REFERENCE:

O. Ruff and W. Plato. Ber. dtsch. chem. Ges. 37, 673 (1904).

Lead (II) Fluoride

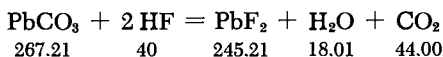

Small portions of nitrate- and acetate-free PbCO_3 are added to hydrofluoric acid contained in a Pb or Pt dish. The HF must be present in excess. The mixture is heated for about one day until CO_2 ceases to evolve. The excess of acid is then decanted and the residue evaporated to dryness on a hotplate. The product is then rapidly melted by placing the Pt dish for a few minutes in an electric furnace which is preheated to red heat. The lead hydrofluoride is thereby decomposed.

Because of its impurities, this PbO is less suitable as a starting material for PbF_2 than Pb(OH)_2 .

PROPERTIES:

White crystalline powder. Dimorphous; rhombic α - PbF_2 (lead chloride type) changes above 316°C into cubic β - PbF_2 (fluorite type).

M.p. 824°C, b.p. 129°C; d 824. Solubility in water (0°C), 0.057 g./100 g. H_2O ; (20°C), 0.065 g./100 g. H_2O . The presence of HNO_3 or nitrates increases the solubility.

REFERENCE:

O. Ruff. Die Chemie des Fluors [Fluorine Chemistry], Springer, Berlin, 1920, p. 33.

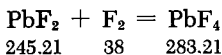
Lead (IV) Fluoride

The apparatus described under BiF_5 (p. 202) contains an alundum boat used for fluorination of PbF_2 at 300°C . The F_2 is initially diluted with CO_2 or N_2 , but its concentration in the gas mixture is slowly increased while the temperature is gradually raised to 500°C . The major portion of the PbF_4 remains in the boat in the form of 1-2 mm. -long needles.

After the fluorination is terminated, the boat with the PbF_4 is pulled into the glass cap placed on the reaction vessel, and the product is scraped out with a Ni wire. The solid drops into the glass ampoules, which are immediately sealed off.

PROPERTIES:

White crystalline substance, very sensitive to moisture, immediately discolors in air yielding brown PbO_2 .

M.p. 600°C ; d 6.7; tetragonal crystals.

REFERENCE:

H. v. Wartenberg. Z. anorg. allg. Chem. 244, 339 (1940).

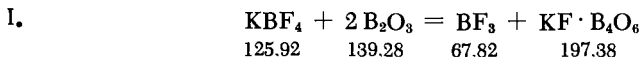
Boron Trifluoride

A mixture of 80 g. of dried or, preferably, melted KBF_4 and 30 g. of B_2O_3 is heated to about 600°C in an inclined iron tube (40 cm. long, 3 cm. diameter), which is sealed at one end. The other end of the iron tube is closed by a flange sealed with a copper gasket. An appr. 10-mm. -diameter iron tube is welded into an

opening in the flange and is connected to a drying tube filled with glass wool, which acts as a dust filter. The drying tube is in turn joined to a quartz or glass trap cooled in liquid nitrogen. The apparatus ends in a drying tube filled with freshly dried KF. The yield is 17 g. of BF_3 . This can be purified by repeated fractional distillation.

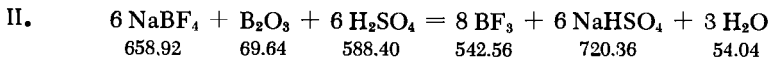

A mixture of 300 g. of NaBF_4 , 50 g. of B_2O_3 and 300 ml. of concentrated H_2SO_4 is carefully heated in a one-liter flask provided with a ground-glass joint (see Fig. 133) until gas evolution starts. Only then can more heat be applied. The exit gas passes through a condenser, then through an absorption tube filled with B_2O_3 which has been interspaced with glass wool, and finally it is condensed in a trap at -196°C . A KF drying tube is placed at the end of the system in order to exclude moisture.

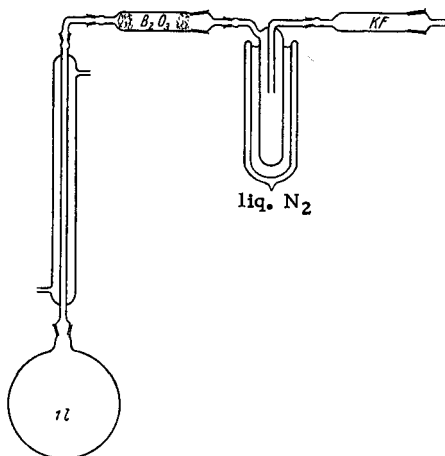
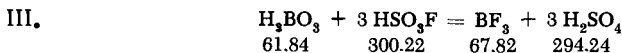

Fig. 133. Preparation of boron trifluoride.

The advantage of this method of preparation is that the residues are water soluble and the reaction vessel can be easily cleaned.

According to Ryss and Polyakova, the best BF_3 yield (80%) is obtained at 180°C with 105.9% sulfuric acid (oleum) in a 200% excess.



Concentrated H_2SO_4 is placed in an iron reaction vessel, which has one gas and two addition nozzles on top and one outlet nozzle

(with a valve) at the bottom. A solution of 20-25% boric acid in concentrated H_2SO_4 and HSO_3F is added at 85 to 135°C. The BF_3 is slowly liberated. The H_2SO_4 which accumulates may be removed from time to time at the bottom and may be used to dissolve the boric acid.

Further preparative methods: IV. Thermal decomposition of diazonium fluoroborates [G. Balz and G. Schiemann, Ber. dtsh. chem Ges. 60, 1186 (1927)].

V. A mixture of 40 g. of KBF_4 , 8 g. of B_2O_3 and 120 ml. of concentrated sulfuric acid is heated to 270°C on a sand bath in a 300-ml. flask equipped with ground-glass joints [P. Baumgarten and H. Henning. Ber. dtsh. chem. Ges. 72, 1747 (1931)].

The older method for preparing BF_3 starting with CaF_2 is not recommended, since the yields are low and the product is contaminated with SiF_4 .

The product is stored in glass containers over Hg or in steel cylinders.

Derivatives: $BF_3 \cdot (OC_2H_5)_2$ p. 786
 $BF_3 \cdot NH_3$ p. 785
 $BF_3 \cdot 2H_2O$ p. 784
 $H[BF_2(OH)_2]$ p. 784
 $n-C_4H_9BF_2$ p. 802

PROPERTIES:

Colorless, asphyxiating gas, fumes in moist air, thermally very stable.

M.p. $-128^\circ C$, b.p. $-101^\circ C$; $t_{cr} -12.25^\circ C$; p_{cr} 50.2 atm. gage; d (liq.) ($-128^\circ C$) 1.769; d (solid) ($-150^\circ C$) 1.87.

Hydrolyzes in water to give H_3BO_3 and HF . The gas attacks rubber. Rubber tubing and stoppers should therefore be avoided in apparatus used in its preparation.

REFERENCES:

- I. W. Hellriegel. Ber. dtsh. chem. Ges. 70, 689 (1937).
- II. H. S. Booth and K. S. Willson. J. Amer. Chem. Soc. 57, 2273 (1935); I. G. Ryss and Y. M. Polyakova. Zh. Obshch. Khim. 19 (81), 1596 (1949) (Chem. Zentr. 50. II. 1329).
- III. U. S. Patent 2,416, 133.

Fluoroboric Acid

HF

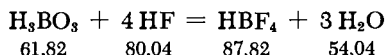

A slightly larger than stoichiometric quantity of H_3BO_3 is added in small portions to an ice-cooled iron reaction vessel containing

70-90% hydrofluoric acid. The reaction is highly exothermic. After the reaction is completed, the excess H_3BO_3 is allowed to settle out and the pure HF_4 is decanted.

Fluoroboric acid is stored in glass containers.

PROPERTIES:

Colorless liquid, does not attack glass at room temperature. Decomposes on heating with water, forming oxyfluoroboric acids. Toxic and inhibits fermentation even when present in traces.

REFERENCES:

- Mathers, Stewart, Housemann and Lee. J. Amer. Chem. Soc. 37, 1516 (1915).
 F. Fichter and K. Thiele. Z. anorg. allg. Chem. 67, 302 (1910).

Sodium Fluoroborate

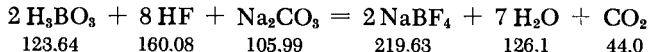

Boric acid (6.2 g.) is added, with cooling, to 25 g. of 40% hydrofluoric acid contained in a Pt dish. The mixture is left standing for six hours at room temperature, then cooled with ice, and 5.3 g of dry Na_2CO_3 is added. The solution is then evaporated until crystallization starts. The salt can be recrystallized from water, whereby large, beautiful single crystals can be obtained. The $NaBF_4$ is finally dried under vacuum.

SYNONYMS:

Sodium fluoborate, sodium borofluoride.

PROPERTIES:

Formula weight 109.815. Colorless salt; crystallizes in the anhydrous form as clear, orthogonal, stubby prisms. Anhydrous $NaBF_4$ does not etch glass. Readily soluble in water. Rhombic crystals, isodimorphous with $NaClO_4$.

REFERENCE:

- G. Balz and E. Wilke-Dörfurt. Z. anorg. allg. Chem. 159, 197 (1927).

Potassium Fluoroborate

Boric acid (6.2 g.) is added to 25 g. of 40% hydrofluoric acid solution contained in an ice-cooled platinum dish. The solution is allowed to stand at room temperature for six hours. At the end of this period it is again chilled with ice, and 5N KOH solution is added with constant stirring until the color of methyl orange changes. Crystalline KBF₄ precipitates out at the same time. The mother liquor and subsequent water washings are decanted and the crystals dried under vacuum. The yield is 90%.

PROPERTIES:

White, crystalline salt, nonhygroscopic.

M.p. 530°C, d_4^{20} 2.505. Solubility in water (20°C) 0.45; (100°C) 6.3 g./100 ml. Dimorphous; rhombic-bipyramidal and cubic structures (trans. temp. 276-280°C).

REFERENCES:

- D. Vorländer, J. Hollatz and J. Fischer. Ber. dtsch. chem. Ges. 65, 535 (1932).

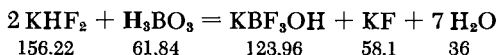
Potassium Hydroxyfluoroborate

Technical grade KHF₂ (100 g.) is dissolved in 250 ml. of water contained in a polyethylene beaker. The K₂SiF₆ and the undissolved KHF₂ are filtered off after several hours of standing; the clear solution is placed in an ice-cold water bath and 40 g. of boric acid is added with stirring. Rapid dissolution occurs. Small crystals separate from the solution within an hour. They are suction-filtered on a fritted glass filter, washed with a small amount of ice-cold water and with 95% methanol solution and acetone. The salt is then dried at 120°C.

PROPERTIES:

Melts without decomposition. Less soluble in water than KBF₄. Yields no precipitate with nitron acetate; hydrolyzed by KOH

more readily than KBF_4 . Recrystallizable from water without decomposition.

REFERENCE:

C. A. Wamser. *J. Amer. Chem. Soc.* 70, 1209 (1948).

Nitrosyl Fluoroborate

NOBF_4

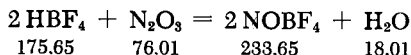

Dry N_2O_3 (prepared by the action of concentrated nitric acid on As_2O_3) is introduced into a platinum dish containing highly concentrated fluoroboric acid (see p. 221) until the dish contents thicken almost completely to a thick slurry and no longer absorb N_2O_3 . The translucent crystalline slurry is suction-filtered on a platinum filter crucible and the remaining liquor separated by pressing. The mother liquor is concentrated in the platinum dish until the appearance of a pronounced white vapor, following which more N_2O_3 is introduced. In this way additional crystals are obtained.

The suction-filtered $\text{NOBF}_4 \cdot \text{H}_2\text{O}$ is vacuum-dried over P_2O_5 for two days. It is then transferred to a thick-wall glass tube, where it is sealed off under liquefied N_2O_3 at -150°C . After several hours of standing the tube is opened and the excess N_2O_3 is allowed to escape. Finally, the preparation is left standing under vacuum and over P_2O_5 and CaO for a period of several days.

In order to obtain pure NOBF_4 the product is vacuum-sublimed at a pressure of 0.01 mm. The sublimation apparatus consists of a glass tube sealed at one end, with an inserted water-cooled cold finger. A connecting tube, emerging from the side, leads to a mercury pump. Heating to $200\text{--}250^\circ\text{C}$ is effected by means of a paraffin bath. The NOBF_4 is collected on the cold finger as a colorless, hard, crystalline deposit and may be scraped off with a knife.

Nitrosyl fluoroborate may be stored in glass bottles. Used to prepare NOF.

PROPERTIES:

Formula weight 116.83. Colorless, birefringent, hygroscopic flakes, crystallizing in rhombic form, which are decomposed by water, releasing nitric oxides. The dry compound does not attack glass.

d_4^{25} 2.185.

REFERENCES:

- E. Wilke-Dörfurt and G. Balz. *Z. anorg. allg. Chem.* 159, 219 (1927);
 G. Balz and E. Mailänder. *Z. anorg. allg. Chem.* 217, 162 (1934).

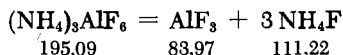
Aluminum FluorideAlF₃

The (NH₄)₃AlF₆, contained in a small platinum vessel, is heated to red heat in a nitrogen stream until constant weight is attained.

Dehydration of AlF₃ · 3H₂O does not produce completely oxide-free AlF₃.

PROPERTIES:

White powder, sparingly soluble in water, acids and alkalis; resistant even to fuming with concentrated H₂SO₄ but may be hydrolyzed with steam at 300–400°C.

Solubility in water (at 25°C): 0.559 g./100 ml.

M.p. above 1260°C, subl. t. 1260°C; d 2.882. Hexagonal crystals.

REFERENCE:

- W. Blitz and E. Rahlfs. *Z. anorg. allg. Chem.* 166, 370 (1927).

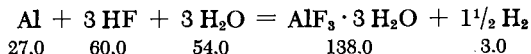
AlF₃ · 3 H₂O

Aluminum foil is added piece-by-piece to 15% HF solution contained in a platinum dish. The reaction temperature is maintained below 25°C by periodic dipping of the dish in an ice-water bath. After some time, the initial rather vigorous reaction virtually ceases even upon addition of further quantities of aluminum. The solution is filtered through a polyethylene filter into a polyethylene dish; additional pieces of aluminum foil are added to the filtrate, and the latter is allowed to crystallize in a refrigerator for 24 hours. The crystals are washed with some water and dried at room temperature on a clay plate.

If AlF₃ · 3 H₂O is not crystallized at 0°C, but instead the solution is evaporated on a steam bath until crystallization begins, a second

modification of $\text{AlF}_3 \cdot 3 \text{H}_2\text{O}$ is obtained. This differs from the previously described product with regard to water solubility and powder diffraction pattern.

PROPERTIES:

White crystalline compound. Drying down to the trihydrate stage may be effected only slowly. Two moles of water of crystallization can be removed on the water bath, yielding the monohydrate.

REFERENCES:

- W. F. Ehret and F. J. Frere. *J. Amer. Chem. Soc.* 67, 64 (1945).
 W. Fischer and E. Bock. *Z. anorg. allg. Chem.* 262, 54 (1950).

Ammonium Hexafluoroaluminate

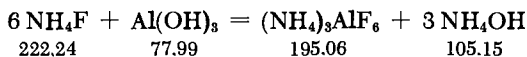
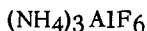

Freshly precipitated hydrated aluminum oxide is introduced portionwise into a hot, rather concentrated NH_4F solution. A gelatinous precipitate results which settles easily when the solution is boiled down. The supernatant liquid is decanted or suction-filtered, and the precipitate is washed with an alcohol-water solution and dried at 105°C .

SYNONYMS:

Ammonium cryolite, ammonium aluminum fluoride.

PROPERTIES:

White, fine crystalline powder, thermally stable to over 100°C . Solubility in water: (0°) 4 g.; (25°C) 7.7 g./liter. Does not attack glass.

d 1.78. Cubic crystals.

REFERENCES:

- H. v. Helmolt. *Z. anorg. allg. Chem.* 3, 127 (1893).
 E. Petersen. *J. prakt. Chem.* (2) 40, 55 (1889).

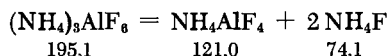
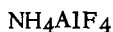
Ammonium Tetrafluoroaluminate

I. Under specific conditions, the thermal decomposition of $(\text{NH}_4)_3\text{AlF}_6$ to AlF_3 and NH_4F proceeds through the intermediate stage of NH_4AlF_4 . A nickel or copper boat containing $(\text{NH}_4)_3\text{AlF}_6$ is placed in a quartz or glass tube. Dry nitrogen gas is introduced on one side, and the whole device is heated in a furnace to 300°C . The subliming NH_4F is collected either in the cooler part of the reaction tube or in a receiver attached to the latter. Pure NH_4AlF_4 remains in the boat. Raising the reaction temperature above 350°C results in further decomposition to AlF_3 . Moisture must be carefully excluded in all these preparations.

II. The ammonium tetrafluoroaluminate may also be produced via the wet route by precipitation of a concentrated hydrofluoric acid- AlF_3 solution with NH_3 .

PROPERTIES:

Crystallizes in the tetragonal system and is isomorphic with TlAlF_4 .

REFERENCES:

E. Thilo. *Naturwiss.* 26, 529 (1938).

C. Brosset. *Z. anorg. allg. Chem.* 239, 301 (1938).

Gallium (III) Fluoride

May be prepared via thermal decomposition of ammonium hexafluorogallate.

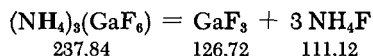

An alundum boat containing $(\text{NH}_4)_3\text{GaF}_6$ is placed in a nickel tube and heated for several hours in a stream of F_2 gas at 400°C .

Dehydration of $\text{GaF}_3 \cdot 3 \text{H}_2\text{O}$, either under vacuum or in a fluorine stream, does not produce oxide-free GaF_3 .

PROPERTIES:

Colorless compound, stable to cold and hot water. In contrast to $\text{GaF}_3 \cdot 3 \text{H}_2\text{O}$, GaF_3 is very sparingly soluble in water. May be sublimed without decomposition in a nitrogen stream at temperatures above 800°C .

M.p. $>1000^\circ\text{C}$, b.p. $\sim 950^\circ\text{C}$, $d \sim 3$; after heating in a fluorine stream to 630°C , d 4.47. Solubility in water (room temperature) 0.0024 g./100 ml.; in hot hydrochloric acid, 0.0028 g./100 ml.

REFERENCE:

O. Hannebohn and W. Klemm. *Z. anorg. allg. Chem.* **229**, 342 (1936).

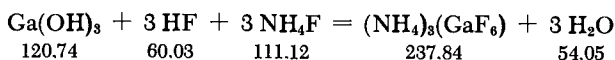
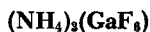
Ammonium Hexafluorogallate

Two grams of $\text{Ga}(\text{OH})_3$ are dissolved in 40% HF solution contained in a platinum dish and the solution evaporated almost to dryness. The residue is dissolved in the least possible quantity of water, and cold, saturated solution of 6 g. of NH_4F is added. The $(\text{NH}_4)_3\text{GaF}_6$ settles out immediately in well-formed crystals.

PROPERTIES:

Colorless crystalline salt, converts to Ga_2O_3 on heating in air; heating in vacuum at 220°C results in formation of GaN , proceeding through several stages. Crystallizes in octahedra.

REFERENCE:

O. Hannebohn and W. Klemm. *Z. anorg. allg. Chem.* **229**, 341 (1936).

Indium (III) Fluoride

I. Thermal decomposition of $(\text{NH}_4)_3\text{InF}_6$ in a stream of fluorine gas.

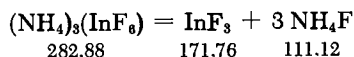

A small sintered corundum vessel containing $(\text{NH}_4)_3\text{InF}_6$ is placed in a nickel tube and heated in a fluorine stream to constant weight.

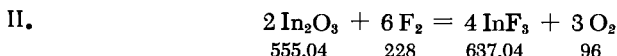

A small sintered alumina vessel containing In_2O_3 is fluorinated in a quartz tube (in an apparatus similar to that used for the preparation of TlF_3). After gentle initial heating, the reaction proceeds (occasionally with incandescence) without additional supply of heat. The progress of the conversion may be checked since the yellow oxide becomes colorless and an increase in volume takes place simultaneously. To obtain a completely oxide-free preparation the product must be kept for several hours at 500°C in a nickel tube, while a stream of fluorine is passed over it.

PROPERTIES:

Colorless compound, stable to cold and hot water; very sparingly soluble in water (in contrast to $\text{InF}_3 \cdot 3\text{H}_2\text{O}$) although readily soluble in dilute acids. Reduced to almost pure InF_2 by a very slow stream of hydrogen at 300°C ; a fast stream of the latter reduces it to the metal.

M.p. 1170°C , b.p. $>1200^\circ\text{C}$; d 4.39. Solubility in water at room temperature: 0.040 g./100 ml.

REFERENCE:

O. Hannebohn and W. Klemm. Z. anorg. allg. Chem. 299, 342 (1936).

Ammonium Hexafluoroindate

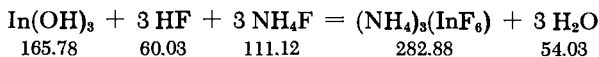
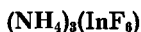

Two grams of In(OH)_3 are dissolved in 40% HF solution contained in a polyethylene dish and concentrated almost to dryness. The residue is dissolved in the least possible amount of water, and a cold, saturated solution containing 6 g. of NH_4F is added. The volume is then reduced until crystallization begins.

PROPERTIES:

Colorless substance, crystallizing as octahedra; heating in vacuum decomposes it, forming InN .

REFERENCE:

- O. Hannebohn and W. Klemm. *Z. anorg. allg. Chem.* 229, 342 (1936).

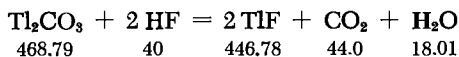
Thallium (I) Fluoride**TlF**

Thallium carbonate is dissolved in an excess of 40% HF solution and evaporated twice to dryness. The product is then melted in a platinum crucible.

May be used for the preparation of fluorine-containing esters.

PROPERTIES:

Formula weight 223.39. Yellow liquid; hard, shiny, white, nonhygroscopic crystals which deliquesce when breathed upon, but resolidify at once.

M.p. 327°C, b.p. 655°C; d_4^{20} 8.36. Solubility in water at 20°C: 78.8 g. in 21.2 g. H₂O. A concentrated aqueous solution is strongly alkaline. Sparingly soluble in alcohol. It has a rhombic (deformed rock salt) structure.

REFERENCES:

- J. A. A. Ketelaar. *Z. Kristallogr.* 92, 30 (1935).
E. Hayek. *Z. anorg. allg. Chem.* 225, 47 (1935).

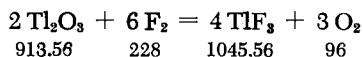
Thallium (III) Fluoride**TlF₃**

The fluorination of Tl₂O₃ is accomplished in an apparatus (see Fig. 134) consisting of a quartz reaction tube containing a quartz boat with the reagent. The fluorine gas is introduced via a 3-m.-long copper capillary which permits rotation of the reaction tube through a 90° angle. The reaction begins even at room temperature. The chocolate-brown Tl₂O₃ changes color, going through black to

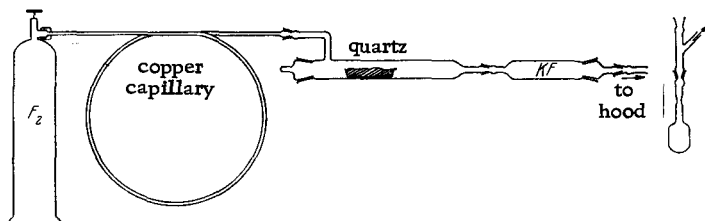

Fig. 134. Preparation of thallium (III) fluoride.

brown-red. The product finally becomes pure white. Fluorination should proceed very slowly, since otherwise the product fuses into a yellowish mass and not all of the material reacts. Toward the end of the fluorination the temperature is increased to 300°C.

This apparatus is suitable for all fluorinations involving elemental fluorine where the product is a nonvolatile fluoride (CuF_2 , AgF_2 , CeF_4 , CoF_3 , GaF_3 , InF_3).

As soon as the reaction is completed, the drying tube is removed and a quartz tube with an ampoule is attached (see Fig. 134). The reaction tube is now rotated 90° and the preparation is poured into the quartz ampoule while maintaining a fluorine stream. The TlF_3 , sealed in the quartz ampoule in this way, can be preserved for a long period of time.

PROPERTIES:

Formula weight 261.39. White substance, very sensitive to moisture, reacts instantaneously with water, forming a black precipitate. Heating TlF_3 in air causes decomposition, but it can be melted in a fluorine atmosphere.

M.p. 550°C, b.p. >550°C; d_4^{25} 8.36.

REFERENCE:

O. Hannebohn and W. Klemm. *Z. anorg. allg. Chem.* **229**, 343 (1936).

Beryllium Fluoride

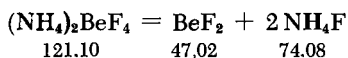

Ammonium tetrafluoroberyllate (see next preparation) is placed in a Pt boat and heated to a red glow, excluding atmospheric

moisture as far as possible. Ammonium fluoride sublimes, and the BeF_2 remains in the boat in the form of a translucent glass.

PROPERTIES:

Colorless, very hygroscopic, soluble in water in all proportions, insoluble in anhydrous HF, sparingly soluble in absolute alcohol, considerably more soluble in 90% alcohol, appreciably soluble in alcohol-ether solution. Volatilizes noticeably at 800°C .

M.p. 800°C (melts in the same manner as glass, that is, with preliminary softening).

d_4^{25} 1.986. Tetragonal structure.

REFERENCE:

P. Lebeau. Comptes Rendus Hebd. Séances Acad. Sci. 126, 1418 (1898).

Ammonium Tetrafluoroberyllate

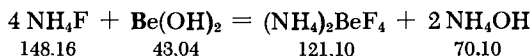
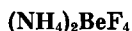

Beryllium hydroxide is introduced portionwise into hot NH_4F solution. Concentration and cooling of the nearly saturated, clear solution leads to very rapid precipitation of small, colorless needles and prisms. They are suction-filtered, washed with some dilute alcohol, and dried at 105°C .

PROPERTIES:

Colorless crystals, decrepitate on heating, with subsequent melting and evolution of NH_4F . Crystallizes in rhombic bipyramidal form.

REFERENCE:

H. v. Helmholt. Z. anorg. allg. Chem. 3, 129 (1893).

Magnesium Fluoride

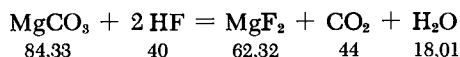

Magnesium carbonate is dissolved in an excess of 40% HF solution contained in a platinum dish; the solution is concentrated

to dryness and dried in vacuum at 150°C. In order to obtain coarse MgF_2 crystals, the product is heated together with NH_4F . Magnesium fluoride may be stored in glass containers.

PROPERTIES:

Colorless compound, very slightly soluble in water. Solubility (18°C) 0.087 g./liter.

M.p. 1248°C, b.p. 2260°C; d 3.148. Hardness: 6 (Mohs). Rutile structure.

REFERENCE:

W. Klemm, W. Tilk and S. von Müllenheim. Z. anorg. allg. Chem. 176, 13 (1928); private communication from the Institute of Inorganic Chemistry of the University of Münster, unpublished.

Calcium Fluoride

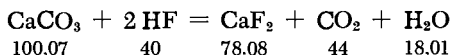

Hydrofluoric acid (40%) is added with constant agitation to a suspension of 100 g. of $CaCO_3$ in 100 ml. of boiling water contained in a large polyethylene dish. The addition is continued until evolution of CO_2 gas almost ceases. The mixture is filtered hot, and the precipitate on the filter is treated with dilute acetic acid until all effervescence stops. It is then thoroughly washed with hot water and finally dried at 300°C.

Fluorine ions precipitated with Ca^{2+} ions in the absence of carbonate produce gelatinous CaF_2 , which is difficult to filter and wash.

May be used for manufacture of fluorspar apparatus (see p. 152).

Repeated treatment of natural fluorspar powder with concentrated hydrochloric and hydrofluoric acids results in almost pure crystalline CaF_2 , which nevertheless is not well suited for making fired fluorspar vessels.

PROPERTIES:

White powder. Solubility in water at 18°C: 0.015 g./liter; soluble to some extent in mineral acids.

M.p. 1418°C, b.p. 2500°C; d. 3.18. Cubic (fluorite) structure.

REFERENCE:

- O. Ruff, Die Chemie des Fluors [Fluorine Chemistry], Springer Verlag, Berlin, 1920, p. 89.

Strontium Fluoride

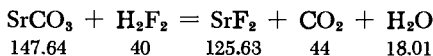

Strontium carbonate is dissolved in an excess of 40% hydrofluoric acid solution contained in a platinum dish. The solution is evaporated to dryness on a hot plate and dehydrated under vacuum at 150°C.

Strontium fluoride is stored in glass containers.

PROPERTIES:

Colorless powder. Solubility in water (18°C) 0.117 g./liter. M.p. 1190°C, b.p. 2460°C; d. 2.44. Cubic (fluorite) structure.

REFERENCE:

- J. J. Berzelius. Pogg. Ann. 1, 20 (1824).

Barium Fluoride

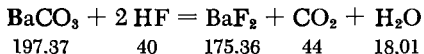

Barium carbonate is dissolved in an excess of 40% HF solution contained in a platinum dish. The solution is evaporated to dryness and the residue heated to a red glow.

The substance is stored in glass containers.

PROPERTIES:

Colorless, transparent, small crystals. Solubility in water (18°C) 1.6 g./liter. Soluble in HF and NH₄Cl solutions.

M.p. 1353°C, b.p. 2260°C; d 4.83. Cubic (fluorite) structure.

REFERENCE:

W. Olbrich. Thesis, Technische Hochschule, Breslau, 1929, p. 2.

Lithium Fluoride

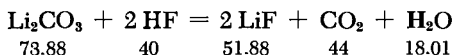

Lithium carbonate is added to 40% HF solution contained in a platinum dish. The mixture is evaporated to dryness, thoroughly calcined, pulverized with a platinum pestle and stored in paraffin bottles.

Lithium fluoride may be used in the preparation of single crystals for optical, photoelectric and dielectric studies, as well as for coating crucibles used in melting Li metal.

PROPERTIES:

Formula weight 25.94. White, granular powder. Solubility in water (18°C) 0.27 g./100 ml.

M.p. 842°C, b.p. 1676°C. Volatilizes between 1100 and 1200°C; d. (solid)(20°C) 2.640, d. (liq.) (1058°C) 1.699. Cubic (rock salt) structure.

REFERENCE:

H. von Wartenberg and H. Schulz. Z. Elektrochem. 27, 568 (1921).

Sodium Fluoride

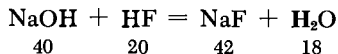

The stoichiometric quantity of NaOH or Na₂CO₃ is added to 40% HF solution contained in a polyethylene dish. Sodium fluoride precipitates out at once; it is suction-filtered and dried in an oven at 110°C.

Dry NaF may be stored in glass containers.

PROPERTIES:

White powder. Solubility in water (15°C) 4 g.; (25°C) 4.3 g./100 ml.; insoluble in alcohol.

M.p. 993°C, b.p. 1704°C; d 2.78. Cubic (rock salt) structure.

REFERENCE:

A. E. Müller. Chem. Ztg. 52, 5 (1928).

Potassium Fluoride**KF**

I.

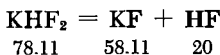

Thermal decomposition of KHF_2 yields the purest KF. To obtain this, KHF_2 contained in a platinum dish is heated in an electric furnace to 500°C (under a hood). A platinum funnel is placed over the dish and well-dried nitrogen is introduced through the funnel stem.

II.

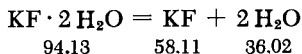

The stoichiometric quantity of chlorine-free potassium hydroxide (or K_2CO_3 solution) is introduced into a polyethylene dish containing 40% HF solution. The $\text{KF} \cdot 2\text{H}_2\text{O}$ separates out as a crystalline slurry on cooling. The latter is suction-filtered in polyethylene equipment, pressed between filter paper sheets and dried as much as possible without melting in a vacuum drying oven (m.p. 46°C).

PROPERTIES:

White, hygroscopic, deliquescent powder. Solubility in water (18°C) 92.3 g./100 ml.; insoluble in alcohol.

M.p. 857°C, b.p. 1503°C; d 2.48. Cubic (rock salt) structure.

REFERENCE:

E. Lange and A. Eichler. Z. phys. Chem. 129, 286 (1927).

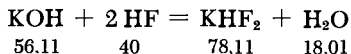
Potassium Hydrogen Fluoride

The stoichiometric quantity of chlorine-free potassium hydroxide (or K_2CO_3 solution) is introduced into an ice-cooled Pt, Ag or Ni dish containing 40% HF solution. The KHF_2 precipitates out and can be suction-filtered at once. It can be recrystallized from hot water. It is dried at 120–150°C in a stream of completely dry air.

To produce absolutely anhydrous KHF_2 , the precipitate is treated with fluorine gas in a cylindrical iron or copper vessel provided with a bottom tube through which fluorine gas can be introduced. The vessel cover is equipped with a gas outlet. The drying process is complete when fluorine gas is detected at the outlet.

The product may be stored in aluminum cans; large quantities of the substance are kept in wooden drums.

It is used in the preparation of fluorine gas and pure KF.

SYNONYM:

Potassium bifluoride.

PROPERTIES:

Colorless salt, readily soluble in water.
M.p. 239°C; d 2.37. Tetragonal structure.

REFERENCE:

E. Lange and A. Eichler. *Z. phys. Chem.* **129**, 285 (1927).

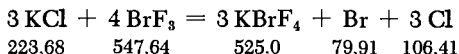
Potassium Tetrafluorobromate (III)

A large excess of BrF_3 is slowly (dropwise) added to about 0.5 g. of KCl contained in a quartz vessel. The mixture is then kept for several minutes at 20°C and then rapidly cooled. The quartz container is then connected to a quartz trap immersed in liquid nitrogen, which in turn is connected to a vacuum pump. The excess BrF_3 is vacuum distilled into the quartz trap.

PROPERTIES:

White, crystalline powder; decomposes on heating, with elimination of BrF_3 . Reacts rapidly with water (decomposition), but less vigorously than BrF_3 . Stable to CCl_4 , acetone and dioxane. Attacks platinum metal when heated.

REFERENCE:

A. G. Sharpe and H. J. Emeléus. J. Chem. Soc. (London) 1948, 2136.

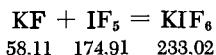
Potassium Hexafluoroiodate (V)

Potassium fluoride is dissolved in boiling iodine (V) fluoride contained in a quartz vessel. The solubility is 1 g. of KF per 100 g. of IF_5 . The KIF_6 precipitates out as white crystals when the solution is cooled. The excess iodine (V) fluoride is removed by evaporation at 15-20°C and a pressure of 2-5 mm.

PROPERTIES:

White crystals, slightly soluble in cold, but more readily soluble in hot iodine (V) fluoride. Decomposes when heated to 200°C; hydrolyzed by water with evolution of heat; stable to CCl_4 .
M.p. about 200°C.

REFERENCE:

H. J. Emeleus and A. G. Sharpe. J. Chem. Soc. (London) 1949, 2206.

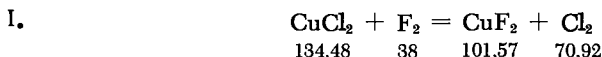
Copper (II) Fluoride

Anhydrous CuCl_2 contained in a copper boat is fluorinated with F_2 or ClF_3 at 400°C in the apparatus already described for the preparation of TlF_3 (see p. 231).

II.

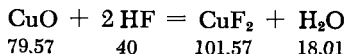

Copper (II) oxide is dissolved in an excess of 40% hydrofluoric acid solution contained in a polyethylene dish, so as to form solid $\text{CuF}_2 \cdot 5 \text{H}_2\text{O} \cdot 5 \text{HF}$. This is then transferred to a small platinum boat, which is inserted in a copper or nickel tube. The salt is dehydrated at 400°C in a completely dry HF stream (see Fig. 141, p. 267). The excess HF is displaced by a stream of nitrogen. The product is cooled under a nitrogen blanket.

The product is stored in sealed glass ampoules.

PROPERTIES:

White, crystalline powder, sensitive to air, sparingly soluble in cold water, hydrolytically cleaved by hot water. Solubility in water (20°C) 4.7 g./100 ml.

M.p. 950°C .

REFERENCES:

P. Henkel and W. Klemm. *Z. anorg. allg. Chem.* **222**, 74 (1935);
H. von Wartenberg. *Z. anorg. allg. Chem.* **241**, 381 (1939).

Silver Subfluoride



Prepared by cathodic reduction of silver fluoride solution:

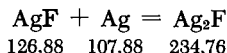

Silver carbonate is added to warm, pure 40% hydrofluoric acid solution until no more dissolves. After addition of 2 g. of NH_4F , the undissolved material is filtered off in the dark.

A platinum dish serves as the electrolysis vessel and the cathode. It is placed on a water bath at 50°C . A 100-g. solid Ag bar with a welded-on Ag lead wire is used as the anode. The maximum current density of the cathode is 0.002 amp./ cm^2 . The voltage drop across the electrodes is 1.4 v. A 6-v. battery is used as the power supply; the current is 0.07-0.1 amp.

Under these conditions, 15-20 g. of large, greenish, shiny crystals is produced in 48 hours. Occasionally Ag precipitates out instead of Ag_2F at the start of the reaction. Since during electrolysis Ag passes into solution, the silver concentration of the solution remains constant.

Following electrolysis the crystals are separated from the electrolyte by decantation. They are freed from the adhering AgF solution by pressing between filter paper and are stored in a desiccator.

PROPERTIES:

Large, shiny, bronze-colored, greenishly opalescent crystals which slowly turn gray-black on exposure to light. On heating to 150°C Ag₂F turns gray; at 700°C it disproportionates quantitatively into AgF + Ag. Decomposes in water to gray Ag powder. Stable to alcohol.

d. 8.57. Hexagonal structure.

REFERENCES:

A. Hettich. Z. anorg. allg. Chem. 167, 67 (1927).

R. Scholder and K. Traulsen. Z. anorg. allg. Chem. 197, 57 (1931).

Silver Fluoride

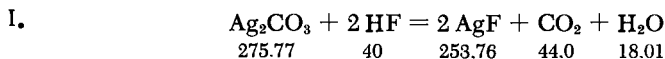

Coarse-grained Ag₂CO₃ is prepared by precipitation from AgNO₃ solution with dilute NaHCO₃ or Na₂CO₃ solution. The precipitate is purified by washing until the test for nitrate ion is negative.

The Ag₂CO₃ thus obtained is dissolved in an excess of 40% hydrofluoric acid solution contained in a platinum dish; the clear solution is rapidly evaporated on an open flame until the beginning of crystallization. It is then evaporated to dryness on a sand bath (constant agitation with a platinum spatula; rubber gloves must be worn). The fine AgF produced is brown-black (contains Ag₂O and Ag). May be used for fluorination without further purification.

To prepare very pure AgF, anhydrous HF is passed over coarse-grained Ag₂CO₃ contained in a platinum tube the temperature of which is gradually raised to 300°C. The apparatus used is identical to the one used for the preparation of CoF₂ (Fig. 141, p. 267). After cooling in a stream of dry nitrogen, the pure, dry product is easily poured from the platinum tube. The yield is quantitative.

II. Pure, crystalline anhydrous AgF can be more conveniently obtained via electrolysis of a solution of KF in acetic acid, using silver anodes. A 7% solution of KF in glacial acetic acid is electrolyzed in a vessel containing an Ag ingot or bar as the anode and

a platinum gauze cathode. The current must be greater than 40 ma. Under these conditions, the AgF formed at the anode falls off and collects at the bottom of the electrolytic bath. The product is filtered, washed consecutively with glacial acetic acid and anhydrous benzene, and placed in a vacuum desiccator at room temperature to remove the adhering benzene. The yield is 99.5%. At 120 ma. and 20 v., 0.5 g. of AgF is obtained in 60 minutes. III. *Other preparative methods*: thermal decomposition of AgBF_4 [A. G. Sharpe. J. Chem. Soc. (London) 1952, 4538].

Silver subfluoride is stored in opaque glass bottles. Used to fluorinate organic compounds.

PROPERTIES:

White, flaky crystals with a flexibility similar to that of horn; pulverized with difficulty, but may be hammered into plates and cut with shears. Very hygroscopic. Darkens upon exposure to light. Solubility in water (15°C) 135 g./100 ml. Also soluble in HF, CH_3COOH and CH_3CN .

M.p. 435°C; d. 5.852. Cubic (rock salt) structure.

REFERENCES:

- I. O. Ruff. Die Chemie des Fluors [Fluorine Chemistry], Berlin, 1920, p. 37; K. Fredenhagen. German Patent Application F 293 30 IV b/12 i, August 1, 1930.
- II. H. Schmidt. Z. anorg allg. Chem. 270, 196 (1952).

Silver (II) Fluoride

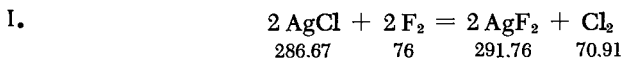

Fluorine gas is passed over a nickel boat containing AgCl. The boat is placed in a nickel tube (the apparatus is identical to that described for the preparation of TlF_3 , p. 231). External cooling must be provided at the start of the reaction so that the temperature does not exceed 80°C. Otherwise a ternary mixture consisting of AgCl, AgF and AgF_2 is formed. This fuses, making further absorption of fluorine difficult. The temperature is then gradually increased to 250°C. The product is allowed to cool in a fluorine stream. The fluorine is then displaced with dry N_2 . The yield is 95%, based on AgCl.

II.

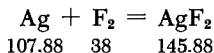

"Molecular" Ag is fluorinated in the apparatus described above. The reaction begins at room temperature with evolution of heat, resulting in a yellow to brown product. Careful external cooling should be provided so that the temperature does not exceed 60°C. When the reaction subsides the temperature is gradually increased to 250°C. The product is allowed to cool in a fluorine stream, which is then displaced with dry N₂.

The product may be stored in sealed quartz ampoules or in iron containers. It may be used for fluorination of organic compounds as well as for the preparation of COF₂.

PROPERTIES:

White when pure; otherwise somewhat brown-tinged. Thermally stable up to 700°C; high chemical reactivity. Instantly hydrolyzed by water.

M.p. 690°C; d 4.7; ΔH (formation) 84.5 kcal.

REFERENCES:

- I. W. S. Struve et al. *Ind. Eng. Chem.* 39, 353 (1947).
- II. O. Ruff and M. Giese. *Z. anorg. allg. Chem.* 219, 143 (1934);
H. von Wartenberg. *Z. anorg. allg. Chem.* 242, 406 (1939).

Zinc Fluoride

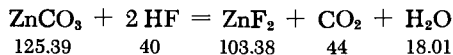

Zinc carbonate is added to an excess of hot aqueous hydrofluoric acid. Initially, a clear solution results. Further addition of ZnCO₃ causes precipitation of ZnF₂ as white, opaque crystals. The mixture is then evaporated to dryness on a hot plate.

This only partially dehydrated form of ZnF₂ is used for fluorination. Absolutely anhydrous ZnF₂ is much less reactive and therefore less suitable.

To obtain anhydrous ZnF₂, the precipitate must be heated to 800°C with exclusion of atmospheric moisture. It is heated in the presence of NH₄F so as to produce larger crystals.

May be stored in glass bottles.

PROPERTIES:

Transparent crystalline needles, sparingly soluble in water, somewhat soluble in dilute hydrofluoric acid, soluble in hydrochloric and nitric acids and ammonia. Solubility in water: $5 \cdot 10^{-5}$ moles/liter.

M.p. 872°C, b.p. 1500°C; d 4.84. Tetragonal (rutile) structure.

REFERENCES:

- O. Ruff. Die Chemie des Fluors [Fluorine Chemistry], Berlin, 1920, p. 36; private communication from the Institute of Inorganic Chemistry of the University of Münster, unpublished.

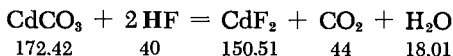
Cadmium Fluoride

Cadmium carbonate is added to an excess of 40% hydrofluoric acid solution contained in a platinum dish; the mixture is evaporated to dryness on a hot plate and dehydrated in vacuum at 150°C. The product is stored in glass containers.

PROPERTIES:

Colorless compound. Solubility in water (25°C) 4.3 g./100 ml. Soluble in hydrofluoric acid and other mineral acids, insoluble in alcohol and liquid ammonia.

M.p. 1049°C, b.p. 1748°C; d 6.33. Cubic (fluorite) structure.

REFERENCE:

- W. Klemm, W. Tilk and S. von Müllenheim. Z. anorg. allg. Chem. 176, 13 (1928).

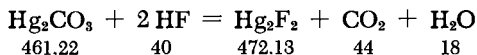
Mercury (I) Fluoride

Mercury (I) nitrate (150 g.) is dissolved in a solution of about 60 ml. of dilute HNO₃ in about 450 ml. of water. The solution is

poured in a fine stream into a vigorously agitated solution of 50 g. of KHCO_3 in one liter of water. Following repeated washing with CO_2 -saturated water (Dry Ice added to water), it is filtered with good suction. The wet Hg_2CO_3 is added in small portions and with constant stirring to 40% hydrofluoric acid solution contained in a platinum dish. A yellow powder of Hg_2F_2 settles out. The addition of Hg_2CO_3 is continued as long as CO_2 is vigorously evolved; the highly dilute supernatant hydrofluoric acid is then poured off and a new portion of 40% hydrofluoric acid solution is added. The resulting mixture is evaporated to dryness on a water bath. The product is then pulverized and heated for 2-3 hours in a drying oven at 120-150°C. The product is then immediately poured into copper containers and vacuum-sealed.

The product must be prepared in the dark or at least in diffuse light.

PROPERTIES:

Yellowish crystalline powder, blackens rapidly on exposure to light; more readily soluble in water (hydrolysis) than Hg_2Cl_2 . M.p. 570°C; d (15°C) 8.73. Tetragonal structure.

REFERENCES:

- O. Ruff. Die Chemie des Fluors [Fluorine Chemistry], Berlin, 1920, p. 34.
 A. L. Henne and M. W. Renoll. J. Amer. Chem. Soc. 60, 1060 (1938).

Mercury (II) Fluoride



I.

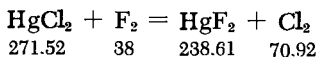

A horizontal copper cylinder which can be rotated like a revolving drum about its own axis (20 r.p.m.) serves as the reaction vessel. Fluorine gas is introduced through one side of the hollow axis, while the other serves as an outlet for the reaction gas (see Fig. 135).

The copper drum is filled with dry, pulverized HgCl_2 and several small pieces of copper, intended to break up crust formations. An exothermic reaction begins as soon as the fluorine is introduced. The progress of the reaction is followed by withdrawal of samples.

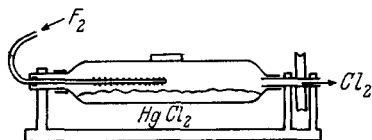
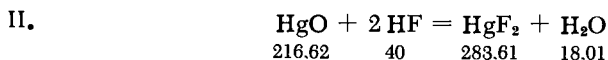

Fig. 135. Preparation of mercury (II) fluoride.

The samples are dissolved in nitric acid and tested for chloride ion. The reaction is considered complete as soon as chloride ion is not detectable. The product is poured into sealed copper containers. The yield is 75%, based on HgCl_2 .



In an apparatus similar to that described for the preparation of CoF_2 (p. 267), 11 parts by weight of HgO , contained in a small nickel boat, are fluorinated for 4.5 hours at $380\text{--}450^\circ\text{C}$ with a gas mixture consisting of 30 parts by weight of anhydrous HF and 2 parts of O_2 .

Small amounts of HgF_2 can be prepared in an apparatus similar to that described for the preparation of TlF_3 (Fig. 134, p. 231).

Mercury (II) fluoride may be used as a fluorinating agent in organic chemistry.

PROPERTIES:

White powder, very sensitive to moisture; hydrolyzed instantly by water, yielding a yellow color.

M.p. 645°C , b.p. $>650^\circ\text{C}$; $d(15^\circ\text{C})$ 8.95. Cubic (fluorite) structure.

REFERENCES:

- I. A. I. Henne and T. Midgley. *J. Amer. Chem. Soc.* **58**, 886 (1936).
- II. U.S. Patent 2,757,070.

Scandium Fluoride

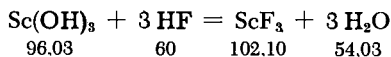

Scandium oxide or hydroxide is added to 40% hydrofluoric acid contained in a polyethylene dish until saturated. It is then

evaporated; the precipitate formed is filtered off and vacuum-dried at 150-180°C.

PROPERTIES:

White powder, very sparingly soluble in water, somewhat soluble in alkali carbonate and ammonium carbonate solutions. Completely decomposed by alkali fusion. Hexagonal structure.

REFERENCE:

Gmelin-Kraut VI, 2, p. 681.

Yttrium Fluoride

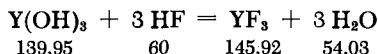
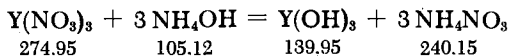

The hydroxide is precipitated from aqueous yttrium nitrate with ammonia. The product is washed and repeatedly evaporated to dryness in a platinum dish together with aqueous hydrofluoric acid solution.

PROPERTIES:

White powder, insoluble in HF, soluble in H₂SO₄ d. 4.01. Cubic structure.

REFERENCES:

E. Zintl and A. Udgard. Z. anorg. allg. Chem. 240, 152 (1939).
W. Nowacki. Z. Kristallogr.(A)100, 242 (1939).

Lanthanum Fluoride

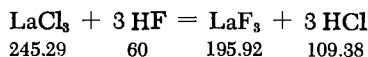

A hydrochloric acid solution of LaCl₃ contained in a polyethylene dish is treated with 40% hydrofluoric acid; the excess HF is decanted and the residue is evaporated to dryness.

PROPERTIES:

Colorless solid, insoluble in water. Hexagonal (tysonite) structure.

REFERENCE:

G. P. Drossbach. Thesis, Technische Hochschule, Munich, 1905, p. 9.

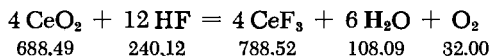
Cerium (III) Fluoride

A mixture of CeO_2 and an excess of hydrofluoric acid is evaporated to dryness in a polyethylene dish.

PROPERTIES:

Formula weight 197.13. Colorless, powdery product. M.p. 1460°C ; d 6.16.

REFERENCE:

H. von Wartenberg. Z. anorg. allg. Chem. 244, 343 (1940).

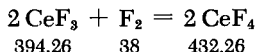
Cerium (IV) Fluoride

In an apparatus similar to that described for the preparation of TlF_3 (p. 231), CeF_3 is fluorinated in a sintered alumina vessel at 500°C .

PROPERTIES:

Formula weight 216.13. White, fine, crystalline salt, insoluble in water; hydrolyzes very slowly in cold water.

M.p. $>650^{\circ}\text{C}$; d 4.77. Can be reduced to CeF_3 with hydrogen at 300°C .

REFERENCES:

- H. von Wartenberg. *Z. anorg. allg. Chem.* 244, 343 (1940).
 W. Klemm and P. Henkel. *Z. anorg. allg. Chem.* 220, 181 (1934).

Europium (II) Fluoride

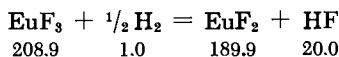

A small platinum vessel containing EuF_3 (the preparation is the same as that of LaF_3 or CeF_3) is placed in a 20-cm.-long platinum tube, which in turn is fitted quite exactly into a quartz tube. It is heated rapidly to 900°C in a high-velocity stream of carefully purified hydrogen and then reduced at 1100°C over a period of three hours.

PROPERTIES:

Light yellow solid; C1-type structure (fluorite).

REFERENCES:

- W. Klemm and W. Döll. *Z. anorg. allg. Chem.* 241, 234 (1939).
 G. Beck and W. Nowacki. *Naturwiss.* 27, 495 (1938).

Titanium (III) Fluoride

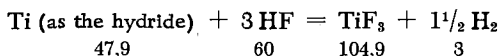

Titanium metal is hydrogenated at $600\text{--}700^{\circ}\text{C}$ (see section on Titanium). It is then placed in a small nickel boat *s*, which in turn is inserted into the horizontal nickel tube *a* (closed at one end), and the hydride is fluorinated with gaseous HF (see Fig. 136). The open end of the tube has a cooling jacket and is sealed with picein to a copper cover *b*. Two copper tubes are silver-soldered into the cover and serve as inlet and outlet for the hydrogen; in addition,

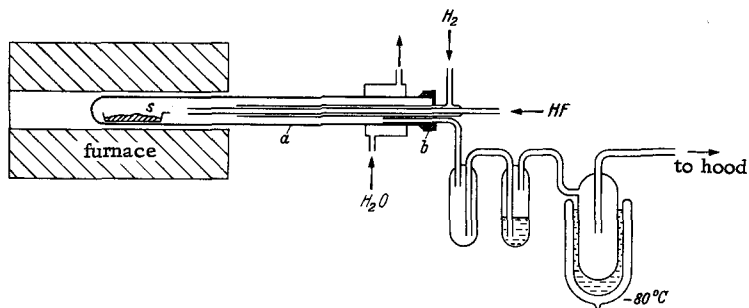

Fig. 136. Preparation of titanium (III) fluoride. *a*) Nickel tube; *b*) copper cover; *c*) small nickel boat.

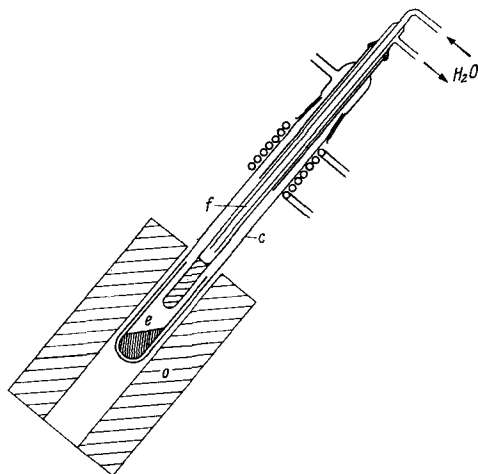

Fig. 137. Sublimation of titanium (III) fluoride. *c*) Quartz tube; *f*) cold finger; *e*) Ni crucible; *o*) tubular furnace.

the inlet tube contains a concentric silver tube for the introduction of HF. The output gases pass through an empty polyethylene bottle, a bubble counter filled with paraffin oil and a polyethylene trap to freeze out excess HF gas. The closed end of the reaction tube is placed in a tubular furnace. The temperature is measured externally.

After thorough flushing of the apparatus with H_2 there follows a fluorination with a 1 : 4 mixture of H_2 ; HF for a period of four to five hours. The HF flow is first started at a temperature above $200^\circ C$. The temperature of the water in the cooling jacket should be higher than $20^\circ C$ to prevent condensation of the HF. After

completion of the fluorination the product is left to cool in a stream of hydrogen. The yield is 90%.

A nickel crucible *e* containing the product (5 g.) is placed at the closed end of a quartz tube *c*, which is then inserted into the oblique tubular furnace *o*. The open end of the tube *c* is closed off with an adapter provided with outlets to a vacuum pump. A water-cooled copper cold finger *f* is sealed into the cap with picein. The cold finger terminates in a copper rod on which the TiF_3 crystals grow. The TiF_3 begins to sublime at 10^{-2} to 10^{-3} mm. About 80% of the product, in the form of bright blue crystals, collects on the cold finger over a period of four hours at 1000°C . A gray-black residue remains in the crucible. The TiF_3 thus obtained is so pure that it can be used directly for magnetic measurements.

PROPERTIES:

Blue, rhombic crystals, stable in air, unusually resistant to acids and bases. Sublimation begins at about 930°C in a vacuum of less than 0.1 mm.

M.p. $>1100^\circ\text{C}$; d_4^{25} 2.98. Insoluble in water and alcohol. Disproportionation to TiF_4 and Ti begins at 950°C .

REFERENCE:

P. Ehrlich and G. Pietzka. Z. anorg. allg. Chem. 275, 121 (1954).

Titanium (IV) Fluoride

TiF_4

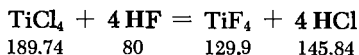

A copper or platinum Erlenmeyer flask with a detachable distillation head serves as the reaction vessel. A copper drying tube containing CaCl_2 is either attached directly at the outlet of the head or after a descending condenser.

A weighed quantity of ice-cold anhydrous HF is poured into the flask, which is cooled by an ice-salt mixture (the reaction should be carried out under a hood). One half of the TiCl_4 , (calculated from the above equation) is weighed into a test tube and added dropwise to the HF solution. Each drop causes a vigorous reaction and evolution of HCl gas. The mixture contained in the flask is left standing for several hours until all the ice has melted (the head and drying tube are attached). The Erlenmeyer flask is then transferred to an oil bath; the drying tube is replaced with a

copper condenser attached to a lead receiver. The temperature of the oil bath is gradually raised to 200°C, as a result of which HCl-containing hydrofluoric acid distills over. The oil bath is then removed, the condenser is taken off, and the TiF_4 is sublimed by heating with an open Bunsen burner flame. The sublimate flows into a copper receiver, which can be sealed and which doubles as a storage container for the product. The receiver is placed over the neck of the retort and cooled with water flowing through lead coils. The head must always be warm during this procedure to prevent plugging of the equipment. The yield is 90%, based on TiCl_4 .

The product is stored in tightly sealed copper or iron containers.

PROPERTIES:

Colorless, loose powder; very hygroscopic, reacts with water with effervescence; dissolves in alcohol with evolution of heat; insoluble in ether.

M.p. $>400^\circ\text{C}$ (under pressure), subl. t. 284°C ; d. (20°C) 2.798.

REFERENCES:

- O. Ruff. Die Chemie des Fluors [Fluorine Chemistry], Berlin, 1920, p. 48;
 O. Ruff and R. Ipsen. Ber. dtsh. chem. Ges. 36, 1777 (1903);
 O. Ruff and W. Plato. Ber. dtsh. Chem. Ges. 37, 673 (1904).

Zirconium (IV) Fluoride

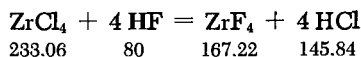

In a procedure similar to that described for the preparation of TiF_4 (see above), 50 g. of ZrCl_4 is gradually added to 120-150 g. of anhydrous HF. Further treatment is, however, simpler in this case since there is no necessity for subliming the ZrF_4 . After the HF is distilled off, the Erlenmeyer flask is heated until the bottom is red hot. The ZrF_4 is then pure, and after cooling can be stored immediately in sealable copper containers.

Other preparative method: Thermal decomposition of $(\text{NH}_4)_2\text{ZrF}_6$.

PROPERTIES:

White, highly refractive translucent substance. Solubility in water: 1.32 g./100 ml. Hydrolyzed by water above 50°C .

Subl. t. $>600^\circ\text{C}$; d (20°C) 4.6. Monoclinic crystals.

REFERENCES:

- O. Ruff. Die Chemie des Fluors [Fluorine Chemistry], Berlin, 1920, p. 49.
 L. Wolter. Chem. Ztg. 51, 607 (1908).

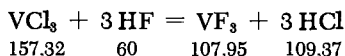
Vanadium (III) Fluoride

In an apparatus similar to that described for the preparation of CoF_2 (p. 267), 4 g. of VCl_3 is treated with anhydrous HF in a nickel, sintered alumina or platinum vessel. At the start of the experiment the apparatus is flushed with dry nitrogen to displace atmospheric oxygen. During the fluorination the tube is slowly heated to 200°C . After 1.5 hours the temperature is raised to red heat. The reaction is complete when the exit gas no longer contains any HCl. The product is allowed to cool to 100°C in a stream of HF gas, after which the cooling is continued in a nitrogen stream. The yield is 95%, based on VCl_3 .

PROPERTIES:

Yellowish-green powder, almost insoluble in water, alcohol, acetone, ethyl acetate, acetic anhydride, glacial acetic acid, toluene, CCl_4 , CHCl_3 and CS_2 . Becomes black in sodium hydroxide solution.
 M.p. $>800^\circ\text{C}$; sublimation occurs at bright red heat; d 3.363.

REFERENCE:

- O. Ruff and H. Lickfett. Ber. dtsh. chem. Ges. 44, 2539 (1911).

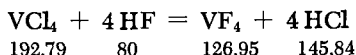
Vanadium (IV) Fluoride

Freshly distilled, Dry Ice-cooled VCl_4 (40 g.) is added to 130 g. of similarly cooled anhydrous HF contained in a reactor identical to that described for the preparation of TiF_4 (p. 250). A copper

reflux condenser charged with a cooling mixture is then attached to the vessel, and the reaction mixture is allowed to warm slowly to 0°C. The mixture is then boiled for several hours until no further HCl evolves. The reflux condenser is then replaced by a descending condenser and the HF is distilled off. The VF₄ remaining in the reactor is freed of any traces of HF by passage of a dry stream of nitrogen at 50°C. The yield is 97%, based on VCl₄.

The product may be stored in sealed iron or copper containers.

PROPERTIES:

Brownish-yellow, loosely packed powder; very hygroscopic, deliquesces in air to a blue liquid; readily soluble in water, imparting a blue color to the solution. Soluble in acetone and glacial acetic acid, giving a deep green and blue-green color respectively. Only very slightly soluble in SO₂Cl₂, alcohol and chloroform. Not volatile, but disproportionates above 325°C to VF₃ and VF₅.
d. (23°C) 2.975.

REFERENCE:

O. Ruff and H. Lickfett. Ber. dtsh. chem. Ges. 44, 2539 (1911).

Vanadium (V) Fluoride

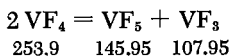

A small nickel or platinum boat containing VF₄ is placed in a nickel tube and gradually heated to 650°C in a stream of dry N₂. The exit gases are collected in a large-diameter quartz trap maintained at -78°C. The trap is attached to a drying tube with anhydrous KF to exclude atmospheric moisture. The heating process must be effected slowly, since otherwise the unreacted VF₄ is blown out of the reaction tube. The product is allowed to cool in a nitrogen stream and the VF₅ is discharged directly from the gas trap into a storage container. A greenish-yellowish residue (VF₄) remains in the boat. The yield is almost quantitative.

The product is stored in sealed iron, nickel, copper or platinum containers.

PROPERTIES:

Compact, white substance, displaying a noticeable vapor pressure at room temperature, becomes yellow in air; soluble in water,

to which it imparts a yellow-red color. Readily soluble in alcohol, chloroform, acetone and ligroin; insoluble in CS_2 . Decomposes toluene and ether. Slowly attacks glass at room temperature.

M.p. $>200^\circ\text{C}$ (under pressure); subl. t. 111.2°C ; d (19°C) 2.177.

REFERENCE:

O. Ruff and H. Lickfett. Ber. dtsh. chem. Ges. 44, 2548 (1911).

Niobium (V) Fluoride

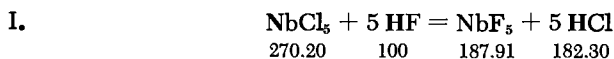

In a manner similar to that described for the preparation of TiF_4 (p. 250), NbCl_5 is introduced into twice the theoretical amount of anhydrous HF. A copper or iron reflux condenser charged with a cooling mixture is then attached to the reactor; the product is boiled for several hours with the excess HF until evolution of HCl ceases. The HF is then distilled through a downward condenser. The condenser is then replaced with a distillation head and the NbF_5 distilled off.



In an apparatus similar to that as described for the preparation of SF_6 (p. 169), Nb is allowed to react with F_2 at 300°C .

The product is stored in sealed copper or iron containers.

PROPERTIES:

Colorless, highly refractive crystals; very hygroscopic, deliquesce on exposure to air. Soluble in water and alcohol with hydrolysis; sparingly soluble in CS_2 and chloroform; hydrolyzes in alkali hydroxide solutions. Concentrated H_2SO_4 dissolves NbF_5 somewhat more readily than TaF_5 .

M.p. 78.9°C , b.p. 233.3°C ; d 3.293.

REFERENCES:

- I. O. Ruff and E. Schiller. Z. anorg. allg. Chem. 72, 329 (1911); O. Ruff and J. Zedner. Ber. dtsh. chem. Ges. 42, 492 (1909).
- II. J. H. Junkins, R. L. Farrar, Jr., E. J. Barber and H. A. Bernhardt. J. Amer. Chem. Soc. 74, 3464 (1952).

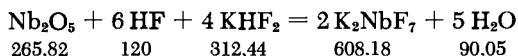
Potassium Heptafluoroniobate (V)

Niobium (V) oxide is dissolved in 40% HF solution in a polyethylene dish on a steam bath. A solution of KHF_2 is added until a permanent precipitate is formed. The mixture is then allowed to cool; the product is recrystallized from dilute hydrofluoric acid and the crystals are pressed between filter papers. They are finally vacuum-dried.

SYNONYM:

Potassium niobium heptafluoride.

PROPERTIES:

Formula weight 304.09. Small, very lustrous needles, recrystallizable from hydrofluoric acid. Solubility in water (18°C) 8 g./100 ml. Monoclinic (pseudorhombic) structure.

REFERENCE:

G. Krüss and L. F. Nilson. Ber. dtsch. chem. Ges. 20, 1688 (1887).

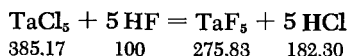
Tantalum (V) Fluoride

Tantalum (V) chloride (30 g.) is added to 50-60 g. of anhydrous HF contained in a reactor similar to that described for the preparation of TiF_4 (p. 250). The reflux condenser is charged with freezing mixture and the reaction mixture is boiled for several hours until the evolution of HCl ceases. The excess HF is then distilled off through a descending condenser. The reflux condenser is then replaced by a distillation head, and the TaF_5 is distilled off into a platinum crucible. It is stored in sealed copper or iron containers. The yield is 65%, based on TaCl_5 .

PROPERTIES:

Colorless, highly refractive prisms which deliquesce when exposed to air. Dissolves in water with effervescence. Fuming

and concentrated nitric acids do not dissolve TaF_5 as well as water. Concentrated H_2SO_4 dissolves only small amounts of TaF_5 . Alkali hydroxide solutions cause a vigorous reaction. Dissolves to some extent in hot CS_2 and CCl_4 . Reacts vigorously with ether. Attacks glass very slowly at room temperature, but rapidly above.

M.p. $96.8^\circ C$, b.p. $229.5^\circ C$; d ($20^\circ C$) 4.74.

REFERENCES:

- O. Ruff and E. Schiller. Z. anorg. allg. Chem. 72, 329 (1911).
O. Ruff and J. Zedner. Ber. dtsch. chem. Ges. 42, 492 (1909).

Potassium Heptafluorotantalate (V)

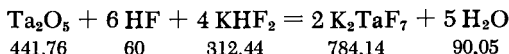

A platinum dish containing Ta_2O_5 is placed on a water bath and the Ta_2O_5 dissolved in 40% hydrofluoric acid solution; a solution of KHF_2 is added to this mixture until a precipitate forms. The mixture is then allowed to cool. The precipitate of K_2TaF_7 can be recrystallized from hydrofluoric acid. It is pressed dry between filter papers and dried at $120^\circ C$.

SYNONYM:

Potassium tantalum heptafluoride.

PROPERTIES:

Formula weight 392.07. Lustrous, thin, short needles, easily recrystallized from hydrofluoric acid. Solubility in water ($15^\circ C$) 0.5 g./100 ml. Monoclinic (pseudorhombic) structure.

REFERENCE:

- J. J. Berzelius. Pogg. Ann. 4, 6 (1825).

Chromium (II) Fluoride

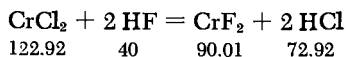

An apparatus similar to that described for the preparation of CoF_2 (p. 267) is used to pass anhydrous HF over anhydrous $CrCl_2$

until evolution of HCl ceases. The reaction proceeds even at room temperature. The mixture is finally heated in a stream of HF to 100-200°C; the excess HF is driven off with a stream of dry nitrogen, in which the product is allowed to cool.

PROPERTIES:

Dark green, crystalline substance with an opalescent luster. Slightly soluble in water, insoluble in alcohol. Not attacked by hot dilute sulfuric or nitric acids. Soluble in boiling hydrochloric acid. Converts to Cr₂O₃ on heating in air.

M.p. 1100°C, b.p. >1200°C; d 4.11. Monoclinic crystals.

REFERENCE:

C. Poulenc. Comptes Rendus Hebd. Séances Acad. Sci. 116, 254 (1893).

Chromium (III) Fluoride

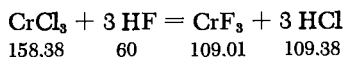

In a procedure similar to that described for the preparation of CoF₂ (p. 267), CrCl₃ is heated in a stream of HF until the evolution of HCl ceases. The temperature must be raised to 600°C. The excess HF is then displaced with a dry stream of nitrogen, in which the product is allowed to cool. The product can be melted in an HF stream in a platinum tube at 1200°C and partly distilled off. This treatment yields a crystalline product.

The reaction of chromium hydroxide with hydrofluoric acid yields the trihydrate, not the anhydrous material.

PROPERTIES:

Greenish needles, insoluble in water and alcohol.

M.p. >1000°C, b.p. >1100°C; d 3.8.

REFERENCES:

C. Poulenc. Comptes Rendus Hebd. Séances Acad. Sci. 116, 254 (1893); Ann. Chim. Phys. (7) 2, 62 (1894).

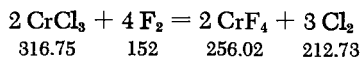
Chromium (IV) Fluoride

or

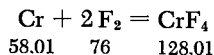

An apparatus similar to that described for the preparation of SF_6 (p. 169) is used for the fluorination of pulverized electrolytic Cr or CrCl_3 contained in a fluorspar or small alumina vessel. The fluorination temperature is $350\text{--}500^\circ\text{C}$. Some CrF_4 , as well as most of the CrF_5 , migrates into the receiver. The main portion of the CrF_4 is deposited in the reaction tube beyond the boat in varnish-like, glittering brown beads. When the fluorination is complete, the apparatus is flushed out with N_2 or CO_2 and the CrF_4 is immediately sealed off in glass ampoules.

PROPERTIES:

Formula weight 128.01. Brown, amorphous, hygroscopic solid, intensely blue vapor; soluble in water (with hydrolysis).

M.p. about 200°C , b.p. about 400°C ; d 2.89.

REFERENCE:

H. von Wartenberg. Z. anorg. allg. Chem. 247, 136 (1941).

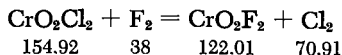
Chromyl Fluoride

A stream of nitrogen gas at a rate of about 50 ml./min. is passed through a quartz trap in which CrO_2Cl_2 is kept in a glycerol bath at a temperature not higher than 100°C (see Fig. 138). The nitrogen stream, saturated with CrO_2Cl_2 , is combined in an iron tee joint with a fluorine stream, flowing at a rate of about 60–70 ml./min. The gas mixture flows through a 3-cm.-diameter nickel reaction tube, which is heated electrically to 200°C . A sintered alumina tube equipped with copper caps (see BiF_5 , p. 202) may be used instead of the nickel tube. The reaction mixture is

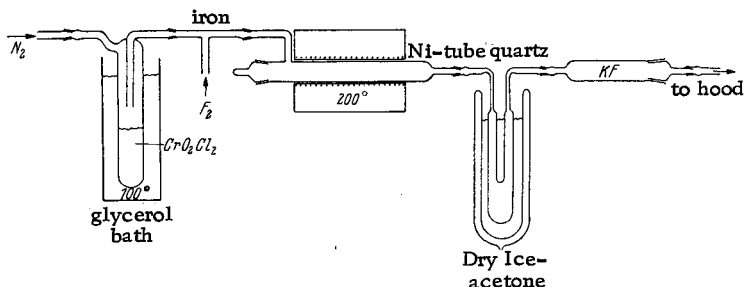

Fig. 138. Preparation of chromyl fluoride.

then led into a quartz U tube, the arms of which should be at least 15 mm. apart. The products are condensed here with Dry Ice-acetone mixture. To avoid contact with atmospheric moisture, an iron drying tube with freshly dehydrated KF is attached to the apparatus.

When sufficient product (a brown feltlike mass) has condensed in the U tube, the glycerol bath is replaced with an ice bath, and N_2 is passed through the apparatus until the F_2 is completely flushed out. The ice bath under the U tube is then removed, while a nitrogen flow is maintained through it. The brown substance decolorizes and forms a gray-white feltlike mass. The nitrogen flow is shut off and both arms of the U tube are fused at their narrowest points. The CrO_2F_2 is stored in the U tube as the white, stable modification.

PROPERTIES:

Reddish-brown vapor. Two solid modifications exist. One is reddish-brown to black-red, unstable (especially when exposed to visible, ultraviolet or infrared light) and can be stored only by chilling the freshly condensed product in liquid nitrogen with exclusion of light. Rhombic or monoclinic crystals. Vapor pressure ($0^\circ C$) 24 mm.

Subl. t. $30^\circ C$, m. p. $31.6^\circ C$.

The second, polymeric modification is gray-white, stable and starts to volatilize only at $200^\circ C$, producing red-brown fumes of CrO_2F_2 .

REFERENCE:

H. von Wartenberg. *Z. anorg. allg. chem.* **247**, 140 (1941).

Molybdenum (VI) Fluoride

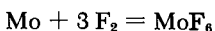

96.0 114.0 210.0

Molybdenum metal is fluorinated in an apparatus similar to that described for the preparation of SF_6 (p. 169) (nickel reaction tube,

quartz freezing trap). The Mo powder is introduced into the reactor in a small sintered alumina or platinum boat. The trap is cooled with liquid nitrogen or, in an emergency, with a Dry Ice-acetone bath. When the apparatus is well flushed with F_2 gas, the nickel reaction tube is carefully heated until the reaction starts. The reactor must be cooled occasionally during the fluorination. The simplest way to accomplish this is by wrapping a wet rag around it. White MoF_6 condenses in the quartz trap together with small amounts of oxyfluorides ($MoOF_4$ and MoO_2F_2), formed from the oxygen contained in the fluorine. After the fluorination is complete, the MoF_6 must be repeatedly redistilled in a quartz apparatus in order to remove these impurities.

The purity can be estimated by a melting point determination. The compound is stored in sealed quartz ampoules.

PROPERTIES:

White crystals; very hygroscopic and reactive; reacts with water with vigorous effervescence; forms a blue-white mist in moist air. M.p. $17.5^\circ C$, b.p. $35.0^\circ C$; d (liq.) ($20^\circ C$) 2.543.

REFERENCE:

O. Ruff and E. Ascher. Z. anorg. allg. chem. 196, 418 (1931).

Tungsten (VI) Fluoride

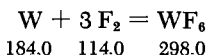

Tungsten powder contained in a small sintered alumina vessel is burned in a fluorine stream in an apparatus similar to that described for the preparation of SF_6 (p. 169). The compound is purified by repeated distillation.

In addition to determination of the melting point, the molecular weight is determined by vapor pressure measurement in a quartz flask; this is a suitable index for checking the purity.

The product may be stored in glass or quartz ampoules.

PROPERTIES:

Colorless gas, faintly yellow liquid, white solid; very hygroscopic.

M.p. 2.3°C, b.p. 17.5°C; d (liq.) (15°C) 3.441. Rhombic crystals.

REFERENCES:

- O. Ruff and E. Ascher. *Z. anorg. allg. Chem.* 196, 413 (1931).
 P. Henkel and W. Klemm. *Z. anorg. allg. Chem.* 222, 68 (1935).

Uranium (IV) Fluoride

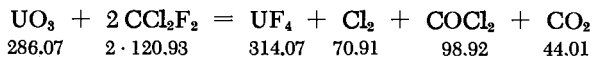

Dichlorodifluoromethane (Freon 12) is passed through a Hg pressure release valve, a bubble counter and a P_2O_5 tube into a glass or quartz reaction tube (diameter 2.5 cm., length 40 cm.) (see Fig. 139). The reaction tube is inserted into a short electric

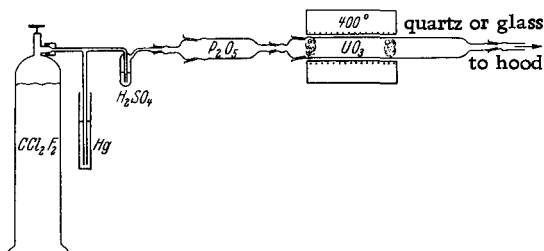

Fig. 139. Preparation of uranium (IV) fluoride.

furnace which can be heated to a temperature of 400°C. Powdered UO_3 is placed in the reaction tube between glass-wool plugs. The escaping gases are led to the hood.

At the beginning, dry oxygen is passed through the apparatus for one hour, while the furnace is heated to 400°C. The oxygen flow is then replaced with CF_2Cl_2 , which is introduced at a rate of one liter per hour. The reaction starts as soon as the temperature reaches 400°C. The progress of the reaction can be followed as the color of the product changes to green.

On completion of the reaction, the product is cooled in a stream of CF_2Cl_2 ; very pure UF_4 is obtained. The yield is almost quantitative.

PROPERTIES:

Green powder, thermally stable up to 1100°C. Converted to U₃O₈ on heating in air.

M.p. >1100°C.

REFERENCE:

H. S. Booth, W. Krasny-Ergen and R. E. Heath. J. Amer. Chem. Soc. 68, 1969 (1946).

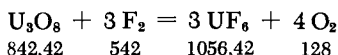
Uranium (VI) Fluoride**UF₆**

Dried, powdered U₃O₈, contained in a small nickel boat, is reacted with F₂ gas in an apparatus similar to that described for the preparation of SF₆ (p. 169). The temperature must be carefully maintained above 600°C, since otherwise the oxyfluoride UOF₄ is formed.

The product is collected in a quartz trap. It is then mixed with NaF (to retain the traces of the HF). The UF₆ is then repeatedly vacuum-sublimed in a quartz apparatus.

Can be stored in silica ampoules. Larger quantities are preferably stored in an iron container provided with a needle valve.

PROPERTIES:

Formula weight 352.14. White crystals when pure, yellowish when less pure; smokes in air and is hydrolyzed vigorously by water. Does not attack glass if pure.

M.p. 69.5°C (under pressure), subl. t. 56.2°C; d (64.052°C, triple point) 3.63, d (solid) 4.87. Monoclinic crystals.

REFERENCES:

W. Kwasnik. Naturforschung und Medizin in Deutschland 1939-1946 (FIAT-Review) 23, 18; German Patent Application J 772863.

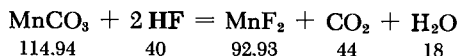
Manganese (II) Fluoride**MnF₂**

Manganese carbonate is added to an excess of 40% hydrofluoric acid solution contained in a platinum or lead dish. The pale-red solution of MnF₂ is then decanted and dried at 110°C.

PROPERTIES:

Rose-colored, square prisms. Solubility in water 1.06 g./100 ml. Soluble in dilute hydrofluoric acid, readily soluble in concentrated hydrochloric and nitric acids.

M.p. 856°C; d 3.98. Tetragonal (rutile) crystal structure.

REFERENCE:

H. Moissan and Venturi. Comptes Rendus Hebd. Séances Acad. Sci. 130 b, 1158 (1900).

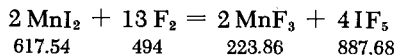
Manganese (III) Fluoride

Freshly fused and powdered MnI_2 , contained in a small sintered alumina or Pt boat, is fluorinated with F_2 in an apparatus similar to that described for the preparation of SF_6 (p. 169). The reaction is exothermic and IF_5 is evolved. Heat is then applied until 250°C is reached; the product is left to cool in a F_2 stream. The F_2 is finally displaced by dry N_2 and the product is immediately placed in ampoules.

Anhydrous MnF_2 can also be converted to MnF_3 at 250°C, using the same procedure.

R. Hoppe recommends fluorination of $(\text{NH}_4)_2\text{MnF}_6$ with elemental F_2 to prepare MnF_3 . This avoids the necessity of observing all the precautions usually required with a hygroscopic starting material. Moreover, the fluorination is more complete, since the molar volume of the starting material is greater than that of the end product.

The product may be stored in sealed glass ampoules.

PROPERTIES:

Formula weight 111.93. Wine-colored; thermally stable to 600°C; hydrolyzed by water; d 3.54.

REFERENCES:

- H. Moissan. Comptes Rendus. Hebd. Séances Acad. Sci. 130 c, 622 (1900).
 H. von Wartenberg. Z. anorg. allg. Chem. 244, 346 (1940).
 R. Hoppe. Unpublished private communication.

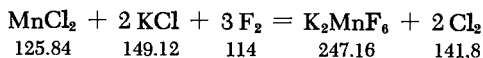
Potassium Hexafluoromanganate (IV)

A mixture consisting of two moles of KCl and one mole of MnCl₂ is heated to 375–400°C in a stream of F₂, using an apparatus similar to that described for the preparation of TlF₃ (p. 231). After cooling, the excess fluorine is driven off with a stream of dry nitrogen.

SYNONYM:

Potassium manganese hexafluoride.

PROPERTIES:

Gold-yellow, transparent platelets. Turns red-brown when heated but resumes its original color on cooling. Decomposed by water, precipitating hydrated MnO₂. Hexagonal crystals.

REFERENCE:

- E. Huss and W. Klemm. Z. anorg. allg. Chem. 262, 25 (1950).

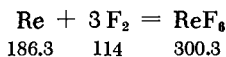
Rhenium (VI) Fluoride

A small fluorspar boat, containing Re powder, is placed in a fluorspar tube and oxygen-free fluorine gas is passed through. Since removal of O₂ from the crude fluorine gas is carried out at reduced pressure, the fluorination of Re must also be done under reduced pressure. Because of this the fluorspar tube must be encased in a nickel or copper tube.

Fluorine gas, kept condensed in a quartz trap immersed in liquid nitrogen (see Fig. 140), is led at a pressure of 20–35 mm. through a spark gap (about 5000 v., 0.012 amp.), also immersed in liquid nitrogen. The oxygen in the crude fluorine gas is thus converted to O_2F_2 and frozen out. The purified fluorine gas sweeps over the rhenium powder, heated to 125°C by an electric furnace. The gaseous reaction products pass through two quartz traps, cooled with liquid nitrogen, where they are condensed. The two condensation traps are connected to an additional quartz trap, which prevents access of atmospheric moisture. A stop-cock closes the system or serves as a connection to an aspirator.

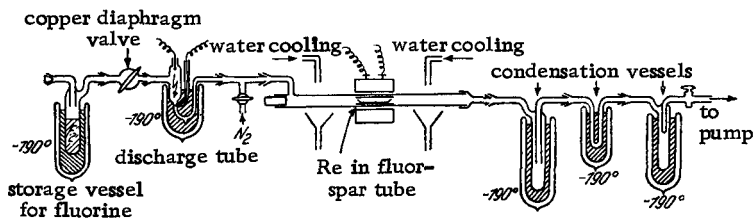

Fig. 140. Preparation of rhenium (VI) fluoride.

The ground joints of the apparatus are not greased but are sealed externally with picein. The water film is removed from the walls of the entire apparatus by heating in a stream of nitrogen before the beginning of the run.

As soon as the Re powder comes in contact with the fluorine gas, a white, blue and violet fog appears in the condensation traps. This is followed at once by the almost colorless ReF_6 .

After the reaction, the apparatus is flushed with dry nitrogen to remove the excess fluorine. The ReF_6 is then resublimed in quartz apparatus under vacuum. Because ReF_6 reacts readily with quartz, this treatment is performed only once. Fractional distillation is inapplicable in this case due to the formation of ReOF_4 .

The product is stored in quartz ampoules placed in liquid nitrogen.

PROPERTIES:

Pale yellow, featherlike, crystalline powder, extremely hygroscopic; fumes in air with formation of blue smoke, which later turns dark violet. Nitric acid dissolves ReF_6 with the formation of white smoke. Very corrosive to glass. Attacks quartz slightly. Copper is stable to it up to 150°C . Instantly blackened by concentrated H_2SO_4 , benzene, acetic acid, paraffin oil, alcohol, ether and acetone.

M.p. 18.8°C , b.p. 47.6°C ; d (liq.) (19°C) 3.616.

REFERENCES:

- O. Ruff and W. Kwasnik. Z. anorg. allg. Chem. 209, 113 (1932).
 O. Ruff and W. Kwasnik. Z. anorg. allg. Chem. 219, 65 (1934).

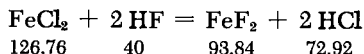
Iron (II) Fluoride

Iron (II) chloride is treated with anhydrous HF in an apparatus similar to that described for the preparation of CoF_2 (Fig. 141). The reaction proceeds even at room temperature, yielding an amorphous product. To obtain crystals, the product must be heated to 1000°C .

PROPERTIES:

White powder, sparingly soluble in water, insoluble in alcohol, ether and benzene.

M.p. $>1100^\circ\text{C}$, subl. t. about 1100°C ; d 4.09. Tetragonal (rutile) structure.

REFERENCES:

- C. Poulenc. Comptes Rendus Hebd. Séances Acad. Sci. 115, 942 (1892).
 C. Poulenc. Ann. Chim. Phys. (7) 2, 53 (1894).

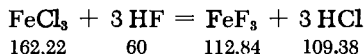
Iron (III) Fluoride

Anhydrous FeCl_3 is allowed to react with anhydrous HF in an apparatus similar to that described for the preparation of CoF_2 (Fig. 141) until HCl evolution ceases. The reaction proceeds even at room temperature and yields amorphous FeF_3 . In order to obtain crystals, the product must be heated to 1000°C .

PROPERTIES:

Greenish powder, very slightly soluble in water (at 25°C, 0.091 g./100 ml.), readily soluble in dilute hydrofluoric acid, insoluble in alcohol, ether and benzene.

Subl. t. >1000°C; d 3.87. Hexagonal crystals.

REFERENCES:

C. Poulenc. Comptes Rendus Hebd. Séances Acad. Sci. 115, 944 (1892).

C. Poulenc. Ann. Chim. Phys. (7) 2, 57 (1894).

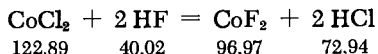
Cobalt (II) Fluoride

Crystalline cobalt (I) chloride ($\text{CoCl}_2 \cdot 2 \text{H}_2\text{O}$) is completely dehydrated at 200°C in a glass tube through which a HCl stream is passed. The progress of the dehydration can be easily followed, since the color changes from pink to blue.

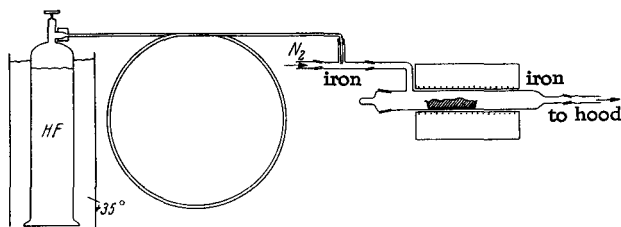

Fig. 141. Preparation of cobalt (II) fluoride.

After this, anhydrous HF at 300°C is passed over the CoCl_2 , contained in a small fluorspar boat placed inside an iron tube, until evolution of HCl is no longer detectable at the end of the tube. The apparatus is then flushed with dry nitrogen to remove excess HF.

This apparatus is suitable for all fluorinations with anhydrous HF in which the product is a nonvolatile solid fluoride (CrF_2 , CrF_3 , VF_3 , FeF_2 , FeF_3).

PROPERTIES:

Reddish-pink powder, sparingly soluble in water; dissolves readily in mineral acids on heating.

M.p. 1100-1200°C; d 4.43. Tetragonal (rutile) structure.

REFERENCES:

- O. Ruff and E. Ascher. *Z. anorg. allg. Chem.* 183, 193 (1929).
 W. B. Burford. *Ind. Eng. Chem.* 39, 321 (1947).

Cobalt (III) Fluoride

Cobalt (II) fluoride (see above) is treated with F_2 gas in an apparatus similar to that described for the preparation of TlF_3 (p. 231). At first the conversion proceeds rather slowly, but it becomes vigorous when the reaction tube is heated to 75°C . Due to the heat of reaction, the temperature rises to 200°C . The product is cooled in a stream of fluorine, and the excess of the latter is then flushed out with dry N_2 . The yield is 91%, based on CoF_2 .

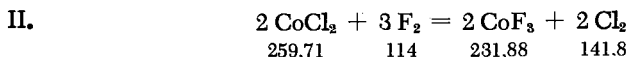

OR:

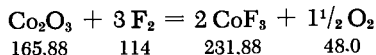

Anhydrous CoCl_2 or Co_2O_3 is treated with F_2 gas in an apparatus similar to that described for the preparation of TlF_3 (p. 231). The temperature of the reaction tube is raised gradually to 300°C , starting from room temperature; this temperature is maintained until F_2 gas can be detected at the exit. The excess F_2 in the apparatus is then displaced with dry N_2 .

The product is stored in hermetically sealed glass, quartz or metal containers.

Used to fluorinate organic compounds.

PROPERTIES:

Formula weight 115.94. Light-brown powder, becomes dark brown on exposure to moist air; volatilizes in a stream of F_2 at $600\text{--}700^\circ\text{C}$; decomposes extensively at lower temperatures into $\text{CoF}_2 + \text{F}_2$. Reacts with water with evolution of O_2 .

d 3.88. Hexagonal crystals.

REFERENCES:

- I. E. A. Belmore, W. M. Ewalt and B. H. Wojcik. *Ind. Eng. Chem.* 39, 341 (1947).

- II. O. Ruff and E. Ascher. *Z. anorg. allg. Chem.* **183**, 193 (1929);
E. T. McBee et al. *Ind. Eng. Chem.* **39**, 310 (1947).

Nickel (II) Fluoride

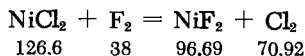

Anhydrous NiCl_2 , contained in a small nickel boat, is fluorinated at 150°C in an apparatus similar to that described for the preparation of TF_3 (p. 231). The reaction product remaining in the boat (its composition is approximately $\text{NiF}_{2.5}$) is then heated in a stream of N_2 or CO_2 , yielding NiF_2 and splitting off F_2 .

PROPERTIES:

Yellowish-green powder, sparingly soluble in water, insoluble in alcohol and ether; sublimes in a stream of HF above 1000°C . d 4.63. Tetragonal (rutile) structure.

REFERENCE:

- P. Henkel and W. Klemm. *Z. anorg. allg. Chem.* **222**, 74 (1935).

Potassium Hexafluoronickelate (IV)

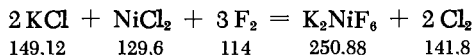

A mixture consisting of two moles of KCl and one mole of NiCl_2 is heated for three hours in a stream of fluorine at 275°C in an apparatus similar to that described for the preparation of TlF_3 (p. 231). After cooling, the excess fluorine is expelled with dry N_2 .

The product is stored in glass ampoules sealed in vacuum or in glass bottles sealed under nitrogen.

This method of preparation is quite versatile and may be applied, for example, to the production of K_2MnF_6 , K_2CrF_6 , K_2FeF_6 , K_3CoF_7 , K_2VF_6 and K_3CuF_6 .

PROPERTIES:

Lustrous red salt, reacts with water, with evolution of gas (OF_2 ?) and formation of a black precipitate; reduced by H_2 at 200°C . d 3.03. Has a K_2PtCl_6 -type structure.

REFERENCE:

W. Klemm and E. Huss. *Z. anorg. allg. Chem.* **258**, 221 (1949).

Iridium (VI) Fluoride

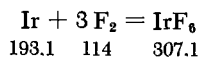

Iridium, contained in a small fluor spar boat placed in an electrically heated fluor spar tube, is fluorinated at 240°C (Fig. 142). A nickel or platinum tube may be employed instead of the fluor spar reactor. The fluorine gas first passes through a quartz trap

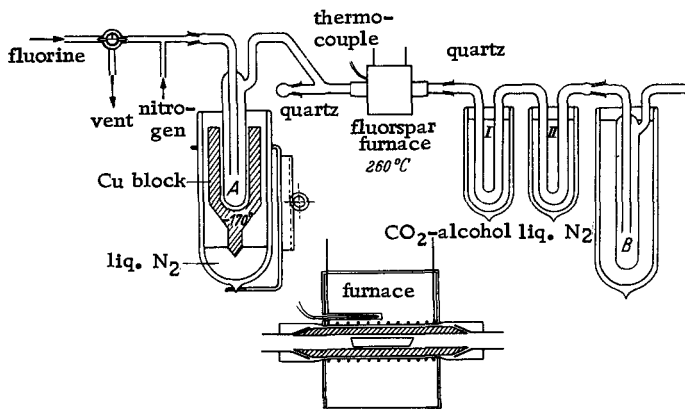

Fig. 142. Preparation of iridium (VI) fluoride.

A, maintained at -170 to -196°C in order to freeze out the HF. From there it flows to the reactor furnace. The product gases flow through two silica U tubes or gas traps (I and II). The temperatures of I and II are -78°C and -196°C , respectively. Terminal trap *B* (maintained at -196°C), serves to prevent access of atmospheric moisture.

The fluor spar tube is connected to the quartz sections of the apparatus with ground joints, which are externally sealed with an asbestos-waterglass mixture.

The apparatus is first flushed with dry nitrogen, while the quartz sections are heated to remove traces of surface moisture. The flow of fluorine gas is then started and the traps are cooled. Yellow vapors of IrF_6 appear as soon as the fluorine reaches the Ir. These

collect in the traps. After the fluorination, the excess F_2 is purged with N_2 . The IrF_6 is then purified by fractional distillation in a quartz vacuum apparatus without stopcocks, and it is finally distilled into quartz ampoules, which are immediately sealed off.

PROPERTIES:

Bright yellow, lustrous lamellae and small needles, which above $-15^\circ C$ become intensely gold-yellow and glassy. Very hygroscopic; attacks glass. Corrodes Pt at temperatures above $400^\circ C$. Reduced by halogens to IrF_4 at room temperature.

M.p. $44.4^\circ C$, b.p. $53^\circ C$; d (solid) ($-190^\circ C$) about 6. Tetragonal crystals.

REFERENCE:

O. Ruff and J. Fischer. Z. anorg. allg. Chem. 179, 166 (1929).

Chlorine, Bromine, Iodine

M. SCHMEISSER

Chlorine

Commercially available liquid chlorine, which is obtained by electrolysis of alkali, is not sufficiently pure and must therefore be purified by method I.

On the other hand, a gas that is already largely free of such impurities as O_2 and chlorine oxides is produced by the reaction of hydrated manganese dioxide with pure hydrochloric acid. For this preparation, see method II below.

I. Chlorine from a steel cylinder is passed consecutively through two wash bottles or columns containing concentrated H_2SO_4 , a tube or column containing CaO (to remove any HCl that might be present), a tube containing P_2O_5 , and finally into a container placed in a Dry Ice-acetone bath, where it is condensed and liquefied. The liquefied Cl_2 is repeatedly vaporized and condensed while noncondensable gases (O_2) are continuously removed with a pump. Finally, the liquid Cl_2 is fractionated in high vacuum and passed into receivers cooled with liquid nitrogen. (For the apparatus see, for example, Part I, p. 66 ff.) Only the middle fraction is used for further work.

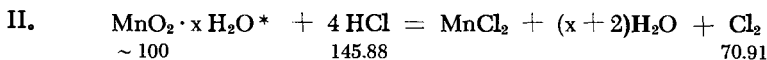

* $x \sim 0.8$ for a product of about 86% purity.

Concentrated, air-free hydrochloric acid (d 1.16) is added dropwise to precipitated hydrated manganese dioxide (e.g., the 86% pure commercially obtainable material) in a flask equipped with a dropping funnel and a gas outlet tube. The gas formation may be regulated by moderate heating.

The chlorine thus formed is passed through water (to remove entrained HCl) and H_2SO_4 (carried out as in method I, that is,

H₂SO₄, a tube containing CaO, a tube with P₂O₅) and liquefied in a receiver cooled with a Dry Ice-acetone bath. Subsequent purification is as in method I.

Other preparative methods:

III. Electrolysis of an NaCl solution saturated with HCl in the electrolytic cell described by Bodenstein and Pohl. The oxygen content of the Cl₂ produced in this manner is 0.01%.

Extremely pure Cl₂ can be produced in small quantities by the following methods:

IV. Heating AuCl₃ (prepared from finely divided Au and dry Cl₂) at 250°C in vacuum.

V. Sublimation-crystallization procedure carried out in high vacuum. (In this process, the purity of the Cl₂ product is checked by measuring the rate of formation of phosgene from CO and Cl₂. This reaction is retarded by the slightest impurities.)

Klemenc considers the most effective means of removing the last traces of O₂ from Cl₂ to be the bubbling of very pure H₂ through liquid Cl₂ at -78°C for 24 hours.

PROPERTIES:

Yellow-green, pungent gas. M.p. -101.0°C, b.p. -34.0°C. Heat of fusion 1531 cal./mole; heat of vaporization 4878 cal./mole. Triple point pressure 10.4 mm., crit. t. 143.5°C, crit. p. 76.1 atm. d₄(liq.) (-34°C) 1.557. Solubility in water: 1 vol. of water dissolves 4.6 vol. of Cl₂ at 0°C, 2.15 vol. at 20°C, 1.22 vol. at 50°C, 0.39 vol. at 90°C.

Chlorine attacks rubber, cork, stopcock grease and Hg but can be stored in glass containers over concentrated H₂SO₄ or as a liquid in steel cylinders. The vigorous reaction of chlorine with many commonly used metals occurs only at elevated temperatures; the reaction with steel, for example, starts above 250°C [G. Heinemann, F. G. Garrison and P. A. Haber, *Ind. Eng. Chem., Ind. Ed.* **38**, 497 (1946)].

REFERENCES:

- I. A. Klemenc. *Die Behandlung und Reindarstellung von Gasen* [Treatment and Purification of Gases], 2nd ed., Vienna, 1948, p. 153.
- II. L. Wöhler and S. Streicher. *Ber. dtsh. chem. Ges.* **46**, 1596 (1913).
W. F. Giaouque and T. M. Powell. *J. Amer. Chem. Soc.* **61**, 1970 (1939).
- III. M. Bodenstein. *Z. Elektrochem.* **22**, 204 (1916).
- IV. A. Coehn and G. Jung. *Z. phys. Chem.* **110**, 705 (1924).
H. von Wartenberg and F. A. Henglein. *Ber. dtsh. chem. Ges.* **55**, 1003 (1922).

V. P. M. Fye and J. J. Beaver. *J. Amer. Chem. Soc.* **63**, 1268 (1941).

Chlorine Hydrate

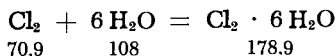
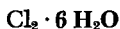

I. Chlorine is dissolved in water at 0°C, forming a thin slurry which is then filtered through a glass filter funnel surrounded by a jacket cooled with ice water. The crystals, which are thus largely freed from water, are sealed into a glass tube and heated to 30 to 40°C. Decomposition into liquid Cl₂ (under its own pressure) and Cl₂-saturated water results. The sealed tube is allowed to cool from 40 to 0°C in a large water bath for two days. Thus, the mixture components recombine and form larger crystals.

II. Better-formed crystals can be prepared in the following way:

Chlorine hydrate, prepared as above, is placed in one arm of a thick-wall U tube and the tube is sealed off. The hydrate is decomposed by heating and the chlorine formed is condensed by immersing the other arm of the U tube in a refrigerant. Then the refrigerant is removed while the other side of the tube, which contains water saturated with Cl₂, is immersed in a vessel full of cold water. After some time large, very glittering, pale-yellow crystals are formed in this arm.

PROPERTIES:

Yellow crystals. Decomposition temperature at 1 atm. +9.6°C; critical decomposition point 28.7°C, 6 atm.; dissociation pressure (at 0°C) 252 mm.; d. (calc.) 1.29. Cubic crystals, with the theoretical composition of Cl₂ · 5³/₄ H₂O.

REFERENCES:

- I. E. Biewend. *J. prakt. Chem.* **15**, 440 (1838).
H. W. B. Roozeboom. *Rec. Trav. Chim. Pays-Bas* **3**, 59 (1884); **4**, 65 (1885).
- II. A. Ditte. *Compt. Rend. Hebd. Séances Acad. Sci.* **95**, 1283 (1882).
P. Villard. *Ann. Chim.* (7) **11**, 292 (1897).
Schröder. *Die Chemie der Gashydrate* [Chemistry of Hydrates of Gases], Stuttgart, 1926.
M. von Stackelberg. *Naturwiss.* **36**, 327, 359 (1949).

M. von Stackelberg and R. H. Müller. *Z. Elektrochem.* **58**, 25 (1954).

Bromine

Br_2

Even the purest commercial bromine contains approximately 0.05% Cl as well as traces of I, and must therefore be purified for special uses.

I. In order to remove most of the still present chlorine, bromine may be stored with pulverized KBr for a considerable time and then distilled off in high vacuum into a receiver cooled with a Dry Ice-ether mixture.

II. Very pure bromine may be prepared, according to Hönigschmid and Baxter, in the following manner: A concentrated solution of CaBr_2 or KBr is placed in a round-bottom flask connected with ground joints to a bromine-containing dropping funnel and to an exit tube, bent at right angles. The tube passes through a condenser into a receptacle containing ice-cold, very pure water. [The very pure CaBr_2 starting material is prepared by dropwise addition of bromine (which has been subjected to the purification described above) to ammoniacal calcium hydroxide. The calcium hydroxide is prepared from the very purest, halogen-free lime.] Bromine is added from the funnel to the flask and is then distilled off from the solution. As the Br_2 distills off, more bromine is added below the surface of the CaBr_2 (or KBr) solution from the dropping funnel. The distilled bromine is reduced to KBr by dropwise addition to a hot solution of recrystallized, halogen-free potassium oxalate. The KBr solution is evaporated. During evaporation, small quantities of Br_2 are liberated frequently by addition of acidified KMnO_4 solution, which through evaporation also removes any I_2 that may be present. According to Baxter, small quantities of absolutely pure Br_2 from a previous run may be added to achieve the same result. In order to decompose traces of organic materials, the KBr that crystallizes out is fused in a Pt crucible. It can then be considered completely free from Cl and I.

Bromine is now liberated by treatment of the KBr with very pure $\text{K}_2\text{Cr}_2\text{O}_7$ and very pure H_2SO_4 (the latter is obtained by distillation over $\text{K}_2\text{Cr}_2\text{O}_7$, discarding the forerun). However, the reaction with $\text{K}_2\text{Cr}_2\text{O}_7$ is not complete, since only about 75% of the needed $\text{K}_2\text{Cr}_2\text{O}_7$ enters into the reaction. Thus, the remaining Br_2 must be distilled again from the KBr solution formed. The product Br_2 is washed with water to remove HBr, separated from the entrained H_2O , and then dried over very pure CaO and CaBr_2 or over P_2O_5 . Finally, it is freed of these substances by distillation in vacuum.

PROPERTIES:

Formula weight 159.84. Reddish-brown, pungent liquid. M.p. -7.3°C , b.p. 58.8°C ; d (0°C) 3.19. Solubility in water (20°C) 3.53 g. of Br_2 per 100 g. of H_2O .

REFERENCES:

- I. W. A. Noyes, Jr. *J. Amer. Chem. Soc.* **45**, 1194 (1923).
- II. O. Hönigschmid and E. Zintl. *Liebigs Ann. Chem.* **433**, 216 (1923).
G. P. Baxter, C. J. Moore and A. C. Boylston. *J. Amer. Chem. Soc.* **34**, 260 (1912).

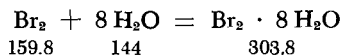
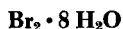
Bromine Hydrate

A 4% (by weight) solution of Br_2 in water (saturated solution at 0°C) is cooled to 0°C . This causes a small quantity of bromine hydrate (about 4% of the $\text{Br}_2\text{-H}_2\text{O}$ mixture) to separate out. Usually, however, the solution must be either seeded with some bromine hydrate or cooled for a short time to -5°C , after which the temperature is restored to 0°C . The precipitate is filtered on a glass filter funnel surrounded by a jacket containing ice water.

In order to form larger crystals, the product hydrate is sealed into a tube together with a large excess of 4% bromine water and kept for about four weeks on ice. The tube is warmed to $5\text{-}6^{\circ}\text{C}$ once each day.

PROPERTIES:

Light-red crystals, which must be stored in a sealed tube at temperatures below 6.2°C . Critical decomposition point; 6.2°C , 93 mm.; dissociation pressure (0°C), 45 mm.; d (solid) (0°C) 1.49.

The composition is somewhat uncertain. Cubic crystals have the theoretical composition $\text{Br}_2 \cdot 7\frac{2}{3} \text{H}_2\text{O}$.

REFERENCES:

- H. W. B. Roozeboom. *Rec. Trav. Chim. Pays-Bas* **3**, 73 (1884); **4**, 65 (1885).
H. Giran. *Comp. Rend. Hebd. Seances Acad. Sci.* **159**, 246 (1914).

W. H. Harris. *J. Chem. Soc. (London)* 1933, 582.

M. von Stackelberg. *Naturwiss.* 36, 327, 359 (1949).

M. von Stackelberg and H. R. Müller. *Z. Elektrochem.* 58, 25 (1954).

Iodine

I₂

Since even the purest commercial KI to be used for the preparation of specially purified iodine may still contain such impurities as Cl, Br, ICN, alkali sulfate, carbonate and sulfide, as well as traces of organic material, special purification is necessary.

I. Preparation of very pure iodine according to Hönigschmid.

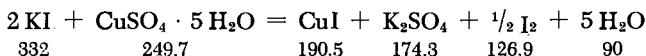

A supersaturated solution of C.P. purity KI is mixed with a solution of thrice recrystallized, completely halogen-free $\text{CuSO}_4 \cdot 5\text{H}_2\text{O}$. The CuI formed is allowed to settle and the supernatant solution of I₂ in KI is decanted and distilled. The I₂ is steam-distilled. The water is decanted from the condensate and the I₂ is again distilled from the KI solution and finally from pure water. After filtering through a glass frit, the iodine is dried in a desiccator over concentrated H₂SO₄ and finally sublimed in a quartz tube in a stream of nitrogen.

II. If extreme purification is unnecessary, commercial iodine or iodine regenerated from wastes can, according to a method described by Plotnikow, be sublimed, first over KI and then over BaO. It is then stored in ground glass containers placed in a desiccator over P₂O₅.

PROPERTIES:

Formula weight 253.84. Gray-black flakes with a metallic sheen. M.p. 113.7°C, b.p. 184.4°C; d 4.93. Solubility (20°C) 0.29 g./100 ml. of H₂O.

REFERENCES:

O. Hönigschmid and W. Striebel. *Z. phys. Chem. (A)* 156a (Bodenstein Anniversary Volume), 286 (1931).

M. Guichard. *Ann. Chim. et Phys. (9)* 7, 28 (1916).

W. A. Plotnikow and W. E. Rokotjan. *Z. phys. Chem.* 84, 365 (1913).

RECOVERY OF IODINE FROM LABORATORY WASTE SOLUTIONS

In the Arndt method, the oxidation of iodide residues with elementary oxygen, using nitric oxides as carriers, proceeds in accordance with the following reactions:

1. $\text{HI} + \text{HNO}_2 = \frac{1}{2}\text{I}_2 + \text{NO} + \text{H}_2\text{O}$
2. $\text{NO} + \frac{1}{2}\text{O}_2 = \text{NO}_2$
3. $2\text{HI} + \text{NO}_2 = \text{I}_2 + \text{NO} + \text{H}_2\text{O}$
4. $2\text{NO}_2 + \frac{1}{2}\text{O}_2 + \text{H}_2\text{O} = 2\text{HNO}_3$

This procedure is feasible because reaction 4 proceeds slowly in relation to reactions 1-3 so that, as long as iodine is present, no significant loss of nitric oxides occurs.

A large flask is closed off with a rubber stopper. A gas inlet is inserted through the stopper, reaching almost to the bottom; this tube is attached to the inlet tube of an empty wash bottle by a fairly long piece of flexible tubing; the other tube of the wash bottle is attached to a gasometer filled with O_2 from a cylinder. The alkaline solution of iodine residues, after concentration by evaporation, is placed in the flask, which should be no more than half full. It is then acidified with concentrated H_2SO_4 and the free space of the flask—with the stopper left loose—is filled with oxygen. The gasometer stopcock is then closed and nitrite solution is added to the flask until the free space acquires an intense reddish-brown color. The stopper is then pushed firmly down and the gasometer cock opened. The oxygen begins to flow into the closed flask either immediately or after very slight rotation of the stopcock. The flask is shaken, at first gently and then vigorously and continuously. The rate of oxygen absorption is checked from time to time by interrupting the shaking to determine whether O_2 is still flowing rapidly in and whether the gaseous phase is still red-brown. Should this not be the case, due to the accumulation of inert gases (from the N_2 in the O_2 used or from reduction of a small quantity of the nitric oxide to N_2O or N_2), the stopper is raised for a moment. If this does not restore the O_2 absorption and the formation of NO_2 , the stopcock is closed, further nitrite solution is added, and the procedure is continued. If shaking is started or stopped too quickly, some liquid may be driven into the wash bottle due to a temporary rise in pressure. However, the O_2 stream which again starts to flow drives it back into the flask. Completion of the oxidation may be recognized by the cessation of O_2 absorption and by the fact that the gaseous phase becomes colorless. After the black, crystalline iodine has settled, the completeness of the iodine precipitation may be checked by adding a few drops of nitrite solution. The mother liquor (which contains only about 0.5 g. of iodine per liter) is decanted and the iodine

precipitate is placed in a round-bottom flask, where it may be combined with iodine prepared in other runs. The I_2 is then steam-distilled from this flask. No condenser is used; instead, the vapor mixture is passed through a large tube (10-15 mm. in diameter) directly into the center of a large two-liter Erlenmeyer flask which is closed with a paraffin-coated cork stopper and immersed in a bath with flowing water. A second hole in the cork stopper contains a vent tube about 0.5 m. long and 1 cm. in diameter. The I_2 separates on the walls as a compact mass. The substance may easily be detached from these surfaces by shaking and cooling. It is crushed with a glass rod and suction-dried while pressing the water out.

The filtered I_2 is given a preliminary and final drying over $CaCl_2$ or concentrated H_2SO_4 in an ungreased desiccator and then sublimed. The iodine is placed in a spoutless beaker, which is immersed in a hot water bath while a round-bottom flask, filled with cold water, is set on top of the beaker. The flask becomes covered with moisture and some iodine and is replaced with a second flask before the condensed water can drop back. This is repeated as long as moisture is evolved. The end of the water evolution can be recognized by the fact that dry I_2 sticks firmly to the water-cooled glass, whereas moist iodine may easily be washed off the glass with a stream from a wash bottle. The wet beaker is now carefully wiped and carefully heated on an asbestos wire gauze. The round-bottom flask is now cooled on the inside with flowing water. As soon as a 0.5-1 cm. crust of iodine forms, it is scraped off and put in a storage flask. The sublimation is then continued until all the I_2 in the beaker has sublimed.

The method described must be modified in some cases, e. g.:

If the iodine residues contain considerable quantities of Fe, the oxidation must be carried out with heating in order to decompose Fe-NO complexes. If Hg or Pb salts are present, the procedure described in *Chemiker-Ztg.* 47, 16 (1923) is used.

Other preparative methods: A procedure for the recovery of I_2 (and Ag) from AgI residues is given by J. R. Spies, *Ind. Eng. Chem., Anal. Ed.* 7, 118 (1935); J. R. Spies in: W. C. Fernelius, *Inorg. Syntheses*, Vol. II, New York-London, 1946, p. 6.

If iodine is to be recovered from organic iodine compounds, the organic portion is decomposed with a $KClO_3$ - Cl_2 mixture [E. M. Marshall, *J. Chem. Ed.* 7, 1131 (1930)].

Another procedure, based on reaction with Cl_2 , is described by C. de Witt, *J. Chem. Ed.* 14, 215 (1937).

In collecting the iodine residues the greatest care should be taken to avoid the presence of any volatile organic solvents in the container. If nonvolatile organic materials such as starches are absent, the steam distillation described above may be omitted.

Great care should be taken to avoid contaminating the iodine residues with ammonium salts. Violent explosions may be caused by the formation of nitrogen iodide.

REFERENCES:

- F. Arndt, Ber. dtsch. chem. Ges. 52, 1131 (1919).
 F. Arndt, Chem. Ztg. 47, 16 (1923).

Hydrogen Chloride

HCl

I. An easily controllable stream of hydrogen chloride gas may be readily obtained by allowing pure, concentrated hydrochloric acid to flow into concentrated H_2SO_4 .

An essential constituent of the apparatus shown in Fig. 143 is the capillary tube. This must be completely filled with hydrochloric acid before the evolution is started, in order to assure the hydrostatic pressure necessary to cause the lighter hydrochloric acid to flow to the bottom of the vessel which contains the heavier H_2SO_4 . Only by allowing the acid to flow in this way is the generation of the gas completely uniform and controllable.

A separatory funnel is filled with approximately 200 ml. of concentrated H_2SO_4 , and concentrated hydrochloric acid (d, 1.18) is added from a dropping funnel at such a rate as to give the gas flow desired. When 200 ml. of concentrated hydrochloric acid (i. e., the same volume as the volume of H_2SO_4 used) has been added, gas evolution stops and the dilute sulfuric acid, which now contains very little HCl, is discharged and replaced by fresh H_2SO_4 . (If more than an equal volume of hydrochloric acid is added, HCl continues to be formed for a while after the stopcock is closed; however, the yield is reduced.) The yield from 200 ml. of concentrated hydrochloric acid is 67.4 g. of HCl.

If a uniform stream of HCl is required for a longer period, the apparatus designed by Seidel (Fig. 144) is recommended. Concentrated hydrochloric acid and concentrated sulfuric acid are dropped continuously from tubes *a* and *b* into the reaction tube,

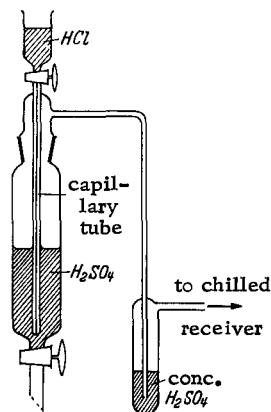

Fig. 143. Preparation of hydrogen chloride.

which is about 5 cm. in diameter and contains a 20- to 25-cm. layer *c* of packing, such as silica or glass beads. The spent liquid mixture automatically drains off below. With an apparatus of these dimensions, up to three liters of HCl gas can be produced per minute.

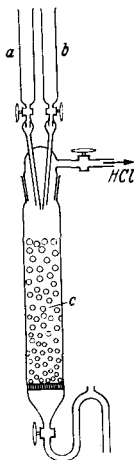

Fig. 144. Preparation of hydrogen chloride. *a*, *b*) Dropping tubes for concentrated HCl and concentrated H_2SO_4 ; *c*) reaction tube packing (silica or glass beads, diameter 2-5 mm.).

In order to remove moisture that may be present, the product gas is led through a wash bottle containing concentrated H_2SO_4 (P_2O_5 must not be used because the gas forms volatile phosphorus compounds with it) and into a receiver chilled with liquid nitrogen. The receiver is then detached from the generator and the gas is fractionally distilled. Only the middle fraction is pure enough for use in further work. (For the apparatus see Part I, p. 66 ff.)

If an especially pure product is not required, the ground glass part of the separatory funnel in Fig. 143 may be replaced by a two-hole rubber stopper. The freezing and fractional distillation of the hydrogen chloride may be omitted in this case.

PROPERTIES:

Formula weight 36.47. Colorless, pungent gas. M.p. $-112^\circ C$, b.p. $-85.0^\circ C$; crit. t. $51.3^\circ C$, crit. p. 83 atm.; d. (liq.) ($-85^\circ C$) 1.189. Solubility in water: 1 vol. ($15^\circ C$) dissolves about 450 vol. of HCl (47% by weight).

Attacks rubber and stopcock grease; glass stopcocks should therefore be lubricated with concentrated H_2SO_4 . The gas can be stored over Hg or over H_2SO_4 .

II. According to Hönigschmid, very pure aqueous solutions of HCl can be obtained by diluting pure laboratory hydrochloric acid to 20% with water, boiling it with small amounts of $KMnO_4$ to remove bromine and iodine, and then distilling it through a quartz condenser. If the purified hydrochloric acid prepared in this way is needed in more concentrated form, HCl gas is generated from this dilute solution with H_2SO_4 according to the method given under I, and this product gas is then bubbled through purified 20% hydrochloric acid until the latter becomes saturated.

REFERENCES:

- I. R. N. Maxson in: H. S. Booth. *Inorg. Syntheses*, Vol. I, New York-London, 1939, p. 147.
O. R. Sweeney. *J. Amer. Chem. Soc.* 39, 2186 (1917).
A. Klemenc. *Die Behandlung und Reindarstellung von Gasen* [Treatment and Purification of Gases], 2nd ed., Vienna, 1948, p. 234.
W. Seidel. *Chem. Fabrik* 11, 408 (1938).
- II. O. Hönigschmid. *Safder Bedr Chan and L. Birckenbach. Z. anorg. allg. Chem.* 163, 315 (1927).

Hydrogen Bromide

HBr

The method chosen for producing hydrogen bromide depends upon whether it is to be anhydrous or in aqueous solution, as well as on the amount required and the requisite degree of purity of the product.

Methods I and II, which are suitable for the preparation of anhydrous HBr, may also be modified to give aqueous solutions, but the special procedures for obtaining aqueous solutions (V) cannot be modified to give anhydrous HBr. However, regardless of the manner in which they have been prepared, HBr solutions can be dehydrated with P_2O_5 via method III.

While method I (tetralin plus Br_2) is very convenient, it should be realized that half of the Br_2 input is lost by reaction with the tetralin. Therefore, method II ($H_2 + Br_2$) is preferred for preparing larger quantities of HBr.

How far the described procedures can be simplified if a highly purified product is not required will be indicated under the respective methods.

I. Preparation of anhydrous HBr from tetralin (tetrahydronaphthalene) and Br_2 :

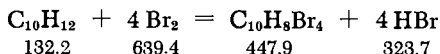

Bromine is gradually added by drops to a mixture of tetralin and pure iron filings contained in a round-bottom flask equipped with a dropping funnel and a gas outlet tube. (Prior to use, the tetralin is dried over anhydrous Na_2SO_4 and distilled; b.p. of the tetralin is $207^\circ C$, vapor pressure at $15^\circ C$, 0.3 mm.; C. P. grade Br_2 should be used.) Since initial cooling is necessary, the flask is placed in a water bath, which, as soon as the reaction becomes sluggish, is heated to 30 to $40^\circ C$. The gas formed in the reaction is passed

through a wash bottle filled with tetralin (also predried and distilled) in order to eliminate small quantities of Br_2 , and through a trap cooled to -60°C in order to remove the last traces of moisture. It is then frozen in a second trap cooled with liquid nitrogen. After completion of the reaction, the receiver trap is separated from the gas generating apparatus by melting the connection.

A more effective method for removal of the last traces of water involves trapping at -70°C instead of -60°C , so that some liquid HBr can accumulate through which the remaining HBr gas will bubble.

The condensed HBr is purified by subliming part of the solid product and collecting the middle fraction in a receiver cooled with liquid nitrogen. The container is then sealed off. The pressures in the preparation and fractionation sections of the apparatus should be monitored by means of an attached manometer. (For suitable apparatus, see Part I, p. 66 ff.)

II.

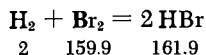

The arrangement shown in Fig. 145 is used; hydrogen bubbles through wash bottle *A*, serving as a flowmeter. It then accumulates

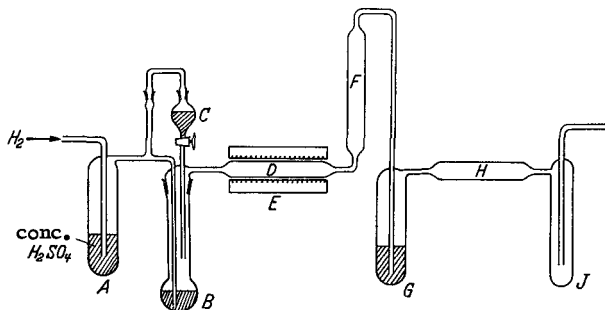

Fig. 145. Preparation of hydrogen bromide.

in flask *B*, to which Br_2 can be added in drops from dropping funnel *C*. The connecting tube from *A* must reach to the bottom of *B*. Between *A* and *B* a part of the H_2 stream is diverted to *C* so that when the closed-off vessel *C* is depleted, pressure equilibrium will be maintained. The H_2 stream carrying the Br_2 vapor then enters Pyrex tube *D* (40-50 cm. long, 2-4 cm. in diameter), filled with platinized asbestos or platinized silica gel held in place by glass wool plugs. This tube is heated in electric furnace *E*. The tube is connected to tube *F*, which contains red phosphorus dispersed on glass spheres or Raschig rings, and to a wash bottle *G*,

which contains a few milliliters of water to remove entrained phosphorus compounds. The HBr-H₂ mixture finally passes through a drying tube *H* filled with CaCl₂ (CaBr₂ is better, of course) and is frozen in trap *J* by cooling with liquid nitrogen.

Procedure: Before adding the Br₂ to *B*, the air in the apparatus is displaced by a stream of H₂. When this has been accomplished, the furnace is heated to 350°C and the first portion of about 50 ml. of Br₂ is admitted to container *B*. The H₂ should pass through the bromine layer (25°C) in a rather fast stream in order to assure a constant excess of H₂. Deterioration of the catalyst may be recognized by the increased presence of free Br₂ in the part of the apparatus connected to tube *D*. Care should be exercised to avoid channeling of the gas through tube *D* due to shrinkage of the catalyst. If no such precautions are taken, the H₂-Br₂ mixture is likely to emerge unconverted from the reactor.

The HBr frozen out in *J* is purified by fractional distillation as indicated in method I.

As a safety measure it is desirable that container *B* not be exposed to direct light. It is best to paint *B* black (leaving some peepholes in order to be able to check the amount of Br₂ present). When needed, rubber stoppers (which then must be frequently changed) and rubber tubing over the glass-to-glass connections may be used. Ground glass or fused joints are better, however. Because of the necessary pressure in the system, the stoppers on the wash bottles should be correspondingly well secured.

Other preparative method:

III. Dehydration of concentrated HBr solutions with P₂O₅. A round-bottom flask is partly filled with very pure P₂O₅; HBr solution is then added in drops from a dropping funnel, with simultaneous cooling. Purification of the gas stream thus produced is carried out as described in method I (A. Klemenc).

PROPERTIES:

Formula weight 80.93. Colorless gas. M.p. -87°C, b.p. -67°C; d. (-68°C) 2.17. A saturated solution in H₂O at 0°C contains 68.85% and at 25°C, 66% HBr. The constant-boiling acid at 760 mm. and 126°C contains 47.8% HBr.

Completely dry HBr may be stored for some time over Hg. After a while, decomposition sets in, possibly promoted by light and stopcock grease.

IV. Aqueous solutions of HBr may be prepared using the HBr prepared and purified according to I or II. If a less pure product is sufficient, it is possible to simplify the procedure in the following ways:

In method I: The HBr, after passing through the wash bottle containing tetralin, is led directly into water cooled with an

ice-salt bath. The yield in this case is 94% of theoretical. When it is remembered that half the bromine is lost by combining with the tetralin, the yield based on total bromine reacted is 47%.

An even simpler method is to mix equal quantities of tetralin and water and then slowly drop Br_2 in with continuous stirring. The aqueous and nonaqueous layers are separated in a separatory funnel, the nonaqueous layer is again washed with H_2O , and the wash water is combined with the main HBr solution.

In method II: Drying tube *H* and trap *J* are replaced by one or more interconnected wash bottles containing water and cooled by an ice-salt bath. In this case, approximately 65% HBr solutions are obtained.

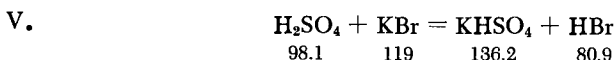

A direct method, which is suitable only for the preparation of constant-boiling HBr solutions, depends on the effect of dilute sulfuric acid on KBr (concentrated H_2SO_4 would oxidize the HBr to Br_2).

A mixture of 120 g. of pulverized KBr and 200 ml. of H_2O is chilled with cold water and slowly reacted with 90 ml. of concentrated H_2SO_4 . The temperature should not be allowed to rise above 75°C to retard possible formation of free bromine. The solution is then cooled to room temperature and the KHSO_4 is filtered off through a Büchner funnel (using hard filter paper). The filtrate is placed in a 500-ml. distillation flask equipped with a suitable condenser and receiver and heated over a wire gauze. After distilling off the water, the fraction that is collected begins to boil 1° below the boiling point of the azeotrope [b. p. 122.5°C (740 mm.), 126°C (760 mm.)] and the distillation is stopped as soon as the temperature begins to drop. The yield is about 85%.

This acid may still contain about 0.01% H_2SO_4 . Acid that is completely free of H_2SO_4 —in the highest attainable concentration—is obtained if collection of the distillate is begun 5° below the boiling point of the constant-boiling acid. This distillate is then redistilled, but only the fraction at the boiling point of the azeotrope is collected.

REFERENCES:

- I. A. Müller. *Mh. Chem.* 49, 29 (1928).
A. Klemenc. *Die Behandlung und Reindarstellung von Gasen* [Treatment and Purification of Gases]. 2nd ed., Vienna, 1948, p. 237.
- II. J. M. Schneider and W. C. Johnson in: H. S. Booth. *Inorg. Syntheses*, Vol. I, New York-London, 1939, p. 152.

- T. W. Richards and O. Höning Schmid. J. Amer. Chem. Soc. 32, 1581 (1910).
- V. G. V. Heisig and E. Amdur. J. Chem. Ed. 14, 187 (1938); Chem. Zentr. 1937 II, 1760.
- G. B. Heisig and E. Amdur in: H. S. Booth. Inorg. Syntheses, Vol. I. New York-London, 1939, p. 155.

Hydrogen Iodide

HI

The choice of preparative method depends on whether anhydrous HI or an HI solution is required. Method I (preparation of anhydrous HI from H_2 and I_2) is quite suitable for the preparation of HI solutions, while method III ($H_2S + I_2$) is limited to solutions, unless (in accordance with II) the highly concentrated aqueous solution is dehydrated with P_2O_5 . Since HI solutions soon turn brown on standing (due to the formation of iodine by light and air), a method (IV) for regenerating such solutions is also given.



Hydrogen is passed over I_2 contained in a 250-ml. Pyrex flask *A* (see Fig. 146) which can be heated. A Pyrex tube *B*, 90 cm. long and 1.8-2 cm. in diameter, is connected to the flask. If possible, this tube is fused on directly. If absolutely necessary it may be connected by a ground joint. However, in this case the joint is sealed on the outside with asbestos-waterglass mixture. The part of the tube nearest flask *A* is filled for a length of 10-20 cm. with platinized asbestos or a mixture of asbestos with Pt sponge which is then heated to 500°C in a furnace. The tube is followed by a U tube *C* containing CaI_2 to dry the HI, a U tube *D* with KI to remove the last traces of iodine, and a freezing trap *E* which is cooled to -78°C. A P_2O_5 tube *F* serves as protection against atmospheric moisture. It is advisable to provide a bypass tube for H_2 . The bypass hydrogen stream may then be used as a carrier gas to carry unreacted iodine, or iodine formed by decomposition of HI, from the empty part of tube *B* back to flask *A*. In order to do this, stopcock H_1 is opened, and the two-way stopcock is turned to a position 180° from that shown in Fig. 146. After cooling the catalyst, the I_2 is heated with a Bunsen burner and sublimed in a stream of hydrogen, which carries it into *A*.

Preliminary treatment of starting materials: Cylinder H_2 is, as usual, passed over a Pt catalyst and through a system of drying tubes. The purest available I_2 is used; it is dried in a vacuum over P_2O_5 and, in order to remove any remaining Cl and Br, is intimately mixed with 5% by weight of KI. For the platinized

asbestos, see the section on Platinum Metals; about 3 g. of asbestos fibers is saturated with 7 ml. of 10% H_2PtCl_6 solution; the damp mixture is evaporated to dryness with continuous stirring and the product is then heated to red heat.

Procedure: After *A* has been charged with I_2 , the air in the apparatus is carefully displaced by N_2 , following which H_2 is passed through. (If H_2 were to be admitted while the apparatus still contained oxygen, the catalyst could promote an explosive reaction of the hydrogen-oxygen mixture.) The catalyst is now heated. The I_2 in flask *A* is heated just enough to produce very small quantities of I_2 vapor in the part of tube *B* that extends beyond the catalyst. Experience shows that the correct temperature of the I_2 is reached when the condensation zone in the iodine flask lies somewhat higher than the side arm. Some I_2 also condenses in the connecting tube between *A* and the catalyst and must therefore be carefully sublimed from time to time with a Bunsen burner. (In general, care should be taken during the entire run to assure that there are no solid I_2 plugs at any point of the apparatus.) The HI product,

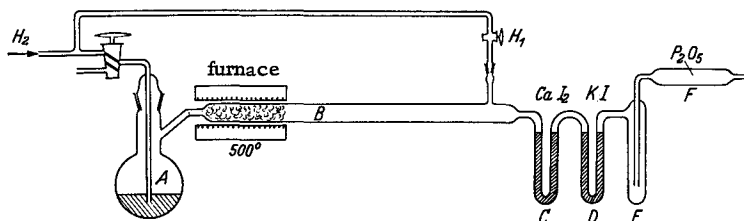

Fig. 146. Preparation of hydrogen iodide.

after passing through purification tubes *C* and *D* (which may be omitted if a high purity product is not required), is frozen in *E* and then repeatedly fractionated. At the end of the run, the catalyst is cooled in a stream of H_2 .

II. Another preparative method for anhydrous HI consists in dehydration of highly concentrated HI solutions by P_2O_5 . A round-bottom flask is partially filled with very pure P_2O_5 . The HI solution is then added in drops from a dropping funnel, while the flask is cooled. The gaseous product is dried in an adjoining tube with P_2O_5 . Further purification of the HI product proceeds in accordance with method I.

PROPERTIES:

Formula weight 127.93. Colorless gas. M.p. -50.9°C , b.p. -35.4°C ; d , (0°C) 5.66. Solid or liquid HI can be stored at a low temperature away from light. Solubility at 0°C , 900 g. of $\text{HI}/100$ g. of H_2O .

No rubber tubing or stoppers should be used with HI, if at all possible. If greased stopcocks must be used, white vaseline is the most suitable lubricant.

III. Solutions of HI may be obtained if the product prepared according to I, instead of being condensed, is dissolved in water cooled in an ice-salt bath.

The following method may be used to prepare azeotropic aqueous HI solution:

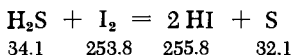

A suspension of 120 g. of I_2 in 150 ml. of H_2O is vigorously stirred in a wide-neck 500-ml. vessel with a three-hole stopper (for a gas inlet tube which reaches below the surface of the liquid, a gas outlet tube, and a stirrer). The stirrer must fit the walls of the vessel as closely as possible. A stream of H_2S is then absorbed by the suspension, the flow rate being controlled so as not to exceed the absorption rate. Any slight excess of H_2S leaves the reaction vessel through the gas outlet tube and goes either to a hood or is passed over the surface of a sodium hydroxide solution in a special flask; the outlet tube should not dip into the sodium hydroxide. After about an hour, the solution in the absorption flask becomes practically colorless due to the separation of considerable quantities of sulfur. The solution is then separated from the coarser sulfur particles by decantation and filtered through a glass frit to remove the fine sulfur. The H_2S , still dissolved in the solution, is removed by a short period of boiling, after which a test of the solution should not give a reaction for sulfide.

The solution is distilled from a 250-ml. distillation flask, using boiling chips to avoid bumping. The fraction boiling from 125 to 127°C is collected. The yield is about 90% based on the I_2 used. The azeotropic acid (57% HI) boils at 126°C (760 mm.), d 1.70. It fumes strongly in air. Aqueous HI solutions must be stored in dark, well-sealed flasks. It is advisable to seal the storage flasks with paraffin. As a further precaution against oxidation, the air above the surface of the liquid may be displaced by an inert gas before sealing the flask.

IV. Concentrated HI solutions that have become brown due to the separation of iodine may be regenerated as follows:

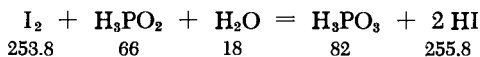

The reaction is carried out in a 500-ml. ground glass flask which is equipped with an inlet tube for inert gas (N_2 , H_2 or CO_2) and a fractionating column. The latter carries a dropping funnel

(connected with a ground glass joint) on top. The iodine-containing HI solution is brought to near boiling with inert gas slowly passing through the flask. The hot solution is then reacted with 50% H_3PO_2 solution, added by drops until decolorization occurs (only a few milliliters are needed for this, depending on the iodine content). The dropping funnel is now replaced by a ground joint thermometer, and the azeotropic acid is distilled off at 125-127°C (760 mm.).

REFERENCES:

- I and III. M. Bodenstein. *Z. phys. Chem.* 13, 59 (1894).
 M. Bodenstein and F. Lieneweg. *Z. phys. Chem.* 119, 124 (1926).
 R. H. Ogg, Jr. *J. Amer. Chem. Soc.* 56, 526 (1934).
 A. Klemenc. *Die Behandlung und Reindarstellung von Gasen* [Treatment and Purification of Gases], 2nd ed., Vienna, 1948, p. 239.
 G. B. Heisig and O. C. Frykholm in: H. S. Booth, *Inorg. Syntheses*, Vol. I, New York-London, 1939, p. 157.
 H. Grubitsch, *Anorg. präp. Chemie* [Preparative Inorganic Chem.], Vienna, 1950, p. 278.
- II. K. F. Bonhoeffer and W. Steiner, *Z. phys. Chem.* 122, 288 (1926). G. K. Rollefson and J. E. Booher, *J. Amer. Chem. Soc.* 53, 1728 (1931).
- IV. L. S. Foster and H. G. Nahas in: W. C. Fernelius, *Inorg. Syntheses*, Vol. II, New York-London, 1946, p. 210.

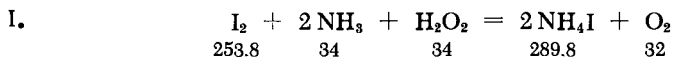
Ammonium Iodide **NH_4I** 

Powdered iodine (100 g.) is reacted with 280 ml. of 10% ammonia water (i. e., double the stoichiometric quantity) and 600 ml. of 3% H_2O_2 (i. e., 33% excess). The I_2 dissolves and O_2 is evolved. In some cases, further H_2O_2 solution must be added until the reaction mixture becomes pure yellow. The solution is evaporated on a steam bath.

The colorless crystals that separate deliquesce rapidly in moist air.

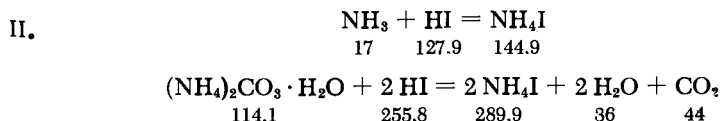

A solution of HI and a solution of NH_3 or $(\text{NH}_4)_2\text{CO}_3$ are combined in stoichiometric quantities and evaporated until crystallization of NH_4I occurs.

To prepare completely iodine-free, colorless crystals (in a hydrogen atmosphere), see P. Wulff and H. K. Cameron, *Z. phys. Chem.* (B) 10, 350 (1930).

PROPERTIES:

Formula weight 144.96. Colorless, very deliquescent crystals. d. 2.56. Sublimes on heating. Solubility (25°C): 177 g./100 g. H_2O .

REFERENCES:

- I. T. C. N. Broeksmit. *Pharm. Weekbl.* 54, 1373 (1917).
E. Rupp. *Apotheker-Ztg.* 33, 460, 473 (1918).
- II. Ullmann. *Enzyklopädie der technischen Chemie*, 2nd ed., Berlin-Vienna 1928/32, Vol. 6, p. 289.

Potassium Iodide

KI

In order to prepare very pure KI, C.P. HI solution is allowed to react with KHCO_3 , and the KI formed is heated in a stream of H_2 to 725°C (m.p. 680°C).

REFERENCES:

- I. I. Lingane and J. M. Kolthoff in: H. S. Booth. *Inorg. Syntheses*, Vol. I, New York-London, 1939, p. 163.
- J. M. Kolthoff and I. I. Lingane. *J. Amer. Chem. Soc.* 58, 1524 (1936).

Iodine Monochloride

ICl

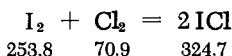

About 300 ml. of cylinder Cl_2 is condensed in a weighed 500-ml. flask surrounded by a Dry Ice-ether bath. Penetration of moisture into the flask must be avoided. Approximately half the stoichiometric quantity of I_2 is added to the chlorine in the flask. The

amount necessary is determined from the roughly estimated volume of Cl_2 but should be weighed exactly before being added (300 ml. = 468 g. of Cl_2 requires 1674 g. of I_2 ; half = 837 g. of I_2). The reaction mixture solidifies after addition of the I_2 . The cold bath is removed, the flask is allowed to warm to room temperature, and the unreacted chlorine is thus removed by evaporation.

The flask and its contents are then weighed and, after subtracting the known weight of the empty flask and of the iodine added, the weight of Cl_2 reacted is obtained. This quantity is always larger than that corresponding to the formation of ICl with a given quantity of I_2 , indicating that some ICl_3 has formed. Therefore, iodine equivalent to the excess Cl_2 is added.

The flask is closed with a glass stopper and allowed to stand 24 hours or longer at room temperature. The crude product (at least 1070 g.) is "recrystallized" once or twice for complete purification; the liquid ICl is cooled until about 80% of the material solidifies. The liquid portion is then discarded.

PROPERTIES:

Formula weight 162.38. Reddish-brown liquid at ordinary temperatures; exists in two solid modifications: α - ICl , ruby-red needles (m.p. 27.19°C); β - ICl , brownish-red plates (m.p. 13.9°C), labile form.

The boiling point at atmospheric pressure cannot be determined exactly since ICl decomposes at the boiling point into I_2 and Cl_2 ; however, it lies in the vicinity of 100°C . d. (liq.) (29°C) 3.10.

Vigorously attacks cork, rubber and the skin, forming very painful patches (antidote: 20% hydrochloric acid).

Not hygroscopic; however, I_2O_5 is formed on the vessel walls as a result of hydrolysis by the moisture of the air.

REFERENCES:

- J. Cornog and R. A. Karges. *J. Amer. Chem. Soc.* 54, 1882 (1932).
W. Stortenbeker. *Rec. Trav. chim. Pays-Bas* 7, 158 (1888).
J. Cornog and R. A. Karges in: H. S. Booth. *Inorg. Syntheses*, Vol. I, New York-London, 1939, p. 165.

Iodine Monobromide

IBr

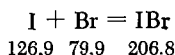

A weighed quantity of finely powdered iodine is reacted in a cooled, round-bottom flask with the stoichiometric quantity of

dry bromine (added in portions). The mixture is then heated at 45°C in a nitrogen stream for a few hours. Further purification is achieved by allowing the melt to cool slowly (in the absence of moisture), and after the material has crystallized, most of the remaining liquid is decanted and discarded. The flask contents are remelted and the process repeated several times.

The product is best stored under dry N₂ in a sealed container. Rubber stoppers should be avoided under any circumstances. It is best to work with IBr in closed systems since it attacks the eyes and mucous membranes rather vigorously.

PROPERTIES:

Brownish-black crystals with an odor similar to bromine. M.p. 40-41°C, b.p. 119°C; d. (0°C) 4.416, (50°C) 3.73. The vapor is largely dissociated.

REFERENCE:

V. Gutmann, Mh. Chemie 82, 156 (1951).

Iodine Trichloride

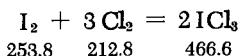

I. Since passing Cl₂ over I₂ gives impure products and poor yields, the method of Thomas and Depuis is recommended. In this procedure, iodine is added to excess liquid Cl₂, and the excess Cl₂ is then evaporated.

A 200-ml. quantity of Cl₂ (10% excess) is condensed in a flask cooled by a Dry Ice-acetone bath and protected from moisture. Finely powdered I₂ (338.3 g.) is gradually added, whereupon orange ICl₃ immediately precipitates. To complete the reaction, the mixture is allowed to stand in a cooling bath for a few hours. The excess chlorine is distilled at room temperature into a second cooled container (where it may be reacted with more I₂). The yield of ICl₃ is quantitative (622 g.).

II. According to E. Birk, Cl₂ gas is passed over I₂, which is cooled by a Dry Ice-acetone bath to -79°C, until yellow droplets of excess Cl₂ are visible. The reaction mixture is allowed to remain in the cooling bath for a few hours and the Cl₂ is then evaporated at room temperature. The yield is theoretical.

III. According to G. Mann, a layer of 500 g. of powdered iodine is spread over 250 g. of finely powdered KClO_3 contained in a 1500-ml. Erlenmeyer flask. Then 250 ml. of water is added. Finally, 950 ml. of concentrated hydrochloric acid is added in small portions over a period of 45 minutes. The temperature should remain below 40°C . The cold solution is filtered through fritted glass; the ICl_3 crystals are recrystallized from alcohol and dried over CaCl_2 in vacuum. The yield, based on the I_2 used, is 75%.

PROPERTIES:

Formula weight 233.3. Loose, orange powder or long, yellow needles with a penetrating, pungent odor. Very corrosive to the skin and leaves painful brown patches.

M.p. 101°C under the pressure of its own vapor (16 atm.). Very volatile even at room temperature and must therefore be stored in well-sealed flasks. Vapor pressure 1 atm. at 64°C . The vapor is almost completely dissociated to ICl and Cl_2 ; at 77°C , dissociation to ICl and Cl_2 is complete. d. (-40°C) 3.203.

Used as a chlorinating agent and as an oxidant (e. g., in sulfide analysis), in the form of a 25-35% solution of ICl_3 in concentrated hydrochloric acid.

REFERENCES:

- I. V. Thomas and P. Depuis. *Compt. Rend. Hebd. Séances Acad. Sci.* 143, 282 (1906).
H. S. Booth and W. C. Morris in: H. S. Booth, *Inorg. Syntheses*, Vol. I, New York-London, 1939, p. 167.
- II. E. Birk. *Angew. Chem.* 41, 751 (1928); *Z. anorg. allg. Chem.* 172, 399 (1928).
E. Wilke-Dörfur and E. A. Wolff. *Z. anorg. allg. Chem.* 185, 333 (1930).
- III. G. Mann. *Magyar Kémiai Folyóirat* 57, 143 (1951); abstract in *Chem. Zentr.* 1953, 349.

Polyhalides

Numerous compounds of this sort are known. The selection given here—with the exception of $\text{KI}_3 \cdot \text{H}_2\text{O}$ and $\text{HICl}_4 \cdot 4\text{H}_2\text{O}$ —is so chosen that to each of the previously described interhalogen compounds there corresponds a polyhalide which yields that compound on decomposition.

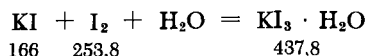
Potassium Triiodide

The theoretical quantity of I_2 is added to a hot, saturated solution of KI ; after the iodine dissolves, the mixture is cooled to 0°C , whereupon $\text{KI}_3 \cdot \text{H}_2\text{O}$ crystallizes out.

PROPERTIES:

Dark brown, hygroscopic prisms which melt in a sealed tube at 38°C and liberate iodine at 225°C , leaving KI .

For a discussion of the fact that anhydrous KI_3 is unstable at room temperature while the monohydrate is stable, see the references given under II.

REFERENCES:

- I. H. L. Wells and H. L. Wheeler. *Z. anorg. allg. Chem.* 1, 453 (1892).
- II. N. S. Grace. *J. Chem. Soc. (London)* 1931, 608.
H. W. Foote and W. C. Chalker. *J. Amer. Chem. Soc.* 39, 565 (1908).

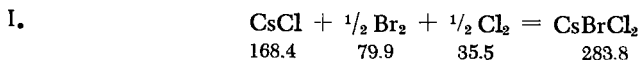
Cesium Dichlorobromide

A solution of 16.9 g. of CsCl in 85 ml. of water is prepared and treated with 8 g. Br_2 . The solution is then slightly heated in order to hold in solution the CsClBr_2 that is formed. The solution is then saturated with Cl_2 ; glittering yellow crystals of CsBrCl_2 form. These are filtered, washed with some water, and recrystallized from a small amount of water. A better yield is obtained if the CsCl is dissolved in only 45 ml. of water. The bromine is then added, red crystals of CsClBr_2 precipitate, and Cl_2 is then introduced without producing any harmful effects.



According to Ephraim, CsBrCl_2 may also be produced by introducing Cl_2 into CsBr solution until saturation.

Cremer and Duncan carried out the same reaction, but used dry CsBr at room temperature.

PROPERTIES:

Glittering yellow crystals which melt in a sealed tube at 205°C but which, when heated in the open at about 150°C, evolve bromine, leaving CsCl. (If the salt is not stored in well-sealed flasks, an appreciable amount of halogen is given off even at room temperature.)

REFERENCES:

- I. H. L. Wells. Amer. J. Sci. [3] 43, 28 (1892); Z. anorg. allg. Chem. 1, 98 (1892).
- II. F. Ephraim. Ber. dtsch. chem. Ges. 50, 1083 (1917).
H. W. Cremer and D. R. Duncan. J. Chem. Soc. (London) 1931, 1865; 1933, 187.

Potassium Dichloroiodide



I. DRY PROCESS:

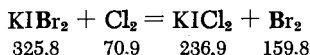

Dry Cl₂ is allowed to react with dry KIBr₂ at room temperature. After a few minutes KICl₂ is formed and the Br₂ produced is carried off in the Cl₂ stream. (When the reaction is continued for a longer period, KICl₄ is formed instead.)

It is also possible to prepare KICl₂ in a dry process by grinding KICl₄ with KIBr₂:

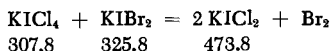

and driving off the Br₂ formed as a byproduct.

II. AQUEOUS PROCESS:

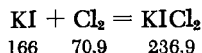

Chlorine is introduced into a very concentrated solution of KI until the initially precipitated I₂ redissolves. In order to prevent

further chlorination to $KICl_4$, finely pulverized KI is added until the I_2 that separates is redissolved—with slight heating if necessary. Crystallization occurs on cooling.

PROPERTIES:

Long, orange crystals, very unstable in air. Begins to soften at $60^\circ C$ in a sealed tube; liberates the labile halogen at $215^\circ C$.

REFERENCES:

- I. H. W. Cremer and D. R. Duncan, J. Chem. Soc. (London) 1931, 1863.
- II. F. Ephraim, Ber. dtsch. chem. Ges. 50, 1086 (1917).

Cesium Dichloriodide

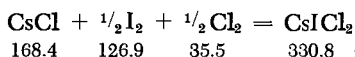

A solution of 16.8 g. of CsCl in 170 ml. of water is prepared and, after addition of 2.7 g. of I_2 , is brought almost to boiling. Chlorine is introduced into the hot solution until the I_2 dissolves. An excess of Cl_2 should be avoided to prevent formation of $CsICl_4$. On cooling, $CsICl_2$ crystallizes out. It may be purified, if necessary, by recrystallization from a small amount of hot hydrochloric acid (1 : 1) and washing with a small amount of cold hydrochloric acid.

PROPERTIES:

Orange crystals which melt at $238^\circ C$ in a sealed tube, evolving labile halogen at $290^\circ C$. More stable than $KICl_2$.

REFERENCE:

- H. L. Wells. Z. anorg. allg. Chem. 1, 96 (1892).

Potassium Dibromiodide

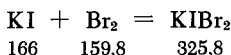

Since $KIBr_2$ crystallized from aqueous solutions always contains water of crystallization, it must be prepared in a dry process.

A given quantity of finely pulverized and dried KI is mixed with an equal quantity (by weight) of Br_2 and the mixture allowed to stand in a sealed flask for three days. When the reaction ends, the product is freed from excess Br_2 by placing the unstoppered flask in a desiccator over I_2 or NaOH .

PROPERTIES:

Shiny red crystals which melt at 58°C in a sealed tube, evolving labile halogen at 180°C .

REFERENCES:

H. W. Cremer and D. R. Duncan. *J. Chem. Soc. (London)* 1931, 1857.
W. N. Rae. *J. Chem. Soc. (London)* 107, 1290 (1915).

Cesium Dibromiodide



Finely pulverized and dried CsI (26 g.) is mixed with about 17 g. of Br_2 and allowed to stand in a closed flask for about three hours. The excess Br_2 is removed by allowing the open flask to stand in a desiccator over I_2 or NaOH .

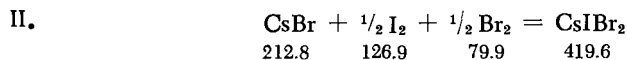

A solution of 21.3 g. of CsBr in 213 ml. of water is prepared and treated with 12.7 g. of I_2 and 8 g. of Br_2 . On cooling, CsIBr_2 crystallizes out.

PROPERTIES:

Glistening red crystals, stable in air. Melt at 243 to 248°C in a sealed tube, evolving labile halogen at 320°C . More stable than KIBr_2 .

REFERENCES:

I. H. W. Cremer and D. R. Duncan. *J. Chem. Soc. (London)* 1931, 1860.
W. N. Rae. *J. Chem. Soc. (London)* 1915, 1290.
II. H. L. Wells. *Z. anorg. allg. Chem.* 1, 94 (1892).

Potassium Tetrachloriodide



I. DRY PROCESS:

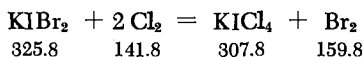

Dry KIBr_2 (see p. 296) is placed in a flask equipped with a glass stopper carrying an inlet tube (almost touching the bottom of the flask) and a gas outlet tube. Dry Cl_2 is passed through for some hours; this removes the byproduct Br_2 as soon as formed. The yield of KICl_4 is quantitative. Within a few minutes after the chlorine is introduced, KICl_2 is formed. Reaction with further quantities of Cl_2 to produce KICl_4 requires several hours.

A dry preparation process from KI and Cl_2 is described by W. N. Rae, J. Chem. Soc. (London) 1915, 1290.

The formation of a pure product in solution is questionable because of the following equilibrium:

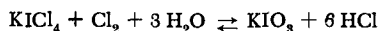

so the compound is better prepared in a dry process.

The formation of iodate can be sharply suppressed by adding hydrochloric acid and avoiding an excess of chlorine.

II. SOLUTION PROCESS:

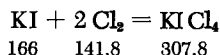

Concentrated KI solution is acidified with hydrochloric acid and chlorine is introduced. The weight increase should be controlled so as to avoid an excess of chlorine. The yield is 70%.

For preparation of KICl_4 from KCl solution, I_2 and Cl_2 , see the references under III.

PROPERTIES:

Golden yellow needles; m.p. 116°C in a sealed tube; in air, evolve ICl_2 even at room temperature.

REFERENCES:

- I. H. W. Cremer and D. R. Duncan. J. Chem. Soc. (London) 1931, 1864.
- II. E. Filhol. J. Pharm. Chim. 29, 457 (1939).
- III. H. L. Wells and H. L. Wheeler. Z. anorg. allg. Chem. 2, 257 (1892).
M. Gutiérrez de Celis and E. Moles. An. Soc. Españ. Física Quim. 30, 542 (1932).

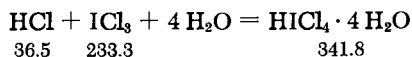
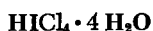
Tetrachloroiodic Acid

A solution of 20 g. of ICl_3 in the stoichiometric quantity (6.9 ml.) of concentrated hydrochloric acid (d 1.19) is prepared and cooled to 0°C , whereupon $\text{HICl}_4 \cdot 4\text{H}_2\text{O}$ precipitates out.

PROPERTIES:

Orange-yellow, deliquescent plates which vigorously attack the skin, paper, etc. Not very stable; decomposed by solvents.

REFERENCE:

H. W. Cremer and D. R. Duncan. J. Chem. Soc. (London), 1931, 1865.

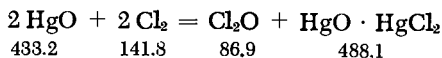
Dichlorine Oxide

I. According to Bodenstein and Kistiakowsky, chlorine dried with concentrated H_2SO_4 is passed over HgO loosely packed in a U tube (300-350 mm. long, 12 mm. in diameter). Shallow layers of HgO should be alternated with small glass-wool plugs. In order to maintain a uniform temperature between 18 and 20°C , the U tube is placed vertically in a water bath. The product is passed through a P_2O_5 tube and is then frozen in a vessel cooled with liquid nitrogen.

To obtain the best possible yield, the dry chlorine is mixed with dry air in a ratio of 1:2 to 1:3. The air flow rate can be measured in a bubble counter and, if necessary, can be regulated by intermediate stopcocks. To avoid any pressure in the apparatus, the Cl_2 -air mixture is aspirated over the HgO at about 400-600 mm. The system is protected against moisture by a trap cooled with liquid nitrogen or by a drying tube. About 15 g. of crude Cl_2O is formed in 4-6 hours.

The Cl_2O is purified by distillation at atmospheric pressure. The first few milliliters are discarded. The remaining Cl_2O is of satisfactory purity except for the last few milliliters.

The HgO used in the reaction is prepared as follows: yellow HgO is precipitated from $\text{Hg}(\text{NO}_3)_2$ solution with sodium hydroxide. It is then suction-filtered, washed, dried and heated to 200-250°C.

The only suitable stopcock lubricants are Kel-F or Teflon greases.

According to Wallace and Goodeve, the Cl_2O formed as described above may be purified by passing the crude condensate first over P_2O_5 and then over precipitated but not heated HgO to remove any traces of unreacted Cl_2 . It is then fractionated three times.

II. *Solutions of Cl_2O in inert solvents.* As an example, 3.55 g. of Cl_2 is dissolved in 100 ml. of carbon tetrachloride, 12 g. (i.e., somewhat more than the theoretical 10.82 g.) of carefully dried HgO is added, and the slurry shaken for 1.5 hours in the dark. Then the $\text{HgO} \cdot \text{HgCl}_2$ and the excess HgO are filtered off through a fritted glass filter. The solution must be kept in the dark and, if possible, refrigerated with Dry Ice.

PROPERTIES:

Yellowish-brown gas, with strong, unpleasant odor; deep brown liquid. M.p. -116°C , b.p. 3.8°C .

Dissolves easily in water (forming HClO). At 0°C , 1 vol. H_2O dissolves more than 100 vol. Cl_2O .

The material can only be stored as a liquid or as a solid below -80°C . Explodes on mixing with organic materials.

REFERENCES:

- I. M. Bodenstein and G. B. Kistiakowsky. *Z. phys. Chem.* 116, 372 (1925).
A. Klemenc. *Die Behandlung und Reindarstellung von Gasen* [Treatment and Purification of Gases], 2nd ed., Vienna, 1948.
R. Schwarz and H. Striebich. *Z. anorg. allg. Chem.* 224, 30 (1935).
J. J. Wallace and C. F. Goodeve. *Trans. Faraday Soc.* 27, 649 (1931).
M. Schmeisser and F. Schmitz. Unpublished.
- II. E. A. Moelwyn-Hughes and C. N. Hinshelwood. *Proc. Roy. Soc. (London)* (A) 131, 179 (1931).
G. H. Cady in: T. Moeller. *Inorg. Syntheses*, Vol. V, New York-London, 1957, p. 158.

Chlorine Dioxide

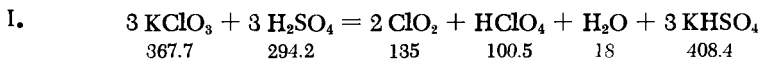

A mixture of 20 g. of KClO_3 and 60 g. of washed and calcined sand is prepared in a 200-ml. round-bottom flask equipped with a special dropping funnel and a gas outlet tube (Fig. 147). The mixture is cooled with ice, and ice-cold, concentrated H_2SO_4 is slowly added by drops. The ClO_2 product, somewhat contaminated with Cl_2 , is aspirated over P_2O_5 and condensed by cooling with liquid nitrogen. It is purified by fractionation. Only the middle fraction is used.

The above method carries a danger of explosion, and ClO_2 may be prepared more safely if it is diluted by simultaneously formed CO_2 as in method II:

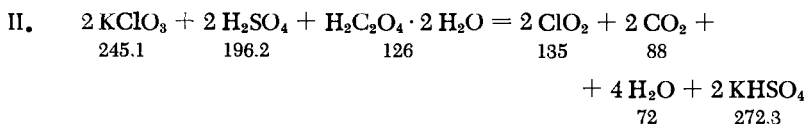

A mixture of 122 g. of KClO_3 (about one mole), 100 g. of C.P. oxalic acid ($\text{H}_2\text{C}_2\text{O}_4 \cdot 2\text{H}_2\text{O}$, 0.8 mole), and a chilled solution of 108 g. (57 ml., 1.1 moles) of concentrated H_2SO_4 (d. 1.84) in 400 ml. of H_2O is prepared in a 1.5-liter ground joint flask. The mixture is slowly heated on a steam bath, and the smooth stream of ClO_2 and CO_2 is passed through a P_2O_5 drying tube and into a receiver cooled to -78°C . When a sufficient quantity of liquid ClO_2 has collected, a stopcock located between the P_2O_5 tube and the receiver is closed. The receiver is then cooled to -110°C and the remaining CO_2 removed by suction. Final purification is by fractionation, retaining only the middle fraction.

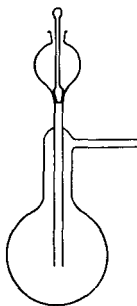

Fig. 147. Dropping funnel apparatus for preparation of chloride dioxide.

III. Other preparative methods have been reported: from solid NaClO_2 and Cl_2 (Hutchinson and Derby) and from AgClO_3 and Cl_2 (King and Partington).

PROPERTIES:

Formula weight 67.46. Yellow gas. M. p. -59°C , b. p. 9.9°C . The liquid is reddish brown, the solid is yellowish red. At -80°C the vapor pressure is almost zero. d (gas) 3.09, d (liq.) ~ 1.5 .

IV. Solutions of ClO_2 in H_2O may be prepared by passing the $\text{ClO}_2\text{-CO}_2$ mixture produced in method II through water cooled by an ice-salt mixture. The ClO_2 is twenty times more soluble than CO_2 . One vol. of H_2O at 4°C dissolves 20 vol. of ClO_2 (5.7%).

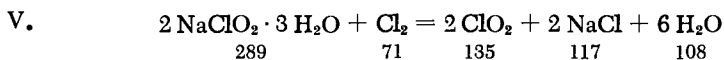

Aqueous solutions of ClO_2 may also be prepared by passing a Cl_2 -air mixture (maximum 5% Cl_2) through two fritted glass wash bottles containing a 10% solution of sodium chlorite. Mixing of the two gases in the proper proportions is carried out by passing the Cl_2 and air separately through two wash bottles filled with H_2O , adjusting the ratio by bubble counting, and combining the streams. The ClO_2 formed in the chlorite solution is swept in a stream of air into two consecutive fritted glass wash bottles filled with water. These are cooled in an ice-salt mixture to aid the absorption. When the NaClO_2 solution in the first wash bottle changes suddenly from brown to a weak yellowish-green, it is exhausted and should be refilled. It is then used as the second wash bottle in the series.

General Precautions for Handling ClO_2 . Gaseous or liquid ClO_2 often explodes for no obvious reason. Stopcock grease on stopcocks and ground glass joints should be avoided; concentrated H_2SO_4 or fluorocarbon grease should be used as lubricants. It is best to confine the dropping funnels to the type shown in Fig. 147.

Direct exposure to daylight should be avoided in preparation and storage of ClO_2 because ClO_2 decomposes easily on illumination. It is best to work in a darkened hood and to paint the outside of the containers black.

Chlorine dioxide attacks Hg; the Hg surface may be protected by a layer of H_2SO_4 for a short time. Containers filled with solid or liquid ClO_2 which are to be sealed off should be well cooled previous to sealing so that no gaseous ClO_2 is present.

As a safety measure in case of breakage, coating the reaction vessels with an adherent plastic film is recommended.

The maximum safe partial pressure of ClO_2 is 36 mm. (see Reference, under III).

REFERENCES:

- I. M. Bodenstein, P. Harteck and E. Padelt. Z. anorg. allg. Chem. 147, 233 (1925).

- II. W. Bray. *Z. phys. Chem.* **54**, 569 (1906).
 H. J. Schumacher and G. Stieger. *Z. phys. Chem (B)* **7**, 364 (1930).
 E. Schmidt, E. Geisler, P. Arndt and F. Ihlow. *Ber. dtsh. chem. Ges.* **56**, 25 (1923).
- III. W. S. Hutchinson and R. J. Derby. *Ind. Eng. Chem.* **37**, 813 (1945).
 R. J. Derby and W. S. Hutchinson in; T. Moeller, *Inorg. Syntheses*, Vol. IV, New York-London, 1953, p. 154.
 F. E. King and J. R. Partington. *J. Chem. Soc. (London)* **1926**, 925.

Dichlorine Hexoxide



Formation of Cl_2O_6 by illumination of ClO_2 and also by illumination of a mixture of Cl_2 and ozone has been proven by Bodenstern, Harteck and Padelt.

According to Schumacher and Stieger, ClO_2 and ozone react as follows:

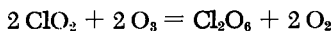

Chlorine dioxide (see p. 301, method II), diluted with CO_2 , is introduced into vessel *a* (Fig. 148), cooled to -10°C . Simultaneously, a stream of ozone-oxygen mixture containing about 8% ozone is added as shown. The flow rate of the ClO_2 - CO_2 mixture is 1-2 liters/hour; that of the O_3 - O_2 mixture is 2-4 liters/hour. After a few minutes, brown oily drops begin to form on the walls of *a*; this is a solution of ClO_2 in Cl_2O_6 .

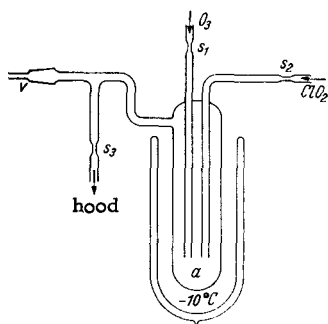

Fig. 148. Preparation of dichlorine hexoxide.

The stopcocks must be greased with fluorocarbon lubricant because of the corrosive effect of Cl_2O_6 , unless one prefers to use the glass valves suggested by Bodenstern.

When a sufficient quantity of the material has accumulated in *a*, the apparatus is sealed off at s_1 , s_2 and s_3 , and vessel *a* is evacuated through *v*, while being immersed first in finely crushed Dry Ice and then in an ice-water bath. About 2/3 of the liquid is allowed to boil off to assure that all the ClO_2 has been removed from the Cl_2O_6 . If the Cl_2O_6 is to be used immediately in a reaction, it is distilled from *a* into a reaction vessel attached at *v*.

In the same way, but using break-seal valves, Goodeve and Richardson prepared Cl_2O_6 of an especially high degree of purity.

PROPERTIES:

Formula weight 166.9. Deep red liquid. M.p. 3.5°C , b.p. 203°C (calcd.); d (3°C) 2.02. Vapor pressure (0°C) 0.31 mm.

Gaseous Cl_2O_6 is largely dissociated to ClO_3 ; the latter, even at room temperature, dissociates to ClO_2 and O_2 or to Cl_2 and O_2 . Liquid Cl_2O_6 is considerably more stable. It is the least explosive of all the chlorine oxides; however, it does explode on contact with organic materials.

REFERENCES:

- M. Bodenstein, P. Harteck and E. Padelt. Z. anorg. allg. Chem. 147, 233 (1925).
 H. J. Schumacher and G. Stieger. Z. anorg. allg. Chem. 184, 272 (1929).
 C. F. Goodeve and F. D. Richardson. J. Chem. Soc. (London) 1937, 294.

Dichlorine Heptoxide

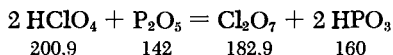

I. Receiver *a* in the apparatus shown in Fig. 149, which contains about 30 g. of loose P_2O_5 dispersed between Raschig rings, is cooled with liquid nitrogen for about 15 minutes before 4-5 ml. of 70% HClO_4 is added in drops from the dropping funnel. The tube of the funnel is bent so that it terminates in the vicinity of the cold wall of the receiver. In this way the heat of reaction is rapidly carried away and explosions are avoided. After completion of the addition of acid, the temperature of *a* is raised to -70°C , and after ten minutes to -25°C ; the reaction mixture is allowed to stand for two hours at this temperature. The viscous mass in *a* is finally allowed to stand at 0°C for a long time to complete the reaction.

After reevacuating, *a* is slowly heated on a water bath to 90°C . The fraction that distills below 40°C is discarded; beginning with a bath temperature of 40°C , colorless liquid droplets are obtained in the liquid-nitrogen-cooled receiver which is attached to drying tower *b* (filled with P_2O_5 dispersed between Raschig rings).

According to Goodeve and Powney, lower chlorine oxides may be decomposed by passing the product gas over CuO wire, freshly reduced to copper and placed in a copper tube. However, the formation of lower chlorine oxides can be avoided in advance, according to J. J. Manley [J. Chem. Soc. (London) 121, 331 (1922)], if before the reaction ozone is passed for 0.5 to 3 hours over the P_2O_5 to be used. The temperature should be 175–200°C; the treatment oxidizes the lower phosphorus oxides which are responsible for the formation of the lower chlorine oxides. Excess ozone is then displaced with O_2 .

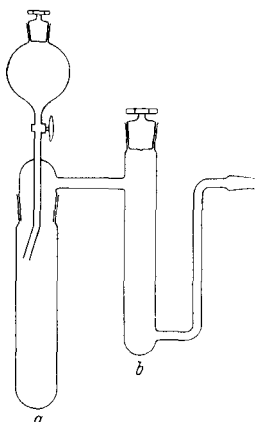

Fig. 149. Preparation of dichlorine heptoxide.

If the Cl_2O_7 product is not colorless, it is fractionated in vacuum.

II. According to Meyer and Kessler, Cl_2O_7 may be successfully prepared—although with a yield of only 10%—by mixing one part by weight of anhydrous $HClO_4$ (e.g., 20 to 30 g.) and 3 to 4 parts by weight of pure calcined kieselguhr with a mixture of one part by weight of P_2O_5 and one part by weight of kieselguhr. The reaction flask must be cooled.

The Cl_2O_7 is distilled off at 80–90°C (2 mm.) and collected in a receiver cooled to $-78^\circ C$. The relatively high temperature of 80–90°C is necessary because kieselguhr absorbs considerable quantities of Cl_2O_7 . For further purification, a fractionating column may be attached.

III. A solution of Cl_2O_7 in CCl_4 is prepared as follows: 50 g. of P_2O_5 is suspended in 120 ml. of CCl_4 in a 500-ml. round-bottom flask. The flask contents must be continually stirred and cooled to $0^\circ C$. Then 8.2 g. of a 70% aqueous solution of $HClO_4$ is slowly added, drop by drop. Next, most of the CCl_4 is distilled off at $0^\circ C$, using an aspirator, and the mixture is then heated for a while to 70–75°C at atmospheric pressure. It is then distilled at $80^\circ C$, whereupon a mixture of CCl_4 and Cl_2O_7 goes over and is trapped in a receiver cooled to $-20^\circ C$.

When this yellowish mixture is heated for a short time to $80^\circ C$, Cl_2 and lower chlorine oxides volatilize and a colorless, approximately 7–8% solution of Cl_2O_7 remains. If a more concentrated solution is required, P_2O_5 is added to this mixture and the entire operation is repeated. A 20–25% solution may be obtained by repeating the procedure several times.

General Precautions for Handling Cl_2O_7 . Dichlorine heptoxide is more stable than the other chlorine oxides; it will, however, explode on impact or in contact with a flame. The greatest source

of danger in the preparation is not so much in handling the Cl_2O_7 product, but rather in the manipulation of the anhydrous HClO_4 used as a starting material. The use of rubber and organic materials must be avoided; stopcocks must be lubricated with H_2SO_4 or H_3PO_4 , or still better, with fluorinated hydrocarbon grease.

The synthesis must be planned so that only about 2 ml. of Cl_2O_7 is produced at a time.

PROPERTIES:

Formula weight 182.91. Colorless, very volatile oil. M.p. -91.5°C , b.p. 82°C ; d (0°C) 1.86. Vapor pressure (0°C) 23.7 mm.

REFERENCES:

- I. A. Michael and W. T. Conn. Amer. Chem J. 23, 445 (1900).
M. Schmeisser and D. Lützow. Unpublished.
C. F. Goodeve and J. Powney. J. Chem. Soc. (London) 1932, 2078.
- II. F. Meyer and H. G. Kessler. Ber. dtsch. chem. Ges. 54, 566 (1921).

Bromine Oxides

BROMINE DIOXIDE, BrO_2

I. The preparation is carried out by ozonizing bromine in Freon 11 (CFCI_3) at a low temperature. A solution of 1 g. of bromine in about 50 ml. of Freon 11 is prepared in a refrigerated container. This solution is saturated with ozone at -50°C for about 30 minutes. The ozone dissolves in the Freon, giving a blue color. The ozone flow is then shut off and the solution is left for about 30 minutes in the refrigerant until a slight precipitate forms. A stream of ozone (precooled to -78°C in a glass spiral) is then passed through the solution until the bromine has reacted completely (about 5-7 hours). Moisture is kept out by means of a P_2O_5 tube. The BrO_2 forms as a solid precipitate with the color of egg yolk. The ozone and Freon are distilled off in a high vacuum. The product is very pure.

II. According to Schwarz and Schmeisser, BrO_2 may be prepared from Br_2 vapor and O_2 in a glow discharge, using a discharge tube cooled by liquid nitrogen, which also serves as a gas trap (compare Part I, p. 91, Fig. 74).

PROPERTIES:

Solid with the color of egg yolk. No definite melting point; decomposes to Br_2 and O_2 at temperatures in the region of 0°C . May explode if heated too rapidly.

REFERENCES:

- I. M. Schmeisser and K. Joerger. *Angew. Chem.* 71, 523 (1959).
 II. R. Schwarz and M. Schmeisser. *Ber. dtsh. chem. Ges.* 70, 1163 (1937).
 R. Schwarz and H. Wiele. *J. prakt. Chem., N. S.* 152, 157 (1939).

DIBROMINE MONOXIDE, Br₂O

Slow heating of BrO₂ (which is stable at low temperatures) in high vacuum from -40°C upward causes it to decompose to Br₂, O₂, a white, unidentified oxide, and Br₂O, which can be frozen out as a brown substance.

By separating the byproducts at -55°C, the Br₂O may be obtained in the pure state.

REFERENCE:

- R. Schwarz and H. Wiele. *J. prakt. Chem., N. S.* 152, 157 (1939).

Diiodine Pentoxide

Diiodine pentoxide may be prepared by thermal dehydration of iodic acid.

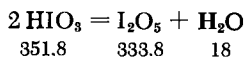

Finely powdered HIO₃ is heated in a stream of dry air for several hours at a temperature of 240-250°C in a glass tube which is placed in an aluminum block or an electric furnace in order to maintain the temperature as precisely as possible.

In order to obtain a colorless or, at most, a pale pink product, which corresponds as far as possible to the composition I₂O₅, the following precautions should be kept in mind:

According to Lamb, Bray and Geldard, the HIO₃ produced from I₂ and HClO₃ (see HIO₃, method III) is more suitable for producing colorless I₂O₅ than the HIO₃ produced from I₂ and HNO₃ or from I₂, H₂O₂ and HNO₃.

Special attention should be given to the careful purification and drying of the air stream. According to Moles, H₂SO₄ should be avoided. The air should be purified by passage through alkaline KMnO₄ solution and over solid KOH, Na wire and P₂O₅.

Decomposition of iodic acid begins at 70°C in accordance with the equation $3\text{HIO}_3 = \text{HIO}_3 \cdot \text{I}_2\text{O}_5 + \text{H}_2\text{O}$. This reaction is favored if some $\text{HIO}_3 \cdot \text{I}_2\text{O}_5$ or I_2O_5 is added in advance. Otherwise, rapid heating will cause the HIO_3 to melt at 110°C, which results in transition to $\text{HIO}_3 \cdot \text{I}_2\text{O}_5$. At 200°C, $\text{HIO}_3 \cdot \text{I}_2\text{O}_5$ begins to evolve water and decomposes to I_2O_5 . At 240-250°C this reaction proceeds rapidly and thoroughly. Keeping the above facts in mind, Baxter recommends that HIO_3 be first heated for an adequate time at 100°C (first dehydration stage) and then for one hour at 240°C (second dehydration stage).

The final product from the method of Lamb, Bray and Geldard still contains 0.2% moisture; Baxter's product, 0.002%.

PROPERTIES:

White, hygroscopic crystals. Decomposition to I_2 and O_2 begins at 275°C and is rapid at 350°C. d (25°C) 4.8.

PROPERTIES:

- E. Moles and A. Perez-Vitoria. Z. phys. Chem. (A) 156 a (Bodenstein, Anniversary Volume 583, (1931).
- G. P. Baxter and G. St. Tilley. Z. anorg. allg. Chem. 61, 293 (1909).
- G. P. Baxter. Z. anorg. allg. Chem. 70, 41 (1911).
- A. B. Lamb, W. C. Bray and W. J. Geldard. J. Amer. Chem. Soc. 42, 1644 (1920).

Hypochlorous Acid

HClO

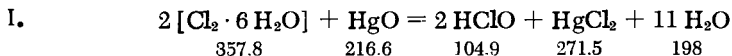

Chlorine hydrate (e.g., 300 g.) is shaken in a wide-mouth bottle for 15 minutes with 3/4 of its weight (e.g., 225 g.) of HgO (prepared from HgCl_2 by precipitation with NaOH and dried at 300°C). The semifluid mass is then vacuum distilled; distilling off 1/3 of the mixture and collecting the distillate in a receiver cooled to -20°C yields a greenish-yellow, 25% solution of HClO . This solution may be stored for some time at low temperature; it decomposes immediately, however, at 0°C.



A solution of Cl_2O in CCl_4 , cooled to 0°C , is mixed with water (0°C) in a separating funnel (the stopcock of which must under no circumstances be coated with stopcock grease) and shaken vigorously for three minutes. The CCl_4 layer is removed; the aqueous solution contains HClO which is free of Cl_2 .

PROPERTIES:

Can be stored only in aqueous solution and is in equilibrium with the anhydride Cl_2O . The latter can be extracted from the solution, using CCl_4 , for example.

REFERENCES:

- I. S. Goldschmidt. Ber. dtsh. chem. Ges. 52, 753 (1919).
- II. G. H. Cady in: T. Moeller, Inorg. Syntheses, Vol. V, New York-Toronto-London, 1957, p. 160.

Sodium Hypochlorite

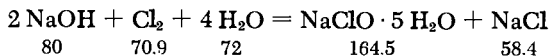
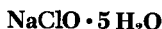

Chlorine is led through a glass tube, widened at the end like a funnel, into an ice-cold solution of 50 g. of NaOH in 50 ml. of H_2O contained in a brown, 350-ml., wide-neck flask. The mixture soon becomes a slurry and it must be repeatedly shaken in order to cause further Cl_2 to be absorbed. The progress of the reaction is periodically checked by determining the weight. After about three hours, the weight increase is 35 g.; this is about 80% of the quantity of chlorine (43.7 g.) needed for complete saturation. The reaction is now interrupted and the NaCl which has precipitated out is filtered off on a glass frit funnel cooled with an ice-salt bath. The filtrate must likewise be cooled with a freezing bath, since disproportionation to chloride and chlorate occurs on warming. The filtrate is then placed in a cold bath at -40°C , in which it solidifies completely within half an hour. After slowly raising the temperature to -5°C , the crystals of $\text{NaClO} \cdot 5\text{H}_2\text{O}$ are filtered through a fritted glass filter, externally cooled with an ice-salt bath.

PROPERTIES:

Colorless crystals, melting at 18°C in their own water of crystallization. This melt decomposes easily. By dehydration in

vacuum (over concentrated H_2SO_4) at the lowest possible temperature, largely anhydrous NaClO may be obtained; however, it tends to decompose explosively. Decomposed by the CO_2 of the air. Solubility (0°C) 29.3 g. of $\text{NaClO} \cdot 5\text{H}_2\text{O}$ /100 g. H_2O .

REFERENCES:

A. Sanfourche and L. Gardent. Bull. Soc. Chim. France [4] 35, 1089 (1924).

Private communication of I. G. Farbenindustrie A. -G., Werk Rheinfelden.

Sodium Hypobromite

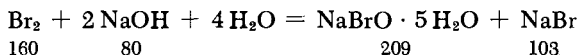
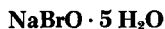

A 40% sodium hydroxide solution (438 g., 306 ml.) is stirred and cooled to -3°C in a wide-neck, round-bottom flask closed with a three-hole rubber stopper (for a stirrer, dropping funnel and thermometer). Bromine (314 g., 100 ml., 90% of the quantity, theoretically needed for 175 g. of NaOH) is slowly added (1-2 drops per second) with constant stirring. The temperature of the reaction mixture is held between -8 and -3°C . Insufficient cooling results in the formation of NaBrO_3 ; cooling below -8°C should be avoided to prevent slow solidification of the flask contents.

During the addition of bromine, $\text{NaBr} \cdot 2\text{H}_2\text{O}$ separates out. After completion of the addition of the bromine, the mixture is allowed to stand for one hour at -8°C ; it is then filtered from the easily filterable $\text{NaBr} \cdot 2\text{H}_2\text{O}$ (about 180 g.) through a glass frit filter, the filtrate being collected in a suction flask cooled to -5°C .

The orange filtrate, with a content of about 60 g. of NaBrO per 100 ml., is supersaturated with $\text{NaBrO} \cdot 5\text{H}_2\text{O}$. In order to induce crystallization, it must be seeded with some crystals prepared as follows: a few milliliters of NaBrO solution in a test tube are cooled to -50°C while the walls are scratched with a thermometer, whereupon the entire tube contents solidify. By briefly warming the test tube with the hand, the thermometer with the adhering crystal mass can be removed. A small part of these crystals is used to seed a few milliliters of NaBrO solution in a test tube at -5°C . The pure $\text{NaBrO} \cdot 5\text{H}_2\text{O}$ which crystallizes out is now used to seed the remaining solution, maintained at -3°C . The abundant precipitate of $\text{NaBrO} \cdot 5\text{H}_2\text{O}$ obtained is in the form of well-formed needles. The yield from 100 ml. of the filtrate is about 55 g. of crude moist material containing about 78% $\text{NaBrO} \cdot 5\text{H}_2\text{O}$, 14%

$\text{NaBr} \cdot 2\text{H}_2\text{O}$, and 3% NaBrO_3 . The remainder is water. The crystal mass is separated on a glass frit and immediately recrystallized from 2% NaOH in order to obtain the maximum possible separation of NaBr and NaBrO_3 . About 30 ml. of base (at 20°C) is used for each 100 g. of crude material. The solution is then filtered and the filtrate cooled with an ice-salt mixture. The crystals that are filtered off (when damp, about 18 g. from 100 g. of crude crystals) are dried for 1-2 hours on a precooled (0°C) porous clay plate placed in a desiccator (0°C) filled with silica gel.

PROPERTIES:

Formula weight (NaBrO) 118.91. Yellow crystals, readily soluble in H_2O . May be stored at -20°C in a closed weighing vessel for a few days with only slight loss of NaBrO ; decomposition, with formation of NaBr and NaBrO_3 , begins immediately at 0°C and is complete within two days.

Analysis after drying for one or two hours on clay at 0°C ; about 92% $\text{NaBrO} \cdot 5\text{H}_2\text{O}$, 2% $\text{NaBr} \cdot 2\text{H}_2\text{O}$, 1% NaBrO_3 , 5% moisture.

REFERENCE:

R. Scholder and K. Krauss. *Z. anorg. allg. Chem.* **268**, 279 (1952).

Potassium Hypobromite

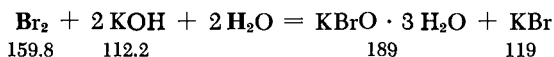
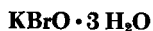

This may be prepared from concentrated potassium hydroxide solution and Br_2 in a manner similar to that previously described for $\text{NaBrO} \cdot 5\text{H}_2\text{O}$. One mixes 465 g. (300 ml.) of 53% potassium hydroxide solution (245 g. of KOH and 220 g. of H_2O) and 314 g. (100 ml.) of Br_2 . This solution (about 250 ml.) is filtered from precipitated KBr (at this point the solution contains about 70 g. of KBrO per 100 ml.), and 125 g. of KOH and 157 g. (50 ml.) of Br_2 are added with stirring. The temperature is -5 to -10°C . The precipitated KBr is again filtered. The filtrate, which contains about 83 g. of KBrO per 100 ml., is cooled to -40°C and seeded with several crystals obtained by cooling a portion of the filtrate to -80°C . After a short time a substantial yield of long, yellow needles of $\text{KBrO} \cdot 3\text{H}_2\text{O}$ is obtained. The precipitate is filtered off and dried on a precooled clay plate for about 20 hours in a desiccator at -20°C .

REFERENCE:

R. Scholder and K. Krauss. *Z. anorg. allg. Chem.* **268**, 279 (1952).

Sodium Chlorite

One method of preparation, based on the reaction of ClO_2 with alkalis in the presence of H_2O_2 , is given below. Other methods use, for example, SO_2 or $\text{Mn}(\text{OH})_2$ instead of H_2O_2 , or start with ClO_2 and metals or amalgams.

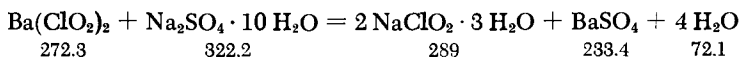
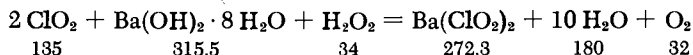

Chlorine dioxide is synthesized from 24.5 g. of KClO_3 , 20 g. of oxalic acid, 21.6 g. (11.8 ml.) of concentrated H_2SO_4 (d 1.84) and 80 ml. of water, according to method II given in the section Chlorine Dioxide, and is introduced into an Erlenmeyer flask containing 200 ml. of ice-cold H_2O . The yellow-orange ClO_2 solution is shaken until it is decolorized with an excess of solid $\text{Ba}(\text{OH})_2 \cdot 8\text{H}_2\text{O}$ (i.e., with more than the theoretical quantity of 31.6 g., because of carbonate impurities present) and with 12 g. of 30% H_2O_2 . The BaCO_3 precipitate is filtered off. The filtrate is boiled and treated with solid Na_2SO_4 until the excess barium ion precipitates as BaSO_4 . The BaSO_4 is filtered and the solution evaporated on a steam bath until crystals of $\text{NaClO}_2 \cdot 3\text{H}_2\text{O}$ separate. The yield is about 15.6 g. (54%).

PROPERTIES:

Formula weight 144.51. White, flaky crystals; may be dehydrated over KOH in a desiccator. Anhydrous NaClO_2 explodes on impact.

REFERENCES:

F. Foerster and P. Dolch. Z. Elektrochem. 23, 138 (1917).
G. R. Levi. Atti Accad. Naz. Lincei [5] 31, 214 (1922); Gazz. Chim. Ital. 52, 418 (1922).

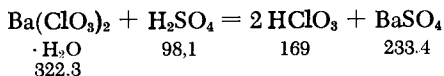
Chloric Acid

A solution of 322 g. of barium chlorate in 500 ml. of boiling water is prepared. A hot mixture of 98 g. of concentrated H_2SO_4

(53.3 ml., d 1.84) and 53.3 ml. of H_2O is then slowly added with stirring. Care should be taken to assure that a small excess of $Ba(ClO_3)_2$ rather than of H_2SO_4 exists at the end of the addition. The $BaSO_4$ precipitate is allowed to settle for at least one hour. Then $2/3$ of the clear solution is poured off and the remainder filtered through a Büchner funnel. The filtrate is combined with the decanted solution, yielding about 660 ml. of a 22% solution of $HClO_3$ (d 1.11). Evaporation of the solution in a vacuum desiccator over concentrated H_2SO_4 produces concentrations up to 40%. (The 40% solution corresponds to the composition $HClO_3 \cdot 7H_2O$; d 1.28.)

Alternate Method: This method uses cation-exchange resins to exchange metal ions (e.g., Na^+) for H^+ .

According to Samuelson, this procedure is possible with ClO_3^- (e.g., in the form of $NaClO_3$) while in the case of ClO^- , BrO_3^- , IO_3^- , for example, the acid is reduced by the resin. Preparation of an approximately 10% $HClO_3$ solution, which then can be concentrated, may be carried out in accordance with a method described by Klement.

PROPERTIES:

Formula weight 84.46. Forms colorless solutions which may be stored in glass-stoppered bottles. Pure solutions undergo slight decomposition at $95^\circ C$; impure solutions decompose at as low as $40^\circ C$.

REFERENCES:

- A. B. Lamb, W. C. Bray and W. I. Geldard. *J. Amer. Chem. Soc.* 42, 1743 (1920).
 O. Samuelson. *IVA*, 17, 5 (1946).
 R. Klement. *Z. anorg. allg. Chem.* 260, 271 (1949).

Ammonium Chlorate

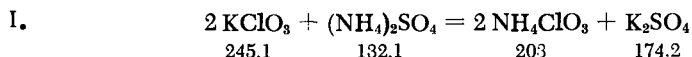

The directions will be found below under $Ba(ClO_3)_2 \cdot H_2O$, since NH_4ClO_3 is an intermediate product in that preparation. If NH_4ClO_3 is to be isolated as such, the NH_4ClO_3 solution, freed of alcohol, is evaporated before the addition of $Ba(OH)_2$ for crystallization (as described in the other procedure). Since the substance

thus prepared may still contain SO_4^{2-} , it may be preferable to follow the entire procedure for $\text{Ba}(\text{ClO}_3)_2$ and then prepare the desired NH_4ClO_3 from the easily purified $\text{Ba}(\text{ClO}_3)_2$ in accordance with method III.

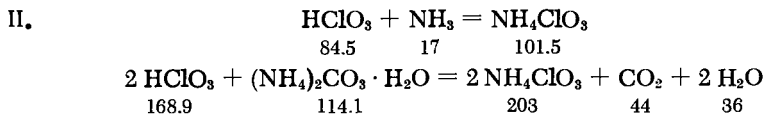

A chloric acid solution is reacted with the stoichiometric quantity of NH_3 or $(\text{NH}_4)_2\text{CO}_3 \cdot \text{H}_2\text{O}$ and the solution placed in a desiccator over H_2SO_4 to crystallize.

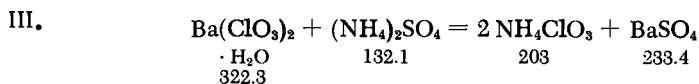

Concentrated solutions of the reagents are brought together in stoichiometric ratios; after filtering off the BaSO_4 , the solution is evaporated.

PROPERTIES:

Formula weight 101.5. Small, needle-shaped crystals, which are unstable and therefore cannot be stored for any length of time. Caution should be exercised in handling NH_4ClO_3 since the substance occasionally explodes without apparent cause. It is definitely explosive at temperatures above 100°C . If the material is spread in a thin layer in the open, it may be manipulated without danger. It readily dissolves in water.

REFERENCES:

- I. Vanino. Handb. d. präp. Chem., Inorganic Section, 2nd ed., Stuttgart, 1925, p. 459.
- II. I. W. Retgers. Z. phys. Chem. 5, 448 (1890).
- III. Ullmann. Enzyklopädie der techn. Chemie, 2nd ed., Berlin-Vienna, 1928/32, Vol. 3, p. 297.

Barium Chlorate

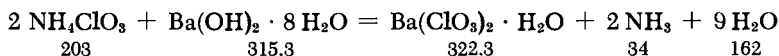
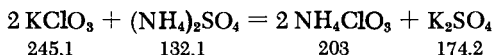

A mixture of 122.6 g. of KClO_3 , 70 g. of $(\text{NH}_4)_2\text{SO}_4$ and 350 ml. of hot water is evaporated in a porcelain dish with constant stirring

until a thin slurry forms. After cooling, a fourfold quantity of 80% ethyl alcohol is added, resulting in the separation of insoluble K_2SO_4 from the NH_4ClO_3 . The K_2SO_4 residue is filtered and washed several times with alcohol. The filtrate is freed of alcohol by distillation. The NH_4ClO_3 residue (caution: NH_4ClO_3 has a tendency to explode!) is reacted in a porcelain dish on a steam bath with a sufficient quantity of hot concentrated $Ba(OH)_2 \cdot 8H_2O$ solution [at least 160 g. of $Ba(OH)_2 \cdot 8H_2O$ dissolved in about 160 ml. of hot water] so that the ammonia odor disappears completely and the solution finally gives a definite alkaline reaction. It is then evaporated to dryness. The residue is dissolved in a fivefold quantity of H_2O , and CO_2 is bubbled through the solution until the precipitation of $BaCO_3$ is completed. The $BaCO_3$ is filtered off and the solution evaporated to crystallization.

PROPERTIES:

Colorless, columnar prisms. M.p. (anhydrous salt) $414^\circ C$; d 3.18. Solubility ($0^\circ C$): 27.4 g.; ($100^\circ C$) 111.2 g./100 g. of H_2O .

REFERENCE:

Vanino. Handb. d. präp. Chem., Inorganic Section, 2nd ed., Stuttgart, 1925, p. 297.

Bromic Acid

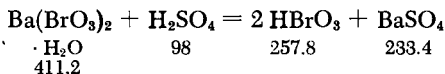

Finely powdered $Ba(BrO_3)_2 \cdot H_2O$ (100 g.) is mixed with a cold solution of 15 ml. (27.6 g., i. e., 10% excess) of concentrated H_2SO_4 (d 1.84) in 275 ml. of H_2O . The reaction flask is placed in an ice-salt bath during the addition. Following the addition, the flask is left for several hours in the bath and frequently shaken. The flask contents are then diluted by at least a factor of two; the exact amount of $Ba(OH)_2 \cdot 8H_2O$ solution necessary to remove the excess H_2SO_4 is added [7.75 g. of $Ba(OH)_2 \cdot 8H_2O$ is needed for this], which causes further $BaSO_4$ precipitation. The mixture is allowed to settle and the clear $HBrO_3$ solution is then decanted; the $BaSO_4$ is filtered off and the filtrate combined with the decanted solution. The acid may be concentrated to 50% by vacuum evaporation at as low a temperature as possible.

PROPERTIES:

Formula weight 128.92. Colorless solution.

REFERENCE:

O. Burchard. Z. phys. Chem. 2, 814 (1888).

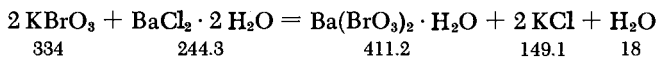
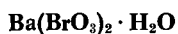
Barium Bromate

A solution of 334 g. of KBrO_3 in 700 ml. of boiling water is prepared; a hot solution of 244 g. of $\text{BaCl}_2 \cdot 2\text{H}_2\text{O}$ in 400 ml. of H_2O is added. The mixture is cooled and the supernatant liquid is decanted. The residue is washed several times with 100-ml. portions of cold water and then suction-filtered. The yield is almost quantitative. For further purification the product may be recrystallized once or several times from boiling H_2O .

PROPERTIES:

White crystals. M.p. 260°C (dec.); d. 3.99. Solubility (10°C): 0.44 g.; (100°C) 5.39 g./100 g. of H_2O .

REFERENCE:

D. W. Pearce and R. G. Russel in: W. C. Fernelius, Inorg. Syntheses, Vol. II, New York-London, 1946, p. 20.

Iodic Acid

Iodic acid may be prepared by oxidation of I_2 with HNO_3 or with a mixture of HNO_3 and H_2O_2 , but even with a clear reaction mixture a pure white product seldom results (I and II). Colorless HIO_3 is formed from I_2 and HClO_3 , which in turn is prepared from $\text{Ba}(\text{ClO}_3)_2$ and H_2SO_4 (III). The procedure based on the reaction of $\text{Ba}(\text{IO}_3)_2$ [prepared from $\text{Ba}(\text{ClO}_3)_2$ and I_2] with H_2SO_4 is unsatisfactory, since it does not give a H_2SO_4 -free product.

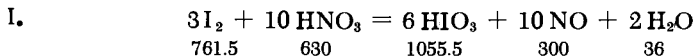

Twice sublimed I_2 (100 g.), in an Erlenmeyer flask covered by a water-cooled round-bottom flask, is heated to $70\text{--}80^\circ\text{C}$ with pure fuming nitric acid until the solution becomes light yellow. The mixture is then evaporated to dryness on a steam bath, treated several times with some H_2O , and again evaporated to dryness. The residue is dissolved in concentrated nitric acid on a steam bath and the clear, colorless solution rapidly cooled in an ice bath. The crystals are suction-filtered on fritted glass and dried for several days in a desiccator over solid KOH . Large crystals may be obtained if a seeded HIO_3 solution in 20% HNO_3 is allowed to evaporate at room temperature or over CaCl_2 in a vacuum desiccator. The crystals are then filtered and washed with the minimum amount of water.

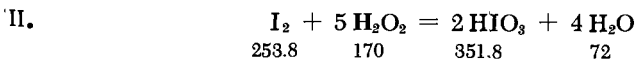

Finely divided I_2 (50 g.), which is best prepared by oxidation of an iodide solution with Cl_2 , H_2O_2 or some other oxidizing agent, is placed in a 750-ml. flask and heated on a water bath (70°C) with 50 ml. of concentrated nitric acid, 25 ml. of 30% H_2O_2 (H_2O_2 free from organic stabilizers should be used) and 50 ml. of H_2O . A water-cooled, round-bottom flask is used to cover the reaction vessel. After repeated shaking, the reaction suddenly begins and the color fades. The addition of H_2O_2 is continued until all the I_2 present has reacted. The solution is then evaporated to dryness; the residue is redissolved in a minimum of water and treated as indicated below.

If organic material is present in the H_2O_2 , the residue after evaporation is dark. If this is the case, the residue is heated two hours at $140\text{--}150^\circ\text{C}$ and then for a while at $170\text{--}180^\circ\text{C}$; after cooling, the HIO_3 is extracted with a very small quantity of hot water, and this solution is filtered and crystallized.

Because of the great solubility of HIO_3 , large losses occur during crystallization; therefore, aqueous HIO_3 solutions may be mixed with an equal volume of concentrated nitric acid and evaporated to one third their volume. This usually results in separation of HIO_3 even from hot solutions.

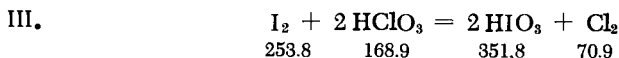

Iodine (100 g.) is mixed with a volume of HClO_3 solution containing 68.55 g. (3% excess) of HClO_3 . The reaction flask is

equipped with an air inlet tube and an outlet tube to carry the Cl_2 into an absorption solution (e.g., NaOH). The reaction mixture is heated and, after the reaction begins, air is slowly passed through. The reaction is completed in about 20 minutes. The solution is then cooled and filtered to remove impurities [e.g., small quantities of $\text{Ba}(\text{IO}_3)_2$ from traces of barium ion in the HClO_3]. The filtrate is evaporated to dryness in a dish, using vigorous agitation. It may also be recrystallized as described in methods I or II.

PROPERTIES:

Formula weight 175.93. Colorless crystals. M.p. 110°C (conversion to HI_3O_8); d (0°C) 4.629. Water is partially eliminated even at 70°C , especially if even a trace of $\text{HIO}_3 \cdot \text{I}_2\text{O}_5$ is present. Above 220°C , complete dehydration to I_2O_5 occurs.

Solubility (0°C): 286 g. HIO_3 /100 ml. H_2O ; (25°C): 141 g. HIO_3 /100 g. HNO_3 [d (25°C) 1.4].

Very readily soluble in water, but is not hygroscopic. Since HIO_3 is light sensitive, it is best to carry out the reaction in complete darkness to obtain a colorless product.

REFERENCES:

- I. E. Moles and A. Perez-Vitoria. *Z. phys. Chem. (A)* 156a (Bodenstein Anniversary Volume), 583 (1931).
G. P. Baxter and G. St. Tilley. *Z. anorg. allg. Chem.* 61, 295 (1909).
- II. W. C. Bray and A. L. Caulkins. *J. Amer. Chem. Soc.* 53, 44 (1931).
M. Guichard. *Bull. Soc. Chim. France* [4] 5, 723 (1909).
- III. A. B. Lamb, W. C. Bray and W. J. Geldard. *J. Amer. Chem. Soc.* 42, 1643 (1920).

Perchloric Acid

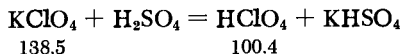

I. A fractionating flask equipped with a ground glass stopper is connected, either directly or through a ground glass joint, to a 75-cm.-long condenser, which is in turn connected to a receiver cooled to -40°C (or, if sufficient, only to -20°C). The latter is connected, through a tube filled with soda-lime, to an aspirator.

The fractionating flask is charged with 25 g. of KClO_4 and 100 g. of H_2SO_4 (d 1.84) and the contents slowly heated on a bath at a pressure of 10-20 mm. The flask should be immersed in the heating bath only to the liquid level so that the vapor space will not become overheated. The reaction begins at about 90°C ; further heating is carried out at such a rate that a temperature of 160°C is reached in about one hour. The reaction mixture is allowed to remain for about two hours at this temperature. By this time all the KClO_4 has dissolved; the HClO_4 is then distilled.

The crude, yellowish distillate is immediately redistilled at $35\text{-}40^\circ\text{C}$ and 10-20 mm. on a steam bath. It is advisable to use a ground joint boiling capillary in the second distillation, but this is not necessary for the first. Small quantities of ClO_2 , which color the acid yellow, may be quickly and completely removed by passing dry air through the solution. Dark-yellow acid cannot be decolorized either by the passage of air or by vacuum distillation. II. Anhydrous acid may be prepared from commercial 70% aqueous perchloric acid solution by mixing it with a fivefold quantity of H_2SO_4 (95.6%) and distilling at 90 to 160°C at 20-30 mm. If the pressure falls below this value, loss of HClO_4 by volatilization occurs. Use the apparatus described in I.

General Precautions for Handling Anhydrous HClO_4 . All connections in the apparatus, if not fused with a torch, must be made with ground glass joints lubricated with H_3PO_4 , H_2SO_4 or HClO_4 . Rubber stoppers and rubber tubing must not be used. If solid $\text{HClO}_4 \cdot \text{H}_2\text{O}$ should form in the receiver during distillation—perhaps because of too rapid heating—the distillation should be stopped immediately. If carefully cleaned glassware and pure starting materials are used, the preparation of HClO_4 is not at all dangerous. The free acid should not come in contact with wood, because this may result in an explosion. Explosions always occur when organic material comes into contact with the anhydrous acid.

The skin must be thoroughly protected from the anhydrous acid (painful, lingering wounds!).

The acid may be stored for a long time below 0°C without decomposition. Acid residues should never be disposed of by pouring into a waste bucket, but should be either discarded (in portions) in the open or diluted with a large amount of cold water. Caution is advisable even under these conditions!

PROPERTIES:

Water-clear, mobile liquid which fumes slightly in the air at room temperature. d_4^{22} 1.764. M.p. -112°C , b.p. 130°C (760 mm. extrapolated; the acid decomposes at about 90°C), 14°C (15 mm.), 16°C (18 mm.), 17.3°C (20 mm.), 39°C (56 mm.).

REFERENCES:

- I. D. Vorländer and R. von Schilling. *Liebigs Ann. Chem.* 310, 369 (1900).
 A. Michael and W. T. Conn. *Amer. Chem. J.* 23, 444 (1900).
 K. van Emster. *Z. anorg. allg. Chem.* 52, 270 (1907).
 H. J. van Wyk. *Z. anorg. allg. Chem.* 48, 4 (1906).
- II. E. Linde. *Z. Elektrochem.* 30, 255 (1924).
 K. Berger. Thesis, Leipzig, 1928; H. Distler, unpublished experiments, Freiburg i. Br.

Alkaline Earth Perchlorates

HYDROUS PERCHLORATE

The hydrous perchlorates $Mg(ClO_4)_2 \cdot 6H_2O$, $Ca(ClO_4)_2 \cdot 4H_2O$, $Sr(ClO_4)_2 \cdot 4H_2O$ and $Ba(ClO_4)_2 \cdot 3H_2O$ are prepared from the corresponding oxides, carbonates, chlorides or nitrates by dissolving these in slightly more than the theoretical quantity of 70% $HClO_4$ (in the case of oxides, a slight excess of the oxide is used and later filtered off) and concentrating the solution by evaporation. The crystals that separate out are centrifuged and dried in a desiccator.

ANHYDROUS PERCHLORATES

These are prepared by heating the hydrous perchlorates to $250^\circ C$ in a vacuum drying oven, at pressures ranging from 1 to 10 mm.

Another method is based on the reaction of solid alkaline earth carbonates with solid NH_4ClO_4 (the reactants are ground together in a ball mill) at $250^\circ C$ and at pressures ranging from 1 to 10 mm., according to the following equation:



REFERENCES:

- G. F. Smith and E. G. Koch. *Z. anorg. allg. Chem.* 223, 18 (1935).
 G. F. Smith and V. R. Hardy. *Z. anorg. allg. Chem.* 223, 1 (1935).

Nitrosyl Perchlorate

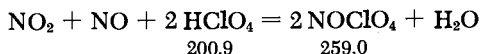

An approximately 30% aqueous solution of $HClO_4$ (100 ml.) is evaporated in a porcelain dish until dense white fumes are evolved

(142°C). The remaining liquid (a mixture of HClO_4 mono- and dihydrates) is poured into a round-bottom flask. A mixture of NO and NO_2 is then introduced (prepared by dropwise addition of 68% nitric acid to NaNO_2).

From 11 to 16 g. of colorless, thin platelets of $\text{NOClO}_4 \cdot \text{aq.}$ form; these are filtered on a Büchner funnel. The yield can be raised almost to theoretical (53 g.) if the filtrate is evaporated and the NO-NO_2 mixture is reintroduced.

After filtration, the crystals are placed in a desiccator and dried for several hours on porous clay over P_2O_5 . It is also a good idea to prefill the desiccator with NO-NO_2 mixture.

After drying the material in a vacuum over P_2O_5 for several days, the water is completely removed and anhydrous NOClO_4 is obtained.

PROPERTIES:

Formula weight (NOClO_4) 129.5. White crystals which decompose with water to form NO , NO_2 , HNO_3 and HClO_4 .

REFERENCES:

- K. A. Hofmann and A. v. Zedtwitz. Ber. dtsh. chem. Ges. 42, 2031 (1909).
 K. Kruse, B. Drobny, G. Huck and H. Möller. Z. anorg. allg. Chem. 259, 154 (1949).

Nitryl Perchlorate

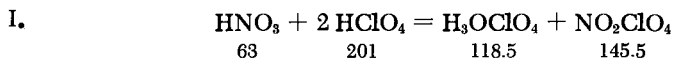

According to Goddard, Hughes and Ingold, NO_2ClO_4 is prepared by reacting anhydrous HNO_3 with anhydrous HClO_4 in a high-vacuum apparatus. The simultaneously formed H_3OClO_4 is reconverted to HNO_3 and HClO_4 by the addition of N_2O_5 . The reaction is carried out in a nitromethane solution, from which the NO_2ClO_4 is obtained by crystallization.

II. According to Gordon and Spinks, dry air (0°C) is passed through a Siemens ozonizer at a rate of 12 liters/hour. The products (ozone and nitrogen-containing gases) are mixed with a much slower stream of chlorine dioxide in an adjacent vessel. White crystals, with the composition NO_2ClO_4 , are deposited on the walls of the reaction vessel.

Goddard, Hughes and Ingold call this compound nitronium perchlorate; Gordon and Spinks call it nitroxyl perchlorate.

PROPERTIES:

At 120°C, the compound decomposes rapidly, but not at an explosive rate.

For other information on the reaction between HNO₃ and HClO₄, see A. Hantzsch, Ber. dtsch. chem. Ges. 58, 958 (1925).

REFERENCES:

- I. D. R. Goddard, E. D. Hughes and C. K. Ingold. Nature (London) 158, 480 (1946).
- II. W. E. Gordon and J. W. T. Spinks. Canad. J. Res. (B) 18, 358 (1940); Chem. Zentr. 1942 (I), 3180.

Periodic Acid



Since H₅IO₆ is decomposed catalytically by Pt, electrolysis on Pt cannot be used. The procedure described below, using barium periodate and HNO₃, makes use of the fact that Ba(NO₃)₂ is insoluble in concentrated HNO₃, while H₅IO₆ is soluble.

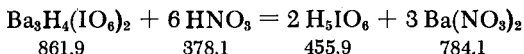

A 100-g. quantity of Ba₃H₄(IO₆)₂ is moistened with 75 ml. of H₂O and treated with 200 ml. of colorless nitric acid (d 1.42). The agitated mixture is heated to 60-70°C for an hour and is then cooled to 30-40°C. The precipitated Ba(NO₃)₂ is filtered off on a glass frit. The residue is washed free of periodate by stirring with concentrated nitric acid. The combined filtrate is evaporated at 60-70°C in aspirator vacuum [if more Ba(NO₃)₂ separates, it is filtered and the evaporation continued] until H₅IO₆ begins to precipitate. After cooling, glistening crystals of periodic acid are formed. Since the solution tends to become supersaturated, it is often necessary to wait a long time. The crystals are filtered off and dried in a vacuum at 50°C. A second crystal crop may be obtained from the mother liquor by evaporation. The yield is almost quantitative (46 g. vs. the theoretical 52.9 g.).

No rubber tubes or rubber stoppers may be used in this procedure because they would reduce HNO₃ to lower oxides, which in turn would reduce H₅IO₆ to HIO₃.

PROPERTIES:

Formula weight 227.96. Colorless, hygroscopic crystals which decompose into H_2O , O_2 and I_2O_5 at the melting point (130°C).

REFERENCE:

H. H. Willard in: H. S. Booth, *Inorg. Syntheses*, Vol. I. New York-London, 1939, p. 172.

Sodium Periodates

The syntheses of $\text{Na}_3\text{H}_2\text{IO}_6$ and NaIO_4 use NaIO_3 as the starting material. The latter is either used as such, or in the form of a solution which may easily be prepared from elemental iodine and excess NaClO_3 in the following manner.

A solution of 125 g. of pure NaClO_3 in 500 ml. of H_2O is prepared at 45°C in a five-liter flask. The solution is acidified with 2 ml. of concentrated nitric acid. Iodine (100 g.) is then added and an inverted beaker placed over the mouth of the flask to avoid loss of iodine. The reaction mixture is then heated, with constant agitation, to $50\text{--}70^\circ\text{C}$. If the reaction becomes too violent, the flask is cooled by immersion in cold water. The end of the reaction (in about 15 minutes) may be recognized by the disappearance of the iodine color. This solution may be used for the preparation of Na periodate. For each 100 g. of I_2 , 76.9 g. of NaClO_3 is required, and 156.1 g. of NaIO_3 is produced.

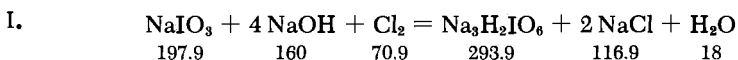
 $\text{Na}_3\text{H}_2\text{IO}_6$:

Solid NaOH (140 g.) and, if necessary, another 100 to 200 ml. of H_2O are added to a beaker containing the iodate solution prepared from 100 g. of I_2 as described above (alternately, 156.1 g. of NaIO_3 may be used). The mixture is vigorously boiled and Cl_2 is introduced as rapidly as possible through a glass tube at least 1 cm. in diameter. This also serves to agitate the reaction mixture continuously and vigorously. After about 10-15 minutes all the alkali is neutralized and no further Cl_2 is absorbed. The solution is then made slightly alkaline with NaOH in order to convert the small amount of the $\text{Na}_2\text{H}_3\text{IO}_6$ byproduct into the less soluble $\text{Na}_3\text{H}_2\text{IO}_6$. On cooling, the precipitate is filtered on a

Büchner funnel. The precipitate is washed with cold water and dried at 110°C. The yield is about 225 g. (about 97% of the theoretical yield of 231.8 g.).

Other preparative methods:

II. If cylinder chlorine is unavailable, NaIO_3 may be oxidized with $\text{K}_2\text{S}_2\text{O}_8$ [the use of $(\text{NH}_4)_2\text{S}_2\text{O}_8$ is not recommended because of poor yields]. Using this method, some sulfate contamination of the product must be expected.

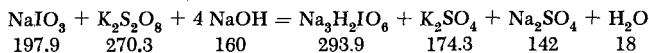

The NaIO_3 solution prepared as above from 100 g. of I_2 (or a solution of 156.1 g. of NaIO_3) is gradually reacted with 40 g. of NaOH ; it is then diluted with H_2O to a total volume of 1200 ml. and is then heated to boiling. The stoichiometric quantity (213 g.) of $\text{K}_2\text{S}_2\text{O}_8$ is then gradually added, followed by 170 g. of NaOH , added in portions. Continuous, vigorous stirring is necessary during the addition; a power agitator is preferable. Following the addition, the mixture is boiled for another 15 minutes, cooled to 40°C, and filtered through a fritted glass filter. A considerable amount of sulfate crystallizes on cooling below 40°C. The $\text{Na}_3\text{H}_2\text{IO}_6$ precipitate is washed several times with cold water.

III. The compound may also be prepared from NaI , Br_2 and NaOH :

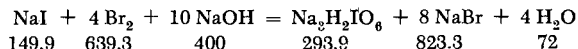

A solution of 50 g. of NaI and 264 g. of NaOH in two liters of H_2O is prepared in a four-liter breaker. The solution is heated to 80°C and, while mechanically stirred, is gradually reacted with 80 ml. of Br_2 (2 ml./minute). The bromine is added from a dropping funnel with its tube projecting below the surface of the liquid. During the addition the temperature is kept as close as possible to 80°C. A precipitate suddenly forms after 30-45 minutes. The drop by drop addition of Br_2 is continued. By a quick movement of the flask, the liquid is decanted from the precipitate and the remainder of the Br_2 is added to the liquid, which is then recombined with the residue. The $\text{Na}_3\text{H}_2\text{IO}_6$ is now filtered through a fritted glass filter, washed four times with 25 ml. of H_2O and air dried. The yield is about 85 g. (87%).

NaIO_4 :

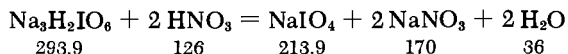

A 100-g. quantity of $\text{Na}_3\text{H}_2\text{IO}_6$ is treated with 200 ml. of H_2O and 55 ml. of concentrated nitric acid (20% excess). If the liquid

is not clear, it is filtered through fritted glass. The filtrate is evaporated until crystals form. It is then cooled to 20°C (cooling to a lower temperature causes $\text{NaIO}_4 \cdot 3\text{H}_2\text{O}$ to crystallize out) and the precipitate is filtered off, washed with cold H_2O and dried at 110°C. The yield is about 61 g. (84%). The periodate still contained in the solution may be recovered as the rather insoluble KIO_4 (about 11 g.) by precipitation with KNO_3 .

PROPERTIES:

White crystals. NaIO_4 : d 3.865.

REFERENCES:

- I and II. M. Guichard. Bull. Soc. Chim. France [4] 5, 724 (1909).
 H. H. Willard in: H. S. Booth, Inorg. Syntheses, Vol. I, New York-London, 1939, p. 168.
 A. E. Hill. J. Amer. Chem. Soc. 50, 2678 (1928).
 E. Müller and W. Jakob. Z. anorg. allg. Chem. 82, 308 (1913).
- III. J. Lange and R. R. Paris. J. Pharm. Chim. 21, 403 (1935).
 P. M. Bernays in: W. C. Fernelius, Inorg. Syntheses, Vol. II, New York-London, 1946, p. 212.

Potassium Periodate

KIO_4

The preparation is analogous to that of sodium periodate: I_2 is converted to KIO_3 by means of KClO_3 and the KIO_3 is oxidized with Cl_2 .

The KIO_3 solution obtained from 100 g. of I_2 and 135 g. of KClO_3 (or a solution of 168.6 g. of KIO_3) is treated with 195 g. of pure KOH (correspondingly more KOH if hydrous), and chlorine is passed through as previously described. The $\text{K}_4\text{I}_2\text{O}_9$ remains dissolved in this alkaline solution and KIO_4 may be precipitated by making the solution neutral or weakly acidic. The yield is almost quantitative (about 178 g.).

PROPERTIES:

White crystals. d 3.618. Solubility (13°C): 0.66 g. KIO_4 /100 ml. H_2O .

REFERENCES:

- A. E. Hill. J. Amer. Chem. Soc. 50, 2678 (1928).
 H. H. Willard in: H. S. Booth, Inorg. Syntheses, Vol. I, New York-London, 1939, p. 171.

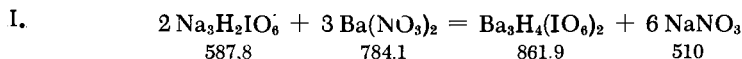
Barium Periodate

The $\text{Na}_3\text{H}_2\text{IO}_6$ (about 225 g.) obtained from 100 g. of I_2 , following the directions for Na periodate, is dissolved in one liter of H_2O and the solution, to which 10 ml. of concentrated nitric acid has been added, is heated to boiling. It is then treated with a hot aqueous solution of 425 g. of $\text{Ba}(\text{NO}_3)_2$. The mixture is boiled for 1.5 to 2 hours with vigorous stirring, then neutralized with $\text{Ba}(\text{OH})_2$ and left to cool. The barium periodate that crystallizes out is repeatedly washed with hot water and the supernatant liquor decanted. It is finally filtered on a Büchner funnel. The yield is about 330 g.; however, the product still contains some NaNO_3 . II. By starting with KIO_4 , the product may be prepared according to the following equation:

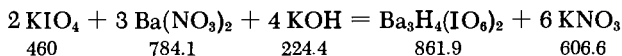

The procedure is identical to that given above. However, if 100 g. of iodine or 181.2 g. of KIO_4 is used as the starting material, another 88.4 g. of KOH should be added before the introduction of $\text{Ba}(\text{NO}_3)_2$.

PROPERTIES:

Formula weight 861.9. White crystals.

REFERENCE:

H. H. Willard in: H. S. Booth, *Inorg. Syntheses*, Vol. I, New York-London, 1939, p. 171.

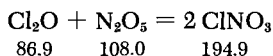
Chlorine Nitrate

A refrigerated pocket-shaped receiver is used to sublime an excess of N_2O_5 directly onto Cl_2O in high vacuum. The receiver

containing the Cl_2O (equivalent to 5 ml. of liquid) is placed in liquid nitrogen so that only the portion holding the Cl_2O is cooled, and the N_2O_5 thus deposits on the Cl_2O as a solid. After releasing the vacuum, the receiver is removed from the high-vacuum apparatus, closed off by means of a drying tube, and placed in a refrigerating bath at -78°C . While the bath is slowly warmed to between -20 and 0°C (over a period of 15 hours) the components react slowly with each other. The ClNO_3 thus formed is still contaminated with chlorine (an impurity of the Cl_2O) and excess N_2O_5 .

In order to eliminate the chlorine, which is difficult to separate, the reaction product is heated to 30°C on a water bath and refluxed for one hour. The upper half of the reaction vessel (serving as a condenser) is cooled by a ring-shaped cup filled with Dry Ice. In this procedure the chlorine is volatilized, while the excess N_2O_5 is decomposed to NO_2 and O_2 . The ClNO_3 is then distilled at -90°C in high vacuum, leaving behind the NO_2 .

PROPERTIES:

Colorless to pale yellow, mobile liquid. M.p. -107°C , b.p. 18°C (extrapolated).

REFERENCES:

- M. Schmeisser. W. Fink and K. Brändle, *Angew. Chem.* **69**, 780 (1957).
 W. Fink. Thesis, Univ. München, 1956.

Dipyridineiodine (I) Perchlorate



This compound is prepared in pyridine solution as follows:

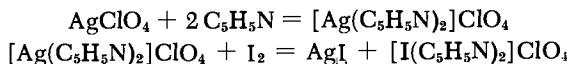

PROPERTIES:

Colorless, saltlike compound, comparatively stable in air.

REFERENCE:

- H. Carlsohn. Über eine neue Klasse von Verbindungen des positiven einwertigen Jods [A New Class of Univalent Iodine Compounds], Ph. D. Thesis, Leipzig, 1932.
 H. Carlsohn. German Patent 692,324 (1940).

The following compounds may be prepared in a similar way:

$[\text{CIPy}_x]\text{NO}_3$, $[\text{BrPy}_x]\text{NO}_3$, $[\text{BrPy}_x]\text{ClO}_4$, $[\text{IPy}_x]\text{NO}_3$, $[\text{IPy}_x]\text{ClO}_4$
(Py = $\text{C}_5\text{H}_5\text{N}$; x = 1 or 2).

H. Carlsohn, see above; H. Carlsohn. Ber. dtsch. chem. Ges. 68,
2209 (1935).

M. J. Uschakow and W. O. Tschistow. Ber. dtsch. chem. Ges. 68,
824 (1935).

$[\text{IPy}_2]\text{F}$, $[\text{BrPy}_2]\text{F}$.

H. Schmidt and H. Meinert. Angew. Chem. 71, 126 (1959).

Bromine (III) Nitrate

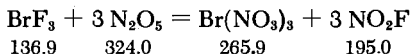

About 2 to 3 g. of BrF_3 is distilled into a quartz receiver (trap) in high vacuum. About 40 ml. of Freon 11 (CFCl_3) is condensed on the BrF_3 , which has deposited on the receiver walls. After releasing the vacuum, the solvent is warmed to about -10°C and the BrF_3 melted into the Freon 11 by hand warming. Part of the BF_3 dissolves, coloring the solution a pale yellow, and part of it forms a fine crystalline suspension. The BF_3 -Freon solution (or suspension) is frozen with liquid nitrogen and a slight excess of finely pulverized N_2O_5 is added through a tube attached to the receiver and protected against moisture. The liquid nitrogen is replaced by a bath kept at -30°C . This temperature is maintained for several hours, during which it is best to stir the mixture magnetically with a Teflon-coated stirrer. After this, the Freon and NO_2F are distilled off in high vacuum at -78°C . The NO_2F can be condensed in a receiver cooled with liquid nitrogen and the Freon in a receiver cooled to -140°C . The excess N_2O_5 is sublimed off at -40°C in high vacuum, the sublimation taking several hours. Pale yellow $\text{Br}(\text{NO}_3)_3$ remains in vessel.

PROPERTIES:

White to pale yellow solid; very sensitive to moisture; slowly decomposes above 0°C into Br_2 , O_2 and NO_2 . M.p. 48°C (dec.); soluble in Freon 11 and CCl_4 .

REFERENCE:

M. Schmeisser and L. Taglinger. Angew. Chem. 71, 523 (1959).

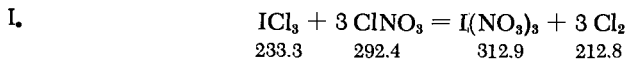
Iodine (III) Nitrate

An excess of ClNO_3 is condensed onto liquid-nitrogen-cooled ICl_3 in high vacuum. After releasing the vacuum the mixture is warmed to 0°C . The reaction starts at -30°C , with evolution of chlorine. The products are allowed to stand for a day at 0°C and the insoluble cake that forms during this time is periodically broken up with a glass rod.

At the end of the 24-hour period, the unreacted ClNO_3 and the traces of Cl_2 are distilled off in high vacuum at -70°C .

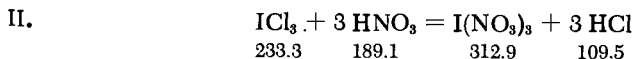

Iodine (III) nitrate may also be prepared by treating ICl_3 with anhydrous HNO_3 .

By long and vigorous mixing with a magnetic stirrer, ICl_3 is made into a slurry with Freon. An excess of a solution of anhydrous HNO_3 in Freon is then added drop by drop. A yellow, emulsion-like product is formed which can, to a large degree, be separated as flakes by cooling to -78°C . After settling and decanting the supernatant liquid, all volatile fractions are distilled off at -80°C in high vacuum. In order to remove the HNO_3 completely, the reaction mixture must remain in high vacuum overnight. During this time the temperature of the cold bath should rise to about -45°C . A yellow powder of $\text{I}(\text{NO}_3)_3$ remains in the flask.

PROPERTIES:

Yellow, brittle, hygroscopic solid; decomposes above 0°C with softening.

REFERENCES:

- I. M. Schmeisser and K. Brändle, *Angew. Chem.* **69**, 781 (1957).
- II. K. Brändle, Thesis, Aachen, 1958.

Iodine (III) Sulfate

Basic and neutral salts are among the compounds containing positive trivalent iodine. The colorless neutral salts are extremely

moisture sensitive, while the yellow basic compounds containing the iodosyl group IO^+ are relatively stable.

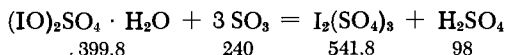

Sulfur trioxide (40-50 g.) is distilled onto 10 g. of $(\text{IO})_2\text{SO}_4 \cdot \text{H}_2\text{O}$ (see below) in a 50-cm.-long and 2-cm. diameter tube. The tube is then sealed off and heated in a paraffin-oil bath until the dark-yellow $(\text{IO})_2\text{SO}_4$ converts to a homogeneous, yellow crystalline mass. This requires about 140 hours at 100-120°C. The individual crystals may be readily seen in the tube as long as the latter is still warm and the excess SO_3 is still fluid. After cooling, the product is freed of SO_3 on a porous clay plate placed in a desiccator over H_2SO_4 . The bright yellow $\text{I}_2(\text{SO}_4)_3$ crystals are extremely hygroscopic and instantly develop a black color on contact with moist air (separation of I_2).

REFERENCE:

F. Fichter and H. Kappeler. Z. anorg. allg. Chem. 91, 134 (1915).

Iodine (III) Perchlorate

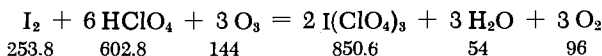

Iodine (4 g.) and anhydrous HClO_4 are precooled separately in ice-salt baths and then mixed. A stream of O_2 containing about 8% ozone is introduced while the mixture is kept at 0°C. The gas stream must be absolutely dry and the reaction flask carefully protected against moisture (be careful in handling HClO_4 : organic materials must not come in contact with it!). When the solution assumes a transparent greenish color, treatment with O_3 is interrupted and the reaction vessel is left to cool for half an hour in the ice-salt mixture. The greenish-yellow crystals are suction-filtered on a filter crucible protected from moisture by a CaCl_2 tube and are washed with some cold, anhydrous HClO_4 .

PROPERTIES:

Extraordinarily moisture sensitive; even at room temperature undergoes internal oxidation. Must therefore be kept cold.

REFERENCE:

F. Fichter and H. Kappeler. Z. anorg. allg. Chem. 91, 134 (1915).

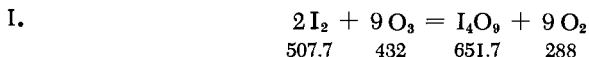
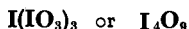
Iodine (III) iodate

A stream of O_2 containing about 8% ozone is passed through a U tube, the lower part of which contains iodine. The latter is heated until vaporized. The yellow I_4O_9 product is precipitated in an attached U tube filled with washed and dried glass wool. Contact with moisture must be very carefully avoided during the entire preparation.

A variation of this method, using CHCl_3 solution, was described by Fichter and Rohner.

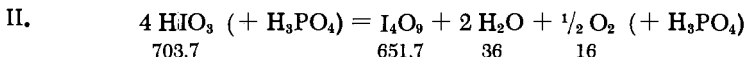

Concentrated phosphoric acid (d. 1.7, 20 ml.) is dehydrated by heating in a large Pt crucible. After cooling, 8 g. of powdered HIO_3 is added in portions with stirring and the mixture is carefully heated. Oxygen is evolved, and after about 15 minutes iodine vapor is given off, imparting a yellow color to the reactants. Heating is then interrupted and the crucible is cooled in a vacuum desiccator over H_2SO_4 . A white, pasty mass gradually forms. This is stirred with concentrated H_2SO_4 in order to work it up. When the precipitate has settled, the liquid is decanted, and the crystalline mass is dried on a porous plate in a vacuum desiccator.

Care should be taken to make sure that the substance does not come into contact with moist air during any of the above equations.

PROPERTIES:

Extremely hygroscopic, bright yellow solid; decomposes above 75°C with formation of I_2O_5 , I_2 and O_2 .

REFERENCES:

- R. K. Bahl and J. R. Partington. *J. Chem. Soc. (London)* 1935, 1258.
 M. Beger. *Chemiker-Ztg.* 33, 1232 (1909).
 F. Fichter and F. Rohner. *Ber. dtsh. chem. Ges.* 42, 4093 (1909).
 F. Fichter and H. Kappeler. *Z. anorg. allg. Chem.* 91, 142 (1915).

Oxiodine (III) Sulfate

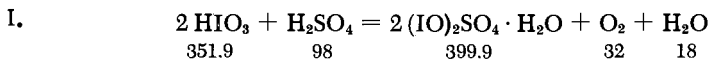

A stirred mixture of 6 g. of HIO_3 and 20 g. of concentrated H_2SO_4 is heated in a platinum dish. Oxygen evolves for a few moments and the mixture then assumes a yellowish-brown color. The heating of the mixture is then continued with a smaller flame until violet iodine fumes are observed. As soon as this occurs, heating is stopped and the product is cooled and left to stand for 5-6 days in a desiccator over concentrated H_2SO_4 . The liquid is then decanted from the crust of yellow crystals. The crystals are powdered, washed with a small quantity of the decanted liquid, suction-filtered through fritted glass, and dried on a porous plate in a vacuum desiccator over H_2SO_4 . The yield is 5 g.

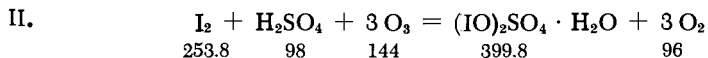

Iodine is dissolved in H_2SO_4 and ozone-containing O_3 is introduced, whereupon a yellow crystalline powder precipitates. It is treated as in method I.

PROPERTIES:

Yellow, hygroscopic powder, very slightly soluble in cold water. Hydrolysis yields I_2 , HIO_3 and H_2SO_4 .

According to Chrétien, the compound has the formula $(\text{IO})_2\text{SO}_4 \cdot \frac{1}{2} \text{H}_2\text{O}$; according to the more recent work of Bahl and Partington, the formula is $(\text{IO})_2\text{SO}_4 \cdot \text{H}_2\text{O}$. Bahl and Partington consider the product of the reaction of H_2SO_4 with HIO_3 as a mixture of $(\text{IO})_2\text{SO}_4 \cdot \text{H}_2\text{O}$ with $(\text{I}_2\text{O}_4) \cdot \text{H}_2\text{SO}_4$. However, when treated with a small amount of water, both compounds finally end up as I_2O_4 , since the HIO_3 formed in the hydrolysis yields I_2O_4 with $(\text{IO})_2\text{SO}_4 \cdot \text{H}_2\text{O}$. Also known as iodosyl sulfate.

REFERENCES:

- P. Chrétien. *Compt. Rend. Hebd. Séances Acad. Sci.* 123, 814 (1896).
 R. K. Bahl and J. R. Partington. *J. Chem. Soc. (London)* 1935, 1258.
 M. M. P. Muir. *J. Chem. Soc. (London)* 95, 656 (1909).
 M. Beger. *Chemiker-Ztg.* 33, 1232, (1909).

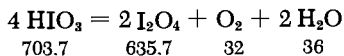
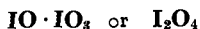
Diiodine Tetroxide

The tetroxide I_2O_4 is formed through the following intermediate reaction steps:

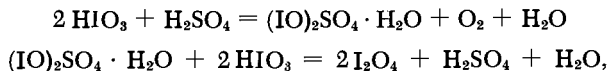

where the HIO_3 appearing on the left side of equation (2) is formed from $(\text{IO})_2\text{SO}_4 \cdot \text{H}_2\text{O}$.

A sample of $(\text{IO})_2\text{SO}_4 \cdot \text{H}_2\text{O}$ obtained from HIO_3 and H_2SO_4 (see above) is tested to see whether iodine separation takes place when it is shaken with a small amount of H_2O . If any I_2 separates, the substance is left in the desiccator for a little longer time; if the test shows no iodine, the entire quantity is quickly washed several times with small amounts of water in a fritted glass suction filter until the wash water is free of sulfate. Suction is applied after each washing. The material is then washed with small amounts of absolute alcohol and then with absolute ether. The substance is dried at room temperature on a clay dish placed in a desiccator over calcium oxide.

PROPERTIES:

Formula weight 317.84. Lemon yellow crystals, not hygroscopic. Very slightly soluble in water. Hydrolysis yields I_2 and HIO_3 . At 130°C , I_2O_4 decomposes to I_2O_5 and I_2 . d 4.2.

REFERENCES:

- R. K. Bahl and J. R. Partington. *J. Chem. Soc. (London)* 1935, 1258.
 M. M. P. Muir. *J. Chem. Soc. (London)* 95, 656 (1909).
 H. Kappeler. *Ber. dtsch. chem. Ges.* 44, 3496 (1911).

Oxygen, Ozone

P.W. SCHENK

Oxygen**O₂**

Since oxygen commercially available in steel cylinders can be used for most laboratory purposes after a suitable purification by washing with KMnO_4 , KOH and concentrated H_2SO_4 , only two laboratory procedures which yield a particularly pure gas are described. These are an electrolytic procedure and preparation from hydrogen peroxide.

I. ELECTROLYTIC OXYGEN

Of the numerous devices for the electrolytic preparation of O_2 , the system using pure nickel electrodes in a 30% KOH solution has proven to be particularly effective. Figure 150 shows the apparatus. It consists of a glass cylinder *A*, about 50 cm. high and 12 cm. in diameter, which is $\frac{2}{3}$ filled with 30% KOH . The cathode F_2 is a cylinder of Ni sheet suspended from three Ni wires (or it may consist of a helix made of 2-mm.-thick nickel wire). These three wires, in turn, are attached to a lid *D* made of Plexiglas or paraffin-treated hardwood. When Plexiglas is used, a conical hole may be drilled and the wire fastened to the lid by means of a matching ground glass stopper. The anode F_1 is placed in a glass bell *C*, which is attached to the bottom of tube *B* (diameter about 20 mm.). This tube is inserted through the lid, which is divided in two for this purpose. The halves are then reconnected with two sheet metal disks. The tube may be cemented to the lid with some picein. The anode itself (helical or sheet) is suspended from a Ni wire, which is cemented on top in a constriction *E*. A drop of white sealing wax is placed on the Ni wire and is pushed into the pre-heated constriction to form a seal. A cork washer is pushed from above against the sealing wax and the whole assembly is completely sealed with picein. Some glass wool is placed in the bulb of the side arm of tube *B* to catch the alkali spray. The bulb is connected to a tube filled with palladium asbestos (see section on Palladium

Metals for preparation), which is inserted into a small tubular electric furnace. At maximum line voltage, the furnace should reach about 350°C and at most 400°C . The furnace as well as the adjoining wash tower containing concentrated H_2SO_4 should be fixed to the glass cylinder with collars made of thick Al sheet. This apparatus works best when a uniform stream of very pure O_2 is needed.

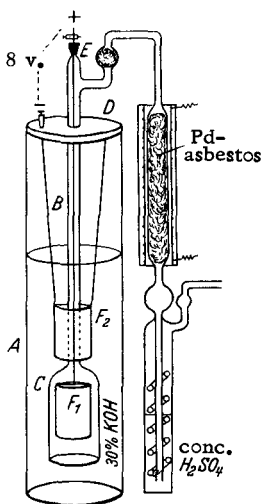

Fig. 150. Electrolytic preparation of oxygen or hydrogen.

If it is desired to know accurately the quantities of products and reactants, a second electrolyzer of the same type is connected in series with the first, and the O_2 evolved in the latter is collected in suitable glass burettes; i.e., the second apparatus is used as a coulometer. Also, any desired mixture with H_2 may be prepared by attaching under the bell a second auxiliary electrode connected in parallel with the cathode through a resistance. The palladium asbestos tube is then omitted, of course. By suitable choice of the resistance, any desired mixture of O_2 and H_2 can be

readily obtained. The auxiliary electrode is insulated by a glass U tube and is introduced into the bell from below.

Given the above dimensions, the apparatus can carry a current of about 5 amp. and furnish about one liter of oxygen per hour. With prolonged high current, the KOH of the electrolyte under the bell is occasionally depleted, resulting in pronounced corrosion of the anode. If the electrolyte becomes dark, it must be remixed, which can be easily done by allowing it to rise in the bell. *Caution: the poles may not be interchanged during the run!* An oxyhydrogen gas explosion, which is then unavoidable, can have very serious consequences because of the concentrated potassium hydroxide solution. For this reason, careful checking of the correct pole connections is indispensable, even during the check-out run.

Other modifications of electrolyzers, which yield very pure O_2 , have been described by Paneth and by Brauer. For the removal of the last traces of finely dispersed droplets from the electrolytically produced gas, see H. Lux.

II. OXYGEN BY CATALYTIC DECOMPOSITION OF HYDROGEN PEROXIDE

An excellent apparatus for the continuous production of fairly large quantities of very pure oxygen has been described by

Von Wartenberg. The half-liter calibrated flask *A* (Fig. 151) is closed off with a ground glass adapter *B* which is sealed with ordinary stopcock grease. This adapter is provided with a small glass winch *C*, from which a thin spiral of Ni sheet is suspended by a thin Pt wire. The 6 × 7 cm. Ni sheet is platinized in the same way as the electrodes of a conductivity cell and is ignited at dull red heat in a H_2 stream until it becomes light gray. Before the first run, it is allowed to react in 30% H_2O_2 for some time. This removes the loose Pt particles. Without this treatment, the decomposition of H_2O would continue even after the cessation of the run and it would also cause premature consumption of the H_2O_2 in the apparatus. The ground glass adapter also contains a few glass beads which retain the coarse liquid spray. A small pressure release valve containing Hg is connected at *F*. A six-cm. long platinized Cu wire screen is placed in the vertical tube attached past stopcock *H* in order to decompose the last traces of entrained hydrogen peroxide. A small rotameter is attached after the spiral wash flask containing concentrated H_2SO_4 . If the apparatus is to be operated for a long time, it is placed in a large container full of cold water to remove the heat developed during the run. After a short startup period, the gases dissolved in the liquid are displaced and very pure, H_2O_2 -free gas is produced. Commercial Perhydrol is used as starting material. With this material, the post evolution of O_2 is reduced in comparison with very pure Perhydrol. The desired rate of evolution is adjusted by increasing or decreasing the submerged surface of the Ni sheet, using the glass winch. The evolution of gas subsides only after the concentration of H_2O_2 drops to about 1.5%. Half a liter of 30% H_2O_2 yields about 45 liters of O_2 .

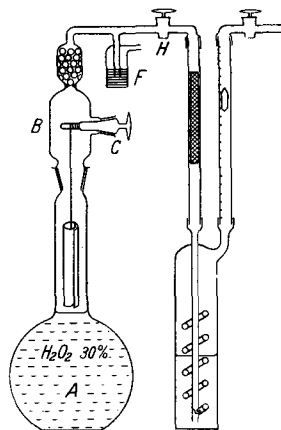

Fig. 151. Preparation of oxygen from hydrogen peroxide.

A Kipp generator can also be used for oxygen production. In this case, 3% H_2O_2 is used and the generator is charged with cubes made of MnO_2 and a binder.

According to Von Wartenberg, very small quantities of O_2 in inert gases can be detected most simply by means of a bead of white phosphorus. The rising vapor streaks of P_2O_5 indicate as little as 0.002 vol. % of O_2 , provided no gases which interfere with the oxidation (H_2S , SO_2 , halogens, N_2O_4 , C_2H_4 , etc.) are present [Z. Elektrochem. 36, 296 (1930)]. Von Wartenberg has also

described a simple apparatus for detecting O_2 in this manner [Chem. Ing. Techn. 26, 418 (1954)]. This apparatus may be used at a moment's notice.

PROPERTIES:

Formula weight 32.000. Colorless, odorless gas. Condenses to a bluish liquid. M.p. $-218.4^\circ C$, b.p. $-183.0^\circ C$. Crit. t. $-118.8^\circ C$. Crit. p. 49.7 atm. $d(-183^\circ C)$ 1.134. Weight per liter ($0^\circ C$, 760 mm.) 1.429 g.

REFERENCES:

- A. Klemenc. *Behandlung und Reindarstellung der Gase* [Treatment and Purification of Gases], 2nd Ed., Vienna, 1948.
H. von Wartenberg. *Z. anorg. allg. Chem.* 238, 297 (1938).
F. Paneth and R. Peters. *Z. phys. Chem.* 134, 365 (1928).
G. Brauer. *Z. anorg. Chem.* 255, 105 (1947).
V. I. Shemyshyn. *Khim. Shkola* No. 6, 57-58; abstract in *Chem. Zentr.* 54, 8172.
H. Lux. *Z. Elektrochem.* 48, 213 (1942).

Ozone

O_3

The ozonizer (Fig. 152), the principle of which was described by Siemens and Berthelot, is still the most suitable apparatus for the preparation of ozone. Four or six ozone tubes are connected in series and placed together in a glass cylinder filled with dilute $CuSO_4$ solution, which serves as the external electrode. The glass cylinder is about 30-40 cm. high. The ozone tubes are made of thin-wall soft glass, as uniform as possible. (The author has observed on occasion that Pyrex ozone tubes are not as effective as those of soft glass.) The inner tube has a diameter of 10 to 12 mm. and is fused concentrically to the outer tube. Three small glass beads on the inner tube keep it in the correct position. The positioning of the inner tube by indentations in the outer tube should be avoided. Such indentations decrease the distance between the inner and outer electrode. The consequent higher electric field density at these points results in breakdowns, leading to the destruction of the tube. The distance between the two tubes, i.e., the air gap between them, is about 1 mm. The individual tubes are fused together in pairs, the fusion point being at the bottom. Two pairs are always connected with each other at the top. In this way the O_2 stream enters the first ozone tube at the top and also leaves

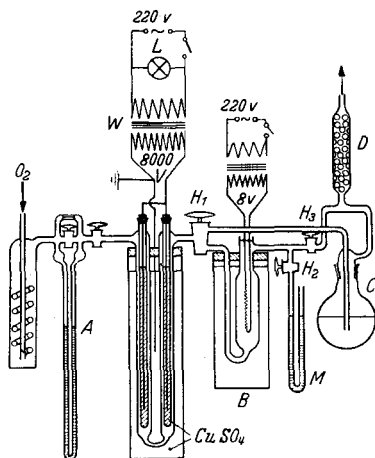
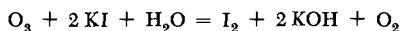

Fig. 152. Preparation of ozone (ozonizer). *A*) flow meter; *B*) analysis vessel with decomposition device for ozone; *C*) reaction vessel; *D*) tube with glass fragments and concentrated KOH solution for decomposing excess ozone.

the last tube at the top. The inner tubes are filled with CuSO_4 solution to a level somewhat higher than that in the cylinders. Thin wires of stainless steel 304 are used as electrical leads. Cork stoppers prevent evaporation of the solution. The individual wires are interconnected. The assembly is then connected to one pole of a small transformer *W* (so-called instrument transformer) which gives about 8000 volts at the secondary. The other pole of the transformer is grounded and is connected with the outer layer—the solution in the cylinder—by an immersed wire. When a 500-cycle alternating current is available, it should be used in preference to the 60-cycle supply since higher ozone concentrations are then obtained. Cylinder O_2 is used as the starting material. It is dried with concentrated H_2SO_4 and its flow controlled by means of flow meter *A*. If the presence of nitrogen oxides in the product is undesirable, electrolytic oxygen should be used as the raw material.

Determination of the ozone concentration, which is indispensable in many studies, can be carried out by passing the gas through a KI solution containing some solid boric acid. The iodine formed according to the equation:



is titrated with 0.1 N thiosulfate.

A much quicker procedure, which is sufficiently accurate for most purposes, is based on the volume increase associated with

the decomposition of ozone according to the equation

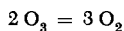

The setup for this determination is shown schematically in Fig. 152 (B).

The two-way stopcock H_1 allows the gas to flow either into analysis vessel B or into reaction vessel C . It is best to lubricate it with P_2O_5 , which is then converted to HPO_3 . To prevent too rapid liquefaction of the acid (which would produce a leak), ordinary stopcock grease is applied at the top and bottom rim of the stopcock. Stopcocks which close at the bottom are also very useful. All other stopcocks in the apparatus can be sealed with ordinary stopcock grease.

The analysis vessel B is cylindrical. It contains a thin spiral of Pt wire supported by two sealed-in current leads. The wire glows when the current from a small line transformer is passed through it. The analysis vessel is connected via stopcock H_2 with an H_2SO_4 manometer M . Stopcock H_3 is connected to the hood through tube D , which will be discussed later. The analysis vessel is placed in a water bath, which must be large enough to prevent temperature fluctuations during the measurement (the bath temperature may be checked with a thermometer).

The run proceeds as follows: The entire apparatus is first flushed with O_2 , stopcock H_1 is turned toward the analysis vessel, and voltage is applied to the ozonizer. (A red control lamp L connected in parallel with the primary of the transformer is highly recommended.) The flow rate is then adjusted by means of flow meter A and the apparatus is flushed for some time. Stopcock H_1 is then turned toward C , and H_3 is closed. After the zero position has been adjusted on the manometer, H_2 is also closed. The heating current for the Pt wire is turned on for a few minutes, and after the heating current has been turned off, H_2 is again opened. The reading is taken when the manometer level ceases to change. The heating process is repeated to make certain that all the ozone has been decomposed. The ozone content of the gas can be determined from the volume increase or pressure increase given by the previously cited equation. The manometer may be calibrated directly in percent ozone. The reliability of the analyzer is checked by the iodometric method. The ozone from the reaction vessel is vented into the hood through tube D , filled with glass fragments. The glass fragments are wetted with concentrated KOH solution, which completely decomposes the ozone.

This device is much safer than the frequently used heated tubes in which the solvent vapors from the reactor may accumulate. If mixed with oxygen, they occasionally ignite and give rise to violent explosions.

It is best to place the entire apparatus under a hood, with the transformers and the ozonizer proper being enclosed in separate boxes. At the very least the electrical components should be protected from contact with ozone.

The present apparatus will yield an oxygen stream with an ozone concentration of 10-12%, especially if 500-c.p.s. AC is used. Still higher concentrations can be obtained by cooling the ozonizer. To obtain a constant O₃ content in the gas, Greenwood suggests cooling of the inner tube of the ozonizer to a constant temperature.

PROPERTIES:

Colorless gas, blue in large volumes; characteristic unpleasant odor. Deep blue liquid. Extremely deleterious to the health, particularly in higher concentrations. B.p. -112.3°C , m.p. -251°C . Crit. t. -5°C . d (-183°C) 1.78. Decomposes rubber completely in a few minutes.

REFERENCES:

- F. R. Greenwood. *Ind. Eng. Chem., Anal. Ed.* 17, 446-447 (1945).
E. D. Boelter, G. L. Putnam and E. I. Cash (Iodometric Ozone Determination). *Analyt. Chem.* 22, 1533-1535.
E. Briner, V. Spreter and B. Kovaliv. *Bull. Soc. Chim. Belge* 62, 55-66 (1953).

Sulfur, Selenium, Tellurium

F. FEHÉR

Sulfur**S**

PURE SULFUR

Commercial sulfur can be purified to a considerable extent by repeated recrystallization from CS_2 .

A solution of 31.5 g. of S in 70 g. of CS_2 (C.P.) is prepared at room temperature. The solution is filtered and allowed to stand in ice for some time in a closed Erlenmeyer flask. The sulfur precipitate is filtered off and again crystallized several times in the same manner. At the end of this procedure, it is pressed between filter papers to remove all adhering solvent, and is finely pulverized and dried for a few hours at 90 to 100°C. The purified product is bright light-yellow, and retains only a very weak odor of CS_2 .

However, R. F. Bacon and R. Fanelli claim that the material thus purified, as well as all "chemically pure" commercial sulfurs, are still contaminated with organic substances (particularly liquid hydrocarbons) as well as H_2S , H_2S_x and adsorbed gases. The only method capable of removing these stubbornly adhering impurities proceeds as follows:

One kilogram of sulfur is melted in a one-liter, short-neck glass flask on an open flame. During this operation, the flask is covered with an inverted fritted glass crucible. The temperature is slowly increased until the mass begins to foam. As soon as gas evolution subsides, the liquid is heated to boiling, 5 g. of pure MgO is added, and the solution is boiled for 3-4 hours. It is then allowed to stand at 125°C overnight. During this time a black sludge settles to the bottom of the flask; this is rapidly separated, together with the MgO , by filtration through a layer of glass wool. The clear filtrate is treated four more times in the same manner, i.e., each time adding 1% MgO , boiling for 25-30 hours, and filtering through glass wool. After a total treatment time of 100-120 hours, the filtrate is

very slowly cooled. The freshly purified product is completely gas free. After standing for several days in air, it is again partially contaminated with gases but can be readily degassed by repeated melting and solidifying at a pressure of 1 mm.

The progress of purification can be followed by occasionally testing the condensate collected on the covering frit. Thus, 3 g. of this sulfur is slowly heated to boiling in a Pyrex test tube (95 × 10 mm.) (with particular care being taken that the region of the high-viscosity melt is not traversed too quickly), boiled for 2-3 minutes, and allowed to cool and solidify. No black spots should appear at the lower walls of the glass which are in contact with the flame. The test is good to less than 10⁻⁴% impurities. Before the test, the test tube must be rinsed with hot cleaning solution, and during the test it must be protected from dust.

Von Wartenberg describes a simple method for obtaining S with a C content of less than 10⁻⁶%. This procedure requires no special attention and takes place over a period of a few days. A quartz tube, electrically heated to 750°C, is suspended in recrystallized boiling S, thus causing CS₂ to form on it. When no further black material precipitates on the tube, the sulfur is distilled in vacuum.

According to Skjerven, H₂S may be removed from this carbon-free sulfur by treatment with SO₂.

PROPERTIES:

Very pure sulfur is light yellow and completely odorless; the melt tends to supercool; there is no residue after burning or distilling.

REFERENCES:

- Aegg, Handbuch der anorganischen Chemie, Vol. IV, 1, p. 142.
J. H. Walton and E. L. Whitford, J. Amer. Chem. Soc. 45, 601 (1923).
R. F. Bacon and R. Fanelli, Ind. Eng. Chem. 34, 1043 (1942).
H. von Wartenberg, Z. anorg. allg. Chem. 251, 166 (1943); 286, 243 (1956).
O. Skjerven, Z. anorg. allg. Chem. 291, 325 (1957).

PLASTIC SULFUR

Plastic sulfur is formed by rapid cooling of molten sulfur.

Pure S is heated to 250-350°C under a nitrogen blanket. A thin stream of the melt is then poured into a cylindrical vessel (at least 60 cm. high) which has a bottom inlet and top outlet for ice-water flow. Strands of plastic sulfur collect in the lower part while the flowers of sulfur forming on the water surface are continuously flushed away.

PROPERTIES:

Yellow, plastic, viscoelastic, amorphous mass. The strands can be stretched out to many times their initial length, which causes partial crystallization. Repeated stretching produces loss of elasticity. More detailed studies have been made by K. Sakurada and H. Erbring, *Kolloid-Z.* 72, 129 (1935). Insoluble in water, partially soluble in CS_2 .

REFERENCES:

- K. H. Meyer and Y. Go, *Helv. Chim. Acta* 17, 1081 (1934).
R. Houwink, *Elastizität, Plastizität und Struktur der Materie* [Elasticity, Plasticity and Structure of Materials], Dresden and Leipzig, 1938, p. 353.
H. Specker, *Kolloid-Z.* 125, 106 (1952).

COLLOIDAL SULFUR SOLUTION

I. A very stable monodispersed S sol is obtained by mixing acidified Na_2S and Na_2SO_3 solutions of the proper concentration, followed by peptization.

Solutions of 7.2 g. of C.P. $Na_2SO_3 \cdot 7H_2O$ and 6.4 g. of C.P. $Na_2S \cdot 9H_2O$, each in 50 ml. of distilled H_2O , are prepared separately. Then 1.5 ml. of the Na_2SO_3 solution is added with a pipette to the Na_2S solution. A mixture of 10 ml. of distilled H_2O and 2.7 g. of concentrated H_2SO_4 is then added in drops with constant stirring up to the point of incipient turbidity (a total of 8 ml. is needed). Then 5.5 g. of concentrated H_2SO_4 is added to the remaining Na_2SO_3 solution and the Na_2S solution is poured in with constant stirring. The mixture is allowed to stand for one hour in an Erlenmeyer flask covered with a watch glass. It is then filtered through a fluted funnel; the precipitate is washed from the outside of the filter with about 100 ml. of H_2O and is peptized on the filter with 300 ml. of distilled water. About 5 to 10 ml. of the yellowish-white colloidal sulfur solution running through the filter is poured into 300 ml. of distilled H_2O , forming a beautiful, reddish opalescent sulfur sol. After 24 hours the slight deposit of solid which may have formed is filtered off. The sol is then stable for weeks.

II. More highly concentrated S sols may be obtained by peptization of finely divided S precipitates in the presence of a protective colloid.

After the S precipitate on the fluted funnel, prepared according to method I, has been washed, it is mixed with sufficient 10% agar solution and dilute NaOH to reach a concentration of 0.6% agar and 0.4% NaOH in the sol product, relative to the weight of dry sulfur. The mixture is then decanted from the insoluble components. The resulting sol is very stable.

REFERENCES:

- I. A. Janek, *Kolloid-Z.* **64**, 31 (1933).
- II. British Pat. 411 241 (1934), IG. Farbenindustrie.

Hydrogen Sulfide

H₂S

The hydrogen sulfide gas prepared in the laboratory from FeS and dilute HCl is generally contaminated with acid vapors such as H₂, CO₂, AsH₃, N₂ and O₂. The HCl can be readily removed by scrubbing with distilled water. To remove AsH₃, Jacobsen recommends that the gas, predried with CaCl₂, be passed through a U tube containing dry iodine and glass wool. The As deposits as AsI₃ and the simultaneously formed HI is then scrubbed out with distilled water. After drying with P₂O₅, the permanent gases H₂, N₂ and O₂ can be removed by condensing the H₂S in a trap cooled with Dry Ice freezing mixture.

A considerably purer gas is obtained by the decomposition of CaS (prepared by the Otto method and pressed into cubes) with very pure dilute hydrochloric acid. The product gas is passed through a wash bottle with distilled water, two wash bottles with KHS solution, a U tube with CaCl₂, and finally, into a trap cooled with Dry Ice mixture. The H₂S reevaporated from this trap is contaminated only with a small quantity of CO₂.

Very pure, air- and CO₂-free H₂S can be prepared via the following procedures:

I. HEATING OF CONCENTRATED Mg(HS)₂ SOLUTION

A one-liter round-bottom flask with a two-hole rubber stopper serves as the gas generator. A separatory funnel (250 ml.) and a gas outlet tube are placed in the stopper. Then 250 ml. of saturated MgCl₂ solution is allowed to flow in from the separatory funnel, followed by the same quantity of H₂O, and finally, by the same volume of saturated NaHS solution. A uniform H₂S stream is generated on slight heating of the flask. The gas is free of CO₂. At the beginning of the run, the apparatus is flushed with nascent H₂S (use a hood!) until all the air is displaced. After this, the gas is very pure. It is dried over P₂O₅ and glass wool and can be used for most laboratory purposes. The yield, based on hydrosulfide, is about 80%.

II.

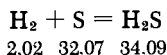

Especially pure H₂S can be obtained by synthesis from the elements. The apparatus is shown in Fig. 153. The flask *R*, made

of high-melting glass, is charged with about 250 g. of carefully purified S (see p. 341). The side arm reaction tube $r-b$, inclined upward and having an internal diameter of 2.5 cm. and a length of 150 cm., is filled with pea size pumice chips for a length of 80 cm. These are prepurified by boiling with concentrated HCl, dilute H_2SO_4 and then H_2O until they show no Cl^- or SO_4^{2-} reaction. They are then calcined in a nitrogen and then in a hydrogen stream. The part of the tube containing the chips is encased in furnace E and can be heated to $600^\circ C$. A lead cooling coil is wound around the middle of the tube section that protrudes from the furnace. The tube outlet is closed off with a thick wad of absorbent cotton and a one-hole rubber stopper. From the stopper, a tube leads to the purification and condensation setup (wash bottle 1 contains distilled water; wash bottles 2 and 3: distilled water and glass chips; wash bottle 4: absorbent cotton).

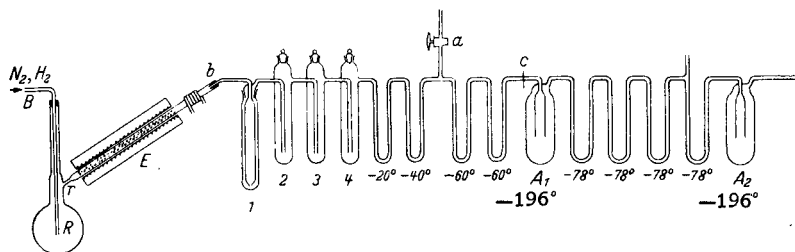

Fig. 153. Preparation of hydrogen sulfide.

At the beginning of the run, carefully purified N_2 is introduced at B until the air is completely displaced from the apparatus. Then H_2 is allowed to flow in at a rate of 8-9 liters/hour, while E is switched on. When the temperature has risen to $600^\circ C$, A_1 is cooled with liquid nitrogen and the sulfur in R is heated to boiling. The hydrogen reacts quantitatively to form H_2S . The heat input at R should be regulated in such a way that no sulfur accumulates in the side arm and a deposit of flowers of sulfur is formed on the cotton wad only after some time has elapsed. A loose condensate of long, shiny H_2S crystals precipitates in A_1 . It is melted briefly from time to time in order to utilize the condenser volume completely and to avoid plugging of the inlets and outlets. When A_1 is full, stopcock a is opened and A_1 is sealed at c . For purification the material is distilled from A_1 into A_2 in a high vacuum by slowly heating A_1 and cooling A_2 with liquid nitrogen (the intermediate U tubes are cooled with Dry Ice mixture). The first and last portions of the distillate are discarded. About 130 liters of H_2S

are obtained in 18 hours; the impurity content of the gas is less than 0.01%.

III. Pure H_2S , completely free of hydrochloric acid, is obtained in a simple manner by decomposition of a concentrated aqueous solution of C.P. $\text{Na}_2\text{S} \cdot 9\text{H}_2\text{O}$ with 20-30% phosphoric acid (C.P.). The acid is allowed to drip slowly from a separatory funnel into the sodium sulfide solution, and the evolving gas is dried over CaCl_2 and P_2O_5 .

Hydrogen sulfide is stored in liquid form at low temperature or in gasometers over saturated NaCl solution. Mercury may also be used as sealing fluid when the gas is completely pure and dry.

PROPERTIES:

Colorless gas with an unpleasant odor reminiscent of rotten eggs; highly toxic. Reducing agent for many substances; for this reason H_2S cannot be dried with concentrated H_2SO_4 .

M.p. -83°C , b.p. -59°C , crit. t. $+100.5^\circ\text{C}$, crit. p. 98.0 atm. gage; d (b.p.) 0.9504; wt. per liter 1.5392 g. Solubility at 760 mm. in 1 volume of H_2O (0°C): 4.67; (20°C): 2.58; (100°C): 0.81 volume of H_2S ; for further details, see D'Ans-Lax (1949), Table 332632 A, 7, p. 970; also soluble in ethanol.

In crystalline H_2S , the S atoms form a face-centered cubic lattice; probably type C1 or C2.

REFERENCES:

- O. Jacobsen. Ber. dtsh. chem. Ges. 20, 1999 (1887).
 A. Klemenc. Die Behandlung und Reindarstellung von Gasen [Treatment and purification of Gases], Leipzig, 1938, p. 180.
 L. Moser. Die Reindarstellung von Gasen [Purification of Gases], Stuttgart, 1920, p. 68.
 I. E. Grünert. J. prakt. Chem. 122, 1 (1929).
 II. A. Klemenc and O. Bankowski. Z. anorg. allg. Chem. 208, 348 (1932).
 III. F. Fehér, K. Naused and H. Weber. Z. anorg. allg. Chem. 290, 303 (1957).

Crude Sulfane



- I. $\text{Na}_2\text{S} + y\text{S} = \text{Na}_2\text{S}_x \quad (x = y + 1)$
 $\text{Na}_2\text{S}_x + 2\text{HCl} = \text{H}_2\text{S}_x + 2\text{NaCl}$

An aqueous solution of sodium polysulfide with the approximate composition $\text{Na}_2\text{S}_{5.5}$ serves as the starting material. It is

prepared as follows: A two-liter, round-bottom, long-neck flask is placed on a steam bath and filled with 500 g. of $\text{Na}_2\text{S} \cdot 9\text{H}_2\text{O}$, which is then heated with 250 g. of powdered S for three hours. Frequent shaking is necessary. The sulfide melts in its water of crystallization and dissolves most of the sulfur, with the color of the mixture becoming deeper. The cooled, dark red-brown solution is diluted with 400 ml. of H_2O . It is then rapidly suction-filtered to remove S residue and other impurities, and the filtrate is diluted with water to one liter.

Next, a five-liter filtration jar is thoroughly cooled on the outside with an ice-salt mixture, and 2 kg. of finely crushed ice and two liters of pure concentrated hydrochloric acid (d 1.19) are added one after the other. When the acid reaches a temperature of -15 to -20°C , the addition of Na_2S_x solution is begun. The solution (in a separatory funnel) is added with thorough stirring over a period of 1-1.5 hours. The solution becomes cloudy during the reaction because of the formation of a milky-white sulfur emulsion. The H_2S_x product settles at the bottom as a yellow oil. The addition rate should be so controlled that the temperature does not rise above -10°C , if at all possible, and in no case above -5°C ; otherwise, decomposition of the H_2S_x and evolution of H_2S occurs. After all the Na_2S_x solution has been added and the product oil has completely settled, the mother liquor is decanted and the oil is washed in the filtration jar with 1 N HCl and decanted in a separatory funnel. A small quantity of P_2O_5 is added to the crude sulfane. The product has the approximate composition $\text{H}_2\text{S}_{5.5}$; it can be stored in a closed glass vessel at 0°C for a fairly long period without change. Before further use, the P_2O_5 is filtered off through glass wool. Freshly prepared H_2S_x should form a clear solution with pure benzene. The yield is 260 g. (160 ml.) of oil, i.e., 87% relative to the starting sulfur.

If crude sulfane is to be prepared continuously in fairly large quantities, the apparatus described by F. Fehér and W. Laue should be used.

Use of sulfane for the preparation of H_2S_2 and H_2S_3 : A crude sulfane which is especially rich in H_2S_4 and is therefore suited for the production of tetrasulfane is prepared in the following manner:

A solution of Na_2S_2 is prepared by heating 480 g. of $\text{Na}_2\text{S} \cdot 9\text{H}_2\text{O}$, 64 g. of powdered S and 500 ml. of H_2O for three hours in a two-liter round-bottom flask on a steam bath. The cooled solution, suction-filtered to remove S residues, is then decomposed in the manner described above, using four liters of dilute HCl. The yield is 32 ml. of crude sulfane having the approximate composition $\text{H}_2\text{S}_{4.5}$.

II. In general, excess sulfane, H_2S_n , which also acts as a solvent, reacts with a chlorosulfane S_mCl_2 , producing quantitative HCl

separation and chain increase and forming a higher sulfane H_2S_{2n+m} according to the following scheme:

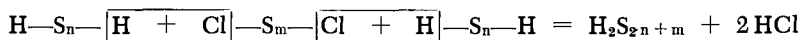

Excess H_2S_n

The H_2S_{2n+m} , which is formed as an intermediate, reacts in turn with the S_mCl_2 . Again, HCl is split off. The formation of a homologous mixture of sulfanes (= crude sulfane, H_2S_x) is based on this fact. (See also p. 353).

The number of moles of reagents, a and b , in the equation below gives the average composition x and the quantity c of crude sulfane formed when the quantity d of unreacted sulfane distilled off after the reaction is determined. The equation was derived on the basis of assumption about the molecular distribution obtained in the condensation of sulfanes and halosulfanes (F. Fehér and W. Laue); however, it holds only for the above described reactions under the further restriction that no other reactions take place.

$$aH_2S_n + bS_mCl_2 = cH_2S_x + 2bHCl + dH_2S_n$$

$$x = \frac{am + n(2a - b)}{a - b}; c = \frac{b(n + m)}{x - n}; d = a \left(1 - \frac{b}{a}\right)^2$$

Interfering side reactions which lead to a higher S content of the crude sulfane are favored, among other things, by too violent a reaction and by too small a sulfane excess. Because of its ease of preparation, only H_2S ($n = 1$) is of importance as a raw material for "crude oil." The reagents for the preparation of chlorosulfane are SCl_2 ($m = 1$) and S_2Cl_2 ($m = 2$). Elementary chlorine, which reacts very violently, may also be used. Since the product is either distilled or cracked, the formation of side products is of no particular importance.

For example, the reaction of a 7-mole excess of H_2S with SCl_2 yields a crude oil with the approximate composition $H_2S_{4.5}$ and containing fairly large quantities of H_2S_3 . With S_2Cl_2 , a crude oil of the approximate composition $H_2S_{5.2}$, containing a large amount of H_2S_4 , is obtained. These reactions are carried out in the same apparatus and in a manner analogous to that described for the preparation of tetrasulfane (p. 354). The reaction of liquid H_2S with Cl_2 yields mainly H_2S_3 and H_2S_4 , plus a small amount of H_2S_2 .

The choice of the second component in the reaction with liquid H_2S usually depends either on the sulfane which is to be distilled directly from the crude mixture or, if cracking is to follow the primary reaction, on the composition of the sulfane mixture which is best suited for that process.

SYNONYMS:

"Crude perhydrogen sulfide," "crude hydrogen persulfide," "hydrogen polysulfide," or just "crude oil." For the nomenclature of chain compounds of sulfur, see F. Fehér and W. Laue, *Z. Naturforsch.* 8b, 11 (1953).

PROPERTIES:

Yellow liquid resembling olive oil, pungent odor of camphor and S_2Cl_2 .

No definite m.p.; solidifies in liquid air to form a glassy mass which softens again on heating over a fairly broad temperature range. On heating, cracking to lower hydrogen sulfides (see H_2S_2 and H_2S_3) takes place. Gradually decomposed by water with evolution of H_2S . Spontaneous decomposition is caused by alkalis and sometimes even by the alkali content of glass. For this reason, all vessels which come in contact with the product must be "neutralized" beforehand by rinsing with hot, concentrated hydrochloric acid or by treatment with gaseous HCl . Soluble in CS_2 , C_6H_6 and $CHCl_3$.

REFERENCES:

- I. I. Bloch and F. Höhn, *Ber. dtsh. chem. Ges.* 41, 1961 (1908); F. Fehér and M. Baudler, *Z. anorg. allg. Chem.* 258, 147 (1949); F. Fehér and W. Laue, *Z. anorg. allg. Chem.* 288, 103 (1956).
- II. F. Fehér, W. Laue and J. Kraemer, *Z. anorg. allg. Chem.* 281, 151 (1955); F. Fehér and W. Laue, *Z. anorg. allg. Chem.* 287, 45 (1956); F. Fehér and W. Kruse, *Z. anorg. allg. Chem.* 293, 302 (1957).

Pure Sulfanes

Since sulfanes are readily decomposed by alkali, metals, dust, cork, rough surfaces and moisture, all glass vessels which come in contact with them (even glass wool) must be thoroughly cleaned, carefully dried and stored in a dust-free atmosphere.

Glass vessels are rinsed with hot cleaning solution, then with hot, pure, concentrated hydrochloric acid, and finally with distilled water. Apparatus contaminated with sulfur can be precleaned with CS_2 or hot ammonium sulfide solution.

Ground glass connections should be sealed with silicone grease. No NH_3 gas (e.g., from bottles of concentrated ammonia or ammonium sulfide in the area) may be present in the atmosphere.

All reactions with sulfanes must be protected from moisture, and pure starting materials must be used.

These precautions must always be very carefully adhered to when working with sulfanes, even when this is not expressly pointed out in the preparation.

I. DISULFANE AND TRISULFANE, H_2S_2 , H_2S_3

Both of these hydrogen sulfide compounds are formed by cracking of crude sulfane, using the apparatus shown in Fig. 154.

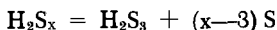
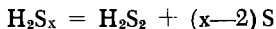

Since the yields of H_2S_2 and H_2S_3 improve when only small quantities of H_2S_x are cracked at a time, the process is carried out as follows. First, flask *a* (300 ml.) is heated in a paraffin bath to 110°C while the apparatus is evacuated to 12-15 mm. Then 15 ml. of H_2S_x (see p. 346 for preparation) is introduced through *d*. After a short time the condenser surface is coated with fine droplets. The H_2S_3 collects slowly but at a uniform rate in receiver *b*, which is at room temperature, while the H_2S_2 is condensed in trap *c*, which is cooled with Dry Ice-methanol mixture. Then the bath temperature at *a* is slowly increased to 125°C over a period of 20 minutes. The flask contents are cooled to 110°C and 15 ml. of H_2S_x is again added through *d*. The 20-minute heating procedure is repeated. After two portions of H_2S_x have been cracked, the vacuum is released and air is slowly introduced into the apparatus, passing through the CaCl_2 and soda-lime tubes. The ground glass joint at *a* is then quickly disconnected, and the hot, still liquid

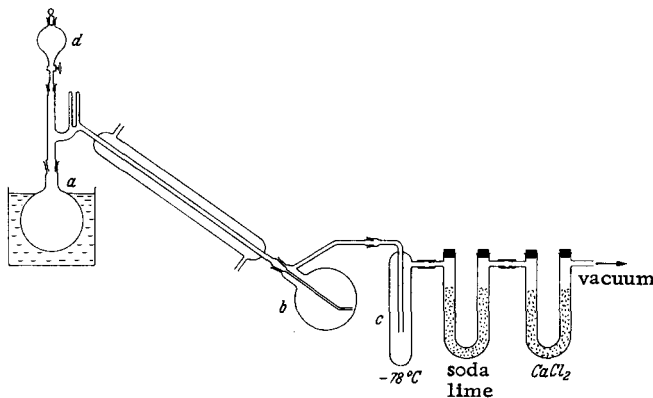

Fig. 154. Preparation of di- and trisulfane.

residue is poured out, whereupon it solidifies. After the ground glass joint has been resealed, the cracking is continued and the residue is again removed after two 15-ml. additions of H_2S_x . About 25 ml. of H_2S_3 and 15 ml. of H_2S_2 are obtained from 120 ml. of freshly prepared H_2S_x . With aged H_2S_x , the yield of H_2S_2 increases, while that of H_2S_3 is reduced. Both products are nearly pure; at most, each is contaminated by a small amount of the other.

Use of the Bloch and Höhn suction device to remove the cracking residue is not recommended since the residue solidifies easily in the narrow tubes and is then difficult to remove.

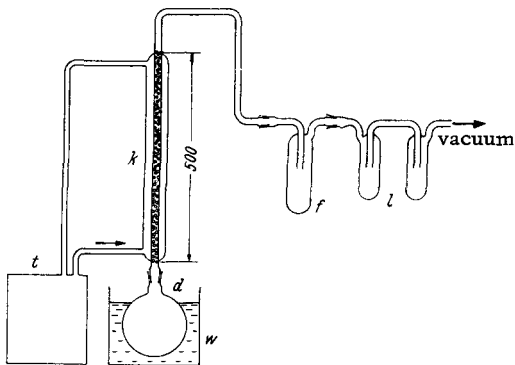

Fig. 155. Distillation of disulfane.

The disulfane is further purified by distillation in the apparatus shown in Fig. 155.

The low-temperature column k is a Liebig condenser filled with glass Raschig rings. It is cooled by circulating methanol from a constant temperature bath t . The distillation flask d is placed in a water bath w at room temperature. The trap f for collecting the pure disulfane is attached to k with an adapter. The liquid-nitrogen-cooled double trap l is connected to a vacuum pump.

After the crude disulfane, which has been dried with P_2O_5 and filtered through glass wool, is charged into the distillation flask d , the column is cooled to -15°C and the system is slowly evacuated to 15 mm. The flask contents foam vigorously, releasing the dissolved H_2S . When the initial foaming subsides, condensation of the pure disulfane is begun by cooling f with a Dry Ice-methanol mixture. Further distillation does not require any special attention.

Purification of 100 g. of disulfane takes about 1.5 hours.

The trisulfane is further purified by distillation in the apparatus shown in Fig. 156.

The 500-ml. flask d , immersed in water bath w , carries a Liebig condenser k_1 filled with glass Raschig rings and a spiral

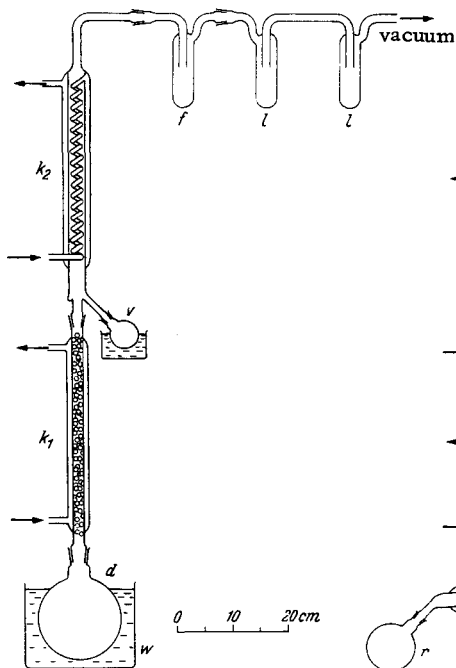

Fig. 156. Distillation of trisulfane.

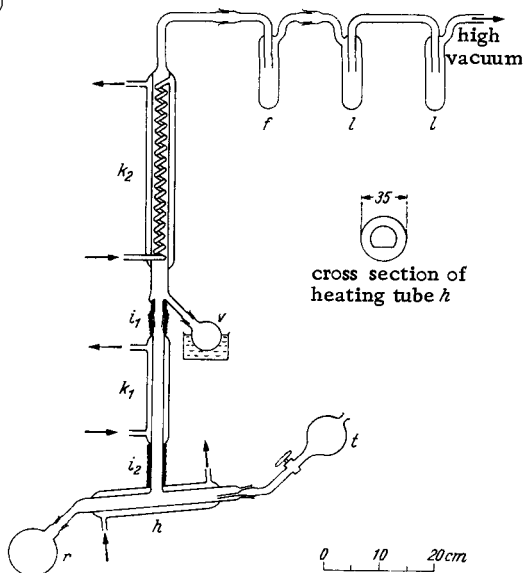

Fig. 157. Preparation of tetrasulfane.

condenser k_2 . The latter expands at the bottom to a toroid, from which an outlet leads to receiver v . A horizontal connecting tube leads from k_2 to trap f . The latter is followed by double trap l , cooled with liquid nitrogen, and this in turn is connected to a high-vacuum pump. Each condenser is provided with its own constant-temperature circulation system. The run is started by adjusting the temperature in k_1 to 42°C . Then flask d is filled with the crude trisulfane and attached to the apparatus. Trap f is cooled with Dry Ice-methanol and the system is slowly evacuated. When a pressure of 1.5 mm. is reached, k_2 and v are cooled with ice water and water bath w is heated to 52°C . The distillation now proceeds without further attention; H_2S_3 condenses in v . The more volatile oils condense in f and the less volatile components in k_1 , from which they flow back into flask d . The temperatures in k_1 , k_2 and w must be constant during the run. The pure distillate generally has the composition $\text{H}_2\text{S}_{3.00-3.03}$.

Equipment for the continuous preparation of larger quantities of H_2S_2 and H_2S_3 is described by F. Fehér and M. Baudler, *Z. anorg. Chem.* **253**, 170 (1947); **254**, 251 (1947); and F. Fehér, W. Laue and G. Winkhaus, *Z. anorg. allg. Chem.* **288**, 113 (1956). This

equipment may also be used to prepare disulfane in yields greater than those described above.

II. TETRASULFANE, H_2S_4

Tetrasulfane is obtained from crude sulfane in the apparatus shown in Fig. 157.

The modified Utzinger tube h , the lower part of which is flattened to increase the vaporization surface as much as possible (see cross section), is surrounded by a heating jacket and carries a separatory funnel t and a 500-ml. flask r . The attached condenser k_1 and the spiral condenser k_2 (which is identical to that used in trisulfane purification and has a toroidal expansion and an outlet to the receiver v) are provided with separate constant-temperature circulating systems. Again, condenser k_2 is connected to trap f , which is immersed in a Dry Ice-methanol mixture. Trap f adjoins double trap l , cooled with liquid nitrogen, which is connected to a high-vacuum pump. The connecting sections of the condensers are covered with asbestos insulation i_1 and i_2 .

The system is evacuated until a pressure of 10^{-3} mm. is attained. Tube h is heated to $75^\circ C$, k_1 to $50^\circ C$, and k_2 and the water bath to $15^\circ C$. Then crude oil of composition $H_2S_{4.5-5.0}$ (preparation on p. 346) is allowed to drip slowly from the separating funnel t into the tube h . The volatile components of the oil distill off while the residue collects in r . Condenser k_2 separates the tetrasulfane from the lighter and heavier components of the distillate. The product is collected in v . An H_2S_2 - H_2S_3 mixture collects in f while the higher-boiling fractions flow from k_1 into r .

III. TETRA-, PENTA-, HEXA-, HEPTA- and OCTASULFANES H_2S_4 , H_2S_5 , H_2S_6 , H_2S_7 , H_2S_8

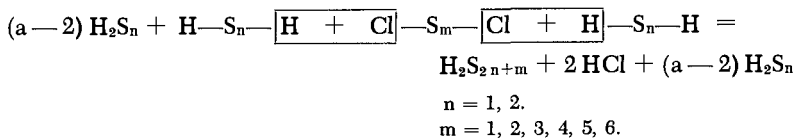

In general, excess sulfane H_2S_n reacts with a chlorosulfane S_mCl_2 , splitting off HCl quantitatively and polymerizing to form a homologous mixture of chain sulfanes. The formation of such a mixture is predicated on the fact that the product of the primary reaction reacts further with the chlorosulfane (compare p. 348).

If, however, a very large excess of the H_2S_n component (a) is used, individual sulfanes can be obtained via direct synthesis. In this case, the rate of formation of the sulfane is so much larger than that of the homologs that it is reaction-controlling. The excess of the sulfane, $(a-2)H_2S_n$, is distilled off after the reaction. Using this principle, it is possible to obtain, with appropriate chloro-

sulfanes, almost pure H_2S_4 , H_2S_5 , H_2S_6 , H_2S_7 and H_2S_8 . The preparative procedures for all these products are analogous, the reaction conditions mild, and the products almost uncontaminated with each other.

These sulfanes are generally best prepared from the following reactants:

Desired sulfane	Sulfane component	Chlorosulfane component
H_2S_4	H_2S	S_2Cl_2
H_2S_5	H_2S_2	SCl_2
	or H_2S	S_3Cl_2
H_2S_6	H_2S_2	S_2Cl_2
H_2S_7	H_2S	S_5Cl_2
	or H_2S_2	S_3Cl_2
H_2S_8	H_2S_2	S_4Cl_2

As an example of the procedure and the ratios of the reactants used, the preparation of tetra- and pentasulfane are described.

a) TETRASULFANE, H_2S_4

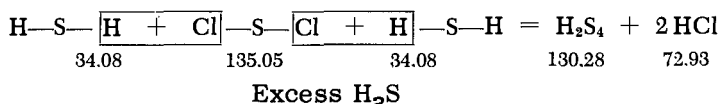

The reaction is carried out in a 500-ml., four-neck flask, provided with one male and three female ground glass connections for P_2O_5 drying tube, separating funnel, low-temperature thermometer, and a mercury seal stirrer. The product is poured out through the neck with the male connection.

To prepare the H_2S_4 , a concentrated aqueous solution of C.P. $\text{Na}_2\text{S} \cdot 9\text{H}_2\text{O}$ (1800 g.) is decomposed with C.P. 25% H_3PO_4 (3400 g.) (compare p. 346) and the gas is passed through CaCl_2 and P_2O_5 drying tubes into a cooled trap (methanol-Dry Ice) where about 150 ml. of H_2S is condensed. From this trap, the H_2S is distilled into the reaction flask, passing through the CaCl_2 and P_2O_5 drying tubes. The reaction flask is immersed in a Dewar flask containing Dry Ice-methanol mixture and the gas is thus liquefied.

About 20 g. of dichlorodisulfane (about 0.15 mole) is carefully added from a separatory funnel. The addition temperature is -80°C , stirring is employed, and the dichlorosulfane is added drop-by-drop over a period of two hours. It is advisable to precool the chlorosulfane. Thus, a bent capillary is attached to the outlet tube of the separatory funnel. This capillary is immersed in the liquid H_2S and then discharges above the surface of the H_2S . The reaction

is complete after about 12 hours, when the reaction mixture has become colorless. The excess H_2S , contaminated with HCl , is slowly evaporated by removing the Dewar flask. The last traces of H_2S are removed by briefly applying an aspirator vacuum. Clear, almost pure tetrasulfane remains in the flask. Since H_2S is highly toxic, the preparation must be carried out under a good hood.

b) PENTASULFANE, H_2S_5

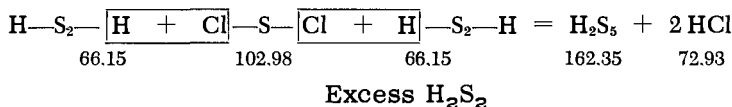

The reaction flask (described in the preparation of tetrasulfane; see above) containing 100 g. H_2S_2 is cooled with Dry Ice-methanol to -60 to -65°C in a Dewar flask. From the separatory funnel, 10 g. of SCl_2 (about 0.1 mole) is allowed to drip in slowly (with stirring) in such a way that the temperature of the mixture does not rise above -55°C . In contrast to the preparation of tetrasulfane, the use of a bent outlet capillary is not recommended, since it plugs easily. The Dewar flask is removed 15 minutes after the completion of the dropwise addition. When the mixture has warmed to 0°C , the temperature is held constant until the evolution of HCl has, for all practical purposes, ended; the mixture is then stirred for another 0.5 hour at room temperature. The total reaction time is 1.5 hours.

The clear mixture is poured into a 250-ml., two-neck flask. One neck of this flask, the one connected to a receiving trap, is shaped as shown in Fig. 158. This intricate shape is necessary since the H_2S_2 to be evaporated tends to superheat and splash.

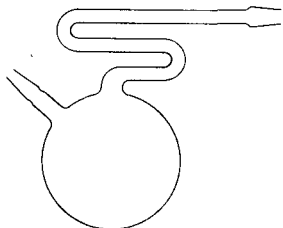

Fig. 158. Evaporation of excess disulfane.

The other neck is a male ground glass piece and is used for pouring out the product. Most of the H_2S_2 is removed in a vacuum of 15 mm., the remainder in high vacuum (about 10^{-3} to 10^{-4} mm.). The product is also briefly heated to 30 to 40°C during the last stage of H_2S_2 removal. The generally quite clear greenish-yellow to yellow residue represents the desired product, which is quite pure.

PROPERTIES:

H_2S_2 :

Formula weight 66.15. M.p. -89.6°C , b.p. 70.7°C ; d. (20°C) 1.334. Light yellow liquid.

H_2S_3 :

Formula weight 98.21. M.p. -52 to $-54^\circ C$; $d(20^\circ C)$ 1.491. On heating, cracking to H_2S_2 , H_2S and S occurs. Light yellow liquid of somewhat deeper color than H_2S_2 . Both H_2S_2 and H_2S_3 have a pungent odor of camphor and S_2Cl_2 ; the vapors are irritating to the eyes and mucous membranes. On prolonged standing, both are converted to homologs richer in sulfur, giving off H_2S . With water they decompose with evolution of H_2S and precipitation of S. Soluble in CS_2 , C_6H_6 and $CHCl_3$.

 H_2S_4 :

Formula weight 130.28. Bright light-yellow liquid similar to olive oil, pungent odor. Somewhat less easily decomposed than H_2S_2 and H_2S_3 ; like these, it is converted on prolonged standing into homologs richer in sulfur. No definite melting point; solidifies at about $-85^\circ C$ to a white, glassy mass which gradually softens over a fairly wide temperature range when heated. Cracked by heating to lower hydrogen sulfides, particularly H_2S . $d(20^\circ C)$ 1.582.

 H_2S_5 :

Formula weight 162.35. $d(20^\circ C)$ 1.644.

 H_2S_6 :

Formula weight 194.41. $d(20^\circ C)$ 1.688.

 H_2S_7 :

Formula weight 226.48. $d(20^\circ C)$ 1.721.

 H_2S_8 :

Formula weight 258.54. $d(20^\circ C)$ 1.747.

The properties of the higher sulfanes (from H_2S_5 up) are similar to those of the lower homologs. They are greenish-yellow liquids, changing to a deeper yellow with increasing chain length. At $0^\circ C$, the substances are stable for several days if they are protected from contact with air.

REFERENCES:

- I. I. Bloch and F. Höhn, Ber. dtsh. chem. Ges. 41, 1971, 1975 (1908); F. Fehér, W. Laue and G. Winkhaus, Z. anorg. allg. Chem. 288, 113 (1956).

- II. F. Fehér and M. Baudler, *Z. anorg. Chem.* 254, 289 (1947); F. Fehér, W. Laue and G. Winkhaus, *Z. anorg. allg. Chem.* 288, 113 (1956).
- III. F. Fehér and L. Meyer, *Z. Naturforsch.* 11b, 605 (1956); F. Fehér and G. Winkhaus, *Z. anorg. allg. Chem.* 288, 123 (1956); F. Fehér and W. Kruse, *Z. anorg. allg. Chem.* 293, 302 (1957).

Ammonium Hydrogen Sulfide

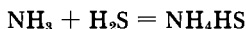

17.03 34.08 51.11

Carefully dried NH_3 and H_2S are alternately added to an Erlenmeyer flask containing anhydrous ether at 0°C ; the flask must be carefully protected from moisture. White crystals of pure NH_4HS precipitate. These readily decompose again at room temperature into NH_3 and H_2S and must therefore be quickly suction-filtered and freed of adhering ether by pressing between filter papers. When sealed in glass ampoules, NH_4HS is stable for some time.

PROPERTIES:

White, needle-shaped crystals; easily decomposed; dissociation pressure at room temperature about 350 mm. d 1.17.

Readily soluble in water and ethanol, forming colorless solutions which rapidly yellow in air; insoluble in ether and benzene.

Tetragonal crystals, space group D_{4h}^7 .

REFERENCE:

- J. S. Thomas and R. W. Riding, *J. Chem. Soc. (London)* 123, 1181 (1923).

Sodium Hydrogen Sulfide

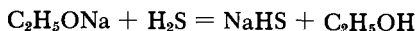

68.06 34.08 56.07 46.07

Carefully dehydrated $\text{C}_2\text{H}_5\text{OH}$ (20 ml.) and small, bright pieces of Na (2 g.) are placed in a 150-ml. glass flask equipped with a reflux condenser and an adapter, closed at first, for introducing a gas

inlet tube. A drying tube on the reflux condenser prevents penetration of atmospheric moisture. When the ethoxide begins to separate, just enough additional C_2H_5OH is added to keep all solute in solution at room temperature. A total of about 40 ml. of C_2H_5OH is needed. Then a glass tube, reaching to the bottom of the flask, is introduced through the adapter and sealed in tightly with a rubber stopper or a piece of hose. A fast stream of pure, carefully dried H_2S (see p. 344 ff.) is introduced through this tube into the solution. After a few minutes, an abundant, fine crystalline precipitate of slightly impure NaHS separates out. The solution is saturated with H_2S and quickly suction-filtered. The filtrate is transferred into a dry Erlenmeyer flask and 50 ml. of pure absolute ether is added. A dense, pure white precipitate of NaHS separates immediately. It is allowed to settle in the stoppered flask, and small portions of ether are added as long as crystals continue to form in the supernatant liquid. In all, about 110 ml. of ether is required for the precipitation. The precipitate is quickly suction-filtered, washed with absolute ether, and transferred to a vacuum desiccator. The yield is 4.3 g. of NaHS. The product is almost analytically pure. Redissolution in absolute C_2H_5OH and reprecipitation with ether readily yields a completely pure substance.

PROPERTIES:

White, granular crystalline powder; very hygroscopic. Turns yellow on heating in dry air, orange at higher temperatures; melts to a black liquid at about $350^\circ C$. d 1.79.

Very soluble in water; moderately soluble in C_2H_5OH . Pure NaHS dissolves in hydrochloric acid with vigorous evolution of H_2S to form a clear solution. Aged products give a weakly yellowish, opalescent solution.

Rhombohedrally distorted NaCl structure, space group D_{3d}^5 .

REFERENCES:

- A. Rule, J. Chem. Soc. (London) 99, 558 (1911).
 W. Teichert and W. Klemm, Z. anorg. allg. Chem. 243, 86 (1939).

Sodium Sulfide



The reaction is carried out in liquid ammonia using the apparatus of Fig. 159.

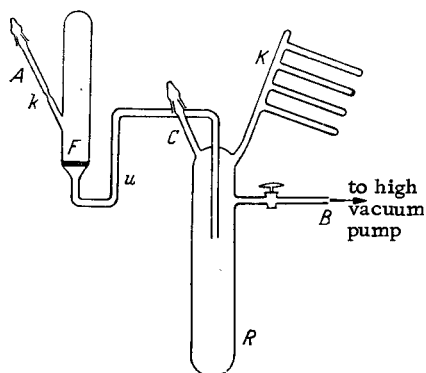
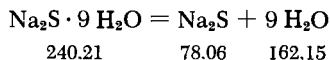

Fig. 159. Preparation of sodium sulfide.

A weighed tube containing very pure, vacuum distilled Na (see section on Alkali Metals) is opened by breaking off the tip and is quickly pushed into the side arm *A* of the apparatus. The latter is immediately capped off. After evacuating through *B*, *A* is carefully heated until the metal melts and flows through the capillary *k* onto the frit plate *F*. The small amount of oxide that formed when the tip was broken off remains in the ampoule. A vigorous stream of dry, carefully purified N_2 is then introduced through *B*, *A* is opened again, the empty ampoule is removed, and the weight of reactant Na is determined by reweighing the ampoule. The quantity of sulfur required for the reaction is introduced at *C*. Vessel *R* is cooled with a Dry Ice bath, and about 100 ml. of pure NH_3 is condensed on top of the sulfur. The frit plate *F* and the sharply bent part of tube *u* are then cooled until some NH_3 collects above the frit; a portion of the Na dissolves in this. The ammonia vapor then produces a higher pressure in the space above *F* than in *R*, and this ammoniacal Na solution is forced into *R* where it contacts the ammoniacal S solution. This procedure is repeated until all the Na has been extracted from the frit with small portions of NH_3 . At first, sodium polysulfides are formed in *R* because of the excess S; these gradually degrade to Na_2S as more Na solution is added. By gradually removing the cooling bath at *R*, the NH_3 is then allowed to evaporate slowly over a period of several hours. Toward the end of this period, a white precipitate separates. The last traces of NH_3 must be evaporated particularly carefully to prevent spattering of the crystals. Finally, the apparatus is evacuated for some time with an oil pump and vessel *R* is heated for 0.5 hour at $400-500^\circ C$. The crystals are pulverized by vigorous shaking and are forced into storage tubes *K* by tipping the apparatus. The tubes are sealed off in vacuum or N_2 atmosphere. The Na_2S is very pure; the yield is almost quantitative.

II.



Pure $\text{Na}_2\text{S} \cdot 9\text{H}_2\text{O}$ is allowed to stand for 14 days in vacuum over concentrated sulfuric or phosphoric acid. The temperature should be 15°C at the start, later 30 to 35°C . The resulting salt contains only 4% H_2O . The last traces of water are removed by heating the material to 700°C in a glass or porcelain tube in a fast stream of dry, well-purified H_2 . Granular, pure white Na_2S of 99.5-99.8% purity is obtained.

PROPERTIES:

White crystals; very hygroscopic; discolors rapidly in moist air. M.p. $1180 \pm 10^\circ\text{C}$ (in vacuum); d 1.86.

Readily soluble in water; solutions have a strongly alkaline reaction.

Crystallizes in C1 structure type.

REFERENCES:

- I. W. Klemm, H. Sodomann and P. Langmesser, *Z. anorg. allg. Chem.* **241**, 281 (1939).
- II. G. Courtois, *Compt. Rend. Séances Acad. Sci.* **207**, 1220 (1938).

Potassium Sulfide

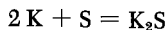

78.19 32.07 110.26

The preparation is carried out in liquid NH_3 in the apparatus shown in Fig. 160.

A weighed tube containing very pure, vacuum-distilled potassium (see section on Alkali Metals) is opened by breaking off the tip and is quickly pushed into side arm *A*; the latter is immediately capped off. The system is then evacuated through *B* with a high-vacuum pump, and *A* is heated carefully until the metal melts and flows through the capillary *k* into the reaction vessel *R*. Small amounts of oxide which formed on opening the ampoule remain in the latter. After a vigorous stream of dry, carefully purified N_2 is introduced at *B*, *A* is reopened and the exact weight of reactant metal is determined by removing and reweighing the ampoule. The stoichiometric quantity of sulfur is then introduced at *C*, while the passage of N_2 is continued. Vessel *R* is then cooled with a Dry Ice

bath, and 100 ml. of pure NH_3 is condensed on top of both reactants. The reaction forming K_2S is quantitative if the NH_3 is then allowed to reevaporate over a period of several hours through drying tubes filled with KOH . The ammoniacal solution becomes colorless toward the end, and the K_2S separates as a white precipitate. As the last traces of NH_3 are removed, the evaporation is slowed down by frequent cooling in order to prevent spattering of the crystals in the reaction vessel. At the end of the run, the system is evacuated for some time with the oil pump and vessel R is heated for 0.5 hour at $400\text{--}500^\circ\text{C}$. The crystals are pulverized by shaking and transferred into storage tubes K by tipping the apparatus. The tubes are then sealed off in vacuum or in a N_2 atmosphere. The K_2S is very pure; the yield is almost quantitative.

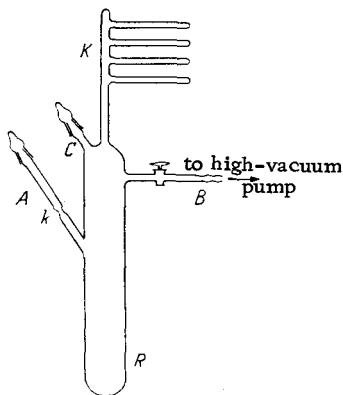

Fig. 160. Preparation of potassium sulfide.

The procedure given above for Na_2S may also be used for K_2S .

PROPERTIES:

White crystalline powder; very hygroscopic and sensitive to air. M.p. 912°C ; d 1.74.

Readily soluble in water; solutions give a strongly alkaline reaction.

Crystallizes in C 1 structure type.

REFERENCES:

W. Klemm, H. Sodomann and P. Langmesser, *Z. anorg. allg. Chem.* 241, 281 (1939).

See also J. Goubeau, H. Kolb and H. G. Krall, *Z. anorg. allg. Chem.* 236, 45 (1938).

Sodium Disulfide



I.

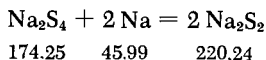

A solution of Na_2S_4 in absolute alcohol is prepared according to the directions given on p. 365. While the solution is kept warm

and a continuous stream of H_2 or N_2 is passed through, 4 g. of shiny Na, cut into fairly large pieces, is introduced rapidly one after another, by briefly removing the reflux condenser. The solution is then heated for about 30 minutes at $80^\circ C$. The light yellow Na_2S_2 precipitate is rapidly suction-filtered through a glass frit in a vigorous H_2 or N_2 stream. It is thoroughly washed several times with absolute alcohol in order to remove occluded Na_2S_4 and adhering mother liquor. It is then allowed to stand in a vacuum desiccator over P_2O_5 . Even after a fairly long time in the desiccator, the product still contains about 4% of tenaciously adhering C_2H_5OH . The yield is 7-8 g. of Na_2S_2 .



About 2.5 g. of Na_2S and the stoichiometric quantity of S are placed in a Pyrex tube in a vigorous stream of dry, O_2 -free N_2 . After the tube has been sealed off in high vacuum, the reactants are fused at $500^\circ C$ in an electric furnace until completely homogenized (about 45 minutes are required). The melt solidifies on cooling to form yellow, very hard Na_2S_2 .



This method of preparation from the elements (in liquid NH_3) given by Fehér and Berthold, follows in principle the method worked out by Klemm and co-workers for preparing Na_2S (method I, p. 358).

SYNONYM:

Disodium disulfane.

PROPERTIES:

Light yellow, microcrystalline, very hygroscopic powder. Gradually darkens on heating and at $400^\circ C$ is a light reddish-brown. Above $475^\circ C$, the color deepens to dark brown and the substance sinters. M.p. $\sim 490^\circ C$. The deep brown melt is very mobile. After solidification and thorough grinding in a mortar, only the preparation obtained from liquid ammonia retains the original yellow color. The products prepared from alcohol are always olive green after melting. X-ray studies have shown that sodium disulfide occurs in two modifications, a low-temperature modification

(α - Na_2S_2) and a high-temperature modification (β - Na_2S_2). The lines of pure α - Na_2S_2 were observed only in preparations isolated from alcoholic solution. Products which solidified from a melt or were exposed to higher temperatures have the lattice of the β -modification. Irreversible transition from one modification to the other occurs between 150 and 250°C.

REFERENCES:

- I. A. Rule and J. S. Thomas, *J. Chem. Soc. (London)* 105, 177 (1914); T. G. Pearson and P. L. Robinson, *J. Chem. Soc. (London)* 1930, 1473; 1931, 1304; F. Fehér and H. J. Berthold, *Z. anorg. allg. Chem.* 273, 144 (1953).
- II. W. Klemm, H. Sodomann and P. Langmesser, *Z. anorg. allg. Chem.* 241, 281 (1939); 225, 273 (1935).
- III. See Na_2S (I); F. Fehér and H. J. Berthold, *Z. anorg. allg. Chem.* 273, 144 (1953).

Potassium Disulfide

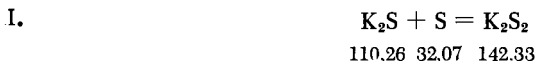

The procedure is the same as in method II for Na_2S_2 . On cooling the melt, a hard yellow cake of K_2S_2 is formed.



Prepared in liquid NH_3 analogously to method III for Na_2S_2 .

SYNONYM:

Dipotassium disulfane.

PROPERTIES:

From liquid NH_3 , it is a fine, pale yellow powder which, after heating at 150°C in vacuum for several hours, is free of all NH_3 . Extremely hygroscopic and sensitive to air. The aqueous solution is light yellow. On heating in vacuum, K_2S_2 gradually darkens and at 440°C is deep orange. At higher temperatures, the substance sinters; at 500°C it is a dark red-violet and it melts at about 520°C to form a dark brown fluid. After pulverizing, the solidified melt

reverts to the original yellow color. d (20°C) 1.973. Occurs in only one modification.

REFERENCES:

- I. The same as for Na_2S_2 (II).
- II. The same as for Na_2S_2 (III); F. Fehér and H. J. Berthold, Z. anorg. allg. Chem. 274, 223 (1953).

Potassium Trisulfide



The reaction is carried out in absolute alcohol.

A solution of 5.0 g. of shiny K in 72 ml. of carefully dehydrated ethanol is prepared in a round-bottom flask equipped with a reflux condenser and a drying tube. After the evolution of H_2 ends, exactly half the solution is decanted and is saturated with H_2S (in the absence of atmospheric moisture) in the manner described for NaHS . Excess H_2S is removed by brief boiling in a stream of N_2 or H_2 . The two portions of the solution are then recombined in the original reaction flask. This K_2S solution is then mixed with 4.1 g. of pure S and boiled for 30 minutes; orange-yellow K_2S_3 crystals separate. These are quickly suction-filtered in a fast H_2 or N_2 stream, washed with absolute ethanol, and freed of adhering solvent in a vacuum desiccator over P_2O_5 .

II. The solid starting materials are melted together. The procedure is the same as in method II for Na_2S_2 . A brown hard cake of K_2S_3 is formed on cooling the melt.

SYNONYM:

Dipotassium trisulfane.

PROPERTIES:

Well crystallizing, yellow-orange compound, which is readily soluble in water, giving a yellow solution. On heating, the substance becomes increasingly darker, begins to sinter above 284°C , and melts at about 292°C to form a brown-black melt. After solidification and pulverization, K_2S_3 has a greenish-brown color. The preparations made by the melt process are of the same color. d (20°C) 2.102.

REFERENCES:

- I. T. G. Pearson and P. L. Robinson, *J. Chem. Soc. (London)* 1931, 1304; the same as for K_2S_2 (II).
- II. The same as for Na_2S_2 (II).

Products of the analytical composition Na_2S_3 may be prepared from the elements either in liquid ammonia or in a melt. However, these products are simply equimolar mixtures of Na_2S_2 and Na_2S_4 .

REFERENCE:

- F. Fehér and H. J. Berthold, *Z. anorg. allg. Chem.* 273, 144 (1953).

Sodium Tetrasulfide

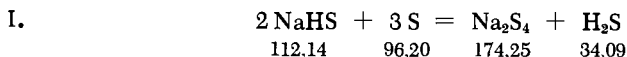

A mixture of 50 ml. of absolute alcohol and about 2 g. of fairly small pieces of shiny Na is prepared in a 150-ml. flask equipped with a reflux condenser and an (initially closed) side arm for holding a gas inlet tube. A drying tube on the condenser prevents contact with atmospheric moisture. After all the Na has dissolved to the ethoxide, a glass tube extending to the bottom of the flask is introduced through the side arm. It is sealed tightly in place, and pure, carefully dried H_2S is passed through it to saturate the solution. The slight precipitate of NaHS which sometimes forms is not troublesome since it redissolves during the reaction. Then the stoichiometric quantity of pure, very finely powdered S (2.00 g. of Na corresponds to 4.17 g. of S) is added and the reaction mixture boiled for one hour on a steam bath while a vigorous stream of O_2 -free, dry H_2 or N_2 is passed through. A dark-red solution of Na_2S_4 is formed. This is condensed to 5 ml. in vacuum at about $40^\circ C$, causing a dense, yellow precipitate of Na_2S_4 to separate. The product is rinsed out onto a fritted filter with some absolute alcohol, quickly suction-filtered in a vigorous H_2 or N_2 stream, and washed with some alcohol. On prolonged standing in a vacuum desiccator over P_2O_5 , it loses the adhering alcohol except for small, stubbornly retained quantities (about 2-3%). The yield is 5-6 g.



The procedure is the same as that described in method II for Na_2S_2 . A grayish-yellow, hard cake of Na_2S_4 is formed on cooling the melt.

SYNONYM:

Disodium tetrasulfane.

PROPERTIES:

Sodium tetrasulfide formed from alcoholic solution is a hygroscopic, orange-yellow crystalline powder. The aqueous solution is yellow at room temperature and dark red at the boiling point. Becomes brown on heating, begins to sinter at 284°C , melts at 286°C to a brown-black mass. After solidification, the substance is green. $d(20^\circ\text{C})$ 2.08.

REFERENCES:

The same as for Na_2S_2 (I and II).

Potassium Tetrasulfide



The procedure is the same as in method II for Na_2S_2 . A hard, wine-red cake of K_2S_4 is formed on cooling the melt.



Preparation in liquid NH_3 is analogous to that described in method III for Na_2S_2 .

SYNONYM:

Dipotassium tetrasulfane.

PROPERTIES:

Orange-yellow solid. The aqueous solution is yellow at room temperature, red at the boiling point. Begins to sinter at 145°C , and melts around 159°C without a sharp melting point. Dark red melt.

On cooling, solidifies to a dark-red, glassy mass. In the preparation of the very pure compound from liquid NH_3 , supercooling of the solution can be eliminated by heating it to 110°C . The color of the substance is then again orange-yellow but slightly more intense than before the melting.

REFERENCES:

The same as for Na_2S_2 (II) and K_2S_2 (II).

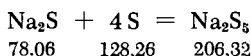
Sodium Pentasulfide

The procedure is the same as in method II for Na_2S_2 . A hard, grayish-yellow cake of Na_2S_5 is formed on cooling the melt.

SYNONYM:

Disodium pentasulfane.

PROPERTIES:

Yellowish-brown powder, very hygroscopic. The microscope reveals uniform, light yellow, partly transparent crystal fragments. If dissolved in freshly boiled water or dilute sodium hydroxide, slight precipitation of S takes place. This disappears almost completely when the solution is heated.

M.p. 253°C ; d (20°C) 2.08.

REFERENCES:

The same as for Na_2S_2 (I and II).

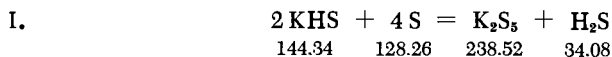
Potassium Pentasulfide

In principle, the reaction is the same as that described in method I for Na_2S_4 . The experimental procedure is therefore completely analogous.

Dissolving about 2 g. of K in 30 ml. of anhydrous C_2H_5OH and subsequent saturation with H_2S yields an (absolute) alcoholic KHS solution. This solution is then mixed with the stoichiometric quantity of very finely powdered S (2.00 g. of K corresponds to 3.28 g. of S) and is then boiled for one hour on a steam bath while H_2 or N_2 is passed through. The reaction is instantaneous and is accompanied by H_2S evolution and discoloration of the solution; after a short time, a light orange-red precipitate of K_2S_5 is formed. The quantity of this precipitate increases considerably if the solution is then concentrated in vacuum to about 5 ml. The K_2S_5 is then quickly suction-filtered in a vigorous H_2 or N_2 stream, washed with some absolute ethanol, and freed of adhering solvent in a vacuum desiccator over P_2O_5 . The yield is about 5 g.



The procedure is the same as described in method II for Na_2S_2 . A hard, dark-brown cake of K_2S_5 is formed on cooling the melt.

SYNONYM:

Dipotassium pentasulfane.

PROPERTIES:

Depending on the method of preparation, orange-red, shiny crystals or dark brown, microcrystalline mass. After a short exposure to air the crystals become coated with a sulfur layer. A solution in CO_2 -free water is yellow to orange-red and becomes deep, dark red at the boiling point. On heating in vacuum, the substance at first becomes dark red and then, at $190^\circ C$, deep violet. M.p. $211^\circ C$; d ($20^\circ C$) 2.128.

REFERENCES:

The same as for Na_2S_2 (I and II) and K_2S_2 (II).

Potassium Hexasulfide



About 5 g. of K_2S_5 is heated together with the required quantity of S for several hours in an evacuated glass tube. The temperature is between $220^\circ C$ and $280^\circ C$, and heating is continued until a completely homogeneous melt is obtained. This procedure is analogous

to that described in method II for Na_2S_2 . The melt is allowed to cool slowly over a period of about 10 hours.

SYNONYM:

Dipotassium hexasulfane.

PROPERTIES:

After pulverizing, K_2S_6 has a red to reddish-brown color and no longer forms a clear solution in water. Sintering starts at about 184°C . M.p. 196°C ; d (20°C) 2.02.

REFERENCES:

The same as for K_2S_2 (II).

The other alkali metal sulfides Rb_2S_2 , Rb_2S_3 , Rb_2S_5 , Cs_2S_2 , Cs_2S_3 and Cs_2S_6 can be prepared from the elements in liquid NH_3 in the same way as described in method III for Na_2S_2 .

REFERENCE:

F. Fehér and K. Naused, Z. anorg. allg. Chem. 283, 79 (1956).

Ammonium Pentasulfide

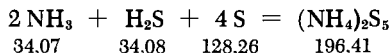

A mixture of 80 g. of finely crystalline S in 200 ml. of concentrated ammonium hydroxide (d 0.88, about 35%) is prepared in a one-liter round-bottom flask with a side gas inlet tube reaching to the bottom of the flask. After the closed flask has been weighed, a moderately fast stream of pure, dry H_2S is passed through the suspension. The neck of the flask carries a one-hole rubber stopper closed off with a plug of absorbent cotton. This flow impediment causes a constant positive pressure within the vessel and thus prevents the inflow of atmospheric O_2 . The solution is at first orange and later becomes dark red; the S dissolves, with occasional shaking, after 60 to 80 minutes. More H_2S is then introduced until a total of about 35 g. is absorbed. The impurities are then removed by rapid suction-filtering of the dark

solution. The filtrate is allowed to stand in a tightly sealed flask at room temperature or on ice until crystallization occurs. After several hours, yellow needles of $(\text{NH}_4)_2\text{S}_5$ are formed. These are stable for a fairly long time if submerged in the mother liquor in the absence of air, but they decompose very rapidly when dry to form NH_3 , H_2S and S . The product is isolated by rapid suction-filtration through filter paper, removal of adhering mother liquor by pressing between filter papers, and consecutive washing with ether-methanol (5 : 1), absolute ether and anhydrous chloroform. The still moist product is allowed to stand in a vacuum desiccator over CaO which has been wetted with some concentrated ammonium hydroxide. However, because of decomposition, it contains about 10% of elemental sulfur after five hours. Freshly prepared $(\text{NH}_4)_2\text{S}_5$ should give a clear solution in 5% ammonium hydroxide.

SYNONYM:

Diammonium pentasulfane.

PROPERTIES:

Yellow to orange-yellow crystals; very easily decomposed to NH_3 , H_2S and S . Melts in a sealed tube at 95°C to form a red liquid; decomposes on heating in an open tube. Rapidly precipitates S with water; soluble in ammonium hydroxide (see above).

REFERENCE:

H. Mills and P. L. Robinson, *J. Chem. Soc. (London)* 1928, 2326.

Dichloromonosulfane



I.

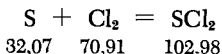

Coarsely ground roll sulfur (200 g.) is placed in a one-liter, round-bottom, ground glass flask equipped with a side arm serving as gas inlet. A reflux condenser is set in the ground joint and a thermometer is fastened in such a way that it protrudes from the flask into the lower part of the condenser. From the upper end of the condenser an outlet tube leads to the hood through a wash bottle containing H_2SO_4 . A fast stream of carefully dried Cl_2 gas is passed through the S until the contents of the flask have completely liquefied, forming crude S_2Cl_2 (heat is evolved). Then a

spatula tip (about 0.1 g.) of Fe powder or anhydrous FeCl_2 or FeCl_3 is added and the gas flow is continued for another 0.5 hour; during this time the reaction mixture is gradually cooled to 20°C by immersing the flask in water. The dark red liquid which forms, and which contains S_2Cl_2 and Cl_2 in addition to the SCl_2 , is left to stand for about one hour. Then 2 ml. of PCl_3 is added and the solution is distilled through a small fractionating column. The middle fraction boiling between 55 and 62°C is collected in a receiver containing a few drops of PCl_3 and is again fractionated. A very pure product with a constant boiling point of 60°C is obtained. The yield is about 70%.

The substance is stable for a few days when stored in glass vessels in the presence of a few drops of PCl_3 . Pure SCl_2 can always be recovered from the mixtures with S_2Cl_2 and Cl_2 that form on prolonged standing by distillation with PCl_3 .

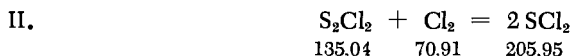

The substance can also be prepared starting directly with S_2Cl_2 . Otherwise, the procedure is the same as in method I.

SYNONYM:

Sulfur dichloride.

PROPERTIES:

Dark-red liquid with a pungent, chlorinelike odor; it decomposes readily, reversing reaction II, to form S_2Cl_2 and Cl_2 ; sensitive to atmospheric moisture. M.p. -121°C , b.p. $+59.6^\circ\text{C}$; d (20°C) 1.621.

Reacts with water with precipitation of sulfur and formation of $\text{H}_2\text{S}_2\text{O}_3$, $\text{H}_2\text{S}_{11}\text{O}_6$ and H_2SO_4 ; soluble in n-hexane without decomposition.

REFERENCES:

H. Jonas and H. Stöhr, unpublished, private communication.
See also *Naturforschung und Medizin in Deutschland 1939-1946* (FIAT-Review), 23, 191.

Dichlorodisulfane

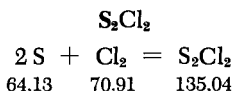

Sulfur is melted in a flask equipped with a side arm and a neck elongated into a gradually narrowing tube. By tilting the flask, the

walls are coated with a uniform layer of sulfur melt. After cooling, the flask is mounted vertically in such a way that the tube end passes through a rubber stopper into another flask below. From the latter, a gas outlet tube passes through a drying tube directly to the hood. A moderately rapid stream of carefully dried Cl_2 is introduced through the side arm of the top flask and the walls of that flask are simultaneously heated to $50\text{--}80^\circ\text{C}$ by fanning with a flame. Once the reaction is in progress, the S_2Cl_2 product flows into the lower flask in a rapid succession of drops. The orange-red substance is still contaminated by dissolved starting materials. Some sulfur is added and it is distilled at atmospheric pressure. The portion which distills above 137°C is refractionated over sulfur at about 12 mm. in an apparatus with ground glass joints; b.p. of the pure product is $29\text{--}30^\circ\text{C}$ at this pressure.

This material is used on a large scale in industry as a solvent for sulfur in the vulcanization of rubber.

SYNONYMS:

Disulfur dichloride; older designations "sulfurous chloride" and "sulfur monochloride."

PROPERTIES:

Golden yellow, oily liquid; when less pure, orange to reddish because of SCl_2 impurities; fumes in moist air, unpleasant pungent odor. M.p. -77°C , b.p. (760 mm.) $+138^\circ\text{C}$; d (20°C) 1.6773.

Hydrolyzes with water to form HCl , SO_2 and H_2S ; these then convert to S , $\text{H}_2\text{S}_2\text{O}_3$ and $\text{H}_2\text{S}_n\text{O}_6$. Readily soluble in CS_2 .

REFERENCE:

Abegg, Handbuch der anorganischen Chemie, Vol. IV, 1, p. 287.

Dichlorotri-, -tetra-, -tenta-, -hexa-, -hepta- and -octasulfane



If the ratios of the reactants are reversed, then the general synthetic method used in the preparation of the sulfanes (p. 353) can also be used for the preparation of the chlorosulfanes. The sulfane component is added to an excess of chlorosulfane at low temperature and after the reaction

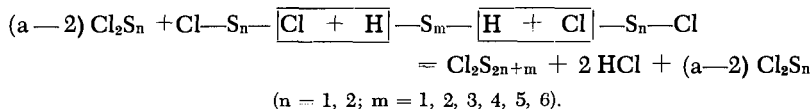

is complete, excess chlorosulfane $(a-2)\text{Cl}_2\text{S}_n$ is distilled off.

With suitable choice of reactants and careful following of

analogous preparative conditions, it is possible to obtain pure S_3Cl_2 , S_4Cl_2 , S_5Cl_2 , S_6Cl_2 , S_7Cl_2 and S_8Cl_2 .

In general, the chlorosulfanes are best made from the following components:

Desired chlorosulfane	Chlorosulfane component	Sulfane component
S_3Cl_2	SCl_2	H_2S
S_4Cl_2	SCl_2	H_2S_2
S_5Cl_2	S_2Cl_2	H_2S
	or SCl_2	H_2S_3
S_6Cl_2	S_2Cl_2	H_2S_2
	or SCl_2	H_2S_4
S_7Cl_2	S_2Cl_2	H_2S_3
S_8Cl_2	S_2Cl_2	H_2S_4

The same rules as those for the preparation of sulfanes (p. 349) apply for these procedures, particularly as far as cleaning the glass equipment is concerned.

The syntheses of S_3Cl_2 and S_4Cl_2 are described as examples.

Dichlorotrisulfane

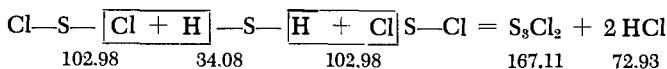

Excess SCl_2

The two-liter, three-neck flask *a* of Fig. 161, equipped with a Hg-seal stirrer, is charged with 2400 g. of freshly distilled SCl_2 and is cooled with stirring to -80°C in a large Dewar flask filled with Dry Ice-methanol mixture; the flask must be completely immersed in the cooling bath. The $CaCl_2$ tube *b* prevents penetration of atmospheric moisture. About 45 ml. of previously condensed H_2S (compare preparation of tetrasulfane, p. 353) is combined with the SCl_2 at about -80°C by attaching the trap filled with liquid H_2S directly to the somewhat inclined ground glass joint *c* and emptying it by slow rotation of the male ground glass joint. The reaction, barely visible from the outside, is complete in 12-14 hours; the

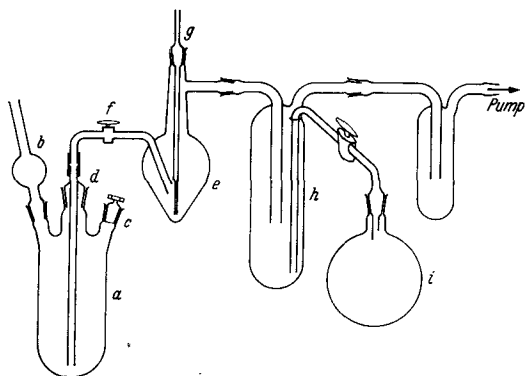

Fig. 161. Preparation of dichlorotrisulfane.

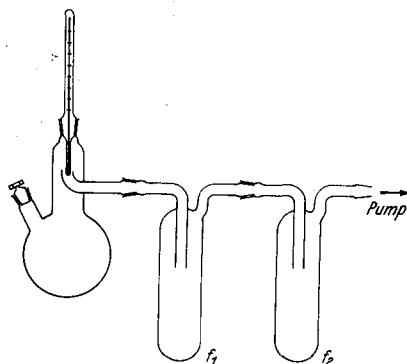

Fig. 162. Distillation of dichlorotrisulfane.

cooling bath is then removed and the solution allowed to warm slowly to about 0°C with constant stirring.

After most of the dissolved HCl has escaped, an accurately fitting riser tube is placed on the middle ground glass joint d , as shown in Fig. 161. This tube is connected to the side arm of distillation flask e by means of a short piece of rubber tubing. Flask e is then evacuated with an aspirator. The input of the reaction mixture to e is regulated by means of stopcock f . The distillation flask is heated with a small burner and dry, purified N_2 is introduced through the capillary g to aid the boiling. The 500-ml. trap h , cooled with a Dry Ice-methanol bath, can be emptied from time to time into flask i through the sealed-in siphon by briefly releasing the aspirator vacuum. After the bulk of the solvent is removed — two hours are needed to distill off two liters of SCl_2 — the product is transferred into the two-neck flask of the high-vacuum apparatus

shown in Fig. 162. Here the remaining solvent is removed and collected in the liquid-nitrogen-cooled trap at the pump (not shown in the diagram). Only then is \mathcal{J}_1 cooled with an ice-water bath and \mathcal{J}_2 with a Dry Ice-methanol bath. The flask is then heated on a water bath of 40–50°C; the S_3Cl_2 slowly distills and mostly condenses in \mathcal{J}_1 (b.p. 30.5°C at 10^{-4} mm.).

In this manner, about 100 g. of S_3Cl_2 may be distilled in five hours. The yield of pure S_3Cl_2 is 50%.

A simplified procedure for the continuous preparation of larger quantities of dichlorotrisulfane was developed by S. Fehér and J. Göebell.

Dichlorotetrasulfane

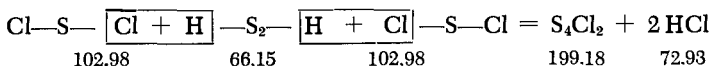

Excess SCl_2

The apparatus is the same as that for the preparation of dichlorotrisulfane; only the manner of adding the sulfane component is different.

The three-neck flask α , cooled to -80°C with Dry Ice-methanol mixture, contains 1200 g. of freshly distilled SCl_2 . A separatory funnel, whose tube is drawn into a capillary, is inserted into the ground joint c . About 26 g. of H_2S_2 is added slowly in drops from this funnel over a period of one to two hours. Good agitation of the flask contents must be provided. The reaction is complete in about three hours.

The rest of the procedure is analogous to that for the preparation of S_3Cl_2 . The residue, a clear, orange-red liquid, is freed of traces of SCl_2 in a smaller flask by short standing in high vacuum; it is then nearly pure so that, in contrast to S_3Cl_2 , distillation is not necessary. The yield is 90%.

The distillation, which involves experimental difficulties, is unnecessary even in the case of higher chlorosulfanes. However, preparations of dichloropenta- and dichlorohexasulfane require about 12 hours for completion, using 25 g. of H_2S_3 and 40 g. of H_2S_4 , respectively.

Reaction of about 450 g. of S_2Cl_2 with approximately 10 g. of H_2S (10 g. of H_2S_2 , H_2S_3 or H_2S_4) produces S_5Cl_2 (S_6Cl_2 , S_7Cl_2 , S_8Cl_2). The course of the reaction and the reaction rates are similar to the case in which SCl_2 is used.

PROPERTIES:

Starting with S_3Cl_2 , the higher chlorosulfanes are orange-red, oily liquids with high refractive indexes. They have the same odor as S_2Cl_2 but the intensity of their odor decreases rapidly with increasing molecular weight.

	Formula weight	d (20°C)
S_3Cl_2	167.09	1.7441
S_4Cl_2	199.15	1.7774
S_5Cl_2	231.21	1.8018
S_6Cl_2	263.27	1.8219
S_7Cl_2	295.33	1.84
S_8Cl_2	327.39	1.85

In this homologous series, the density of the last two members can only be obtained by extrapolation because of their increased viscosity and decreased purity compared to the first members.

REFERENCES:

- F. Fehér and L. Meyer, *Z. Naturforsch.* **11b**, 605 (1956).
 F. Fehér, K. Naused and H. Weber, *Z. anorg. allg. Chem.* **290**, 303 (1957).
 F. Fehér and S. Ristić, *Z. anorg. allg. Chem.* **293**, 307 (1958).
 F. Fehér and J. Goebell, *Z. anorg. allg. Chem.*, in press.

Sulfur Tetrachloride

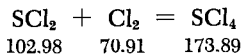

Leg *A* of the apparatus shown in Fig. 163 is filled to about one third with pure SCl_2 and then sealed off at *C*. The stoichiometric quantity of Cl_2 is then condensed in the graduated tube *B*, cooled with a Dry Ice bath. The tube is then sealed off at *D*. Leg *A* is then also cooled to $-78^\circ C$ and the apparatus is tilted so that the SCl_2 flows quickly into the Cl_2 in *B*. The mixture is vigorously shaken. It solidifies immediately, forming white (occasionally pale yellow) SCl_4 .

The product can be stored only in sealed tubes at low temperatures.

The analogous preparation from S_2Cl_2 and liquid Cl_2 is not recommended since the formation of the intermediate SCl_2 proceeds very slowly in the absence of a catalyst, and the reaction therefore takes several days.

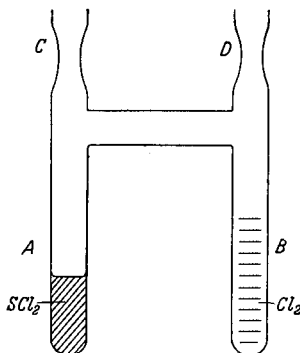

Fig. 163. Preparation of sulfur tetrachloride.

PROPERTIES:

Fine white powder; stable only as a solid at low temperatures; decomposes above -30°C into SCl_2 and Cl_2 ; sensitive to moisture. Solid SCl_4 sinters at -30°C and melts between -30 and -20°C with simultaneous decomposition.

Hydrolyzed by water to HCl and SO_2 .

REFERENCES:

E. Beckmann, *Z. phys. Chem.* 65, 289 (1909).

See also O. Ruff, *Ber. dtsh. chem. Ges.* 37, 4513 (1904).

Dibromodisulfane



I.

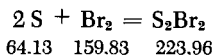

The procedure is based on that described by Ruff and Winterfield. Thus, 94 ml. of Br_2 is slowly added to 119 g. of S (recrystallized from CS_2) in a dry 500-ml. pressure flask capable of withstanding 20 atm. of internal pressure. (If proper precautions are observed, a beer bottle can be used.) The mixture is heated for two hours on a steam bath. The dark-red liquid product is distilled at 0.1 mm. The first cut contains primarily unreacted Br_2 ; the main fraction distilling between 46 and 48°C is pure S_2Br_2 , while crystalline S remains in the distillation flask.

The yield averages 80%.

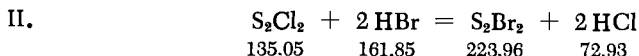

The reaction is carried out in the apparatus shown in Fig. 164. Hydrogen bromide is produced by allowing Br_2 to drip into tetralin (see p. 282 for this procedure); to remove traces of elemental bromine, the HBr is passed through a wash bottle containing tetralin, through a U tube containing clay fragments and moist red P, and finally through two CaCl_2 drying tubes. This prepurified gas is then bubbled at room temperature through about 30 g. of dichlorodisulfate (see p. 371), contained in a 250-ml. two-neck flask, in such a way that the contents are well mixed. The course of the slightly exothermic reaction can be followed through the gradual coloration of the oil to a dark red. The reaction is complete after 1-2 hours, as confirmed by qualitative testing of the product for chlorine. During the reaction, the excess HBr and the HCl produced are discharged to the hood via a CaCl_2 tube.

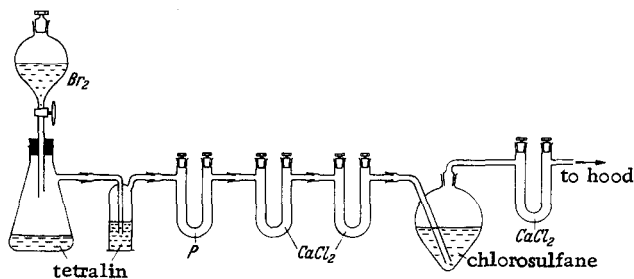

Fig. 164. Preparation of dibromodisulfane.

SYNONYM:

Disulfur dibromide. Older names "sulfur monobromide" and "sulfurous bromide."

PROPERTIES:

Dark red, oily liquid which does not wet glass. M.p. -46°C ; dissociates on heating into the elements and therefore can be distilled without decomposition only in high vacuum, d. (20°C) 2.629. In H_2O , hydrolyzes to HBr, SO_2 and S. Soluble in CS_2 , CCl_4 and C_6H_6 .

REFERENCES:

- I. O. Ruff and G. Winterfield, Ber. dtsh. chem. Ges. 36, 2437 (1903); F. Fehér, J. Kraemer and G. Rempe, Z. anorg. allg. Chem. 279, 18 (1955).
- II. F. Fehér and G. Rempe, Z. anorg. allg. Chem. 281, 161 (1955); F. Fehér and S. Ristić, Z. anorg. allg. Chem. 293, 311 (1958).

Dibromotri-, -tetra-, -tenta-, -hexa-, -hepta- and -octasulfane

$\text{S}_3\text{Cl}_2 + 2 \text{HBr} = \text{S}_3\text{Br}_2 + 2 \text{HCl}$
167.11 161.85 256.03 72.93
$\text{S}_4\text{Cl}_2 + 2 \text{HBr} = \text{S}_4\text{Br}_2 + 2 \text{HCl}$
199.18 161.85 288.10 72.93
$\text{S}_5\text{Cl}_2 + 2 \text{HBr} = \text{S}_5\text{Br}_2 + 2 \text{HCl}$
231.24 161.85 320.16 72.93
$\text{S}_6\text{Cl}_2 + 2 \text{HBr} = \text{S}_6\text{Br}_2 + 2 \text{HCl}$
263.31 161.85 352.23 72.93
$\text{S}_7\text{Cl}_2 + 2 \text{HBr} = \text{S}_7\text{Br}_2 + 2 \text{HCl}$
295.38 161.85 384.29 72.93
$\text{S}_8\text{Cl}_2 + 2 \text{HBr} = \text{S}_8\text{Br}_2 + 2 \text{HCl}$
327.44 161.85 416.36 72.93

These bromosulfanes are prepared in a manner analogous to S_2Br_2 (method II), using the same apparatus. About 30 g. of chlorosulfane is used.

PROPERTIES:

The color of the bromosulfanes lightens with increasing chain length: S_2Br_2 is dark red, S_8Br_2 only raspberry red. All bromosulfanes are completely miscible with CS_2 . Only the oils containing less sulfur than S_4Br_2 are soluble in benzene, toluene and carbon tetrachloride.

d (20°C)

S_3Br_2	2.52
S_4Br_2	2.47
S_5Br_2	2.41
S_6Br_2	2.36
S_7Br_2	2.33
S_8Br_2	2.30

REFERENCES:

See S_2Br_2 (II).

Lower Sulfur Oxides

See the original literature for the preparation of these compounds.

REFERENCES:

- P. W. Schenk and H. Platz, *Z. anorg. allg. Chem.* 215, 113 (1933).
 P. W. Schenk and H. Triebel, *Z. anorg. allg. Chem.* 229, 305 (1936).
 P. W. Schenk, *Chem. Ztg.* 67, 251, 273 (1943).
 M. Goehring and K. D. Wiebusch, *Z. anorg. allg. Chem.* 257, 227 (1948).
 F. Thomo and E. Böhm, *Monatsh. Chem.* 81, 907 (1950).
 A. Vallance-Jones, *J. Chem. Phys.* 18, 1263 (1950).
 P. W. Schenk, *Z. anorg. allg. Chem.* 265, 169 (1951).
 G. St. Pierre and J. Chipman, *J. Amer. Chem. Soc.* 76, 4787 (1954).
 D. J. Meschi and R. J. Meyers, *J. Amer. Chem. Soc.* 78, 6220 (1956).
 A. J. Myerson, F. R. Taylor and P. J. Hanst, *J. Chem. Phys.* 26, 1309 (1957).
 P. W. Schenk and W. Holst, *Angew. Chem.* 70, 405 (1958).

Disulfur Trioxide

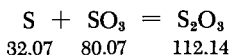

The Pyrex apparatus (Fig. 165) consists of distillation flasks *A*, *B* and *C* (300 ml. each), reaction vessel *D*, and U tube *K*, filled with a P_2O_5 -glass wool mixture. To start the run, about 1 g. of carefully purified S (see p. 341) is charged into vessel *D* through ground glass joint *J*, and 200 ml. of pure, 65% oleum is placed in the flask *A*. Then *A* is heated very slowly in an H_2SO_4 bath while *B* is cooled in an ice-water bath and *C* with an ice-salt bath. Most of the SO_3 condenses in *B* and only a small amount passes into *C*. As soon as all the SO_3 which can be removed from the acid by gentle heating is evaporated, flask *A* is allowed to cool and is then

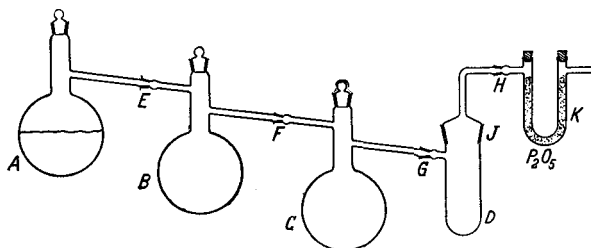

Fig. 165. Preparation of disulfur trioxide.

disconnected at joint *E*; the latter is immediately closed off. About three quarters of the SO_3 in *B* is then distilled into *C* in the same manner by cooling *C* with ice water and *D* with an ice-salt mixture. Flask *B* is then disconnected at *F*. If the product collected in *C* is not yet sufficiently pure (it should melt at $15\text{--}16^\circ\text{C}$ to a colorless liquid), it must be redistilled using flasks *A* and *B* (which are meanwhile cleaned and dried). To achieve the reaction, the SO_3 in *C* is heated until it melts, and 15 ml. of the melt is allowed to deposit on the sulfur in *D* by rotating the flask in the ground glass joint *G*. The mixture instantaneously turns a deep blue. A vigorous reaction starts after 30 seconds, evolving white vapors. It is then advisable to disconnect the P_2O_5 tube at *H* from time to time. It is important to maintain the flask contents at approximately 15°C at all times. Above that temperature, the product S_2O_3 is markedly decomposed, while at lower temperatures the excess SO_3 solidifies. If this happens, separation of the SO_3 becomes very difficult and is accompanied by partial decomposition of the S_2O_3 .

The reaction subsides after about two minutes. The mixture is then thoroughly shaken and allowed to stand for five minutes. The solid bluish-green S_2O_3 settles to the bottom and the almost colorless SO_3 above it can be poured back into flask *C* by careful tipping. Adhering traces of SO_3 are removed by subsequent warming in a vigorous CO_2 stream. The initial temperature for this operation is 50°C , which later is reduced to 40°C . When almost all the SO_3 is removed; the contents are rapidly poured into a second dry vessel of the same type and CO_2 is again introduced; the ground glass cap is lifted from time to time and the crystal mass carefully crushed with a glass rod. The surface of the otherwise blue substance begins to turn brown after quantitative removal of the SO_3 . Carbon dioxide is then passed over the product for a further 20 minutes. The temperature should not exceed $+10^\circ\text{C}$. Following this operation, the product has the theoretical composition. The yield is about 3 g.

Disulfur trioxide must be stored below $+15^\circ\text{C}$ in a dry, oxygen-free atmosphere at pressures below 1 mm., but even under these conditions it is stable for only a few hours.

PROPERTIES:

Blue-green, crystalline substance; extremely hygroscopic; decomposes readily, particularly above $+15^\circ\text{C}$, into SO_2 , SO_3 and S. Reacts with water with fizzing to form S, H_2SO_4 and $\text{H}_2\text{S}_n\text{O}_6$.

Soluble in oleum, giving a deep blue or brown color, depending on the SO_3 content of the acid; insoluble in pure SO_3 .

REFERENCES:

- I. Vogel and J. R. Partington, J. Chem. Soc. (London) 127, 1514 (1925).

L. Wöhler and O. Wegwitz, *Z. anorg. allg. Chem.* **213**, 129 (1933).

Polysulfur Peroxide



See the original literature for the preparation of this compound.

U. Wannagat and G. Mennicken, *Z. anorg. allg. Chem.* **268**, 69 (1952).

U. Wannagat and J. Rademachers, *Z. anorg. allg. Chem.* **286**, 81 (1956).

Thionyl Chloride

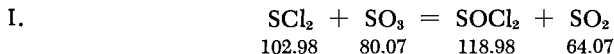

Flask *A* of the apparatus in Fig. 166 is charged with pure 65% oleum, flask *B* with 100 g. of SCl_2 (see p. 370). Flask *A* is slowly heated in an H_2SO_4 bath, while *B* is cooled with an ice-water bath. The stoichiometric quantity of SO_3 is thus gradually distilled onto the SCl_2 . The reaction proceeds with SO_2 evolution (use a hood!). Partial solidification of the flask contents frequently occurs at the beginning. However, the contents should again be completely liquid when the addition is completed. If necessary, the flask is heated at the end for a short time on a water bath. Flask *A* is then disconnected, the ground joint at *C* is stoppered, and the mixture is slowly distilled through a column (use a hood!). The mixture must be protected from contact with atmospheric moisture. The middle fraction is further purified by repeated careful fractionation, with S added to the distillation charge in order to convert all sulfur chlorides present to S_2Cl_2 . The contents are distilled through an efficient column until a completely colorless product, coming over at 76–77°C, is obtained. The yield is about 80% of theoretical.

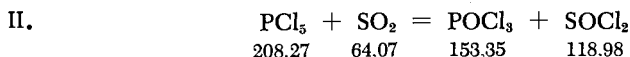

A well-dried, 250-ml., two-neck, round-bottom flask, equipped with a reflux condenser connected to a CaCl_2 tube, is loaded with 100 g. of PCl_5 . Sulfur dioxide is introduced through a gas inlet tube extending to the bottom of the flask. The SO_2 is carefully

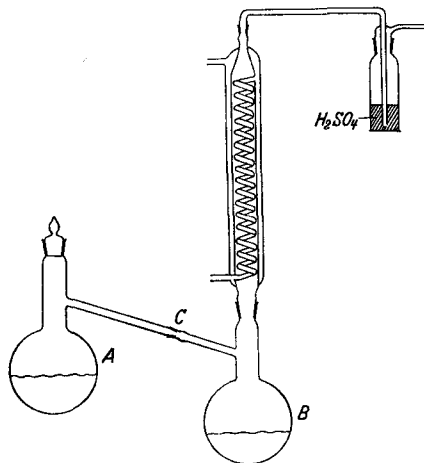

Fig. 166. Preparation of thionyl chloride.

predried by allowing it to bubble through two wash bottles containing concentrated H_2SO_4 . The reaction, which can be accelerated by shaking the flask, is complete after several hours, when all the PCl_5 dissolves.

The products are separated by repeated careful fractionation, using an efficient column. B.p. of SOCl_2 , 77°C ; of POCl_3 , 108°C .

This preparation is generally not completely free of phosphorus compounds. The yield of SOCl_2 is 30 g. (50% of theoretical).

PROPERTIES:

Colorless, highly refractive liquid with an unpleasant, SO_2 -like odor. M.p. -104.5°C , b.p. 77°C ; d_4^{20} 1.64. Significant dissociation to S_2Cl_2 , SO_2 and Cl_2 occurs just above the boiling point. Hydrolyzes in water to SO_2 and HCl ; soluble in benzene and chloroform.

REFERENCES:

- I. A. Michaelis, *Liebigs Ann. Chem.*, **274**, 173 (1893).
- II. H. Grubitsch, *Anorganisch-präparative Chemie*, Vienna, 1950, p. 294.

Sulfuryl Chloride



a) The reaction proceeds very smoothly and almost quantitatively when activated charcoal is used as the catalyst.

The reactor is a bulb-type condenser with at least six bulbs. Each bulb is approximately half filled with loose glass wool, on top of which there is a layer of granular activated charcoal which occupies less than half of the remaining space. The condenser is clamped vertically; the lower end passes through a rubber stopper and into a suction flask (500-1000 ml.) with its side arm connected to a CaCl_2 tube in order to protect the contents against atmospheric moisture. Tank Cl_2 and SO_2 are used, if possible, since this is the simplest way to keep the flow rates constant over long periods. The gases are dried separately by passage through wash bottles filled with concentrated H_2SO_4 . These bottles also serve as bubble counters. The gases are then mixed in a Y piece and fed into a flask in which the mixing is completed. When all the air is displaced, the outlet tube of this flask is tightly joined to the upper end of the reactor by means of a rubber stopper. The reactor is well cooled with externally flowing water. At flow rates of 3-4 bubbles/second in both wash bottles, the first SO_2Cl_2 drops begin to collect in the suction flask after 20-30 minutes. (The induction period can be shortened by moistening the uppermost sphere with a few milliliters of SO_2Cl_2 .) From then on, about 150 g. of SO_2Cl_2 is formed per hour. This amount can be increased by increasing the flow rate. The product obtained is quite pure and needs to be fractionated only once at atmospheric pressure, which decreases the yield only slightly.

b) The reaction also proceeds smoothly when camphor is used as the catalyst.

A 500-ml., two-neck, ground-joint flask is provided with a CaCl_2 tube and a gas inlet tube reaching to the bottom. A tee connection allows simultaneous introduction of SO_2 and Cl_2 .

Coarse camphor (10 g.) is placed in the flask, and well-dried SO_2 is passed through until the camphor is saturated and liquefies (1 part of camphor absorbs about 0.88 parts by weight of SO_2 at 725 mm.). Dried Cl_2 is then introduced; it is absorbed by the liquid, forming a colorless solution. After saturation, the SO_2 is reintroduced, followed by renewed passage of Cl_2 . After the formation of approximately 30 g. of sulfuryl chloride, both gases may be introduced simultaneously.

When enough SO_2Cl_2 has been prepared, it is distilled on a water bath. The product obtained in the first distillation still contains camphor, which may be removed by careful fractionation.

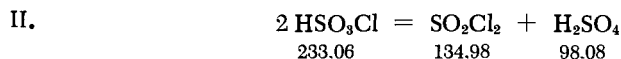

An ordinary combustion tube is half filled with pure chloro-sulfonic acid (for preparation, see p. 385), is sealed off in the usual

way and is then heated in a paraffin or oil bath for 20 hours at 200–210°C. The initially water-clear liquid takes on a greenish color on cooling. The tube is opened with the usual precautions, the liquid is rapidly poured into a flask, and the fraction boiling below 110°C is distilled off. This fraction is redistilled on a water bath and the fraction boiling below 73°C is collected; it consists mainly of SO_2Cl_2 . To remove HSO_3Cl and H_2SO_4 , the product is poured into a separatory funnel filled with crushed ice and is briefly shaken; the lower, cloudy organic layer is removed. This layer is dried for some time in a desiccator over P_2O_5 and is finally re-fractionated on a water bath at atmospheric pressure. The middle fraction, boiling between 69 and 70°C, is pure SO_2Cl_2 . The yield is about 40%.

PROPERTIES:

Colorless, very mobile liquid; yellows slightly on prolonged standing because of partial dissociation; fumes somewhat in air; extremely pungent odor. M.p. -54.1°C , b.p. 69.2°C ; d_4^{20} 1.667.

Decomposes gradually in water to form H_2SO_4 and HCl ; under certain circumstances, decomposes explosively with alkalis. Soluble in benzene and toluene.

REFERENCES:

- I. a) J. Meyer, *Angew. Chem.* 44, 41 (1931); see also H. Danneel, *Angew. Chem.* 39, 1553 (1926).
b) H. Schulze, *J. prakt. Chem.* 24, 168 (1881).
- II. P. Behrend, *J. prakt. Chem.* 15, 23 (1877).

Chlorosulfonic Acid

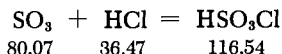

A round-bottom flask, closed with a three-hole rubber stopper, is half filled with oleum of the highest SO_3 concentration possible. A gas inlet tube, reaching to the bottom of the flask, passes through one of the holes of the stopper, a thermometer through the second and a downward condenser ending in a CaCl_2 tube through the third. At the beginning of the run, the flask is inclined so that the condenser points upward. Thus, all products condensing during the reaction flow back into the flask. A slow, carefully dried HCl stream (see p. 280) is then passed through the oleum at room

temperature until no further absorption takes place. The condenser is then returned to its downward position and the flask contents are distilled in the HCl stream. The reaction must be protected against atmospheric moisture. The fraction coming over between 145 and 160°C is refractionated in the same manner in a clean apparatus with ground glass connections. A colorless distillate, stable for long periods of time, can be obtained only in the complete absence of organic substances (rubber, cork, dust, etc.). The boiling point of the pure middle fraction is 151-152°C. The yield is almost quantitative, based on the SO₃ content of the oleum.

Because of slight dissociation on heating, the product contains some dissolved HCl and SO₃, as well as traces of SO₂, Cl₂, SO₂Cl₂ and H₂SO₄ formed from the above. Completely pure HSO₃Cl is obtained by fractional crystallization in liquid nitrogen in complete absence of moisture. (For more details, see the original literature.)

PROPERTIES:

Colorless liquid, fuming strongly in moist air; pungent odor. M.p. -80°C, b.p. 152°C; d (20°C) 1.79.

Decomposes violently with water to form HCl and H₂SO₄.

REFERENCES:

C. R. Sanger and E. R. Riegel, *Z. anorg. allg. Chem.* 76, 79 (1912). See also H. Beckurts and R. Otto, *Ber. dtsh. chem. Ges.* 11, 2058 (1878).

A. Simon and G. Kratsch, *Z. anorg. allg. Chem.* 242, 369 (1939).

Pyrosulfuryl Chloride

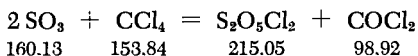

The apparatus, consisting of a one-liter flask equipped with a long reflux condenser topped with a drying tube, is set up under an efficient hood because of the ensuing COCl₂ evolution. Commercial SO₃ (300 g.) is placed in the flask and CCl₄ (572 g.) is poured over it. The reaction rate is very low while the flask contents are cold. The flask is carefully heated on a sand bath until all the SO₃ dissolves and the brown liquid which forms no longer evolves any COCl₂. The reaction usually ends in two hours. The contents of the flask are then slowly distilled through a column protected from atmospheric moisture (use a hood!) and the fraction boiling between

135 and 160°C, consisting of crude $S_2O_5Cl_2$ contaminated with some H_2SO_3Cl , is collected separately. To purify the compound, small pieces of ice are added while the flask is rapidly rotated and efficiently cooled with an ice-salt bath; the ice vigorously hydrolyzes the H_2SO_3Cl , evolving HCl , while the $S_2O_5Cl_2$ is not attacked to any significant extent. As soon as the gas evolution subsides, the addition of ice is stopped, the flask is allowed to stand for several hours in the cooling bath, and the cold liquid, which by then has separated into two layers, is poured into a separatory funnel. Here the $S_2O_5Cl_2$ may become either the upper or the lower layer since the densities of the two phases are very similar. However, a separation with $S_2O_5Cl_2$ collecting in the bottom layer is easily attained by addition of some concentrated H_2SO_4 or cold water. The product is dried with P_2O_5 and distilled, while carefully protected from atmospheric moisture, at atmospheric pressure. The fraction distilling between 150 and 153°C is refractionated at reduced pressure. The yield is about 240 g. of pure $S_2O_5Cl_2$.

PROPERTIES:

Colorless, very mobile liquid; characteristic odor; fumes faintly in moist air and becomes cloudy because of the separation of sulfuric acid. M.p. $-37^\circ C$, b.p. $152-153^\circ C$ with slight decomposition; dissociates into SO_3 , SO_2 and Cl_2 on prolonged refluxing or heating to $250^\circ C$; d_4^{20} 1.84; d_4^{25} 1.87.

Hydrolyzes in water, particularly when warm, to H_2SO_4 and HCl .

REFERENCES:

- W. Prandtl and P. Borinski, *Z. anorg. allg. Chem.* **62**, 24 (1909).
 C. R. Sanger and E. R. Riegel. *Z. anorg. allg. Chem.* **76**, 79 (1912).

Thionyl Bromide

$SOBr_2$

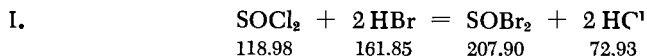

Pure $SOCl_2$ (50 ml.) (see p. 382) is placed in a 150-ml. ground glass flask provided with a gas inlet tube reaching to the bottom and sealed in at the side. The flask is equipped with a reflux condenser closed off with a $CaCl_2$ drying tube. A moderately rapid stream of carefully dried HBr is bubbled through for 12 hours while

the flask is cooled with ice. The contents gradually turn reddish. At the end of the reaction, the product mixture is distilled in ground glass apparatus at 62 mm.; about 50 ml. of orange-red crude SOBr_2 distills between 69 and 70°C. This crude is re-fractionated at 20 mm.; b.p. of the pure orange-yellow substance is 48°C. The yield is nearly quantitative.

Stored in sealed glass ampoules or in flasks with very tight ground glass stoppers.

Other preparative methods:

II. Reaction of SO_2 with Br_2 in the presence of PCl_3 : 64 g. of SO_2 is added to a mixture of 138 g. of PCl_3 and 160 g. of Br_2 , while the reactor is cooled. The yield, after fractional distillation, is 180 g. of SOBr_2 .

III. When 1 mole of SOCl_2 is added dropwise to a solution of 2.1 moles of KBr in 150 ml. of liquid SO_2 , SOBr_2 separates as a white precipitate. After evaporation of the SO_2 , the product is distilled at 20°C and 0.1 mm. into a trap at -80°C. The yield is about 50%.

PROPERTIES:

Orange-yellow liquid. On prolonged standing, slowly decomposes into SO_2 , Br_2 and S_2Br_2 and turns reddish; very sensitive to moisture. M.p. -49.5°C. Its thermal stability is poor and therefore SOBr_2 can be distilled only in vacuum. d. (20°C) 2.685.

Hydrolyzes in water to HBr and SO_2 . Soluble in CS_2 , C_6H_6 , CHCl_3 and CCl_4 .

REFERENCES:

- I. H. Hibbert and J. C. Pullman in: H. S. Booth, *Inorg. Syntheses*, Vol. I, p. 113, New York-London 1939; H. A. Mayes and J. R. Partington, *J. Chem. Soc. (London)* 1926, 2594; see also F. Govaert and M. Hansens, *Natuurwetensch. Tijdschr.* 20, 77 (1938).
- II. German Pat. 665061 (1936) I. G. Farbenindustrie.
- III. M. J. Frazer and W. Gerrard, *Chem. and Ind.* 1954, 280.

Peroxymonosulfuric Acid

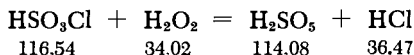

A slight excess of 100% (or at least nearly anhydrous) H_2O_2 (see p. 140) is slowly added to pure, thoroughly cooled chloro-

sulfonic acid (see p. 385). Vigorous evolution of HCl occurs. When all the H_2O_2 has been added and the gas evolution has subsided, the reaction mixture is gradually warmed and the dissolved or still evolving HCl is removed in aspirator vacuum. The mixture cannot be allowed to stand too long prior to HCl removal because the H_2SO_5 tends to oxidize the HCl to Cl_2 and to oxides of chlorine. The HCl-free liquid can then be crystallized in a well-sealed flask. If, after standing for some time at room temperature, it is still not solid, the flask is placed in a cooling bath. After 12 hours the crystals are separated from the mother liquor either by rapid suction filtration on a glass frit or by centrifuging in the apparatus shown in Fig. 103 (p. 141). The effectiveness of this separation determines the purity of the product, which is normally 94-97%. The impurities present are $\text{H}_2\text{S}_2\text{O}_8$ and traces of Cl. The substance can be further purified by partial remelting. The yield is 50-70%. A small additional fraction can be obtained from the mother liquor. The handling of large quantities of H_2SO_5 is somewhat dangerous. Local overheating, caused, for example, by addition of H_2O , can cause explosive decomposition. Safety glasses should always be worn.

SYNONYMS:

Hypersulfuric acid, Caro's acid.

PROPERTIES:

Colorless, beautiful crystals; hygroscopic; pure material stable for a few days, although with slight loss of active oxygen, the rate of decomposition is catalysed by the impurities formed; vigorous oxidizing agent. M.p. $+45^\circ\text{C}$ with slight decomposition.

Small amounts of H_2SO_5 dissolve in ice water without evolving oxygen or hydrolyzing. When larger amounts are used and the water is at room temperature, H_2O_2 and H_2SO_4 are formed. Readily soluble in alcohol and ether.

REFERENCES:

J. D'Ans and W. Friederich, Ber. dtsh. chem. Ges. 43, 1880 (1910); Z. anorg. allg. Chem. 73, 325 (1912).

Peroxydisulfuric Acid

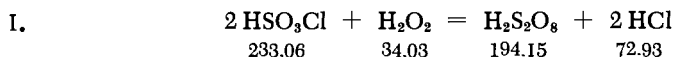

Pure chlorosulfonic acid (see p. 385) is mixed slowly and with efficient cooling with the stoichiometric quantity of 100% H_2O_2

(see p. 140 for preparation). The reaction proceeds with HCl evolution, which continues for some time after the end of the addition. When the gas evolution subsides, the solution is gradually heated, and both the dissolved and evolving HCl are removed with an aspirator. The liquid is allowed to stand in a closed flask; it usually solidifies slowly after some time at room temperature. The crystallization can be accelerated by cooling or seeding. The HCl evolution resumes during crystallization because the mother liquor becomes enriched with HSO_3Cl and H_2SO_5 . After 12 hours, the solid acid is quickly suction-filtered through a glass frit or is isolated by centrifuging in the apparatus shown in Fig. 103 (p. 141). The purity is 92-98%; the yield is 60% of theoretical. A fair amount of a somewhat less pure fraction may still be obtained from the mother liquor by lower cooling.

II. Aqueous solutions of $\text{H}_2\text{S}_2\text{O}_8$ are obtained by electrolysis of concentrated H_2SO_4 solutions at a high current density and low temperature. For details, see the original literature.

SYNONYMS:

Hypersulfuric acid, persulfuric acid.

PROPERTIES:

Colorless, finely crystalline substance; ozone odor; extremely hygroscopic; pure $\text{H}_2\text{S}_2\text{O}_8$ is stable for several weeks with only a slight loss of active oxygen, while the impure acid is considerably less stable; strong oxidizing agent. M.p. 65°C (dec.).

Dissolves in water, with fizzing and considerable decomposition, to yield H_2SO_5 and H_2O_2 ; soluble without decomposition in alcohol; less soluble in ether.

REFERENCES:

- I. J. D'Ans and W. Friederich, *Ber. dtsh. chem. Ges.* **43**, 1880 (1910); *Z. anorg. allg. Chem.* **73**, 325 (1912).
- II. K. Elbs and O. Schönherr, *Z. Elektrochem.* **2**, 245 (1895).

Ammonium Peroxydisulfate



Prepared by anodic oxidation of a saturated $(\text{NH}_4)_2\text{SO}_4$ solution:

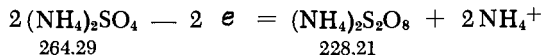

A clay cup with a capacity of 130 to 150 ml. is placed in a 500-ml. beaker of equal height. The cup is surrounded with a coil of

lead tubing which serves both as a cathode and a cooling coil. The current lead is a copper wire soldered to the coil. A 0.05-cm.-thick Pt wire spiral anode, ignited prior to the run, is suspended in the middle of the cup. A mixture of equal weights of concentrated H_2SO_4 and H_2O is used as the cathode liquid; the anode space is filled with an iron-free $(\text{NH}_4)_2\text{SO}_4$ solution, saturated at 10°C [76.3 g. of $(\text{NH}_4)_2\text{SO}_4$ in 100 g. of H_2O].

The cooling water flow is turned on, and the electrodes are connected through a rheostat and an ammeter to the 12-14 v. power supply. The current should be 2.5 amp. and the electrolyte temperature as low as possible. Slight evolution of O_2 can be observed at the anode; simultaneously, an ozone odor is apparent. After 4-6 hours, white crystalline $(\text{NH}_4)_2\text{S}_2\text{O}_8$ separates in the clay cup. The electrolysis is continued for some time and then the salt is suction-filtered on fritted glass. The remaining mother liquor is largely removed by pressing on clay. The product still contains a few percent of sulfate. To purify the compound, it is recrystallized (from as small an amount of water as possible) by dissolving at 40°C and then cooling an ice bath. The pure substance (negative test with BaCl_2) is dried on clay and in the desiccator. After 10 hours of electrolysis the yield is 33 g.

The anolyte liquid, saturated with $(\text{NH}_4)_2\text{S}_2\text{O}_8$, can be remixed with fresh $(\text{NH}_4)_2\text{SO}_4$ and reelectrolyzed. The catholyte is gradually neutralized by NH_4^+ and therefore must be tested with pH paper and replaced with fresh acid when necessary. After 3-4 hours, another 20-40 g. of $(\text{NH}_4)_2\text{S}_2\text{O}_8$ is obtained.

SYNONYM:

The older name is ammonium persulfate.

PROPERTIES:

Colorless, platelike or prismatic crystals; stable for months when pure and dry; decomposes in the presence of moisture, gradually evolving ozone-containing oxygen; strong oxidizing agent. Decomposes on heating, evolving O_2 and forming $(\text{NH}_4)_2\text{S}_2\text{O}_7$. d 1.98.

Solubility (0°C): 58.2 g.; (15.5°C) 74.8 g./100 g. H_2O . The solution decomposes slowly at room temperatures and rapidly at higher temperatures, evolving O_2 and forming NH_4HSO_4 .

Monoclinic crystals, space group C_{2h}^5 .

REFERENCES:

- E. Müller, *Elektrochemisches Praktikum* [Electrochemical Practice], 7th Ed., Dresden-Leipzig, 1947, p. 212.
K. Elbs, *J. prakt. Chem.* [2] 48, 185 (1893).

Potassium Peroxydisulfate



Prepared by electrolytic oxidation of saturated KHSO_4 solution:

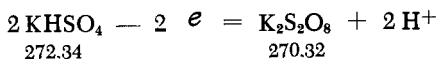

A 500-ml. battery jar, placed in a larger container which has an inlet and an outlet for cooling water, is used as the electrolysis vessel. The 1.4×4 cm. anode, a shiny Pt sheet, is suspended in the middle. Two Pt wire-gauze cathodes having over-all surface areas of 15 cm.^2 each are attached parallel to the anode, one on either side. The cathode-anode distance is 1.5 cm.

Before the run, the anode is ignited and the jar filled with dilute H_2SO_4 saturated with KHSO_4 . The electrodes are then connected through a rheostat and an ammeter with an 8-12 v. power supply. The anode current is adjusted to a density of 0.48 amp./cm.^2 (5.3 amp. for the given anode surface) and the electrolysis is carried out for a few hours with intensive external cooling. The temperature of the electrolyte should not exceed $+7^\circ$. The liquid turns cloudy after 10-15 minutes, due to separation of $\text{K}_2\text{S}_2\text{O}_8$. The salt gradually collects at the bottom of the vessel as a white, loose, very fine crystalline precipitate. It is suction-filtered (good vacuum) on fritted glass and washed with some water. Small amounts of occluded sulfuric acid are removed by repeated recrystallization from water at 30°C . The pure substance (negative test with BaCl_2) is dried by pressing on clay and in a desiccator over concentrated H_2SO_4 or CaCl_2 . After three hours of electrolysis, the yield is 27 g., corresponding to an electrolytic yield of 34%.

SYNONYM:

The older name is potassium persulfate.

PROPERTIES:

Colorless prisms or platelike crystals; only the completely dry material is stable for long periods; decomposes in moist air, forming KHSO_4 ; strong oxidizing agent. Evolves oxygen on heating. *d* 2.477.

Solubility in water (0°C): 1.62 g.; (10°C) 2.60 g.; (20°C) 4.49 g.; (30°C) 7.19 g. of $\text{K}_2\text{S}_2\text{O}_8/100$ g. of H_2O . The solution decomposes on prolonged standing, evolving O_2 and forming KHSO_4 .

Triclinic crystals, space group C_2^1 .

REFERENCE:

E. Müller and O. Friedberger, Z. Elektrochem. 8, 230 (1902).

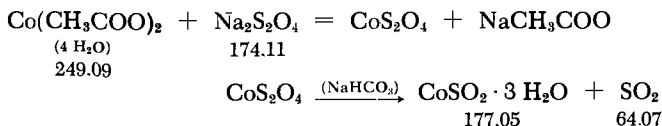
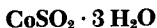
Cobalt Sulfoxylate

A solution of 10 g. of $\text{Co}(\text{CH}_3\text{COO})_2 \cdot 4\text{H}_2\text{O}$ in 60 ml. of water is mixed with 10.2 g. of solid $\text{Na}_2\text{S}_2\text{O}_4^*$ (Co : $\text{Na}_2\text{S}_2\text{O}_4$ = 1 : 1.5) while a fast stream of oxygen-free N_2 is passed through. A solution of 3.5 g. of NaHCO_3 in 50 ml. of H_2O (Co : NaHCO_3 = 1 : 1.1) is then gradually added in small portions. The cobalt salt solution turns red-brown, and a brown, finely powdered precipitate of $\text{CoSO}_2 \cdot 3\text{H}_2\text{O}$ separates, while CO_2 is evolved. The precipitate is rapidly suction-filtered in a nitrogen atmosphere, washed with water, alcohol and ether, and dried on clay in an evacuated desiccator previously flushed with N_2 .

PROPERTIES:

Brown powder. Decomposed by atmospheric oxygen or heat, forming cobalt sulfide. Soluble in NH_3 , pyridine and ethylenediamine, forming deep dark-red solutions.

REFERENCE:

R. Scholder and G. Denk, Z. anorg. allg. Chem. 222, 17 (1935).

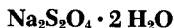
Sodium Dithionite

Sodium dithionite dihydrate is prepared by salting out an aqueous solution of commercial $\text{Na}_2\text{S}_2\text{O}_4$.

*This refers to 100% $\text{Na}_2\text{S}_2\text{O}_4$; commercial products are usually less pure.

A 20-25% solution of the purest obtainable $\text{Na}_2\text{S}_2\text{O}_4$ in air-free distilled H_2O is prepared in an inert gas atmosphere. The solution is filtered in the absence of air. Then 30 g. of finely powdered NaCl per 100 ml. of H_2O is quickly added and immediately vigorously shaken. After about half a minute, the dihydrate precipitates as a thick, white crystalline slurry. It is suction-filtered (again in the absence of air) and washed with saturated NaCl solution, then with aqueous and finally with anhydrous acetone. The crystals are dried on clay in an evacuated desiccator preflushed with nitrogen. Other salting-out agents include NaHSO_3 , NaOH , NaNO_2 , CH_3COONa , MgCl_2 , CaCl_2 and ZnCl_2 .

Because of its instability, the dihydrate has no practical uses; anhydrous $\text{Na}_2\text{S}_2\text{O}_4$ is used on a large scale as a reducing agent in the dye industry, for preparing rongalite ($\text{CH}_2\text{O} \cdot \text{Na} \cdot \text{HSO}_2 \cdot \text{H}_2\text{O}$) and as an O_2 absorbent.

SYNONYM:

The older designation is "sodium hyposulfite," while in industry it is called (incorrectly) "sodium hydrosulfite."

PROPERTIES:

Formula weight 192.13. Colorless, needle-shaped crystals; very air sensitive; decomposes particularly easily when moist, forming $\text{Na}_2\text{S}_2\text{O}_5$ and $\text{Na}_2\text{S}_2\text{O}_3$; strong reducing agent. Decomposes thermally to $\text{Na}_2\text{S}_2\text{O}_3$, Na_2SO_3 and SO_2 .

Readily soluble in water (2.18 g. of $\text{Na}_2\text{S}_2\text{O}_4 \cdot 2\text{H}_2\text{O}$ /100 g. of H_2O at 20°C); insoluble in ethanol.

REFERENCE:

K. Jellinek, Z. anorg. allg. Chem. 70, 93 (1911).

Zinc Dithionite

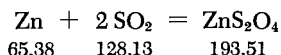

A two-liter round-bottom flask with a side arm reaching to the bottom and serving as gas inlet tube is used as the reactor. The flask carries an Anschütz attachment with a mercury-seal stirrer in one opening, while the other is closed with a one-hole rubber stopper with a cotton plug in the hole. In this manner a steady, positive SO_2 pressure is maintained in the flask.

The flask is charged with 750 ml. of ethanol, 250 ml. of H₂O and 270 g. of finely powdered, high-grade Zn dust. With vigorous stirring, 470 g. of pure SO₂ is introduced at 60°C. The reaction is exothermic. After a short time, a paste of coarsely crystalline ZnS₂O₄ begins to separate. When the reaction is complete, the mixture is allowed to cool and is then rapidly suction-filtered in a fast H₂ stream. The crystals are washed with absolute ethanol and dried in vacuum at 60-70°C. Acetone may be used for the washing. The yield is nearly quantitative but depends essentially on the composition of the zinc dust. The latter may be activated, if desired, by pretreatment with very dilute AgNO₃ solution.

SYNONYM:

The older designation is "zinc hyposulfite," while in industry it is frequently called "zinc hydrosulfite."

PROPERTIES:

White, crystalline powder; SO₂ odor, due to decomposition on standing in air (SO₂ evolution); strong reducing agent. Readily soluble in water (the ratio is about 1 : 7) with a strong tendency to form supersaturated solutions.

REFERENCES:

German patent 218 192 (1907) Badische Anilin- und Sodafabrik; Chemiker-Ztg. Rep. 31, 324 (1907).

Sodium Dithionate

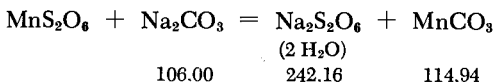
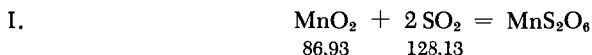
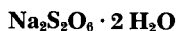

A one-liter round-bottom flask equipped with a stirrer, a thermometer and a gas inlet tube reaching to the bottom is used as the reactor. The flask is cooled in an ice bath and 500 ml. of H₂O is saturated with very pure SO₂. While the contents are vigorously stirred and the addition of SO₂ is continued, 80 g. of finely powdered, very pure MnO₂ is added in portions of 1-2 g. over a period

of 2.5-3 hours; the temperature of the mixture should not exceed 10°C. The stirring is continued for some time after the addition until there is no further color change. Excess SO₂ is removed in vacuum, while the flask is gently heated to 40°C. The gelatinous residue is filtered and washed with warm water.

The filtrate is combined with the wash water and stirred at 35-40°C with solid BaCO₃ until there is no further evolution of CO₂. The stirring is continued for another 10 minutes. The mixture is then neutralized to litmus with solid Ba(OH)₂. To test for completeness of removal of sulfate and sulfite, a filtered sample of the liquid is mixed with dilute HCl and BaCl₂ solution. If a precipitate is still formed, more hot saturated Ba(OH)₂ solution is added and the test is repeated. When the result is negative, the solution is suction-filtered and the precipitate washed with 50 ml. of water.

Approximately 65 g. of Na₂CO₃ is slowly added, in portions of 1-2 g., to the filtrate at 35°C. The mixture is vigorously stirred and the temperature increased to 45°C. As soon as a continuous test with litmus paper indicates a lasting, definitely alkaline reaction, addition of the Na₂CO₃ is interrupted and the mixture is suction-filtered and washed with 150 ml. of 50°C water containing some Na₂CO₃. The filtrate is retested with litmus paper and, if necessary, mixed with further Na₂CO₃ and filtered. The solution is concentrated on the water bath to a much smaller volume (discarding any precipitate which might separate at the beginning) and is then allowed to stand for some time at 10°C. The separated Na₂S₂O₈ · 2H₂O is suction-filtered (good suction, no washing) and dried by pressing on clay. Concentrating the solution too much causes contamination with Na₂CO₃. The yield is 88%, based on MnO₂ used.

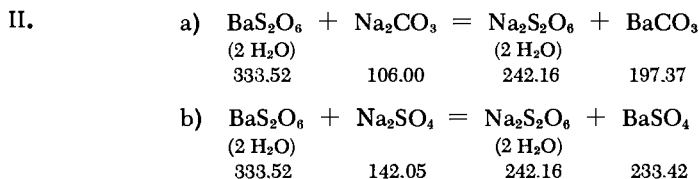

A hot solution of BaS₂O₈ · 2H₂O is mixed with the stoichiometric quantity of Na₂CO₃ or Na₂SO₄, also dissolved in hot water. After boiling for several hours, the precipitate is filtered off and the solution concentrated. Isolation and drying of the crystals is the same as in method I.

PROPERTIES:

Colorless, water-clear crystals; very stable in air. On heating, the water of crystallization is given off between 60 and 100°C;

above 200°C quantitative decomposition into Na_2SO_4 and SO_2 . d 2.19.

Readily soluble in water (at 0°C, 6.05; at 20°C, 13.39; at 30°C, 17.32 wt. % of salt is dissolved); insoluble in alcohol.

REFERENCES:

- I. R. Pfanstiel in: W. C. Fernelius, *Inorg. Syntheses*, Vol. II, p. 170, New York-London, 1946.
- II. W. C. de Baat, *Rec. Trav. Chim. Pays Bas* 45, 237 (1926).

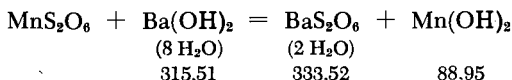
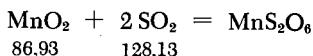
Barium Dithionate

A solution of MnS_2O_6 is prepared from sulfurous acid and MnO_2 in the manner described for $\text{Na}_2\text{S}_2\text{O}_6 \cdot 2\text{H}_2\text{O}$ (see above). The filtered clear solution is heated to 25-40°C and stirred with 160 g. of $\text{Ba}(\text{OH})_2 \cdot 8\text{H}_2\text{O}$ over a period of 30 minutes. Stirring is continued for 30 minutes after completion of the reaction. The solution is then heated to 65-75°C and enough base is added to make the mixture strongly alkaline. Very vigorous agitation is necessary during the addition of the base. The heating and agitation are continued for another 30 minutes. The separated hydrated oxide is filtered hot and washed with 300 ml. of $\text{Ba}(\text{OH})_2$ solution held at 65°C. The wash water is combined with the filtrate and retested for alkalinity. If the alkaline reaction is weak, more $\text{Ba}(\text{OH})_2 \cdot 8\text{H}_2\text{O}$ is added and the solution is refiltered. The excess base is then precipitated with CO_2 and filtered off. The solution is concentrated on a steam bath to about 50 ml. and cooled to crystallize. The $\text{BaS}_2\text{O}_6 \cdot 2\text{H}_2\text{O}$ precipitate is suction-filtered (the best vacuum possible—no washing!) and freed of traces of mother liquor by pressing on clay. Additional salt may be precipitated from the mother liquor by the addition of 75 ml. of ethanol. The yield is 73%, based on MnO_2 used.

PROPERTIES:

Colorless, monoclinic, prismatic crystals; stable in air. On heating, the water of crystallization is given off at 120°C. Significant

decomposition starts at 140°C (SO₂ evolution and formation of BaSO₄).

Readily soluble in water (at 0°C, 7.86; at 20°C, 15.75; at 30°C, 19.86 wt. % of salt is dissolved); insoluble in alcohol.

REFERENCE:

R. Pfanstiel in: W. C. Fernelius, *Inorg. Syntheses*, Vol. II, p. 170, New York-London, 1946.

Potassium Trithionate

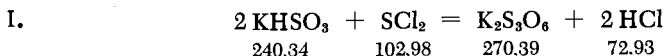

Sulfur dioxide is bubbled through 800 ml. of cooled 5M potassium hydroxide solution until the solution is converted to KHSO₃ (pH ~ 7). In the meantime, a solution of 100 g. of SCl₂ in 1.5 liters of pure petroleum ether is precooled to -20°C. The KHSO₃ solution is cooled to -5°C. It is then mixed in a 3- to 4-liter stoppered flask with 200-ml. portions of the SCl₂ solution. The liquid turns yellow in the process and must be decolorized before each new addition by thorough shaking. The temperature of the mixture should not rise above +10°C during the reaction. At the end of the addition the mixture is allowed to stand for some time at 0°C in order to complete the separation of the trithionate. The crystalline slurry is suction-filtered, washed with acetone, and dried on clay dishes at room temperature. The yield is 120 g. of approximately 86% K₂S₃O₆, but the product is still contaminated with KCl and sulfur. To recrystallize the salt, it is dissolved in about 350 ml. of H₂O at 35°C, and the solution is filtered through a heated funnel and rapidly cooled to 0°C (longer heating or higher temperature must be avoided because of the instability of K₂S₃O₆). Completely pure K₂S₃O₆ separates. By precipitating the mother liquor with an equal volume of acetone and renewed cooling to 0°C, an additional fraction of the same purity can be obtained. The crystals are filtered with strong suction, washed with acetone, and dried by pressing on clay at room temperature. The yield is 85 g.

II. REACTION OF SO₂ WITH AQUEOUS K₂S₂O₃ SOLUTION

Saturated sulfurous acid (20 ml.) is added to 200 ml. of saturated K₂S₂O₃ solution at 30°C. The flask must be thoroughly cooled with

running water. The initial yellow color of the solution disappears after some time. The addition is then repeated, using gaseous SO_2 , until a strong yellow color is apparent. The solution is allowed to stand until the color disappears, and the process is repeated until the yellow color of the solution persists for a fairly long period. After standing for several hours at about 10°C , the precipitated pale yellow crude product is suction-filtered and thoroughly washed with alcohol. To purify the crude compound, it is dissolved in some water and filtered free of suspended S, and pure $\text{K}_2\text{S}_3\text{O}_6$ is precipitated as shiny needles by mixing the filtrates with an approximately equal quantity of alcohol. The salt is suction-filtered, washed with alcohol and dried on clay at room temperature.

PROPERTIES:

Colorless crystals with a salty, bitter taste; the pure, dry salt is stable for a fairly long time. Rapidly decomposes into SO_2 , S and K_2SO_4 on heating to $30\text{--}40^\circ\text{C}$. d. 2.33.

Readily soluble in water; 100 g. of solution contains 8.14 g. of $\text{K}_2\text{S}_3\text{O}_6$ at 0°C , 18.43 g. at 20°C ; the solution decomposes slowly into $\text{K}_2\text{S}_3\text{O}_6$ and SO_2 . Insoluble in alcohol.

Crystallizes in K 5₁ structure type.

REFERENCES:

- I. H. Stamm and M. Goehring, *Z. anorg. allg. Chem.* 250, 226 (1942).
- II. F. Martin and L. Metz, *Z. anorg. allg. Chem.* 127, 83 (1923); E. H. Riesenfeld, E. Josephy and E. Grünthal, *Z. anorg. allg. Chem.* 126, 281 (1923); H. Hertlein, *Z. phys. Chem.* 19, 287 (1896).

Potassium Tetrathionate

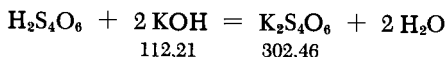
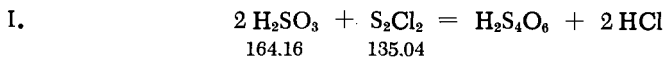

A two- to three-liter stoppered glass flask is used to saturate 750 ml. of H_2O with SO_2 at 0°C . Disregarding the appearance of any crystalline $\text{SO}_2 \cdot 6\text{H}_2\text{O}$, the solution is reacted at 0°C with 100-ml. portions of a solution of 75 g. of S_2Cl_2 in 500 ml. of

petroleum ether precooled to -15°C . The liquid turns yellow in the process; it must be decolorized before the addition of a new portion by vigorous shaking, following which it is cooled to 0°C . At the end of the addition, the mixture should still have an odor of SO_2 . The petroleum ether is removed in a separatory funnel, and a fast air stream is passed through the aqueous layer for several hours until no further odor of SO_2 can be detected. The solution is then cooled to 0°C and neutralized with an ice-cold solution of 150 g. of KOH in one liter of aqueous alcohol (final pH 6-7). The precipitated $\text{K}_2\text{S}_4\text{O}_6$, which still contains about 10% KCl, is suction-filtered and dried on clay at room temperature. The yield is about 165 g. To purify the crude product, it is dissolved in 120 ml. of 70°C water, thoroughly stirred, and, if necessary, reheated rapidly to 60°C . It is then filtered rapidly through a heated funnel; long heating or temperatures above 60°C must be avoided because of the instability of $\text{K}_2\text{S}_4\text{O}_6$. On cooling to 0°C , the filtrate yields 120 g. of 100% $\text{K}_2\text{S}_4\text{O}_6$. The crystals are filtered by suction, washed with 150 ml. of aqueous alcohol, and dried by pressing on clay at room temperature. By adding the wash alcohol to the mother liquor, a further 20 g. of 99% pure salt can be precipitated.

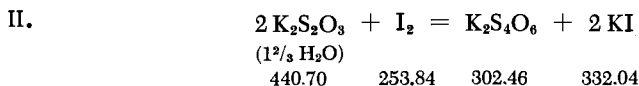

An aqueous, nearly saturated solution of 39.5 g. of $\text{K}_2\text{S}_4\text{O}_6 \cdot 1\frac{2}{3}\text{H}_2\text{O}$ (sulfate-free) is added very slowly (drop-by-drop) to an ice-cooled solution of 26 g. of I_2 in a mixture of ethanol and a few milliliters of H_2O . Very vigorous stirring is needed during the addition. The reaction is instantaneous; the tetrathionate, which is insoluble in ethanol, separates as small crystals. At the end of the addition, the solution is suction-filtered and washed with alcohol until the wash liquor is free of iodine and iodide. To purify the salt, it is redissolved at room temperature in as little water as possible and reprecipitated with alcohol. The precipitate (small, shiny crystals) is completely pure. It is dried by pressing between filter papers and then in a desiccator over concentrated H_2SO_4 .

PROPERTIES:

Colorless, platelike or prismatic crystals; the pure dry material is stable for a very long time without change but decomposes if $\text{K}_2\text{S}_2\text{O}_3$ or occluded mother liquor is present, assuming a characteristic odor. On ignition, $\text{K}_2\text{S}_4\text{O}_6$ decomposes to K_2SO_4 , SO_2 and S. d 2,29.

Readily soluble in water: 100 g. of solution at 0°C contains 12.60 g., at 20°C , 23.18 g. of $\text{K}_2\text{S}_4\text{O}_6$; the solution decomposes slowly to $\text{K}_2\text{S}_3\text{O}_6$ and $\text{K}_2\text{S}_5\text{O}_6$. Insoluble in absolute alcohol.

Monoclinic crystals, space group C-Cc.

REFERENCES:

- I. H. Stamm and M. Goehring, Z. anorg. allg. Chem. 250, 226 (1942).
- II. F. Martin and L. Metz, Z. anorg. allg. Chem. 127, 83 (1923); A. Sander, Angew. Chem. 28, (1915).

Potassium Pentathionate

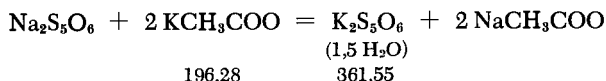
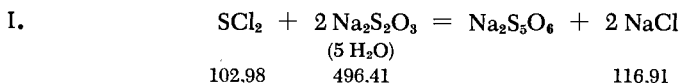

A solution of 51 g. of SCl_2 in 200 ml. of CCl_4 is prepared in a two-liter, stoppered, wide-neck flask and is then cooled to -15°C . At the same time, a solution of 250 g. of $\text{Na}_2\text{SO}_3 \cdot 5\text{H}_2\text{O}$ in 400 ml. of water is prepared and placed in an ice bath. In a third vessel, 200 ml. of 36% hydrochloric acid is mixed with 200 ml. of water and is also cooled to 0°C . The $\text{Na}_2\text{S}_2\text{O}_3$ solution and the hydrochloric acid are then rapidly and simultaneously poured into the SCl_2 solution; the flask is closed and vigorously shaken. The reaction temperature should not exceed 0°C . The mixture becomes colorless almost immediately, or should become so within 20 sec., while the aqueous layer should show only a very slight turbidity due to S. Without delay, 120 ml. of 0.3M FeCl_3 solution, precooled to 0°C , is then added until the aqueous phase is colored pale yellow. The dark color of the intermediate iron (III) thiosulfate complex is briefly evident and then disappears. The aqueous solution is then separated in a funnel and immediately concentrated at 12 mm. and a bath temperature of $35-40^\circ\text{C}$ to about 170 ml. The residual NaCl is filtered off and the ice-cold concentrate is reacted with ice-cold methanolic potassium hydroxide solution (approximately 20 g. of KOH to 100 ml. of methanol). The alkaline solution is added drop-by-drop and the mixture must be continuously and vigorously stirred. The temperature should never rise above $+10^\circ\text{C}$. The brown hydrated iron oxide formed on contact of the two solutions is immediately redissolved by the acid. When the greenish-black hydroxide intermediate begins to separate (pH ~ 3), the addition of

potassium hydroxide is interrupted and the solution is again cooled to 0°C. The separated crystalline slurry is suction-filtered and washed with acetone until the yellowish color disappears. The product is dried on clay at room temperature. The yield is 102 g. of 85% $K_2S_5O_6 \cdot 1.5H_2O$, contaminated with KCl. To recrystallize it, 50 g. of the crude product is added to 100 ml. of 0.5N HCl at 60°C, while the solution (which cools in the process) is rapidly reheated to 50°C and filtered through a heated funnel. The clear solution is placed in a dish set on ice. Star-shaped crystals of 100% pure $K_2S_5O_6 \cdot 1.5H_2O$ separate; they are filtered by suction and, after washing with alcohol, are dried on clay. The yield from the entire batch is 46 g. On addition of methanol to the mother liquor, another 13 g. of 80% pure salt is obtained.

II. REACTION OF THIOSULFATE WITH HYDROCHLORIC ACID IN THE PRESENCE OF ARSENIOS ACID

A solution of 8-10 g. of As_2O_3 in 50% sodium hydroxide is prepared and added to a solution of 500 g. of C.P. $Na_2S_2O_3 \cdot 5H_2O$ in 600 ml. of water. The reaction vessel is a five-liter flask; the mixture is well stirred and cooled to -10°C (incipient crystallization). Then 800 ml. of concentrated hydrochloric acid (precooled to -15°C) is poured in at once. After thorough mixing, the NaCl precipitate is filtered off on a fritted glass suction filter. The clear filtrate is allowed to stand in a loosely stoppered flask for 3-4 days at 25°C. Considerable precipitation of S and As_2S_3 occurs. The solution is passed through a finely porous filter and is immediately concentrated in vacuum to 200 ml. in a glass rotary evaporator at 38-40°C and 21 mm. (If no evaporator is available, the concentration can also be carried out with a small oil pump at 2-5 mm.; the H_2O is condensed with an ice-salt or Dry Ice bath; the pump is protected from acid vapors by a CaO drying tower.) The freshly precipitated NaCl is filtered off; the concentrate (d. 1.6) is mixed with 100 ml. of glacial acetic acid and cooled in a tall beaker to -10°C. A thick slurry of fine $KC_2H_3O_2$ crystals is now added in portions while the temperature is kept below -2°C and the mixture is vigorously stirred. (The slurry is prepared by dissolving 80 g. of pure, fused $KC_2H_3O_2$ in 250 ml. of boiling absolute ethanol, cooling with agitation to room temperature and adding — also with vigorous shaking — 50 ml. of glacial acetic acid.) The $KC_2H_3O_2$ dissolves because of its fine particle size, and spontaneous separation of $K_2S_5O_6 \cdot 1.5H_2O$ occurs after 30-60 seconds. The crystals are immediately suction-filtered (otherwise partial conversion to $K_2S_6O_6$ occurs) and washed with a few milliliters of a mixture of two parts of glacial acetic acid and one part of water, then with aqueous alcohol, and finally with absolute ethanol. They are

dried by pressing on clay at room temperature. The yield is 80-100 g. of very pure $K_2S_5O_6 \cdot 1.5H_2O$. Addition of a large amount of ethanol to the mother liquor yields another (95% pure) fraction.

PROPERTIES:

Colorless, prismatic or platelike crystals; the pure, dry material is stable for a long time; very unstable on contact with alkali. On heating, the water of crystallization is given off with simultaneous decomposition to K_2SO_4 , SO_2 and S. d. 2.11.

Readily soluble in water; 100 g. of solution at $0^\circ C$ contains 15.50 g. and at $20^\circ C$, 24.78 g. of $K_2S_5O_6 \cdot 1.5H_2O$; the solution decomposes into $K_2S_4O_6$ and S. Insoluble in absolute alcohol.

REFERENCES:

- I. M. Goehring and U. Feldmann, Z. anorg. allg. Chem. 257, 223 (1948).
- II. H. Stamm, O. Seipold and M. Goehring, Z. anorg. allg. Chem. 247, 277 (1941); see also A. Kurtenacker and W. Fluss, Z. anorg. allg. Chem. 210, 125 (1933); F. Foerster and K. Centner, Z. anorg. allg. Chem. 157, 45 (1926).

Potassium Hexathionate



I. REACTION OF THIOSULFATE WITH NITRITE IN ACID SOLUTION

An aqueous solution of thiosulfate and nitrite is added in one portion and with strong agitation to a mixture of 200 ml. of concentrated hydrochloric acid and 100 ml. of water, precooled to -30 to $-40^\circ C$, in a three-liter, round-bottom, wide-neck flask. The thiosulfate-nitrate solution is prepared by dissolving 12 g. of C.P. KNO_2 in a filtered solution of 90 g. of technical grade $K_2S_2O_3$ in 90 ml. of water. The mixture first turns dark brown; after a few seconds it becomes dark green and evolves NO vigorously; after 30 seconds the solution turns light green and then, over a period of 2-3 minutes, first yellow and finally a pure white. Until this happens, vigorous agitation is required since otherwise the polythionate solution decomposes with precipitation of sulfur. The nitrogen oxides still present are driven off with a fast N_2 stream and the solution is suction-filtered through glass frit to remove precipitated KCl.

The clear filtrate from two such batches is concentrated at $25-30^\circ C$ and 15-18 mm. to a moderately thick slurry. The crystals

are filtered by suction on fritted glass, washed with aqueous and then absolute alcohol, and dried on clay at room temperature. The yield is 60-70 g. of approximately 60% $K_2S_6O_6$ contaminated primarily with KCl. To purify it, 50 g. of the crude product is heated in 75 ml. of 2N HCl to about 80°C, while the flask contents are vigorously swirled around. The clear, slightly yellow solution which forms is immediately cooled with shaking. The salt precipitate is suction-filtered, washed thoroughly with alcohol, and dried by pressing on clay. The yield from the two batches is 40-44 g. of pale yellow 97.5% $K_2S_6O_6$.

II.

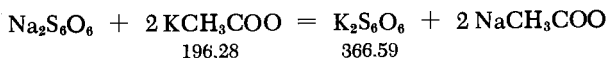
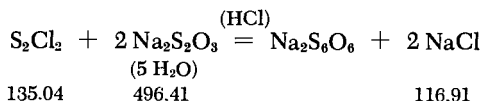

The reaction is completely analogous to that for the preparation of $K_2S_5O_6 \cdot 1.5H_2O$ from SCl_2 and thiosulfate (see above). The details of that procedure can therefore be applied unless noted to the contrary. The two cold solutions (one of 100 g. of $Na_2S_2O_3 \cdot 5 H_2O$ in 150 ml. of water and the other of 80 ml. of 36% hydrochloric acid in 80 ml. of water) are added simultaneously to a solution of 27 g. of S_2Cl_2 in 100 ml. of CCl_4 , precooled to -15°C in a one-liter wide-neck flask. The mixture is shaken, whereupon the solution becomes colorless. Then about 15 ml. of 0.6M $FeCl_3$ solution is added until the aqueous layer turns slightly yellow. It is separated in a funnel, and the aqueous $Na_2S_6O_6$ solution is immediately concentrated at 35°C and 12 mm. to about 50 ml. The NaCl precipitate is filtered off and the concentrate cooled to 0°C. Cold methanolic KOH solution is added in drops and with stirring until a pH of 1-2 (use indicator paper) is attained. The crystalline slurry is suction-filtered, washed twice with 40-ml. portions of acetone, and dried on a clay dish. The yield is 42 g. of 81% $K_2S_6O_6$.

To purify, 20 g. of the crude product is dissolved in 30 ml. of 2N HCl; the clear solution is rapidly heated to 60°C and immediately cooled again in ice water, while occasionally swirled around. Filtering by suction, washing, and drying of the crystals are as in method I. The yield from a batch is about 22 g. of 96% $K_2S_6O_6$.

PROPERTIES:

Colorless to faintly yellow, copious microcrystalline powder which becomes electrostatically charged with slight friction; stable for a long time in dry air; readily decomposed by alkali.

Readily soluble in water (although often slowly); however, the initially clear solution soon decomposes to $K_2S_5O_6$ and S.

REFERENCES:

- I. H. Stamm, O. Seipold and M. Goehring, *Z. anorg. allg. Chem.* 247, 277 (1941); E. Weitz and F. Achterberg, *Ber. dtsch. chem. Ges.* 61, 399 (1928).
- II. M. Goehring and U. Feldmann, *Z. anorg. allg. Chem.* 257, 223 (1948).

Wackenroder Liquid

This is a liquid prepared by passing H_2S through an aqueous SO_2 solution. In addition to finely divided S and small amounts of H_2SO_4 , it contains mostly higher polythioacids, particularly $H_2S_5O_6$. The component distribution varies greatly with the preparative conditions (rate of the H_2S stream, reaction time, temperature of the solution, etc.).

In the Debus method, a slow stream of pure H_2S gas is passed for 2-3 hours through 480 ml. of nearly saturated aqueous SO_2 solution held just above $0^\circ C$. After the reaction the liquid, which still retains a strong odor of SO_2 , is allowed to stand in the dark for 1-2 days in a closed flask. The H_2S treatment is then repeated in the same manner. This intermittent H_2S treatment is continued for about 10-14 days until all of the SO_2 — including that formed during the reaction — is used up; this occurs when the mixture no longer gives off the odor of SO_2 after standing for 10-12 hours at room temperature. The liquid thus obtained is an emulsion. Its thick layers are opaque; thin ones are translucent and red. It can be concentrated on a water bath to d 1.3, in vacuum to d 1.46. No decomposition of the polythioacids occurs in either case, but S precipitates out. The concentrate may be stored in the dark for a long time.

REFERENCES:

- H. Debus, *Liebigs Ann. Chem.* 244, 76 (1888).
Abegg, *Handbuch der anorganischen Chemie*, Vol. IV, 1, p. 542.

Polythionic Acids



See the original literature for the preparation of these compounds.

REFERENCES:

- Max Schmidt, Z. anorg. allg. Chem. 289, 141-202 (1957).
 F. Fehér, J. Schotten and B. Thomas, Z. Naturforsch. 13 b, 624 (1958).

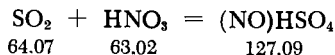
Nitrosyl Hydrogen Sulfate

Carefully dried SO_2 is introduced into a wash bottle cooled with an ice-salt bath and containing pure, fuming HNO_3 (d 1.60). The reaction is exothermic but the temperature should not rise above $+5^\circ\text{C}$. The SO_2 flow is continued until a thick slurry of $(\text{NO})\text{HSO}_4$ is separated, but some unreacted liquid nitric acid is still present. The crystals are rapidly filtered by suction through a fritted glass filter, washed with glacial acetic acid and CCl_4 , and dried on clay in a desiccator over P_2O_5 .

SYNONYM:

Nitrosyl sulfuric acid; in industry it is also called lead chamber crystals because of its occurrence as an impurity in the chamber process for manufacture of H_2SO_4 .

PROPERTIES:

White, featherlike to flaky crystals; stable in dry air; sensitive to moisture. M.p. 73.5°C (dec.).

Decomposed by water into sulfuric and nitric acids; soluble without decomposition in concentrated H_2SO_4 .

REFERENCES:

- R. Weber, J. prakt. Chem. [1] 85, 424 (1862).
 See also G. H. Coleman, G. A. Lillis and G. E. Goheen in: H.S. Booth, Inorg. Syntheses, Vol. I, p. 55, New York-London, 1939.

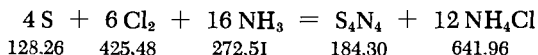
Tetrasulfur Tetranitride

The strongly exothermic process is carried out in an inert organic solvent by reacting NH_3 with a solution (of known concentration) of Cl_2 in S_2Cl_2 .

The reaction is carried out in a six-liter round-bottom flask with a three-hole cork stopper. The stopper holds a large-diameter inlet tube reaching as far down into the flask as possible; the tube has a T connection at the top through which a wire can be pushed to remove any plugs that may form. The inlet tube is connected with an NH_3 cylinder via a flow meter, a pressure release valve, and a long KOH drying tube. The reaction flask is also provided with a power-driven stirrer and a reflux condenser topped with a KOH drying tube.

Four liters of CCl_4 (dried over P_2O_5) and 250 ml. of S_2Cl_2 are placed in the flask. This solution is first saturated with Cl_2 at room temperature; then a fast stream of NH_3 (about 50 liters/hour) is passed through with vigorous stirring. The reaction temperature may not exceed $30\text{--}50^\circ\text{C}$; if necessary, the flask should be cooled with ice water.

A thick reddish-brown slurry quickly forms during the reaction. It gradually becomes grayish-green; after 3-4 hours the color becomes lighter. The slurry turns salmon-red after about six hours. At this point, the introduction of NH_3 should be stopped. The precipitate is suction-filtered on a large filter, shaken for 15 minutes with three liters of water, again collected on a frit, and dried on a clay plate. It is then again shaken for one hour with 750 ml. of ether in a one-liter powder bottle to dissolve the by-product S_7NH . After filtration and washing with ether, the residue is placed in an extraction tube and treated with dry dioxane at room temperature until the extract has only a slight yellow-orange color. The dioxane solution is carefully concentrated in vacuum. The brownish-red residue is taken up in hot benzene; on cooling, S_4N_4 crystallizes out in orange-red needles. For further purification, the substance can be sublimed in high vacuum at a bath temperature of about 100°C .

The yield varies; generally, it is about 100 g.

It must be kept in mind during the entire procedure that S_4N_4 is susceptible to explosive decomposition induced by shock or temperatures above 100°C .

PROPERTIES:

Light yellow-orange solid at ordinary temperature; becomes light yellow at -30°C ; on heating to 100°C , orange-red. M.p. 178°C , b.p. about 185°C ; decomposes explosively on further heating; d 2.22.

Insoluble in water; readily soluble in many organic solvents such as benzene, CS_2 and dioxane; only moderately soluble in alcohol and ether.

Monoclinic crystals, type C_{2h} ; space group $\text{P2}_1/\text{n}$.

REFERENCE:

- M. Goehring, *Scientia Chimica* 9, Ergebnisse und Probleme der Chemie der Schwefelstickstoffverbindungen [Data and Problems in the Chemistry of Sulfur-Nitrogen Compounds], Berlin, 1957, pp. 144, 3, 17.

Tetrasulfur Dinitride

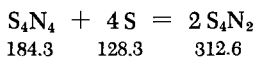

The reaction vessel is a 500- to 750-ml. stirred autoclave which can be heated to 110°C.

A mixture of 24 g. of S_4N_4 and 50 g. of S is dissolved or suspended in 380 ml. of pure CS_2 and heated in the autoclave for two hours at 110°C. The mixture is then cooled as rapidly as possible. If a great deal of thiocyanogen polymer forms during the reaction, it is filtered off. The residue is thoroughly washed with CS_2 and the wash liquor is combined with the filtrate. The carbon disulfide is then evaporated in vacuum. The red evaporation residue is distilled in high vacuum at a bath temperature of 60-65°C. Dark-red crystals separate in a trap cooled with Dry Ice-methanol mixture.

The yield is about 4 g. The autoclave should not be cleaned between runs since the yield is good only if the walls are contaminated with material from a previous S_4N_2 preparation.

PROPERTIES:

M.p. 23°C; quite unstable; decomposes within a few hours even at 0°C; decomposes explosively to S and N at 100°C; soluble in many organic solvents; insoluble in water; hydrolyzes slowly with water; diamagnetic.

REFERENCE:

- M. Goehring, *Scientia Chimica* 9, Ergebnisse und Probleme der Chemie der Schwefelstickstoffverbindungen [Data and Problems in the Chemistry of Sulfur-Nitrogen Compounds], Berlin, 1957, pp. 22, 147.

Disulfur Dinitride

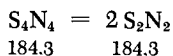

The compound is prepared by thermal degradation of S_4N_4 . The reactor is a quartz tube, about 320 mm. long. The diameter of the lower section of the tube is 11 mm., while that of the top half is approximately twice that. As shown in Fig. 167, the upper part of the tube is connected through two condensation traps to a high-vacuum pump; a water-cooled glass finger extends into the upper section of the reactor. All connections are ground glass joints. The narrower, lower section of the reactor is surrounded by two electric furnaces, each heating about half of the section. The lower furnace heats the contents to about 80°C , the upper one to about 300°C .

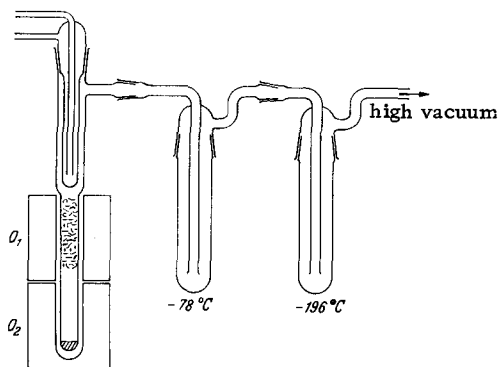

Fig. 167. Preparation of disulfur dinitride.

A small amount (1-2 g.) of S_4N_4 is placed in the reactor. A 7-cm.-long part of the section heated by the upper furnace is filled with tightly compressed silver wool. The apparatus is evacuated to 0.005 mm. The first condensation trap is then cooled with Dry Ice-methanol and the second trap with liquid nitrogen. The upper furnace is heated to 300°C and only then is the lower one switched on.

The cold finger soon becomes coated with a blue film, and colorless to faintly yellow crystals form in the inlet tube to the first trap. After 6-8 hours, the thermal degradation of S_4N_4 is complete. The furnaces and the trap coolants are then removed and the apparatus is flushed with dry air or dry N_2 .

The light-gray crystalline coating in the first trap (which is reddish, with a blue rim, where it extends beyond the cooling zone) is extracted several times with 10-ml. portions of dry ether until only a few dark-blue or shiny metallic crystals remain. The first extract is a deep red because of the byproduct S_4N_2 ; since S_4N_2 dissolves readily, the color of the other extracts is lighter. The combined ether solution is filtered and placed in a conical ground glass flask (which narrows to a point at the bottom) provided with an adapter permitting reverse filtration with exclusion of moisture. The flask is then cooled to -80°C in a Dry Ice-methanol bath; the white S_2N_2 crystals precipitate. These are separated from the ether by reverse filtration.

To purify the S_2N_2 it can be sublimed at room temperature in high vacuum. Beautiful, large, colorless crystals are obtained. The yield, prior to sublimation, is 80%.

It cannot be overemphasized that the preparation and further manipulation of S_2N_2 must be done very cautiously. Significant polymerization occurs within a short time even at room temperature. The material detonates violently at 30°C , or when under high mechanical pressure.

PROPERTIES:

Well-formed, colorless crystals; very volatile; unpleasant iodinelike odor; stable only at low temperature; becomes dark after a short exposure to 20°C ; sublimes at 10^{-2} mm. even at room temperature; polymerizes readily to $(SN)_x$; in the presence of traces of moisture, about 67% of the S_2N_2 polymerizes to $(SN)_x$, while 33% dimerizes to S_4N_4 ; detonated by shock, friction and temperature above 30°C ; soluble in alcohols, yielding yellowish red solutions; readily forms colorless solutions in benzene, ether, carbon tetrachloride, acetone, tetrahydrofuran, dioxane; in the absence of moisture, the colorless solutions are more stable than the solvent-free substance (however, the addition of traces of alkali metals, some NaOH, KCN or Na_2CO_3 causes instantaneous and complete dimerization); crystals are not wetted by water and acids (for this reason, hydrolysis with these solvents occurs very slowly); vigorous reaction with alkali solutions; dissolves rapidly in 2 N NaOH, giving a yellow solution, with larger crystals becoming black and detonating, giving off a pungent gas.

REFERENCE:

- M. Goehring, *Scientia Chimica* 9, Ergebnisse und Probleme der Chemie der Schwefelstickstoffverbindungen [Data and Problems in the Chemistry of Sulfur-Nitrogen Compounds], Berlin, 1957, pp. 18, 145.

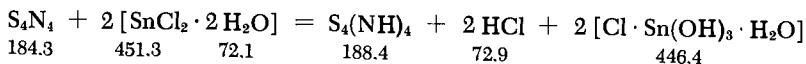
Sulfur Nitride Tetrahydride

A solution of 10 g. of S_4N_4 in 300 ml. of dry benzene is heated to 80°C in a two-liter flask. A solution of 35 g. of $\text{SnCl}_2 \cdot 2\text{H}_2\text{O}$ in 80 ml. of methanol containing about 5% water is added all at once. The solution starts to boil and becomes colorless. The precipitate formed is suction-filtered and washed with cold 2N HCl until no Sn remains. It is then washed with alcohol and ether. Further purification is by recrystallization from methanol.

The yield is about 6 g.

PROPERTIES:

Colorless solid; small, shiny crystals of C_{2h} type; reddens on heating to $80\text{--}100^\circ\text{C}$; m.p. 152°C (provided it is heated very rapidly; otherwise decomposition occurs); not wetted and not dissolved by water; readily soluble in pyridine, slightly soluble in hot acetone and hot alcohol, very slightly soluble in other organic solvents; diamagnetic.

REFERENCE:

- M. Goehring, *Scientia Chimica* **9**, Ergebnisse und Probleme der Chemie der Schwefelstickstoffverbindungen [Data and Problems in the Chemistry of Sulfur-Nitrogen Compounds], Berlin, 1957, pp. 28, 147.

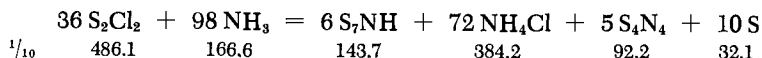
Heptasulfur Imide

A two-liter, three-neck flask, equipped with a stirrer, a gas inlet tube reaching to the bottom, and a gas outlet tube connected to a KOH drying tube, serves as the reaction vessel.

The flask is filled with one liter of dimethylformamide and cooled with an ice-salt mixture, and a fast stream of NH_3 is passed through with vigorous stirring. When the solution is saturated with NH_3 and the temperature has dropped to -5°C , the gas outlet tube

is briefly removed and 5 ml. of S_2Cl_2 is rapidly injected from a pipette without interrupting the inflow of NH_3 . After the addition of S_2Cl_2 , the temperature of the reaction mixture increases somewhat; after renewed cooling to $-5^\circ C$, another 5 ml. of S_2Cl_2 is injected into the flask. A total of 100 ml. of S_2Cl_2 is added in this manner. Ammonia passage is continued for 15 min., after which stirring is interrupted. The mixture is left to stand for one hour and is then poured into three liters of 1% HCl (precooled to $0^\circ C$). Some ice is added. The mixture is stirred, neutralized with 10% HCl, and left to stand for 2-3 hours to settle the reaction products (S and S_7NH). The supernatant is then decanted; the solid products are washed with water on a filter and dried in a vacuum desiccator over $CaCl_2$. The crude product is shaken with 250 ml. of tetrahydrofuran for one half hour. It is then filtered through a fluted filter paper, and the tetrahydrofuran is removed in aspirator vacuum. The residue is recrystallized from hot methanol. By concentrating the mother liquor, further heptasulfur imide can be obtained. The yield is 16-20 g.

PROPERTIES:

M.p. $113.5^\circ C$; crystallizes in space group D_{2h}^{18} ; d 2.01. Not wetted or dissolved by water; readily soluble in organic solvents; characteristic blue-violet color with acetone when alcoholic alkali hydroxide is added.

REFERENCES:

- M. Goehring, *Scientia Chimica* 9, Ergebnisse und Probleme der Chemie der Schwefelstickstoffverbindungen [Data and Problems in the Chemistry of Sulfur-Nitrogen Compounds], Berlin, 1957, p. 55.
 M. Becke-Goehring, H. Jenne and E. Fluck, *Chem. Ber.* 91, 1947 (1958).

α -Sulfanuric Chloride

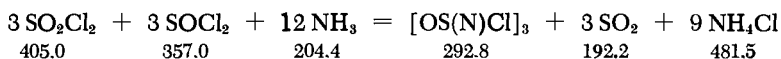
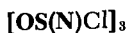

A mixture of sulfuryl chloride and thionyl chloride (100 ml., mole ratio 2 : 1) is diluted with 100 ml. of low-boiling petroleum ether in a 500-ml., three-neck, ground glass flask equipped with a stirrer, a gas inlet and a drying tube. The flask is cooled in a Dry Ice-methanol bath, and a rapid stream of dry NH_3 is passed through for 1.5 hours, while the mixture is continuously stirred.

A yellow slurry is formed. The solvent is removed in vacuum at a bath temperature of about 50°C; the residue is washed with cold water, immediately filtered and dried in a vacuum desiccator. From this water-insoluble reaction mixture, α -sulfanuric chloride is obtained by sublimation at a bath temperature of 60–80°C and a pressure of 0.05 mm.

The yield is about 1 g.

PROPERTIES:

White, crystalline substance; not wetted by water; soluble in organic solvents; forms esters with alcohols; hydrolyzes slowly with water; m.p. 144.5°C.

REFERENCE:

- M. Goehring, *Scientia Chimica* 9, Ergebnisse und Probleme der Chemie der Schwefelstickstoffverbindungen [Data and Problems in the Chemistry of Sulfur-Nitrogen Compounds], Berlin, 1957, pp. 96, 158.

Trisulfur Dinitrogen Dioxide

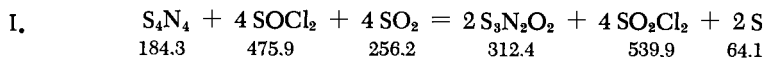

The reaction vessel is a 100-ml., two-neck, ground glass flask with reflux condenser and gas inlet tube.

Approximately 1 g. of S_4N_4 is reacted with a mixture of equal volumes of C_6H_6 and SOCl_2 . The quantity of the C_6H_6 - SOCl_2 mixture should be such that a portion of the S_4N_4 remains undissolved. Dry SO_2 is then introduced and the flask is heated at 70–75°C for two hours. The solution turns red-brown. The solvent is then evaporated in vacuum at room temperature and the $\text{S}_3\text{N}_2\text{O}_2$ is sublimed from the mixture in high vacuum at about 40°C to form large yellow crystals.

The yield is about 0.8 g.

II. Approximately 80 g. of distilled SOCl_2 is diluted with 80 g. of dry petroleum ether and cooled to -80°C . A rapid stream of dry NH_3 is passed through this solution until the mixture becomes a thick yellow slurry. The reaction must be protected from moisture. The solvent is distilled off in vacuum at room temperature and the dry residue is then transferred into a sublimation vessel; the

product sublimes at a bath temperature of about 40°C and 0,01 mm. The crude product may be recrystallized from dry benzene.

The yield is about 6 g.

PROPERTIES:

Well-formed, pale yellow crystals (rhombic, pseudotetragonal); soluble in organic solvents (e.g., benzene, nitrobenzene, heptane, petroleum ether, alcohols; these solutions are stable if the solvent is completely dry); hydrolysis occurs only on prolonged contact with water; immediate hydrolysis in alkaline solution; completely stable when stored in dry air (or dry N₂, dry SO₂) at room temperature; becomes red when heated to 80°C; m.p. 100.7°C (without decomposition); boils on further heating, evolving a yellow vapor which ignites spontaneously in air at about 300°C. When decomposed by moisture, the yellow crystals first turn red, then black and finally white (the odor of SO₂ is apparent).

REFERENCE:

- M. Goehring, *Scientia Chimica* **9**, Ergebnisse und Probleme der Chemie der Schwefelstickstoffverbindungen [Data and Problems in the Chemistry of Sulfur-Nitrogen Compounds], Berlin, 1957, pp. 156, 85.

Trisulfur Dinitrogen Pentoxide

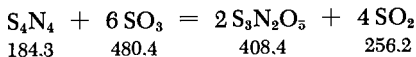

The reactor is a 4-cm.-diameter tube with a capacity of 200 ml. A water-cooled cold finger, extending through about 4/5 of the tube length, is inserted through a ground glass connection. A flask filled with oleum, a vacuum line, and a pressure release valve (protected with an H₂SO₄ drying tube) are connected to the reaction tube via stopcocks.

A 5-g. quantity of S₄N₄ is placed in the tube. The cold finger is then cooled with running water and the tube is evacuated to about 15 mm. The stopcock to the flask containing the oleum is now opened; the flask is evacuated and heated until SO₃ distills out. It condenses on the cold finger and then drips onto the sulfur nitride below. Immediately after the start of the reaction, the reactor is cooled with ice water. The S₄N₄ first turns black-brown and SO₂ is evolved. Later, when the substance reverts to light yellow and is covered with some liquid SO₃, the stopcock to

the oleum flask is closed and the stopcock to the pressure release valve is opened so that the SO_2 may escape. The cooling bath is now removed and the mixture allowed to stand at room temperature for about six hours. The excess SO_3 is distilled back into the oleum flask by opening the stopcock to this flask, evacuating the reaction vessel to 15 mm., cooling the oleum flask to 0°C , and heating the reaction tube to 30°C . If the reactor is then heated briefly to 60°C , even the last traces of SO_3 can be removed. Finally, the stopcock to the oleum flask is closed again, the apparatus is evacuated to 1 mm., and the reactor is heated to $70\text{--}80^\circ\text{C}$. Most of the $\text{S}_3\text{N}_2\text{O}_5$ product sublimes onto the cold finger.

The yield is about 5 g.

PROPERTIES:

Well-formed, almost colorless crystals, which can be sublimed in vacuum; completely stable when stored dry; readily soluble in organic solvents (e.g., nitrobenzene) without decomposition; vigorous reaction with traces of moisture. The compound is characterized most easily by its powder pattern.

REFERENCE:

- M. Goehring, *Scientia Chimica* 9, Ergebnisse und Probleme der Chemie der Schwefelstickstoffverbindungen [Data and Problems in the Chemistry of Sulfur-Nitrogen Compounds], Berlin, 1957, pp. 156, 85.

Selenium

Se

VERY PURE SELENIUM

Commercial selenium frequently contains some sulfur as well as small amounts of tellurium and iron. To remove these, it is oxidized to SeO_2 ; the latter is purified by repeated sublimation and is then reduced again to elemental selenium.

The oxidation of Se to SeO_2 should be carried out according to the procedure given under SeO_2 , with particular attention to the purity of all reagents used. The subsequent resublimation is also carried out in the manner described. The final sublimate, consisting of loose, colorless crystals, is dissolved in water, re-filtered (if needed), and then reduced in a stirred flask placed on the water bath by the gradual addition of 10% hydrazinium hydroxide solution. The Se precipitates as a red powder which, when heated,

soon coagulates to form a grayish-black precipitate. An excess of the reducing agent should be avoided as it dissolves Se, forming red polyselenides. (These may be decomposed by the addition of hydrochloric acid.) The Se is filtered off and washed several times with hot water until the filtrate ceases to give a blue color on addition of KI-starch solution. The entire purification procedure is then repeated. The dark powder obtained after the second reduction is thoroughly washed, dried at 170°C, and, if desired, distilled in a stream of N₂ to remove the last traces of adsorbed moisture (a quartz apparatus should be used).

REFERENCES:

- J. Jannek and J. Meyer, Z. anorg. allg. Chem. **83**, 51 (1913).
 O. Hönnigschmid and W. Kapfenberger, Z. anorg. allg. Chem. **212**, 198 (1933).

MODIFICATIONS OF SELENIUM

a) AMORPHOUS SELENIUM

Amorphous selenium is formed by reduction of Se compounds at moderate temperatures. Depending on the state of aggregation, it may be red to black in color.

To prepare amorphous red Se, SO₂ is passed at 15 to 20°C through an aqueous H₂SeO₃ solution strongly acidified with hydrochloric acid. The finely powdered Se precipitate is carefully washed free of Cl⁻ and SO₄²⁻ ions and dried in a vacuum desiccator over CaCl₂.

Dark, amorphous Se is obtained by treating red Se with boiling water. It is also formed by reduction of heated selenous acid with hydrazinium hydroxide (see Very Pure Selenium above). The grayish-black powder is thoroughly washed with warm water and dried in vacuum over CaCl₂.

Both forms of amorphous Se are stable at room temperature.

b) AMORPHOUS, VITREOUS SELENIUM

Vitreous Se is formed on rapid cooling of molten Se.

Solid selenium of any available modification is melted and poured in a thin stream into cold water. Strands of brittle, vitreous Se are obtained. Thin layers of this material are translucent and red, while thick layers are grayish black. The substance can be stored for a long time at room temperature.

c) MONOCLINIC α -SELENIUM AND β -SELENIUM

The two monoclinic modifications are formed together when amorphous Se is treated with CS₂.

A few grams of amorphous red Se are refluxed for two hours in one liter of CS_2 . The orange, slightly green-tinted solution is allowed to evaporate slowly at room temperature in a vessel protected from dust. Large red crystals of α -Se along with smaller, dark prisms of β -Se are formed. They can be separated by sorting under the microscope. Both forms are quite stable at room temperature.

d) HEXAGONAL SELENIUM

Metallic, hexagonal selenium is formed when any one of the other selenium modifications is heated above 130°C .

Monoclinic Se, vitreous Se or powdered amorphous Se is vacuum heated for some time (10 hours or more) at 200°C until complete conversion to the metallic form has occurred. The product is lead gray, finely crystalline and granular.

A highly ordered Se solid, in which no lattice imperfections can be detected by x ray analysis, is obtained only after annealing for several days at 200 to 218°C . The crystallization of Se can be catalyzed by various substances.

For methods of preparing single crystals up to 10 mm. long and 0.5 mm. in diameter, see the cited literature.

e) COLLOIDAL SELENIUM

Stable, essentially monodispersed Se sols are obtained by reduction of selenous acid with hydrazinium hydroxide. A mixture of 90 ml. of distilled H_2O and 5 ml. of 1.5M $\text{N}_2\text{H}_5\text{OH}$ solution is heated, and 4 ml. of pure H_2SeO_3 solution (0.1M) is added when the temperature reaches 100°C . When the mixture turns dark yellow, 1 ml. of the same H_2SeO_3 solution is added. The flame is then removed; the solution is cooled for about 10 minutes and diluted to 400 ml. with distilled H_2O . When stored in the dark, the sol is stable for a fairly long period. On the other hand, it flocculates quantitatively in a short time on exposure to direct sunlight. The particle count is $3-4 \cdot 10^{10}/\text{ml}$. If the 5 ml. of H_2SeO_3 solution is added all at once to a vigorously boiling solution of reducing agent, a greater number of particles ($10-12 \cdot 10^{10}/\text{ml}$., diameter about $75 \text{ m}\mu$) is obtained. The sols may be freed of the electrolyte by dialyzing.

REFERENCES:

- a) S. S. Bhatnagar, M. R. Verma and M. Anwar-ul-Hag, *Kolloid-Z.* **78**, 9 (1937); V. Lenher, *J. Amer. Chem. Soc.* **20**, 565 (1898).
- b) K. Neumann and E. Lichtenberg, *Z. phys. Chem. (A)* **184**, 89 (1939); V. Regnault, *Ann. Chim. Phys.* [3] **46**, 284 (1856).

- c) W. Muthmann, *Z. Kristallogr.* **17**, 336 (1890); F. Halla, F. X. Bosch and E. Mehl, *Z. phys. Chem.* (B) **11**, 455 (1931); H. P. Klug, *Z. Kristallogr.* **88**, 130 (1934).
- d) K. Neumann and E. Lichtenberg, *Z. phys. Chem.* (A) **184**, 89 (1939); M. Straumanis, *Z. Kristallogr.* **102**, 442 (1940); F. C. Brown, *Phys. Rev.* [2] **4**, 85 (1914); R. M. Holmes and A. B. Rooney, *Phys. Rev.* [2] **31**, 1126 (1928); R. M. Holmes and H. W. Allen, *Phys. Rev.* [2] **55**, 593 (1939); *Bull. Amer. Phys. Soc.* **13**, No. 7, 8 (1939); H. Krebs, *Z. anorg. allg. Chem.* **265**, 156 (1951); *Angew. Chem.* **65**, 293 (1953).
- e) H. R. Kruyt and E. A. van Arkel, *Rec. Trav. Chim. Pays Bas* **39**, 656 (1929); *Kolloid-Z.* **32**, 29 (1923); F. B. Gribnau, *Kolloid-Z.* **82**, 15 (1938).

Hydrogen Selenide

H₂Se

Hydrogen selenide is even more poisonous than H₂S. It very strongly attacks the mucous membranes of the eyes, nose and throat ("selenium fever"). The preparation must therefore be carried out under a very good hood, using a carefully sealed apparatus with the outlets directly connected to the stack.

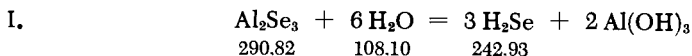

The reactor is a dry 500-ml. ground glass flask equipped with a separatory funnel and gas inlet and outlet tubes. The outlet tube is connected to the drying and condensation apparatus; the latter consists of two U tubes, containing CaCl₂ and P₂O₅-glass wool, as well as two glass condensation traps cooled to -78°C. The flask is filled with pure dry Al₂Se₃ (for preparation see section on Aluminum) and the apparatus is flushed for 15-20 minutes with oxygen-free, dry N₂ until all air is displaced. While a slow stream of N₂ is passed through, freshly distilled cold water is added slowly from the separatory funnel. The addition must be regulated so that the reaction is not too violent and the flask heats up only very slightly. A little dilute hydrochloric acid is added toward the end, when the gas evolution subsides. The condensate collected in the traps is 100% H₂Se, provided all starting materials used in the preparation of Al₂Se₃ were pure. The yield is about 85%.

Hydrogen selenide can be stored in liquid form at low temperatures or as a vapor in sealed glass flasks.



A mixture of oxygen-free, dry H₂ and pure selenium vapor is passed through a combustion tube filled with pumice fragments and

heated to 350–400°C. For the arrangement of the apparatus and the procedure, see the analogous synthesis of H₂S (p. 344) as well as the original literature. After passing through traps cooled to –20°C and –40°C, the H₂S is frozen out with liquid nitrogen; after another distillation in high vacuum, it is very pure.

PROPERTIES:

Colorless gas with an unpleasant odor “reminiscent of rotten radishes”; very poisonous. Decomposed by dust, rubber and, in the presence of moisture, also by atmospheric oxygen, with separation of selenium. For this reason, rubber connections are to be avoided. M.p. –65°C, b.p. –42°C, crit. t. +141°C, crit. p. 91 atm. d. (liq. –42°C) 2.12, d. (solid –170°C) 2.45; weight per liter 3.6643 g.

More soluble in water than H₂S; solubility at 760 mm. in 1 vol. part H₂O (4°C) 3.77; (13.2°C) 3.31; (22.5°C) 2.70 vol. parts H₂Se. In air, the initially colorless solution rapidly becomes cloudy, with separation of red Se.

The Se atoms in crystalline H₂Se form a cubic face-centered lattice; probably structure type C1 or C2.

REFERENCES:

- I. G. R. Waitkins and R. Shutt in: W. C. Fernelius, *Inorg. Syntheses*, Vol. II, p. 183, New York-London, 1946; see also L. Moser and E. Doctor, *Z. anorg. allg. Chem.* **118**, 284 (1921).
- II. A. Klemenc, *Die Behandlung und Reindarstellung von Gasen* [Treatment and Purification of Gases], Leipzig, 1938, p. 184; W. Hempel and M. G. Weber, *Z. anorg. allg. Chem.* **77**, 48 (1912); M. G. Weber, Thesis, Dresden, 1910; H. J. Backer, *Rec. Trav. Chim. Pays Bas* **62**, 580 (1943).

Sodium Hydrogen Selenide

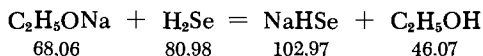

Because of the instability of NaHSe and H₂Se in moist air, the preparation must be carried out in the closed apparatus shown in Fig. 168.

Oxygen-free, dry N_2 is introduced at a , and the apparatus is carefully purged until all air is displaced. Then a small tube, containing highly pure, vacuum-distilled Na (see section on Alkali Metals), the tip of which has been broken just prior to insertion, is pushed with the open end down into attachment C , and the latter is rapidly closed off with a rubber stopper. After evacuating through 2 with stopcocks 1, 3 and 4 closed, the metal is melted in high vacuum and allowed to flow into reaction vessel A . Capillary k_1 is then fused to form a seal. Section A is then cooled with an ice-salt mixture, and carefully dehydrated alcohol is added from D in small portions until an alcoholic ethoxide solution is formed. When the

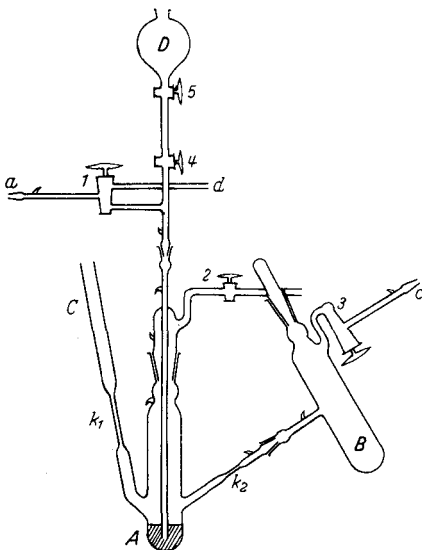

Fig. 168. Preparation of sodium hydrogen selenide.

reaction is complete, A is warmed again to room temperature. Then a mixture of pure dry H_2 and H_2Se is allowed to enter at a with the three-way stopcock 1 turned so that the gas escapes at d and thus flushes the stopcock holes free of air; only then is it introduced into the apparatus by turning stopcock 1. The solution heats up considerably during the reaction. At first the gas is allowed to escape at 3; when section B is sufficiently filled with H_2Se , the gas is allowed to escape at 2. As soon as the reaction subsides, the H_2 inflow is stopped and pure H_2Se is introduced. The end of the reaction is recognized by the absence of vapor mists and cooling of vessel A . Stopcock 2 is then closed and stopcock 3 opened, the apparatus is tilted, and the $NaHSe$ solution is forced to flow toward B under hydrogen pressure. Capillary k_2 is then fused shut. The

alcohol is evacuated with an aspirator through *c*. Finally, high vacuum is applied, and the remaining fine, white crystals of NaHSe are dried at about 50°C. The product is then analytically pure.

PROPERTIES:

White crystals; very unstable in moist air, separating Se and forming polyselenides.

Rhombohedrally distorted NaCl structure.

REFERENCE:

W. Teichert and W. Klemm, *Z. anorg. allg. Chem.* 243, 86 (1939).

Sodium Selenide, Potassium Selenide



The reaction is carried out in liquid NH_3 . For apparatus and procedure, see K_2S (p. 360). The directions given there may be applied without change. The white Na_2Se or K_2Se is analytically pure.

PROPERTIES:

White, fine, hygroscopic crystals; rapidly turns red in moist air because of Se separation and formation of polyselenides.

Na_2Se : m.p. > 875°C, d 2.58.

K_2Se : On heating, initially brown, then black. d 2.29 (by x ray).

Both compounds are soluble in water; red Se separates rapidly on contact with air.

Crystallizes in Cl structure type.

REFERENCE:

W. Klemm, H. Sodomann and P. Langmesser, *Z. anorg. allg. Chem.* 241, 281 (1939).

Sodium Diselenide

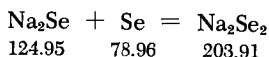

About 2.5 g. of Na_2Se and the stoichiometric amount of Se are placed in a small glass tube in a vigorous oxygen-free stream of

dry N_2 . The tube is sealed off in high vacuum and then heated in an electric furnace to $500^\circ C$ until a homogeneous melt is formed (about 45 min.). The gray-black, very hard mass that forms on cooling is Na_2Se_2 .

PROPERTIES:

Dull gray-black, microcrystalline substance; very hygroscopic; decomposes in moist air, turning red.

M.p. about $495^\circ C$.

Readily soluble in water, forming a red solution which decomposes rapidly on contact with air, separating selenium.

REFERENCES:

W. Klemm, H. Sodomann and P. Langmesser, *Z. anorg. allg. Chem.* 241, 281 (1939).

W. Klemm and H. Sodomann, *Z. anorg. allg. Chem.* 225, 273 (1935).

Diselenium Dichloride

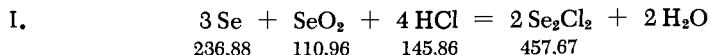

A solution of 115 g. of freshly sublimed SeO_2 in 500 ml. of concentrated hydrochloric acid (36-37%) is prepared in a wide-neck flask, and 235 g. of pure Se is added. Then concentrated H_2SO_4 is added in drops from a separatory funnel until HCl evolution ceases. The mixture is cooled. The Se_2Cl_2 , which settles at the bottom as a red layer, can then be removed in the separatory funnel. To purify the product, it is either washed several times with concentrated H_2SO_4 , or it is dissolved in fuming sulfuric acid and reprecipitated with HCl. Any adhering H_2SO_4 is removed by treating with anhydrous $BaCl_2$ and subsequent filtering through fritted glass. The filtration must be protected from moisture. The yield of red-brown Se_2Cl_2 is about 90%.

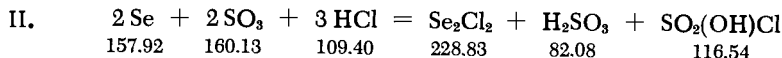

A distillation flask is filled with 300 g. of 30% oleum, and 100 g. of finely powdered Se is added with constant stirring. The flask

is equipped with a gas inlet tube extending to the bottom and is connected to a downward condenser, connected to a receiver. From the receiver, a gas outlet tube leads (through an H_2SO_4 wash bottle) directly to the stack of the hood. A fast stream of dry HCl (p. 280) is bubbled through the reaction mixture, which is carefully heated until Se just begins to volatilize. After a short time, crude Se_2Cl_2 begins to distill into the receiver at a uniform rate. The distillation rate is adjusted so that about 130 g. distills in two hours. The crude product is shaken several times with small amounts of fuming sulfuric acid until it no longer turns green (SeSO_3), then allowed to stand for some time over anhydrous BaCl_2 , and finally filtered through a fritted glass filter protected from access of moisture.

Stored in sealed glass ampoules.

SYNONYMS:

Older names: selenium monochloride and selenous chloride.

PROPERTIES:

Dark red, oily liquid with a brown tint; odor similar to S_2Cl_2 ; sensitive to moisture. M.p. -85°C , b.p. (733 mm.) 127°C with partial decomposition into Se and SeCl_4 ; cannot be distilled without decomposing, even at reduced pressure. d_4^{25} 2.77.

Slowly hydrolyzed by water, forming H_2SeO_3 , HCl and Se . Dissolves without decomposition in CS_2 and CHCl_3 .

REFERENCES:

- I. V. Lenher and C. H. Kao, *J. Amer. Chem. Soc.* 47, 772 (1925); 48, 1550 (1926).
- II. F. H. Heath and W. L. Semon, *Ind. Eng. Chem.* 12, 1100 (1920).

Selenium Tetrachloride

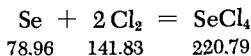

I. DIRECT CHLORINATION OF SOLID Se :

A 1- to 15-cm. section of a 1.5-m.-long combustion tube is filled with pure granulated Se (free of Te). The filled section starts at a distance of 10 cm. from one end. The tube is closed at both ends

with one-hole rubber stoppers holding gas inlet and outlet tubes. The inlet is at the end close to the Se layer. The outlet tube is connected, through a CaCl_2 drying tube, to the hood stack. The middle and rear sections of the tube are cooled with strips of wet filter paper, and pure, dry chlorine gas is introduced at room temperature. The reaction begins immediately, with absorption of Cl_2 and heating of the selenium layer. Toward the end of the reaction, the selenium must be heated somewhat with a multiple-flame burner. The SeCl_4 deposits in the colder section of the tube. It is then sublimed several times (in the direction of the tube rear) in a fast stream of Cl_2 in order to remove small amounts of SeOCl_2 . The pure product is loosened from the glass wall by light tapping, with heating if necessary. It is then quickly shaken out of the reactor and sealed in ampoules. The yield is about 90%.

A different apparatus operating on the same principle is described by H. G. Nowak and J. F. Suttle in: T. Moeller, *Inorganic Syntheses*, Vol. V, p. 125, New York-Toronto-London, 1957.

II. CHLORINATION OF Se IN AN INERT SOLVENT:

Pure Se is suspended in CCl_4 in a round-bottom flask provided with a gas inlet and outlet. Dry Cl_2 is then introduced. The Se soon dissolves and the solution turns brown (formation of Se_2Cl_2); after some time, SeCl_4 separates as a yellow-white powder. It is rapidly filtered by suction (the filtration must be protected from moisture) on a fritted glass filter, washed with a small amount of CCl_4 , and dried in a vacuum desiccator over silica gel.

PROPERTIES:

White to faintly yellow crystalline substance; decomposes in moist air. On heating, sublimes without melting; the change in the color of the vapor from yellow to red with increasing temperature indicates increasing dissociation; subl. p. about 196°C . Melts in a closed tube at about 305°C to form a dark red liquid, d 3.80.

With water, it hydrolyzes exothermically to form H_2SeO_3 and HCl .

REFERENCES:

- I. G. Wagner, *Anorganisch-präparatives Praktikum [Inorganic Preparative Manual]*, Vienna, 1947, p. 114; F. Clausnizer, *Liebigs Ann. Chem.* 196, 265 (1879).
- II. V. Lenher, *J. Amer. Chem. Soc.* 42, 2498 (1920); H. C. Bell and C. S. Gibson, *J. Chem. Soc. (London)* 127, 1877 (1925).

Hexachloroselenium Salts

The stock solution for the preparations is prepared by dissolving 5.5 g. of SeO_2 in hydrochloric acid; alternatively, 4 g. of finely powdered gray Se is added to 50 ml. of concentrated hydrochloric acid, and Cl_2 is passed through with frequent swirling or stirring until the initially dark brown sludge of SeCl_2 is completely dissolved and the solution is brownish-yellow.

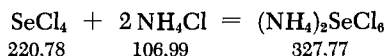
 $(\text{NH}_4)_2\text{SeCl}_6$ 

For example, 5 ml. of an aqueous solution of 0.55 g. of NH_4Cl (~10 mmoles) is added to 5 ml. of the SeCl_4 solution containing 5 mmoles of SeCl_4 , and HCl gas is passed through at 0°C with frequent shaking. The $[\text{SeCl}_6]^{2-}$ concentration increases with increasing HCl concentration and determines the point of precipitation. Precipitation of the deep yellow complex salt, which soon commences, is nearly quantitative if the solution is saturated with HCl . The solution is then colorless.

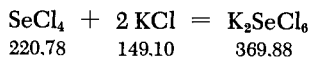
 K_2SeCl_6 

For example, 15 ml. of a concentrated hydrochloric acid solution of 0.75 g. of KCl (~10 mmoles) is added to 5 ml. of the SeCl_4 solution and the complex is precipitated as discussed under $(\text{NH}_4)_2\text{SeCl}_6$.

To isolate these moisture-sensitive complexes, the apparatus described for the preparation of hexachlorotitanium salts (compare section on Titanium) can be used.

Ti_2SeCl_6 cannot be made by reaction in hydrochloric acid solution, since the Se^{4+} is reduced to elemental Se.

Rb_2SeCl_6 and Cs_2SeCl_6 are analogously obtained from concentrated hydrochloric acid solutions even at room temperature.

PROPERTIES:

$[(\text{NH}_4)_2\text{SeCl}_6 \text{ and } \text{K}_2\text{SeCl}_6]$: Yellow octahedra with an average diameter of 0.03 mm. Very sensitive to moisture; when moistened with hydrochloric acid, complete decomposition and loss of color occur in air in about 10 minutes. Very readily soluble in water with complete hydrolysis to selenic and hydrochloric acids; nearly

insoluble in concentrated hydrochloric acid. The complex salt reprecipitates on passage of HCl through a not too dilute aqueous solution at 0°C.

Crystal structure: K_2PtCl_6 type.

REFERENCES:

W. Petzold, Z. anorg. allg. Chem. 209, 267 (1932).

G. Engel, Z. Kristallogr. 90, 341 (1935).

H. Leibiger, Thesis, Freiburg i. Br., 1951.

Diselenium Dibromide



A round-bottom flask, equipped with a separatory funnel and gas outlet tube connected to a P_2O_5 drying tube, is filled with a suspension of 20 g. of pure powdered Se in 50 ml. of dry CS_2 ; 20 g. of pure Br_2 is then slowly added from the separatory funnel. If the flask is occasionally shaken, the reaction is soon complete. A reddish-brown solution is formed, from which the CS_2 is evaporated in vacuum as rapidly as possible. The product is deep-red, pure Se_2Br_2 .

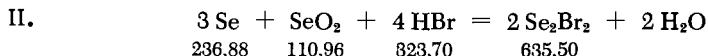

A wide-neck flask is filled with 400 ml. of H_2O and this is saturated at 0°C with SO_2 . While the SO_2 passage is continued, 135 ml. of Br_2 is gradually added from a separatory funnel. When the Br_2 is completely consumed and the solution becomes colorless, 115 g. of SeO_2 and then 235 g. of Se are added at room temperature. About one liter of concentrated H_2SO_4 is then added, the reaction mixture is allowed to cool, and the dark red, oily layer is removed in a separatory funnel. The product is purified by repeated washing with concentrated H_2SO_4 . The yield of Se_2Br_2 is about 90%.

SYNONYMS:

Older names are selenium monobromide and selenous bromide.

PROPERTIES:

Dark red, almost black, oily liquid with an unpleasant odor; hygroscopic; rapidly liberates Br_2 in air, simultaneously separating

Se. Partially decomposed on heating; first, some Br_2 escapes, then some SeBr_4 sublimes, and between 225 and 230°C a part of the Se_2Br_2 boils without decomposition, leaving a residue of Se. d (15°C) 3,604.

In water, Se_2Br_2 sinks to the bottom in oily drops and gradually decomposes into Se, SeO_2 and HBr; soluble in CS_2 and CHCl_3 .

REFERENCES:

- I. J. Meyer and V. Wurm, Z. anorg. allg. Chem. 190, 90 (1930); R. Schneider, Pogg. Ann. 128, 327 (1866).
- II. V. Lenher and C. H. Kao, J. Amer. Chem. Soc. 47, 772 (1925).

Selenium Tetrabromide

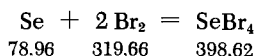

The reaction is carried out in a round-bottom flask equipped with a separatory funnel and gas outlet tube connected to a P_2O_5 -glass wool drying tube. Pure Br_2 (100 g.) is allowed to flow slowly into a suspension of 20 g. of pure powdered Se in 50 ml. of dry CS_2 . Finely crystalline yellow SeBr_4 separates. When the addition is complete, a gas inlet tube is substituted for the separatory funnel and the CS_2 and excess Br_2 are driven off with a dry air stream. The residual SeBr_4 is rapidly transferred into a tightly sealed vessel.

PROPERTIES:

Fine, ochre-yellow crystals with an unpleasant odor reminiscent of S_2Cl_2 ; hygroscopic; decomposes in moist air to Br_2 , Se_2Br_2 and reddish-brown Se. On heating, Br_2 evolves. Between 75°C and 80°C, a mixture of SeBr_4 and Se_2Br_2 sublimes, forming black, shiny crystals.

With water, SeBr_4 forms a clear solution of H_2SeO_3 and HBr.

REFERENCES:

- J. Meyer and V. Wurm, Z. anorg. allg. Chem. 190, 90 (1930).
See also R. Schneider, Pogg. Ann. 129, 450 (1866).

Selenium Dioxide



A large porcelain boat containing 60 to 75 g. of Se is pushed into the front end of a Pyrex glass tube (50-70 cm. long, 4-5 cm. in diameter); the tube is closed with a one-hole rubber stopper, and a fast O₂ stream, which has passed successively through a wash bottle containing fuming HNO₃ and a drying tube containing P₂O₅-glass wool, is introduced. A two-liter, two-neck glass bulb is mounted over the rear end of the tube. The front end of the boat is heated with a fishtail burner so that the Se melts and, shortly afterward, ignites, forming a long, luminous blue flame. The SeO₂ deposits to the rear of the tube, behind the boat. The O₂ stream must be very fast or elemental Se will also distill off and darken the SeO₂. To avoid plugging of the tube, the sublimate is driven forward from time to time by means of a second burner. Traces of SeO₂, which are carried along in the gas stream, are retained in the glass bulb. When all the Se has burned (about 1.25 hours) and only impurities remain in the boat, the product is repeatedly sublimed in the same tube in a pure O₂ stream until it is snow white; this removes small amounts of Se and nitrogen oxide impurities. The SeO₂ is then very pure and completely dry. The yield is about 90%, based on 100% pure Se.

Pure SeO₂ can be stored without decomposition only in carefully cleaned, well-sealed glass containers; even dust reduces it partially to Se. Very hygroscopic.

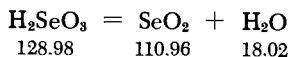
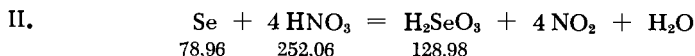

Pure Se is slowly added to pure, concentrated, heated nitric acid, the solution is evaporated to dryness on a sand bath, and the residue is heated until sublimation begins. It is then absorbed in water and, to remove all H₂SeO₄ present, Ba(OH)₂ solution is added dropwise until the precipitate ceases to form. The solution is filtered and reevaporated to dryness while stirring. The crude product is powdered and repeatedly sublimed. For very pure material the compound is sublimed in pure O₂ as in method I. For many purposes, however, it is sufficient to sublime it two or three times from a porcelain dish into an inverted beaker or an inverted funnel

containing a glass wool plug in the stem. The SeO_2 obtained in this manner, in contrast to that obtained in the dry oxidation process I, is not completely anhydrous, but the moisture can be removed by subsequent heating for 3-4 hours in an air stream at 150°C .

PROPERTIES:

White, crystalline substance; poisonous; hygroscopic, forms H_2SeO_3 with moisture; readily discolors in the presence of small amounts of reducing materials (e.g., dust), separating free Se. Sublimes at 315°C , forming shiny needles. Can be melted without decomposition in a closed tube at somewhat higher temperature. d 3.95.

Readily soluble in water (at 20°C about 70 wt.% SeO_2) and alcohol.

Crystallizes in C 47 structure type.

REFERENCES:

- I. J. Meyer, Ber. dtsch. chem. Ges. 55, 2082 (1922).
- II. J. Thomsen, Ber. dtsch. chem. Ges. 2, 598 (1869); V. Lenher, J. Amer. Chem. Soc. 20, 555 (1898); J. Jannek and J. Meyer, Z. anorg. allg. Chem. 83, 51 (1913); L. M. Dennis and J. P. Koller, J. Amer. Chem Soc. 41, 949 (1919); O. Hönigschmid and W. Kapfenberger, Z. anorg. allg. Chem. 212, 198 (1933).

Selenium Oxychloride

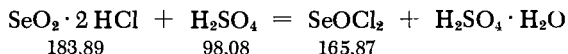
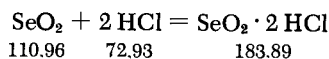

Carefully dried HCl is introduced into a weighed, 150-ml. round-bottom flask containing 50 g. of SeO_2 until all the SeO_2 dissolves, forming $\text{SeO}_2 \cdot 2\text{HCl}$ (theoretical weight increase, 33 g.). The flask must be occasionally shaken and protected from moisture. Since this reaction may be violent, it is best to insert an empty 500-ml. flask between the reaction flask and the wash bottles at the inlet (which are filled with concentrated H_2SO_4 in order to dry the HCl gas). To dehydrate the $\text{SeO}_2 \cdot 2\text{HCl}$, it is treated in the reaction flask for 10 minutes with 10 ml. of concentrated H_2SO_4 while being slowly warmed to 50°C and constantly shaken. The partially dehydrated $\text{SeO}_2 \cdot 2\text{HCl}$ settles as the lower layer; it is then separated in a 100-ml. separatory funnel. The dehydration of the separated layer is repeated under the same conditions, each time

with 5 ml. of concentrated H_2SO_4 , until no further separation takes place. It should be noted that too large an excess of H_2SO_4 , as well as insufficient dehydration, results in low yields and difficulties in the subsequent distillation.

Before the distillation, the cherry-red product is chlorinated until its color becomes straw yellow. In this process, the SeCl_2 is converted to SeCl_4 , which in turn reacts with SeO_2 to form SeOCl_2 . The chlorinated product is distilled twice in aspirator vacuum, using a boiling capillary. The distillation must be protected from moisture; the first milliliter is always discarded. The distillation is continued until fairly large quantities of SeO_2 accumulate, causing heavy bumping. If the product ceases to be straw yellow before the second distillation, additional chlorine may have to be introduced.

Caution: All safety rules must be observed during distillation (safety goggles!) since violent decomposition may occur if the SeOCl_2 was incompletely dehydrated. For this reason, it is always necessary to determine, immediately prior to the distillation, whether the SeOCl_2 is completely dehydrated. (When heated in concentrated H_2SO_4 , SeOCl_2 must form a clear solution.)

The yield is about 50 g., i.e., 68% based on SeO_2 input.

Since the pure product is very hygroscopic, it is transferred in the absence of moisture and stored in glass ampoules sealed off with a torch.

SYNONYM:

Selenyl chloride.

PROPERTIES:

Straw yellow liquid which fumes in moist air; hygroscopic; corrosive to skin. M.p. 11°C , b.p. 179°C with slight decomposition. $d(20^\circ\text{C})$ 2.43. Hydrolyzes in water to form H_2SeO_3 and HCl ; completely miscible with CCl_4 , CHCl_3 , CS_2 , benzene and toluene.

Because of its dissolving ability, SeOCl_2 is occasionally used as a solvent for many substances.

REFERENCE:

G. B. L. Smith and J. Jackson in: L. F. Audrieth, *Inorg. Syntheses*, Vol. III, New York-London, 1950, p. 130.

Selenous Acid (anhydrous)

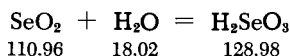

Pure SeO_2 (p. 428) is placed in a porcelain dish and dissolved in a small amount of water. The solution is concentrated on a

water bath with careful exclusion of dust particles (danger of reduction to Se) until crystallization starts. After cooling, the separated H_2SeO_3 is filtered by suction through a fritted glass filter and recrystallized from water. The pure product is pressed between filter papers and dried for several days in a vacuum desiccator over KOH. On prolonged standing over concentrated H_2SO_4 or P_2O_5 , further dehydration to SeO_2 occurs.

PROPERTIES:

Colorless, prismatic crystals, which lose water in dry air, forming SeO_2 , but gradually liquefy in the presence of moisture; poisonous; easily reduced (even by dust) to Se. Melts at about 70°C to form a light yellow solution of SeO_2 in H_2O . d_4^{15} 3.00. Very readily soluble in water.

Crystal form: hexagonal.

REFERENCES:

- A. Rosenheim and L. Krause, Z. anorg. allg. Chem. 118, 177 (1921).
 J. Jannek and J. Meyer, Z. anorg. allg. Chem. 83, 51 (1918).

Sodium Selenite

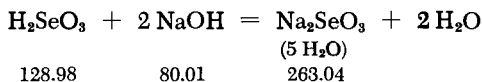
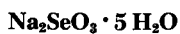

A concentrated aqueous solution of selenous acid is mixed with the stoichiometric quantity of carbonate-free sodium hydroxide solution. The mixture is concentrated at room temperature in vacuum over CaCl_2 , and crystallization is induced by occasionally rubbing the vessel wall with a glass rod. The salt tends to form supersaturated solutions and then precipitates from these in microscopically small needles, which agglomerate into bundles. If these are used for seeding a saturated solution and the latter is allowed to evaporate further, transparent prisms up to 3 mm. long may be obtained. The crystals are filtered by suction through a fritted glass filter and dried on clay in a desiccator (do not place drying agents in the desiccator). The $\text{Na}_2\text{SeO}_3 \cdot 5\text{H}_2\text{O}$ thus obtained is analytically pure.

PROPERTIES:

White crystals, needle-shaped to prismatic; stable in moist air; in dry air, loses water at the surface; poisonous; sensitive to reducing agents. On heating to 40°C, converts to the anhydrous salt.

Very readily soluble in water; 100 g. of solution contains about 68 g. of $\text{Na}_2\text{SeO}_3 \cdot 5\text{H}_2\text{O}$ at 20°C.

REFERENCE:

J. Janitzki, *Z. anorg. allg. Chem.* **205**, 49 (1932).

Selenic Acid

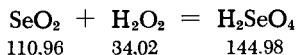

The oxidation is carried out in aqueous solution so that dilute selenic acid solution is obtained first; this may be concentrated to the anhydrous acid by evaporation.

A solution of 150 g. of pure SeO_2 (p. 428) in 100 ml. of distilled water is prepared in a one-liter ground glass flask with a side gas inlet tube extending to the bottom. Then 500 g. of 30% H_2O_2 (Perhydrol) is slowly introduced. The mixture is refluxed for 12 hours while O_2 is passed through. The selenic acid solution formed contains traces of H_2SeO_3 as the only impurity.

To concentrate the solution, most of the water is distilled off in a slow stream of P_2O_5 -dried air and aspirator vacuum until the temperature of the solution reaches 150°C (about four hours are required for this). The acid concentration is then 85-90%. For further dehydration it is distilled at 1-2 mm.; the temperature in the flask should not exceed 160°C, or decomposition to H_2SeO_3 occurs. To avoid local overheating at the flask walls above the liquid level, it is best to heat on a small hotplate and not in an oil bath. When no further H_2O flows into the condenser and the receiver, the oily liquid is transferred to a flat dish and seeded at 10-15°C with a small amount of solid H_2SeO_4 . The latter is obtained by cooling a few milliliters of the solution in a Dry Ice bath. To crystallize the solution, it is allowed to stand in a desiccator over P_2O_5 . The more complete the dehydration during distillation, the more readily will the acid solidify. The crystals are completely dehydrated by standing in a P_2O_5 -dried air stream at 5 mm. for several days. The yield is about 190 g. of 97-98% H_2SeO_4 containing about 2-3% H_2SeO_3 .

PROPERTIES:

Anhydrous H_2SeO_4 forms colorless prismatic or needle-shaped crystals; extremely hygroscopic. M.p. 58°C ; the melt tends to supercool. On heating, decomposes into SeO_2 , O_2 and H_2O . d (solid) (15°C) 2.95, d (liq.) (15°C , supercooled) 2.60.

Readily soluble in water.

REFERENCES:

- L. I. Gilbertson and G. B. King in: L. F. Audrieth, *Inorg. Syntheses*, Vol. III, p. 137, New York-London 1950.
 L. I. Gilbertson and G. B. King, *J. Amer. Chem. Soc.* 58, 180 (1936).

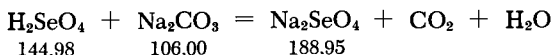
Sodium Selenate

About 210 g. of 85-90% selenic acid solution (p. 432) is used to neutralize 125 g. of C.P. Na_2CO_3 . After filtering, the salt solution is evaporated (with heating) until a significant quantity of sediment is formed. If the solution acquires a slight reddish or brownish color due to colloidal Se, it is rediluted with H_2O , boiled and filtered after standing for 1-2 days. It must then be reconcentrated. The Na_2SeO_4 is suction-filtered from the mother liquor, which is kept as warm as possible (the temperature of the solution must not fall below 45°C), and dried by pressing between filter papers. The salt is analytically pure.

At lower temperature (cooling of the salt solution in ice and filtering while cold), the decahydrate is obtained.

PROPERTIES:

White crystals, stable in air; isomorphous with Na_2SO_4 . d 3.21. Very readily soluble in water.

REFERENCE:

- J. Meyer and W. Aulich, *Z. anorg. allg. Chem.* 172, 321 (1928).

Sodium Selenopentathionate

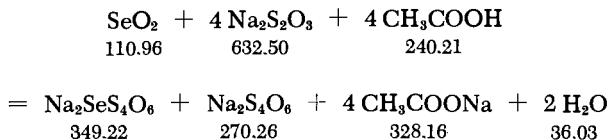

A solution of 130 g. of $\text{Na}_2\text{S}_2\text{O}_3 \cdot 5\text{H}_2\text{O}$ in 40 ml. of H_2O is prepared with heating; the solution is cooled to 25–30°C and is added dropwise over a period of 20 minutes with mechanical stirring to an ice-salt cooled solution of 17.2 g. of FeO_2 and 20 ml. of H_2O in 100 ml. of glacial acetic acid. The reaction temperature may not exceed 0°C. It is of utmost importance that the addition of $\text{Na}_2\text{S}_2\text{O}_3$ be slow since thiosulfate catalyzes the decomposition of the selenopentathionate unless there is a constant excess of H_2SeO_3 . The clear, viscous, yellow-green solution is then mixed with 150 ml. of ethanol; after crystallization begins, 50 ml. of ether is added and the mixture is stirred and cooled for an additional 15 minutes. The crude product, containing about 40 g. of $\text{Na}_2\text{SeS}_4\text{O}_6 \cdot 3\text{H}_2\text{O}$ and 4 mole percent of $\text{Na}_2\text{S}_4\text{O}_6$, is filtered off, washed with ethanol and ether, and dried in vacuum over H_2SO_4 . To recrystallize the salt, it is dissolved in 50 ml. of 0.2N HCl at 30°C and suction-filtered; 100 ml. of methanol is added to the filtrate and the mixture is cooled in an ice-salt bath. Pure $\text{Na}_2\text{SeS}_4\text{O}_6 \cdot 3\text{H}_2\text{O}$ crystallizes; it is filtered, washed with ethanol, and dried in vacuum over H_2SO_4 .

The yield is 25 g. (55%).

PROPERTIES:

Small, pale yellowish-green flakes. Very readily soluble in water, very soluble in methanol, insoluble in ethanol. Aqueous solutions are yellow-green and decompose gradually into selenium and tetrathionate; they can be stabilized by mineral acids; alkalis accelerate the decomposition. The pure salt can be stored over H_2SO_4 for several months without decomposition (Se sometimes separates); readily loses its water of crystallization in vacuum over H_2SO_4 .

REFERENCE:

O. Foss in: H. S. Booth, *Inorg. Syntheses*, Vol. IV, p. 88, New York-London-Toronto, 1953.

Selenium Sulfur Trioxide

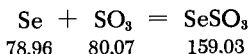

Portions of liquid SO_3 are mixed with small quantities of selenium in a glass tube fused shut at one end and externally cooled with tap water. Between additions, the tube opening is closed with a one-hole stopper leading to a P_2O_5 -filled absorption flask. The reaction is exothermic; the temperature must be so adjusted that the SO_3 is just above its solidification point (about 15°C). The SeSO_3 product settles to the bottom and on the walls as a thick, dark-green oil which eventually solidifies. When all the Se has reacted, the supernatant clear SO_3 is decanted and any traces are removed by suction-filtration. The remaining scaly SeSO_3 is rapidly loosened from the walls with a sharp-edged glass rod and transferred to ampoules, which are sealed.

PROPERTIES:

Dark-green crystalline substance; stable for some time at room temperature without decomposition; sensitive to moisture. On heating, SeSO_3 decomposes, becoming first brown then yellow, then orange and finally red, and forming SO_2 , SeO_2 and Se.

Violent reaction with water, yielding H_2SO_4 , H_2SO_3 , H_2SeO_3 and Se. Soluble in oleum and concentrated sulfuric acid, giving a green solution.

REFERENCES:

- R. Weber, Pogg. Ann. 156, 531 (1875).
E. Divers and M. Shimosé, J. Chem. Soc. (London) 45, 201 (1884);
Ber. dtsh. chem. Ges. 17, 858 (1884).

Selenium Nitride



Caution! Se_4N_4 is a very explosive substance. Even very small mechanical disturbances and mild action of chemicals cause extremely violent explosive decomposition. The strictest safety precautions must therefore be observed in handling this material.

REACTION OF AMMONIA WITH DIETHYL SELENITE IN BENZENE SOLUTION

The starting materials for preparing diethyl selenite are $\text{C}_2\text{H}_5\text{ONa}$ and SeOCl_2 . A solution of 20 g. of Na in 200 ml. of

absolute C_2H_5OH is prepared in a reflux apparatus. When the reaction is complete, most of the C_2H_5OH is distilled off and 70 g. of pure $SeOCl_2$ (p. 429) is allowed to drip onto the slurry; the latter is cooled with an ice bath and is frequently swirled around. The product, which has a strawberry color because of a slight Se precipitate, is extracted with ether and the ether solution dried with Na_2SO_4 . Most of the ether is distilled off on a water bath, and the residue is fractionated twice in aspirator vacuum. The ester, a water-clear liquid, is collected between 83 and 85°C at 14 mm.

The conversion to Se_4N_4 is carried out in a 100-ml., round-bottom flask, closed with a three-hole rubber stopper. The stopper holds a separatory funnel, a gas inlet tube extending to the bottom, and a gas outlet tube leading to a drying tower filled with soda lime. Sodium-dried benzene (20 g.) is placed in the flask, and the apparatus is flushed with dry NH_3 until all air is displaced. The NH_3 stream is continued and 3.1 g. of diethyl selenite is slowly added drop-by-drop. An initially green suspension forms. The color soon turns to red-brown as N_2 is evolved. After 1.75 hours, the precipitate is suction-filtered and carefully dried at 105°C. To remove SeO_2 and Se, it is then successively washed with water, 10% KCN solution, and finally again with water to remove CN. Pure Se_4N_4 is best stored under benzene because of its explosive nature. The dry substance may not be placed in glass stoppered bottles since the contents generally explode when such bottles are opened. Cardboard boxes are the best containers.

Other preparative methods: Reaction of SeO_2 , $SeCl_4$ or $SeBr_4$ with liquid ammonia in a steel autoclave at 70-80°C (Jander and Doetsch).

PROPERTIES:

Formula weight 371.87. Orange-red, amorphous powder; becomes crystalline after prolonged standing under benzene; under the influence of light pressure or strong heating, explodes with great brisance.

Insoluble in water; slowly decomposed by boiling water to yield H_2SeO_3 , Se and NH_3 . Slightly soluble in glacial acetic acid.

REFERENCES:

- W. Strecker and H. E. Schwarzkopf, Z. anorg. allg. Chem. 221, 193 (1934).
H. E. Schwarzkopf, Thesis, Marburg, 1932.
J. Jander and V. Doetsch, Angew. Chem. 70, 704 (1958).
J. Jander and V. Doetsch, Chem. Ber. (in press).

Tellurium

Te

VERY PURE TELLURIUM

Commercial tellurium must generally be further purified for most laboratory uses since it contains some TeO_2 as well as small amounts of Se, S and heavy metals (particularly Cu, Pb and Ag). It should be noted that Te is a strong respiratory poison. The metal is distilled in a hydrogen stream and converted to the readily crystallizable basic salt $\text{Te}_2\text{O}_3(\text{OH})\text{NO}_3$; the latter is purified by repeated recrystallization, ignited to the oxide, and reduced in hydrochloric acid solution with hydrazine to form elemental Te. To achieve an ultrapure product, the metal is then distilled in high vacuum.

Prior to the prepurification by distillation in a hydrogen stream, the Te is pulverized in an agate mortar and placed in a large quartz boat inserted in the forward section of a quartz tube. The boat is gradually heated to red heat while a moderately fast stream of pure, dry hydrogen is passed over it. The Te melts and, with increasing temperature, gives off a greenish-yellow vapor which is carried along by the H_2 and condenses in small metallic balls in the colder section of the tube. The distillation is interrupted when about 90% of the Te has vaporized. All less volatile metals are found in the residue. After cooling in a stream of H_2 the distilled Te can be readily loosened from the tube wall and taken out with platinum forceps.

The prepurified product is dissolved in concentrated hydrochloric acid containing some nitric acid; excess nitric acid is decomposed by prolonged heating and the solution is diluted with water, taking care not to exceed the point at which hydrolysis (TeO_2 separation) would occur. The solution is filtered to remove any impurities which may be present, and is then reduced with freshly distilled hydrazinium hydroxide solution. The Te precipitate is washed with water and then alcohol and dried in a vacuum desiccator over concentrated H_2SO_4 . The finely divided metal is then dissolved in nitric acid (d 1.25) at 70°C . Higher temperatures are to be avoided because of the precipitation of considerable quantities of rather insoluble TeO_2 . As the solution is concentrated, the basic nitrate $\text{Te}_2\text{O}_3(\text{OH})\text{NO}_3$ precipitates in large, well formed crystals. The salt is again recrystallized from nitric acid of the same concentration. After drying, it is ignited to TeO_2 in a porcelain crucible in an electric furnace. The dioxide is dissolved in hydrochloric acid (d 1.12) and reduced to Te with hydrazinium hydroxide solution; the Te is washed and dried as above. Since the metal powder is always partially reoxidized

to TeO_2 by atmospheric oxygen, the product powder is melted in a quartz boat while a pure hydrogen stream is passed over it. It is kept liquid until all the TeO_2 is reduced and the whole surface is shiny. To obtain an ultrapure product, the metal can then be distilled from a quartz boat placed in a quartz tube closed at one end; this is done in high vacuum and at as low a temperature as possible.

The purity of the product is determined most reliably by spectral analysis.

A process for preparing Te single crystals is given by Schmid and Wassermann; it involves melting the pure metal in narrow tubes, followed by very slow solidification.

REFERENCES:

- O. Hönigschmid, R. Sachtleben and K. Wintersberger, *Z. anorg. allg. Chem.* 212, 242 (1933).
 O. Hönigschmid and H. Baudrexler, *Z. anorg. allg. Chem.* 223, 91 (1935).
 A. Stähler and B. Tesch, *Z. anorg. allg. Chem.* 98, 1 (1916).
 E. Schmid and G. Wassermann, *Z. Phys.* 46, 653 (1928).

Colloidal Tellurium Solution

Stable Te sols are obtained by the reduction of telluric acid with hydrazinium hydroxide.

A solution of 2-3 g. of very pure H_6TeO_6 (p. 451) in one liter of very pure water (see section on Hydrogen, Deuterium, Water, p. 117) is prepared and heated on a water bath to 40-50°C. Higher temperatures may cause a yellow color in the subsequent reduction. A very dilute aqueous N_2H_4 solution (1 : 2000) is added dropwise to the warm H_6TeO_6 solution until the color of the hydrosol no longer changes. An excess of reducing agent should be avoided since it renders the sol very unstable and causes coagulation. The liquid is transferred into a dialyzer or parchment paper bag and is dialyzed until completely pure; the exterior water is frequently renewed.

REFERENCES:

- A. Gutbier, *Z. anorg. allg. Chem.* 32, 51 (1902); *Kolloid-Z.* 4, 180 (1909).

Hydrogen Telluride



Since H_2Te is a poisonous gas with an unpleasant odor and, when inhaled in large quantities, greatly irritates the bronchial

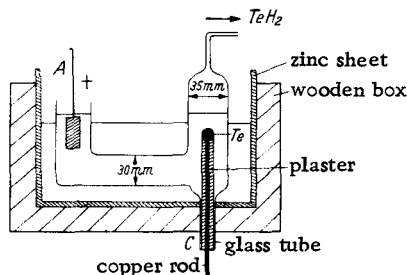

Fig. 169. Preparation of hydrogen telluride.

tubes and damages the nervous system, its preparation must be carried out in a good hood and in carefully sealed apparatus.

I. CATHODIC REDUCTION OF Te

Electrolytic preparation of H_2Te is generally preferred to the method of acid decomposition of tellurides (see II) because the yield is higher.

The apparatus of Fig. 169 is used. The electrolysis flask proper, which is made of glass, stands in a zinc tub surrounded by thermal insulation and an external wooden box. The cathode is introduced from below through adapter tube *C*. The cathode is made from a thin-wall glass tube which is fused and closed at one end. A few grams of pure Te are melted in the tube and a copper wire is inserted before the melt solidifies. After cooling, the space above the Te is filled with plaster of Paris. The tube tip at the tellurium end is then cracked by scratching, warming it slightly, and immersing it in water. The tellurium is thus exposed. The anode *A* is of platinum foil. The electrolysis vessel is filled to the upper edge of the anode with 50% sulfuric acid and is cooled from the outside by a Dry Ice bath. The run is conducted in a darkened room since, according to Hempel and Weber, H_2Te decomposes more rapidly in light. The electrolysis proceeds at 4.5 amp. and 75-110 v., and the pressure is so adjusted that only a thin layer of acid is found above the Te at the cathode. The electrolyte temperature is maintained at $0^\circ C$ by balancing the exterior cooling and the heat produced by the current. The evolving gas mixture, which contains up to 45% H_2Te (besides the H_2), is dried by passage through two U tubes containing $CaCl_2$ and P_2O_5 -glass wool (no rubber connections may be used), and is then condensed in a trap cooled with liquid nitrogen. As usual, the trap is protected against atmospheric moisture by a drying tube. The gas obtained after reevaporation is sufficiently pure for most purposes.

If a very pure product is required, the traces of inert gas are removed by repeated melting and solidification in vacuum by fractionation or sublimation in high vacuum; a considerable amount of the first and last cuts is rejected.

Hydrogen telluride is stored in the dark either as a solid at low temperature or in the vapor state in torch-sealed glass flasks. Mercury may not be used as a sealing liquid since it is attacked even by carefully dried H_2Te .

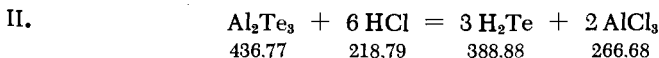

The Al_2Te_3 used as starting material is prepared from the elements according to the method of Moser and Ertl (see section on Aluminum).

The acid decomposition is carried out in the apparatus shown in Fig. 170, which permits the introduction of the telluride into the acid in an inert gas stream. All parts of the apparatus must be carefully dried before assembly since H_2Te is decomposed by moisture, with Te precipitation. Hydrochloric acid (4N) is boiled

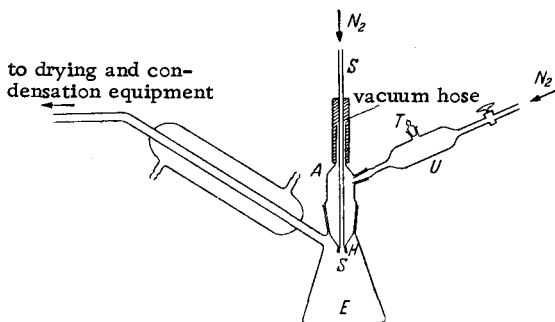

Fig. 170. Preparation of hydrogen telluride.

and then cooled in a N_2 stream. The reaction flask E (100 ml.) is filled with this acid. The entire experiment is done in an atmosphere of pure N_2 , which is introduced through the side arm U and the hollow piston rod S whose conical end fits into the ground glass joint H of adapter A . When the air has been displaced from the apparatus, coarsely powdered Al_2Te_3 is rapidly introduced at T . By tilting or slight tapping of the apparatus, the powder is gradually transferred into adapter A ; by slight downward motion of the piston rod, small portions are introduced into the acid. At the end, flask E is heated to a moderate temperature for a short time in order to complete the gas evolution. The H_2Te passes through a small water-cooled condenser which forms a side

arm of E and through two drying tubes filled with CaCl_2 and P_2O_5 -glass wool, and is frozen in a trap cooled with liquid nitrogen and protected against moisture by a drying tube. When pure starting materials are used, the product is generally sufficiently pure; it can be further fractionated via the procedure given in method I.

PROPERTIES:

Formula weight 129.63. Colorless gas, unpleasant odor reminiscent of AsH_3 ; poisonous. Decomposes with Te separation with even traces of air or moisture, also with cork and rubber. Whenever possible, ground glass joints should therefore be used. The liquid is instantaneously decomposed by light, which produces discoloration; whether or not light accelerates the decomposition of the gas as well is not certain as the data existing in the literature are contradictory. According to Moser, pure dry H_2Te is stable even in ultraviolet light.

M.p. -49°C , b.p. -2°C . Begins to decompose into the elements slightly above room temperature. $d(\text{liq.}) (-12^\circ\text{C})$ 2.68; weight per liter 6.234 g.

Soluble in water with rapid decomposition; the saturated solution is about 0.1N.

REFERENCES:

- I. W. Hempel and M. G. Weber, *Z. anorg. allg. Chem.* **77**, 48 (1912); see also A. Klemenc, *Die Behandlung und Reindarstellung von Gasen* [Treatment and Purification of Gases], Leipzig, 1938, p. 186; L. M. Dennis and R. P. Anderson, *J. Amer. Chem. Soc.* **36**, 882 (1914).
- II. L. Moser and K. Ertl, *Z. anorg. allg. Chem.* **118**, 269 (1921).

Sodium Telluride, Potassium Telluride

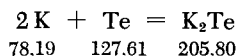
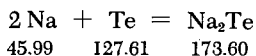

The synthesis is carried out in liquid NH_3 with exclusion of air and moisture. For the apparatus and procedure, see K_2S (p. 360). The directions may be followed in all details; the compounds Na_2Te and K_2Te prepared accordingly are analytically pure.

PROPERTIES:

Na_2Te : White crystalline powder; very hygroscopic; decomposes immediately in air, becoming dark; crystallizes in the C1

structure type. M.p. 953°C; d 2.90. Soluble in water; on contact with air, the solution rapidly precipitates black Te powder.

K_2Te : Faintly yellow, crystalline substance; hygroscopic; decomposes instantaneously on contact with air with Te precipitation. Crystallizes in C1 structure type. d 2.52. Soluble in water; the solution precipitates Te in air.

REFERENCE:

W. Klemm, H. Sodomann and P. Langmesser, *Z. anorg. allg. Chem.* **241**, 281 (1939).

Sodium Ditelluride

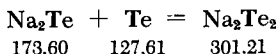

The stoichiometric quantity of Te and 2.5 g. of Na_2Te are introduced in a rapid stream of pure N_2 into a Pyrex tube, closed at one end. The tube is evacuated with a high-vacuum pump, the open end is melted shut under vacuum, and the tube is heated in an electric furnace to 500°C until a homogeneous melt is formed (about 45 min.). After cooling, a gray-black, very hard mass of Na_2Te_2 is obtained.

PROPERTIES:

Gray-black, metallic, shiny microcrystalline substance; decomposes in the presence of air and moisture.

REFERENCES:

W. Klemm, H. Sodomann and P. Langmesser, *Z. anorg. allg. Chem.* **241**, 281 (1939).

W. Klemm and H. Sodomann, *Z. anorg. allg. Chem.* **225**, 273 (1935).

Tellurium Tetrachloride

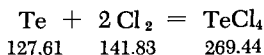

The synthesis is carried out in the glass apparatus shown in Fig. 171; because of the extreme hygroscopicity of $TeCl_4$, all

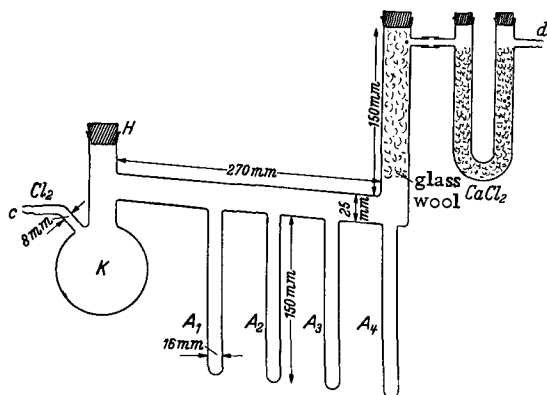

Fig. 171. Preparation of tellurium tetrachloride.

connections are glass fused to glass. The number of sealable ampoules A_1 , A_2 , etc., can be varied depending on the number of individual samples desired. The apparatus is dried in a drying oven for 12 hours prior to the run. Then 50 g. of pure Te (powder or coarse fragments of Te sticks) is placed in the still warm flask K through H . Opening H is then closed, c is clamped shut, and the whole apparatus is heated by fanning with a flame to remove the last traces of water film; at the same time, the apparatus is evacuated through d . When the apparatus is cooled down, the connection to the vacuum line is broken and the apparatus is rinsed with dry, O_2 -free N_2 introduced at c . When all air is displaced, a slow stream of dry, O_2 -free Cl_2 (p. 272) is introduced and K is carefully heated at the same time with a Bunsen burner to initiate the reaction. The flame can be removed as soon as the reaction starts. The contents of the flask liquefy after some time. They turn black at first, then transparent and dark red, and finally amber yellow. Toward the end of the reaction, K is again slightly heated. When the product has become pure yellow, dry Cl_2 -HCl mixture is passed through for some time with slight heating, in order to decompose any oxychloride that might have formed. At the end, the product is distilled into the ampoules in a slow Cl_2 stream, the heat being supplied by fanning with a flame. The ampoules are then sealed. The yield is 95 g. of pure $TeCl_4$.

PROPERTIES:

Fine, white crystals; very hygroscopic; deliquesces in moist air with partial hydrolysis. M.p. $224^\circ C$, b.p. $390^\circ C$; d 3.01. The melt is yellow, the vapor orange-red.

Hydrolyzes with water to form HCl and TeO_2 . Soluble in absolute alcohol and toluene.

REFERENCES:

- J. F. Suttle and C. R. F. Smith in: L. F. Audrieth, *Inorg. Syntheses*, Vol. III, p. 140, New York-London 1950.
 J. F. Suttle and R. P. Geckler, *J. Chem. Ed.* **23**, 135 (1946).
 O. Hönigschmid and H. Baudrexler, *Z. anorg. allg. Chem.* **223**, 91 (1935).
 A. Stähler and B. Tesch, *Z. anorg. allg. Chem.* **98**, 1 (1916).

Hexachlorotellurium Salts

The required stock solution of TeCl_4 in hydrochloric acid is best prepared by treating Te powder with aqua regia, evaporating this solution to dryness, and taking up residue in as little concentrated hydrochloric acid as possible.

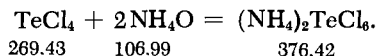
 $(\text{NH}_4)_2\text{TeCl}_6$ 

Concentrated aqueous NH_4Cl solution is added to the TeCl_4 solution in hydrochloric in such a quantity that the mixture is just at the point of NH_4Cl precipitation. On prolonged standing in air, the yellow complex salt precipitates in beautiful, relatively large octahedra. The precipitation can be accelerated and completed by passage of HCl and cooling. The salt is considerably less moisture-sensitive than the analogous selenium compound. After suction-filtration and pressing between filter papers, it can therefore be dried in air and stored in a desiccator.

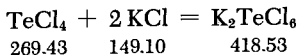
 K_2TeCl_6 

The TeCl_4 solution is mixed with aqueous KCl solution in a ratio not exceeding one mole of KCl per mole of TeCl_4 ; precipitation should not be allowed to occur. The precipitation procedure corresponds to that for $(\text{NH}_4)_2\text{TeCl}_6$. Since the K salt is considerably more sensitive to atmospheric moisture than the NH_4 salt, it is best to dry it in the apparatus described for the preparation of hexachlorotitanium salts (see section on Titanium).

The Rb and Cs chloro complex salts are prepared analogously. For the preparation of Tl_2TeCl_6 , see G. Engel.

PROPERTIES:

$[(\text{NH}_4)_2\text{TeCl}_6 \text{ and } \text{K}_2\text{TeCl}_6]$: yellow, octahedral crystals, about 0.1 mm. in diameter; decompose gradually in air, particularly when moistened with hydrochloric acid, with color loss and HCl evolution. The NH_4 salt is considerably more stable than the K salt. Both are very readily soluble in water, hydrolyzing to tellurous and hydrochloric acids. Dissolve without decomposition in not too dilute hydrochloric acid, the K salt more readily than the NH_4 salt. The latter can be recrystallized from hydrochloric acid.

CRYSTAL STRUCTURE:

$[(\text{NH}_4)_2\text{TeCl}_6; \text{K}_2\text{PtCl}_6]$ structure type; K_2TeCl_6 : optically a bi-axially negative crystal; monoclinic, pseudocubic lattice; deviation from the K_2PtCl_6 structure type is only slight.

REFERENCES:

- W. Muthmann and J. Schäfer, Ber. dtsch. chem. Ges. 26, 1004 (1893).
 H. L. Wheeler, Z. anorg. allg. Chem. 3, 434 (1893).
 A. Gutbier, F. Flury and H. Micheler, J. prakt. Chem. [2] 83, 153 (1911).
 G. Engel, Z. Kristallogr. 90, 357 (1935).

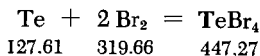
Tellurium Tetrabromide

Pure Te (5 g.) is introduced through adapter *a* into the elongated reaction flask *A* of the apparatus shown in Fig. 172. Adapter *a* is connected to a N_2 purification train which furnishes either pure dry N_2 or N_2 containing bromine vapor. For the latter, the gas stream may be passed through a wash bottle containing dry Br_2 , followed by a U tube containing P_2O_5 -glass wool. First, the apparatus is purged with pure N_2 . Then *A* is cooled with ice water and the N_2 - Br_2 mixture is introduced. A portion of the Br_2 condenses on the Te and reacts quietly with it, while the remainder is retained in the empty U tube *D*, cooled with an ice-salt mixture. The difference between the weight loss of the Br_2 wash bottle and the weight of the condensate in *D* indicates the amount of bromine remaining in *A*. When this becomes about twice the amount needed for quantitative conversion to TeBr_4 , the gas stream is interrupted, stopcock *C* is closed, and the product slurry is allowed to stand at room temperature for several hours (better overnight) in order to complete the reaction. Then *C* is reopened and the excess

bromine is purged by a stream of N_2 while A is simultaneously heated to $50^\circ C$. To purify the product, it is sublimed in vacuum. Gas inlet tube a is sealed off at d , the whole apparatus is tilted to a horizontal position, and ground glass joint E is connected to an aspirator through a P_2O_5 drying tube. During evacuation, A is heated to sublimation temperature (about $350^\circ C$) with an electric furnace. Any black condensate which may separate in B at $200^\circ C$ is vaporized by heating with a burner. The subsequently deposited yellow to orange-red powder is quite pure $TeBr_4$; if necessary, this can be further purified by an analogous sublimation in high vacuum. Because of its hygroscopicity, the product is either immediately sealed in the condensation receiver or is rapidly transferred to a well-sealed vessel.

PROPERTIES:

Yellow to orange, hygroscopic crystals. On heating, partially decomposes with Br_2 evolution; for this reason, $TeBr_4$ cannot be melted or distilled at atmospheric pressure without decomposition. d ($15^\circ C$) 4.31.

Hydrolyzes in water; soluble in hydrobromic acid, ether and glacial acetic acid.

REFERENCES:

O. Hönigschmid, R. Sachtleben and K. Wintersberger, Z. anorg. allg. Chem. 212, 242 (1933).

B. Brauner, Mh. Chem. 10, 411 (1889).

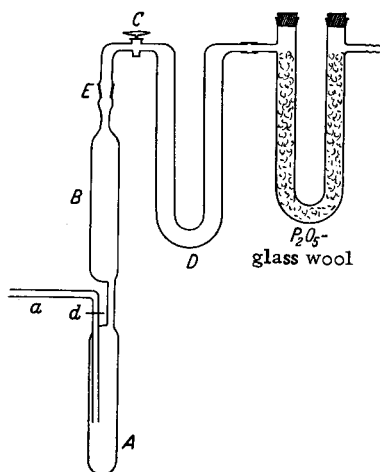
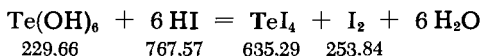

Fig. 172. Preparation of tellurium tetrabromide.

Tellurium Tetraiodide

A very concentrated H_5TeO_6 solution (p. 451) is mixed at room temperature with slightly more than the stoichiometric quantity of fuming hydriodic acid (d 2.00). A heavy, gray precipitate of TeI_4 immediately separates. It is suction-filtered on a fritted glass filter and freed of traces of hydriodic acid by pressing on clay. Concentration of the mother liquor at room temperature yields a considerable additional amount of the compound. When dry, the crystals are washed several times with pure CCl_4 to remove iodine and are finally pulverized under CCl_4 until the continuously renewed wash fluid no longer is colored. The product is then analytically pure.

PROPERTIES:

Iron-gray crystalline substance; stable even in moist air. Decomposes on heating, giving off I_2 . M.p. (closed tube) 280°C ; d (15°C) 5.05.

Hydrolyzed slowly in cold water, rapidly in warm water, forming TeO_2 and HI. Soluble in hydriodic acid, forming $\text{H}(\text{TeI}_5)$; slightly soluble in acetone.

REFERENCES:

A. Gutbier and F. Flury, Z. anorg. allg. Chem. **32**, 108 (1902).
See also M. Damiens, Ann. Chim. [9] **19**, 44 (1923).

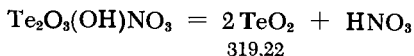
Tellurium Dioxide

Concentrated nitric acid (95 ml.; d 1.42) is slowly added to a suspension of 20 g. of Te powder (commercial grade) in 200 ml. of distilled water in a one-liter beaker. The mixture is allowed to

stand for about 10 minutes with occasional shaking. Any impurities which have not dissolved after this time (selenides, tellurides, etc.) are rapidly suction-filtered, and the filtrate is mixed with another 65 ml. of concentrated nitric acid. The solution is boiled until all oxides of nitrogen are removed. If the Te contained any Sb or Bi, the basic nitrates of these elements separate and, if necessary, are filtered through a fritted glass suction filter. The clear solution is concentrated to 100 ml. on a water bath, using a 600-ml. beaker; it is then allowed to cool and is suction-filtered to remove the crystallized $\text{Te}_2\text{O}_3(\text{OH})\text{NO}_3$. The salt is washed with water and dried on clay in air. In order to convert it to TeO_2 , it is heated for two hours at 400-430°C (sand bath or hotplate) in a porcelain dish protected from dust by an inverted beaker (to avoid reduction to Te). The TeO_2 product is pure white and is analytically pure. If the starting material is very impure, the $\text{Te}_2\text{O}_3(\text{OH})\text{NO}_3$ may again be recrystallized from nitric acid (d 1.25) before the ignition. Immediately after cooling, the pure product is transferred into a tightly sealed clean vessel to prevent any discoloration by the reducing action of organic substances in the atmosphere. Assuming that good quality commercial Te is used, the yield is about 21 g. or 84%.

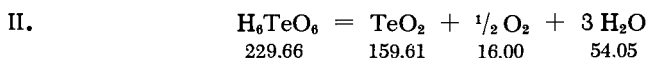

Pure H_6TeO_6 (p. 451) is heated in a porcelain crucible. The heating is done in two stages: first the material is heated slowly to 150-200°C until most of the water is driven off; then it is ignited for some time at about 600°C. If the conversion to TeO_2 is quantitative, the crucible contents are pure white after cooling. If the material is yellowish, the product still contains TeO_3 and must be heated further. The purity of the TeO_2 product is determined by that of the H_6TeO_6 used.

PROPERTIES:

White crystals; not hygroscopic; discolors in the presence of organic materials because of partial reduction. M.p. 733°C; the melt is dark yellow. d 6.02.

Very slightly soluble in water (about 1 : 150,000); soluble in concentrated mineral acids and alkalis, with salt formation.

Crystallizes in C 4 structure type.

REFERENCES:

- I. H. Marshall in: L. F. Audrieth, *Inorg. Syntheses*, Vol. III, p. 143, New York-London, 1950; see also P. L. Baynton, *Nature* 176, 691 (1955).

- II. L. Staudenmaier, *Z. anorg. allg. Chem.* **10**, 189 (1895); W. Marckwald, *Ber. dtsch. chem. Ges.* **40**, 4730 (1907).

Tellurous Acid

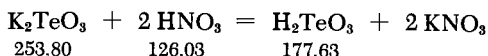

The K_2TeO_3 stock solution is made by dissolving pure Te (p. 437) in dilute HNO_3 , evaporating to dryness, and dissolving the residue in 10% KOH . The solution is colored with one drop of phenolphthalein and mixed at 0°C with dilute HNO_3 , added dropwise from a burette, until it is colorless. A white — first flaky, then finely powdered — precipitate of H_2TeO_3 separates. It is filtered and thoroughly washed with ice water until the wash water is free of NO_3^- and K^+ ions. The product is stored under distilled water since, in the dry state, it readily loses H_2O , forming TeO_2 hydrates of lower water contents.

PROPERTIES:

White, amorphous substance of varying composition; H_2O content is frequently less than that corresponding to the formula H_2TeO_3 ; loses water when dry but can be stored under H_2O for several days without change.

On heating above room temperature, extensively loses water with conversion to TeO_2 . Very slightly soluble in water (at 18°C about $3.0 \cdot 10^{-6}$ moles/liter).

REFERENCES:

- J. Kasarnowsky, *Z. phys. Chem.* **109**, 287 (1924).
E. B. R. Prideaux and J. O. N. Millott, *J. Chem. Soc. (London)* **1929**, 2703.

Sodium Tellurite

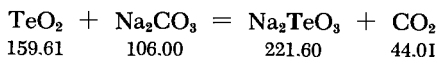

Stoichiometric quantities of pure TeO_2 (p. 447) and C. P. Na_2CO_3 are melted together in a Pt crucible. In order to prevent

oxidation to tellurate, the heating must be carried out in a CO_2 atmosphere. As soon as gas evolution stops and a clear melt is obtained, the latter is allowed to cool under CO_2 . The white crystalline mass is Na_2TeO_3 .

PROPERTIES:

White crystalline substance; converts to Na_2TeO_4 when heated in air.

Very readily soluble in water; the solution is decomposed by atmospheric CO_2 , yielding TeO_2 .

REFERENCE:

V. Lenher and E. Wolessensky, J. Amer. Chem. Soc. 35, 718 (1913).

Tellurium Trioxide

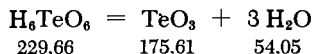

I. $\alpha\text{-TeO}_3$

Pure H_6TeO_6 (p. 451) is slowly heated to $300\text{--}320^\circ\text{C}$ in a porcelain crucible with occasional stirring. When all the H_2O has been driven off, the material is cooled and mixed several times with concentrated hydrochloric acid to remove any TeO_2 which might have formed. The washing flask should be cooled. The pure TeO_3 is then thoroughly washed with water and dried at 100°C . The yield is about 30%.

PROPERTIES:

Bright yellow powder which, in contrast to $\beta\text{-TeO}_3$, gives no powder pattern.

On heating, $\alpha\text{-TeO}_3$ becomes brown at about 200°C , and above 400°C decomposes to TeO_2 and O_2 . $d(15^\circ\text{C})$ 5.075.

Nearly insoluble in cold water, but noticeably soluble on long standing in hot water, forming H_6TeO_6 . Soluble in strong alkali, forming tellurates.

II. $\beta\text{-TeO}_3$

Pure H_6TeO_6 is mixed with a few drops of concentrated H_2SO_4 and heated for 12-15 hours at about 320°C in a torch-sealed tube.

In order to remove α -TeO₃, the product is then boiled with concentrated KOH solution and the resulting solution is filtered with suction through a fritted glass filter. The β -TeO₃ product is washed thoroughly with water and dried at 100°C. The yield is about 40%.

PROPERTIES:

Gray, microcrystalline substance which, in general, is considerably less reactive than α -TeO₃. On heating above 400°C, decomposes into TeO₂ and O₂. d 6.21.

Insoluble in water; even hot acids and concentrated alkali do not attack it and do not form salts.

REFERENCES:

E. Montignie, Z. anorg. allg. Chem. 252, 111 (1943); 253, 90 (1945).
Bull. Soc. Chim. France, Mem. 1947, 564.

Telluric Acid

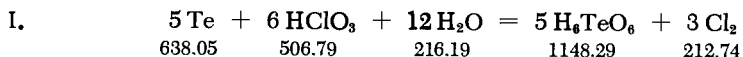

The starting materials are very fine Te powder and aqueous HClO₃ solution. The acid required for the oxidation of 0.1 mole (that is, 12.75 g.) of Te is prepared by adding a lukewarm mixture of 40 ml. of H₂O and 7.2 ml. of concentrated H₂SO₄ to a solution of 24 g. of Ba(ClO₃)₂·H₂O in 100 ml. of H₂O. After about five hours, the solution is decanted from the precipitated BaSO₄ through a filter, and if desired the residue is extracted once with H₂O. To oxidize the Te, it is added to a 500-ml., round-bottom flask placed under the hood. It is then moistened with 5 ml. of 50% HNO₃ and about one fourth of the HClO₃ solution. With thorough agitation (by swirling) the flask contents soon boil and the reaction proceeds at boiling with strong Cl₂ evolution to form H₆TeO₆. The reaction should definitely not be slowed by intermittent cooling. If white flakes (H₂TeO₃ or TeO₂) should form in the liquid, the contents of the flask must be continuously boiled. As soon as the evolution of Cl₂ subsides, the rest of the HClO₃ solution is added in several large portions while the solution is again kept boiling and is constantly agitated. After 30 minutes, the reaction is complete and all the Te should be dissolved. The clear liquid is now concentrated in a porcelain dish, first over a free flame and

finally on a water bath, until crystals begin to separate (the solution volume is about 1/3 of the original at this point). The dish is then set on ice; the acid separates with stirring as a fine, pure-white crystalline powder. The precipitate is suction-filtered through fritted glass and dissolved once more in hot distilled H₂O in order to remove traces of HCl. The solution is mixed with a few drops of dilute AgNO₃. After filtering off the AgCl, the solution is evaporated until crystallization begins. When the liquid is cooled slowly, the acid separates in beautiful, water-clear crystals up to 2 cm. long. It is suction-filtered through fritted glass, washed with water at 0°C, then with alcohol and ether, and dried in a vacuum desiccator over P₂O₅. By mixing the mother liquor with an equal volume of alcohol, a further finely crystalline fraction, somewhat more soluble in cold H₂O, may be obtained. The total yield is 90-95%.

Other preparative methods:

II. OXIDATION OF TeO₂ WITH KMnO₄ IN NITRIC ACID SOLUTION:

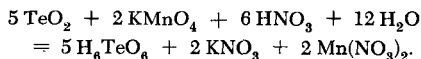

The process is somewhat more cumbersome than method I since it requires, among other things, separate preparation of TeO₂ as well as repeated recrystallization of the acid to quantitatively remove the simultaneously formed salts. The yield is 75-85%. For detailed description of the procedure, see the literature below.

III. Reaction of Te or TeO₂ with 30% H₂O₂ in sulfuric acid or alkaline solution and subsequent precipitation of H₆TeO₆ with concentrated nitric acid.

IV. Oxidation of Te with HNO₃ and CrO₃. The product must be recrystallized several times in order to remove the Cr(NO₃)₃ by-product.

PROPERTIES:

Formula weight 229.66. Colorless crystals, stable in air. May occur in a monoclinic modification (space group C_{2h}⁵) and a cubic modification (space group O_h⁶); the large crystals are generally monoclinic while the microcrystalline powder frequently consists of a mixture of both forms.

Heating H₆TeO₆ between 100 and 220°C converts it to solid, water-insoluble polymetatelluric acid; the latter decomposes above 220°C into TeO₃, and at 400°C or higher into TeO₂ and O₂. Melts in a sealed tube at about 136°C, forming a concentrated aqueous solution of polymetatelluric acid and some polyorthotelluric acid. d (monoclinic) 3.071; d (cubic) 3.17.

Readily soluble in water; very slightly soluble in concentrated nitric acid.

REFERENCES:

- I. J. Meyer and M. Holowatyj, Ber. dtsh. chem. Ges. 81, 119 (1948); J. Meyer and W. Franke, Z. anorg. allg. Chem. 193, 191 (1930).
- II. F. C. Mathers, C. M. Rice, H. Broderick and R. Forney in: L. F. Audrieth, Inorg. Syntheses, Vol. III, p. 145; New York-London, 1950.
- III. L. I. Gilbertson, J. Amer. Chem. Soc. 55, 1460 (1933); A. Gutbier and W. Wagenknecht, Z. anorg. allg. Chem. 40, 260 (1904).
- IV. L. Staudenmaier, Z. anorg. allg. Chem. 10, 189 (1895).

Sodium Tetrahydrogentellurate (VI)

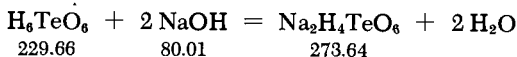

A moderately concentrated H_6TeO_6 solution (p. 451) is mixed at the boiling point with the stoichiometric quantity of concentrated NaOH solution and is kept boiling for a short time. A microcrystalline, granular precipitate of $\text{Na}_2\text{H}_4\text{TeO}_6$ separates. When the solution has cooled, it is filtered by suction, washed with water at 0°C , and dried in a desiccator over CaCl_2 . The salt thus obtained is analytically pure.

PROPERTIES:

White crystals, stable in air. Decomposes into Na_2TeO_3 when vigorously heated. Very slightly soluble in water.

REFERENCES:

- J. Meyer and M. Holowatyj, Ber. dtsh. chem. Ges. 81, 119 (1948).
- A. Gutbier, Z. anorg. allg. Chem. 31, 340 (1902).
- A. Rosenheim and G. Jander, Kolloid-Z. 22, 23 (1918).

Sodium Orthotellurate

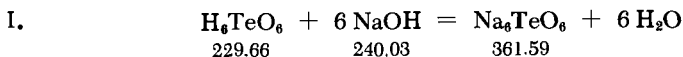

Solid NaOH is melted in a porcelain crucible and the stoichiometric quantity of H_6TeO_6 is added to the melt at $290\text{--}300^\circ\text{C}$.

When the reaction is complete, the crucible is slowly cooled, then broken; alcohol is poured over it and allowed to stand for 4-5 hours. The solution thus formed is filtered hot and slowly concentrated at room temperature until crystallization occurs. After 2-3 days, crystals (1-1.5 cm. long) of $\text{Na}_6\text{TeO}_6 \cdot 2\text{H}_2\text{O}$ separate. The product is filtered off, washed with alcohol, and dried in a vacuum desiccator over P_2O_5 . The water of crystallization is given off quantitatively, and the product converts to white, powdery Na_6TeO_6 . The salt thus obtained is analytically pure.

II. *Other Preparative Methods:* Fusing Na_2O and Na_2TeO_4 at 700°

The process requires a large amount of equipment. Detailed descriptions of the apparatus and procedure are given in the literature below.

PROPERTIES:

White, microcrystalline powder; gradually forms $\text{Na}_2\text{H}_4\text{TeO}_6 \cdot 3\text{H}_2\text{O}$ in air. Readily soluble in water.

REFERENCES:

- I. J. Meyer and M. Holowatyj, Ber. dtsch. chem. Ges. 81, 119 (1948).
- II. E. Zintl and W. Morawietz, Z. anorg. allg. Chem. 236, 372 (1938).

Sodium Telluropentathionate

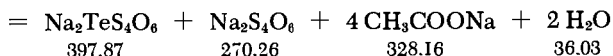
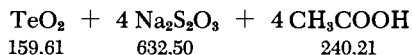

Under the same conditions as those described for the preparation of $\text{Na}_2\text{SeS}_4\text{O}_6 \cdot 3\text{H}_2\text{O}$ (p. 434), 110 g. of $\text{Na}_2\text{S}_2\text{O}_3 \cdot 5\text{H}_2\text{O}$ is dissolved in 60 ml. of H_2O and then added over a period of 15 minutes to a solution of 18.8 g. of TeO_2 in 75 ml. of concentrated HCl and 75 ml. of glacial acetic acid. Then 150 ml. of ethanol is added and the mixture is stirred and cooled for 15 additional minutes. Rubbing the walls with a glass rod accelerates the crystallization.

The crude product, which contains approximately 25 g. of $\text{Na}_2\text{TeS}_4\text{O}_6 \cdot 2\text{H}_2\text{O}$ and 2-4 mole percent of $\text{Na}_2\text{S}_4\text{O}_6$, is filtered, washed with ethanol and ether, and dried in vacuum over H_2SO_4 .

To recrystallize the salt, it is dissolved in 60 ml. of 0.2N HCl held below 45°C ; further procedure is as in the preparation of $\text{Na}_2\text{SeS}_4\text{O}_6 \cdot 3\text{H}_2\text{O}$. The yield is 20 g. (45%).

PROPERTIES:

Small flakes or flat needles. In large quantities, the crystals appear yellow with an orange cast; individual crystals seem yellow with a greenish cast. Dilute aqueous solutions seem yellow, concentrated ones orange-red. Completely soluble in water but less soluble than the corresponding selenium salt. Aqueous solutions gradually decompose into Te and tetrathionate but the rate of decomposition is smaller than that of the corresponding selenium salt. The solutions can be stabilized by mineral acids, whereas alkalis accelerate the decomposition. Insoluble in ethanol, very slightly soluble in methanol. Readily gives off its water of crystallization over H_2SO_4 in vacuum. The pure material can be stored over H_2SO_4 for several months without decomposition (Te eventually separates).

REFERENCE:

- O. Foss in: J. C. Bailar, Inorg. Syntheses, Vol. IV, p. 88, New York-London-Toronto, 1953.

Tellurium Sulfur Trioxide

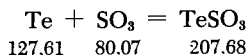

An excess of molten SO_3 is allowed to react with pure, finely powdered Te at room temperature. The reaction must be protected from moisture. The apparatus and the procedure are the same as for the analogous synthesis of S_2O_3 (p. 380). The product is dark-red α - TeSO_3 ; in order to obtain the light brown β -modification, this product is heated for a short time to about 80°C .

Stored in ampoules sealed in an oxygen-free atmosphere at pressures below 1 mm. When so stored, it is stable for some time at room temperature.

PROPERTIES:

The α -modification is dark, and the β -form is light brown; very hygroscopic; decomposes on heating above 90°C into SO_2 , TeO_2 and Te.

Reacts violently with water, resulting in the precipitation of Te and formation of H_2SO_4 , H_2SO_3 and H_2TeO_3 . Soluble in oleum with a blood-red color; insoluble in pure SO_3 .

REFERENCES:

- E. Divers and M. Shimosé, Ber. dtsch. chem. Ges. 16, 1008 (1883).
A. Damiens, Compt. Rend. Hebd. Séances Acad. Sci. 179, 829 (1924).

Nitrogen

P. W. SCHENK

Nitrogen**N₂**

The preparation of elemental nitrogen in the laboratory will only occasionally be necessary, for special purposes. Commercially available N₂ in steel cylinders can normally be used when an inert gas is required. In general, no purification is required if the low-oxygen—low-moisture grade is purchased. If the latter is unavailable the gas can be purified by the method described below. Very pure N₂ can be obtained by thermal decomposition of NH₃ or the decomposition of alkali azides.

NITROGEN FROM AZIDES

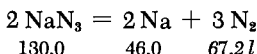

A layer (several millimeters thick) of recrystallized and dried NaN₃ is placed in a thin-wall Pyrex decomposition tube *a* (Fig. 173). The tube is 40 cm. long and 2 cm. in diameter. The lubricated ground glass joint *b* is kept cool by wrapping it with a wet rag. The entire apparatus is evacuated with a mercury diffusion pump and dried by heating under vacuum. The tube containing the azides is also heated; however, it is not allowed to reach the decomposition temperature of the azide. The internal pressure and the seals of the apparatus are tested with a high-frequency apparatus (vacuum leak tester). Finally, tube *a* is uniformly heated with an incandescent flame. Stopcock *d* is then closed and the azide is heated at one spot until decomposition begins. The progress of gas evolution is checked, after closing stopcocks *g* and *f* and opening *d*, by observing the pressure increase registered by manometer *h*. Heating is stopped until the pressure increase slackens. The heating is then resumed until a pressure increase is again recorded on the manometer. When the fine Na dust has settled in flask *c*, the gas is transferred into flask *e*. This procedure

is repeated until a sufficient amount of N_2 has been collected. This procedure avoids the use of the rapidly clogging glass-wool plug normally employed to filter out the Na dust. There is no danger of an explosion since a sudden pressure increase would, at worst, break the seal at *b* and separate the gas generation tube from the ground glass joint. No further purification of the N_2 obtained by this method is necessary.

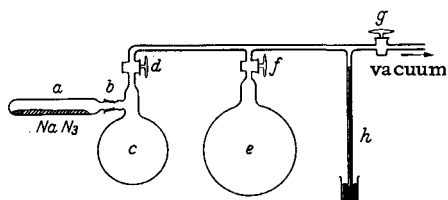

Fig. 173. Preparation of nitrogen from azides.

The decomposition temperature of NaN_3 is $275^\circ C$; KN_3 decomposes at $355^\circ C$; the alkaline earth azides decompose above $110^\circ C$.

PROPERTIES:

B.p. $-195.8^\circ C$, m.p. $-210^\circ C$; d 1.2505 g./liter.

REFERENCES:

E. Tiede, Ber. dtsh. chem. Ges. 46, 4100 (1913); 49, 1745 (1916).
E. Justi, Ann. Phys. [5] 10, 985 (1931).

PURIFICATION OF COMMERCIAL TANK NITROGEN

Water, CO_2 and other impurities (oil vapor) are removed with the usual absorbents. Difficulties are encountered only in the removal of the last traces of O_2 . The common procedure of passing the gas over heated Cu is suitable only when the nitrogen need not be too pure, since the partial pressure of oxygen over glowing CuO cannot be discounted. Thus, one of the following methods should be used.

Purification with "active" copper. Based on Fricke's work, Meyer and Ronge have developed the following practical method. A tube (Fig. 174), 75 cm. long and 4 cm. diameter, is directly wrapped with 10 m. of heating wire with a total resistance of 64 ohms. The inside temperature of the tube is adjusted to about $170^\circ C$ with a small rheostat, using a thermometer as an indicator. This temperature is maintained during both the oxidation and the reduction because recent studies indicate that the apparatus

achieves its greatest efficiency and longest life at this temperature. A protective glass jacket, fastened at the ends with asbestos, prevents heat loss and at the same time permits observation of the inside of the tube. The tube is filled according to one of the following procedures.

Either 250 g. of $\text{CuCl}_2 \cdot 2\text{H}_2\text{O}$ or 366 g. of $\text{CuSO}_4 \cdot 5\text{H}_2\text{O}$ is dissolved in two liters of water, and 250 g. of purified kieselguhr (boiled with hydrochloric acid and heated to incandescence) is added. The mixture is then precipitated at 60°C with a solution of 200 g. of NaOH in 500 ml. of H_2O , while vigorously stirred. After ten minutes the mixture is poured into ten liters of distilled water. By allowing to stand, decanting and again suspending in fresh water, the product is washed as well as possible. It is then filtered by suction. The moist cake is then pressed through a die with a high-power screw press (a meat grinder was ineffective). The thin sausages of 4-5 mm. diameter are collected on a sheet of paper. The sausages are dried in air, where they harden and shrink to some extent, and are then broken into pieces 5-10 mm. long. These pieces are dried at 180°C in a drying oven. The dust is sifted off and the pieces are loosely packed into the inner tube of the apparatus. Hydrogen is introduced from the top and heating is begun when all the air has been displaced. The water formed during the reduction of the CuO collects in the lower part *w* of the tube and is removed via the stopcock. The stopcock may be replaced by a ground glass joint, the male part of which may be removed during the reduction. The apparatus is ready for use when the contents have turned deep violet.

Nitrogen is introduced into the apparatus from the top. The gas issuing at the bottom is redried by one of the usual methods.

A second method devised by Meyer and Ronge involves dissolving 120 g. of basic copper carbonate in two liters of concentrated ammonia water. After addition of 420 g. of purified kieselguhr, the solution is evaporated almost to dryness on

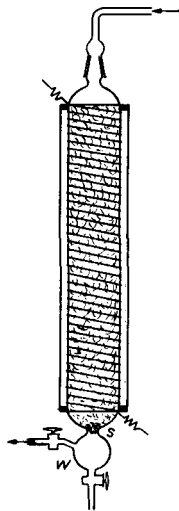

Fig. 174. Removal of oxygen from impure nitrogen ("copper tower"). By using a ground glass joint at *s*, the tube and the water separator can be made of different glasses.

a water bath. The somewhat moist cake is further treated as indicated above.

Precipitation with NaOH is nevertheless preferable because the CuO is precipitated more evenly and adheres more firmly to the kieselguhr.

The initial reduction of the tube packing takes considerably longer than subsequent regenerations with H₂.

The particular advantage of the above apparatus is that the activity of the packing can be estimated by visual inspection. As the apparatus is used, one can distinctly see zones of violet Cu, brown CuO and yellow Cu₂O. This packing can absorb about four liters of O₂, and thus can be used to purify about 400 liters of N₂ containing 1% O₂. For continuous operation, two such reactors are prepared, so that one may be regenerated while the other is in use. According to Meyer and Ronge (who also describe the analytical method), nitrogen purified in this manner contains less than $4 \cdot 10^{-5}\%$ O₂ (see also p. 336).

Purification with ammoniacal copper salt solution. According to H. von Wartenberg, 300 g. of copper shavings is packed into a two-liter steel cylinder and 300 ml. of a mixture prepared from 250 ml. of saturated NH₄HCO₃ solution, 250 ml. of concentrated ammonia, 500 ml. of H₂O and 100 g. of NH₄Cl is added. After addition of the solution, the cylinder valve is screwed on and N₂ is introduced to a pressure of 100 atm. gage. Then the steel cylinder is rotated for eight hours on a suitable device (a lathe may be used) or shaken in a shaking apparatus. The N₂ thus obtained need only be purified with H₂SO₄ and dilute KOH, followed by drying with concentrated H₂SO₄. It is designated as "completely free of oxygen." For determination of oxygen see p. 336.

REFERENCES:

- F. R. Meyer and G. Ronge, *Z. angew. Chem.* 52, 637 (1939).
H. von Wartenberg, *Z. Elektrochem.* 36, 295 (1930).
E. C. Kendall, *Science* [2] 73, 395 (1931).
R. Fricke and J. Kubach, *Z. Elektrochem.* 53, 76 (1949).

Ammonia



The laboratory preparation of ammonia from ammonium salts should seldom be required since pure synthetic NH₃ is commercially available in steel cylinders. In order to remove minor impurities such as oil vapor, traces of CO₂, etc., it is sufficient to pass the gas over fresh or well-regenerated activated charcoal.

From time to time, the charcoal is either heated under vacuum or treated with water vapor.

The gas is dried by passing through a series of 0.5-m.-long tubes. The first is filled with soda lime, the second with solid KOH or BaO, and the third with sodium wire. The gas is finally passed over P_2O_5 , since NH_3 predried by the above procedure does not react with P_2O_5 . The absence of this reaction can be used as a criterion for successful predrying. One can also achieve further purification by condensing the gas and dissolving some Na in the condensate. The NH_3 boiling off from the blue solution is completely dry. For suitable apparatus see Part I, p. 86 ff.

For drying, Fehér recommends a small, 1.5-liter steel cylinder with a screw-on lid. Some metallic sodium is added to the cylinder; the cylinder is cooled and filled with the NH_3 (Fig. 175). Since the sodium reacts not only with the water but also gradually with the ammonia, H_2 pressure builds up; this can be observed with a manometer. The H_2 should be vented from time to time.

To obtain a steady supply of purified NH_3 , one can liquefy the gas over very dry NH_4NO_3 . The vapor pressure of the resulting solution is considerably decreased so that it can be stored in a glass ampoule equipped with a stopcock from which the NH_3 can be drawn off as needed.

PROPERTIES:

Gas, very soluble in water. Liquid NH_3 is a solvent resembling water; that is, phenomena observed upon solution of many substances in water (dissociation) are also observed upon their solution in liquid NH_3 . Ammonia itself dissociates to a very small extent into NH_4^+ and NH_2^- ions. M.p. $-77.8^\circ C$, b.p. $-33.5^\circ C$.

REFERENCE:

F. Fehér, J. Cremer and W. Tromm, *Z. anorg. allg. Chem.* **287**, 175 (1956).

$N^{15}H_3$ FROM LABELED NH_4Cl

Ammonia labeled with N^{15} is prepared from labeled NH_4Cl and KOH in an apparatus especially suitable for smaller quantities (Fig. 176). $N^{15}H_4Cl$ (1.2 g.) is introduced via inlet *a* into small flask *k* and mixed with 5 ml. of water. Approximately 4 g. of KOH pellets is introduced via inlet *b* and about 8 g. via *d*; the glass lugs prevent their descent. The condensation trap J_1 is cooled in liquid nitrogen after tubes *a*, *b* and *d* are sealed by fusion, and the pressure is decreased to 450 mm. Stopcock *h* can remain closed during the gas evolution in spite of the pressure increase, provided the gas

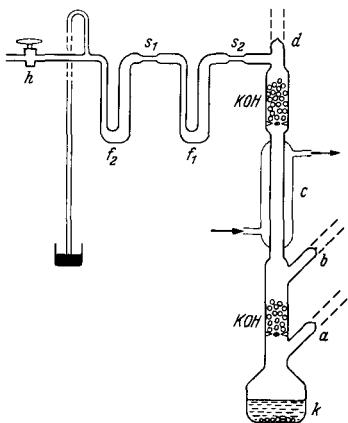
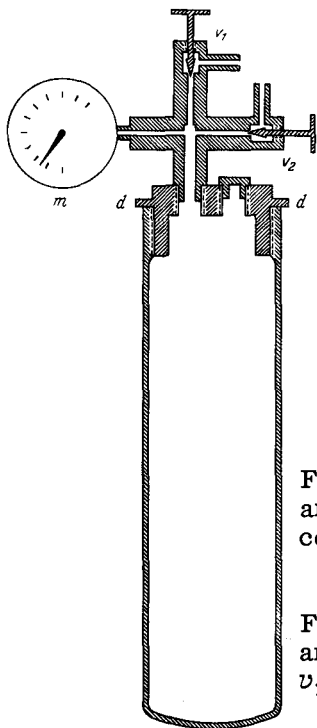

Fig. 176. Preparation of $N^{15}H_3$ from labeled ammonium salt. *a*, *b*, *d*) Inlet tubes; \mathcal{J}_1 , \mathcal{J}_2) condensation traps; *k*) reaction flask; s_1 , s_2) constricted sealing-off points.

Fig. 175. Steel cylinder for the drying of ammonia. *d*) Screw-on lid; *m*) pressure gage; v_1 , v_2) valves for intake of NH_3 and venting of H_2 .

evolution proceeds in the correct manner; in that case loss of N^{15} is impossible. Flask *k* is carefully heated with a small flame; the salt dissolves and the rising water vapor condenses on the KOH in the neck of the flask. The formation of $N^{15}H_3$ starts as soon as the concentrated alkali begins to flow. The evolving gas carries over enough water vapor to dissolve all the KOH in *b*, and the reaction is sustained even when the flame is withdrawn. The intermediate condenser *c* is necessary because otherwise the gas is too moist when it reaches the upper drying tube; even with the condenser, the bottom part of the drying tube (where the gas enters) heats up considerably. Some self-regulation is inherent in this simple arrangement. Too high a rate of gas evolution results in a pressure increase, which in turn increases the solubility of NH_3 in the liquid phase (especially in the water condensed by *c*) so that the pressure decreases, etc.

The $N^{15}H_3$ evolved in the process may be transferred almost completely to \mathcal{J}_2 by boiling for half an hour, shutting of the heat at the end of that period and evacuating the system to 30 mm. The receiver system is sealed off at s_2 , the air is removed with a pump, and \mathcal{J}_2 is immersed in liquid nitrogen and \mathcal{J}_1 in a Dry Ice-methanol bath. The $N^{15}H_3$ is then distilled from \mathcal{J}_1 into \mathcal{J}_2 . At the end of the

distillation, f_2 is sealed off at constriction s_1 . The dry ammonia may be removed by distillation. The yield is almost 100%.

REFERENCE:

K. Clusius and E. Effenberger, *Helv. Chim. Acta* 38, 1836 (1955).

AMMONIA SOLUTION

To prepare analytically pure, carbonate-free ammonia solution, NH_3 from a steel cylinder is passed through a tube packed with activated charcoal and a tube packed with soda lime, and finally into well-boiled water (soda lime can be dispensed with in some instances). The water should not occupy more than $2/3$ of the bottle because the dissolution of the NH_3 results in a considerable increase of volume. The outlet tube is closed off by a small soda lime tube. The inlet tube reaches to the bottom of the vessel. Backing up is unlikely because of the high flow rate of the incoming gas. It is advisable to cool the vessel with cold water.

Small quantities of pure, carbonate-free ammonia can easily be prepared by placing a dish of boiled distilled water above a dish of pure concentrated ammonia in a desiccator and allowing to stand overnight. This method of "isothermal distillation" can also be used to prepare other very pure reagents.

PROPERTIES:

Yields NH_3 when boiled; d of a saturated solution at 15°C , 0.882.

REFERENCE:

E. Abrahamczik, *Chemie* 55, 233 (1942).

Lithium Amide

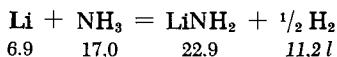

Metallic lithium is brought into contact with anhydrous liquid NH_3 in a heavy-wall tube. A blue solution of the metal results. When the tube is sealed off and allowed to stand for 2-3 weeks, the $\text{Li}(\text{NH}_3)_x$ is converted to LiNH_2 according to the above equation. Because of the pressure increase, the tube must be protected with an iron jacket and the pressure released by opening and closing

the cylinder once or twice. The reaction may also be completed in several hours by heating to 60°C.

To prepare larger quantities, Li metal is heated in a trough made of nickel sheeting. This is placed in a glass tube and the assembly is placed in an electric furnace. The tube is inclined and dry NH₃ is passed through from one end while the furnace is heated to 380-400°C. The molten LiNH₂ runs off and solidifies in the cooler portions of the reaction tube. In this manner, fresh surface of the Li metal is continuously exposed.

In another preparatory method, two nickel crucibles may be arranged one above the other in a vertical glass tube placed in an electrical furnace. The bottom of the upper crucible has three 1.5-mm. openings and contains a piece of lithium metal. The furnace is heated to 400°C while NH₃ is passed through. The LiNH₂ formed drips into the lower crucible through the holes in the upper. The product is cooled in a stream of NH₃.

PROPERTIES:

Translucent, lustrous, colorless crystal mass. M.p. 380-400°C. Gives off NH₃ on heating under vacuum above 450°C, with formation of Li₂NH. The latter is stable up to 750-800°C, where it decomposes to NH₃ and N₂. *d* (17.5°C) 1.178.

REFERENCES:

- A. W. Titherley, *J. Chem. Soc. (London)* **65**, 517 (1894).
 O. Ruff and E. Geisel, *Ber. dtsh. chem. Ges.* **39**, 840 (1906); **44**, 505 (1911).
 R. Juza and K. Opp, *Z. anorg. allg. Chem.* **266**, 313, 325 (1951).

Lithium Imide

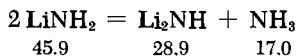

Lithium amide, divided into rice-sized grains, is heated slowly to 360°C in a glass tube evacuated with a mercury diffusion pump. After 3-4 hours, evolution of NH₃ practically ceases. During the next two hours the temperature is increased to 450°C (with continuous pumping). Evacuation of the vessel is continued for an additional two hours at this temperature. The amide should not be allowed to melt during this procedure.

PROPERTIES:

d 1.48. Crystallizes in an antiferite structure. Insoluble in benzene, toluene and ether.

REFERENCES:

- O. Ruff and H. Goerges, Ber. dtsh. chem. Ges. 44, 502 (1911).
R. Juza and K. Opp, Z. anorg. allg. Chem. 266, 325 (1951).

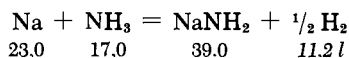
Sodium Amide

I. Smaller quantities of NaNH_2 are prepared by moderate heating of Na metal, freed of its crust and oil, in a boat placed in a porcelain or glass tube, through which a stream of NH_3 is passed. The temperature should be kept at about 300°C and the NH_3 must be dried especially carefully. All the air must be removed from the apparatus before the start of the reaction. The end of the reaction is determined by collecting the evolving gases in a test tube over Hg and then immersing the tube in water. The reaction is terminated when no H_2 remains in the test tube after absorption of the NH_3 . The amide is slowly cooled in a stream of NH_3 .

II. Larger amounts of NaNH_2 are prepared by the method of Dennis and Brown, as follows.

A nickel dish containing 100 g. of pure Na metal freed of crust and oil is placed in an iron pot equipped with a lid (Fig. 177). Pure, dry NH_3 gas is introduced as described above. The entire system is heated. When the sodium melts, the end of the inlet tube is immersed in it. The NH_3 stream (from a steel cylinder) should be constant. The apparatus must be provided with a pressure release valve so that sudden plugging will not cause disturbances. The temperature should be kept at approximately 350°C and should never be allowed to drop below 250°C . After about 5-7 hours the inlet tube is lifted out of the melt, which is tested for completeness of reaction in the manner described above. The product is cooled in a stream of NH_3 .

Still larger quantities of NaNH_2 may be prepared in a carefully cleaned iron retort with polished inside surfaces. The retort should hold about 500 g. of Na. The NH_3 inlet tube should end just short of the surface of the molten metal. Since the reaction proceeds rapidly, especially at the beginning, a sufficiently large and

efficient drying apparatus must be provided for the ammonia. (See p. 461 f., steel cylinder with Na, Fehér's method.) The retort is heated to about 300°C. Good seals must be provided to exclude air from the apparatus. During the vigorous uptake of ammonia, especially at the start of the reaction, there is a danger of sucking in air, which may lead to an explosion.

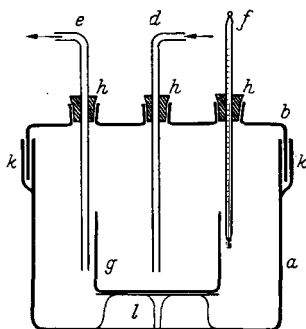

Fig. 177. Preparation of sodium amide. *a*) Iron pot; *b*) lid; *d*) inlet tube; *e*) outlet tube; *f*) thermometer; *g*) nickel dish; *h*) asbestos stopper; *k*) asbestos seal; *l*) tripod.

III. Clusius and Effenberger have described the following procedure for the preparation of NaNH_2 (as well as NaN_3) with N^{15} , using the apparatus shown in Fig. 178. An iron boat *s* is welded to an iron wire, at the end of which there is a slotted sleeve, by means of which the boat is suspended from a protrusion on the ground glass stopper. This prevents creeping of the reaction material. About 10 cm. of clean sodium wire (about 10 mmoles) is charged into the boat. The little vial *b* contains two drops of concentrated H_2SO_4 ; the storage flask holds the NH_3 . The entire apparatus is evacuated via stopcock *h*₂, which is then closed. The NH_3 is admitted to the Na vessel, and the reaction is carried out by heating furnace *o* to 250–300°C. The course of the reaction is followed through the pressure changes indicated by manometer *m*. The H_2 formed is from time to time removed by suction via *h*₂, while the NH_3 is retained in tube *c*, which is cooled to -180°C . During the evacuation, the furnace temperature must be temporarily decreased below 210°C (the melting point of NaNH_2) because the liquid amide dissolves considerable gas and may bump. The reaction is completed in about 24 hours, during which the apparatus must be refilled three times with NH_3 . The remaining gases are removed by suction.

If the final product is to be NaN_3 , dry N_2O is taken from a previously filled ampoule and reacted with the amide at a furnace temperature of 170–190°C. The reaction requires 36 to 48 hours

for completion. Stopcock h_1 is kept open so that the NH_3 formed via the reaction $2 \text{NaNH}_2 + \text{N}_2\text{O} = \text{NaN}_3 + \text{NH}_3 + \text{NaOH}$ may be absorbed by the H_2SO_4 .

When the reaction is complete, a crust of NaN_3 covers the entire boat. It is dissolved in water, some Fe_2O_3 present is centrifuged off, and the solution is concentrated on the water bath.

IV. Another procedure utilizing liquid NH_3 and Na metal and carried out in the presence of a catalyst yields lower purity NaNH_2 since the catalyst remains in the product; however, the amide is finely divided and free of NaH and unreacted Na.

The catalyst is powdered iron (III) nitrate, $\text{Fe}(\text{NO}_3)_3 \cdot 9\text{H}_2\text{O}$ (1 g. per 100 g. of Na). The reaction is carried out in a three-neck, round-bottom flask equipped with a rugged, tightly sealed stirrer. A spiral condenser which can be cooled with Dry Ice is set in one of the side necks; NH_3 is introduced through the other neck. The flask is half filled with liquid NH_3 , and then the ferric nitrate and approximately 50 g. of Na metal per liter of liquid ammonia are added piece by piece. The sodium pieces are manipulated by spearing them with an iron wire. Whenever the blue solution turns gray, a fresh piece of Na is added. Finally the excess NH_3 is evaporated and the remainder is driven off on a water bath.

PROPERTIES:

White, fibrous crystalline mass. Reacts vigorously with water. M.p. 210°C ; subl. t. above 400°C ; dec. $500\text{--}600^\circ\text{C}$. When partially oxidized or hydrolyzed by contact with air, often detonates violently upon heating.

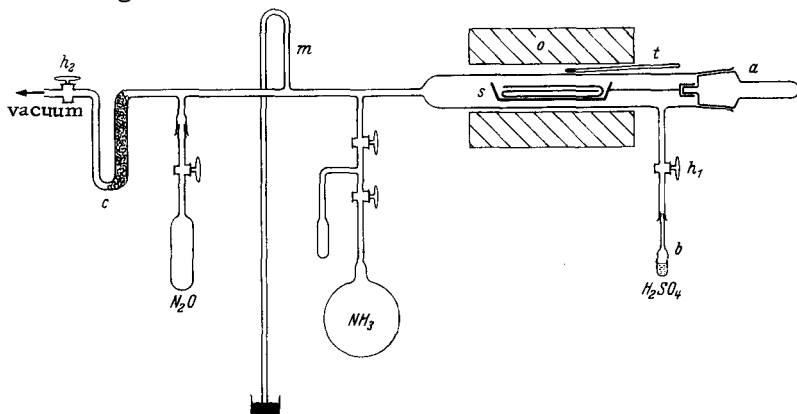
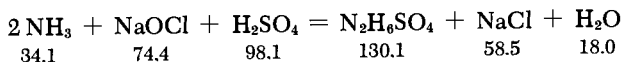

Fig. 178. Preparation of sodium amide with N^{15} . a) ground glass stopper; b) ampoule with H_2SO_4 ; c) condensation trap; h_1 , h_2) stopcocks; m) manometer; o) electric furnace; s) iron boat; t) thermocouple.

REFERENCES:

- A. W. Titherley, J. Chem. Soc. (London) 65, 504 (1884).
 J. Wislicenus, Ber. dtsch. chem. Ges. 25, 2084 (1892).
 L. M. Dennis and A. W. Browne, Z. anorg. allg. Chem. 40, 95 (1904).
 W. C. Johnson and W. C. Fernelius, J. Chem. Ed. 6, 443 (1929).
 K. Clusius and E. Effenberger, Helv. Chim. Acta 38, 1834 (1955).
 K. W. Greenless and A. L. Henne, in W. C. Fernelius, Inorg. Syntheses 2, 128, New York-London 1946.
 K. N. Campbell and B. K. Campbell, Org. Syntheses 30, 72 (1950).

Hydrazinium Sulfate

A 1N sodium hypochlorite solution (100 ml.) is added to 200 ml. of 20% ammonia water and 5 ml. of 1% limewater in a one-liter Erlenmeyer flask. The mixture is heated rapidly to boiling and maintained at that temperature for 1/2 hour so that all excess NH_3 is removed and the volume of the solution is reduced to about one half. The solution is then rapidly cooled; sulfuric acid is added to the lukewarm solution until a pH of 7-8 is reached (check with pH paper) and the mixture is left to stand for some time until the gray gelatinous substance settles out. The solution is filtered and the filtrate strongly acidified with sulfuric acid. After standing overnight the hydrazine sulfate is filtered. It is already quite pure but can be further purified by recrystallization from boiling water.

P. Pfeiffer and H. Simons recommend adding Trilon B (sodium ethylenediaminetetraacetate) instead of the limewater. This additive gives a true solution with water and a stable complex with the heavy metals which catalyze the decomposition of monochloramine formed as an intermediate. However, the yield is only 20% and therefore the procedure is of no advantage as of now.

PROPERTIES:

Shiny, glasslike tablets or prisms. Very slightly soluble in cold water (at 22°C, 3.05 g./100 ml. H_2O); readily soluble in hot water. Insoluble in alcohol. M.p. 254°C (dec.).

REFERENCES:

- F. Raschig, Ber. dtsch. chem. Ges. 40, 4588 (1907).
 P. Pfeiffer and H. Simons, Ber. dtsch. chem. Ges. 80, 127 (1947).

Hydrazine Hydrate

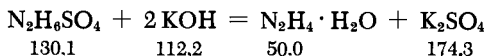

Dry hydrazine sulfate (100 g.) is mixed with an equal amount of powdered KOH in a Cu or Ag retort, 15 ml. of H₂O is added and the hydrazine hydrate formed is distilled through a downward inclined glass condenser. Heating is almost unnecessary at the beginning, but considerable heat eventually must be supplied in order to bring the reaction to completion. The hydrazine hydrate, which still contains water at this point, is purified by fractional distillation. Pure hydrazine hydrate distills between 117 and 119°C. The first cut is converted to hydrazine sulfate. The yield is 10 g. of hydrazine hydrate from 100 g. of hydrazine sulfate (about 25% of theoretical).

PROPERTIES:

Strongly refracting liquid; fumes in air; not very mobile. Peculiar odor which is, however, unlike ammonia. Miscible with water and alcohol, but not with ether, chloroform and benzene. B.p. (739.5 mm.) 118.7°C.

Hydrazine



Several procedures are available for the preparation of anhydrous hydrazine. Of these, the dehydration of N₂H₄ · H₂O and the cleavage of hydrazine salts with NH₃ are of special interest. The first method yields anhydrous N₂H₄, if an efficient column with about 15 theoretical plates is used. The distillation is carried out in a stream of N₂, using a mixture of 100 g. of 78.5% hydrazine hydrate and 140 g. of NaOH. The N₂H₄ obtained is at least 99.5% pure.

According to Fehér, the cleavage of hydrazine salts with NH₃ proceeds as follows:

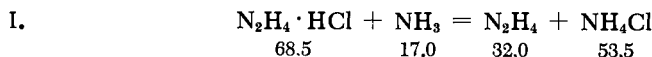

The reaction tube *r* (Fig. 179) made of Pyrex (outside diameter 45 mm., length 1200 mm.) is heated in an aluminum jacket equipped with a heating coil. The temperature is measured by thermocouples inserted between the glass tube and the furnace wall.

If the starting material is laboratory-made hydrazine dihydrochloride, about 500 g. of the moist compound may be charged in such a way that the upper third of the tube remains free. The charge is heated to about 120 to 150°C, and a fast stream of dry air is drawn through the tube by means of the pump. When the salt is dry and no moisture is seen in the connecting tubes, h_2 is closed and the temperature increased to 190°C. In the vacuum created by an aspirator, the hydrazine dihydrochloride loses about half its HCl over a period of 2-3 hours and is converted to the monochloride. (If commercial monochloride is used as the starting material, this part of the operation may be omitted.) The temperature of the reaction tube is now decreased to 160°C and dry ammonia (see p. 461) is bled in through the three-way stopcock h_1 . As soon as atmospheric pressure is attained, the apparatus is connected to the flowmeter m via h_2 , and the ammonia stream regulated so that a pressure somewhat in excess of atmospheric exists inside the apparatus (h_2 may have to be closed a little). Traps f_1 and f_2 are cooled to -30°C. The course of the reaction can be followed by changes in the pressure, the NH_3 flow rate, the temperature of the

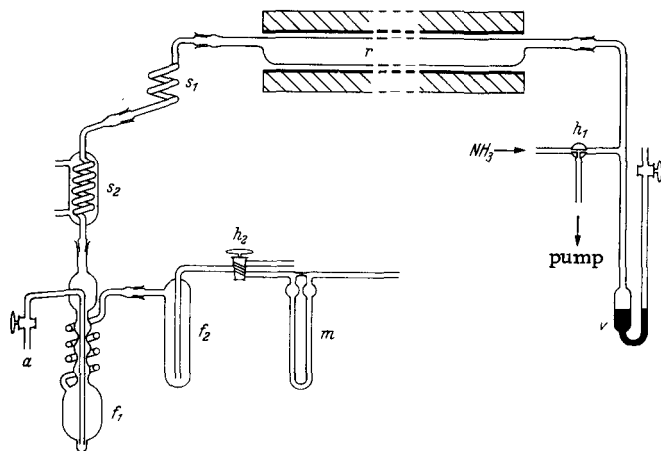

Fig. 179. Preparation of large quantities of anhydrous hydrazine.

a) Tap; f_1) high-efficiency condensation trap; f_2) condensation trap; m) flow meter; r) reaction tube; s_1) air cooling coil; s_2) spiral condenser; v) manometer for pressure control.

furnace, and the rate of condensation of the N_2H_4 . The reaction is terminated after 20-30 hours. About 125 ml. of N_2H_4 is collected in the first trap, from which it can be removed via a even during the run, using a two-neck, round-bottom flask. The dissolved NH_3 is separated by refluxing at 100°C in a H_2 stream. The yield

is 90%. After vacuum distillation to separate any hydrochloride carried over, the N_2H_4 is 100% pure.

A special apparatus for the one-step preparation of larger quantities of N_2H_4 has been described by Fehér, Cremer and Tromm.

A simplified, smaller apparatus, capable of only modest yields (about 30%) is shown in Fig. 180. Hydrazine monochloride (two moles) is placed in a 500-ml., two-neck, round-bottom flask. Tubes r_2 and r_3 are closed off with rubber tubing and pinch clamps. The apparatus is evacuated via r_1 by means of an aspirator. A clear melt free of bubbles is formed on heating to $190^\circ C$ on an oil bath. The temperature is then decreased to about $150^\circ C$ and h_1 is closed. Dry NH_3 gas is introduced through r_2 and trap f is cooled to -10 to $-30^\circ C$. A drying tube filled with KOH pellets is connected at r_3 and the NH_3 stream is adjusted to 50-100 bubbles per minute. As the melt becomes viscous, the temperature is increased gradually to $190^\circ C$. The reaction is complete when further flow of

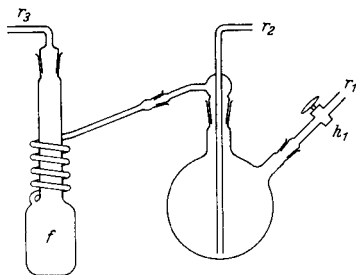
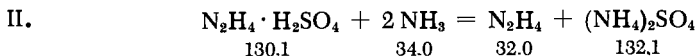

Fig. 180. Simplified apparatus for the preparation of small amounts of anhydrous hydrazine: r_1 is connected to an aspirator; r_2 is connected to an ammonia cylinder; f is a condensation trap.

NH_3 becomes impossible because of solidification of the melt. The N_2H_4 is freed of NH_3 as described above (refluxing in a stream of H_2 or N_2).



This procedure, based on the insolubility of $(NH_4)_2SO_4$ in liquid NH_3 , has been worked out by Fehér et al., as well as Glemser, and yields N_2H_4 of about 99.5% purity from commonly available hydrazine sulfate.

ANALYSIS:

By the method of Penneman and Audrieth; titration with 0.1 M potassium iodate solution in 3-5N HCl.

PROPERTIES:

Oily, strongly fuming liquid. Vigorously attacks cork, rubber and other organic substances. M.p. 1.8°C, b.p. 113.5°C. Explosive if ignited or overheated, especially in the presence of air. Miscible with water and alcohols. Only slightly soluble in other solvents.

REFERENCES:

- F. Raschig, Ber. dtsh. chem. Ges. 43, 1427 (1910).
 W. Schlenk and T. Weichselfelder, Ber. dtsh. chem. Ges. 48, 669 (1915).
 F. Fehér, J. Cremer and W. Tromm, Z. anorg. allg. Chem. 287, 175 (1956).
 R. A. Pennemann and L. F. Audrieth, Anal. Chem. 20, 1058 (1948).
 L. F. Audrieth and B. Ackerson, in Ogg: The Chemistry of Hydrazine, New York, 1951.
 G. Pannetier and R. de Hartoulary, Bull. Soc. Chim. France. Mem. (5) 21, 941 (1954), Battelle Development Corp., Swiss Pat. 291 184 (1950-1953); Mathieson Chem. Corp., Brit. Pat. 703 150 (1950-1954).
 O. Glemser, H. Weber and H. Duyster, Z. anorg. allg. Chem. 286, 205 (1956).
 F. Fehér, Private communication.
 H. Bock, Z. anorg. allg. Chem. 293, 264 (1958).

Hydrazoic Acid

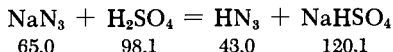

A solution of NaN_3 is mixed with a small amount of litmus and sulfuric acid (2 : 1 diluted with H_2O) is slowly added. When an excess of acid is present, the mixture is slowly distilled. By repeated fractionation one obtains 91% acid, which can be made anhydrous by distillation over CaCl_2 . However, extraordinarily violent explosions sometimes occur with this procedure. According to Günther and Meyer, HN_3 can be prepared in a relatively safe fashion by replacing the sulfuric acid with stearic acid. Pure NaN_3 is mixed in a round-bottom flask with stearic acid; a trap cooled to -40°C is fused directly to this flask. The reaction flask is evacuated and heated. The HN_3 is then purified by distillation at -50 to 80°C .

PROPERTIES:

Water-clear liquid. B.p. 37°C , m.p. -80°C . Very mobile and extremely explosive. However, even concentrated solutions can be handled without too much danger. Unbearably pungent odor. Inhalation of the vapor causes dizziness, headache and strong irritation of the mucous membranes.

REFERENCES:

- L. M. Dennis and H. Isham, J. Amer. Chem. Soc. 29, 27 (1907).
P. Günther and R. Meyer, Z. Elektrochem. 41, 541 (1935).
J. Einig, German Patent 435 654, from Chem. Zentr. 1926 II, 3072.
W. Hoth and G. Pyl, Angew. Chem. 42, 888 (1929).
A. W. Browne, J. Amer. Chem. Soc. 27, 551 (1905).
J. Martin, J. Amer. Chem. Soc. 49, 2133 (1927).
L. F. Audrieth, Chem. Rev. 15, 169 (1934).

SOLUTIONS OF HYDRAZOIC ACID

Because of the very high danger of explosion with pure HN_3 , it is expedient to work only with its relatively harmless solutions.

I. Aqueous solution: A solution of NaN_3 (15 g.) and NaOH (5 g.) is prepared in 150 ml. of water in a 250-ml. distillation flask equipped with an addition funnel and a high-efficiency condenser. The end of the condenser is connected by means of an adapter to a 500-ml. suction flask, which contains 100 ml. of water. The suction outlet of the flask is connected to a tube leading directly to the hood. The contents of the flask are heated to boiling (very important!), and 90 ml. of 40% H_2SO_4 is added dropwise. The distillation is continued until about 50 ml. of the solution remains in the flask. In this manner one obtains a solution containing about 3% HN_3 (0.6-0.7N). The initial addition of NaOH is a precautionary measure which definitely precludes too high a concentration of HN_3 in the cold solution.

II. *Anhydrous Ether Solution*: Since the distribution of HN_3 between water and ether is approximately 1 : 7, one can extract an aqueous solution of HN_3 with ether. However, even in this case it is preferable to use a distillation method: NaN_3 (30 g.) is dissolved in 100 ml. of water, 150 ml. of ether is added, and the mixture is placed in a 500-ml., round-bottom flask. The latter is equipped with an adapter fitted to a condenser, followed by a suitable ice-cooled receiver flask containing 100 ml. of ether. The round-bottom flask is also equipped with an addition funnel, the tip of which is immersed in the liquid and through which 30 ml. of concentrated H_2SO_4 is slowly added. The bulk of the ether and HN_3 distill off during the addition of the H_2SO_4 . The remainder

is driven off by heating on a steam bath. The ether distillate is dried over CaCl_2 and then distilled from this desiccant.

REFERENCES:

- W. S. Frost, J. C. Cothran and A. W. Browne, *J. Amer. Chem. Soc.* **55**, 3516 (1933).
 L. F. Audrieth and C. F. Gibbs in: H. S. Booth, *Inorg. Syntheses*, Vol. I, New York-London 1939, p. 77.

Azides

SODIUM AZIDE, NaN_3

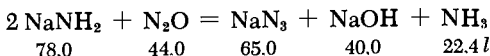

Sodium azide is prepared in the same apparatus used for the preparation of sodium amide (see Fig. 177, p. 459). Following the preparation of sodium amide, an N_2O generator (from ammonium nitrate) is attached instead of the ammonia generator (see Fig. 179, p. 470). The N_2O outlet tube is equipped with a glass tee immersed in mercury. It acts as a pressure release valve should the inlet tube plug. The water, formed together with the N_2O , is collected in the receiver (Fig. 184). Finally, the gas is well dried over soda lime and sodium hydroxide before reaching the reactor (Fig. 177). The N_2O inlet tube may not dip into the sodium azide melt since NaN_3 is solid at the reaction temperature and thus would plug the tube. About five hours are required for the conversion of 25 g. of NaNH_2 to NaN_3 . The crude product obtained must be recrystallized from water unless it is used for the preparation of HN_3 or other azides.

Other methods of preparation: $\text{N}_2\text{H}_4 + \text{HNO}_2 = \text{HN}_3 + 2\text{H}_2\text{O}$.

Hydrazine hydrate (5 g.) is dissolved in 50 ml. of absolute ether, the solution cooled with ice, and 37.5 ml. of 4N sodium methoxide solution and 12.6 ml. of ethyl nitrite are added. The solution is allowed to stand for a while in the ice and is then slowly warmed to room temperature. The NaN_3 precipitates and is washed, after suction filtration, with a methanol-ether mixture. If hydrazine hydrate is unavailable, the corresponding quantity of hydrazine sulfate can be used. It is ground with the methoxide solution, and the sodium sulfate precipitated is filtered off. After the addition of ether, the solution so obtained is reacted with ethyl nitrite. One then proceeds as described above.

Another procedure is to dissolve 26 g. of hydrazine sulfate in 140 ml. of sodium hydroxide solution (containing 28 g. of NaOH),

add 22 ml. of ethyl nitrite, and shake the mixture for six hours in a pressure bottle. The unreacted ethyl nitrite is purged with air, and the alcohol is similarly removed on a water bath. The solution is used directly for the preparation of HN_3 .

For the procedure for the preparation of N^{15} -labeled NaN_3 , see p. 466.

REFERENCES:

- L. M. Dennis and A. W. Browne, *Z. anorg. allg. Chem.* **40**, 95 (1904).
 W. Wislicenus, *Ber. dtsch. chem. Ges.* **25**, 2084 (1892).
 K. Clusius and E. Effenberger, *Helv. Chim. Acta* **38**, 1834 (1955).

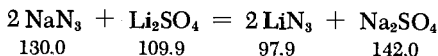
LITHIUM AZIDE, LiN_3 

With gentle warming, NaN_3 (91.30 g.) and $\text{LiSO}_4 \cdot \text{H}_2\text{O}$ (1.41 g.) are dissolved in 7 ml. of H_2O . Then 35 ml. of 96% alcohol is added with shaking. The solution is filtered after ten minutes and the residue of Na_2SO_4 and LiSO_4 washed with alcohol. The filtrate and wash solutions are evaporated on a water bath and dried in a drying oven at 80°C . This crude product is digested at 35°C for two minutes with 10 ml. of 96% alcohol and filtered, and the solution is dried as described above. The yield is 0.6 g of 99.5% LiN_3 .

REFERENCE:

- N. Hofmann-Bang, *Act. Chem. Scand.* **11**, 581 (1957).

ALKALI AZIDES FROM CARBONATES

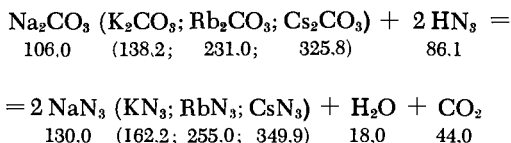

According to Suhrmann and Clusius, the required quantity of HN_3 is prepared in the following manner. The NaN_3 and the calculated amount of 6% H_2SO_4 are placed in a 300-ml., round-bottom Pyrex flask equipped with a ground glass stopper. A distillation tube, sufficiently long to prevent spraying over, is fused laterally to the neck of the flask. The tube end is immersed in a Pt dish filled with an alkali carbonate solution (for the preparation of pure alkali carbonates see p. 987) so that the HN_3 which

comes over is completely absorbed. In order to ensure complete conversion of the carbonate to the azide, an excess of HN_3 is used. After the reaction is complete, the alkali azide solution is evaporated on a water bath until the onset of crystallization. Crystallization on cooling is carried out without disturbing the solution to prevent the inclusion of mother liquor. After standing for several hours, the crystalline paste is separated from the mother liquor by suction filtration in a Pt Gooch crucible and washed with small quantities of distilled water. The crystals are dried in a drying oven at about 80°C and stored in a desiccator over P_2O_5 . The stoppers of the flask and the lid of the desiccator are not greased in order to avoid contamination of the preparation.

PROPERTIES:

NaN_3 : Formula weight 65.02. Decomposes at 275°C without melting. Solubility (17°C) 41.7 g./100 g. H_2O ; (16°C) 0.315 g./100 g. absolute alcohol; insoluble in ether. $d(x\text{ ray})$ 1.838. F5_1 structure type.

KN_3 : Formula weight 81.12. M.p. 343°C , decomp. t. 355°C . Solubility (water) (0°C) 41.1 g., (17°C) 49.6 g., (100°C) 105.7 g./100 g. H_2O ; (alcohol, 16°C) 0.137 g./100 g. absolute alcohol; insoluble in ether. $d(x\text{ ray})$ 2.045. F5_2 structure type.

RbN_3 : Formula weight 127.50. M.p. 321°C , decomp. t. 395°C (in a quartz tube). Solubility (16°C) 107.1 g./100 g. H_2O ; 0.182 g./100 g. absolute alcohol; insoluble in ether. d 2.788. Probably F5_2 structure type.

CsN_3 : Formula weight 174.93. M.p. 326°C , decomp. t. 390°C (in a quartz tube). Solubility (16°C) 307.4 g./100 g. H_2O ; 1.037 g./100 g. absolute alcohol; insoluble in ether.

REFERENCE:

R. Suhrmann and K. Clusius, *Z. anorg. allg. Chem.* **152**, 52 (1926).

Azides of Be, Mg, B, Al, Ga, Si: Their preparation is described by E. Wiberg and H. Michaud, *Z. Naturforschg.* **9 b**, 495 (1954); see also section on Alkaline Earth Metals.

Chlorine Azide

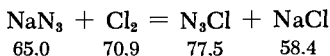

I. A solution of chlorine azide in CCl_4 is prepared by mixing a solution of NaN_3 in water with a solution of NaOCl . The reaction follows the above equation. A layer of CCl_4 is introduced underneath the NaOCl and the mixture is acidified with boric or acetic

acid while stirring vigorously. The two layers are then separated in a separatory funnel.

II. A gaseous mixture of ClN_3 and N_2 is obtained by mixing solutions containing one mole each of NaN_3 and NaOCl and dropping the mixture slowly from an addition funnel into a boric acid or dilute acetic acid solution. Simultaneously, a stream of N_2 is passed into the flask through a tube, the end of which is immersed in the solution. This stream immediately removes the ClN_3 formed. This procedure has proven safer than that in which the gas is withdrawn using a vacuum, in which explosions may occur. It is advisable to feed the ClN_3 diluted with N_2 directly into nonaqueous solvents such as aliphatic hydrocarbons, chloroform or methanol.

Other procedures: A solution of ClN_3 in ether may be prepared by introducing Cl_2 into a dispersion of AgN_3 in ether and filtering off the AgCl . Bromine azide can be similarly prepared.

PROPERTIES:

Condenses at -15°C to an orange-colored liquid. Solidifies at about -100°C to a yellow, very explosive mass. The melting and boiling points have not been accurately determined because of its explosiveness.

REFERENCES:

- F. Raschig, Ber. dtsch. chem. Ges. 41, 4149 (1908).
 W. J. Frierson, J. Kronrad and A. W. Browne, J. Amer. Chem. Soc. 65, 1696, 1698 (1943).

Monochloramine

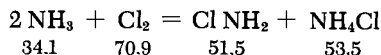

I. The calculated amount of Cl_2 (but not an excess!) required for conversion to NaOCl is introduced into 250 ml. of 2N NaOH with efficient cooling. Several pieces of ice are dropped into the solution (precooled to 0°C), and 250 ml. of 1N NH_4OH (also precooled) is then added at once. The mixture is then placed in a distillation flask equipped with an ice-cooled spiral condenser. Using an aspirator vacuum, 50 to 60 ml. is distilled off at 30 to 40°C . The chloramine solution thus obtained is stable for some time at 0°C . However, the HCl formed during its decomposition further accelerates that process. Thus, a small excess of ammonia should

be maintained in the solution. In order to obtain the monochloramine from its solution, the latter is placed in a distillation flask to which a drying tube filled with ignited K_2CO_3 is attached. A trap cooled with liquid nitrogen is attached to this drying tube. After evacuation, the flask with the solution is slightly heated. The potassium carbonate removes the water vapor carried over and the monochloramine collects in the trap. The accompanying ammonia is removed by suction at $-60^\circ C$.

It should be noted that NCl_3 , which causes violent explosions, is easily formed by decomposition during this operation.

II. According to Sisler, Neth, Drago and Yaney, gaseous $ClNH_2$ is prepared as follows. As shown in Fig. 181, the reaction vessel is a glass tube *a* (65 cm. long and 50 mm. in diameter) which is closed at both ends with rubber stoppers. The right end of the tube is half filled with glass wool, packed a little more tightly near the stopper. The left stopper is perforated and has five 8-mm.-diameter tubes. Chlorine gas, diluted with N_2 , is introduced through the middle tube. A glass rod *d*, sealed in with rubber tubing *c*, is used to remove any plugs of NH_4Cl . The NH_3 gas is introduced via the four tubes arranged symmetrically around the central tube. The four tubes are slightly bent toward the center. Gaseous Cl_2 , N_2 and NH_3 are withdrawn from steel cylinders, dried and metered into the tube in a ratio of 1 : 3 : 30. The Cl_2 flow rate should be about 0.01-0.05 mole/hour. A large excess of NH_3 and a reasonably high rate of flow are essential. The exit gases can be condensed in liquid nitrogen.

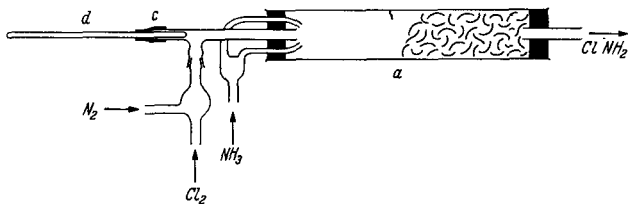

Fig. 184. Preparation of monochloramine. *a*) Reaction tube, half filled with glass wool; *d*) glass rod for removal of NH_4Cl plugs.

The preparation of NH_2Cl solution in liquid NH_3 has been described by J. Jander, Z. anorg. allg. Chem 280, 264 (1955).

PROPERTIES:

M.p. $-66^\circ C$. Colorless crystals which decompose very readily.

REFERENCES:

- H. Markwald and W. Wille, *Ber. dtsch. chem. Ges.* 56, 1319 (1923).
 G. H. Coleman and H. L. Johnson, in H. S. Booth, *Inorganic Syntheses*, Vol. I, New York-London 1939, p. 59.
 R. Mattair and H. H. Sisler, *J. Amer. Chem. Soc.* 73, 1619 (1951).
 H. H. Sisler, F. T. Neth, R. S. Drago and D. Yaney, *J. Amer. Chem. Soc.* 76, 3906 (1954).

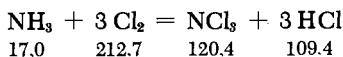
Nitrogen Trichloride

Preparation in solution: A 10 to 20% solution of CCl_4 in CHCl_3 (225 ml.) is placed in a one-liter round-bottom flask and 600 ml. of 10% $(\text{NH}_4)_2\text{SO}_4$ solution is added. The flask is closed with a cork stopper equipped with gas inlet and outlet tubes. The outlet tube is connected to a flask containing alkali to absorb excess Cl_2 . The inlet tube is then connected to a Cl_2 cylinder or a Cl_2 generator. The quantity of chlorine generated from 60 g. of KMnO_4 and 300 ml. of concentrated hydrochloric acid (about 20 liters = 70 g.) is introduced while vigorously shaking the flask. During this operation the solution becomes warm, but if it was well prechilled, further cooling is usually unnecessary. The two layers are now separated; the CHCl_3 layer is washed by repeated and vigorous shaking for five minutes with 5% $(\text{NH}_4)_2\text{SO}_4$ solution. Finally the layers are separated as well as possible and the CHCl_3 solution is dried with CaCl_2 . The solution contains about 12% NCl_3 .

PROPERTIES:

The solution may be stored for several days in the dark under $(\text{NH}_4)_2\text{SO}_4$ solution. Before use it is separated (after shaking the two solutions vigorously) and dried as described. Handling of such solutions is not dangerous up to a concentration of 18% NCl_3 .

REFERENCES:

- W. A. Noyes, *J. Amer. Chem. Soc.* 50, 2902 (1928).
 W. C. Bray and C. T. Dawell, *J. Amer. Chem. Soc.* 39, 896, 905 (1917).
 W. A. Noyes and A. B. Haw, *J. Amer. Chem. Soc.* 42, 2167 (1920).

Nitrogen Triiodide

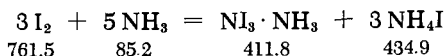

A suspension of very finely divided iodine is prepared by pouring an alcoholic iodine solution into water. The solution is allowed to settle and is filtered. The precipitate is washed with water, mixed with 0°C concentrated aqueous ammonia, and allowed to stand. The ammonia is decanted and renewed several times. The product is then sucked dry on filter paper and washed several times with alcohol and finally with ether. The filter is removed from the funnel while still very wet with ether; it may not be touched after it dries in air since even the slightest contact causes the nitrogen triiodide to detonate immediately. Preparations made in this manner often contain less NH₃ than indicated by the above formula, but it is impossible to obtain pure NI₃.

For lecture demonstrations the explosive nitrogen triiodide is prepared more simply by precipitating a KI₃ solution with concentrated ammonia and washing the precipitate with alcohol and ether on a suction filter.

PROPERTIES:

Brown-black powder. Explodes upon the slightest touch. Detonation occurs occasionally even under water. Storage is thus impossible.

REFERENCES:

Mallet, *Chem. News* 39, 257 (1879).

J. Szuhay, *Ber. dtsch. chem. Ges.* 26, 1933 (1893).

O. Ruff, *Ber. dtsch. chem. Ges.* 33, 3025 (1900).

J. Jander and E. Schmid, *Z. anorg. allg. Chem.* 292, 178 (1957).

Nitrogen Tribromide and Monobromamine

To prepare bromine-nitrogen compounds such as NBr₃·6NH₃ and BrNH₂, see the original papers by M. Schmeisser, *Z. anorg. allg. Chem.* 246, 284 (1941) and J. Jander, *Z. anorg. allg. Chem.* 296, 117 (1958).

Thionyl Imide

SONH

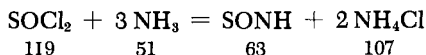

The reaction shown above takes place very readily in the gaseous phase if an excess of NH₃ is carefully avoided. The slightest excess

immediately causes polymerization to red-colored products. The apparatus shown in Fig. 182 is used.

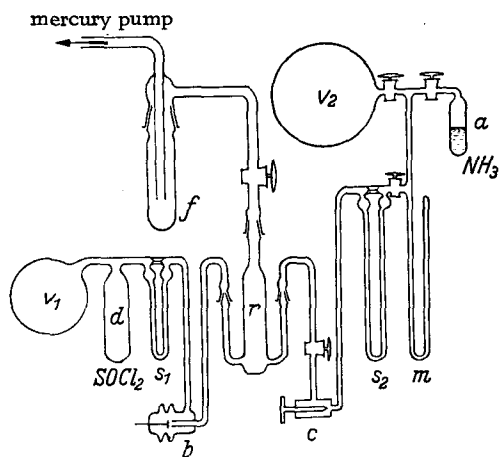

Fig. 182. Preparation of thionyl imide. *b*) Bodenstein valve; *c*) needle valve; *f*) condensation trap; *m*) Hg manometer; *r*) reaction vessel; *s*₁, *s*₂) flowmeters; *v*₁, *v*₂) surge vessels.

Ammonia dried over Na is stored in ampoule *a*. It can be transferred from *a* into reaction vessel *r* via precision needle valve *c*. The flow meter *s*₂, the Hg manometer *m*, and the surge flask *v*₂ (volume about one liter) are used to adjust and maintain the rate at which the gas enters the reaction vessel. A similar apparatus is used to maintain a stoichiometric ratio of SOCl₂ to NH₃ and a constant flow of thionyl chloride vapor from *d*. Because SOCl₂ attacks stopcock lubricants, Hg and metals, it is advisable to use a glass control and shut off valve *b* of the type developed by Bodenstein (see Part I, p. 62). The two flowmeters are filled with bromonaphthalene. They are calibrated with SOCl₂ and NH₃ prior to the experiment. The gas, at a given pressure and flow rate, is condensed in *f*. The quantity accumulated over a measured time is titrated to yield the calibration. The preparation of SONH proceeds as follows: Initially, one obtains the desired SOCl₂ flow rate by adjusting *b*. The SOCl₂ reservoir is kept at a constant temperature by an ice bath around it. The constant temperature in the NH₃ reservoir is similarly maintained and the corresponding flow rate is established. The flow rates must be such that only a very small excess of SOCl₂ is maintained. The trap *f* is then cooled with

liquid nitrogen. (Naturally, it is essential to place at least one, and preferably two traps cooled with liquid nitrogen in front of the mercury pump used to evacuate the entire apparatus.) A colorless condensate of SONH collects rapidly in the trap. If the tube connecting the trap and the reaction vessel is about 10 mm. in diameter, about 1 g. of SONH collects within a few minutes.

PROPERTIES:

Colorless liquid. M.p. -85°C . Polymerizes rapidly at the melting point to a clear glasslike mass which soon discolors to a yellow-red, brown and then cloudy substance.

REFERENCE:

P. W. Schenk, Ber. dtsch. chem. Ges. 75, 94 (1942).

Sulfamide

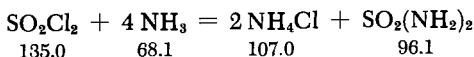

Well-dried NH_3 (300-400 ml.) (see p. 461) is liquefied in the reactor shown in Fig. 183. A large diameter KOH drying tube is attached to the side of the reaction vessel; the latter is closed off with a two-hole stopper. A stirring rod is inserted through one of the holes and a cylindrical addition funnel is inserted through the other. A solution of 100 ml. of SO_2Cl_2 in 100 ml. of petroleum ether (b.p. 40°C) is added over a period of 3-4 hours from the funnel. The reaction vessel is kept at -80°C . The solid crust of NH_4Cl and imidosulfuryl compounds forming on the surface of the liquid NH_3 must be broken up with the stirring rod. After all the SO_2Cl_2 has reacted, the product is poured into a large porcelain dish. The excess NH_3 evaporates overnight and the remaining material is placed in a round-bottom flask. The rest of the NH_3 and the petroleum ether are evacuated over a period of two hours by means of an aspirator. The white, solid crude product is dissolved in about 400-500 ml. of water to which 5 ml. of concentrated hydrochloric acid per 100 ml. of solution has been added. To hydrolyze the major part of the chain-type imido compounds formed, the solution is rapidly heated to $70-80^{\circ}\text{C}$ and kept at this temperature for ten minutes. The solution is allowed to cool to 30°C and then evaporated under vacuum at this temperature until dry. If the product is still somewhat moist, it must be dried in a vacuum

desiccator over H_2SO_4 . To separate the sulfamide, the dry crude product is extracted at room temperature two or three times with 400 ml. of acetone. Evaporation of the acetone solution yields 40-60 g. of almost pure sulfamide, which can be further purified by recrystallization from ethanol or ethyl acetate.

PROPERTIES:

Colorless rhombic plates. M.p. 93°C . Readily soluble in water and hot ethanol, very slightly soluble in cold ethanol. Tasteless. Upon heating decomposes according to: $3 \text{SO}_2(\text{NH}_2)_2 = (\text{SO}_2\text{NH})_3 + 3 \text{NH}_3$. Forms a silver salt with AgNO_3 only upon addition of NH_3 . The silver salt, $\text{SO}_2(\text{NHAg})_2$, is very slightly soluble in water.

REFERENCES:

M. Traube, Ber. dtsh. chem. Ges. 25, 2427 (1892); 26, 610 (1893).
A. Hantzsch and A. Holl, Ber. dtsh. chem. Ges. 34, 3430 (1901).
W. Appel, Private communication.

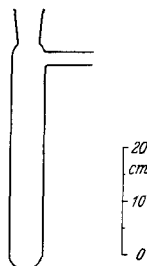
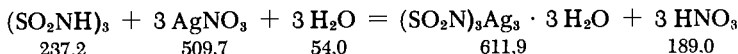
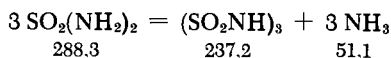
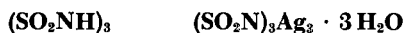

Fig. 183. Reactor for the preparation of sulfamide.

Trisulfimide and Its Silver Salt



Pure sulfamide (m.p. 93°C ; 2 g.) is placed in a heavy-wall test tube. A thermometer is introduced so that the mercury bulb is completely covered with sulfamide. A side arm of the reaction tube, lightly closed with cotton, is used as a pressure equalizer. The tube is slowly heated to 92°C by insertion to a depth of 5 cm. in an oil bath. When the sulfamide has melted, the temperature is slowly raised to 180°C over a period of one hour. During the second hour, the temperature is increased to 200°C and maintained there for four hours. After a total of six hours of heating, the reaction vessel is removed from the oil bath and allowed to cool. The cold, fused cake of trisulfimide is dissolved in about 20 ml. of water; the solution is then diluted with 500 ml. of boiling water. A

solution of 4 g. of AgNO_3 in 50 ml. of water is added. After brief boiling, the small amount of coagulated brownish precipitate is filtered off in a heated funnel and the clear filtrate is left to cool overnight. The fine, long needles of the silver sulfimide which separate are washed with cold water and dried in air. The yield is 2.8-3.0 g. of $(\text{SO}_2\text{N})_3\text{Ag}_3 \cdot 3 \text{H}_2\text{O}$, corresponding to 66-71% of theoretical. Further purification (usually superfluous) is accomplished by recrystallization from boiling distilled water.

PROPERTIES:

$(\text{SO}_2\text{NH})_3$: Formula weight 237.25. M.p. 165°C . $(\text{SO}_2\text{N})_3\text{Ag}_3 \cdot 3 \text{H}_2\text{O}$: Formula weight 611.91. Needle-shaped crystals. Loses its water of crystallization at 110°C .

REFERENCE:

G. Heinze and A. Meuwesen, *Z. anorg. allg. Chem.* 275, 49 (1954).

Nitrous Oxide

N_2O

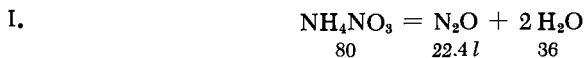

Very pure NH_4NO_3 is completely dehydrated in a drying oven at 160 to 170°C and the melt is allowed to solidify in a desiccator. After pulverization it is placed in a flask provided with a sealed-on trap. A heating coil is wrapped around the neck of the flask in order to prevent the water formed during the reaction from condensing and flowing back into the hot melt (Fig. 184). The condensation trap *b* is ice-cooled and is used to retain the major portion of the water formed. The flask is very carefully heated over a wire mesh. The reaction starts at 170°C and is exothermic. The temperature may not exceed 250°C , lest N_2 and NO evolve. Sudden heating and too large charges should be avoided, since the reaction can become explosive due to its exothermicity. The gas is scrubbed by passage through a 50% potassium hydroxide solution; the traces of O_2 may be removed by washing with an alkaline dithionite solution. According to Manchot, the often recommended washing with concentrated FeSO_4 solution is without merit.

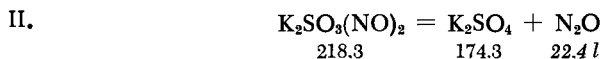

A suspension of 15 g. of $\text{K}_2\text{SO}_3(\text{NO})_2$ in 150 ml. of H_2O is prepared. A trace of alkali is added to the water to retard premature

decomposition of the salt. Complete dissolution of the salt is not necessary. Dilute sulfuric acid is added dropwise through an addition funnel. The reaction vessel should be cooled when large charges are used. The product gas is pure after washing with 4N KOH.

III. Pure N_2O in steel cylinders is commercially available for anesthetic purposes. Further purification of this gas (or of the gas prepared by the above two methods) can be effected by liquefaction and fractional distillation at low temperatures.

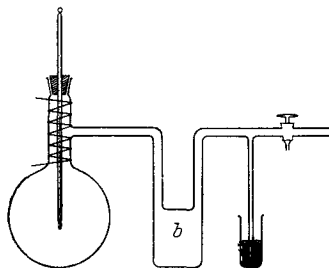

Fig. 184. Preparation of nitrous oxide.

PROPERTIES:

Formula weight 44.02. Colorless gas. M.p. $-90.6^{\circ}C$, b.p. $-88.5^{\circ}C$. At room temperature, the solubility in water corresponds approximately to that of CO_2 .

REFERENCES:

- H. Gehlen, *Ber. dtsh. chem. Ges.* 65, 1130 (1932).
 H. L. Johnston and H. R. Weiner, *J. Amer. Chem. Soc.* 56, 625 (1934).
 H. L. Johnston and W. F. Glauque, *J. Amer. Chem. Soc.* 51, 3194 (1929).
 V. Meyer, *Lieb. Ann. Chem.* 175, 141 (1875).
 P. Baumgarten, *Ber. dtsh. chem. Ges.* 71, 80 (1938).
 W. Manchot, M. Jahrstorfer and H. Zepfer, *Z. anorg. allg. Chem.* 141, 48 (1924).

Nitric Oxide

NO

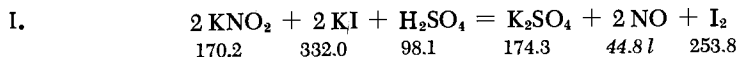

Sulfuric acid (50%) is added dropwise to a solution of 30 g. of KNO_2 and 15 g. of KI in 100 ml. of H_2O . The gas is washed with

90% sulfuric acid and 50% potassium hydroxide solutions, dried by passing through a U tube cooled with Dry Ice-ether mixture, and condensed over P_2O_5 by means of liquid nitrogen. The most volatile fraction is allowed to escape and the middle fraction is redistilled.

Instead of the expensive KI, $K_4Fe(CN)_6$ may be used.

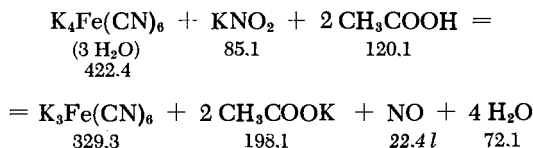

A mixture of 9 g. of KNO_2 and 100 ml. of a solution of $K_4Fe(CN)_6$ in H_2O (saturated at room temperature) is prepared; dilute acetic acid is added dropwise. The liberated gas is purified with 50% KOH solution, solid KOH and P_2O_5 . Additional purification is accomplished by distillation, as above.

II. FROM NITROSYL HYDROGEN SULFATE AND MERCURY

Mercury is added dropwise from an addition funnel to $(NO)HSO_4$ or a mixture of $NaNO_2$ (2-4 g.) and concentrated H_2SO_4 (100 ml.). The Bodenstein drip funnel described in Part I, p. 78 and Fig. 57, is preferred. This apparatus permits the NO to evolve easily under vacuum. The gas is purified by methods indicated above.

III. FROM NITRITE AND DILUTE SULFURIC ACID

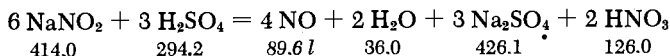

A layer of $NaNO_2$ is covered with two to three times its weight of water, and dilute sulfuric acid is added dropwise. Rod-shaped solid nitrite can also be decomposed with dilute sulfuric acid in a Kipp generator. Caution is recommended because the riser of the generator is easily plugged by the precipitated Na_2SO_4 . The liberated gas is washed with 4N KOH; it is quite pure. It may be purified further as above.

IV. Another simple and successful procedure is as follows. Alternate layers of 8.5 g. of finelyground $FeSO_4 \cdot 7H_2O$ and a finely pulverized mixture of 8.5 g. of NaBr and 4 g. of fused $NaNO_2$ are placed in a dry, 100-ml. round-bottom flask. Mixing of the

layers by shaking the flask initiates the reaction, which is accompanied by foaming. The yield is about 1 liter of gas from the above quantity of starting materials. The gas contains 98.8% NO and 1.2% N₂.

Other preparative possibilities: From copper and nitric acid. Gas prepared in this manner is rather impure.

The often recommended purification of NO by absorption in FeSO₄ solution, followed by boiling, does not appear to be effective. Purification with strong alkali is likewise of doubtful efficacy. In both cases, contamination with N₂O may occur.

PROPERTIES:

Formula weight 30.01. Colorless gas, slate-blue liquid; the solid condensed directly from the gaseous phase is a white, fluffy snow. M.p. -163.7°C, b.p. -151.8°C. The only substance which may be used as a sealing liquid for storage of the gas is mercury. Oxidizes very readily in air.

REFERENCES:

- W. Winkler, Ber. dtsch. chem. Ges. 34, 1408 (1901).
 H. L. Johnston and W. F. Giaque, J. Amer. Chem. Soc. 51, 3194 (1929).
 W. A. Noyes, Jr., J. Amer. Chem. Soc. 53, 515 (1931).
 H. Goldschmidt, Z. Phys. 20, 159 (1923).
 R. W. Gray, J. Chem. Soc. (London) 87, 1601 (1905).
 C. M. van Deventer, Ber. dtsch. chem. Ges. 26, 589 (1893).
 J. R. Partington and W. G. Shilling, Phil. Mag. [6] 45, 416 (1923).
 W. Biltz, W. Fischer and E. Wünnenberg, Z. anorg. allg. Chem. 193, 354 (1930).
 R. Stössel, Ann. Phys. [5] 10, 405 (1931).
 H. Gehlen, Ber. dtsch. chem. Ges. 64, 1272 (1931); 66, 296 (1933).
 M. G. Suryaraman and A. Viswanathan, J. Chem. Ed. 26, 594 (1949).

Nitrogen Trioxide



Since N₂O₃ is in equilibrium with NO and NO₂ according to the equation $\text{N}_2\text{O}_3 \rightleftharpoons \text{NO} + \text{NO}_2$, it can readily be prepared from these compounds. The following method is also very convenient:

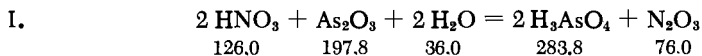

Nitric acid (d 1.30-1.35) is added dropwise to pulverized As₂O₃. The reaction is initiated by slight heating (70°C).

II. FROM NITROSYL HYDROGEN SULFATE

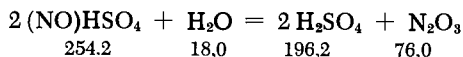

Since pure $(\text{NO})\text{HSO}_4$ is not required, the stock solution is prepared by the addition of SO_2 to fuming HNO_3 until a thick liquid forms. Water is then added dropwise to this paste in a suitable reactor, such as a flask equipped with a ground glass joint and a dropping funnel.

PROPERTIES:

Green to blue liquid. Does not have a uniform boiling point but first loses NO , which results in an increased boiling point. M.p. -103°C . Soluble in benzene, CCl_4 , toluene and CHCl_3 with a blue coloration.

REFERENCES:

- G. Lunge, Ber. dtsch. chem. Ges. 11, 1229, 1641 (1878).
 W. Biltz, W. Fischer and E. Wünnenberg, Z. anorg. allg. Chem. 193, 355 (1930).
 O. Scheuer, Ber. Wiener Acad. 123, II a, 1038 (1914).

Nitrogen Dioxide

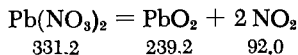

Pulverized lead nitrate is dried for several days in a drying oven at 110 to 120°C and placed in tube *r* (Fig. 185) made of high-melting glass. The tube is heated in a slow O_2 stream until gas evolution begins. The major portion of the moisture is frozen out in trap 5 at -15 to -20°C . Additional purification is obtained in horizontal U tubes 6 and 7 over PbO_2 and P_2O_5 , respectively. The gas is liquefied in vessel 8 at -78°C . Stopcock *h* is then closed and distillation into vessel 9 is carried out using an aspirator vacuum. The first fraction is removed by suction, and after the contents freeze, the tube is fused at *a*. The gas is ultimately distilled into individual ampoules 10, which are then sealed.

For a method of preparing very pure NO_2 from N_2O_5 see L. Hackspill and Besson, Bull. Soc. Chim. France, Mém. (5) 16, 479 (1949).

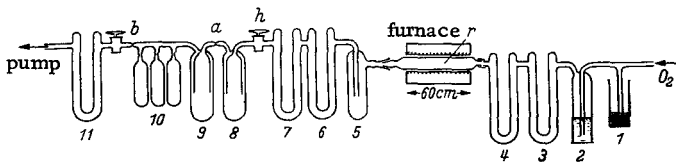

Fig. 185. Preparation of nitrogen dioxide. *r*) Tube of high melting glass; *a* and *b*) seal-off points; 1) mercury valve; 2) concentrated H_2SO_4 ; 3, 4) soda lime; 5) ice-salt-cooled trap; 6) PbO_2 ; 7) P_2O_5 ; 8, 9) condensation traps; 10) storage ampoules; 11) drying agent.

PROPERTIES:

Formula weight 46.01. Brown, extremely poisonous gas. Absorbed by alkali, forming nitrite and nitrate. M.p. -10.8°C , b.p. 21.2°C .

REFERENCES:

- M. Bodenstein, *Z. phys. Chem.* **100**, 68 (1922).
 A. Klemenc and J. Rupp, *Z. anorg. allg. Chem.* **194**, 51 (1930).
 P. A. Guye and G. J. Druginin, *J. Chim. Phys.* **8**, 489 (1910).
 F. E. C. Scheffer and C. P. Treub, *Z. phys. Chem.* **81**, 308 (1913).
 A. Klemenc, *Die Behandlung and Reindarstellung von Gasen* [Treatment and Purification of Gases], Vienna, 1948, p. 207.

Nitrogen Pentoxide

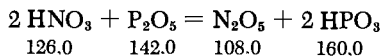

Nitric acid, as concentrated as possible (d 1.525), is cooled with an ice-salt freezing mixture and carefully dehydrated with excess P_2O_5 , using adequate cooling and small batches of acid. The mixture is then distilled very slowly from a retort — preferably in a stream of oxygen containing some ozone. The apparatus must not contain any stoppers or connections made of organic material. The yield is about 80 g. of N_2O_5 from 150 g. of HNO_3 .

Cäsar and Goldfrank recommend freezing 70–80 ml. of highly concentrated HNO_3 (d 1.5) contained in a large, three-neck, round-bottom flask cooled with Dry Ice mixture (see Fig. 186). An O_2 stream containing ozone is passed through the flask and

100-125 g. of P_2O_5 is added at once through the central tube. The tube is closed immediately with a glass stopper. The mixture is then allowed to thaw slowly. A room temperature water bath may be used to accomplish this. Large quantities of N_2O_5 mixed with N_2O_4 are rapidly evolved and are condensed in the large trap *b*, which is cooled to $-78^\circ C$. When most of the product (recognizable by its reddish vapors) has been transferred, the flask is shaken, and when the renewed evolution of gas again decreases, the flask is heated for several hours in a stream of O_2 containing O_3 . When all the product gas has been transferred and condensed, the trap is removed and the condensate fractionated by vacuum distillation.

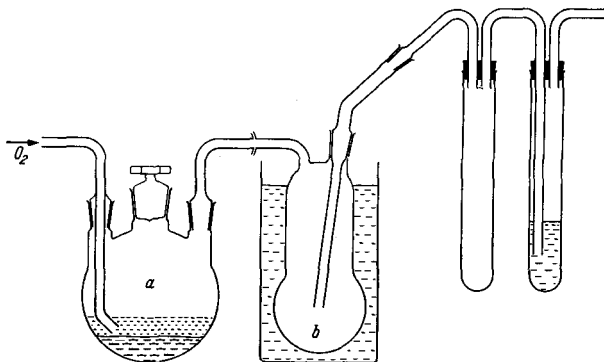

Fig. 186. Preparation of nitrogen pentoxide. *a*) Three-neck round-bottom flask with a ground glass stopper; *b*) condensation trap with Dry Ice bath.

Other preparative methods: From $AgNO_3$ and Cl_2 or from $AgNO_3$ and $POCl_3$. It is best to introduce ozone-containing oxygen into the liquid N_2O_4 . For example, 5 g. of liquid N_2O_4 is placed in a U tube cooled in an ice-salt mixture. Oxygen containing 6-7% ozone is passed through the tube for one hour.

PROPERTIES:

Colorless crystals which decompose slowly at room temperature and are moderately stable only below $10^\circ C$. The melting point has not been determined. Subl. t. $34^\circ C$. According to R. Schwartz, N_2O_5 reacts with H_2O_2 with the formation of pernitric acid: $N_2O_5 + H_2O_2 = HNO_4 + HNO_3$.

REFERENCES:

W. Biltz, W. Fischer and E. Wünnenberg, *Z. anorg. allg. Chem.* **193**, 360 (1930).

- H. J. Schumacher and G. Sprenger, *Z. phys. Chem. A* **140**, 274, 277 (1929).
- F. Russ and E. Pokorny, *Mh. Chem.* **34**, 1051 (1913).
- R. Schwarz, *Z. anorg. allg. Chem.* **256**, 3 (1947); see also L. Hackspill and J. Besson, *Bull. Soc. Chim. France, Mém.* (5) **16**, 479 (1949).
- G. V. Caesar and M. Goldfrank, *J. Amer. Chem. Soc.* **68**, 372 (1946).
- N. S. Gruenhut, M. Goldfrank, M. L. Cushing and G. V. Caesar, in L. F. Audrieth, *Inorganic Syntheses*, Vol. III, New York-Toronto-London 1950, p. 78.

Nitric Acid

HNO_3

When necessary, purification of technical-grade nitric acid in the laboratory is accomplished by distillation over a small amount of AgNO_3 . The first and last fractions are discarded; the resulting acid is free of halogens.

Several methods have been suggested for the preparation of anhydrous nitric acid.

I. Acid of the highest possible concentration is distilled; then an inert, dust-free gas stream, preferably preheated, is passed through to remove the nitrogen oxides. It is ultimately distilled over P_2O_5 . Analysis then indicates whether the acid contains free N_2O_5 . If so, some dilute acid, containing enough water to dissolve the N_2O_5 present, is added.

II. By distillation with H_2SO_4 . The starting material is acid of the highest possible concentration; the apparatus shown in Fig. 187 is used. A 600-ml. glass flask is equipped with a ground glass joint with a boiling capillary *a* and a ground glass thermometer *b*. An efficient condenser is attached at *c* and terminates in a receiver. The apparatus is connected to an aspirator via a safety trap. The three-way stopcock also permits attaching a manometer. The distillation flask is filled with 150 ml. of HNO_3 , 300 ml. of H_2SO_4 ,

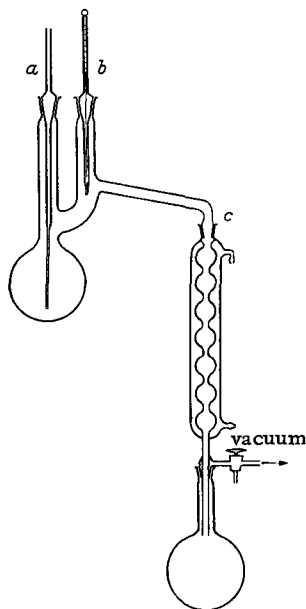

Fig. 187. Preparation of anhydrous nitric acid.

both precooled in an ice-salt mixture. Cooling should be continued during the mixing process. The apparatus is then evacuated and carefully heated on a water bath. Colorless HNO_3 passes into the receiving vessel at 22 mm. and $37\text{--}40^\circ\text{C}$. The condensate is redistilled in the same manner, using twice the volume of concentrated H_2SO_4 . At 20 mm. the pure acid distills over between 36 and 38°C . The ground glass joints should obviously not be lubricated with any organic material. If a sealing agent is necessary, some P_2O_5 or H_2SO_4 may be used.

It is also recommended that a stream of oxygen containing some ozone be passed through the highly concentrated acid and that it be distilled under aspirator vacuum.

PROPERTIES:

Formula weight 63.02. B.p. 83°C (increases after some boiling to 87°C because of decomposition), m. p. -41°C . After dilution with twice the amount of water, nitric acid not containing nitrogen oxides does not discolor KMnO_4 . d_4^{15} 1.522. Pure, 100% acid cannot be kept without decomposition for a very long time, especially in the light. Aqueous HNO_3 has a boiling point maximum at 121°C (68% HNO_3).

REFERENCES:

- J. Giersbach and A. Kessler, *Z. phys. Chem.* **2**, 690 (1888).
 L. Meyer, *Ber. dtsh. chem. Ges.* **22**, 23 (1899).
 V. H. Veley and J. J. Manley, *Proc. Roy. Soc. London* **62**, 223 (1897); **68**, 128 (1901).
 R. Lüdemann, *Z. phys. Chem. B* **29**, 136 (1935).
 E. Briner, B. Susz and P. Favarger, *Helv. Chim. Acta* **18**, 376 (1935).
 A. Klemenc and E. Ekl, *Mh. Chem.* **39**, 641 (1918).
 A. Potier, *Comptes Rendus Hebd. Séances Acad. Sci.* **233**, 1113 (1951).

Hyponitrous Acid

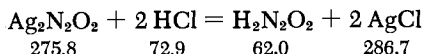

Ether, dehydrated over Na wire, is saturated with dry HCl, cooled and treated with $\text{Ag}_2\text{N}_2\text{O}_2$ until the yellow color of the latter persists. Complete exclusion of atmospheric moisture is required. The solution is rapidly filtered through a dry filter

into a crystallization dish placed in a desiccator. To accomplish this, the addition funnel is connected with a tube in the lid of a desiccator provided with a side vent. A small dish with KOH pellets and another with a small amount of concentrated H_2SO_4 are put in the desiccator. The desiccator is then rapidly evacuated. Hyponitrous acid separates immediately.

PROPERTIES:

Colorless, flakelike crystals. Very explosive, detonates even when rubbed with a glass rod. Ignites with solid KOH. Sometimes decomposes spontaneously, seemingly without cause. Readily soluble in alcohol; less soluble in ether, chloroform and benzene; very slightly soluble in ligroin.

REFERENCES:

- A. Hantzsch and L. Kaufmann, *Lieb. Ann. Chem.* 292, 317 (1896); *Ber. dtsch. chem. Ges.* 29, 1394 (1896).

Silver Hyponitrite

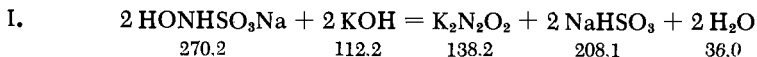

Sodium hydroxylamine monosulfonate is prepared from hydroxylamine disulfonate. This salt is obtained in solution according to the instructions given on p. 503. However, the salt is not isolated from its solution by addition of KCl. Instead, the solution is evaporated under vacuum until the major portion of the Na_2SO_4 (formed together with the monosulfonate) precipitates. At this point 1 ml. of the solution should react completely with about 10-12 ml. of 1N iodine solution. When this is achieved, 100 ml. of solution is mixed in a one-liter flask with 100 g. of solid KOH and heated for two hours on a water bath at 60 to 70°C. A thick paste of bisulfite and hyponitrite is formed. A test is performed to determine whether an added suspension of HgO is still reduced to Hg. [Half a gram of the paste is diluted with water and a HgO suspension added. The HgO is obtained by precipitation of a $\text{Hg}(\text{NO}_3)_2$ solution with a small excess of sodium hydroxide solution and is purified by repeated decantation with water.] The paste is then diluted to three liters with water and treated, while shaking vigorously, with HgO until the color of the latter persists. A little steatite powder is added to facilitate the ensuing filtration. The reaction mixture

is filtered, the filtrate is diluted to twice its volume, and 0.25 liter of the diluted filtrate is put aside. A 1% AgNO_3 solution is added slowly and with stirring to the main batch. The precipitate at first redissolves but the yellow $\text{Ag}_2\text{N}_2\text{O}_2$ eventually settles. The addition of AgNO_3 solution is discontinued upon the appearance of a persistent, dark precipitate. This precipitate is then removed by addition of the solution previously put aside. A total of 6-7 liters of AgNO_3 solution is required. The suspension is left to settle in a glass cylinder, and the mother liquor is then siphoned off. The precipitate is washed several times, with the supernatant liquor removed by decantation and siphoning. (The excess Ag can be recovered from the mother liquor and the first washings with HCl .) The siphoning process is repeated 8 to 10 times. The precipitate is then suction-filtered, washed with water and dried at 100°C . Light should be avoided as much as possible during all the operations with the silver salt. If the silver salt is to be further processed, it is best stored in paste form.

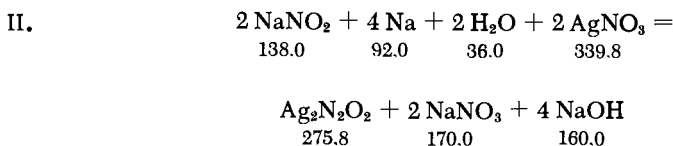

Sodium amalgam (2500 g. of Hg + 16 g. of Na) is added from a funnel over a period of forty-five minutes to a vigorously stirred, chilled solution of 20 g. of NaNO_2 and 10 g. of NaOH in 100 ml. of H_2O . The stirring is discontinued, the supernatant decanted from the Hg, and the solution almost completely neutralized with dilute HNO_3 . (The solution should remain slightly alkaline and the temperature should not exceed 0°C .) Mercury (II) oxide is then added until it begins to settle unchanged on the bottom. The mixture is then filtered and precisely neutralized with dilute HNO_3 . The prepared solution of AgNO_3 is then added immediately. The yellow precipitate of $\text{Ag}_2\text{N}_2\text{O}_2$ is suction-filtered, washed with hot water, dissolved in very dilute, ice-cold HNO_3 , and precipitated with ammonia. The purification by precipitation may be repeated. The yield is about 6-7 g.

E. Abel and J. Proisl describe an electrolytic method of preparation.

PROPERTIES:

Yellow powder, stable in the absence of light. Darkens on exposure to light.

REFERENCES:

- A. Hantzsch and F. Kaufmann, *Lieb. Ann. Chem.* 292, 320 (1896).
 F. Raschig, *Schwefel- und Stickstoffstudien* [Studies on Sulfur and Nitrogen], Leipzig-Berlin 1924, p. 94.
 E. Abel and J. Proisl, *Mh. Chem.* 72, 1 (1939).

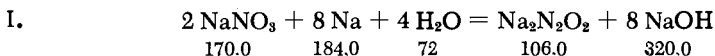
Sodium Hyponitrite

Sodium amalgam is added with stirring or shaking to an ice-cooled solution of 85 g. of NaNO_3 in 250 ml. of H_2O . The amalgam is prepared by dissolving 58 g. of Na in 4000 g. of Hg. When three quarters of the amalgam has been added, the cooling is discontinued and the remainder of the amalgam is added at once. Shaking is continued for 10-15 minutes, during which the temperature increases to 40°C . When the temperature begins to fall the mixture is poured into a closed flask with a narrow neck and the first flask is rinsed with 2-3 ml. of H_2O . The washings are combined with the main solution and the whole shaken vigorously for about ten minutes. To determine whether all the hydroxylamine formed has disappeared, a drop of the solution is mixed with a little water and AgNO_3 . The solution is decanted from the Hg and placed over H_2SO_4 in a vacuum desiccator at 35 to 40°C in order to remove all the NH_3 . The $\text{Na}_2\text{N}_2\text{O}_2 \cdot 9\text{H}_2\text{O}$ separates during this operation. It is suction-filtered on a fritted glass filter, washed with alcohol at a temperature above 10°C to remove traces of NaOH, and dried in a desiccator.

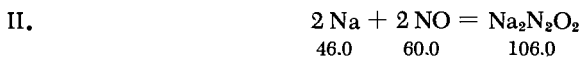

A flask equipped with gas inlet and outlet tubes is connected, via a tee, with an H_2 generator on the one side and an NO generator on the other side (see p. 485). The flask is charged with 0.3 g. of Na metal (in small pieces), 90 g. of pyridine distilled over KOH, and 30 g. of thiophene-free benzene dried over Na wire. The air is displaced with H_2 , and the flask left overnight under the pressure of the H_2 generator. By the next day the Na metal disintegrates to a loose pulp of the green-black pyridine compound. The outlet tube is opened and NO is slowly admitted. By the time the bulk of the H_2 is displaced, the absorption of NO becomes so violent that the

apparatus must be cooled. The absorption takes place chiefly during the first ten minutes and is practically terminated after the first 30 minutes, even though less than half of the theoretical amount is absorbed during that time. The NO is then displaced with H₂, and the product is rapidly suction-filtered on a large filter and thoroughly washed with dry ether. The Na left over is removed mechanically. The light-brown mass is dissolved in a small amount of water. Treatment of the brown solution with several times its volume of alcohol yields a precipitate of Na₂N₂O₂, at first in the form of an oil and finally as shiny, almost white flakes. The flakes are suction-filtered and washed with a small amount of alcohol and ether. Repetition of the procedure yields snow-white plates. The yield is 4.5 g. of Na₂N₂O₂ · 9H₂O.

Other preparative methods: Sufficient NaCl solution is added to a suspension of Ag₂N₂O₂ so that a faint yellow color persists. The mixture is filtered and washed briefly, and the solution is evaporated in vacuum until it crystallizes. It is dried as above.

PROPERTIES:

Formula weight (Na₂N₂O₂ · 9H₂O) 268.14. Small granular crystals or plates. Loses water of crystallization under vacuum. In its anhydrous form, it resembles hydrated magnesium carbonate. Readily soluble in H₂O.

REFERENCES:

- E. Divers, J. Chem. Soc. (London) 75, 96 (1899).
 F. Raschig, Schwefel- und Stickstoffstudien [Studies on Sulfur and Nitrogen], Leipzig-Berlin 1924, p. 95.
 E. Weitz and W. Vollmer, Ber. dtsch. chem. Ges. 57, 1015 (1924).

Nitramide

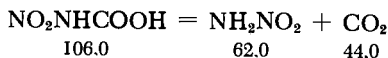

a) The potassium nitrocarbamate required for the synthesis is prepared as follows: 100 g. of potassium cyanate is dissolved in the minimal amount of warm, 50% alcohol and the clear solution is added to an excess of alcoholic hydrogen chloride (96% alcohol). After 24 hours, the solution is neutralized with BaCO₃ and suction-filtered, and the bulk of the alcohol is evaporated. The remaining portion is dried in a vacuum desiccator and the residue is extracted

with ether. The ether solution is dried and distilled. The yield is about 66 g. of the ethylester of carbamic acid (plates, m.p. 49-50°C, b.p. 180°C). The 66 g. of the ester is added with vigorous stirring to 170 ml. of cold, pure, NO₂-free H₂SO₄. Upon completion of the addition and subsequent temperature drop to below 0°C, 37 g. of ethyl nitrite is added at once. The temperature must drop to below -5°C within ten minutes. The lower the temperature, the better the yield. After standing for 45 minutes at a temperature below -5°C, the mixture is poured over 0.5 to 0.75 kg. of ice and extracted four times with 150 ml. of ether. The solution is dried and diluted to one liter, and dry NH₃ is introduced. The precipitate that separates is suction-filtered and air-dried on clay. The yield is 30-35 g. (The yield can be improved by working up the mother liquor and by further treatment of the aqueous acid solution with ether.) A solution of 25 g. of this salt in 100 ml. of water is prepared and cooled to 0°C. Then 750 ml. of methanolic potassium hydroxide (250 g. of KOH/liter), precooled to 0°C, is added with vigorous stirring, which results in a temperature rise. The mixture is ice cooled, but not continuously, so the temperature can be held at 7°C. Should local gas evolution occur, the solution is immediately and vigorously stirred. The solution is left to crystallize and is suction-filtered after about one hour. The crystals are thoroughly washed with alcohol and dried in a desiccator. The yield is 20-25 g. Although potassium nitrocarbamate is decomposed by water, it can be stored in a desiccator.

b) A total of 25 g. of potassium nitrocarbamate is introduced in small portions into a mixture of 25 ml. of concentrated H₂SO₄ and 200 g. of ice, and the solution is saturated with (NH₄)₂SO₄. The mixture is then extracted 30 times with ether until an evaporated sample no longer evolves gas upon addition of a drop of ammonia. The ether solution is put in a flask and evaporated by a dry air stream at room temperature. The residue is dissolved in a small quantity of absolute ether, and the nitramide is precipitated with ligroin. It is washed with petroleum ether and dried on clay. The lengthy ether extraction can be avoided by superimposing a layer of ether on the aqueous solution and solidifying the latter, while stirring, by cooling it with Dry Ice-acetone mixture. The ether is then decanted. Just four repetitions of this process result in transfer of 80% of the nitramide to the ether.

The following procedure is much more rapid, but the yield is also much lower. Potassium nitrocarbamate (25 g.) is added, with shaking, to a mixture of 10 ml. of concentrated H₂SO₄, 100 g. of ice and 200 ml. of ether. The reaction mixture is cooled in an ice-salt bath. Approximately 300 g. of ignited Na₂SO₄ is added portionwise, with shaking and cooling until the mass solidifies. The mixture is left to stand for two hours with occasional kneading, the ether is removed by suction, the mixture is kneaded again using

200 ml. of ether, which is then removed, and the procedure is repeated a third time. The NH_2NO_2 is obtained from the ether solution by the method described above. The yield is about 3-4 g.

PROPERTIES:

Shiny white plates from ligroin. M.p. $72-75^\circ\text{C}$ (dec.). Soluble in ether, alcohol, water and acetone; less soluble in benzene; almost insoluble in ligroin. It can be obtained with especial ease by precipitation with chloroform from ether solutions.

REFERENCES:

- J. Thiele and A. Lachmann, Ber. dtsh. chem. Ges. 27, 1909 (1894); Lieb. Ann. Chem. 288, 273, 297 (1895).
C. A. Marlies and V. K. LaMer, J. Amer. Chem. Soc. 57, 2008 (1935).
I. N. Brönstedt and K. Pedersen, Z. phys. Chem. 108, 187 (1924).
O. Folin, J. Amer. Chem. Soc. 19, 341 (1897).
C. A. Marlies, V. K. LaMer and J. Greenspan, in H. S. Booth, Inorganic Syntheses, Vol. I, New York-London 1939, p. 68.

Hydroxylammonium Chloride



I. PREPARATION BY ELECTROLYTIC REDUCTION OF HNO_3

A lead sheet cylinder is placed inside a cylindrical filtering jar (appr. 10 cm. I. D.) (Fig. 188). The inside cylinder should contact the jar walls as uniformly as possible (a lead sheet vessel of similar size may be used instead of the cylinder). The lead sheet is very carefully cleaned with a soft wire brush and thoroughly amalgamated with $\text{Hg}(\text{NO}_3)_2$ solution and Hg. A porous clay cell is inserted; this serves as the anode chamber. The anode placed in this chamber consists either of a water-cooled lead coil or a lead vessel closed on top by a lid equipped with an inlet and an outlet for cooling water. The entire vessel is immersed in ice water, and the anode cooling water is also kept as cold as possible with ice water. A ring-shaped stirrer which can be moved up and down about once a second by a simple mechanical device (a string attached eccentrically to a disk suffices) is placed around the anode. The anode chamber is first filled with 50% sulfuric acid. After the clay cell has been well soaked with acid, the outer annulus is filled with the same acid, the stirrer is put into operation, and the current is adjusted to 24 amp. A solution of 20 g. of nitric acid

diluted with 30 ml. of H₂O is added to the cathode liquid over a period of two hours from a funnel equipped with a capillary tip. The temperature should not exceed 15°C. The electrolysis is continued for approximately another 45 minutes until the cathode liquid gives only a faint test for NO₃⁻ (FeSO₄ and concentrated H₂SO₄). The cathode liquid is then removed from the reaction vessel and diluted with an equal quantity of H₂O. All SO₄²⁻ present is precipitated with the calculated stoichiometric quantity of warm BaCl₂ solution, using intermittent cooling. The precipitated BaSO₄ is suction-filtered and washed. The filtrate, together with the washings, is dried under vacuum on a water bath. The dry residue is recrystallized from half its weight of water. Electrolytic efficiency: 0.2 g./amp.-hour.

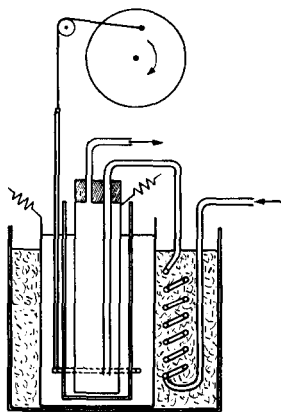
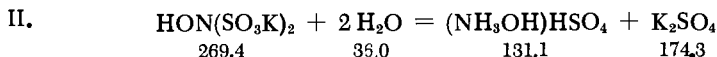

Fig. 188. Preparation of hydroxylammonium chloride by electrolysis.



Potassium hydroxylamine disulfonate is dissolved in the smallest possible quantity of boiling water; the solution is boiled for several hours and then evaporated to induce crystallization. The solution is separated from the potassium sulfate formed; hydroxylammonium sulfate is obtained by further evaporation. The pure product is obtained by further fractional crystallization. The crude salt mixture obtained by evaporation can also be extracted with alcohol in a Soxhlet apparatus, since the hydroxylamine salt is soluble in alcohol. The chloride is obtained from the sulfate with BaCl₂, as above.

PROPERTIES:

Formula weight 69.50. Colorless crystals. Decomposes to NH₄Cl, N₂O, H₂O and HCl upon dry heating. Hydrolyzes, giving an acid reaction. Strong reducing agent. Oxidizes Fe(OH)₂.

REFERENCES:

- F. Tafel, Z. anorg. allg. Chem. 31, 322 (1902).
 E. P. Schoch and Pritchett, J. Amer. Chem Soc. 38, 2042 (1916).
 F. Raschig, Lieb. Ann. Chem. 241, 183 (1887).

Hydroxylammonium Salts

HYDROXYLAMMONIUM PHOSPHATE

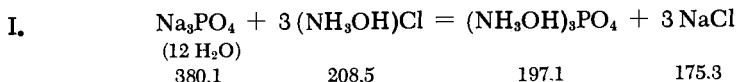

A solution of 500 g. $\text{Na}_3\text{PO}_4 \cdot 12\text{H}_2\text{O}$ is prepared in one liter of hot water. The filtered solution is added to a filtered solution of 273 g. of $(\text{NH}_3\text{OH})\text{Cl}$ in 600 ml. of hot water. The mixture is allowed to cool and is suction-filtered. Approximately 200 g. of hydroxylammonium phosphate is obtained. Further hydroxylammonium phosphate can be isolated from the mother liquor by evaporation, giving a total yield of about 90%.

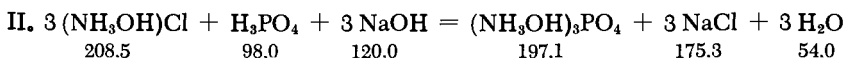

A solution of 210 g. of $(\text{NH}_3\text{OH})\text{Cl}$ in 200 ml. of H_2O is prepared by heating. It is filtered and put into a 1.5-liter beaker placed in an empty cooling bath. A mechanical stirrer and a thermometer are placed in the solution and 115 g. of 85% phosphoric acid is rapidly added. A cooled solution of 120 g. of NaOH in 400 ml. of H_2O is then added from a dropping funnel as fast as individual drops can be maintained. The final temperature should be 70°C . If the temperature threatens to exceed 75°C , the cooling bath should be filled with ice and water. The separation of hydroxylammonium phosphate usually starts toward the end of the addition of NaOH . Upon completion of the addition, the bath is filled with ice and the reaction mixture cooled to 15°C . The crystals are separated from the mother liquor on a large fritted glass filter and washed three times with 100 ml. of water. The suction is interrupted during each water addition and the crystals are mixed well with the washing water. The crystals are dried overnight in air and then under vacuum over P_2O_5 . The yield is 175-180 g. of 95% hydroxylammonium phosphate. For purification the entire mass is dissolved in 1750 ml. of water at $80\text{-}85^\circ\text{C}$. Recrystallization takes place upon cooling. After filtration, washing and drying, as described above, the yield is about 140-145 g. with a purity of about 98%.

PROPERTIES:

White salt. Free hydroxylamine forms upon heating.

REFERENCES:

- R. Uhlenhut, Lieb. Ann. Chem. **311**, 117 (1900).
 P. F. Tryon, in L. F. Audrieth, Inorg. Syntheses, Vol. III, New York-London 1950, p. 82.

HYDROXYLAMMONIUM ARSENATE

Can be prepared in the same manner as hydroxylammonium phosphate by substituting a solution of 312 g. of $\text{Na}_2\text{HAsO}_4 \cdot 7\text{H}_2\text{O}$ in 300 ml. of H_2O for the phosphoric acid. For neutralization a solution of 40 g. of NaOH in 100 ml. of H_2O (efficient cooling not necessary) is required. The crystals are washed three times with 150 ml. of water. The yield is 200-210 g. of 95% salt. After purification by recrystallization from an eightfold volume of water, the yield of 98% pure salt is about 145 g. Formula weight 241.03.

HYDROXYLAMMONIUM OXALATE

Can also be obtained from the stoichiometric quantities of hydroxylammonium chloride, oxalic acid and sodium hydroxide (sufficient for neutralization). A diluted solution of the hydroxylammonium salt (140 g. in 400 ml. of water) is used. All the solid oxalic acid is added at once with vigorous mechanical agitation, and the mixture is neutralized with a solution of 80 g. of NaOH in 200 ml. of H_2O . This solution is added in the fastest possible stream of separate drops. The mixture is agitated for 30 minutes, cooled to 15°C , filtered and washed three times with 100 ml. of H_2O . Since the salt at this point often contains up to 10% of oxalic acid, it must be recrystallized from eight times its weight of water. The yield is 95 g.; the purity is 99%. Formula weight 156.10.

Hydroxylamine

NH_2OH

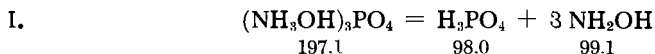

Tertiary hydroxylammonium phosphate (20 g.) is placed in a 100-ml. distillation flask. Coarse salt, such as that obtained by seeding, is preferably used. The full scale of the thermometer inserted in the neck of the flask should be above the stopper (stem correction thermometer); the bulb reaches almost to the bottom of the flask. The flask is connected to an aspirator via a receiver. An in-line manometer is essential. The apparatus is evacuated to 13 mm. and heated carefully with an open flame. Some salt dust is readily carried over in the beginning, and this results in contamination of the product. If the receiver is cooled, the product immediately solidifies, and characteristic, pointed crystals form. The bulk of the material distills over at 13 mm. at a thermometer reading of $135\text{--}137^\circ\text{C}$. The flask is heated intermittently until the

temperature reaches 150 to 170°C; the pressure should not exceed 30-40 mm. Should the pressure exceed 40 mm., cooling must be immediately applied, lest an explosion occur (goggles must be worn!). The product distilling over at 150°C is no longer completely anhydrous. A total of 5.6 g. of distillate is obtained from 20 g. of phosphate.

The hydroxylamine obtained by distillation, which still contains water, can be purified by recrystallization from absolute alcohol. A solution of 5 g. in 100 ml. of alcohol is prepared and cooled to -18°C. It is rapidly suction-filtered and dried in a vacuum desiccator over H₂SO₄, but as briefly as possible because of the volatility of the compound.

II. CONCENTRATION BY FREEZING FROM ALCOHOLIC HYDROXYLAMINE SOLUTION

A cylindrical vessel is placed inside a Bruehl distillation receiver and secured in place with a cork stopper. The lower end of the condenser adapter is closed with a CaCl₂ tube. A rubber stopper with two holes, each of which carries a dropping funnel, is set in the upper side tube. The shaft of a powerful three-propeller stirrer is introduced through the center tube. The cylindrical vessel contains 34.7 g. of very finely pulverized (NH₂OH)Cl, to which is added 50 ml. of absolute ethanol mixed with 0.01 g. of solid phenolphthalein. One of the dropping funnels is filled with hydroxylammonium chloride solution, identical with that found in the cylindrical vessel. The other is filled with sodium ethoxide solution (made by dissolving 11.5 g. of Na in 200 ml. of absolute alcohol). After about ten minutes of agitation, the ethoxide solution is slowly added in drops. The reaction is terminated after 1.5 to 2 hours. If the solution is reddish, some hydroxylamine salt solution from the first funnel is added until the color disappears. The solution is rapidly suction-filtered from the NaCl formed, which is rinsed with a small amount of absolute alcohol, and the filtrate plus the washing is placed in an ice-salt freezing mixture to crystallize. The crystals are suction-filtered at -18°C on a fritted glass filter. The yield is about 40%. The NH₂OH still present in the NaCl residue and in the alcohol can be readily recovered. There are no losses due to decomposition. Butyl alcohol and Na butoxide can be used instead of ethyl alcohol.

PROPERTIES:

Formula weight 33.03. M.p. 33°C. Very hygroscopic. Odorless. Produces blisters on contact with skin. Deliquescent in air. Burns on a Pt sheet when heated. A drop heated in a test tube will detonate with a very loud noise. Very volatile.

REFERENCES:

- R. Uhlenhut, Lieb. Ann. Chem. 311, 117 (1900).
 E. Ebler and E. Schott, J. prakt. Chem. (2) 78, 318 (1908).
 L. F. Audrieth, Z. angew. Chem. 45, 386 (1932).
 H. Lecher and J. Hofmann, Ber. dtsh. chem. Ges. 55, 915 (1922).
 C. de Witt-Hurd and H. J. Brownstein, J. Amer. Chem. Soc. 47, 67 (1925).

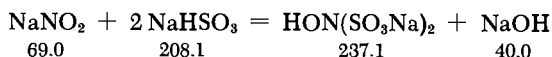
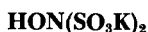
Potassium Hydroxylamine Disulfonate

A solution of 69 g. of NaNO_2 in the minimal quantity of water is prepared and mixed with 200 g. of ice. A cooled solution of NaHSO_3 , prepared either by dissolving 208 g. in the minimal quantity of water or by dissolving the same quantity in 600 ml. of technical (35%) bisulfite solution, is added in portions with agitation. Ice should still be present at the end of the addition. A cold, saturated solution of 150 g. of KCl is then added and the reaction mixture is left to stand for 24 hours. Half of the theoretical yield of disulfonate separates as compact crystals together with fine needles of trisulfonate. The nitriлотrisulfonate can be easily removed by washing and decantation. The $\text{HON}(\text{SO}_3\text{K})_2$ is then recrystallized from a small amount of hot water to which some KOH or ammonia is added (a few seed crystals are retained for this purpose from the first crystallization because the salt tends to form supersaturated solutions).

In another procedure, one mole of KNO_2 and 1.1-1.2 moles of potassium acetate are dissolved in 200 ml. of ice water; 1500 g. of finely shaved ice is added and SO_2 is bubbled through the agitated reaction mixture until the solution gives the characteristic odor of the gas. The temperature may not exceed 0°C . The disulfonate formed may be washed with a small amount of water and recrystallized as above.

PROPERTIES:

Formula weight 269.35. Hard, shiny crystals, which readily decomposed to K_2SO_4 and hydroxylamine on boiling with water.

REFERENCES:

- F. Raschig, Lieb. Ann. Chem. 241, 183 (1887).
 G. K. Rollefson and C. F. Oldershaw, J. Amer. Chem. Soc. 54, 977 (1932).

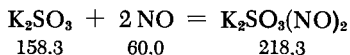
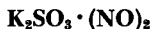
Potassium Dinitrososulfite

One quarter of a weighed quantity of KOH is dissolved in a small amount of water in a large flask, and the solution is saturated with SO_2 . The remaining KOH and sufficient water to dissolve it are added. The solution is then diluted with an equal volume of water. A fast stream of NO from a gasometer is bubbled in until all the air is displaced. The outlet tube is then closed and more NO is introduced under the pressure of the gas holder. During this operation, the flask is cooled in a cold water bath and repeatedly shaken. Shiny crystals of $\text{K}_2\text{SO}_3(\text{NO})_2$ soon separate in profusion. They are rapidly suction-filtered on a fritted glass filter and briefly washed twice with ice water.

PROPERTIES:

Formula weight 218.28. Shiny needles. Stable in a dry environment. Explodes upon heating. Air moisture hydrolyzes it to K_2SO_4 and N_2O . Readily soluble in water but the solution soon decomposes, yielding N_2O and K_2SO_4 . Reduction yields hydrazine disulfonate.

REFERENCES:

- E. Weitz and F. Achterberg, Ber. dtsh. chem. Ges. 66, 1718, 1728 (1933).
 G. A. Jeffrey and H. P. Stadler, J. Chem. Soc. (London) 1951, 1467.
 E. Degener and F. Seel, Z. anorg. allg. Chem. 285, 129 (1956).

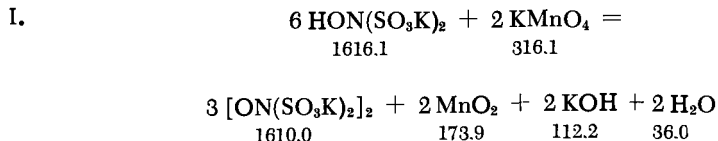
Potassium Nitrosodisulfonate

A 5N solution of NaNO_2 (35 g. in 100 ml. of H_2O) is mixed with 200 g. of ice, and 100 ml. of 5N bisulfite solution is added with vigorous stirring. Then 20 ml. of glacial acetic acid is added. After a few seconds the solution is tested to determine whether

it turns blue with a drop of KI solution. Then 25 ml. of 10N ammonia solution is added, followed by (with stirring) 400 ml. of prepared 1N permanganate solution (12.6 g./400 ml.). A thick sludge of MnO_2 separates; after a short settling period this is filtered off through a large fluted filter. The first 50 ml. of filtrate is passed again through the filter. A 250-ml. quantity of the dark-violet filtrate is mixed with 500 ml. of cold, saturated KCl solution. A crystalline mass of yellow needles soon separates; the mass is rapidly suction-filtered and washed briefly with ice water.

II. First, 84 g. of $NaHCO_3$ and 70 g. of $NaNO_2$ are dissolved in 500 ml. of water, and then 1000 g. of ice added. Sulfur dioxide is introduced at $-2^\circ C$ with stirring and cooling until the mixture is acid (pH 2). After 40 minutes, the solution turns orange-brown. Stirring is continued for another ten minutes while the introduction of SO_2 is discontinued; the solution turns colorless. Purified air is then bubbled through the solution for five minutes. After addition of 125 ml. of saturated Na_2CO_3 solution, the mixture should have a pH of 9. The mixture is stirred for 1.5 hours at room temperature, 1000 ml. of distilled water and 360 g. of PbO_2 are added, and stirring on a water bath is continued for another 30 minutes while the temperature is maintained at 20 to $40^\circ C$. After 25 minutes of agitation, the violet solution is allowed to settle for five minutes and then filtered. The pH of the filtrate is 10. Carbon dioxide is then introduced until the pH is 7 to precipitate the Pb as the carbonate. The lead carbonate is filtered off and 30 ml. of saturated Na_2CO_3 solution is added; after this addition the pH should be 9. Then 500 g. of KNO_3 is added with stirring (pH 8.5). Beautiful crystals of Frémys salt are obtained from the solution. They are very stable after drying.

SYNONYM:

Frémys salt.

PROPERTIES:

Yellow needles, yielding a violet solution in water. Monomolecular (formula weight 268.24) in solution, dimerized (formula weight 536.68) as a solid. Recrystallizable from 1N KOH. Dry, pure preparations that have been washed with pure methanol and ether are stable practically indefinitely if kept in a clean glass container under vacuum. The containers described in Part I, p. 75, are recommended (G. Brauer, private communication).

REFERENCES:

- H. I. Teuber and G. Jellinek, *Ber. dtsh. chem. Ges* **85**, 95 (1952).
F. Raschig, *Schwefel- und Stickstoffstudien* [Studies on Sulfur and Nitrogen], Leipzig-Berlin 1924, p. 148.

G. Harvey and R. G. W. Hollingshead, *Chem. and Ind.* 1953, 249.
 D. J. Cram and R. A. Reeves, *J. Amer. Chem. Soc.* 80, 3094 (1958).

Potassium Nitrilosulfonate

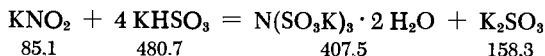
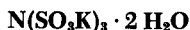

A solution of 75 g. of KOH in 150 ml. of water is saturated with SO_2 . A solution of 25 g. of KNO_2 in 100 ml. of water is added to the above hot solution with vigorous stirring. The liquid soon becomes cloudy because of precipitation of fine crystalline needles. The suspension is allowed to stand for one hour and the separated precipitate is redissolved by addition of 1500 ml. of hot water and heating. The solution must be alkaline at all times, and if necessary, a few more KOH pellets should be added. The solution is allowed to cool; the precipitate is suction-filtered, washed thoroughly with ice water, then with alcohol and ether, and finally dried in a desiccator. The yield of the dried, washed salt is 74 g. (62% of theoretical). In acid solution, disulfonate is rapidly formed. This is the reason why all bisulfite must be removed by careful washing.

PROPERTIES:

Shiny, rhombic crystalline needles. The pure salt may be stored in a desiccator for many weeks. Slightly soluble in water and liquid NH_3 . Saponified rapidly to imidosulfonate in an acid medium. Saponified to amidosulfonate at boiling temperatures.

REFERENCES:

A. Claus and S. Koch, *Lieb. Ann. Chem.* 152, 336 (1869).
 H. Sisler and L. F. Audrieth, *J. Amer. Chem. Soc.* 60, 1947 (1938).

Potassium Imidosulfonate

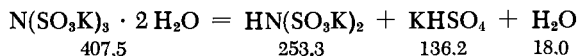

Potassium nitrilosulfonate (38 g.) is wetted with 16 ml. of 2% H_2SO_4 and left to stand for 24 hours. The paste is suction-filtered

and washed with 60 ml. of ice water. It is then recrystallized from a mixture of 60 ml. of water and 10 ml of concentrated ammonia. The crystals that precipitate upon cooling of the solution are washed with ice water, alcohol and ether and dried in a desiccator over H_2SO_4 . The yield is 12 g. or 51% of theoretical.

PROPERTIES:

Formula weight 253.3. Granular crystal aggregates or shiny plates. Very slightly soluble in cold water (but more soluble than the nitrilosulfonate). The dry salt is stable. Saponifies to amidosulfonate in boiling water.

REFERENCES:

- F. Raschig, Lieb. Ann. Chem. 241, 171 (1887).
 H. Sisler and L. F. Audrieth, J. Amer. Chem. Soc. 60, 1947 (1938).
 G. J. Doyle and N. Davidson, J. Amer. Chem. Soc. 71, 3491 (1949).

Potassium Amidosulfonate

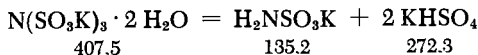

Potassium nitrilosulfonate (60 g.) is boiled for 75 minutes with 300 ml. of water. The solution is then neutralized with 20 g. of K_2CO_3 and evaporated to dryness. The residue is extracted with 80% alcohol for 46 hours in a Soxhlet apparatus. Cooling of the alcoholic solution yields 13.5 g. of amidosulfonate (67% of theoretical).

PROPERTIES:

Colorless crystals. Very readily soluble in water, slightly soluble in alcohol.

REFERENCES:

- F. Raschig, Lieb. Ann. Chem. 241, 176 (1887).
 H. Sisler and L. F. Audrieth, J. Amer. Chem. Soc. 60, 1947 (1938).
 S. H. Maron and A. R. Berens, J. Amer. Chem. Soc. 72, 3571 (1950).

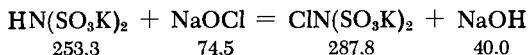
Potassium Chloroimidosulfonate

With efficient cooling, 7.1 g. of Cl_2 is introduced into an ice cold solution of 8 g. of NaOH in 20 ml. of water (thermometer in the flask). Then 25 g. of potassium imidosulfonate is added to the solution. The mixture is heated on a water bath with occasional shaking until all solids are dissolved. It is left to stand on the water bath for several hours, then cooled to separate the $\text{ClN}(\text{SO}_3\text{K})_2$.

PROPERTIES:

Water clear crystals. Unstable, decomposes to NCl_3 and $\text{N}(\text{SO}_3\text{K})_3$.

REFERENCE:

F. Raschig, Z. anorg. allg. Chem. 147, 1 (1925).

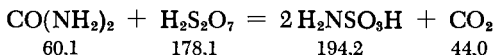
Amidosulfonic acid

Urea (100 g.) is added over a period of 45 minutes to 560 g. of 100% H_2SO_4 . The mixture must be thoroughly agitated with a mechanical stirrer and efficiently cooled so that the temperature does not exceed 40°C . Then 309 g. of oleum (65% SO_3) is added and the reaction mixture is left to stand for 16 hours at 42 to 45°C . The crystals are suction-filtered on a fritted glass filter and washed, first with concentrated and then with 50% H_2SO_4 , and finally with cold methanol. The yield is 90%.

PROPERTIES:

Formula weight 97.10. Colorless crystals. Very stable. Can be used as a primary titration standard in alkalimetry.

REFERENCE:

P. Baumgarten, Ber. dtsch. chem. Ges. 69, 1929 (1936).

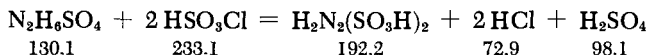
Potassium Hydrazinedisulfonate

A suspension of 130 g. of dry hydrazine sulfate in 600 g. of dry pyridine is prepared. Chlorosulfonic acid (300 g.) is added in portions from an addition funnel with stirring and cooling. Finally, the mixture is heated to 90-100°C on a water bath. It is then allowed to cool, and alcohol is added with shaking. The crystalline mass that separates is suction-filtered. For purification the pyridine salt so obtained is redissolved in a small amount of water, some alcohol is added, and the mixture is evaporated in a desiccator until copious crystallization is induced. The crystals are then suction-filtered. This pyridine salt, in the form of needles with a silken sheen, can be used for the preparation of potassium azodisulfonate. The compound is readily soluble in water and very slightly soluble in alcohol. For the preparation of the potassium hydrazinedisulfonate, the crystals need not be isolated. Thus, instead of alcohol, 300 g. of ice and as much potassium hydroxide solution (d 1.39) as needed to make the solution barely alkaline are added to the impure mixture after cooling. The precipitated salt is suction-filtered and washed with cold water. The yield is about 200 g.

The ammonium salt can be prepared in the same way, by neutralizing with ammonia instead of KOH. It must be precipitated from the solution with alcohol because it is very soluble in water. It can also be readily prepared from the pyridine salt, which is then dissolved in the minimum amount of water and neutralized with ammonia. Crystallization is effected by addition of alcohol. The yield is 90%.

PROPERTIES:

The potassium salt is very slightly soluble in water (formula weight 268.36). The ammonium salt is readily soluble in water, very slightly soluble in alcohol. Shiny plates. Pyridine salt: needles with a silken sheen, very soluble in water.

REFERENCES:

- F. Raschig, Schwefel- und Stickstoffstudien [Studies on Sulfur and Nitrogen], Leipzig-Berlin 1924, p. 199.
 E. Konrad and R. Pellens, Ber. dtsh. chem. Ges. 59, 135 (1926).

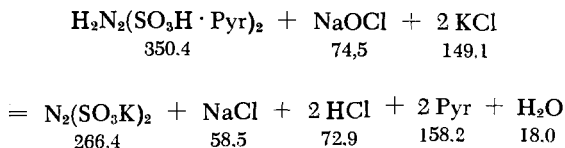
Potassium Azodisulfonate

Five grams (0.014 mole) of the pyridine salt of hydrazinesulfonic acid, described in the preceding preparation, is dispersed in a small amount of water and congealed to a slurry in a freezing mixture at -20°C . Similarly, 0.028 mole of NaOCl (oxidation value 7%; i.e., 2 g. of Cl_2 is introduced into an ice-cold solution of 2.3 g. of NaOH in 25 ml. of H_2O) is slurried, together with 10 ml. of 12% NaOH. The hypochlorite slurry is added to the pyridine salt slurry with stirring and cooling, and after ten minutes it is allowed to warm to a maximum of -7°C . No gas should evolve during the process. Then 10 ml. of cold, saturated KCl solution is added. The potassium azodisulfonic acid separates immediately. It is immediately placed on a well-cooled suction filter, washed with cold alcohol and cold ether, and then placed in a vacuum desiccator while still moist with ether (danger of detonation!). The material is dried over P_2O_5 . The yield is 80-90%.

PROPERTIES:

Small, yellow crystalline needles.

REFERENCE:

E. Konrad and R. Pellens, Ber. dtsch. chem. Ges. 59, 135 (1926).

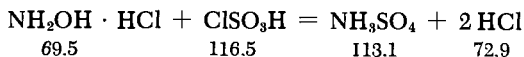
Hydroxylamineisomonosulfonic Acid

One mole of $\text{NH}_2\text{OH} \cdot \text{HCl}$ is placed in a 600-ml. beaker and 1.5 moles of ClSO_3H is slowly poured over it. The mixture effervesces and forms intense hydrogen chloride fumes. The mixture is allowed to cool and the salt dissolves. When the reaction begins to subside, the mixture is heated for 10-15 minutes at 70 to 80°C . However,

the temperature should not exceed 80° C since decomposition occurs at that temperature. The viscous lumps that form must be broken up by stirring. The mixture is cooled in a desiccator over NaOH. The beaker is then immersed in ice and absolute ether, cooled to 0° C, is poured over the substance. The ether reacts vigorously with the excess ClSO_3H . After comminution with a stirring rod and standing one hour under ether, the reaction product appears as a finely dispersed precipitate, which is suction-filtered and washed with two liters of absolute ether. The powder of hydroxylaminesulfonic acid is stored in a vacuum desiccator over P_2O_5 because of its great hygroscopicity. The yield is almost quantitative. The purity is about 98%. It may be analyzed by iodometric titration. The acid may be further purified and thus obtained as fine crystals by dissolving the crude material in ice-cold absolute methanol and adding the filtered solution in drops to twice its volume of dry chloroform.

PROPERTIES:

White, hygroscopic powder or water-clear prisms. Forms hydrazine with ammonia. Hydrolyzes slowly in water. Decomposes in warm, aqueous alkaline solutions to H_2SO_4 and short-lived imine (NH); thus, it may serve as an amination agent. M.p. about 210° C. Has oxidizing properties.

REFERENCES:

- F. Sommer, O. F. Schulz and M. Nassau, *Z. anorg. allg. Chem.* 147, 144 (1925).
 F. Sommer and H. G. Templin, *Ber. dtsch. chem. Ges.* 47, 1221 (1914).
 G. Arens, Private communications, unpublished.
 U. Wannagat and R. Pfeiffenschneider, *Z. anorg. allg. Chem.* 297, 151 (1958).

Nitrosyl Chloride

NOCl

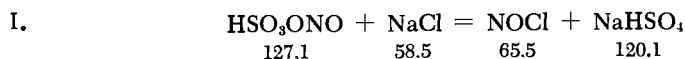

A mixture of 127 g. of nitrosyl hydrogen sulfate (see p. 406) and 58.5 g. of well-dried sodium chloride is prepared in a half-liter flask equipped with a ground glass joint and a gas outlet tube. The flask is warmed on a water bath and the gases are led into a

well-cooled trap. The nitrosyl chloride may also be prepared directly, thus avoiding the preparation of nitrosyl hydrogen sulfate. To accomplish this, N_2C_3 , obtained from As_2O_3 and HNO_3 , is dried over $CaCl_2$ and then added to concentrated H_2SO_4 . The resulting slurry is used instead of the pure nitrosyl hydrogen sulfate. It is heated after introduction of well-dried $NaCl$. Of course, nitrosyl hydrogen sulfate can also be prepared by addition of SO_2 to HNO_3 . The resulting thick slurry may be used directly, without preliminary isolation of the nitrosyl hydrogen sulfate. At the end of the preparation the temperature of the water bath in which the $NOCl$ reaction flask is immersed is preferably increased to $110^\circ C$ by addition of $NaCl$. The $NOCl$ condensate is purified by distillation. This is especially necessary if a non-stoichiometric quantity of pure nitrosyl hydrogen sulfate was used, but rather a slurry of impure material containing concentrated H_2SO_4 . In this case, the $NOCl$ product may contain dissolved HCl .

Other preparative methods:

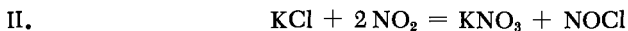

Liquid nitrogen dioxide is passed through a vertical, 60-cm.-long column packed with moist KCl (containing about 2.4% H_2O), so that the total flow is approximately 20 ml. in three hours. The reaction in the column can be followed by observation of the sharp separation zones. In a properly run reaction, the reaction zone never reaches the upper end of the tube and there is no NO_2 in the product gas. The product gas is purified by distillation as indicated above.



Chlorine gas is liquefied in a suitable vessel and saturated at -50 to $-60^\circ C$ with NO prepared from nitrosyl hydrogen sulfate and Hg . The crude product is passed through a glass tube heated to $150^\circ C$. It is then recondensed and purified by distillation.

PROPERTIES:

Yellowish-red gas, which condenses to a yellowish-red liquid at $-5^\circ C$. Yellowish-red crystals below $-60^\circ C$. The liquid is very corrosive to the skin; the vapor attacks stopcock grease.

REFERENCES:

- W. A. Tilden, J. Chem. Soc. (London) 27, 630 (1874); 59, 73 (1891).
 A. F. Scott and C. R. Johnson, J. Phys. Chem. 33, 1975 (1929).
 M. Trautz and W. Gerwig, Z. anorg. allg. Chem. 134, 409 (1924).
 E. Wourtzell, J. Chim. Phys. 11, 243 (1913).
 C. W. Whittacker, F. O. Lunsfröm and A. R. Merz, Ind. Eng. Chem. 23, 1410 (1931).

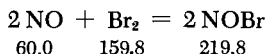
Nitrosyl Bromide

Dry NO is added to 80 g. of Br₂, cooled to 0°C. During the introduction of the gas the Br₂ is gradually cooled to -10°C by placing the flask in a freezing mixture. The completely saturated liquid weighs about 28 g. more than the initial. The reaction mixture is slowly heated; the NOBr distills at 24°C. It is collected in a cooled ampoule.

PROPERTIES:

Formula weight 109.92. Dark brown liquid which readily decomposes upon warming.

REFERENCE:

O. Froelich, Lieb. Ann. Chem. 224, 272 (1884).

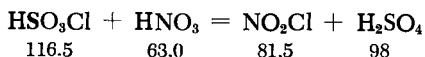
Nitryl Chloride

I. A three-neck, ground glass joint flask, the center neck of which carries a mercury-seal stirrer, is charged with 63 g. of 94.4% HNO₃. An addition funnel is placed in one of the side necks, with the tip of its outlet tube immersed in the HNO₃, and 116.5 g. of chlorosulfonic acid is added from it. The flask should be well cooled (5 to 10°C) and vigorous agitation must be provided. The third neck of the flask carries a gas outlet tube, which leads, via a wash-flask filled with 96% H₂SO₄, to a condensation trap for the NO₂Cl. The yield is 73 to 74 g. (90% of theoretical).

II. Schmeisser recommends three condensation traps connected with ground glass joints. The first is filled with 122 g. of HSO₃Cl and the next with 69 g. of 100% HNO₃; the third remains empty and is connected to a vacuum pump. Both traps are cooled to at least -60°C and are evacuated for about five minutes. A stopcock located between the second and the third (empty) trap is then closed and cooling of the HNO₃ vessel discontinued. Shortly afterward, HNO₃

distills into the first trap. The level of the coolant is maintained at that of the HSO_3Cl and the HNO_3 thus condenses immediately above the HSO_3Cl . When the distillation is complete, the stopcock to the third trap is opened, and the latter is cooled with liquid nitrogen. The other two traps are allowed to warm slowly to above -60°C while still in their cooling baths. A constant stream of pure NO_2Cl evolves and condenses in the third trap. The cooling bath of the first trap may be slowly warmed to -20°C . When the HNO_3 used is incompletely anhydrous or is contaminated with nitrogen oxides, some red NOCl may form, especially toward the end of the reaction. The yield is almost quantitative.

Other preparative methods:

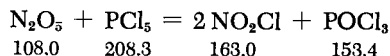
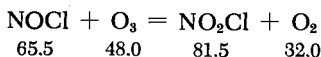

PROPERTIES:

B.p. -15°C , m.p. -149°C , d (-20°C) 1.46.

REFERENCES:

- K. Dachlauer (I. G. Farben), German Patent 509405 of 8/30/1929, in Chem. Zentr., 1930 II, 3832.
 H. J. Schumacher and G. Sprenger, Z. anorg. allg. Chem. 182, 139 (1929); Z. phys. Chem. (B) 12, 115 (1931).
 M. Schmeisser, Private communication; Z. anorg. allg. Chem. 255, 33 (1948).
 H.H. Batey and H. Sisler, J. Amer. Chem. Soc. 74, 3408 (1952).
 R. Kaplan and H. Shechter, in J.C. Bailar, Inorg. Syntheses, Vol. IV, New York-London-Toronto, 1953, p. 52.
 F. Seel and I. N6gr6dy, Z. anorg. allg. Chem. 269, 188 (1952).

Sodium Nitrosyl

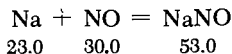

A boat containing 1 g. of fresh Na is placed in a glass tube which has provision for very slow and uniform heating in a well-regulated electric furnace or a hot air jacket. A thermometer, the tip of

which is placed as close as possible to the boat, is inserted in the air jacket or the electric furnace. A mixture of 18-20% NO and pure N₂ (free of O₂) is introduced through a glass tube set in a stopper which fits one end of the reactor tube. A wash bottle with concentrated H₂SO₄ is attached at the inlet and outlet of the reactor tube. The gas mixture is dried with CaCl₂ and initially flows in at a rate of two or three bubbles per sec. When the air has been displaced, heating is begun very slowly and carefully. When the thermometer reads 150-170°C, the reaction starts, and a light-yellow mass is formed. The Na slowly swells, and a gray mass fills almost the entire cross section of the tube. The temperature is then raised to 180°C and the rate of gas flow is increased. The mass turns light-yellow to nearly white. When no further change is noted, the heating is discontinued and the substance is allowed to cool in a stream of N₂. When 1 g. Na is used, the entire experiment lasts three to four hours.

Other preparative method: A product with similar composition but with somewhat different properties is obtained, according to Zintl and Harder, by the reaction of NO with a blue solution of sodium in liquid NH₃.

PROPERTIES:

Soluble in H₂O, forming N₂O. Silver nitrate precipitates yellow Ag₂N₂O₂ from aqueous solutions of the compound on acidification with acetic acid. Nitrite is also present in the final solution.

REFERENCES:

- H. Gehlen, Ber. dtsh. chem. Ges. 72, 159 (1939).
E. Zintl and A. Harder, Ber. dtsh. chem. Ges. 66, 760 (1933).

Sodium Nitroxylate

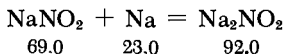

The reaction tube described on p. 87 (Fig. 69) is used for the preparation of sodium nitroxylate. Two grams of repeatedly crystallized and carefully high vacuum dried NaNO₂ are placed in leg *b* and tube *c* is sealed off. Fresh Na (0.4 g.) is placed in *a*. The ground glass cap *d* is put in place and its tube connected with rubber or tombac vacuum tubing to a high-vacuum apparatus (via stopcock 5). The apparatus is evacuated, stopcock 5 is closed, and

NH_3 is introduced via stopcock 1 and condensed on the Na in vessel 3. When 50 ml. of NH_3 collects in 3, stopcock 1 is closed, stopcock 5 is opened, and the apparatus is again evacuated. The stopcock in the line leading to the pump is then closed. By cooling both *a* and *b* and heating vessel 3, 20 ml. of NH_3 is condensed in each leg of the reaction tube. After the mixture dissolves, the Na solution is poured into the nitrite solution by tipping the tube. The glass wool placed in *e* prevents solid particles from reaching *b*. The apparatus must be cooled to a point above *e* to prevent boiling of the NH_3 . The solutions must not be too concentrated. When the reaction is complete, the NH_3 is allowed to evaporate through valve 6. Alternately, it may be recondensed in vessel 3. If *b* is again cooled with liquid nitrogen, flakes of the product peel off the walls. The apparatus is then purged with pure N_2 dried over P_2O_5 (copper tower, see p. 458), and as soon as it appears at valve 6, the seal at *c* is broken. The product can now be crushed with a long glass rod. The wash tube (Fig. 70) may be used to free the product of its nitrite impurity. The wash tube is packed with glass wool at the middle. While pure N_2 is introduced at the bottom, the crude product is poured in through the wide-open top. As the N_2 flow continues, the upper end of the tube is narrowed with a hand torch, as shown in the figure. A piece of tubing is slipped over the narrowed tube, which is then connected to the vacuum apparatus via stopcock 5. The bottom end of the wash tube is then sealed off. The tube is thoroughly evacuated and dry NH_3 is condensed at the bottom by cooling. After evacuation, the upper end of the tube is also sealed and the cooling device (Fig. 70) is moved into place. The tube is then carefully heated from below. Gaseous NH_3 flows upward through the 3-mm.-diameter insert tube into the top part of the apparatus, condenses there on the walls, and extracts the substance remaining on the glass wool filter. (Caution: safety shield and goggles must be used!) After a few hours (not more than 24), the bottom end is cooled to -70°C , a hose is slipped over the upper end (which previously has been scratched with a glass file), the hose is connected to stopcock 5, and the end of the tube is broken off inside the hose. The ammonia is removed by suction and pure, dry N_2 allowed to enter. The bottom end of the wash tube is opened in the same manner; the product may now be removed in a N_2 stream.

PROPERTIES:

Bright yellow substance. Extremely sensitive to O_2 , NO , CO_2 . sensitive to H_2O ; hydrolyzes to N_2O , $\text{H}_2\text{N}_2\text{O}_2$ and NO . Stable up to 100°C . Decomposes at 130°C , emitting sparks and evolving N_2 .

REFERENCE:

E. Zintl and O. Kohn, Ber. dtsh. chem. Ges. 61, 189 (1928).

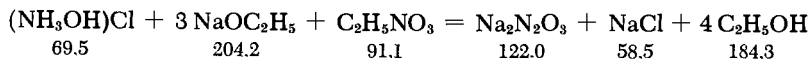
Sodium Hyponitrate

A saturated solution of 7 g. of dry hydroxylammonium chloride in warm absolute alcohol is slowly added to a concentrated solution of 7 g. of Na in absolute ethanol. The precipitated NaCl is suction-filtered and washed briefly with absolute ethanol. The filtrates are mixed with 9 g. of ethyl nitrate. The solution is cooled and the separated $\text{Na}_2\text{N}_2\text{O}_3$ is suction-filtered. It is washed briefly with cold absolute ethanol and dried in a desiccator over concentrated H_2SO_4 .

PROPERTIES:

White salt. Readily soluble in water. Thermally unstable. The free acid has not been isolated.

REFERENCES:

- A. Angeli, Gazz. 26, 18 (1896); 30, 593 (1900).
 O. Baudisch, Ber. dtsh. chem. Ges. 49, 1181 (1916).
 W.D. Bancroft, J. Phys. Chem. 28, 1181 (1916).
 L.H. Michigan and G.R. Gillette, J. Phys. Chem. 28, 754 (1924).

Phosphorus

R. KLEMENT

White Phosphorus

VERY PURE PHOSPHORUS

Commercial phosphorus is usually rather pure. It is, however, repurified for special purposes, either by double steam distillation (I) or by treating molten phosphorus with very dilute chromosulfuric acid (II).

I. Commercial phosphorus (100 g.) and 0.5 liter of water are placed in a four-liter flask connected to a steam generator, a tank of CO_2 and a condenser. An adapter on the condenser outlet connects to a receiver, partially filled with water. The adapter tube should empty below the water surface. The receiver is heated to $30^\circ C$ and the air in the apparatus is displaced with CO_2 . Steam is then introduced into the flask at a rate sufficient to keep the contents vigorously and continuously boiling. As CO_2 is slowly and continuously passed through, the phosphorus steam-distills in colorless, strongly refracting droplets which fall to the bottom of the receiver and eventually solidify. The receiver water is periodically changed. It takes about eight hours to distill 50 g. of phosphorus.

If the product is still not completely As-free, a second distillation yields pure material. To test for As, the phosphorus is oxidized with HNO_3 . The evaporated solution is taken up in HCl and precipitated with H_2S . The precipitate is dissolved in $(NH_4)_2CO_3$ and the solution acidified with HCl. The arsenic sulfide which precipitates is dissolved in NH_4OH and H_2O_2 , and the As precipitates as $NH_4MgAsO_4 \cdot 6 H_2O$.

II. Commercial white phosphorus is melted under dilute chromosulfuric acid, stirred vigorously with a glass rod, and after solidification, thoroughly washed with distilled water. Melting under acid must be repeated until the phosphorus is no longer yellow.

PROPERTIES:

Atomic weight 30.975. Pure phosphorus is white, translucent, soft and readily cut. It is brittle when cold and shows a crystalline structure at break surfaces. Beautiful crystals are obtained by

evaporation of a solution of white phosphorus in CS_2 or in benzene or by slow vacuum sublimation in the absence of light. Because of its low ignition temperature (60°C), phosphorus should not contact warm objects, and thus can be cut only when wet, preferably under water. On contact with skin, phosphorus produces deep, difficult-to-heal burns. Only water is used to put out a phosphorus fire on the skin. Skin burns should be treated with compresses soaked in a 1% solution of CuSO_4 . A physician should be called as soon as possible. A phosphorus burn must never be treated with a salve or an oil because white phosphorus is soluble in these substances and thus the burn can spread further on the skin. M.p. 44.1°C ; d 1.82. Almost insoluble in water, somewhat soluble in alcohol and acetic acid; readily soluble in ether, benzene, fatty oils, PCl_3 , PBr_3 , liquid NH_3 and liquid SO_2 . Miscible in all proportions with CS_2 .

REFERENCES:

- I. E. Nölting and W. Feuerstein. Ber. dtsch. chem. Ges. 33, 2684 (1900).
- II. I. Pakula. Brief communication.

GRANULAR WHITE PHOSPHORUS

Fine phosphorus powder is obtained by shaking pieces of phosphorus with warm water or warm urea solution (thick-wall, closed flask, mechanical shaker). As the liquid cools, the phosphorus solidifies to granules of various sizes.

REFERENCE:

- A. Michaelis. Liebigs Ann. Chem. 310, 56 (1960).

Red Phosphorus

Red phosphorus occurs in various forms which, according to Krebs, are not different modifications. Commercial red phosphorus is amorphous on x-ray analysis, and crystallizes exothermally above 450°C when heated at a rate of $1^\circ/\text{min}$. Depending on material history and the heating rate, the melting point varies between 580 and 610°C . The initially diffuse x-ray diffraction pattern becomes increasingly sharper on long heating to just below the melting point and ultimately becomes identical to that observed with Hittorf's phosphorus. This treatment increases the density from 2.10 (red phosphorus) to 2.32 (Hittorf's phosphorus). According to Schenck and Wolf, bright red phosphorus cannot be obtained pure, and Krebs refers to it as a "mixed polymerizate" containing varying amounts of bromine.

- I. Red Phosphorus. Commercial red phosphorus is purified as follows: Portions of 100 g. are boiled for 24 hours with a 7% NaOH solution. After removal of the hydroxide, the phosphorus is boiled

for 24 hours with water, washed with cold water until the alkaline reaction disappears (a centrifuge may be used here to advantage) and dried in vacuum on clay plates over P_2O_5 . Phosphorus which has stood for some time must be freshly washed before use because of its oxidation on exposure to air.

II. Hittorf's Phosphorus. Phosphorus dissolved in molten lead separates on cooling as a crystalline form (Hittorf's phosphorus). This material can be readily prepared via the Stock and Gomolka procedure, as improved by Pakulla.

White phosphorus, purified with very dilute cleaning solution, is weighed under ice water, quickly and carefully dried with filter paper and acetone, and placed at the bottom of a Pyrex ampoule which has been purged with CO_2 . The ampoule, 6-10 cm. long, has an inner diameter of 10-12 mm. and a wall thickness of 1.5-2 mm. The free space above the phosphorus is filled as completely as possible with strips of very pure, Zn-free lead. The ampoule should be filled up to the constriction. For example, 0.7 g. of phosphorus and 20 g. of lead or 1.1 g. of phosphorus and 35 g. of lead are used. Larger charges yield poorly formed crystals. The ampoule is evacuated with an aspirator, sealed by fusing, and placed horizontally in an electric furnace capable of delivering a large amount of heat. If the ampoule is made of Vycor and has been carefully sealed, no protective iron tube is needed, provided the temperature does not rise above $640^\circ C$. The ampoule is heated to $625-640^\circ C$ (the thermocouple should be located next to it). The temperature of the furnace is gradually reduced to about $400^\circ C$ over a period of several days. The heat is then shut off. After complete cooling, the ampoule is chilled in a salt-ice mixture so that the small amount of white phosphorus present does not burst into flame on opening. The ampoule contains mostly a small amount of crystalline Hittorf's phosphorus in the form of fine needles. The bulk of the phosphorus is occluded in the lead. It is recovered by electrolytic dissolution of the lead used as an anode.

The apparatus shown in Fig. 189 is used for this purpose. The vessel, which is made by breaking off the top of a one-liter bottle, contains the electrolyte, which is prepared from 200 g. of lead acetate and 800 ml. of 6% acetic acid. A lead plate *A*, 2 mm. thick, serves as the cathode. Soldered to it is a copper lead wire, which is insulated from the electrolyte by means of a rubber sheath and a glass tube. The Pb bar *B*, which serves as the anode, has a hole bored through its rounded end and is suspended from the Cu lead wire by a platinum wire sling so that one third of it is immersed in the liquid. A watch glass *C*, supported by glass rods halfway down through the liquid, serves as a trap for the P. The anode is surrounded by a glass cylinder *D*, 5 cm. in diameter, which protrudes 1 cm. into the fluid (the supporting clamp is not shown). The lead bar is then gradually lowered without letting the platinum wire come in contact with the solution. The current is adjusted to 0.5 amp.

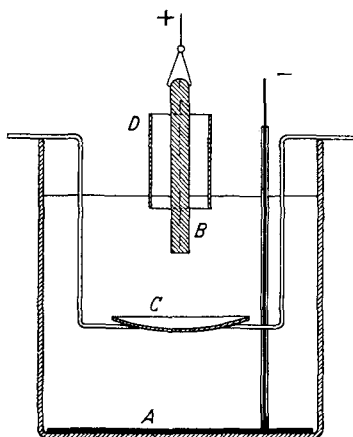
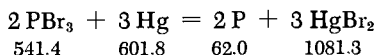

Fig. 189. Isolation of Hittorf's phosphorus. *A*—Lead cathode; *B*—lead rod containing Hittorf's phosphorus; *C*—watch glass; *D*—glass cylinder.

times a few millimeters long and 0.5 mm. thick. Depending on layer thickness, they range from bright to dark red. The sublimed needles are bright red to dark reddish-brown. Hittorf's phosphorus is never completely free of lead, the lead impurity ranging from 1.5 to 3%. A sample containing 1.5% lead has a density of 2.36. By extrapolation, the density of pure Hittorf's phosphorus is computed to be 2.31-2.33. The term "metallic" P for this modification is considered incorrect by Stock and Stamm because the material is not electrically conductive.

REFERENCES:

- W. Hittorf. *Pogg. Ann.*, 126, 193 (1865).
 A. Stock and F. Gomolka. *Ber. dtsch. chem. Ges.* 42, 4510 (1909).
 A. Stock and E. Stamm. *Ber. dtsch. chem. Ges.* 46, 3497 (1913).
 H. Krebs. *Z. anorg. allg. Chem.* 206, 175 (1915).
 I. Pakulla. Thesis, Bonn, 1953.
 H. Krebs, K. H. Müller, I. Pakulla and G. Zürn. *Angew. Chem.* 67, 524 (1955).
 III. Bright-red P. Bright-red P is obtained in Wolf's procedure by reduction of PBr_3 with Hg.



The lead is deposited on the cathode in well-formed crystals, which are pressed together from time to time with a glass spatula. The phosphorus collects on the watch glass as a reddish-brown crystalline powder. After electrolysis, the PbO_2 present is removed by suspending in water. The powder is then refluxed for 24 hours with 20% HCl in a CO_2 atmosphere. The acid is renewed three or four times until no further lead dissolves. The residue is centrifuged, washed with cold H_2O , and dried in vacuum over P_2O_5 . In some cases, glass splinters must be removed with hydrogen fluoride.

PROPERTIES:

Hittorf's phosphorus forms tetragonal plates which are some-

A mixture of 55 g. of Hg and 51 g. of PBr_3 (both as pure and dry as possible) is heated for two days at $100^\circ C$ in a sealed tube with constant shaking, special care being taken that the Hg does not adhere to the tip of the tube. The tube is then heated for one day in a furnace at $130^\circ C$; the temperature raised to $170^\circ C$ the following day. The product is carefully broken up and extracted six times with absolute ether in an extraction apparatus (two hours each time). After drying, it is heated once or twice in vacuum under dry, oxygen-free CO_2 to sublime the $HgBr_2$ byproduct. The residue consists of about 87% P, the remainder being Hg_2Br_2 and $HgBr_2$. This material is again placed in a combustion tube, a drop of PBr_3 is added for each gram of the substance, and after evacuation, the tube is sealed by fusing. The 0.5-m.-long tube containing the material is placed in a furnace; one third of the tube is allowed to protrude out of the furnace. The tube is carefully heated for one day at $220-240^\circ C$ and is then allowed to cool. The product $HgBr_2$ readily crystallizes in the tip of the tube. It is freed of the bulk of the remaining PBr_3 by a six-hour extraction, the ether being changed three times, and residual $HgBr_2$ is distilled off in CO_2 atmosphere at 25-30 mm. The brown-black residue becomes vermilion on cooling. If quantitative analysis shows this material to be still contaminated, it is remelted with PBr_3 and the procedure repeated. If the distillation is too slow, Hg_2Br_2 is formed, and whereas the PBr_3 distills off, the nonvolatile Hg_2Br_2 remains. In that case, repetition of the procedure only serves to transform the Hg(I) into Hg(II) salt.

PROPERTIES:

The bright-red phosphorus described here is quite different from that obtained by R. Schenck from white P and PBr_3 . Its color varies between that of red lead and vermilion and deepens (reversibly) to brown-black on heating to $250^\circ C$. According to Wolf, bright-red P is not an allotropic modification. Rather, it is to be considered a variant of the common "red" P, from which it is differentiated by its smaller particle size. Insoluble in ether and CS_2 . Not darkened either by liquid or aqueous NH_3 . The ignition temperature in air is about $300^\circ C$. In moist air it oxidizes slowly. d. ($24^\circ C$) 1.876.

REFERENCES:

- L. Wolf. Ber. dtsh. chem. Ges. 48, 1272 (1915).
R. Schenck. Ber. dtsh. chem. Ges. 36, 979 (1903).

Black Phosphorus

According to Bridgman, black P is formed by a pressure of 12,000 atm. acting for about one half hour on white P at $200^\circ C$.

This modification may be produced at room temperature by a shock wave of 100,000 atm. (Günther, Geselle and Rebentisch). According to Krebs, Weitz and Worms, large quantities of black P can be obtained by the catalytic action of Hg on white P at 370°C.

A mixture of 50 g. of distilled, white P and 50 g. of Hg is placed in an ampoule filled with pieces of copper-plated welding rods. At the same time, 0.5 g. of black P, which has been well pulverized beforehand in an atmosphere of N₂, is added as seed crystals. The ampoule is fused shut and gently heated until the white P melts. It is then shaken to achieve a good mix. As a result, a layer of seed crystal powder adheres to the newly amalgamated surface of the welding rod. The ampoule is heated in a protective iron tube to 220°C and then, over a period of two days, to 370°C. After a total of eight days, black P forms quantitatively. Its surface sometimes shows traces of white and red phosphorus.

To produce the seed crystals, a small ampoule filled with freshly distilled white P and 30–40 at. % Hg is placed in a furnace preheated to about 370°C. It is left there for three days at this temperature. It is then heated for one day at 380°C, one day at 390°C and three to four days at 410°C. The well-formed spherules of black P can be easily separated from the other material.

To extract the crude product from the admixed Hg, the pulverized sample is placed next to a piece of Pb and heated in an evacuated ampoule for several days at 300–450°C. After repeating the process with the repulverized sample and fresh Pb, the remaining Hg amounts to about 1 at. %. If gold is used instead of Pb in the second amalgamation the amount of Hg after heating to between 370°C and 440°C is reduced to about 0.5 at. %. The Hg content cannot be further reduced by this or any other method.

PROPERTIES:

Black P (containing Hg) takes up O₂ and H₂O in moist air and becomes coated with a layer of viscous fluid. After three weeks the weight gain of a pulverized sample amounts to about 13%. At higher temperatures the liquid layer is formed more rapidly. This layer protects the black P from air, and therefore it cannot be ignited with a match. Concentrated nitric acid (d. 1.4) reacts explosively with a fine pointed flame. Concentrated sulfuric acid is reduced to SO₂ at about 150°C. Warm 3–6% H₂O₂ reacts somewhat more rapidly with black P than with red, while bromine vapor or bromine dissolved in benzene attacks the black modification more slowly than the red. Heating for eight hours at 560°C causes transformation to red P. Forms rhombic crystals and has a layer lattice. Conducts electricity and rectifies AC current. d. 2.7–3.0.

REFERENCES:

- P. W. Bridgman. *Phys. Rev.* **3**, 187 (1914), *J. Amer. Chem. Soc.* **36**, 1344 (1914); **38**, 609 (1916); P. L. Günther, P. Geselle and W. Rebentisch. *Z. anorg. allg. Chem.* **250**, 373 (1943); H. Krebs, H. Weitz and K. H. Worms. *Z. anorg. allg. Chem.* **280**, 119 (1955).

Colloidal Phosphorus

Colloidal phosphorus can be prepared, according to Svedberg (I), by pulverizing red P with an electric spark. Roginsky and Schalnikoff (II) obtained a hydrosol of P through simultaneous condensation of P vapor and water vapor at the temperature of liquid air and subsequent thawing of the substance. According to German Pat. 401,049, colloidal P can be obtained by mixing a solution of white P in CS_2 with water in the presence of a protective colloid suspension agent (III).

I. A conical aluminum vessel containing red P and isobutyl alcohol is placed in a glass funnel with its upper edge ground flat (see Fig. 190). A glass cover is provided with a center hole for an Al electrode. The funnel insulates and supports the apparatus very effectively. The aluminum vessel and wire are attached to a power

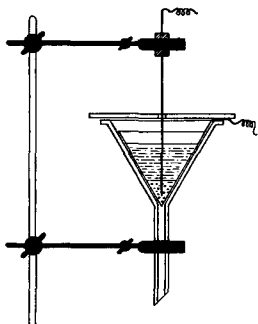

Fig. 190. Preparation of colloidal phosphorus.

supply (induction coil with a capacitor across the secondary) and a spark is produced within the liquid. The aluminum wire should be grounded in order to allow adjustment with the ungloved hand. The resulting colloid is practically colorless (slightly yellow) in transmitted light and flesh-colored in reflected light.

II. Water is placed in side tubes A_1 and A_2 of the apparatus shown in Fig. 191. Adapter B contains phosphorus which can be vaporized by means of an enclosing electric furnace. Before the run, the water is frozen by means of liquid nitrogen so that the apparatus can be evacuated. Liquid nitrogen is poured into vessel D and then the furnace is turned on, vaporizing the P. The ratios of solvent to P are regulated by the temperature of tubes A_1 , A_2 and B . After a sufficient amount of mixture has settled on the wall of D , the liquid nitrogen is removed; the mixture is melted and flows into vessel C .

The sol thus obtained is polydisperse, probably due in part to the incompleteness of the mixing, and in part to the subsequent enlargement of the particles of the solid mixture on melting.

III. One part of a 50% solution of P in CS_2 is shaken vigorously with two parts of Turkey red oil. A milky white liquid forms,

which gives a stable emulsion on dilution with water (e.g., 2,000 parts).

After removal of the CS_2 , the solution releases a vapor which phosphoresces in the dark.

REFERENCES:

- I. T. Svedberg. Ber. dtsch. chem. Ges. 39, 1714 (1906); Herstellung kolloider Lösungen anorganischer Stoffe [Preparation of Colloidal Solutions of Inorganic Substances], 1909, p. 490.
- II. S. Roginsky and S. Schalkinoff. Kolloid-Z. 43, 67 (1927).
- III. German Patent. 401,049, Class 30 h. Group 2, August 25, 1924 (Inventor: F. Winkler).

Phosphine and Diphosphine

Phosphine (hydrogen phosphide) can be prepared by any one of the following methods:

I. action of potassium hydroxide on white phosphorus:

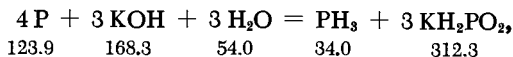

II. reaction of calcium phosphide with water:

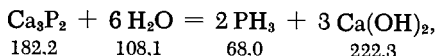

III. treatment of phosphonium iodide with potassium hydroxide

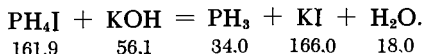

Pure PH_3 will be obtained only by method III, the other procedures yield a product contaminated to varying degrees with diphosphine, P_2H_4 and H_2 . Liquid P_2H_4 can be obtained at the same time.

I. PREPARATION FROM PHOSPHORUS AND POTASSIUM HYDROXIDE

A round-bottom, 3-liter flask K (see Fig. 192) is closed with a four-hole rubber stopper. The following are inserted through

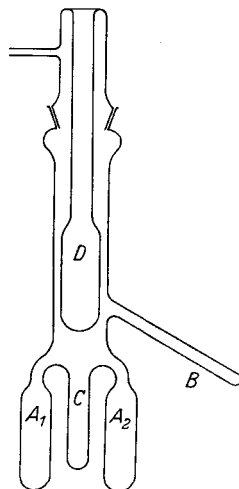

Fig. 191. Preparation of colloidal phosphorus A_1 , A_2) for water; B) for phosphorus; C) collecting tube for the colloidal phosphorus; D) cold finger.

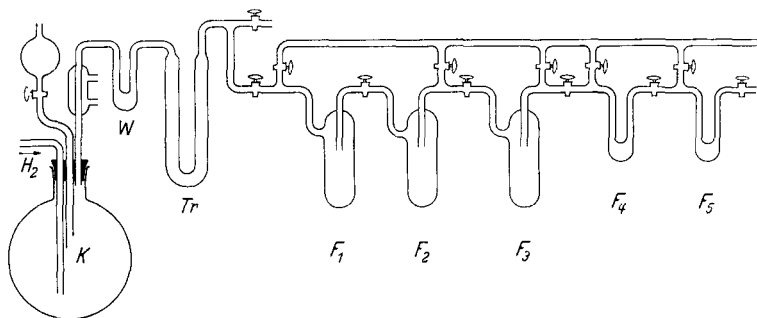

Fig. 192. Preparation of phosphine. *K*) reaction flask; *W*, $F_1 - F_6$) traps; *Tr*) drying tube.

the holes: a hydrogen inlet tube, a separatory funnel for potassium hydroxide, an outlet tube with a small reflux condenser, and a thermometer (not shown in Fig. 192). A series of vessels is attached to the outlet tube as follows: an ice-cooled trap *W*, two drying tubes *Tr*, filled with solid KOH, four gas traps $F_1 - F_4$, and two traps F_5 and F_6 for fractionation of the liquefied gases. Each trap is provided with a manometer for control of the fractionation (not shown in Fig. 195).

Electrolytic hydrogen is passed through traps cooled to -180°C and filled with activated charcoal, and thereafter it is freed of O_2 by contact with platinized asbestos catalyst.

Flask *K*, about half filled with white P and dilute potassium hydroxide, is heated to $+60^\circ\text{C}$ after the air has been displaced with H_2 . The evolving gases, containing a great deal of moisture and carried along by the rapid stream of H_2 , are partially freed of water in the reflux condenser, the trap *W*, and the drying tubes *Tr*. The remainder of the water vapor can only be removed by fractionation at low temperature. The traps are cooled to the following temperatures: F_1 : -90°C , F_2 : -100°C , F_3 and F_4 : -180°C . Traps F_1 and F_2 collect mainly P_2H_4 , while the PH_3 condenses in traps F_3 and F_4 . The PH_3 is carefully removed from these traps by fractional distillation rejecting everything but the lowest boiling fractions.

The contents of traps F_1 and F_2 are subjected to careful fractionation between -70°C and -100°C in order to obtain the P_2H_4 . The entrained water remains as a residue. When necessary, the material is quickly distilled at -50°C and the first cut is discarded; thus, any traces of PH_3 which may have formed are removed.

At the end of the run, the flask contents are allowed to cool in a stream of H_2 until complete solidification of the phosphorous occurs. The apparatus may only be disassembled after the PH_3 has been completely removed by the H_2 stream. The P must be washed with water until free of alkali to prevent further production of PH_3 .

II. PREPARATION FROM CALCIUM PHOSPHIDE

The apparatus shown in Fig. 195 is used. However, flask *K* has a capacity of only one liter. In order to decompose any P_2H_4 , as well as for drying, the product gas is passed through long tubes filled with soda-lime and P_2O_5 (instead of tubes *Tr*) and is condensed in two traps cooled with liquid nitrogen.

Commercial Ca_3P_2 is placed in flask *K* and the apparatus is completely filled with electrolytic H_2 (for purification of the latter, see p. 111). By means of the separatory funnel, dilute hydrochloric acid is then added drop-by-drop. The PH_3 , which collects in the trap, is carefully fractionated (once) and only the lowest boiling fraction is collected.

According to Baudler and Schmidt, very pure P_2H_4 (7-8 g. per run) can be obtained in the apparatus shown in Fig. 192a. To obtain larger quantities, condensates collected from several runs are combined prior to distillation.

Commercial Ca_3P_2 (as freshly prepared as may be obtained) is crushed to pea-size grains. The material is then sieved. The feed bulb *M* is loaded with 375 g. of Ca_3P_2 . Then all oxygen is displaced from the entire apparatus through repeated evacuation and filling with very pure nitrogen. Stopcock 2 is then closed and 500 ml. of O_2 -free water is added to flask *U* from dropping funnel *T*. Flask *U* is placed in a 60-65°C bath and small portions of the phosphide are added to it by rotating bulb *M* in the joint. The addition time should be no less than three hours. To prevent the distillation of the water from *U* into *M*, joint *L* is cooled with a stream of compressed air. The first gas fraction liberated passes through stopcock 1 and connection *a* into section III. It is collected under the safety bell which is immersed in water and is connected to a burner. The gas fraction is mixed with city (or natural) gas and is burned. Other gases, liberated in various sections of the apparatus, are also collected under the bell and similarly disposed of.

Stopcocks 4 and 8 are now closed and stopcock 2 is opened. The gas then passes through the reflux condenser and the KOH tube *Tr*₁, where the entrained water vapor is removed. The P_2H_4 (plus some water) condenses in trap *A*, which is cooled to -78°C. The noncondensable gases pass through *A*₁ and are either released to section III through stopcock 10 or, if it is desired to recover the PH_3 , are condensed in the -196°C trap *G*.

If the first run is to be followed by another one, flasks *U* and *M* are removed while the apparatus is flushed with a fast stream of N_2 . Identical fresh flasks, already charged with reagents and free of oxygen, are immediately substituted.

Before the start of the purification sequence, all remaining product gases are removed from the apparatus with a N_2 stream

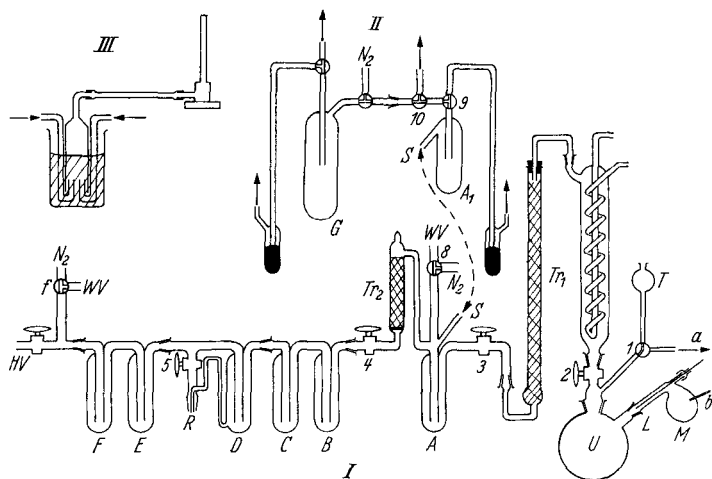

Fig. 192a. Preparation of diphosphine. I. Reaction and condensation section (up to stopcock 4), also used for distillation and transfer of product to storage vessels. II. section used for condensation of PH_3 (connected to section I at S). III. Safety apparatus for the decomposition of phosphines. A to G are condensation traps; M , 300-ml. flask; U , 1000-ml. flask; HV , high-vacuum connection; WV , aspirator connection; \rightarrow separate connections to section III.

and are burned in section III. Stopcock 3 is then closed. The three-way stopcocks at traps A_1 and G are turned so that they communicate only with their respective pressure release valves, but are otherwise closed. Trap A is then evacuated with an aspirator through stopcock 8 in order to remove dissolved PH_3 . Stopcock 4 is then opened and, at a pressure of 5 mm., a small forerun is removed into the liquid-nitrogen-cooled trap E . The main P_2H_4 fraction is then distilled from A (at -35°C) through the KOH tube Tr_2 and into B , which is cooled to -196°C . This treatment removes traces of water. Distillation of 7 g. of product takes 2-3 hours. Stopcock 4 is then closed. The temperature in B is raised to -60°C and the P_2H_4 is distilled at 10^{-3} mm. into trap C , cooled to -196°C . The procedure is repeated (this time from C into D). Only the middle fraction is collected in each case. Then stopcock 5 is closed and N_2 is introduced at f . The pure P_2H_4 is forced out through the siphon of trap 1 into a series of vessels, cooled to -78°C , and attached at R . The inlet of each of these vessels is narrowed to a capillary which may then be fused to form a seal. The series of vessels is connected to a mercury pressure

release valve, which can be disconnected from the system by a stopcock. In this way, no Hg transfers into the receivers during the high vacuum distillation.

At the end of this procedure, the system is reevacuated to 2-5 mm. with stopcock 5 initially closed. Nitrogen is then introduced until the pressure is almost equal to atmospheric. The series of receivers is then sealed off with a torch and is stored at -78°C . However, they remain connected to the pressure release valve. All these operations must be conducted, as far as possible, in the absence of light. All glassware must be precleaned in the usual way, after which it is repeatedly rinsed with 50% ammonia solution and with distilled water.

III. PREPARATION FROM PHOSPHONIUM IODIDE

A) WITH POTASSIUM HYDROXIDE

Pea-sized pieces of PH_4I are mixed with small pieces of glass in an Erlenmeyer flask. The flask is closed with a two-hole rubber stopper. A separatory funnel and a glass outlet tube are inserted in the holes. By adding dilute potassium hydroxide (about 1:2) in drops, a steady stream of very pure PH_3 is obtained without a rise in temperature. However, if the potassium hydroxide is not added slowly enough, then some P_2H_4 may also form. One liter of PH_3 is delivered by 7.3 g. PH_4I .

B) WITH WATER CONTAINING ETHER

About 10 g. of PH_4I is placed in an Erlenmeyer flask. The flask is closed with a two-hole rubber stopper. A separatory funnel and a glass outlet tube are inserted through the holes. First, ordinary ether is added to the flask from the separatory funnel. Its water content is sufficient to initiate evolution of PH_3 . As soon as the moisture content of the ether decreases and the gas stream becomes slower, one or more drops of water are added from the separatory funnel, thus restarting gas evolution. This lasts for about eight hours.

A small Kipp generator may also be used for the reaction.

The PH_3 obtained via this method may be contaminated with ether vapor.

SYNONYM:

(Gaseous) hydrogen phosphide.

PROPERTIES (PH_3):

Colorless, very poisonous gas with a peculiar, acetylenelike odor. (The odor of ordinary acetylene is due to the presence of

small amounts of PH_3 .) Ignites in air at about 150°C , particularly when very dry. Ignites spontaneously at room temperatures only if contaminated with P_2H_4 during the preparation.

M.p. -132.5°C , b.p. -87°C .

Only slightly soluble in water: at room temperature one volume of water absorbs 0.112 volume of PH_3 .

PROPERTIES (P_2H_4):

Colorless liquid. The vapor ignites spontaneously in air.

M.p. -99°C , b.p. $+51.7^\circ\text{C}$. Decomposes on rough surfaces and in the presence of traces of acid (particularly in light) into PH_3 and amorphous, yellow "solid hydrogen phosphide," which must be considered a "mixed polymerizate."

REFERENCES:

- I. H. Rose. Pogg. Ann. 6, 199 (1826); 46, 633 (1839); P. Royen and K. Hill. Z. anorg. allg. Chem. 229, 98 (1936).
- II. P. Royen and K. Hill. Z. anorg. allg. Chem. 229, 115 (1936); M. Baudler and L. Schmidt. Z. anorg. allg. Chem. 289, 219 (1957).
- III. a) A. W. von Hofmann. Ber. dtsch. chem. Ges. 4, 202 (1871).
b) J. Messinger and C. Engels. Ber. dtsch. chem. Ges. 21, 326 (1888).

Sodium Dihydrogenphosphide



Sodium dihydrogenphosphide is prepared by addition of PH_3 to a blue solution of Na in liquid NH_3 (Royen method):

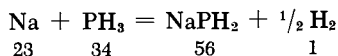

Approximately 25 ml. of liquid NH_3 , dried over Na and fractionated at least once, is condensed on 0.5 g. of Na (sealed in a glass ampoule; see Fig. 265). After breaking the ampoule and dissolving the Na, purified PH_3 is introduced in a stream of N_2 into the blue solution until the blue color disappears. The addition is continued for some time. The apparatus is protected from the atmosphere by means of a pressure release valve, according to the method of Zintl, Goubeau and Dullenkopf (see p. 56). The NH_3 is distilled off through this valve at the end of the reaction. After reaching room temperature, the molten diammoniate $\text{NaPH}_2 \cdot 2\text{NH}_3$

remains behind as a yellow liquid, which loses NH_3 in vacuum, forming a white salt. The yield, based on the Na used, is quantitative.

PROPERTIES:

White crystalline powder, which splits off PH_3 on heating above 60°C : $2\text{NaPH}_2 = \text{Na}_2\text{PH} + \text{PH}_3$. At 95°C , this transformation is complete. The Na_2PH is yellow. In water, NaPH_2 decomposes to PH_3 and NaOH .

REFERENCES:

- A. Joannis. *Compt. Rend. Hebd. Séances Acad. Sci.* 119, 557 (1894);
 C. Legoux. *Bull. soc. chim.* [5] 7, 546 (1940); *Ann. Chim.* 17,
 100 (1942);
 P. Royen. Private communication.

Phosponium iodide

PH_4I

Phosponium iodide is prepared in the Baeyer method (I) by decomposition of phosphorus iodide with water. The mechanism of the transformation is not entirely clear; the reaction proceeds roughly according to the equation:

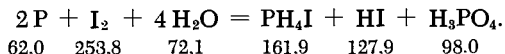

After Baeyer's method of preparation is presented, that of Hofmann (II) will be given, because, according to the latter author, it is advantageous to work with large quantities.

I. A fairly large tubular retort is closed off with a stopper. An inlet tube for dry CO_2 and a separatory funnel are inserted into the stopper. White P is then placed in the retort and dissolved in dry CS_2 . Then 175 g. of I is added in small portions while the vessel is efficiently cooled. After the reaction is complete, the CS_2 is distilled off. The last traces of CS_2 are removed in a stream of dry CO_2 , with gentle heating of the retort. On cooling, the condenser is replaced with a long, large diameter, thin-wall glass tube. The free end of the tube is connected to a gas tube, which in turn, ends in a water-filled flask, without, however, touching the water surface. By means of a separatory funnel, 50 ml. of water is added in small portions to the phosphorus iodide. On each addition, a vigorous reaction takes place, producing HI.

The latter is absorbed by the water in the receiver, while PH_4I sublimes onto the wall of the retort and into the large glass tube. After all the water has been added, the retort is heated, at first gently and then to a dull glow, so that the PH_4I is transferred completely into the glass tube. After cooling, the tube is separated from the retort, one end is closed with a stopper, and the PH_4I adhering to the wall is removed with a long wire. The yield is about 120 g.

II. In the Hofmann method, which is useful for larger quantities, 400 g. of P is dissolved in an equal weight of CS_2 in a retort of at least one liter capacity. It is then reacted with 680 g. of I. The CS_2 is then distilled off over a period of several hours, using a water bath. The decomposition uses 240 g. of water, added in very small portions, with gentle heating and in a constant stream of dry CO_2 . The HI produced is trapped in water in two wash bottles connected to a glass tube 1.3 to 1.5 m. long and 3 to 4 cm. in diameter. The wash bottles are very large to prevent backup of water into the retort. Dilute hydriodic acid is added to the first flask for better absorption. To avoid explosion of the hot PH_4I vapor, the apparatus should be protected from air. After the reaction with water is complete, the retort is heated, at first gently and then, at the end of the sublimation, to a dull glow. The sublimation takes 8 to 9 hours. Hydriodic acid is obtained as a byproduct. This, however, is somewhat contaminated with H_3PO_4 .

PROPERTIES:

Large water-clear crystals, with a diamond glitter. Tetragonal crystal system. Sublimes at room temperature. Instantaneous decomposition with water, accompanied by formation of PH_3 (see p. 529) and HI. Must therefore be stored out of contact with atmospheric moisture.

B.p. 80°C .

REFERENCES:

- I. A. von Baeyer. Liebigs Ann. Chem. 155, 269 (1870).
- II. A. W. von Hofmann. Ber. dtsh. chem. Ges. 6, 286 (1873).

Thiophosphoryl Chloride



Thiophosphoryl chloride is prepared by addition of S to PCl_3 :

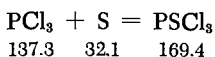

According to German Pat. 675,303 (I), the reaction can be carried out by passing PCl_3 vapor over S at 160°C . Alternately, in the method of Knotz (II) it is prepared by reacting PCl_3 with S, using AlCl_3 as a catalyst.

I. PREPARATION ACCORDING TO GERMAN PAT. 675,303

An oil bath is used to heat 250 g. of S at a bath temperature of 195°C . The internal temperature of the reaction vessel is then about 160°C . In another vessel, 500 ml. of PCl_3 is heated to vigorous boiling. The vapors are passed over the molten S, which is vigorously stirred. The PSCl_3 product and the unreacted PCl_3 are condensed in a reflux condenser and flow back into the PCl_3 vessel. After about six hours the reaction is stopped and the PSCl_3 removed by simple fractionation. Very pure PSCl_3 (about 205 g.) is obtained between 118 and 122°C . The unreacted PCl_3 is recovered and, together with the unreacted S, can be used in a new run.

According to unpublished data of R. Klement, the following procedure can be carried out with simple equipment available in any laboratory. The S is melted in a round-bottom, ground-joint flask placed in an oil bath. The flask carries a ground-glass adapter fused to a downward-tilted condenser. The condenser is connected through an adapter to a receiver, which is protected from the air with a CaCl_2 tube. The ground-glass adapter on the flask is also provided with an inlet tube dipping into the molten S. This tube is attached to a Claisen flask, provided with an insert thermometer. The PCl_3 is brought to the boil in the Claisen flask and its vapor is passed through the molten S in a moderately fast stream of dry CO_2 from a steel cylinder. After boiling off the PCl_3 in the Claisen flask, the liquid collected in the receiver is transferred into the Claisen flask to gradually concentrate the PSCl_3 . By controlling the boiling temperature, it is possible to avoid passage of the PSCl_3 product over the S. This means a saving of time without limiting the yield. From 100 g. of S and 200 g. of PCl_3 , about 80 g. of PSCl_3 can be obtained within 6 hours. This can then be purified by fractionation. One disadvantage of this procedure is that it requires constant supervision.

II. PREPARATION BY THE KNOTZ METHOD

A round-bottom or an Erlenmeyer flask with an Anschütz adapter and a reflux condenser, the end of which is closed off with a CaCl_2 tube, is used. The flask is filled with 100 g. of PCl_3 and 24 g. of powdered S and heated to boiling on a steam bath. As soon as the mixture is boiling vigorously, 3 to 5 g. of finely powdered anhydrous AlCl_3 is added. The sulfur dissolves quickly

with vigorous to violent boiling. The flask must sometimes be somewhat cooled. Toward the end of the reaction, which occurs within 5 to 10 minutes, the liquid becomes orange-yellow. At that point the boiling ceases, indicating that all of the PCl_3 is transformed into PSCl_3 .

The cooled liquid is now poured into a large separatory funnel, a large amount of water is added, and the funnel is carefully shaken to avoid too heavy an emulsion. This dissolves the AlCl_3 , PCl_5 , H_3PO_3 and HCl , producing an immediate decolorization of the product. The PSCl_3 settles out as the bottom. It is separated, dried with CaCl_2 and distilled.

The yield is as high as 120 g. (97%).

SYNONYM:

Phosphorus sulfochloride.

PROPERTIES:

Colorless, mobile liquid; fumes in air; sharp odor, not disagreeable when diluted; lachrymator. With water, decomposes slowly in the cold, quickly when heated, to give HCl , H_2S and H_3PO_4 . On heating with sodium hydroxide, $\text{Na}_3\text{PO}_3\text{S}$ is formed (see p. 569). Miscible with CS_2 .

M.p. -35°C , b.p. 125°C (corr.); d 1.668.

REFERENCES:

- I. German Patent 675,303, Class 12 i, Group 31, May 5, 1929 (Inventor: G. Schrader).
- II. F. Knotz. *Österr. Chemiker-Z.* 50, 128 (1949).

Phosphoryl (V) Bromide

POBr_3

According to Hönigschmid and Hirschbold-Wittner, the reaction of PBr_5 with P_2O_5 , proposed by Berger, is the best procedure for the preparation of POBr_3 :

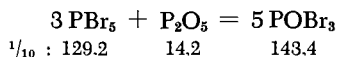

A round-bottom flask, joined to a reflux condenser with a ground joint, is the reactor. A mixture of PBr_5 and P_2O_5 (mole ratio 5 : 1), with a small excess of the latter [e.g., 250 g. of PBr_5 and

20 g. of P_2O_5 —preferably from a new package] is heated in an oil bath, with the temperature gradually increased to $150^\circ C$. Care must be taken to prevent escape of the bromine. The reaction is complete after five hours. Then 10 g. of Br_2 and a corresponding quantity of P_2O_5 are added to the molten product. The mixture is refluxed for seven hours at $150^\circ C$. This oxidizes the intermediate PBr_3 to PBr_5 and transforms the latter into $POBr_3$. The final product is distilled at 12 mm. A tube containing $NaOH$ must be inserted between the aspirator and the distillation apparatus. The first cut contains Br_2 and some PBr_3 . The completely colorless $POBr_3$ is obtained almost quantitatively. It is best to cool the receiver with an ice-salt mixture. The yield is 200 g. (73%, based on the PBr_5 used).

The traces of PBr_3 can only be removed by fractionating the $POBr_3$ six times in high vacuum.

PROPERTIES:

Very sensitive to elevated temperature, at which it decomposes with yellowing. For this reason it should never be melted with a flame, but only with hot water.

Large, flaky crystals. M.p. $55^\circ C$, b.p. $193^\circ C$; d 2.82.

Decomposes slowly in water, forming H_3PO_4 and HBr . Soluble in ether.

REFERENCES:

- O. Hönigschmid and F. Hirschbold-Wittner. *Z. anorg. allg. Chem.* 243, 355 (1940).
 E. Berger. *Compt. Rend. Hebd. Séances Acad. Sci.* 146, 400 (1908).

Thiophosphoryl (V) Bromide

$PSBr_3$

Thiophosphoryl bromide can be obtained by the reaction of phosphorus pentasulfide with phosphorus pentabromide:

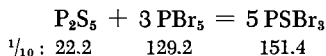

The reaction vessel is a distillation flask provided with a P_2O_5 drying tube. The flask is charged with 31 g. of dry, red P and cooled in a bath. Then 400 g. of Br is added, followed by 100 g. of P_2S_5 . The mixture is then heated for two hours on a water bath and finally with an open flame, until completely

liquid. The PSBr_3 is distilled at 25 mm. and the fraction distilling between 120 and 130°C is collected. The yield, based on P, is 80-85%.

To purify the crude product, it is added to twice its volume of distilled water plus a few drops of a 10% solution of KBr. The mixture is heated on a water bath until liquid. A slow stream of compressed air is bubbled through the mixture for a few minutes, the water is decanted, and any sulfur which might have settled out is removed. The yellow layer of PSBr_3 is allowed to crystallize, the water traces are removed, and the compound is dried over P_2O_5 . The yield of pure PSBr_3 is 60%.

PROPERTIES:

Dissolved in PBr_3 , it crystallizes in yellow, regular octahedra. The melt hardens to fibers.

M.p. 38°C , b.p. $212-215^\circ\text{C}$ (dec.), $125-130^\circ\text{C}$ (25 mm.); d (17°C) 2.85.

Readily soluble in ether, CS_2 , PCl_3 and PBr_3 . Fairly stable in the presence of water, and even forms a monohydrate with it [m.p. 35°C , d (18°C) 2.794]. The hydrate decomposes at the melting point into its constituents; the same happens on dissolving in CS_2 . The water may be removed with CaCl_2 .

REFERENCE:

H. S. Booth and C. A. Seabright in: W. C. Fernelius, *Inorganic Syntheses*, Vol. 2, p. 153, New York-London, 1946.

Diphosphoric Acid Tetrachloride



According to Geuther and Michaelis, $\text{P}_2\text{O}_3\text{Cl}_4$, together with other phosphorus oxychlorides, can be obtained by the reaction of PCl_3 with N_2O_4 . Klement et al. have improved this procedure and have confirmed, among other things, the simultaneous formation of tetraphosphoryl decachloride $\text{P}_4\text{O}_4\text{Cl}_{10}$. Because of the complexity of the reaction, no stoichiometric equation can be written (I). The procedure of Huntly, based on heating a mixture of POCl_3 and P_4O_{10} was improved by Grunze (II).

I. Nitrogen oxides (N_2O_3 , or $\text{NO} + \text{NO}_2$) are produced in flask *a* (see Fig. 196) over a period of about four hours by dropping about 550 ml. of 68% H_2SO_4 onto 500 g. of ice-cooled crystalline NaNO_2 (Hofmann and Zedtwitz procedure). The jacket of reflux condenser *b* is filled with lukewarm water. Sufficient dry O_2 is

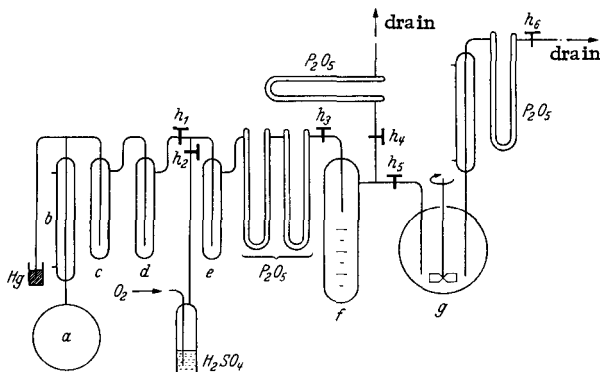

Fig. 193. Preparation of $P_2O_3Cl_4$ and $P_4O_4Cl_{10}$: *a*) prereaction flask; *b*) reflux condenser; *c*) empty trap; *d*) trap filled with glass wool; *e*) mixing trap; *f*) measuring trap; *g*) reaction flask; h_1 – h_6) stopcocks.

mixed with the nitrogen oxides to assure that all N_2O_3 is converted to N_2O_4 . The O_2 is mixed at stopcock h_2 . The gaseous mixture is condensed in mixing trap *f*, cooled with liquid nitrogen. With stopcocks h_1 and h_4 closed and stopcocks h_2 , h_3 , h_5 and h_6 open the N_2O_4 (about 200 g.) is distilled from *f* by heating the latter to $22^\circ C$. It is collected in 1000 g. of freshly distilled PCl_3 in flask *g*. The addition proceeds with vigorous stirring. At the same time, a very slow stream of O_2 is passed through. For greater safety, an empty trap is inserted between flask *g* and stopcock h_5 . During the reaction (10–11 hours), flask *g* must be well cooled to -25 to $-21^\circ C$ (by means of a trichloroethylene–Dry Ice bath), because this influences the yield. The dark red liquid is allowed to stand overnight in flask *g*, with stopcock h_5 closed and stopcock h_6 open. By heating flask *g* in a water bath to no more than $30^\circ C$, most of the gaseous product (particularly $NOCl$) is driven off. The mixture must be stirred during the distillation. The yellow-red liquid is then placed in a distilling flask and distilled at 11 mm. Nitrogen oxides and $NOCl$ distill first, then $POCl_3$ (about 850 g.). The receiver must be cooled with ice-salt mixture. It is best to insert several liquid-nitrogen-cooled traps between the receiver and the pump. The light-brown residue is distilled at 10^{-3} mm., with the flask heated on an oil bath. The bath temperature is slowly raised to $120^\circ C$. Residual $POCl_3$ distills first; then a colorless liquid follows from $35^\circ C$ on. A dark mass (a few grams) remains in the flask.

The distillate is fractionated very slowly at 10^{-3} mm. and the fractions boiling between 35 and $50^\circ C$ (I), between 50 and $60^\circ C$ (II)

and between 60 and 70°C (III) are collected separately. Fraction II is divided into lower boiling (*a*) and higher boiling portions (*b*). Portion *a* is added to I and portion *b* to III. Fraction I is then refractionated, and almost completely pure $P_2O_3Cl_4$ (90-100 g.) is obtained between 36 and 38°C. By fractionation of III, almost pure $P_4O_4Cl_{10}$ is obtained between 63 and 68°C (about 70 g.). To obtain very pure material, the crude must be refractionated. The high-vacuum boiling temperatures given below depend on the dimensions of the apparatus and the rate of the condensation. At 10-12 mm., $P_2O_3Cl_4$ boils at 90-92°C and $P_4O_4Cl_{10}$ at 137-138°C. Pure $P_4O_4Cl_{10}$ solidifies even in the condenser (colorless crystals, m.p. 38°C). It is therefore best to fill the condenser with water at 45°C.

II. A mixture of $POCl_3$ and P_4O_{10} (mole ratio 8:1) is heated in a combustion tube for 48 hours at 200°C. The $POCl_3$ is distilled from the product at 12 mm. (the flask is placed in hot water). The $P_2O_3Cl_4$ is then quantitatively distilled off at 12 mm., with the flask placed in a sand bath at 250°C. A repeat distillation at even lower pressure, using a boiling water bath, yields completely pure $P_2O_3Cl_4$. The yield is about 30%.

SYNONYMS:

Pyrophosphoryl chloride, dichlorylphosphoric acid anhydride.

PROPERTIES:

Formula weight 251.8. Colorless liquid. Fumes only after standing for some time in air. However, reacts vigorously with water. Dichlorylphosphoric acid HPO_2Cl_2 can be obtained by careful reaction with water below -30°C (Grunze). Soluble in PCl_3 , $POCl_3$, $SOCl_2$, C_6H_6 and other hydrocarbons, ether and nitrobenzene.

M.p. -16.5°C, b.p. (in the vacuum of a mercury diffusion pump) 47°C. d_4^{15} 1.82.

REFERENCES:

- I. A. Geuther and H. Michaelis. Ber. dtsh. chem. Ges. 4, 766 (1871); R. Klement and K. H. Wolf. Z. anorg. allg. Chem. 282, 149 (1955); R. Klement, O. Koch and K. H. Wolf. Naturwiss. 41, 139 (1955); L. Benek. Ph.D. thesis, Universitat München, 1956; E. Rother, thesis, Universitat München, 1956; thesis, Universität München, 1959; K. A. Hofmann and A. Zedtwitz. Ber. dtsh. chem Ges. 42 2032 (1909).
- II. O. N. Huntly. J. Chem. Soc. (London) 59, 202 (1891); H. Grunze. Z. anorg. allg. Chem. 296, 63 (1958); 298, 152 (1959).

Diphosphorus Tetraiodide



Diphosphorus tetraiodide is formed exothermically from the elements mixed in the stoichiometric ratio. The reaction can be moderated with CS_2 , which also serves as a solvent:

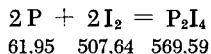

According to the procedure of Germann and Traxler, improved by Baudler, a solution of 6.2 g. of white P in 100 ml. of CS_2 (carefully purified and distilled over P_2O_5) is poured through a fritted glass filter into a ground joint flask. This treatment removes small amounts of suspended contaminants. A filtered solution of 50.77 g. of sublimed iodine in 500 ml. of pure CS_2 is added in portions with shaking, making certain that the flask is opened for a short period only. Before adding a fresh portion, wait until the initially dark red-brown mixture becomes transparent and bright red. The 50-ml. CS_2 rinse of the I_2 container is also added. The mixture is then allowed to stand in the dark in a well stoppered flask for twelve hours to complete the reaction. The clear orange-red solution is then poured into a suction flask which is connected through a CaCl_2 tube to an aspirator. It is then concentrated. Care should be taken that this operation does not take too long and that the solvent is kept boiling gently all the time. The rate of boiling is controlled through the steam bath temperature. After a short time, crystals of P_2I_4 are deposited on the wall and are washed down by swirling the liquid. When the solution is concentrated to 60-80 ml., the crystals are quickly suction-filtered on a fritted glass filter and gently crushed with a glass rod. The filter with contents is immediately placed in a vacuum desiccator and evacuated to 20 mm. while protecting the product from moisture with a CaCl_2 drying tube. The crystals are then dry enough to be easily pulverized without smearing. Longer drying is harmful as it favors slight decomposition of the P_2I_4 . Since considerable decomposition takes place even after a short time in a desiccator over CaCl_2 , the product is stored in sealed ampoules or in carefully closed bottles with ground glass stoppers. The yield is 37-41 g., or 65-75% of theoretical. With careful operation, the mother liquor can be reused for a new batch.

SYNONYM:

Phosphorus diiodide.

PROPERTIES:

Thin, red prisms. M.p. 125.5°C Decomposes with water to H_3PO_3 , PH and HI.

REFERENCES:

- A. Michaelis and M. Pitsch. Liebigs Ann. Chem. 310, 66 (1900).
 F. E. E. Germann and R. N. Traxler. J. Amer. Chem. Soc. 49, 307 (1929).
 M. Baudler. Z. Naturforschg. 13b, 266 (1958).

Phosphorus (III) Iodide

Phosphorus (III) iodide can be prepared either from red or white P, dissolved in CS_2 , by reaction with a solution of I_2 in CS_2 :

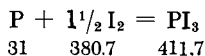

As Germann and Traxler have established, very carefully purified CS_2 must be used. Impure CS_2 , containing S, causes the formation of sulfurated PI_3 , the presence of which lowers the melting point.

Purification of the reagents: a) Iodine is purified by grinding with KI and subliming. b) Red phosphorus should have been exposed to the air as little as possible. It is washed with freshly purified CS_2 in order to remove white P. Commercial white phosphorus is usually pure enough. c) Very pure carbon disulfide is shaken in a glass-stoppered flask with portions of pure Hg until the free S is removed. This requires long contact with several portions of Hg. The treatment should be continued until only a slight discoloration is evident on the bright surface of freshly added mercury after several minutes of contact with the CS_2 . The latter is then filtered, distilled and used immediately.

I. PREPARATION WITH RED PHOSPHORUS

The required amount of I_2 is dissolved in CS_2 , and excess red P is added. After the disappearance of free I_2 , the dark-red, opaque solution is filtered from unreacted P and the CS_2 is distilled off on a sand bath until crystals appear. The solution is then allowed to cool, the supernatant liquid is decanted, and the remaining crystals are gently warmed.

II. PREPARATION WITH WHITE PHOSPHORUS

Two solutions in CS_2 are prepared. One contains 1 g. of white P and the other 12.27 g. of I_2 . The solutions are mixed without loss, and the mixture is processed further as under I.

PROPERTIES:

Dark red, columnar crystals. M.p. 61°C . Quick decomposition in moist air and must therefore be stored over CaCl_2 .

REFERENCE:

F. E. E. Germann and R. N. Traxler. J. Amer. Chem. Soc. 49, 307 (1927).

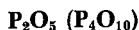
Phosphorus (V) Oxide

Purification of the commercial product. Ordinary commercial P_2O_5 usually contains lower oxides of P, especially P_2O_3 , and sometimes also white P. When P_2O_5 is used as a drying agent, these impurities sometimes exert a harmful influence because of their reducing action. To test for the lower oxides, P_2O_5 is dissolved in water, forming a solution which easily reduces a 10% AgNO_3 solution, and a Hg(II) salt solution on boiling. If lower P oxides are present a distinct odor of PH_3 is given off when the aqueous solution is evaporated and then moderately warmed. To prepare pure P_2O_5 , the commercial product is sublimed in a stream of well-dried oxygen at bright red heat, according to Finch and Peto, and also Whitaker. A T-shaped iron tube is used for this purpose (see Fig. 194); it is connected to a glass tube. The apparatus, particularly the iron tube, must be thoroughly cleaned and dried. The commercial product to be sublimed is gradually added from *a* and trapped in collecting bulb *b*. From 200 g. of impure P_2O_5 , about 70 g. of pure P_2O_5 can be obtained in two hours (cf. also Part I, p. 81).

Modifications of phosphorous pentoxide. Phosphorus pentoxide forms three solid modifications, of which the metastable M form is the ordinary commercial P_2O_5 . This modification crystallizes as rhombohedra with a molecular lattice (P_4O_{10}) and sublimes readily at 250°C and 10 mm. (Glixelli and Boratynski). Above 260°C and even more quickly above 500°C , form M changes into form R. The latter crystallizes in a three-dimensional atomic lattice of PO_4 tetrahedra and is less volatile. A form S, which

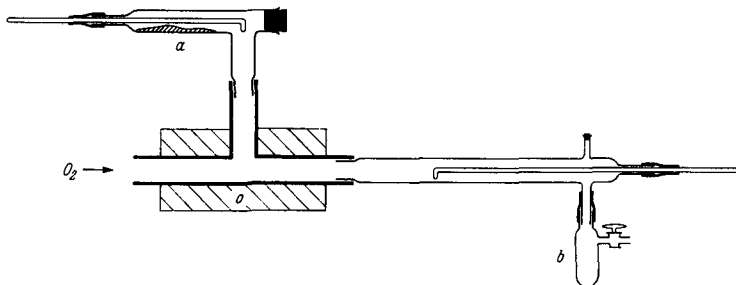

Fig. 194. Purification of P_2O_5 by sublimation. *a*) Starting material; *b*) collecting bulb for purified material; *o*) electric furnace.

crystallizes in a layer lattice, and a few vitreous forms are also known (De Decker and McGillavry; Hill, Faust and Hendricks).

To prepare the stable modification, crystals of the M modification, obtained by sublimation in a stream of dry O_2 at about $320^\circ C$, are placed under a stream of dry O_2 in a Vycor tube 2×23 cm. The latter is fused shut after evacuation. After heating for five days at $500-530^\circ C$ in a horizontal position, the section of the tube containing the best crystals is heated for 2.5 hours at $350-400^\circ C$, while the other end remains at room temperature.

SYNONYM:

Tetraphosphorus decaoxide.

PROPERTIES:

Modification M is brittle; R and S form hard crystals, which deliquesce after a few hours in the air and undergo considerable swelling in water. The density of R is 2.72, that of M 2.30 (calculated from x-ray data).

REFERENCES:

- G. I. Finch and R. H. K. Peto. *J. Chem. Soc. (London)* 121, 692 (1922).
 H. Whitaker. *J. Chem. Soc. (London)* 127, 2219 (1925).
 S. Glixelli and K. Boratynski. *Z. anorg. allg. Chem.* 235, 225 (1938).
 H. C. J. de Decker and C. H. McGillavry. *Rec. Trav. Chim. Pays-Bas* 60, 153 and 413 (1941); *Nature* 164, 448 (1949).
 W. L. Hill, G. T. Faust and S. B. Hendricks. *J. Amer. Chem. Soc.* 65, 794 (1943).

Orthophosphoric Acid



CRYSTALLINE ORTHOPHOSPHORIC ACID

According to Simon and Schulze, very pure, crystalline H_3PO_4 may be prepared by evaporating 83% phosphoric acid in high vacuum to crystallization.

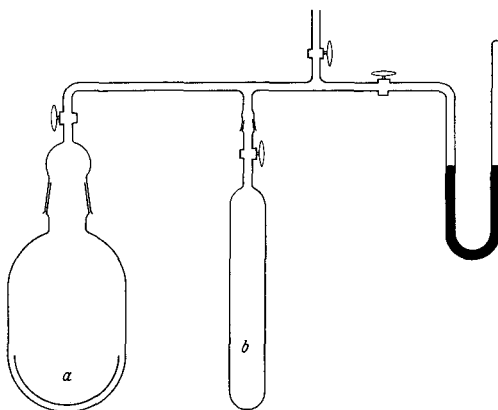

Fig. 195. Evaporation of phosphoric acid in vacuum. *A*) Pt-Au alloy dish; *b*) condensation trap.

A platinum-gold alloy dish is fastened by melting in a glass flask (see Fig. 195). The dish is filled with 83% phosphoric acid, which is then concentrated to 99% at 80°C and 1 mm. The procedure takes one week. The dehydration is continuously checked by weighing the liquid-nitrogen-cooled trap. The highly concentrated acid obtained is introduced into fritted glass container *A* of the crystallization apparatus (see Fig. 196), which is then evacuated. By sharp cooling of the lower section of *A* with Dry Ice-alcohol mixture, a seed crystal is produced. The apparatus is then immediately transferred to a thermostat held at 38°C. The temperature is then gradually lowered until the seed crystal continues to grow slowly. Usually the temperature is not allowed to drop below 35°C. In two to three days, a large part of the acid solidifies to a loose, crystalline network. Then dried air is introduced through the fritted glass vessel *F*₁, which is filled with pumice chips and P_2O_5 . The liquid part of the acid which collects in *B* is removed by suction through *C*. The separation of the crystals from

the liquid is greatly facilitated by the behavior of H_3PO_4 crystals, which are not wetted by the liquid acid. After a second evacuation the crystals are melted and the crystallization is repeated at a temperature about 0.5° higher.

SYNONYM:

Phosphoric acid.

PROPERTIES

The crystals remaining after the second suction drying yield no precipitate of $\text{Zn}_2\text{P}_2\text{O}_7$ when reacted with ZnSO_4 in an acetic acid solution. They contain 99.6% to 100.1% H_3PO_4 . M.p. 41.5°C ; $d(18^\circ\text{C})$ 1.834.

REFERENCE:

A. Simon and G. Schulze. *Z. anorg. allg. Chem.* 242, 322 (1939).

Sodium Dihydrogen Phosphate



According to Beans and Kiehl, NaH_2PO_4 can be obtained as the dihydrate by crystallization from cold aqueous alcoholic solution.

Very pure NaH_2PO_4 is recrystallized three times from a mixture of equal volumes of distilled water and 95% alcohol. The crystallization proceeds in an ice bath. The crystals are suction-dried, washed three times with absolute alcohol and three times with absolute ether, and allowed to stand for a short time in the air to evaporate the ether. The salt must be stored in fused vessels or water is lost because of the high dissociation pressure.

PROPERTIES:

Formula weight 156.02. Rhombic-disphenoidal crystals. d 1.915. Begins to melt at 60°C .

REFERENCE:

H. T. Beans and S. J. Kiehl. *J. Amer. Chem. Soc.* 49, 1878 (1927).

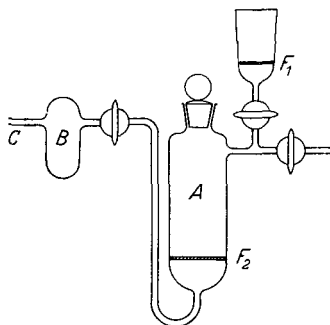
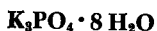

Fig. 196. Preparation of crystalline orthophosphoric acid. A) Fritted glass container; B) collecting vessel for the mother liquor; C) suction connection; F_1 , F_2) fritted glass disks.

Potassium Phosphate

Pure K_3PO_4 cannot be obtained by recrystallization. According to Simon and Schulze, the octahydrate can be prepared in a sufficiently pure form, using a procedure reported by Jänecke.

A solution of 300 g. of C. P. K_3PO_4 in 180 ml. of water is prepared. After bubbling ammonia through this solution, for 2-3 hours, potassium phosphate octahydrate precipitates in large amounts. The salt is suction-dried in well-dried air.

PROPERTIES:

Formula weight 356.4. Flat, rectangular flakes. M.p. 45.1°C . Solubility in water (0°C): 43.7; (25°C) 50.8; (45.1°C) 59.7% K_3PO_4 .

REFERENCES:

- E. Jänecke. *Z. phys. Chem.* 127, 75 (1927);
A. Simon and G. Schulze. *Z. anorg. allg. Chem.* 242, 331 (1939).

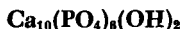
Hydroxyapatite

Crystalline hydroxyapatite is formed on very slow precipitation from extremely dilute solutions:

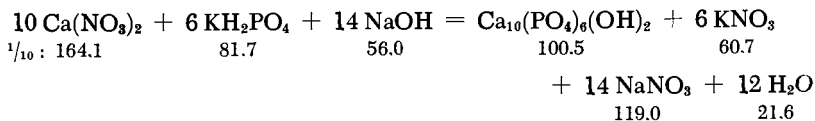

Hayek, Müllner and Koller (II) obtained well-formed single crystals of hydroxyapatite as needles up to 0.03 mm. long by digesting calcium phosphate (or $\text{CaHPO}_4 \cdot 2\text{H}_2\text{O}$) with CO_2 -free, very pure water. Single crystals up to $\frac{1}{2}$ mm. long were obtained hydrothermally in sodium hydroxide (Hayek, Böhrer, Lechleitner and Petter).

I. Two liters of water are kept for a week on a hot plate at about 95°C , with continuous replacement of the evaporated water. Every day five drops each of the following solutions are added: a) 16.9 g. of $\text{Ca}(\text{NO}_3)_2$ in one liter of CO_2 -free water, b) 5.84 g. of KH_2PO_4 (Sörensen method for enzyme studies) in one liter of CO_2 -free

water. With the help of a few drops of CO_2 -free 0.1N NaOH, the solution is kept neutral to bromthymol blue, and some seed crystals of hydroxyapatite, precipitated from a concentrated solution, are added. After four days, crystals begin to separate. These are just visible to the naked eye and grow somewhat larger during the next three days. They are filtered and washed with water.

II. The precipitation product from mixing stoichiometric quantities of solutions of Na_3PO_4 and $\text{Ca}(\text{NO}_2)_2$ or that from mixtures of $\text{Ca}(\text{OH})_2$ and H_3PO_4 (or $\text{CaHPO}_4 \cdot 2\text{H}_2\text{O}$) is boiled about 20 times, each time for an hour, with CO_2 -free, pure water. The water is renewed each time. The weight ratio of the sediment to the water should not exceed 1:30. If $\text{CaHPO}_4 \cdot 2\text{H}_2\text{O}$ is used, it is recommended that a larger amount of water (about 100:1) be used for the first heating.

PROPERTIES:

Hexagonal needles and druses. Only slightly soluble in water.

REFERENCES:

- I. W. Rathje. Ber. dtsh. chem. Ges. 74, 347 (1941).
- II. E. Hayek, F. Müllner and K. Koller. Monatsh. Chem. 82, 959 (1951);
E. Hayek, W. Böhler, J. Lechleitner and H. Petter. Z. anorg. allg. Chem. 295, 241 (1958).

Condensed Orthophosphates

DIPHOSPHORIC ACID, $\text{H}_4\text{P}_2\text{O}_7$

Crystalline diphosphoric acid. The reaction discovered by Geuther:

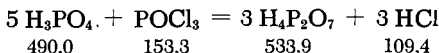

is recommended by Partington and Wallsom for obtaining very pure $\text{H}_4\text{P}_2\text{O}_7$.

A mixture of H_3PO_4 and POCl_3 is carefully evaporated in a platinum dish at 180°C . The residue is allowed to crystallize in a cooled desiccator.

SYNONYM:

Pyrophosphoric acid.

PROPERTIES:

Vitreous crystals. M.p. 61°C . Soluble without change in ice water; gradually forms orthophosphoric acid at higher temperature.

REFERENCES:

- A. Geuther. J. prakt. Chem. [2] 8, 359 (1874).
 J. R. Partington and H. E. Wallisom. Chem. News 136, 97 (1928),
 as reported by Chem. Zentr. 1928, I, 1936.

PENTASODIUM TRIPHOSPHATE, $\text{Na}_5\text{P}_3\text{O}_{10}$

Pentasodium triphosphate is prepared by annealing a quenched melt of solid $(\text{NaPO}_3)_n$ (Graham's salt) and $\text{Na}_4\text{P}_2\text{O}_7$ between 300 and 500°C (Huber):

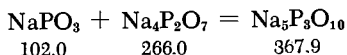

The hexahydrate crystallizes from an aqueous solution of the reaction products (method I).

According to Thilo and Rätz (method II), the salt can be quantitatively prepared in solution by cleavage of sodium trimetaphosphate (see p. 552) with the equivalent amount of alkali according to the equation

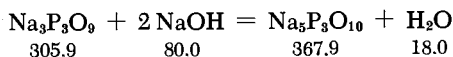

I. An intimate mixture of 102 g. of $(\text{NaPO}_3)_n$ and 266 g. of $\text{Na}_4\text{P}_2\text{O}_7$ is melted. The melt is quenched, pulverized, and pressed into tablets of 2-3 g., and these are annealed for eight hours at 500 to 525°C. Then 10 g. of the annealed reaction product is dissolved in water. The solution is evaporated over H_2SO_4 and an unstable octahydrate crystallizes out. It is dried over P_2O_5 and thus transformed to the hexahydrate. The latter is stable. The hexahydrate can also be produced by precipitation from the solution with alcohol.

II. Sodium trimetaphosphate (10 g.) is placed in a porcelain dish and covered with a solution of 2.611 g. of NaOH in 60 ml. of water. This is heated on a steam bath until dissolution occurs. After 2-3 minutes the reaction is complete as indicated by the fact that the solution yields a pure white precipitate with AgNO_3 . Prolonged heating should be avoided, as it causes hydrolysis of the triphosphate to the orthophosphate. The solid salt is obtained from the solution by precipitating with alcohol or evaporating in vacuum over H_2SO_4 at about 40°C. The yield is 100%.

The salt is pure if its solution gives a white precipitate with AgNO_3 which is readily soluble in dilute sulfuric acid and in dilute ammonia. If the precipitate is brownish, the reaction was not complete; a yellowish precipitate indicates the presence of products of hydrolysis.

SYNONYM:

Sodium tripolyphosphate.

PROPERTIES:

$\text{Na}_5\text{P}_3\text{O}_{10} \cdot 6\text{H}_2\text{O}$ formula weight 476.02. Rectangular parallelepipeds. d 2.12. On dehydration at 100°C , only $5/6$ of the water of crystallization is given up quickly, while the last molecule of water acts destructively according to the equation: $\text{Na}_3\text{P}_3\text{O}_{10} + \text{H}_2\text{O} = \text{Na}_4\text{P}_2\text{O}_7 + \text{NaH}_2\text{PO}_4$. Above 120°C the salts react to give up water and form pentasodium triphosphate: $\text{Na}_4\text{P}_2\text{O}_7 + \text{NaH}_2\text{PO}_4 = \text{Na}_5\text{P}_3\text{O}_{10} + \text{H}_2\text{O}$ (according to Thilo). Anhydrous sodium triphosphate forms two monoclinic crystalline forms with differing densities: form I, d 2.52, form II, d 2.59 (Dymon and King). The anhydrous compound melts incongruently at 622°C , forming $\text{Na}_4\text{P}_2\text{O}_7$ crystals and a melt containing 49.5 weight % $\text{Na}_4\text{P}_2\text{O}_7$.

REFERENCES:

- H. Huber. *Angew. Chem.* 50, 323 (1937).
 P. Bonneman. *Compt. Rend. Hebd. Séances Acad. Sci.* 204, 433 (1937).
 P. Bonneman and M. Bassière. *Compt. Rend. Hebd. Séances Acad. Sci.* 206, 1379 (1938).
 E. P. Partridge, V. Hicks and G. W. Smith. *J. Amer. Chem. Soc.* 63, 454 (1941) as reported by *Chem. Zentr.* 1941 II, 548.
 G. W. Morey and E. Ingerson. *Amer. J. Sci.* 242, I (1944) as reported by *Chem. Zentr.* 1945 I, 1225.
 E. Thilo and R. Rätz. *Z. anorg. allg. Chem.* 258, 33 (1949).
 E. Thilo. *Sitzungsber. Deutsche Akad. Wiss. Berlin, Kl. Mathemat. u. allg. Naturwiss.* 1952, No. 1.
 J. J. Dymon and A. J. King. *Acta Cryst.* (London) 4, 378 (1951).

HEXASODIUM TETRAPHOSPHATE, $\text{Na}_6\text{P}_4\text{O}_{13}$

Hexasodium tetraphosphate is formed by careful hydrolysis of sodium tetrametaphosphate (see p. 553) (method of Thilo and Rätz):

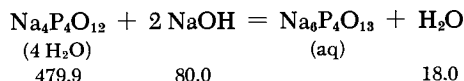

A solution of 4.8 g. of $\text{Na}_4\text{P}_4\text{O}_{12} \cdot 4\text{H}_2\text{O}$ in 85 ml. of hot water is prepared, and after cooling, a solution of 0.8 g. of NaOH in some water is added. The mixture is kept over H_2SO_4 in a vacuum desiccator, placed in an oven at 40°C . The rate of evaporation

should be such that after about 100 hours no less than 8 to 10 ml. remains. The solution is then diluted to 30 ml. and acetone is added. The colorless oil formed is dissolved in some water and reprecipitated with acetone.

PROPERTIES:

$\text{Na}_6\text{P}_4\text{O}_{13} \cdot \text{H}_2\text{O}$. Formula weight of the anhydrous salt is 469.85. The crystalline salt cannot be obtained. On standing for four weeks, the dried oil is partially transformed to $\text{Na}_3\text{HP}_2\text{O}_7 \cdot \text{H}_2\text{O}$. Heating of this mixture to 200°C for two hours produces a quantitative yield of $\text{Na}_3\text{HP}_2\text{O}_7$.

REFERENCE:

E. Thilo and R. Rätz. *Z. anorg. allg. Chem.* 260, 255 (1949).

Polyphosphates

MADRELL'S SALT, SODIUM POLYPHOSPHATE (NaPO_3)_x

According to V. Knorre, sodium polyphosphate, called Madrell's salt, is obtained by heating the residue from evaporation of a solution of NaNO_3 and phosphoric acid.

A solution of 20 g. of NaNO_3 in 25 ml. of water is prepared, mixed with 42 ml. of phosphoric acid (d 1.3) and evaporated on a water bath. The residue is then heated for four hours at 330°C and the melt is extracted with water. The salt is obtained as a practically insoluble white powder. The yield is about 95%. For unknown reasons, the preparation sometimes proves unsuccessful.

PROPERTIES:

Difficultly soluble in acetic acid. Readily soluble in cold dilute sulfuric acid, cold dilute nitric acid, and hot dilute hydrochloric acid to form orthophosphate. According to Thilo and Plaetschke, Madrell's salt is a chainlike, polymerized polymetaphosphate. According to Partridge, Hicks and Smith, it exists in two modifications, which, according to Thilo, differ in the lengths of their chains.

REFERENCES:

- R. Madrell. *Liebigs Ann. Chem.* 61, 63 (1847).
 G. von Knorre. *Z. anorg. allg. Chem.* 24, 397 (1900).
 E. Thilo and I. Plaetschke. *Z. anorg. allg. Chem.* 260, 297 (1949).
 E. P. Partridge, V. Hicks and G. W. Smith. *J. Amer. Chem. Soc.* 63, 454 (1941).
 E. Thilo. *Angew. Chem.* 63, 508 (1951).

GRAHAM'S SALT (NaPO_3)_y

The ordinary commercial material is obtained as a transparent glass in the Graham method by heating NaH_2PO_4 and quickly quenching the melt. It is still often incorrectly called "sodium hexametaphosphate" but, according to Karbe and Jandev, it is in no way a simple, well-defined hexaphosphate. Rather, most of the preparations are highly polymerized. The degree of polymerization depends on the heating temperature and reaches a maximum at about 1100°C . Thereafter, it begins to fall off, as can be seen by measuring the anion weight in the determination of the dialysis coefficient. The maximum corresponds to an anion weight of 3460, which (with certain assumptions) corresponds to about 44 PO_3 groups in the anion. Karbe and Jander give the following directions for a uniform and reproducible preparation:

A definite (always the same) amount of $\text{NaH}_2\text{P}_4 \cdot 2\text{H}_2\text{O}$ is placed in a platinum dish and, after a two-hour dehydration at somewhat above 200°C , is placed in an electric furnace set at the desired temperature. The run itself starts from time at which the temperature, after an initial drop, regains constancy. This occurs approximately one half hour after placing the dish in the furnace. At the end of a four-hour heating cycle, the melt is removed from the furnace and quenched as quickly as possible by pouring into a large iron dish filled with dry CCl_4 . The dish is externally cooled with ice-salt mixture. To speed up the cooling process, several pieces of Dry Ice are placed in the CCl_4 , before the addition of the melt. They are soon coated with a layer of solid CCl_4 . The rate of cooling is increased considerably by the melting of this layer which follows on addition of the hot mass and by further evaporation of the CO_2 . The vitreous product is filtered off. It usually breaks up spontaneously because of the great internal stresses and the crushing can be completed by slight agitation. The adsorbed CCl_4 is removed in vacuum. The pieces of glassy product are immediately sealed in an air-tight container.

PROPERTIES:

Extremely hygroscopic; becomes moist and sticky even after standing in the air for a short time. Dissolves slowly in cold water but is quite soluble in warm water between 30 and 50°C . According to Bronnikov, solubility (20°C) 973.2 g./liter; (80°C) 1744 g./liter. Its solutions give precipitates with Mg, Ca, Ba, Pb and Ag salts. These precipitates are soluble in an excess of the polyphosphate. Concentrated NaCl solution and alcohol flocculate the solutions, gradually forming a viscous, oily mass. No definite melting point; with careful heating, the material starts to liquefy somewhat above 600°C .

REFERENCES:

- T. Graham. Pogg. Ann. 32, 64 (1834).
K. Karbe and G. Jander. Kolloid-Beihefte 54, 80-91 (1942).
A. Kh. Bronnikov. Zh. Prikladnoy Khimii 12, 1287 (1939) (cited in Karbe and Jander).

KURROL'S SODIUM POLYPHOSPHATE, $(\text{NaPO}_3)_x$

The preparation starts with the production of seed crystals. Thus 85 g. of Na_2HPO_4 and 15 g. of $\text{NH}_4\text{H}_2\text{PO}_4$ are heated at 800-900°C until all water and NH_3 are removed. Then the mixture is allowed to cool and kept at a constant temperature between 650 and 550°C for a few hours. The melt solidifies almost completely to a fibrous product, which is still somewhat impure, since an excess of phosphoric acid was used. The fibrous mass is pulverized, washed several times with water and dried with alcohol and ether.

Then, in the Pascal method, a melt of Graham's salt is allowed to cool to 600°C, the seed crystals are strewn on its surface, and the melt is kept for another half hour at 550°C, during which it solidifies to a completely pure material.

PROPERTIES:

Very definite fibrous structure. Cannot be pulverized in a mortar, but must be ground in a mill. Swells in pure water and if a sufficient amount of water is present, forms a cloudy, viscous solution after several days. Similar highly viscous, colloidal systems are also formed with NH_4 salts, with highly diluted Ca or Mg salt solutions and with LiCl but not, however, with K ions. Can be precipitated with NaCl solution, very concentrated $\text{NH}_4\text{-KCl}$ solution and with alcohol. M.p. 630-650°C. d. 2.56 to 2.62. The anions of the salt consist of very long PO_3 chains, and the Na ion can be replaced reversibly with other cations, as in ion exchange. Thilo considers Kurrol's salt to be the crystalline form of Graham's salt. It appears in two forms *a* and *b*, of which form *a*, obtained from Graham's salt by annealing, transforms into form *b* on standing, on treatment with water or through purely mechanical stresses. The two forms show different powder patterns. They also differ by the fact that form *a* is quantitatively transformed into Madrell's salt on annealing between 420 and 490°C, while form *b* transforms quantitatively into trimetaphosphate between 390 and 600°C.

REFERENCES:

- G. Tammann. J. prakt. Chem. [2] 45, 467 (1892).
H. Huber and K. Klumpner. Z. anorg. allg. Chem. 251, 213 (1943).

P. Pascal. Compt. Rend. Hebd. Séances Acad. Sci. 178, 211 and 1541 (1924);

E. Thilo. Angew. Chem. 63, 511 (1951).

Metaphosphates

SODIUM TRIMETAPHOSPHATE, $\text{Na}_3\text{P}_3\text{O}_9 \cdot 6 \text{H}_2\text{O}$

Sodium trimetaphosphate, discovered by Fleitmann and Henneberg, is best prepared, according to Von Knorre, by heating a mixture of Na_2HPO_4 with NH_4NO_3 . According to Karbe and Jander, a temperature of $310\text{--}320^\circ\text{C}$ is most favorable:

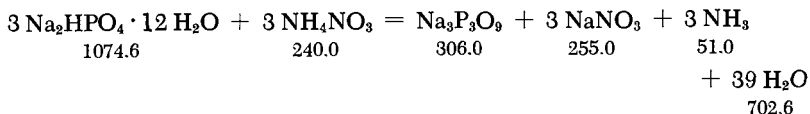

The salt may also be formed by annealing Graham's salt (see above) at 520°C .

I. A mixture of 60 g. of Na_2HPO_4 and 17 g. of NH_4NO_3 is heated for six hours at $310\text{--}320^\circ\text{C}$. The mixing produces a very sharp cooling of the salt mass. The reaction product is white and crystalline. It is dissolved in cold water, filtered and allowed to crystallize. (According to Tammann, two layers are formed on leaching, of which the lower contains Graham's salt, while the trimetaphosphate can be crystallized out of the upper one after layer separation.)

II. Graham's salt is heated for 12 hours at 520°C . The absence of precipitation with Ba, Ag, Pb or other salts of heavy metals indicates the end point of the reversible reaction. To prepare the hexahydrate, 51 g. of anhydrous salt is dissolved in 160 ml. of water at room temperature and 45 ml. of saturated NaCl solution is added. After stirring for four hours the crystals are filtered by suction and air dried. The yield is 23 g. (33%) of hexahydrate.

PROPERTIES:

Formula weight 413.99. Triclinic prisms. d 2.476. Non-hygroscopic; loses its water of crystallization over H_2SO_4 and at 100°C . On extended storage at above 20°C , loses water and finally transforms to the anhydrous salt. Solubility: 4.5 parts H_2O per part of salt; insoluble in alcohol. The transformation to orthophosphate requires repeated evaporation with mineral acids. Trimetaphosphate forms no precipitates with Ba, Ag or Pb salts. However, the salt obtained in the above procedures gives a slight opalescence with silver nitrate.

REFERENCES:

- T. Fleitmann and W. Henneberg. *Liebigs Ann. Chem.* **65**, 304 (1848).
 G. von Knorre. *Z. anorg. allg. Chem.* **24**, 381 (1900).
 K. Karbe and G. Jander. *Kolloid-Beihefte* **54**, 35 and 36 (1942).

SODIUM TETRAMETAPHOSPHATE, $\text{Na}_4\text{P}_4\text{O}_{12} \cdot n \text{H}_2\text{O}$ ($n = 10$ and 4)

The starting material is $\text{Cu}_2\text{P}_4\text{O}_{12}$, prepared by heating a mixture of CuO and H_3PO_4 . This is then reacted with Na_2S to yield the sodium salt (Andress, Gehring and Fischer):

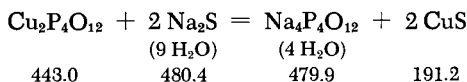

Freshly precipitated CuO is added slowly and in small portions to a 5% excess of 76.9% H_3PO_4 . This yields a paste, which becomes bright blue on standing overnight. To drive out the free water, the mass is heated in a porcelain evaporating dish over a Bunsen burner. At first, the heating is gentle; then the material is heated for several hours at temperatures not exceeding 430°C . The fine crystals formed are washed eight times with hot water, until the wash water is neutral.

A 72-g. portion of this $\text{Cu}_2\text{P}_4\text{O}_{12}$ is added in small portions to a vigorously stirred solution of 78 g. of $\text{Na}_2\text{S} \cdot 9\text{H}_2\text{O}$ in 750 ml. of O_2 -free water. The filtered solution is concentrated to 1/3 its volume, filtered and precipitated with alcohol or acetone. After recrystallization, pure white crystals are obtained. The yield is 52 g., or 67% of theoretical. A further fraction may be obtained from the mother liquor (Thilo and Rätz).

Other preparative methods: Free tetrametaphosphoric acid, $\text{H}_4\text{P}_4\text{O}_{12}$, is formed in low-temperature hydration of P_4O_{10} (form M, see p. 541) (Bell, Audrieth and Hill). The Na salt is readily obtained from this solution by neutralization with NaOH .

With vigorous stirring, 50 g. of P_4O_{10} is slowly added to 300 ml. of water. The temperature should never exceed 15°C . When the P_4O_{10} is completely dissolved, the solution is neutralized with 30% NaOH to a pH of 7 (about 98 g. of NaOH solution is needed). Then 30 g. NaCl is added and the mixture allowed to stand overnight. The decahydrate is formed below 25°C , while the tetrahydrate is obtained above 40°C . The crystals are filtered off, washed with water at $5\text{--}10^\circ\text{C}$, and air-dried. The yield is 60-65%.

According to Such and Tomlinson, the tetrahydrate may be obtained by treating P_4O_{10} with $\text{Na}_2\text{CO}_3 \cdot 10\text{H}_2\text{O}$ or with a cold suspension of NaHCO_3 . The yield is 50%.

Purification of $\text{Na}_4\text{P}_4\text{O}_{12}$ by ion exchange is described by Barney and Gryder.

PROPERTIES:

$\text{Na}_4\text{P}_4\text{O}_{12} \cdot 4\text{H}_2\text{O}$ formula weight 479.93. The decahydrate loses six molecules of water on heating to 40°C . The tetrahydrate occurs in two polymorphic forms with the transition point at 54°C . The transition is irreversible. The anhydride is formed at 100°C . It transforms into trimetaphosphate at about 400°C . The tetraphosphate (p. 548) is formed on careful hydrolysis with NaOH ; at 100°C the ortho- and triphosphates are formed: $\text{P}_4\text{O}_{12}^{4-} + 4\text{OH}^- = \text{P}_3\text{O}_{10}^{5-} + \text{PO}_4^{3-} + 2\text{H}_2\text{O}$.

REFERENCES:

- K. R. Andress, W. Gehring and K. Fischer. *Z. anorg. allg. Chem.* **260**, 331 (1949).
 E. Thilo and R. Rätz. *Z. anorg. allg. Chem.* **260**, 255 (1949).
 R. N. Bell, L. F. Audrieth and O. F. Hill. *Ind. Eng. Chem.* **44**, 568 (1952).
 J. E. Such and R. H. Tomlinson, as cited by B. Topley. *Quart. Revs.* **3**, 345 (1949).
 D. L. Barney and J. W. Gryder. *J. Amer. Chem. Soc.* **77**, 3195 (1955).

Orthophosphorous Acid



Orthophosphorous acid is prepared by the hydrolysis of PCl_3 :

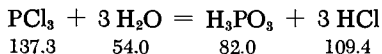

In order to moderate the violent reaction, Milobedzki and Friedmann recommend using concentrated hydrochloric acid. In this procedure two layers are formed, so that only a part of the PCl_3 enters into the reaction at any time. The product solution is concentrated. Simon and Feher heat the commercial acid for twelve hours at 80°C and allow it to cool over P_2O_5 . In this way they obtain a crystalline acid containing 99.3% H_3PO_3 .

PROPERTIES:

White crystalline mass; deliquesces on standing in air; very soluble in water. M.p. 74°C . The solid acid disproportionates on heating: $4 \text{H}_3\text{PO}_3 = \text{PH}_3 + 3\text{H}_3\text{PO}_4$. d (21°C) 1.65.

REFERENCES:

- T. Milobedzki and M. Friedmann. *Chemik Polski* 15, 76 (1917), as cited by *Chem. Zentr.* 1918 I, 933.
 A. Simon and F. Feher. *Z. anorg. allg. Chem.* 230, 298 (1937).

Hypophosphorous Acid

According to Klement, free, crystalline hypophosphorous acid can be obtained in a highly purified form in a simple procedure consisting of treating $\text{Na}_2\text{H}_2\text{PO}_2$ with the H^+ form of a cation exchanger (I). According to Simon and Feher, one can also start directly from a commercial solution of H_3PO_2 (about 50%, d 1.274), which is then concentrated. In the Thomsen preparation (II), $\text{Ba}(\text{H}_2\text{PO}_2)_2$ (see p. 557) is decomposed with the stoichiometric quantity of H_2SO_4 :

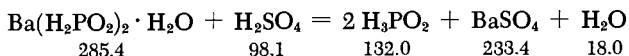

A procedure for the purification of the acid is given by Jenkins and Jones (III).

I. About 70 g. of commercial cation exchange resin is placed over a cotton wad in a glass column with a bulb and a drain stopcock. The tube I.D. is 25 mm. and its length is about 25 cm. The tube is completely filled with water. The resin is left to swell for a few hours and then, by opening the stopcock, 5 N HCl is drawn from the bulb into the layer covering the resin until the resin is entirely covered with acid. After 15 minutes the acid is drawn off and distilled water is repeatedly added until the wash water is acid free. The resin layer is completely drained and a solution of 15 g. of NaH_2PO_2 in 60 ml. of water is added to it. Any air bubbles present in the resin are removed by shaking. After 15 minutes of treatment, the solution is drained drop-by-drop and the resin is rinsed first with 50 ml., and then with 25 ml. of distilled water. The washings are combined with the solution and the combined solution of free H_3PO_2 is then filtered and evaporated on a water bath. Further dehydration proceeds via the method of Simon and Feher. The acid is placed in high vacuum over P_2O_5 and kept there until the P_2O_5 begins to turn red-brown because of the reaction with the volatile acid. The acid is then crystallized in a cold bath. The crystals are freed of mother liquor on cooled clay plates, and are melted and allowed to recrystallize by freezing. The product is about 98% pure.

The ion-exchange resin is again washed twice with distilled water, using 50 ml. each time; it is reactivated with 5N HCl, and, after thorough washing until the eluent is acid-free, it can be used again.

It is recommended that a batch of at least 60 g. of NaH_2PO_2 be processed (in four portions) at one time. This procedure has the advantage that a pure solution of the free acid is obtained directly, without having to filter off the finely divided BaSO_4 as in method II. Evaporation in high vacuum assures that no decomposition of H_3PO_2 will occur and that the product will therefore be free of traces of H_3PO_3 and H_3PO_4 .

II. A solution of 285 g. of $\text{Ba}(\text{H}_2\text{PO}_2)_2$ in five liters of water is decomposed with a solution of 100 g. of concentrated H_2SO_2 in 3-4 times its weight of water. The mixture is well stirred and allowed to stand for a day; the BaSO_4 settles out. The supernatant liquid is siphoned off. The product solution of H_3PO_2 , which, if proper amounts of reactants are used, contains only traces of Ba, is evaporated by boiling in a porcelain dish until concentrated to about 1/10 of the original volume. It is then evaporated in a Pt dish while stirring with a thermometer until the temperature reaches 105°C . The bulb of the thermometer must be completely immersed without, however, touching the bottom of the dish. It is therefore impractical to work with less than the amount given above, since otherwise the volume of the concentrated acid is too small. The Pt dish is heated with a burner covered with a wire screen, so that the heat is evenly distributed at the bottom of the vessel.

When the temperature has risen to 105°C , the liquid is quickly filtered and the colorless filtrate is concentrated until the temperature rises to 110°C . It should not be allowed to boil. The temperature is now kept constant for 15 minutes and is then gradually raised to 130°C , again avoiding boiling. The acid simmers gently, shows no gas bubbles, and has no odor of PH_3 . However, some vapor is present because traces of it volatilize. By carefully heating, the temperature can be raised even to 138°C without decomposition. After the acid has been heated for about 10 minutes at 130°C , the flame is removed and the liquid is cooled and filtered into a glass-stoppered flask.

The glass vessel is now cooled down to a few degrees below zero, and if crystallization does start, the bottom of the vessel is scratched with a glass rod and the material allowed to stand. III. Jenkins and Jones recommend the following procedure for the purification of the acid. The directions must be followed most carefully. Commercial 50% acid (600 ml.) is placed in a one-liter suction flask, provided with a two-hole stopper for a thermometer and a gas inlet tube with a coarse fritted glass end. The suction flask is placed on a hot plate and connected to an aspirator.

A fast stream of N_2 is introduced until all air is displaced. The N_2 stream is throttled down to a few bubbles, and the aspirator and the hot plate are turned on. Evaporation to 300 ml. is carried out at $40^\circ C$. The temperature should not exceed $45^\circ C$. The cooled liquid is poured into a wide-neck Erlenmeyer flask, which is then well stoppered and placed in a Dry Ice-acetone bath. After crystallization, which sometimes must be started by scratching the walls, the flask is allowed to stand for 12 hours at about $5^\circ C$. At that point the liquid should constitute 30-40% of the flask contents. Further operations must be carried out in a refrigerated space. The crystals are quickly filtered through filter paper and the filtrate is discarded. The crystals are pressed dry and placed in a crystallizing dish, in which they are allowed to stand until about 20-30% of the contents liquefy. The residue is filtered off and the process is repeated. The almost pure residue (about 10% yield) is stored over $Mg(ClO_4)_2$ in a vacuum desiccator in a refrigerated room. To obtain large crystals, the material can be recrystallized from n-butanol.

PROPERTIES:

Anhydrous H_3PO_2 crystallizes in colorless lamellae which readily dissolve in water. M.p. $26.5^\circ C$. Heating the anhydrous acid to $130-140^\circ C$ results in disproportionation to PH_3 and H_3PO_3 . These decompose further into PH_3 and H_3PO_4 . d ($19^\circ C$) 1.493.

REFERENCES:

- J. Thomsen. Ber. dtsch. chem. Ges. 7, 994 (1874).
 R. Klement. Z. anorg. allg. Chem. 260, 267 (1949).
 A. Simon and F. Fehér. Z. anorg. allg. Chem. 230, 298 (1937).
 W. A. Jenkins and R. T. Jones. J. Amer. Chem. Soc. 74, 1353 (1952).

Barium Hypophosphite



Barium hypophosphite and PH_3 are produced in the reaction of white phosphorus with $Ba(OH)_2$:

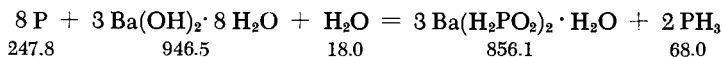

A solution of 120 g. of crystalline $Ba(OH)_2$ in 1200 ml. of water is heated for about four hours with 30 g. of white P in a round-bottom flask. The flask is provided with a long glass tube, extending

to the stack of the exhaust hood, to conduct away the spontaneously igniting phosphine mixture. When the P is completely dissolved, CO_2 is introduced to precipitate the excess $\text{Ba}(\text{OH})_2$. The precipitate is filtered off and washed with hot water. The solution and the wash water are combined and evaporated to half the original volume, refiltered, and evaporated until crystallization begins. Some alcohol is then added and the mixture is left to cool. The resulting crystals are suction-filtered and the mother liquor again evaporated until crystallization takes place. The accumulated salts are combined and recrystallized from hot water. The yield is 40-60 g.

PROPERTIES:

Formula weight $\text{Ba}(\text{H}_2\text{PO}_2)_2$, 267.34; $\text{Ba}(\text{H}_2\text{PO}_2)_2 \cdot \text{H}_2\text{O}$, 285.36. Colorless, tabular prisms (monoclinic) with a pearly sheen. Insoluble in alcohol, readily soluble in water. Solubility: 28.6 g. per 100 g. cold water; 33.3 g. per 100 g. boiling water. d (17°C) 2.90.

REFERENCE:

H. Rose. Pogg. Ann. 9, 370 (1827).

Hypophosphoric Acid



According to Salzer, free crystalline hypophosphoric acid is obtained when lead hypophosphate, prepared from disodium dihydrogen hypophosphate (see below), is decomposed with H_2S and the resulting acid solution evaporated (Baudler):

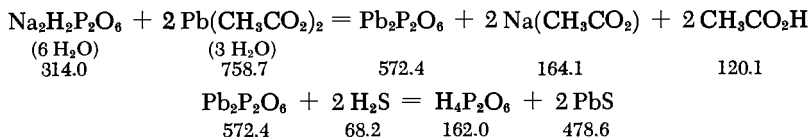

A clear solution of 425 g. of $\text{Pb}(\text{C}_2\text{H}_3\text{O}_2)_2 \cdot 3\text{H}_2\text{O}$ in 850 ml. H_2O (if necessary, treated with several drops of glacial acetic acid and filtered) is stirred into a hot solution of 174 g. of $\text{Na}_2\text{H}_2\text{P}_2\text{O}_6 \cdot 6\text{H}_2\text{O}$ (twice recrystallized) in one liter of water. A copious precipitate is formed immediately and is allowed to settle by standing overnight; the supernatant liquid is then decanted; the precipitate is filtered on a suction filter and washed carefully with small amounts of H_2O . It is then placed in a wide-mouth

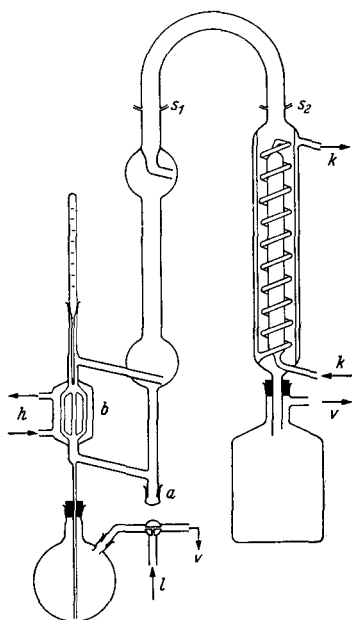

Fig. 197. Evaporation apparatus for the preparation of hypophosphoric acid. *a*) Drain; *b*) vaporizer (actually five heating tubes instead of the three shown); *h*) heating medium; *k*) cooling liquid; *l*) air intake; *s*₁, *s*₂) ground-glass ball and socket joints; *v*) vacuum connection.

The condenser and the receiver are cooled with methanol to -10 to -15°C . Except for the ground-glass ball and socket joint *s*₁, which is coated with grease, all other joints are sealed with purified molten paraffin. After evaporating for about 2 hours, the saturated $\text{H}_2\text{P}_2\text{O}_6 \cdot 2\text{H}_2\text{O}$ solution in the reservoir is drawn back by suction into the reservoir or drained through *a*. Following cooling at -78°C and suction filtering through a fritted glass filter (filtration protected from atmospheric moisture), 40–43 g. of crystalline $\text{H}_4\text{P}_2\text{O}_6 \cdot 2\text{H}_2\text{O}$ contaminated with 0.3–1.0% H_3PO_3 is obtained. The mother liquor is contaminated by large amounts of hydrolysis products.

flask with 500 ml. of H_2O , mechanically agitated for several hours, and suction-filtered. This is repeated. The pure $\text{Pb}_2\text{P}_2\text{O}_6$, dried as much as possible by suction, is then suspended as evenly as possible, using vigorous stirring, in one liter of double-distilled water placed in a three-liter, large diameter cylindrical vessel. A fast stream of H_2S is bubbled through for about seven hours, while the vessel is cooled with ice. The H_2S flow is shut off when the precipitate has taken on a uniform jet-black color. If the slurry becomes too thick, more H_2O must be added. The precipitate of PbS is suction-filtered and freed as completely as possible from the associated residual acid solution by careful washing with some H_2O . Dissolved H_2S is removed in a stream of N_2 . After repeated filtration through activated charcoal, using a fritted glass filter, the solution—about one liter containing about 7% $\text{H}_4\text{P}_2\text{O}_6$ —is placed in the reservoir of a natural circulation evaporator (see Fig. 197). The capacity of the vaporizer is about 60 ml.; and with the amounts specified here, crystallization of the $\text{H}_4\text{P}_2\text{O}_6 \cdot 2\text{H}_2\text{O}$ occurs shortly before this volume is attained. The procedure is carried out at a bath temperature of 65°C and a pressure of 3–7 mm.

When purity requirements are lower, the acid solution is simply filtered to remove the PbS and evaporated by boiling. This can be continued as long as it still contains a large amount of water. In order to concentrate it to a syrup, it is evaporated in vacuum over CaCl_2 . The $\text{H}_4\text{P}_2\text{O}_6 \cdot 2\text{H}_2\text{O}$ precipitates upon cooling of the syrupy liquid.

PROPERTIES:

Formula weight ($\text{H}_4\text{P}_2\text{O}_6 \cdot 2\text{H}_2\text{O}$) 198.01. Large rhombic plates, hygroscopic, very readily soluble in water. M.p. (corr.) 62°C . When placed in vacuum over P_2O_5 for two months it forms the anhydrous acid which has a broad melting range beginning at about 73°C . The anhydrous acid liquefies at room temperature within six days but remains unchanged for long periods at $0-5^\circ\text{C}$ if H_2O is excluded; the same holds for the dihydrate. An aqueous solution of the acid is stable; it decomposes on boiling with sulfuric acid to form H_3PO_3 and H_3PO_4 . The use of rubber gloves and protective glasses is strongly recommended when working with the solid acid or concentrated solutions. Contact with the skin produces blisters which heal very slowly; damage to the cornea results on contact with the eyes.

REFERENCES:

- T. Salzer. Liebigs Ann. Chem. 187, 322 (1877); 211, (1882).
M. Baudler. Z. anorg. allg. Chem. 279, 115 (1955).
H. Remy and H. Falius. Naturwiss. 43, 177 (1956).

Disodium Dihydrogen Hypophosphate



Leininger and Chulski have demonstrated that disodium dihydrogen hypophosphate is produced in the oxidation of red P with NaClO_2 in a yield of about 42%. In addition, 19% orthophosphate, 35% phosphite, and 2% hypophosphite are formed. The procedure, somewhat cumbersome because of the large cooling apparatus required, has been improved and simplified by Baudler and, later, by Remy and Falius. According to the latter authors, special apparatus is unnecessary. Sufficient phosphorus must be available, however, and the heat of reaction must be rapidly removed. The yield is better than that achieved by Leininger and Chulski.

Red phosphorus (100 g.) is suspended in one liter of water placed in an open, round-bottom flask, which should be well cooled by running water over it. Over a period of five hours, a

solution of 170 g. of NaClO_2 in 350 ml. of H_2O is added in drops with vigorous stirring. The unreacted P is then filtered. Following the addition of 10-12 g. of activated charcoal, the mixture is allowed to stand overnight. The activated charcoal is then filtered, and the clear solution is treated with a 15% solution of sodium hydroxide to give a pH of 5.4 (measured with a glass electrode). At this point, cationic impurities precipitate out. To complete the precipitation, the mixture is boiled, filtered, and placed overnight in a refrigerator. The precipitated crystals are suction-filtered, washed with ice water, and dried in air. The yield is about 120 g. Considerably larger quantities of material can be reacted if sufficient cooling is provided. The salt is recrystallized once or more from water for purification.

PROPERTIES:

Formula weight ($\text{Na}_2\text{H}_2\text{P}_2\text{O}_6 \cdot 6 \text{H}_2\text{O}$) 314.04. Forms tabular, monoclinic crystals. Stable in air at room temperature; loses its water of crystallization upon gentle heating. The salt, dehydrated at 100°C , melts at 250°C and decomposes at red heat, evolving flammable phosphine. d (20°C) 1.8.

REFERENCES:

- E. Leininger and T. Chulski. *J. Amer. Chem. Soc.* 71 2385 (1949).
 M. Baudler. *Z. anorg. allg. Chem.* 279, 115 (1955).
 H. Remy and H. Falius. *Naturwiss.* 43, 177 (1956).

Tetrasodium Hypophosphate

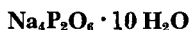

According to Salzer, tetrasodium hypophosphate is obtained by neutralizing a solution of $\text{Na}_2\text{H}_2\text{P}_2\text{O}_6$ with Na_2CO_3 :

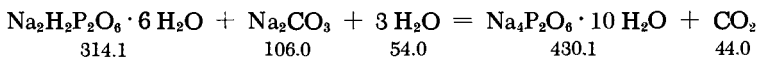

A solution of $\text{Na}_2\text{H}_2\text{P}_2\text{O}_6$ in 50 parts of water is treated with an excess of concentrated Na_2CO_3 solution. The neutral salt precipitates in small, snowflake-like crystals. If a hot concentrated solution of the disodium salt is treated with Na_2CO_3 solution, the entire solution solidifies into silky needles of the tetrasodium salt.

PROPERTIES:

Glossy crystalline needles. Recrystallizable from water without change. The aqueous solution gives an alkaline reaction with phenolphthalein. d 1.823.

REFERENCE:

T. Salzer. Liebigs Ann. Chem. 194, 29 (1878).

Barium Dihydrogen Hypophosphite



Obtained by precipitation of a solution of $\text{Na}_2\text{H}_2\text{P}_2\text{O}_6$ with BaCl_2 solution.

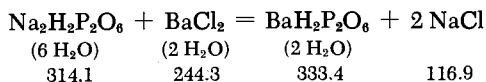

A solution of 144 g. of $\text{Na}_2\text{H}_2\text{P}_2\text{O}_6 \cdot 6 \text{H}_2\text{O}$ (twice recrystallized) is prepared with heating in three liters of water, and 12 ml. of hydrochloric acid (d 1.12) is added. A hot, filtered solution of 112 g. of $\text{BaCl}_2 \cdot 2 \text{H}_2\text{O}$ in 720 ml. of water is gradually stirred in. The initially gelatinous precipitate becomes coarsely crystalline after standing overnight. It is suction-filtered on a fritted glass filter, washed with ice water, and dried on a clay plate. The yield is about 140 g.

PROPERTIES:

Clear, very hard, needle-shaped monoclinic crystals. Very slightly soluble in water. Loses its water of crystallization at 140°C .

REFERENCES:

C. Bensa. Z. anorg. allg. Chem. 6, 132 (1894);
M. Baudler. Z. anorg. allg. Chem. 279, 115 (1955).

Potassium Peroxydiphosphate



According to Fichter et al., potassium peroxydiphosphate is formed during the anodic oxidation of KH_2PO_4 , in the presence of fluoride and chromate, through the decomposition of the intermediate peroxyphosphoric acid:

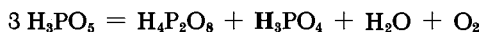

A solution of 302.2 g. of KH_2PO_4 , 198 g. of KOH , 120 g. of KF and 0.355 g. of K_2CrO_4 in one liter of water is prepared. A 215-ml. portion of this solution is electrolyzed in a large platinum dish (which serves as the anode), with a rapidly rotating bent Pt wire used as the cathode. The anode current density is 0.02-0.03 amp./ cm^2 . The electrolyte temperature is maintained below 14°C by external cooling. The current is interrupted after three hours and the material is allowed to stand overnight at room temperature. During this period, the intermediate H_3PO_5 decomposes, evolving O_2 and re-forming orthophosphate. A certain amount of $\text{K}_4\text{P}_2\text{O}_8$ is also formed (see above equation), while the already existing $\text{K}_4\text{P}_2\text{O}_8$ remains unchanged. Following a second electrolysis for two hours, the material is again allowed to stand overnight. Finally, the solution is electrolyzed a third time for one hour and again permitted to stand overnight.

The solution is then evaporated on a water bath, with stirring, while a stream of air is directed across the upper surface so that its temperature never rises above 80°C . By recrystallizing three times, 96.4-99.8% pure $\text{K}_4\text{P}_2\text{O}_8$ is obtained. The yield is about 80%.

PROPERTIES:

Formula weight 346.35. Very gradually evolves free I_2 with KI .

REFERENCES:

- F. Fichter and A. Rins y Miro. *Helv. Chim. Acta* 2, 3 (1919).
 F. Fichter and E. Gutzwiller. *Helv. Chim. Acta* 11, 323 (1928).

Phosphorus Trisulfide



Phosphorus trisulfide can be synthesized either by Stock's method (I), which involves fusing red P and S and carefully purifying the crude product by recrystallization from CS_2 , followed by a second recrystallization from benzene, or according to German patent 309,618 (F. C. Frary), which uses white P in a high-melting inert solvent (II).

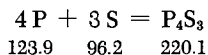

I. STOCK'S METHOD

The starting materials and the solvents must be carefully purified prior to use. Very pure crystalline S is powdered as finely

as possible and dried at 100°C. Red P is purified by the method given on p. 519. Carbon disulfide is shaken for 24 hours with CaCl_2 and Hg, distilled and stored in brown bottles over P_2O_5 . Benzene is distilled and stored over P_2O_5 .

An intimate mixture of 155 g. of red P and 96 g. of S is prepared and portions (40–50 g.) are reacted in a large diameter open test tube under a stream of dry CO_2 . It is recommended that a pan filled with sand be placed under the test tube since the molten mass will immediately catch fire if the tube breaks. The test tube is first lightly preheated over its entire length to about 100°C and is then heated with a small flame in one spot at the upper edge of the mixture until the onset of the reaction. As soon as the entire charge has reacted (thereby becoming molten), it is heated to the point where distillation begins and then cooled in a stream of CO_2 . The cake is then pulverized and extracted with hot CS_2 (200 g. for each 100 g. of material). By evaporation of the CS_2 , an almost theoretical yield of crude sulfide, which melts between 130 and 150°C, is obtained.

Purification is carried out by adding hot water to the powdered product (200 ml. for each 100 g. of material) in a one-liter round-bottom flask; a strong jet stream is introduced into the mixture for one hour so that it is continually agitated. On cooling, the supernatant liquid is decanted as completely as possible and the P_4S_3 is extracted in a separatory funnel with about 150 g. of CS_2 for each 100 g. of crude sulfide. The solution, which is easily separated from the aqueous layer and the undissolved impurities, is shaken for 12 hours with P_2O_5 ; it is then evaporated on a steam bath until crystals form and then evaporated in aspirator vacuum until dry. The final drying may not be done over a steam bath because the sulfide is partially decomposed at this temperature. A 100-g. quantity of crude product yields about 98 g. of compound, m.p. 169–171.5°C, which still contains some CS_2 . This is removed by recrystallization from benzene in the following manner: A reflux condenser is connected with a ground-glass joint to the 5-cm. -diameter neck of a 750-ml. round-bottom flask; an extraction cell is suspended from the lower end of the condenser by a wire. The cell consists of a piece of glass tubing 10 cm. long and 4 cm. in diameter which has been somewhat narrowed at the lower end and fitted with several small hooks at the upper. Hard filter paper is secured over the lower opening. The cell holds about 80–100 g. of the compound to be recrystallized. A 300-ml. portion of benzene is kept at a vigorous boil in the surrounding flask. In six hours, about 100 g. of P_4S_3 is extracted from the cell. The small, uniform crystals which precipitate out of the benzene solution are carefully suction-filtered, with care not to cool too strongly and protection from atmospheric moisture. It is freed of residual solvent by passing dry H_2 over it. This is

conveniently done in an upright glass tube, not too wide, and is continued so long as the H_2 gives off an odor of benzene. Additional, less pure product (5-7% of the crude) can be recovered by concentrating the benzene solution. The yield of pure P_4S_3 is about 92% of the crude product.

II. PROCEDURE ACCORDING TO GERMAN PATENT 309,618

White P is dissolved in (virtually nonflammable) α -chloronaphthalene and the stoichiometric quantity of S is added. The solvent acts as a diluent controlling the rate of reaction and causes crystallization of the sulfide. When the reaction is complete, the mixture is cooled with stirring. Most of the P_4S_3 precipitates as a fine powder.

PROPERTIES:

Yellowish-green, long rhombic needles; stable in the air. M.p. $172.5^\circ C$, b.p. $407^\circ C$; d_4^{20} 2.03. In the absence of O_2 and moisture, remains stable above $700^\circ C$. Decomposed by water at elevated temperatures, evolving H_2S . Soluble in CS_2 and benzene. These solutions become turbid in air almost immediately and gradually deposit a copious, yellowish-white precipitate.

REFERENCES:

- I. A. Stock. Ber. dtsh. chem. Ges. **43**, 150 (1910).
- II. F. C. Frary. German Patent 309,618, Class 12i, December 2, 1918, cited in Chem. Zentr. 1919 II, 55.

Phosphorus Pentasulfide



According to Boulouch, as confirmed by Treadwell and Beeli, phosphorus pentasulfide is easily prepared by exposing a solution of P_4S_3 and S in CS_2 to light in the presence of a small amount of iodine as catalyst.

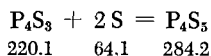

A solution of 22 g. of P_4S_3 and 7 g. of S in 200 ml. of CS_2 is prepared, and 0.2 g. of iodine is added. The mixture is exposed to light for one or two days (for three days in diffuse daylight at room temperature, according to Treadwell and Beeli). The crystals

that precipitate are washed with CS_2 , dried, powdered, washed again and dried in air. The crystals usually contain residual CS_2 , which can be removed by melting. The yield is 23 g.

PROPERTIES:

Sulfur-yellow crystals which, when slowly heated, melt between 170° and 220°C . d (25°C) 2.17.

REFERENCES:

R. Boulouch. *Compt. Rend. Hebd. Séances Acad. Sci.* 138, 363 (1904);
W. D. Treadwell and C. Beeli. *Helv. Chim. Acta* 18, 1161 (1935).

Phosphorus Heptasulfide



According to Stock, phosphorus heptasulfide is produced in a manner analogous to that for P_4S_3 (see p. 563).

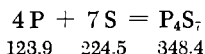

The starting materials and the solvent must be purified as specified on p. 563.

An intimate mixture of 100 g. of red P and 173 g. of S is prepared and reacted in portions (40-50 g.), after which it is heated until pronounced distillation occurs. The cooled produce is finely powdered and recrystallized from CS_2 in the extraction apparatus described on p. 564. The extraction cell is charged with 40-50 g. of crude product; the flask is charged with about 300 ml. of CS_2 , which must be maintained at a vigorous boil. Because of the low solubility of P_4S_7 , the extraction requires about 48 hours. The sulfide, which precipitates as glittering crystals, is then recrystallized in the same manner. The crystals are suction-filtered, care being taken to exclude atmospheric moisture and not to cool too much. It is dried in a stream of hydrogen at 100°C .

PROPERTIES:

Almost colorless, faintly yellow monoclinic prisms. M.p. 310°C , b.p. (760 mm.) 523°C . The best solvent is CS_2 . One part of P_4S_7 dissolves in 3500 parts of CS_2 at 17°C and in 20,000 parts at 0°C . The very slight solubility in CS_2 distinguishes P_4S_7 from the other

phosphorus sulfides. Slowly decomposed by cold water, rapidly by hot water, forming H_2S . d (17°C) 2.19.

REFERENCE

A. Stock. Ber. dtsch. chem. Ges. 43, 414 (1910).

Diphosphorus Pentasulfide



According to Stock and Herscovici, the preparation of diphosphorus pentasulfide is carried out by the same synthesis as for P_4S_3 (p. 563). The reagents must also be purified according to the instructions given there.

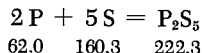

An intimate mixture of 100 g. of red P and 260 g. of S (2 g. atoms of P to 5 g. atoms of S, with a 1% excess of S) is reacted in portions and heated until vaporization begins. The cooled product is coarsely ground and placed in a Pyrex tube. The tube is evacuated, using an aspirator, fused to seal it and heated for several hours at about 700°C in an iron tube packed with sand and closed with a screw cap. After cooling, the glass tube is broken; the contents are pulverized and recrystallized from boiling CS_2 in the extraction apparatus (about 300 ml. per 50 g. of sulfide). The precipitated sulfide is twice recrystallized in the same manner, and the crystals are dried at 100°C in a stream of H_2 . If the crude product is not heated under pressure, a pure product can only be obtained by repeated recrystallization. The yield is 60%.

PROPERTIES:

Light yellow, almost colorless triclinic crystals with a P_4S_{10} molecular lattice (Vos and Wiebenga). M.p. 276°C , b.p. 514°C ; d_4^{20} 2.03. Soluble with difficulty in boiling CS_2 (about 1:200). Decomposes in moist air or water forming H_3PO_4 and H_2S . Dissolves on heating in caustic soda to form a yellow sodium thiophosphate solution. Organic compounds containing oxygen are converted to sulfur-containing materials.

REFERENCES:

A. Stock and B. Herscovici. Ber. dtsch. chem. Ges. 43, 1223 (1910).
A. Vos and E. H. Wiebenga. Acta Cryst. (Copenhagen) 8, 217 (1955).

Monothiophosphoric Acid



The thio derivatives of orthophosphoric acid—tetrathiophosphoric acid, trithiophosphoric acid, dithiophosphoric acid and monothiophosphoric acid—are unstable in aqueous media, forming H_2S and H_3PO_4 by hydrolysis:

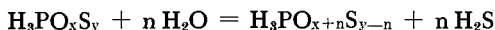

Of the four acids, however, monothiophosphoric acid is sufficiently stable that Klement obtained an 83% solution by reacting barium dithiophosphate with the stoichiometric quantity of H_2SO_4 , followed by hydrolysis of the resulting dithiophosphoric acid to monothiophosphoric acid.

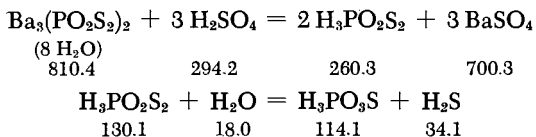

A 68.5-g. portion of barium dithiophosphate (see p. 571) is added to 50 ml. of H_2S water, saturated at 0°C ; the exact quantity of 1 N H_2SO_4 required by the analysis of the barium salt for precipitation of all the Ba (about 500 ml.), is rapidly dripped in, with ice cooling and vigorous stirring. The precipitated BaSO_4 is quickly centrifuged off and the solution is freed of H_2S in vacuum while cooling with ice. To convert the $\text{H}_3\text{PO}_2\text{S}_2$ into $\text{H}_3\text{PO}_3\text{S}$ hydrolytically, the solution is permitted to stand in ice for 12 hours. After this, the fresh quantity of H_2S produced by the hydrolysis is removed in vacuum. To concentrate the acid solution, which is about 3.5% at this point, the material is evaporated in high vacuum, using a ground-joint apparatus. The round-bottom flask containing the acid is constantly maintained at 0°C . The distilled water, which contains only traces of H_2S , is collected in a trap at -79°C . The residue is about 16 g. of oily liquid containing about 84% $\text{H}_3\text{PO}_3\text{S}$.

PROPERTIES:

If the concentrated acid is stored in a refrigerator at -2°C , with exclusion of air, it remains clear. Introduction of air causes turbidity because of the precipitation of S due to oxidation of the H_2S which results from the gradual hydrolysis of monothiophosphoric acid. Heating the concentrated acid to 50°C , results in vigorous liberation of H_2S . The acid is a vitreous solid at -60°C .

REFERENCE:

R. Klement. Z. anorg, allg. Chem. 253, 242 (1947).

Sodium Monothiophosphate



Sodium monothiophosphate can be prepared in several ways. The oldest procedure is that of Wurtz (I) and is based on the hydrolysis of PSCl_3 with NaOH . This procedure gives a very good yield.

A different method, reported by Kubierschky (II), uses P_2S_5 , which is converted to a mixture of various sodium thiophosphates of sodium hydroxide. After isolation, the sodium thiophosphates are converted, by heating to 90°C in aqueous solution, into sodium monothiophosphate, which is then precipitated (see the first equation under monothiophosphoric acid, page 568). A very elegant method which gives an excellent yield was reported by Zintl and Bertram (III). This procedure is based on the addition of anhydrous sodium sulfide to anhydrous sodium trimetaphosphate (see page 552) at temperatures ranging from 500 to 750°C .

I. WURTZ PROCEDURE

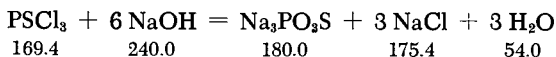

A quantity of PSCl_3 (70 g.) is refluxed with a solution of 120 g. of NaOH in 400 ml. of water until all the PSCl_3 has dissolved. After partial cooling, 100 ml. of alcohol is added and the mixture is thoroughly cooled in ice. The crude salt (approximately 125 g.) is dissolved in 90 ml. of water at a temperature not exceeding 50°C and, after filtration, the solution is gradually cooled, to ice temperature. The yield is 100 g. of analytically pure salt.

II. KUBIERSCHKY PROCEDURE

A solution of 100 g. of NaOH in 500 ml. of water is mixed with small portions of 100 g. of technical P_2S_5 . The temperature of the mixture must not exceed 50°C . After filtration, 200 ml. of alcohol is added to the yellow solution, which is then cooled in ice. After several hours the precipitated salt is suction-filtered, washed (first with 50%, then with pure alcohol) and air-dried. The yield is approximately 220 g. of crude salt. This is then dissolved in 700 ml. of water. The solution is heated to approximately 70°C until the onset of vigorous evolution of H_2S . The solution is then

immediately cooled to 60°C and kept at that temperature for 10 minutes to liberate the H₂S. Then, 200 ml. of alcohol is added and the solution is cooled as rapidly as possible to ice temperature. The crude Na₃PO₃S is recrystallized as in method (I). It is not easy to recognize the end point of the hydrolysis of the various initial thiophosphates to the monothiophosphate. In addition it is desired to prevent the process from continuing until orthophosphate is formed. There, a single recrystallization is sometimes insufficient and the material must be crystallized several times to obtain the analytically pure salt. For this reason, the yield varies.

III. ZINTL AND BERTRAM PROCEDURE

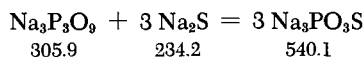

A mixture of Na₃P₃O₉ and carefully dehydrated Na₂S, in the same ratio as in the above equation, is fused at 500 to 750°C. The mixture is placed in a carbon crucible and the fusion proceeds either in a stream of N₂ or H₂, or in vacuum. The gray to yellow product contains up to 85% of anhydrous Na₃PO₃S. Solution of the melt in water and crystallization produces the dodecahydrate.

PROPERTIES:

Thin, hexagonal flakes that readily effloresce in air. Very readily soluble in hot water; aqueous solutions are strongly alkaline. M.p. 60°C.

REFERENCES:

- I. M. A. Wurtz. Ann. Chim. Phys. [3] 20, 473 (1847).
- II. C. Kubierschky. J. prakt. Chem. [2] 31, 93 (1885).
- III. E. Zintl and A. Bertram. Z. anorg. allg. Chem. 245, 16 (1940).

Sodium Dithiophosphate

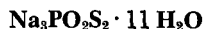

According to Kubierschky, sodium dithiophosphate, is obtained in the same manner as sodium monothiophosphate, i.e., through reaction of P₂S₅ with sodium hydroxide and subsequent hydrolysis of the simultaneously formed higher thiophosphates (see page 569).

A mixture of various thiophosphates is prepared in the manner described on page 569 under (I). The crude salt is dissolved in

water. The solution is heated to 50–55°C and kept at that temperature until a sample of the solution produces a green but not a yellow color on mixing with a CoSO_4 solution. However, it should not be heated to the point where a precipitate of monothiophosphate is formed with CaCl_2 . The $\text{Na}_2\text{PO}_2\text{S}_2$ is then precipitated with alcohol and is recrystallized from water at a temperature not exceeding 40°C.

PROPERTIES:

Formula weight 394.26. Hexagonal prismatic crystals are formed on slow cooling of the aqueous solution; rapid cooling yields needles up to 2 cm. long. M.p. 45–46°C.

REFERENCES:

- C. Kubierschky. J. prakt. Chem. [2] 31, 101 (1885).
E. Steeger and U. Seener. Z. anorg allg. Chem. 303, 21 (1960).

Barium Dithiophosphate

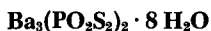

Barium dithiophosphate, required in the preparation of free monothiophosphoric acid, is produced in accordance with the Kubierschky method by precipitation from $\text{Na}_2\text{PO}_2\text{S}_2$ solution with BaCl_2 :

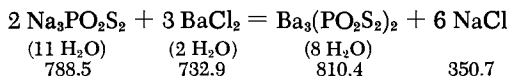

Stoichiometric quantities of the salts are separately dissolved in water, and the BaCl_2 solution is added to the other. The precipitated $\text{Ba}_3(\text{PO}_2\text{S}_2)_2$ is suction-filtered, washed with alcohol and ether or acetone, and air-dried.

REFERENCE:

- C. Kubierschky. J. prakt. Chem. [2] 31, 103 (1885).

Sodium Trithiophosphate

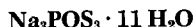

Pure sodium trithiophosphate can be obtained by repeated fractional crystallization of the mixture of thiophosphates obtained from P_2S_5 and NaHS by the Kubierschky method.

A solution of 100 g. of NaOH in 600 ml. of water is saturated with H_2S . Then 60 g. of technical grade P_2S_5 is gradually introduced at a temperature not exceeding $20^\circ C$. The solution is heated at $25^\circ C$ for 10-15 minutes. It is then rapidly filtered and quickly cooled in ice. The salt, precipitated by addition of 200 ml. of alcohol or acetone, is suction filtered, washed successively with a small quantity of ice water, 25% alcohol, 50% alcohol, absolute alcohol and ether, and then air-dried. The yield is approximately 130 g.

The crude salt, with an average S content of 23%, is a mixture of varying quantities of di-, tri-, and tetrathiosphates. The salt is dissolved at $20^\circ C$ in three times its weight of 10% Na_2S solution, and the mixture is cooled in ice. Crystallization begins at approximately $4^\circ C$, but must sometimes be initiated with a few seed crystals of pure sodium dithiophosphate. After about one half hour, the mixture is suction filtered and washed as above (this is fraction 1, about 20 g.). Then 25 ml. of alcohol is added to the mother liquor and the precipitated crystals are suction-filtered after one hour (this is fraction 2, about 50 g.). Fractions crystallized on continued addition of alcohol contain significant quantities of Na_3PS_4 and are therefore discarded. They can sometimes be processed to Na_3PO_3S or $Na_3PO_2S_2$ (see page 569 f.)

Fractions 1 and 2 are combined and crystallized as above. The second fraction thus obtained is generally of such purity that simple recrystallization is sufficient to obtain analytically pure Na_3POS_3 . Should the second fraction (obtained during the second fractional crystallization) turn out to be insufficiently pure, it must be further fractionated. The yield of pure salt is about 30-40 g.

PROPERTIES:

Formula weight 410.32. Crystallizes well; colorless. The least stable sodium thiophosphate. Decomposes slowly when stored at $-2^\circ C$. After one year, one fifth of the salt is converted into $Na_2PO_2S_2$.

REFERENCES:

- C. Kubierschky. J. prakt. Chem. [2] 31, 105 (1885).
R. Klement. Z. anorg. Chem. 253, 254 (1947).

Sodium Tetrathiosphate

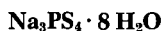

According to Glatzel, sodium tetrathiosphate is produced by treatment of P_2S_5 with Na_2S :

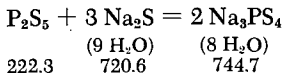

Crystalline $\text{Na}_2\text{S} \cdot 9\text{H}_2\text{O}$ (800 g.) is melted in a large porcelain dish and 80 g. of P_2S_5 is then stirred in. In 10-20 minutes after solution has taken place, 800 ml. of hot water is added and the mixture is rapidly filtered through a large filter. The crude salt that precipitates after the mixture has been left standing for 24 hours is suction-filtered and recrystallized by the Klement method, which proceeds as follows. The salt is dissolved at a temperature not exceeding 10°C in a fivefold quantity of 2% Na_2S solution in the presence of a few ml. of 2N sodium hydroxide. The salt is then precipitated by addition of an equal volume of alcohol, while cooling in ice. This operation must be rapid to prevent decomposition. The salt is washed with 50% alcohol, absolute alcohol and ether, and is then air-dried.

PROPERTIES:

Formula weight 372.34. Monoclinic crystals. Stable when stored in a closed container. Quickly hydrolyzes in aqueous solution (see equation under $\text{H}_3\text{PO}_3\text{S}$ on p. 569).

REFERENCES:

- E. Glatzel. Z. anorg. allg. Chem. 44, 65 (1905).
R. Klement. Z. anorg. allg. Chem. 253, 246 (1947).

Tetraphosphorus Triselenide



According to Mai, tetraphosphorus triselenide is synthesized from the elements in Tetralin solution at 200°C :

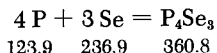

Ground (but not "powdery"!) fused Se (10 g.) is placed in a 100-ml. test tube. Then 50 ml. of Tetralin is added, together with 5 g. of white P wire which has been quickly dried with filter paper. The lower end of the test tube is immersed in a paraffin bath ($215\text{-}220^\circ\text{C}$). As soon as the P melts, the tube contents are mixed with an L-shaped rod until the mass acquires a uniform consistency. The tube is then lowered into the bath so that all the Tetralin is surrounded by the paraffin and begins to boil. At a

point at which frequent stirring no longer produces P vapor, the mixture is filtered hot through glass wool (the funnel in which the glass wool is placed has a very short stem). The product is collected in a well-heated Erlenmeyer flask. The crude product is extracted by boiling twice with 50 ml. of Tetralin. After several hours, long, prismatic crystals separate out of the first filtrate and the extracts. The Tetralin is decanted, since it can be reused. The crude product is washed with alcohol until no further emulsion is produced. (After settling, the alcohol can be decanted and reused.) The crude product is then placed in a filter with fresh alcohol, washed with ether and chloroform, and carefully suction-filtered without, however, permitting it to dry out. It is then extracted in a Soxhlet apparatus with CS_2 . The P_4Se_3 deposits on the tube in a firm crystalline crust. The mother liquor is decanted and the crystals are washed with CCl_4 . A small additional quantity of P_4Se_3 can be obtained from the mother liquor by precipitation with ether. Recrystallization from benzene yields long, transparent, almost odorless needles. The product must be stored in a desiccator. The yield is approximately one third of theoretical.

PROPERTIES:

Long, yellow to red-orange needles which evolve H_2Se in air. Soluble in cold CS_2 ; soluble in warm chloroform, carbon tetrachloride, acetone, benzene and toluene. M.p. 242°C , b.p. $360\text{--}400^\circ\text{C}$.

REFERENCE

J. Mai. Ber. dtsch. chem. Ges. 61, 1807 (1928).

Triphosphorus Pentanitride



According to Stock and Hoffman, triphosphorus pentanitride is prepared by heating $\text{P}_2\text{S}_5 \cdot 7\text{NH}_3$ to bright red heat in a stream of NH_3 or H_2 . According to Moureu and De Ficquelmont, the compound can also be formed by heating $(\text{PNCl}_2)_n$ (see p. 575) at 825°C in a stream of NH_3 . Both reactions involve several intermediate steps.

I. The addition compound $\text{P}_2\text{S}_5 \cdot 7\text{NH}_3$, formed at -20°C by treating P_2S_5 (see p. 567) with gaseous, dry NH_3 , is gradually heated in a stream of NH_3 to 230°C , followed by careful heating in a stream of H_2 or N_2 to a higher temperature. First, $(\text{NH}_4)_2\text{S}$ is liberated, then P and S are evolved, and after heating to bright red heat only P_3N_5 remains. To remove the last traces of S, the heat must be

increased steadily almost to the temperature of decomposition of the P_3N_5 . It is best to use a Pyrex tube, open at both ends, which fits tightly inside an outer Pyrex tube. This is preferred to a porcelain boat since the substance is more exposed to the gas than in the boat. Hydrogen is preferred to nitrogen, since it reduces the extensive decomposition of the product. If the temperature is too high, an odor of NH_3 will be noticeable, an indication that the temperature must be immediately lowered.

II. Some $(PNCl_2)_3$ is heated in a stream of NH_3 . The intermediate chloride-containing phospham evolves HCl in vacuum at $170-180^\circ C$ and is then heated to $600^\circ C$. When the temperature is further increased to $800-825^\circ C$, in a stream of NH_3 , pure P_3N_5 is obtained.

PROPERTIES:

Formula weight 162.96. White, odorless, tasteless; decomposes into its elements in vacuum at high temperature. Insoluble in all solvents. Heating with water in a sealed tube at $180^\circ C$ decomposes P_3N_5 , forming H_3PO_4 and NH_3 . Oxygen affects it (ignition) only at temperatures above $600^\circ C$. d ($18^\circ C$) 2.51.

REFERENCES:

- I. A. Stock and B. Hoffmann. *Ber. dtsch. chem. Ges.* **36**, 317 (1903).
- II. H. Moureu and A. M. de Ficquelmont. *Compt. Rend. Hebd. Séances Acad. Sci.* **198**, 1417 (1934).

Phosponitrilic Chlorides



Phosponitrilic chlorides of varying degrees of polymerization ($n = 3-7$) are formed through reaction of PCl_5 with NH_4Cl at elevated temperatures:

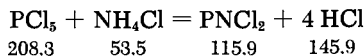

Schenck and Roemer performed the reaction at $135^\circ C$, using tetrachloroethane as the solvent for the PCl_5 . Upon recrystallization from petroleum ether, the crude product is vacuum-distilled, yielding the trimer or tetramer. Audrieth et al. and Steinmann et al. report heating a mixture of the reactants directly to temperatures up to $160^\circ C$, and they describe various separation methods for the different polymers.

I. A mixture of 400 g. of PCl_5 and 120-130 g. of finely powdered, dry NH_4Cl is heated to 135°C in one liter of tetrachloroethane. The round-bottom flask containing the mixture is placed in an oil bath. The flask is equipped with a reflux condenser, the latter having a CaCl_2 tube and a delivery tube. The solution is boiled gently and gradually evolves HCl . Although the main reaction is complete in seven hours, heating is continued for another 13 hours. After cooling, the unreacted NH_4Cl is filtered off and the solvent is distilled at about 11 mm. and 50°C . The initially liquid residue solidifies to a crystalline mass containing traces of an oil and weighing approximately 220 g. This mass is placed in a round-bottom 500-ml. flask equipped with a reflux condenser. It is extracted by boiling 10 minutes with 200-250 ml. of petroleum ether (b.p. $40-60^\circ\text{C}$). This is repeated five or six times. The clear petroleum ether layer is decanted from the oily residue and transferred to a distillation apparatus. The petroleum ether is then distilled off on a water bath. The petroleum ether can be reused for subsequent extractions. To determine when further extraction becomes unnecessary, a glass rod is dipped into the extract, the solvent is allowed to evaporate, and the thickness of the layer of $(\text{PNCl}_2)_n$ ($n = 3, 4$) is observed. Partial evaporation of the petroleum ether solution of $(\text{PNCl}_2)_n$ on a water bath under atmospheric pressure, followed by cooling of the concentrate, produces crystals of the trimer and tetramer. The crystals are suction-filtered, washed with a small quantity of petroleum ether, and separated from adhering liquid by pressing. After drying with filter paper, the crystals are placed in a distillation flask and distilled in vacuum with an oil bath. The flask is immersed in the bath as far as possible. At 10 mm., two fractions are obtained. These boil at 124°C and 185°C . The distillates are separately recrystallized from benzene or chloroform. Approximately 50 g. of the trimer and 15 g. of the tetramer are obtained.

II. Instead of starting with PCl_5 , Schenck and Roemer recommend that an equivalent quantity of PCl_3 be dissolved in tetrachloroethane and the necessary quantity of Cl_2 added. The reaction with NH_4Cl is then carried out.

III. An intimate mixture of 52.1 g. of PCl_5 and 50-100 g. of NH_4Cl is prepared, covered with a 2- to 7-cm. protective layer of NH_4Cl , and heated 4-6 hours in an oil bath at $145-160^\circ\text{C}$. Most of the PNCl_2 trimer sublimes and deposits in the cooler section of the apparatus. The remaining trimer and tetramer are quantitatively extracted with petroleum ether (b.p. $50-70^\circ\text{C}$). The higher homologs are obtained as viscous oils or rubbery materials by treatment of the residue with benzene, chloroform or carbon tetrachloride.

The trimer is distilled from the residue of the petroleum ether solution at 12-14 mm. and 140°C . It is recrystallized from acetic acid. For further purification, it is sublimed at 1 mm. and $100 \pm 5^\circ\text{C}$.

IV. The polymers can also be separated in the following manner. 1) The higher homologs are considerably more soluble in cold benzene than the trimer or the tetramer. 2) The lower homologs are more soluble in anhydrous glacial acetic acid than the higher ones. 3) Only the trimer is carried over in a steam distillation, as the other homologs are hydrolyzed. 4) The trimer and the tetramer can be separated by distillation at reduced pressure (see method I).

PROPERTIES:

The phosphonitrilic chlorides polymerize at temperatures above 255°C. The polymerization is complete after six hours of heating. The infusible, elastic mass formed is completely colorless and transparent. It swells in benzene, forming a colloid. It resists cold acids and alkali, is gradually attacked by boiling water, and, because of substitution of Cl by OH it transforms into cyclic acids. On long exposure to air, the material loses its elasticity and decomposes to a friable mass. The polymers consist of long chain molecules, stretched, frozen samples of which have a fiber pattern similar to that of rubber.

The phosphonitrilic chlorides have an aromatic odor and damage the respiratory organs. The decomposition products cause eye and respiratory difficulties and cause apathy after prolonged exposure. Antidote: Inhalation of NH_3 -containing air.

Audrieth, Steinmann, and Toy give the following data for the homologous phosphonitrilic chlorides:

	Density	M.p., °C	B.p., °C	Crystal system
Trimer	1.98	114	127 (13 mm.) 256 (760 mm.)	rhombic } Lines in which tetragonal } P and N atoms alternate
Tetramer	2.18	123.5	188 (13 mm.) 328.5 (760 mm.)	
Pentamer		40.5 - 41	223 - 224.3 (13 mm.)	} rhombic, chains
Hexamer		90 - 91	261 - 263 (13 mm.)	
Heptamer		-18	289 - 294 (13 mm.)	

According to the same authors, the solubilities in g./100 g. of solvent are as follows:

	Ether	Dioxane	Benzene	Toluene	Xylene	Alkanes	CCl_4	CS_2
Trimer	46.37	29.55	55.01	47.3	38.85	27.9	38.88	52.05
Tetramer	12.4	8.23	21.42	17.8	13.85	8.39	16.55	22

REFERENCES:

- R. Schenck and G. Römer. Ber. dtsch. chem. Ges. 57, 1345 (1924).
 R. Steinmann, F. B. Schirmer and L. F. Audrieth. J. Amer. Chem. Soc. 64, 2377 (1942).
 L. F. Audrieth, R. Steinmann and A. D. F. Toy. Chem. Rev. 32, 109 (1943).

Phosponitrilic Bromides

Phosponitrilic bromides ($n = 3, 4$), discovered by Besson, are obtained, according to Grimme, from a solution of PBr_5 in tetrachloroethene by reaction with NH_4Br :

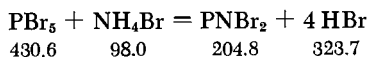

Bode has described the preparation and separation of the homologs in great detail.

A sample of PBr_3 is dissolved in tetrachloroethene and the quantity of Br_2 necessary for its conversion to PBr_5 is added. Following this reaction the stoichiometric quantity of NH_4Br is added. The mixture is heated to the boiling point of the solvent (147°C). At this temperature, PBr_5 decomposes partially, liberating Br_2 , which therefore must be replenished from time to time. After the reaction is complete, the solvent is evaporated and the remaining crystalline slurry is fractionally crystallized from benzene. The solubility of the tetramer (a reaction byproduct) differs only slightly from that of the trimer. A simple separation method consists in slowly evaporating the benzene solution and then separating the characteristically different crystals by manual sorting.

PROPERTIES:

The trimer PNBr_2 forms tabular, well-formed lamellae of the rhombic crystal system. M.p. 191°C . The tetramer forms prismatic crystals which belong to the tetragonal system. M.p. 202°C .

REFERENCES:

- A. Besson. Compt. Rend. Hebd. Séances Acad. Sci. 114, 1479 (1892).
 W. Grimme. Thesis, Münster, 1926 (cited by H. Bode).
 H. Bode. Z. anorg. allg. Chem. 252, 113 (1943).

Monoamidophosphoric Acid



Monoamidophosphoric acid is prepared by the Stokes method. Phenol and POCl_3 are reacted to form the diphenyl ester of monochlorophosphoric acid. The latter is reacted with alcoholic ammonia to give the phenyl ester of monoamidophosphoric acid. Monoamidophosphoric acid is formed on saponification of the ester with KOH . It is isolated as the potassium salt, from which, according to Klement and Becht, free amidophosphoric acid can be obtained by reaction with HClO_4 :

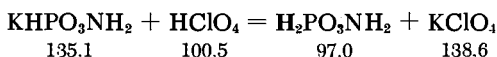
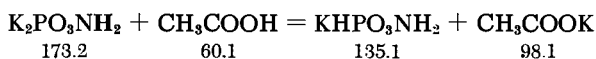
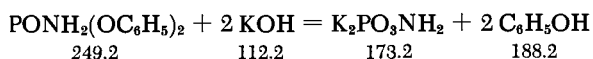
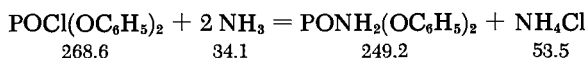
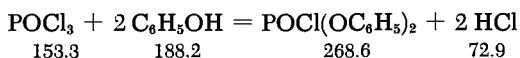

According to Klement, free amidophosphoric acid can also be obtained by reaction of a solution of the acid potassium salt with a cation exchanger that is not too strongly acidic.

A quantity of freshly distilled POCl_3 (154 g.) is refluxed for 2-3 hours with 188 g. of freshly distilled phenol. The product is kept overnight in vacuum over NaOH to remove additional HCl . The oily liquid is added by drops to a minimum of 300 ml. of absolute alcohol, presaturated with NH_3 at 0°C . The reaction flask is ice-cooled and vigorously stirred. The mixture must be ammoniacal at the end of the reaction. The alcoholic solution is poured into five times its volume of ice water. The precipitate of the diphenyl ester of monoamidophosphoric acid is filtered off by suction, freed of adhering oil by pressing on clay, and dried in vacuum. The crude ester (approximately 160 g.) is recrystallized from 200 ml. of alcohol. The yield is approximately 100 g. (m.p. 148°C). An additional 50 g. of impure ester can be obtained by precipitation of the alcoholic mother liquor with water.

Small portions of 125 g. of the ester are gradually added to a hot solution of 140 g. of KOH in 280 ml. of water. The ester dissolves with a vigorous reaction. The saponification is terminated

after boiling for a maximum of five minutes. The mixture is carefully cooled in ice and then acidified with 50% acetic acid. After standing in ice for one hour, the white, crystalline precipitate of KHPO_3NH_2 is suction-filtered and is successively washed with 50% alcohol, absolute alcohol and ether. A small amount of the potassium salt can be recovered from the aqueous phase of the filtrate upon addition of alcohol. The yield is 50 g.

A solution of 13.5 g. of the potassium salt in 125 ml. of ice water is filtered, if necessary, and 100 ml. of 10% HClO_4 is added dropwise, while the flask is cooled in an ice bath. The KClO_4 precipitate is suction-filtered after a short time, and 700 ml. of alcohol is added to the filtrate. After long standing in an ice bath, the $\text{H}_2\text{PO}_3\text{NH}_2$, somewhat contaminated with KClO_4 , is suction-filtered, washed with alcohol and ether, and air dried. The yield is approximately 8 g. The acid is purified by dissolving in 150 ml. water; the filtered solution is precipitated with an equal volume of alcohol, refiltered after standing in an ice bath, and washed as above. The yield of pure acid is 4 g.

To liberate the acid with a cation exchanger, the latter is prepared in accordance with the instructions given on p. 555, and the procedure described there is followed. A solution of 10 g. of KHPO_3NH_2 in 100 ml. of water is added to the resin. After 10 minutes it is decanted and the resin is rinsed with 50-ml. and 25-ml. portions of pure water. The filtered and combined solutions are then precipitated with 600 ml. of alcohol. The yield of free $\text{H}_2\text{PO}_3\text{NH}_2$ is 5 g. (about 60% of theoretical) of comparatively pure material. It can be further purified by reprecipitation as above.

Other Preparative Method: The Adams procedure may be used for hydrogenation of $\text{PO}(\text{NH}_2)(\text{OC}_6\text{H}_5)_2$ with platinum oxide; this easily yields $\text{H}_2\text{PO}_3\text{NH}_2$ (M. Becke-Goehring and J. Sambeth): $\text{PO}(\text{NH}_2)(\text{OC}_6\text{H}_5)_2 + 16 \text{H} = \text{H}_2\text{PO}_3\text{NH}_2 + 2\text{C}_6\text{H}_{12}$. In the presence of 200 mg. of platinum oxide, five grams of $\text{PO}(\text{NH}_2)(\text{OC}_6\text{H}_5)_2$, dissolved in 100 ml. of anhydrous methanol, absorb approximately 95% of the calculated quantity of hydrogen in 10 to 15 hours. Toward the end of the reaction, another 200 g. of platinum oxide is added. The free acid, along with the platinum, is carefully filtered by suction through a compact filter. The acid is washed with methanol without coming in contact with the air. The acid is dissolved on the filter with as little water as possible and is then precipitated with ethanol. After standing in an ice bath for one hour, the acid is suction-filtered and washed with acetone and ether. The yield is 1 g (51%). This procedure may also be employed to produce other substituted phosphoric acids.

PROPERTIES:

Exists only in the anhydrous form. Colorless, prismatic crystals, easily soluble in water. The aqueous solution hydrolyzes, forming

$\text{NH}_4\text{H}_2\text{PO}_4$. It is therefore impossible to obtain completely pure $\text{H}_2\text{PO}_3\text{NH}_2$ (Klement and Hille). Rapidly hydrolyzes on boiling the solution in the presence of dilute sulfuric acid. Stable in sealed ampoules. Produces a white, crystalline precipitate with AgNO_3 . Heating of the free acid to 110°C yields an ammonium polyphosphate (Goehring and Sambeth).

REFERENCES:

- N. H. Stokes. Amer. Chem. J. 15, 198 (1893).
 R. Klement and K. -H. Becht. Z. anorg. allg. Chem. 254, 217 (1947).
 R. Klement. Z. anorg. allg. Chem. 260, 267 (1949).
 R. Klement and V. Hille. Z. anorg. allg. Chem. 289, 89 (1957).
 M. Goehring and J. Sambeth. Chem. Ber. 90, 232 (1957).
 M. Becke-Goehring and J. Sambeth. Chem. Ber. 90, 2075 (1957);
 Angew. Chem. 70, 594 (1958).

Disodium Monoamidophosphate

Disodium monoamidophosphate is formed on saponification of the diphenyl ester of monoamidophosphoric acid (see p. 579) with the stoichiometric quantity of NaOH (Klement and Biberacher):

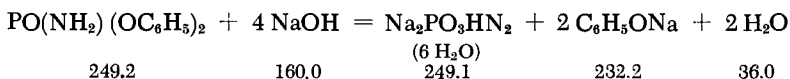

A 25-g. quantity of the diphenyl ester of monoamidophosphoric acid is boiled in a solution of 16 g. of NaOH in 60 ml. of water for 10 minutes. Crystallization of the salt commences on cooling the clear solution to 0°C . This is aided by addition of ice-cold ethanol (200 ml. is needed for complete precipitation). The $\text{Na}_2\text{PO}_3\text{NH}_2 \cdot 6\text{H}_2\text{O}$ obtained is already quite pure. To reprecipitate, or to obtain larger crystals, it is dissolved in a small quantity of water together with pellets of NaOH. Then ethanol is added to the filtered solution at room temperature. While the salt initially precipitates as an oily substance, larger crystals are formed after brief stirring. The crystals are washed with ethanol and ether and dried in vacuum. The yield is 20 g.

PROPERTIES:

The salt effloresces in air and is simultaneously decomposed by CO_2 . Therefore it must be stored in airtight containers. Readily soluble in water.

REFERENCE:

R. Klement and G. Biberacher. *Z. anorg. allg. Chem.* **283**, 246 (1956).

Diamidophosphoric Acid

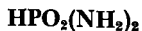

In the Stokes method (I), the synthesis of diamidophosphoric acid starts from the phenyl ester of dichlorophosphoric acid obtained from POCl_3 and phenol. This is converted with aqueous NH_3 to the phenyl ester of diamidophosphoric acid. This ester is then saponified with $\text{Ba}(\text{OH})_2$; the Ba^{2+} is precipitated as BaCO_3 , and the silver salt of diamidophosphoric acid is then obtained by precipitation with AgNO_3 . After reprecipitation of the silver salt, treatment with HBr results in very pure, free diamidophosphoric acid. The phenyl ester of diamidophosphoric acid can also be saponified with potassium hydroxide, and after acidification with acetic acid, the free diamidophosphoric acid can be precipitated with ethanol, yielding a somewhat less pure product (method II).

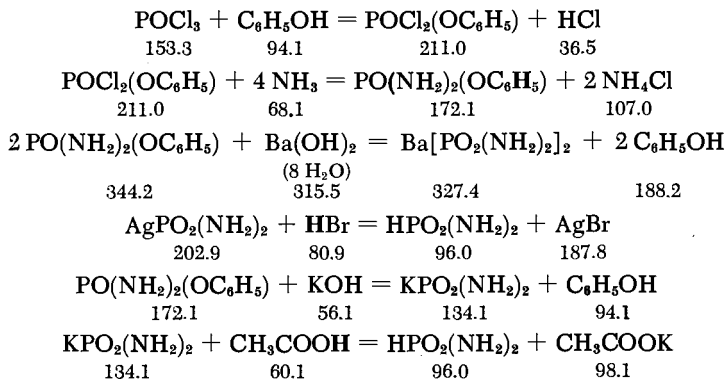

A mixture of 95 g. of freshly distilled phenol and 160 g. of freshly distilled POCl_3 is refluxed until HCl evolution ceases (about eight hours). The product is distilled at 14 mm. and the fraction boiling at 115–120°C is collected. The oily liquid (approximately 180 g.) is added dropwise to 750 ml. of ice-cold, vigorously stirred concentrated ammonia. The precipitated phenyl ester of diamidophosphoric acid is rapidly filtered off, washed with ice water and dried on clay plates. A quantity (70–80 g.) of the crude ester is recrystallized twice from 1000–1250 ml. of 95% ethanol. The m.p. of the pure ester is 188°C.

I. In this method not more than 30 g. of the phenyl ester of diamidophosphoric acid should be used per run since otherwise the yield of silver salt will diminish. One part of ester is boiled for 10 minutes with two parts of $\text{Ba}(\text{OH})_2 \cdot 8 \text{H}_2\text{O}$ and ten parts of water. After cooling, CO_2 is bubbled through until a neutral reaction is obtained, and the BaCO_3 precipitate is immediately filtered off. The filtrate is treated with a 10% AgNO_3 solution until no further precipitate is formed. The supernatant is decanted through a filter, the silver residue is suspended in 150-200 ml. of water, and ammonia is added until the solution acquires a definite ammonia odor. Disregarding the incomplete solution, nitric acid (1:1) is added dropwise without intermediate filtration until a pH of 7. At this point, the solution is filtered through a fritted glass filter and the precipitate is discarded. Dropwise addition of nitric acid to the filtrate is continued until complete precipitation of pure primary silver diamidophosphate. The latter appears curdy at first, but soon assumes a crystalline form. No excess nitric acid should be used, because part of the silver salt may dissolve. The salt is filtered by suction, washed with ethanol and dried in vacuum. The yield is 20 g.

A 10-g. sample of $\text{AgPO}_2(\text{NH}_2)_2$ is suspended in 50 ml. of water. Hydrobromic acid (57%) is added in drops to the stirred solution until complete reaction is achieved (0.44 ml. of acid per gram of silver salt). The silver bromide is filtered off and 150 ml. of ethanol is gradually added to the filtrate. Crystalline $\text{HPO}_3(\text{NH}_2)_2$ precipitates after brief ice cooling. The crystals are suction-filtered, washed with 70% ethanol and dried in vacuum. The yield is 3.5 g.

II. A mixture of 30 g. of the phenyl ester of diamidophosphoric acid and a hot solution of 30 g. of KOH in 30 ml. of water is kept boiling for five minutes. It is then cooled in ice, and a mixture of 30 g. of acetic acid and 10 ml. of water is added, followed by 300 ml. of ethanol. The distinctly acid solution is allowed to stand in ice for a while, and the precipitate of diamidophosphoric acid is suction-filtered and washed with ethanol and ether. Upon drying in air, a yield of 11 g. is obtained (65%, based on the ester). To purify, the acid is dissolved in a small amount of water and reprecipitated with ethanol.

Alternate Method: When 5.1 g. of $\text{PO}(\text{NH}_2)_3$ (see below) is heated on a water bath with 100 ml. of 10% sodium hydroxide for two hours, the following reaction takes place: $\text{PO}(\text{NH}_2)_3 + \text{NaOH} = \text{NH}_3 + \text{NaPO}_2(\text{NH}_2)_2$. The cooled solution is mixed with 20% perchloric acid until a pH of 6 is reached and the silver salt is precipitated with 10% AgNO_3 solution; the salt is then treated as outlined in method I. [R. Klement and O. Koch, Ber. dtsh. chem. Ges. 87, 333 (1954)].

PROPERTIES:

Colorless, hexagonal stars, prisms or short needles. More stable than the monoamidophosphoric acid; however, is transformed into ammonium hydrogen monoamidophosphate if exposed to air for several months: $\text{HPO}_2(\text{NH}_2)_2 + \text{H}_2\text{O} = \text{NH}_4\text{HPO}_3\text{NH}_2$. Thus, it must be stored in sealed glass ampoules. Liberates CO_2 from carbonates in the cold. Over an eight-hour period, $\text{NH}_4\text{HPO}_3\text{NH}_2$ is formed in the aqueous solution of the free acid. After 24 hours, this is transformed to $(\text{NH}_4)_2\text{HPO}_4$. M.p. $\sim 100^\circ\text{C}$ (dec.).

REFERENCES:

- I. R. Klement, G. Biberacher and V. Hille. Z. anorg. allg. Chem. 289, 80 (1957).
- II. N. H. Stokes. Amer. Chem. J. 16, 123 (1894).

Phosphoryl Triamide

I. Phosphoryl triamide can be prepared via reaction of NH_3 with a well-cooled chloroform solution of POCl_3 (Wetroff):

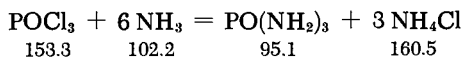

To separate the products, the NH_4Cl is reacted with diethylamine to yield NH_3 and diethylammonium chloride, which is soluble in CHCl_3 :

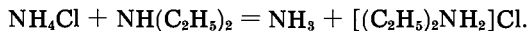

The unreacted $\text{PO}(\text{NH}_2)_3$, which is insoluble in CHCl_3 , is recrystallized from methanol (Klement and Koch).

A three-neck, two-liter flask is provided with a mercury-seal stirrer, a cooled dropping funnel (see Fig. 198) and a ground glass cap with an inlet and a connecting tube. The latter is attached to a drying tube filled with solid NaOH . The flask is filled with 1.5 liters of freshly distilled and CaCl_2 -dried CHCl_3 and is cooled in an ice-salt mixture to -15°C . Then a fast stream of well-dried NH_3 is bubbled through for three hours, until the CHCl_3 is fully saturated. The cooling jacket of the dropping funnel is then filled with ice-salt mixture and the funnel itself is filled with a solution of 60 g. (37 ml.) of freshly distilled POCl_3 in 100 ml. of CHCl_3 . The ammonia solution is stirred as vigorously as possible; it is chilled

to -15°C and kept at that temperature with very efficient cooling, and the POCl_3 is added dropwise over a period of two hours, while continuing the passage of NH_3 . Slow bubbling of NH_3 is continued for another hour. The cold bath is then removed, the mixture is allowed to stand overnight, and the precipitate is rapidly suction-filtered. It is washed with dry CHCl_3 and dried in vacuum. The yield is 100 g.

The product is mixed with 225 ml. of dry CHCl_3 and 160 g. (230 ml.) of diethylamine and heated four hours at 60°C in a flask equipped with a reflux condenser. Higher temperatures should be avoided because decomposition will occur. Then 200 ml. of CHCl_3 is added and the $\text{PO}(\text{NH}_2)_3$ product is filtered off. It is washed with dry CHCl_3 until both product and wash liquid no longer give a positive chloride test; the product is then dried in vacuum. The yield is 34 g.

To recrystallize the crude product, it is heated on a water bath with 150 ml. of absolute methanol in the complete absence of moisture. The solution is filtered hot and the pure $\text{PO}(\text{NH}_2)_3$, which precipitates on cooling, is suction-filtered. The mother liquor is discarded because it still contains some chloride. The undissolved crude product remaining is then treated in a similar manner with 200 ml. of absolute methanol. The mother liquor from this crystallization is reused for dissolving and recrystallizing the remainder of crude product, a procedure that requires repetition of the above steps up to three times. The combined crystals are dried in vacuum. The product is chromatographically pure. The yield is 26 g. (70%, based on POCl_3).

II. According to Goehring and Niedenzu, $\text{PO}(\text{NH}_2)_3$ can be obtained from POCl_3 via direct reaction with liquefied NH_3 . The apparatus shown in Fig. 199 is used. Tube a is half filled (by condensation) with 100-150 ml. of well-dried, pure NH_3 . Then h_1 is closed, while h_2 remains open. However, a drying tube filled with KOH is attached at h_2 to protect a against atmospheric moisture. The temperature is reduced to -80°C and the POCl_3 is slowly forced with well-dried compressed N_2 from the dropping funnel into a . Throughout this process, h_3 remains closed. After 20-40 g. of POCl_3 has been added, the dropping-funnel stopcock is closed, tube b is evacuated via h_5 to approximately 3 mm., h_2 is closed and tube b is cooled to -80°C . The cooling bath is then removed from tube a , and h_3 and h_4 are opened. Within one minute, the liquid from a begins to flow through h_3 , s and h_4 into tube b . The frit f in tube a retains the already quite pure $\text{PO}(\text{NH}_2)_3$, while most of the NH_4Cl remains dissolved in the NH_3 and is transferred into b . Stopcocks h_3 and h_4 are again closed and h_6 is connected to h_2 . The cooling bath is removed from tube b and transferred to tube a . Stopcocks h_5 and h_2 are again opened and the NH_3 is again condensed in a . Then h_2 and h_6 are closed and the filtration is repeated. This procedure is

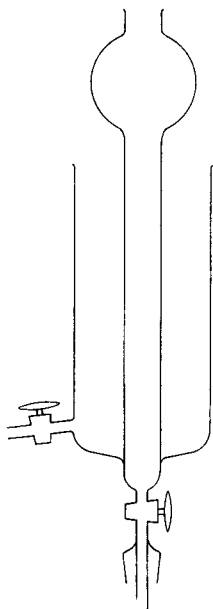

Fig. 198. Cooled dropping funnel for preparation of $\text{PO}(\text{NH}_2)_3$. The upper bulb has a capacity of 50 ml.; the inner tube has a diameter of 2 cm. The outer cooling jacket has a diameter of 7 cm. and is 15 cm. high.

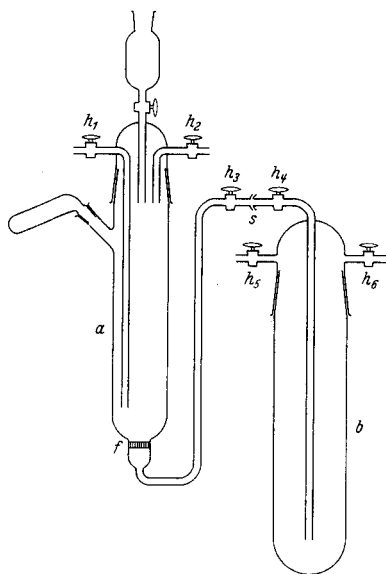

Fig. 199. Preparation of phosphoric acid amides according to Goehring and Niedenzu. *a*) reaction tube; *b*) condensation trap and storage tube; *f*) glass frit; h_1 - h_2) stopcocks; *s*) ball and socket joint.

repeated five times. Finally, h_3 is closed and dry N_2 is passed through h_1 and h_2 into *a*, which is then heated on a water bath to remove residual NH_3 . The pure $\text{PO}(\text{NH}_2)_3$ can be removed from *a* by shaking. The yield is 94%.

PROPERTIES:

Colorless crystals, probably belonging to the monoclinic system. Insoluble in ethanol, readily soluble in methanol, very readily in water. However, the aqueous solution is unstable because it converts to orthophosphate via amidophosphates. Heating with sodium hydroxide produces diamidophosphate (see p. 583).

Introduction of HCl into a -15°C suspension of $\text{PO}(\text{NH}_2)_3$ in ether produces imidodiphosphoric acid tetramide $(\text{NH}_2)_2\text{P}(\text{O})\text{-NH-P}(\text{O})(\text{NH}_2)_2$; diimidotriphosphoric acid pentamide $(\text{NH}_2)_2\text{P}(\text{O})\text{-NH-P}(\text{O})(\text{NH}_2)\text{-NH-P}(\text{O})(\text{NH}_2)_2$ is formed at 30°C . Both substances are formed when $\text{PO}(\text{NH}_2)_3$ is heated to 120°C in toluene. In moist air, $\text{PO}(\text{NH}_2)_3$ converts within a few weeks to ammonium hydrogen monoamidophosphate. Thus, it must be stored in sealed glass vessels. With POCl_3 , forms a chlorine-containing intermediate which, after treatment with NH_3 , yields the amide-imide of orthophosphoric acid $[\text{H}_2\text{N-P}(\text{O})\text{NH}]_n$.

REFERENCES:

- I. G. Wétroff. Thesis, Paris, 1942; R. Klement and O. Koch. Chem. Ber. 87, 333 (1954).
- II. M. Goehring and K. Niedenzu. Chem. Ber. 89, 1768, 1771, 1774 (1956).

Thiophosphoryl Triamide



I. Thiophosphoryl triamide is obtained similarly to phosphoryl triamide (see p. 584) via reaction of NH_3 and PSCl_3 in chloroform solution. The reaction flask must be well cooled (Klement and Koch):

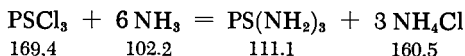

The products are separated with diethylamine.

The apparatus of Fig. 198 is used. A solution of 60 g. of freshly distilled PSCl_3 in 100 ml. of CHCl_3 is added by drops to a solution of NH_3 in CHCl_3 ; the addition time is two hours, and vigorous stirring and efficient cooling to maintain the temperature at -15°C are imperative. Further procedure is the same as given in method I for phosphoryl triamide. The product (approximately 105 g.) is treated with 225 ml. of dry CHCl_3 and 100 g. of diethylamine. The yield of crude $\text{PS}(\text{NH}_2)_3$ is approximately 32 g. Recrystallization from methanol is effected in the same way as for $\text{PO}(\text{NH}_2)_3$, but instead of 150 or 200 ml., 100-150 ml. of solvent is used due to the greater solubility here. The yield is 26 g. (66%).

II. According to Goehring and Niedenzu, $\text{PS}(\text{NH}_2)_3$ can also be produced through direct reaction of PSCl_3 with liquid NH_3 in the manner described in method II for $\text{PO}(\text{NH}_2)_3$, using the apparatus shown in Fig. 199. The Klement and Koch procedure (diethylamine) is used to separate the products. The yield is 96%.

PROPERTIES:

Colorless rhombic crystals. Insoluble in ethanol, readily soluble in methanol, very readily in water. Heating with sodium hydroxide produces sodium diamidomonothiophosphate: $\text{PS}(\text{NH}_2)_3 + \text{NaOH} = \text{NaPOS}(\text{NH}_2)_2 + \text{NH}_3$. Forms diammonium hydrogen monothiophosphate on standing in moist air for several weeks: $\text{PS}(\text{NH}_2)_3 + 3\text{H}_2\text{O} = (\text{NH}_4)_2\text{HPO}_3\text{S} + \text{NH}_3$. Therefore, it must be sealed in glass for storing.

REFERENCES:

- I. R. Klement and O. Koch. Chem. Ber. 87, 333 (1954).
- II. M. Goehring and K. Niedenzu. Chem. Ber. 89, 1768 (1956).

Pyrophosphoryl Tetramide

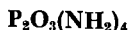

Pyrophosphoryl tetramide is produced from pyrophosphoryl tetrachloride and NH_3 in chloroform solution:

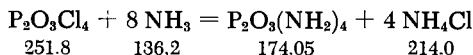

When the reaction product is treated with liquid NH_3 , pure $\text{P}_2\text{O}_3(\text{NH}_2)_4$ is obtained (Klement and Benek, Goehring and Niedenzu). I. The apparatus of Fig. 198 is used. A solution of 8 g. of $\text{P}_2\text{O}_3\text{Cl}_4$ in 20 ml. of CHCl_3 is added in drops, with stirring and cooling, to a solution of NH_3 in 750 g. of dry CHCl_3 . The procedure described above (p. 584) is then followed and the reaction product is suction-filtered in the absence of air. The product is washed with dry CHCl_3 and is dried in vacuum. The apparatus shown in Fig. 71, p. 88, may be used for extraction with liquid NH_3 . The yield is 75%.

II. As in the method of Goehring and Niedenzu, 25 g. of $\text{P}_2\text{O}_3\text{Cl}_4$ is treated with 150 ml. of dry liquid NH_3 in the apparatus of Fig. 199. Slow dropwise addition of $\text{P}_2\text{O}_3\text{Cl}_4$ is necessary as a water insoluble substance will be otherwise formed. The product mixture is worked up in the same apparatus. The yield is 89%.

PROPERTIES:

Colorless crystals, readily soluble in water, giving a weakly acidic reaction. Diammonium diamidopyrophosphate is formed on exposure to moist air and solution in water:

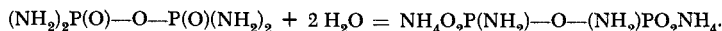

REFERENCES:

- R. Klement and L. Benek. Z. anorg. allg. Chem. 287, 12 (1956).
 M. Goehring and K. Niedenzu. Chem. Ber. 89, 1771 (1956).

Tetrasodium Imidodiphosphate

When anhydrous disodium monoamidophosphate is heated in vacuum to 210°C, anhydrous tetrasodium imidodiphosphate is formed (Klement and Biberacher):

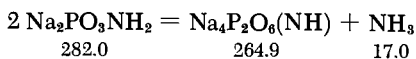

For a good yield, the $\text{Na}_2\text{PO}_3\text{NH}_2$ must be completely anhydrous. The freshly produced salt containing water of crystallization (see p. 581) is first stored in a vacuum desiccator over NaOH or CaCl_2 at room temperature for two days. Then the CaCl_2 is replaced with P_2O_5 and the desiccator is sealed with a lubricant that is little affected by temperature changes, such as a silicone grease. The desiccator is evacuated and placed in an oven, which is then heated to 70°C for six hours. The desiccator is left to stand for three days and the P_2O_5 is replenished as necessary. If the desiccator is tightly sealed, a completely dry substance is obtained.

Absolutely anhydrous $\text{Na}_2\text{PO}_3\text{NH}_2$ (10–15 g.) is weighed into a 50-ml. ground-joint flask. The flask is connected to a high-vacuum system (oil pump) with a stopcock and a trap with solid NaOH interposed. The flask is evacuated and gradually heated to 80°C. This temperature is maintained for six hours to remove any residual water. The temperature is then raised; the rising pressure indicates liberation of NH_3 . Evacuation is repeated more frequently and the temperature is raised to 210°C. Gas evolution gradually subsides and ends after seven days. To purify the crude $\text{Na}_4\text{P}_2\text{O}_6\text{NH}$, a 10-g. sample is gradually added to 100 ml. of ice-cold 0.1N NaOH. The clear solution, heated to about 10–15°C by the exothermic hydration, is immediately fractionally precipitated with ice-cold acetone, as shown in the scheme below:

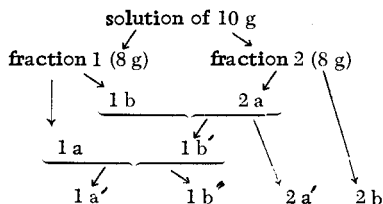

Fraction 1 a' is discarded and the three fractions 1 b'', 2 a' and 2 b are combined. They contain pure $\text{Na}_4\text{P}_2\text{O}_6\text{NH} \cdot 10\text{H}_2\text{O}$. The crystals are washed with acetone and dried in air.

PROPERTIES:

Formula weight ($\text{Na}_2\text{O}_3\text{P-NH-PO}_3\text{Na}_2 \cdot 10\text{H}_2\text{O}$) 445.13. Colorless crystals, readily soluble in water. Isomorphous with $\text{Na}_4\text{P}_2\text{O}_7 \cdot 10\text{H}_2\text{O}$. A 0.1 M aqueous solution has a pH of 11. On boiling, decomposition to monoamidophosphate and orthophosphate takes place: $\text{Na}_4\text{PO}_6\text{NH} + \text{H}_2\text{O} = \text{Na}_2\text{PO}_3\text{NH}_2 + \text{Na}_2\text{HPO}_4$. Orthophosphate is quantitatively formed in acid solution. Heating for seven days in vacuum at 450°C produces sodium nitrilotriphosphate:

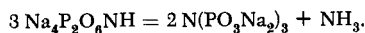

REFERENCE:

R. Klement and G. Biberacher. Z. anorg. allg. Chem. 283, 246 (1956).

Arsenic, Antimony, Bismuth

P. W. SCHENK

Arsenic**As**

VERY PURE ARSENIC

Very pure, antimony-free arsenic is produced from magnesium ammonium arsenate. A solution of arsenic acid is mixed with chemically pure $MgCl_2$ and ammonia is slowly added. The initial precipitate is discarded and the middle fractions are collected. Then the material is repeatedly dissolved and precipitated in a similar fashion, the number of such treatments depending upon the purity of the starting materials. In each case, the first and last fractions are discarded. After final washing, the material is dried. The magnesium ammonium arsenate thus obtained is mixed with sugar charcoal; pure As is sublimed from the mixture by heating, preferably in vacuum.

De Passillé recommends that ammonium arsenate be reduced in an ammonia stream at $1000^\circ C$. According to Geach, very pure As can also be obtained by reduction of chemically pure As_2O_3 with Zr metal and subsequent sublimation. Impurities other than Sb can be removed by sublimation in vacuum (Geach).

PROPERTIES:

M.p. 817° (under pressure), b.p. 633° ; d. 5.78. Rhombohedral crystals with a gray metallic luster. Brittle. Hardness (Mohs) 3.5.

REFERENCES:

- N. A. Orlow. *Chem. Ztg.* 25, 290 (19-1).
 G. G. Reissaus. *Z. Angew. Chem.* 44, 959 (1931).
 A. de Passillé. *Comptes Rendus Hebd. Séances Acad. Sci.* 198, 1781 (1934).
 R. Suhrmann and W. Berndt. *Z. Physik* 115, 17 (1940).
 W. Trzebiatowski and E. Bryjak. *Z. anorg. allg. Chem.* 238, 255 (1938).
 H. Stöhr. *Z. anorg. allg. Chem.* 242, 138 (1939).

G. A. Geach, R. A. Jeffery and R. J. Shelton. *J. Chem. Soc. (London)* 1950, 1207. [For preparation of single crystals, see P. W. Bridgman, *Proc. Am. Acad.* 68, 27-93, 39 (1932-33).]

YELLOW ARSENIC

Yellow As is formed when the vapor is cooled suddenly. In the Erdmann and Unruh method, the As vapor is added directly to CS_2 , which serves as the solvent, because the yellow form converts to the gray with exceptional ease, particularly in the light. Figure 200 illustrates the apparatus employed. The aluminum tube *a* (wall thickness 3 mm., inside diameter 20 mm., length 1 m.) is wrapped with a 2-mm. thickness of asbestos paper (*b*), which is cemented in place with water glass. A closely fitting, 40-cm. iron tube *e* is pushed over the tube. The end of the Al tube projecting 50 cm. is closed with a one-hole cork and connected to a CO_2 source via a wash bottle containing H_2SO_4 . The other end of the Al tube is reinforced with asbestos and water glass to provide a good seal with the conical aperture of tube *f*, even though that end of the tube is very hot during operation because of the necessity of preventing condensation and consequent plugging with As. Receiver *g* is a 12-cm. I.D. sphere with U tube *f* attached. Dry CO_2 at about -20°C is introduced through a tube adjacent to the thermometer. The receiver stands in ice-water bath and holds about 300 ml. of CS_2 . A second and a third receiver, identical but containing only about 100-120 ml. of CS_2 each, are connected in line with the first. All three vessels are placed in the ice-water bath, which is covered to exclude light. The level of ice water must extend above the conical connection of tube *f*. The Al tube is charged with pure As

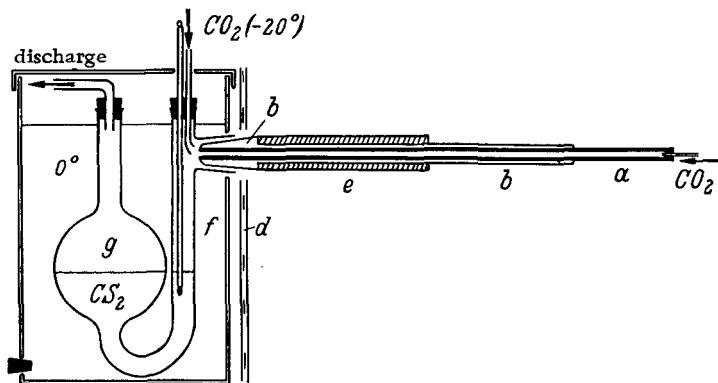

Fig. 200. Preparation of yellow arsenic. a) Aluminum tube; b) asbestos insulation; d) asbestos paper heat insulation; f) inlet tube; g) receiver.

and brought to low red heat by a gas flame or an electric furnace. The thin oxide layer on the As is immediately removed by heating the material in a stream of CO_2 . Then an additional CO_2 stream is admitted through the aluminum tube. Thus, the As vapor which distills over is cooled with the -20°C CO_2 and is immediately absorbed in the cold CS_2 . The solution is filtered and concentrated on a water bath, to about half the original volume. It is then evaporated to saturation in a large diameter test tube. Finally, it is cooled to -70°C in a Dry Ice-acetone bath, whereupon the As precipitates. The supernatant liquid is decanted and the As is dried in vacuum. All the operations, particularly those with the concentrated solutions, must be performed as far as possible in the absence of light. About 12 g. of yellow arsenic is obtained from the solution in the first receiver and another 4 g. from the second. There is none in the third.

PROPERTIES:

Yellow powder, converting to gray As in less than one minute when exposed to sunlight. Soluble in CS_2 . Cubic crystals. *d.* (20°C) 1.97.

Solubility in 100 ml. of CS_2

Temperature, $^\circ\text{C}$:	+ 46	+ 18 to 20	+ 12	0	- 15	- 60 to - 80
Yellow As, g.:	11	7.5—8	5.5—6	3.8—4	2—2.5	0.8—1.0

REFERENCES:

- H. Erdmann and M. von Unruh. *Z. anorg. allg. Chem.* **32**, 439 (1902).
 A. Stock and W. Siebert. *Ber. deutsch. chem. Ges.* **37**, 4572 (1904); **38**, 966 (1905).
 V. Kohlschütter, E. Frank and C. Ehlers. *Liebigs Ann. Chem.* **400**, 268 (1913).
 G. Linck. *Z. anorg. allg. Chem.* **56**, 393 (1908).

Arsine

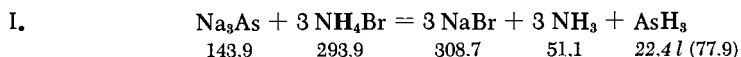

The reaction is run in liquid NH_3 , using the reactor illustrated in Fig. 201. First the required amount of Na is placed in *a* and dry NH_3 is condensed over it. The required amount of powdered As is then added. By turning and tapping the bulb, dry NH_4Br , which has

been weighed into the flask at the right, is added to a. The evolving gas is scrubbed with water, dried with P_2O_5 , and condensed in a trap cooled with liquid nitrogen. It can be purified by vacuum distillation in the apparatus used for SbH_3 (p. 599, Fig. 203, or Part I, p. 67).

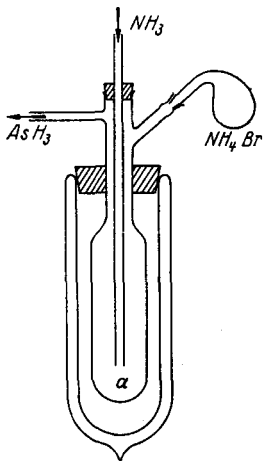
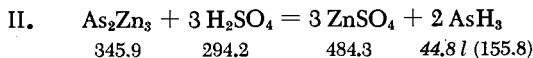
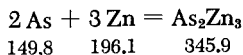

Fig. 201. Preparation of arsine.



To obtain the required zinc alloy, an intermediate alloy is first prepared by fusing the quantity of Zn computed from



in a closed crucible, to which a portion of the As is added. After cooling, the alloy is pulverized, the rest of the As is added, and the fusion in the closed crucible is repeated. After cooling and grinding, the alloy is placed in a reaction flask equipped with a dropping funnel and a ground joint.

The air is displaced with a stream of H_2 , and boiled 30% H_2SO_4 is then added drop-by-drop. The gas thus generated contains only 0.5% impurities. It is scrubbed with KOH solution, dried with solid KOH and P_2O_5 , and purified by condensation and vacuum distillation at low temperature.

III. Arsine can also be prepared in the familiar manner involving addition of a solution of As_2O_3 in HCl to zinc granules and dilute H_2SO_4 . However, the gas thus generated contains no more than 25% AsH_3 .

IV. In the Nast method, an Mg-Al-As alloy is decomposed with very dilute sulfuric acid. Fractionation of the resulting gases in a Stock vacuum apparatus also permits isolation (even though in a very small quantity) of As_2H_4 (diarsine), an analog of N_2H_4 and P_2H_4 .

V. According to Stone and Burg, treatment of $AsCl_3$ with $LiAlH_4$ in absolute ether gives AsH_3 in a 70% yield.

PROPERTIES:

M.p. -113°C , b.p. -58.5° . Colorless gas and liquid. Exceptionally poisonous. Sensitive to O_2 . Unstable on porous surfaces.

REFERENCES:

A. Reckleben, G. Lockemann and A. Eckardt. *Z. Anal. Chem.* 46, 671 (1907).

- R. Robertson, J. J. Fox and E. Hiscocks. Proc. Roy. Soc. (London) 120, 149 (1928).
 E. Cohen. Z. physik. Chem. 25, 483 (1898).
 A. A. Durrant, T. G. Parson and P. L. Robertson. J. Chem. Soc. (London) 1934, 731; A. O. Rankine and C. J. Smith. Phil. Mag. [6] 42, 608 (1921).
 W. C. Johnson and A. Pechukas. J. Amer. Chem. Soc. 59, 2065 (1937).
 R. Nast. Ber. dtsch. chem. Ges. 81, 271 (1941).
 A. L. G. Rees and K. Stewart. Trans. Farad. Soc. 45, 1028 (1949).
 F. G. A. Stone and A. B. Burg. J. Amer. Chem. Soc. 76, 386 (1954).

Sodium Dihydrogen Arsenide

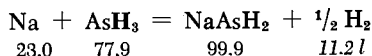

Gaseous arsine is introduced into a solution of sodium in liquid NH_3 at -78°C . The arsine apparatus described in Fig. 201 is employed. Approximately 1 g. of sodium is placed in the side bulb and about 50 ml. of NH_3 is condensed in *a*. Then the Na is added to the NH_3 by rotation of the bulb, and dissolved while the flask is cooled with Dry Ice. A stream of AsH_3 is then introduced, while the flask is still in the cold bath. The solution, initially dark blue, becomes lighter and finally turns yellow. When the color changes, the NH_3 is evacuated. The residue is NH_3 -free NaAsH_2 which appears on the reactor walls as pale-yellow crystals.

Potassium dihydrogen arsenide can be produced in a similar fashion.

Other preparative methods:

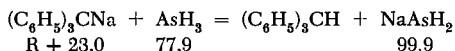

PROPERTIES:

Decomposes rapidly in air, generating heat and leaving a brown residue of unknown composition. Stable in vacuum, in the absence of air. Hydrolyzes in H_2O , forming AsH_3 .

See also the preparation and properties of the analog NaPH_2 .

REFERENCES:

- W. C. Johnson and A. Pechukas. J. Amer. Chem. Soc. 59, 2068 (1937).
 H. Albers and W. Schuler. Ber. dtsch. Chem. Ges. 76, 23 (1943).

Arsenic Trichloride



Pulverized As is placed in a retort with a filler tube or in a boat inserted into a Pyrex tube. Dry Cl_2 is passed over the material. The As usually ignites and burns in the Cl_2 stream. If necessary, the reaction may be initiated by slight heating. A long cooling tube attached to the reaction tube (or to the neck of the retort) delivers the product to a distillation flask serving as receiver. At the end, a small quantity of As powder is added to the distillation flask to bind the dissolved Cl, and the contents are distilled. The material fractionated over As powder is completely pure.

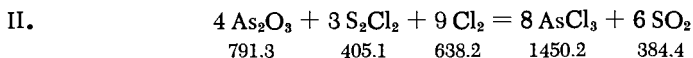

A mixture of 140 g. of As_2O_3 and 100 g. of S_2Cl_2 is prepared in a flask, and dry Cl_2 is introduced. When most of the material has reacted, another 60 g. of As_2O_3 is added, and additional Cl_2 is introduced. Finally, the product is distilled directly from the flask, in the presence of some metallic arsenic.

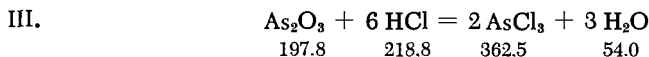

The As_2O_3 is distilled from concentrated hydrochloric acid in a stream of HCl.

PROPERTIES:

Formula weight 181.28. Colorless, oily liquid. Fumes in air. Extremely toxic (skin poison). Solidifies at -16.2°C to colorless crystals with a pearly sheen. B.p. 130.2°C ; d. 2.2. Soluble in H_2O and HCl. Dissolves alkali iodides, sulfur, phosphorus, and oils.

REFERENCES:

- R. C. Smith. *Ind. Eng. Chem.* 11, 109 (1919).
 J. R. Partington. *J. Chem. Soc. (London)* 1929, 2577.
 G. P. Baxter et al. *J. Amer. Chem. Soc.* 55, 1054 (1933); 57, 851 (1935).
 W. Biltz and A. Sapper. *Z. anorg. allg. Chem.* 203, 277 (1932).
 W. Biltz and E. Kennecke. *Z. anorg. allg. Chem.* 147, 171 (1925).
 C. F. Booth. *Monsanto Chem. Co. US Patent* 2,383,105 (1945).

Arsenic Tribromide

A boat is placed in a Pyrex tube and filled with As powder. A stream of dry N_2 , saturated with Br_2 vapor by passage through a Br_2 -filled wash bottle, is passed over the As. The tube is inclined toward the receiver and connected with the latter by means of an asbestos-paper-sealed adapter. The tube is heated until the onset of reaction. The product is distilled from the receiver over As powder.

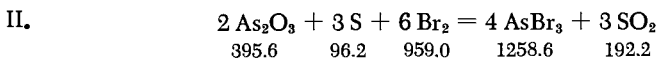

A mixture of 26.5 g. of As_2O_3 , 6 g. of sulfur, and 64 g. of Br_2 is heated in a 300-ml. flask in a metal bath. After about seven hours, the rising vapors are no longer colored brown with bromine. A pre-heated suction filter is employed for filtering. The product is very pure. Further purification involves distillation over As as in method I.

PROPERTIES:

Formula weight 314.66. Colorless, deliquescent, rhombic prisms. M.p. 31.2°C , b.p. 221°C ; d_{4}^{15} 3.66. Fumes in humid air and is hydrolyzed by water.

REFERENCES:

- G. P. Baxter. *J. Amer. Chem. Soc.* **55**, 1054 (1933).
 G. Oddo and U. Giachery. *Gazz. Chim. Ital.* **53**, 56 (1923).
 W. Biltz and A. Sapper. *Z. anorg. allg. Chem.* **203**, 277 (1932).
 H. Braekken. *Kongr. Norske Vidensk. Selsk. Forhandl.* **8**, No. 10, 1 (1935).

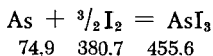
Arsenic Triiodide

I. A CS_2 or ether solution of I_2 is refluxed with excess As powder until the iodine color disappears. This is followed by rapid filtration. The product is then allowed to crystallize. Concentration of the solution yields additional crystals. The product is recrystallized from CS_2 or ether.

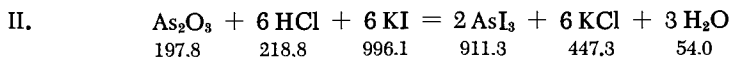
Other preparative methods:

A solution of 10 g. of KI in 10 ml. of H₂O is added to a hot solution of 2 g. of As₂O₃ in 30 ml. of hydrochloric acid (d. 1.19), whereupon a yellow crystalline powder precipitates. This is suction-filtered and washed with concentrated hydrochloric acid (d. 1.12) until no KCl residue is seen when the wash liquid is evaporated on a watch glass. The product can be further purified by recrystallization as described above.

III. In the Oddo method, the product is obtained from As₂O₃, iodine, and sulfur, in a procedure identical to that described for AsBr₃. However, 102 g. of iodine is used in the present case. After heating for 14 hours, the product can be purified by recrystallization as described above.

PROPERTIES:

Lustrous, trigonal red leaves or platelets. Rhombohedral. M.p. 141.8°C, b.p. 403°C; d.₄²⁵ 4.688. Soluble in H₂O, ether, CS₂, xylene, and various other organic solvents. Sparingly soluble in strong HCl. In air, gradually decomposes into As₂O₃ and iodine.

REFERENCES:

- E. Bamberger and J. Philipp. Ber. dtsch. chem. Ges. 14, 2643 (1881).
 W. H. Madson and F. C. Krauskopf. Recueil Trav. Chim. Pays-Bas 50, 1005 (1931).
 G. Oddo and N. Giachery. Gazz. chim. ital. 53 56 (1923).
 T. Karantassis. Bull. Soc. Chim. France (4) 37, 853 (1925).
 E. Montignie. Bull. Soc. Chim. France (5) 8, 542 (1941).
 Wiggers. Lehrbuch von Graham-Otto [Graham-Otto Textbook]. 5th ed. Braunschweig 1881, II, 462.
 R. C. Cowley and J. P. Catford. Pharm. J. [4] 21, 131 (C. 1905 II, 809).
 L. Vegard. Skr. Acad. Oslo (1947) No. 2, 1.
 W. Biltz and A. Sapper. Z. anorg. allg. Chem. 203, 277 (1932).

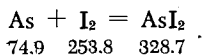
Arsenic Diiodide

A mixture of 20 g. of I₂ and 20 g. of powdered As is placed in a tube, and all air is displaced by repeated evacuation and filling

with CO_2 . The tube is sealed in a stream of CO_2 . The tube is then heated in an inclined position for seven hours at 240°C , and permitted to cool in the same position to enable the product to gather and solidify at one end. To recrystallize the product, the section containing the product is broken off. It is immediately placed in flask *a* of the apparatus illustrated in Fig. 202, prefilled with air-free, P_2O_5 -dried CO_2 from *b*. The flask capacity is 300–400 ml. and it contains about 150 ml. of dry xylene. Stopper *c* is then pushed firmly into place while *d* is left loose. The xylene is then boiled (continued passage of CO_2) until the AsI_3 dissolves. After that, *d* is tightened in place, *c* is removed, and adapter *e*, containing a hard folded filter paper, *f*, is put in its place. Flask *h* is then placed over *e* while a constant flow of CO_2 is maintained. After *h* has been filled with CO_2 (in about 5 minutes) the solution is transferred into *h* via filter *f* by slowly tilting the apparatus. The solution must remain boiling hot. The CO_2 inlet is then transferred to *g* and the stopper connecting *h* to *e* may be removed. The product is permitted to cool in the CO_2 stream; the AsI_2 precipitates as long red prisms.

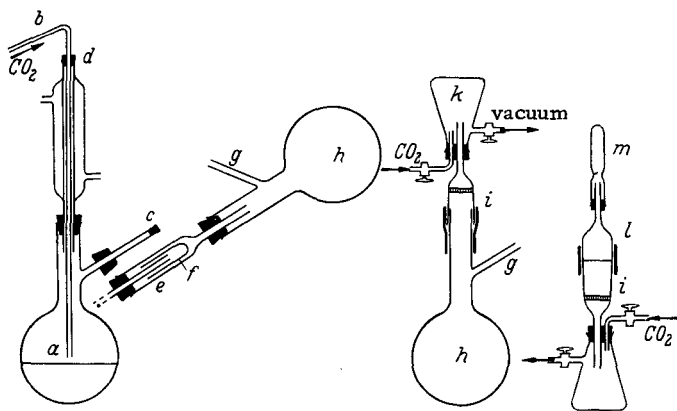

Fig. 202. Purification of arsenic diiodide.

To separate the AsI_2 , a fairly coarse fritted glass filter *l*, attached to suction flask *k*, is placed over the neck of flask *h*. Carbon dioxide is introduced through a tube in the stopper of *k*. When the whole system has been filled with CO_2 via *g*, the apparatus is turned upside down and the AsI_2 drops onto the fritted filter. It is then suction dried in a stream of CO_2 . Removal from the filter must also be done in a stream of CO_2 and in the absence of moisture. The aspirator is turned off, the system is filled with CO_2 , and flask *h* is removed quickly and replaced by an adapter *l* which fits the fritted filter. The adapter is sealed to the filter with large-diameter rubber hose (e.g., bicycle inner tube). Then CO_2 passage from

below is resumed. Several previously prepared storage tubes may now be attached at the other end of the adapter. These are filled with CO_2 , the AsI_2 is poured in, and the tubes are sealed with a torch.

PROPERTIES:

Red prisms. M.p. 128–130°C. Exceptionally unstable in air. Disproportionates in water to As and AsI_2 .

REFERENCES:

- I. T. Hewitt and T. F. Winmill. *J. Chem. Soc. (London)* 91, 962 (1907).
 W. Schlenk and G. Racki. *Liebigs Ann. Chem.* 394, 218 (1912).
 T. Karantassis. *Bull. Soc. chim. France* (4) 37, 853 (1925).
 L. Vanino. *Hanb. d. präp. Chem.* vol. 1, 3rd ed., Stuttgart 1925, p. 228.
 E. Montignie. *Bull. Soc. Chim. France* (5) 8, 542 (1941).

Diarsenic Trioxide

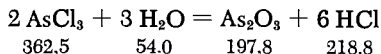
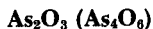

To obtain a pure product, 150 g. of As_2O_3 is treated with concentrated HCl in the apparatus shown in Fig. 231, and AsCl_3 is slowly distilled in a stream of HCl. To remove SbCl_3 from the oily layer in the first condensation trap, the material is shaken repeatedly with 2/3 its volume of concentrated hydrochloric acid until the aqueous layer is free of Sb (tested by the method of Foulk and Horton, i.e., distilling off the bulk of dissolved AsCl_3 and precipitating the strongly acid solution with H_2S). The precipitate is filtered off, the solution diluted, and the H_2S bubbling is resumed; Sb precipitates as an orange-red solid. If SbCl_3 is present only in traces, the precipitate appears only after one or two days of standing in an atmosphere of H_2S). The pure AsCl_3 is hydrolyzed in vigorously stirred boiling water and As_2O_3 crystallizes out on cooling.

PROPERTIES:

White powder. There are two crystalline modifications, monoclinic claudetite (m.p. 313°C) and cubic arsenolite (m.p. 275°C). A cold solution of As_2O_3 in hydrochloric acid always separates arsenolite. Claudetite can be obtained by heating moist arsenolite for several days at 100 to 200°C. In addition, there is a vitreous

form of As_2O_3 . In the vapor and in nitrobenzene the formula is As_4O_6 . The structure is analogous to that of P_4O_6 . B.p. 465°C ; sublimes at 195°C in a stream of N_2 .

REFERENCES:

- C. W. Foulk and P. G. Horton. *J. Amer. Chem. Soc.* 51, 2416 (1929).
 E. Jenckel. *Z. anorg. allg. Chem.* 182, 314 (1929).
 J. A. Schulmann and W. C. Schumb. *J. Amer. Chem. Soc.* 65, 878 (1943).
 A. R. Toueky and A. A. Mousa. *J. Chem. Soc. (London)* 1949, 1305.
 I. N. Stranski, K. Plieth and J. Zoll. *Z. Elektrochem.* 62, 362 (1958).

Orthoarsenic Acid

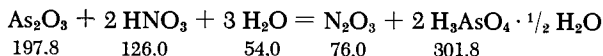

Arsenic trioxide (100 g.) is placed in a ground joint flask and 100 ml. of concentrated HNO_3 (d. 1.38) is slowly added from a dropping funnel. The mixture is then heated. The nitric oxides are passed through concentrated H_2SO_4 to obtain nitrosyl hydrogen sulfate. When the evolution of nitrogen oxides ceases, the supernatant liquid is decanted from the undissolved material and evaporated to dryness. The residue is taken up in some H_2O and filtered through a glass frit, and the solution is evaporated until a thermometer in the liquid reads 130°C . The solution, which has a honeylike consistency when cold, is left to crystallize in a refrigerator (in a desiccator over H_2SO_4). Beautiful transparent crystals of $\text{H}_3\text{AsO}_4 \cdot \frac{1}{2} \text{H}_2\text{O}$ precipitate. If the crystallization is done at -30°C , the hydrate H_7AsO_6 may be formed, but only if the solution is held for a few days at this temperature. If the solution is evaporated until a b.p. of 175°C is reached, $\text{As}_2\text{O}_5 \cdot \frac{5}{3} \text{H}_2\text{O}$ precipitates.

PROPERTIES:

All the hydrates lose their water on heating above $250-300^\circ\text{C}$ and convert to As_2O_5 .

$\text{H}_3\text{AsO}_4 \cdot \frac{1}{2} \text{H}_2\text{O}$: transparent, large, hygroscopic crystals.

$\text{As}_2\text{O}_5 \cdot \frac{5}{3} \text{H}_2\text{O}$: dull, granular crystalline mass.

REFERENCES:

- A. Simon and E. Thaler. *Z. anorg. allg. Chem.* 161, 143 (1927); 246, 19 (1941).
 H. Guérin. *Bull. Soc. Chim. France Mém.* (5) 22, 1536 (1955).

Sodium Dihydrogen Orthoarsenate

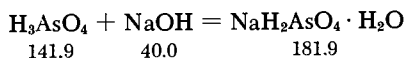

A 5N solution of H_3AsO_4 is neutralized with caustic soda to the methyl orange end point and then evaporated until crystallization begins. The crude salt which precipitates on cooling is dissolved in water to make a saturated solution at 100°C (75.3 g./100 g. H_2O), and is then cooled to 0°C with stirring. The fine, crystalline precipitate is suction-filtered, washed with some ice water, and dried over P_2O_5 .

PROPERTIES:

White crystalline powder. d 2.53. Loses water of crystallization when warmed and passes through the stages $\text{NaH}_2\text{AsO}_4 \rightarrow \text{Na}_2\text{H}_2\text{As}_2\text{O}_7 \rightarrow \text{Na}_3\text{H}_2\text{As}_3\text{O}_{10}$, finally converting to NaAsO_3 above 230°C .

REFERENCE

E. Thilo and J. Plaetschke. *Z. anorg. Chem.* **260**, 315 (1949).

Ammonium Orthoarsenate

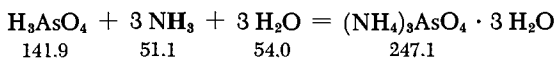

A saturated aqueous orthoarsenic acid solution is saturated with gaseous NH_3 . Beautiful crystals of ammonium orthoarsenate precipitate immediately.

PROPERTIES:

Rhombic crystalline lamellae. Loses NH_3 and H_2O in air and converts to the monohydrogen salt. On heating, the aqueous solution loses so much NH_3 that the solution corresponds at the end to the dihydrogen salt.

REFERENCES:

H. Salkowski. *J. prakt. Chem.* **104**, 132 (1868).
C. Matignon and A. de Passille. *Comptes Rendus Hebd. Séances Acad. Sci.* **198**, 779 (1934); **200**, 1854 (1935).

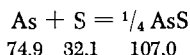
Tetraarsenic Tetrasulfide

Equimolar quantities of As and S are placed in a thick-walled, sealed tube and fused together at 500–600°C in a N₂ atmosphere. The product is sublimed in vacuum.

PROPERTIES:

Deep red, lustrous monoclinic crystals. Vapor density measurements at 550°C indicate As₄S₄. M.p. 320°C, b.p. 565°C; d 3.5. Occurs in nature as realgar.

REFERENCE:

E. V. Britzke and A. F. Kapustinski. *Z. anorg. allg. Chem.* 205, 95 (1932).

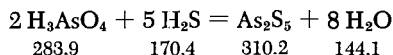
Diarsenic Pentasulfide

Pure As₂S₅ can be obtained by precipitation of orthoarsenic acid solutions only if the aqueous acid is treated with twice its volume of concentrated (d 1.19) hydrochloric acid, and a fast stream of H₂S is bubbled through the ice-cooled solution for about an hour. The flask must be cooled even during the HCl addition and no temperature rise should be allowed. The precipitate is washed with water and alcohol and dried at 100°C.

PROPERTIES:

Somewhat brighter yellow than the trisulfide. Decomposes into As₂O₃, S, and As₂S₃ when boiled with H₂O.

REFERENCES:

F. Neher. *Z. anal. Chem.* 32, 45 (1893).
 W. Foster. *J. Amer. Chem. Soc.* 38, 52 (1916).
 F. Foerster. *Z. anorg. allg. Chem.* 188, 90 (1930).

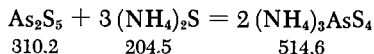
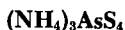
Ammonium Thioarsenate

A solution of As_2S_5 in excess $(\text{NH}_4)_2\text{S}$ is prepared with moderate heating and thoroughly extracted with hot alcohol. Cooling results in precipitation of colorless crystals of the salt. After suction filtering, the product is washed with alcohol.

PROPERTIES:

Formula weight 257.29. Prisms. In air, the surface yellows. Melts on heating and decomposes to As_2S_3 , S, and ammonium sulfide.

REFERENCE:

W. P. Bloxam. J. Chem. Soc. (London) 67, 277 (1895).

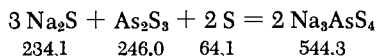
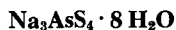
Sodium Thioarsenate

A solution of 20 g. of As_2O_3 in hot NaOH is strongly acidified with HCl. Then As_2S_3 is precipitated by bubbling H_2S through the hot solution. Filtering and thorough washing with dilute HCl follows. One half of a solution of 24 g. of NaOH in 100 ml. of water is saturated with H_2S and mixed with the other half. The thus obtained Na_2S solution is used to dissolve 6.4 g. of sulfur and the As_2S_3 . The mixture is evaporated on a steam bath until a crystalline surface layer forms. It is then left to crystallize in the cold.

PROPERTIES:

Formula weight 416.275. Monoclinic prisms, colorless to pale yellow. Readily soluble in H_2O and stable in air. Acidification of the solution results in precipitation of copious quantities of As_2S_5 .

REFERENCES:

R. Fresenius, Z. analyt. Chem. 1, 192 (1862).
McCay. Z. analyt. Chem. 34, 725 (1895).

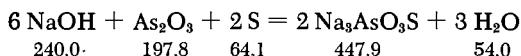
Sodium Monothioorthoarsenate

Arsenic trioxide (20 g.) is dissolved in a solution of 24 g. of NaOH in 100 ml. of H₂O and the mixture is boiled with 6.5 g. of S for half an hour. It is filtered hot and evaporated on a steam bath until crystallization. It is then permitted to cool and the crystals are suction filtered.

PROPERTIES:

Formula weight 440.14. Colorless, rhombic columns, readily soluble in water. Effloresces in air.

REFERENCES:

R. F. Weinland and O. Rumpf. *Ber. dtsh. Chem. Ges.* 29, 1009 (1896); *Z. anorg. allg. Chem.* 14, 42 (1897).

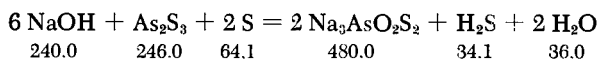
Sodium Dithioorthoarsenate

A mixture of 24.6 g. of moist, freshly precipitated As₂S₃ and 6.4 g. of finely ground sulfur is prepared and a solution of 24 g. of NaOH in 200 ml. of water added. This new mixture is allowed to stand for 12 hours, with frequent agitation, until the bulk of the sulfur has dissolved. It is then filtered, and the filtrate is evaporated until crystallization, at which point it is allowed to cool. The crystallized substance consists of very pure Na₃AsO₂S₂ · 11 H₂O. Additional product is obtained from the mother liquor; it is, however, contaminated with thio- and monothioarsenates.

PROPERTIES:

Formula weight 438.19. Colorless, rhombic crystals, readily soluble in water.

REFERENCE:

R. F. Weinland and P. Lehmann, *Z. anorg. allg. Chem.* 26, 340 (1901).

Antimony

Sb

Chemically pure Sb can be produced by reduction of Sb_2O_5 with hydrogen or, more simply, with KCN. Equal parts of the dried oxide and chemically pure KCN are mixed and the mixture is fused in a porcelain crucible. After cooling, the block of metal is freed of surface impurities by boiling with water and remelted. The starting Sb_2O_5 is best purified by conversion to HSbCl_6 through repeated recrystallization from pure, concentrated hydrochloric acid (Groschuff method). Lautié recommends vacuum distillation of the metal at 800°C for final purification.

PROPERTIES:

M.p. 630°C , b.p. 1645°C ; d 6.684. Brittle, lustrous, bluish-white metal, can be pulverized. Insoluble in HF, HCl, and H_2SO_4 . Soluble in HNO_3 -tartaric acid solution and in aqua regia. Rhombohedral crystals.

REFERENCES:

- E. Groschuff. Z. anorg. allg. Chem. 103, 164 (1918).
 H. H. Willard and R. K. McAlpine. J. Amer. Chem. Soc. 43, 801 (1921).
 O. Hönigschmid, E. Zintl and M. Linhard. Z. anorg. allg. Chem. 136, 264 (1924).
 R. Lautié. Bull. Soc. Chim. France (5) 14, 975 (1947).

Stibine (Antimony Hydride)

SbH_3

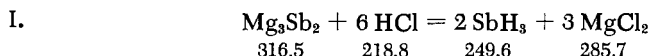

A mixture of 20 g. of finely pulverized Sb and 40 g. of Mg powder is placed in a sheet-iron trough (70 cm. long) which is inserted into a 25-mm.-diameter iron tube. The mixture is then heated in a stream of H_2 . When the tube glows, the flame is extinguished and the tube is allowed to cool in the stream of H_2 . The alloy should be sintered but not fused. The tube contents are sieved and the coarse fraction is repulverized. The gray-black powder should pass through a screen with 0.5-mm. openings. In decomposition the powder is added to the acid and not vice versa. Where small quantities are involved, this can be done in the manner described for AsH_3 (p. 593). The acid is placed in flask *a* of Fig. 203 and Mg-Sb alloy in the side bulb. The powder is added to the flask by turning and tapping the bulb. However, it is better to employ an automatic charging

apparatus, illustrated in Fig. 203. The vessel *b* containing the Sb-Mg powder is fitted on top of flask *g*. A hard rubber rod *d* (a thick knitting needle if available) is positioned axially in vessel *b* and rotating in the mercury seal *c*. The lower end of the rod is conical, with a few spiral grooves at the bottom. Slow rotation of the rod permits a uniform powder flow into *g*. The latter contains preboiled, dilute hydrochloric acid (d 1.06) and is cooled with an ice-salt bath. The air is displaced with H_2 prior to addition of the alloy powder. The interior of empty tube *e* is coated with P_2O_5 powder, while a glass bead- P_2O_5 mixture is placed in drying tubes *f*. The evolving gas passes through *e* and *f* for drying and is frozen in trap *k*, cooled with liquid nitrogen. The product gas contains

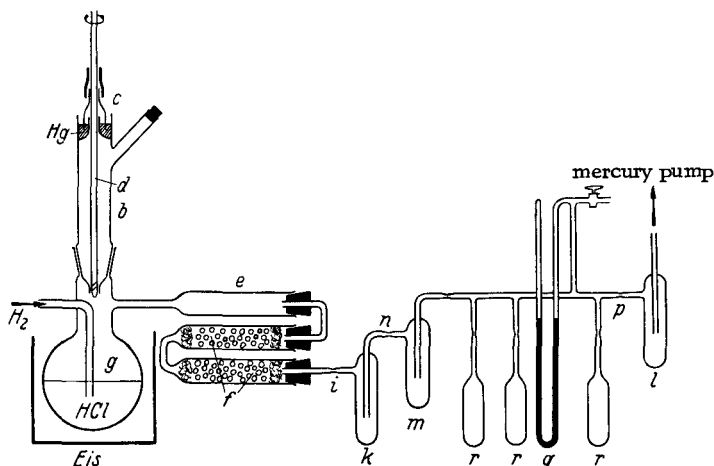

Fig. 203. Preparation of stibine. *e*) Empty tube coated with P_2O_5 powder; *f*) drying tube filled with P_2O_5 and glass beads; *k*, *l*, *m*, *r*) condensation vessels; *q*) Hg vacuum gauge.

about 15% SbH_3 . At the end of the run (SbH_3 evolution is readily controlled by adjustment of the rate of rotation of the feed rod; it continues for a few hours) all the SbH_3 is displaced from *g* into *k* with a stream of H_2 . Capillary *i* is melted and the sealed apparatus is evacuated. The trap contents are melted; a small forerun is distilled into *l*, while the main fraction is collected in *m*. Constrictions *n* and *p* are then melted and the material distilled into ampoules *r*, observing the vacuum on gauge *q*. The distillation temperature is 65–75°C.

Other preparative methods: The electrolytic preparation method of Reismann, Berkenblit, Haase and Gaines uses a Pt anode and a Pt/Ir cathode in an electrolyte consisting of 1.7 liters of 4N H_2SO_4 , 80 g. of tartaric acid, and 8 g. of Sb.

PROPERTIES:

Formula weight 124.78. Cubic crystals. The gas decomposes readily, evolving heat (the decomposition may become explosive). Since a flame may not be brought near the SbH_3 , the storage flask may be torch-sealed only if the contents are frozen at liquid N_2 temperature or a long capillary is interposed between the seal point and the flask. M.p. -91°C , b.p. -17°C , d (-17°C) 2.2. Slowly decomposes into the elements just above the b.p. Extremely toxic. Five volumes of H_2O dissolve one volume of SbH_3 . Cubic crystals.

REFERENCES:

- H. Reckleben and A. Güttig. *Z. analyt. Chem.* 49, 73 (1910);
 F. Paneth. *Z. Elektrochem.* 26, 453 (1920);
 H. J. Sand, E. J. Weeks and S. W. Worell. *J. Chem. Soc. (London)* 123, 456 (1923);
 H. J. S. Weeks. *Recueil Trav. Chim. Pays-Bas* 43, 649 (1924); 44, 201, 795 (1925);
 A. Stock and W. Doht. *Ber. dtsh. chem. Ges.* 35, 2274 (1902);
 G. V. Teal. US Patent 2 391 280 (1945);
 A. A. Durrant, T. G. Pearson and P. L. Robinson. *J. Chem. Soc. (London)* 1934, 733;
 A. Reismann, M. Berkenblit, E. C. Haas and A. Gaines. *J. Electrochem. Soc.* 101, 387 (1954).

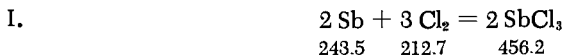
Antimony (III) Chloride

A few pieces of pure Sb are placed in glass tube r (Fig. 204), and a stream of dry Cl_2 is introduced through side arm a of the flask. Tube r rests on an asbestos-lined iron trough inclined slightly toward the flask. Once the reaction has started, it is necessary to add fresh pieces of Sb only from time to time. This is done by removing stopper c , which is only loosely inserted. Plugging does not occur since the chloride is kept fluid in the narrow 8-mm. section of tube r by absorbing Cl_2 . When enough crude chloride is collected in the flask, the Cl_2 stream is interrupted and a few pieces of Sb are placed in the flask. Heat is then applied and finally some more Sb powder is added to eliminate the last of the SbCl_5 . Finally, the SbCl_3 is purified by distillation.

II. A solution of 25 g. of finely pulverized stibnite in 150 ml. of concentrated hydrochloric acid is prepared with heating and filtered

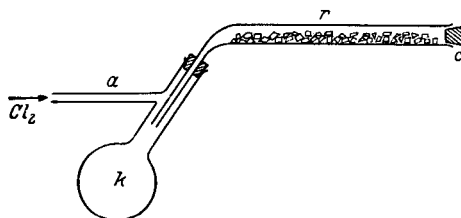

Fig. 204. Preparation of antimony (III) chloride. *r*) Glass tube, straight section about 60 cm. long, inside diameter 1.5 cm., 0.8 cm. in constricted section. Walls 1.5-2 mm. thick.

after cooling. The operation must be conducted under a hood. The filtrate is fractionated in the presence of 2 g. of Sb, the flask being closed with an asbestos stopper. The condenser is air cooled. The forerun (boiling up to 120°C) is discarded. The fraction boiling above 200°C is retained. This portion is fractionated once more in the presence of 1 g. of Sb powder, and only the fraction boiling at 223°C is collected.

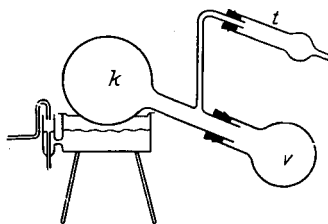

Fig. 205. Purification of antimony (III) chloride by sublimation. *t*) Drying tube.

A particularly pure preparation can be obtained by resublimation of the SbCl_3 . In this procedure, a two-liter distillation flask *k* is placed on a steam bath (see Fig. 205) while the upper part of the sphere is cooled with running water. Some SbCl_3 is placed in the flask. When enough fine, long crystals have deposited on the cold upper part and no unsublimed SbCl_3 is left on the bottom, the flask is left to cool without being disturbed. Then the readily detached crystals are transferred (with tapping) into flask *v*. The entire apparatus must, of course, be carefully dried.

PROPERTIES:

Formula weight 228.1. Colorless; when sublimed, long, fine, rhombic crystals. M.p. 72.9°C, b.p. 223.0°C; d_4^{20} 3.14. Hygroscopic. Fumes in air. Highly corrosive. Soluble in small amounts of H₂O. In large quantities of H₂O, hydrolyzes to SbOCl. Soluble in cold alcohol, CS₂, and in ether; soluble in alkali chloride solutions, forming salts of hexachloroantimony(III) acid. Used for bronzing iron articles. The high cryoscopic constant (18.4) and its ability to dissolve many substances render SbCl₃ suitable for molecular weight determinations.

REFERENCES:

- P. Hensgen. *Recueil Trav. Chim. Pays-Bas* 9, 301 (1890);
 G. Jander and H. Wendt. *Lehrbuch d. analyt. and präp. anorg. Chem.* [Analytical and Preparative Inorganic Chemistry] Stuttgart 1954, p. 201;
 J. Kendall, E. D. Crittenden and H. K. Miller. *J. Amer. chem. Soc.* 45, 967 (1923);
 G. Langguth. *Chim. Ind.* 25, 22 (1931);
 O. Werner. *Z. anorg. allg. Chem.* 181, 154 (1929);
 D. I. Zhurevyev. *Zhurnal Fiz. Khim.* 13, 684 (1939).

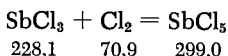
Antimony (V) Chloride

A sample of SbCl₃ is melted in a ground joint Claisen flask. A gas inlet tube passes through one stopper. Chlorine is introduced, at first with heating and then without. When the liquid is saturated, the inlet tube is replaced by a capillary and the flask, which has a vacuum receiver, is evacuated. To remove the excess Cl₂, a stream of air dried with P₂O₅ is drawn through the apparatus by suction, followed by distillation of the flask contents at 14 mm. At this pressure, the SbCl₅ distills over at 68°C. The yield is 85%.

PROPERTIES:

Colorless liquid; fumes strongly in air. M.p. 4.0°C, b.p. (14 mm.) 68°C; (760 mm.) about 140°C (dec.); d_{20} 2.346. On addition of a small quantity of H₂O, forms the hydrates SbCl₅ · H₂O and SbCl₅ · 4H₂O. With addition of larger amounts of water, hydrolyzes to Sb₂O₅. Vapor pressure 6 mm. (51°C), 9 mm. (58°C).

REFERENCES:

- O. Ruff. Ber. dtsch. chem. Ges. 42, 4026 (1909);
 W. Biltz and K. Jeep. Z. anorg. allg. Chem. 162, 34 (1927);
 F. Seel. Z. anorg. Chem. 252, 35 (1944).

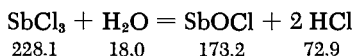
Antimony (III) Oxide Chloride

A mixture of 70 ml. of H_2O and 100 g. of SbCl_3 is prepared, thoroughly stirred, and allowed to stand for several days. The crystals that precipitate are suction-filtered, pressed, washed with ether, and dried. Larger crystals are prepared, according to Edstrand, by heating SbCl_3 with absolute alcohol in a sealed tube at 150°C .

PROPERTIES:

Colorless monoclinic crystals or crystalline powder. Soluble in hydrochloric and tartaric acids and in CS_2 . Addition of water results in hydrolysis to Sb_2O_3 . Heating to about 250°C results in formation of $\text{Sb}_2\text{O}_5\text{Cl}_2$. Above 320°C the product is Sb_2O_3 .

REFERENCES:

- A. Sabanjew. Z. f. Chem. 14, 206 (1871);
 J. M. van Bemmelen, P. A. Meerburg and U. Huber Noodt. Z. anorg. allg. Chem. 33, 290 (1903);
 E. Montignie. Bull. Soc. Chim. France Mém. (5) 14, 378 (1947);
 M. Edstrand, Ark. Kemi 6, 89 (1954).

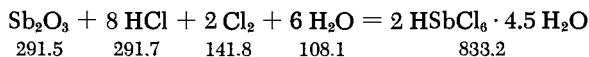
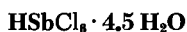
Hexachloroantimonic (V) Acid

A sample of Sb_2O_3 is dissolved in twice its weight of concentrated hydrochloric acid, and saturated with Cl_2 . When the solution becomes greenish yellow, it is concentrated somewhat on a water

bath, gaseous HCl is added, and the mixture is allowed to crystallize overnight at 0°C in a desiccator over H₂SO₄ (seeding should be used if possible). The crystals that precipitate are suction-filtered on a glass suction filter and repeatedly washed with ice-cold concentrated hydrochloric acid. By concentration, additional crystal fractions can be obtained from the mother liquor and the wash liquids, after another treatment with HCl gas. The crystalline fractions thus obtained can then be repeatedly recrystallized from concentrated hydrochloric acid (seed crystals should be set aside). The compound K₂SbCl₆ · H₂O precipitates as greenish octahedral crystals if KCl, instead of HCl, is added to the concentrated solution.

PROPERTIES:

Formula weight 416.6. Greenish, very hygroscopic prisms. M.p. 44°C. Effloresces over concentrated H₂SO₄. Readily soluble in ethanol, acetone, glacial acetic acid, and small amounts of H₂O. Hydrolyzes in excess H₂O. Alcohol and acetone solutions give a neutral reaction.

REFERENCES:

- R. F. Weinland and H. Schmidt. Z. anorg. allg. Chem. 44, 37 (1905);
 E. Groschuff. Z. anorg. allg. Chem. 103, 147 (1918);
 F. Seel. Z. anorg. Chem. 252, 24 (1943).

Nitrosyl Chloroantimonate (IV)

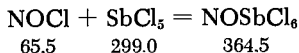
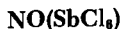

A solution of two moles of NOCl in a small quantity of dried CCl₄ is cooled in an ice-salt bath. Moisture must be absent. A solution of one mole of SbCl₅ in a small quantity of CCl₄ is added dropwise. The yellow precipitate is suction-filtered, washed with some cold CCl₄, and vacuum dried over P₂O₅.

The corresponding nitryl chloroantimonate (V) can be prepared, according to Seel, by co-condensation of SbCl₅, Cl₂, and NO₂Cl. It is a colorless salt.

PROPERTIES:

Yellow crystals, can be sublimated in a CO₂ stream at 150°C. Melts in a closed tube at 170°C. Decomposes in moist air.

REFERENCES:

- H. Rheinboldt and R. Wasserfuhr. Ber. dtsch. chem. Ges. 60, 732 (1927);
 F. Seel. Z. anorg. Chem. 252, 24 (1943);
 F. Seel, J. Nógrádi and R. Posse. Z. anorg. allg. Chem. 269, 197 (1952).

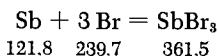
Antimony (III) Bromide

Antimony and bromine react with the appearance of a flame. The material can be prepared in exactly the same manner as described for As: a N_2 stream, saturated with Br_2 , is passed over Sb powder and the products are trapped in a receiver. Another method is to add very small portions of Sb powder through a vertical reflux condenser set on a Pyrex flask containing a solution of Br_2 in CS_2 . Then the Br_2 excess and the CS_2 are distilled off. The flask contents are distilled in a sausage distillation flask. Purification may be accomplished by recrystallization from CS_2 or, better still, via the Jander and Weis procedure, by redistillation over Sb powder and KBr in a stream of dry CO_2 . The apparatus illustrated in Fig. 205a is employed. Flask *a* contains SbBr_3 , placed over Sb powder and KBr. A very large first cut is distilled into receiver *v*, while dry CO_2 is passed through the apparatus from *b*. Then *v* is removed, CO_2 is introduced in at the right, and the major fraction is distilled from *b* onto the chemically pure Sb. The material is again distilled from *b*, and again a large first cut is discarded. Finally, the main fraction is distilled into receivers attached with ground glass joints.

PROPERTIES:

White crystalline mass. When fused, it is bright, amber yellow. M.p. 96°C , b.p. 288°C ; d 4.148. Hygroscopic. Hydrolyzes in H_2O . Rhombic.

REFERENCES:

- J. Niklès. J. Pharm. (3) 41, 145 (1862);
 A. C. Vournasos. Z. anorg. allg. Chem. 192, 372 (1930);
 W. Biltz and A. Sapper. Z. anorg. allg. Chem. 203, 282 (1932);

E. Dönges. *Z. anorg. allg. Chem.* **263**, 112 (1950);
 G. Jander and J. Weis. *Z. Elektrochem.* **61**, 1275 (1957).

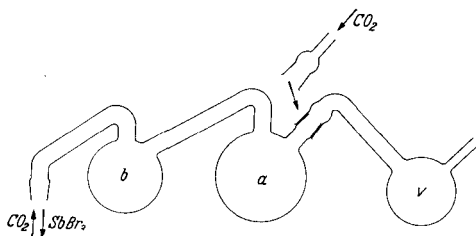
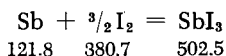

Fig. 205a. Purification of antimony (III) bromide.

Antimony (III) Iodide



A solution of 14 g. of I_2 in 300 ml. of toluene is refluxed with 7 g. of finely pulverized Sb until the iodine color disappears. The yellow-green solution is filtered from the unconverted Sb (best practice is to use an immersion suction filter and propel the fluid with compressed CO_2) and allowed to crystallize, whereupon SbI_3 precipitates as red leaflets. These are freed of toluene in a vacuum desiccator at 40°C and then resublimed in a flow of CO_2 or in vacuum. The SbI_3 distills between 180 and 200°C . The yield is 80%.

PROPERTIES:

Red, crystalline flakes; trigonal. In addition to the red trigonal form [d (22°C) 4.92], there are two greenish modifications, one rhombic and one monoclinic. d (17°C) 4.77. When fused, a pomegranate-red liquid. The vapor is orange red. M.p. 170°C , b.p. 401°C . Hydrolyzes in H_2O to a yellow oxyiodide.

REFERENCES:

W. Biltz and A. Sapper. *Z. anorg. allg. Chem.* **203**, 282 (1932);
 J. C. Bailar and P. F. Cundy in: H. S. Booth, *Inorg. Syntheses*, Vol. I, p. 104, New York-London 1939.

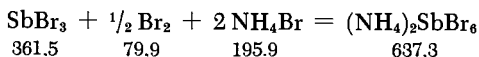
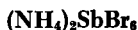
Ammonium Hexabromoantimonate (IV)

A 4.9-g. sample of NH_4Br is dissolved in 50 ml. of concentrated (48%) hydrobromic acid with gentle warming and the solution is then cooled. A portion of the NH_4Br precipitates as a very fine powder but redissolves on addition of 50 ml. of concentrated H_2SO_4 (use cooling). A solution of 9 g. of SbBr_3 and 0.65 ml. of Br_2 in 10 ml. of concentrated hydrobromic acid is then added to the mixture. The $(\text{NH}_4)_2\text{SbBr}_6$ precipitates virtually quantitatively. It is suction filtered, washed three times with 4 ml. of concentrated hydrobromic acid, and dried in a vacuum desiccator over KOH . The drying process, usually complete after two days, involves loss of Br , and the substance takes on a dirty olive-green color. After drying, the composition of the substance corresponds approximately to the formula $(\text{NH}_4)_2\text{SbBr}_{5.4}$. If the drying is longer, the color becomes lighter and more bromine is lost. To rebrominate the substance, it is placed in a desiccator over concentrated H_2SO_4 and kept there for a day under bromine vapor. The excess Br_2 is then evacuated. The preparation is then pure and corresponds to the formula $(\text{NH}_4)_2\text{SbBr}_6$.

PROPERTIES:

Crystallizes in deep-black octahedra, stable in dry air. Moisture produces hydrolytic decomposition. Soluble in 2N hydrochloric acid; can be recrystallized (with loss of Br) from concentrated hydrobromic acid. Crystal structure: similar to K_2PtCl_6 .

REFERENCES:

- F. Ephraim and S. Weinberg. Ber. dtsh. chem. Ges. 42, 4450 (1909);
 K. A. Jensen. Z. anorg. allg. Chem. 232, 193 (1937); 252, 317 (1944);
 W. D. Schnell, Thesis, Freiburg, 1952.

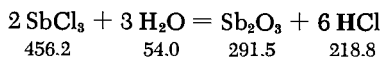
Antimony (III) Oxide

A solution of SbCl_5 in some highly concentrated hydrochloric acid is diluted with water. The resulting precipitate is repeatedly

washed and decanted with water and is then boiled repeatedly with dilute ammonia until the solution is free of halogen ions. It is then decanted repeatedly with water, washed on a filter, and dried. Other antimony compounds may be used in similar fashion to prepare Sb_2O_3 by hydrolysis.

PROPERTIES:

White, crystalline powder; cubic (senarmonite) or rhombic (valentinite); transformation point $570^\circ\text{C} \pm 10^\circ\text{C}$. Hydrolysis yields the metastable valentinite. When treated with alkali, converts gradually to senarmonite. d_4^{25} 5.19 (cubic), 5.79 (rhombic); b.p. 1425°C ; m.p. 655°C . Sublimes in vacuum at 400°C . Slightly soluble in H_2O . Heating gives a reversible yellow color.

REFERENCES:

- L. Vanino. *Handb. d. präp. Chem.*, 2nd ed., Stuttgart 1925, p. 229;
 E. J. Roberts and F. Fenwick. *J. Amer. Chem. Soc.* **50**, 2133 (1928);
 M. C. Bloom and M. J. Buerger. *Z. Kristallogr.* **96**, 367 (1937);
 M. J. Buerger and S. B. Hendricks. *Z. Kristallogr.* **98**, 29 (1938);
 A. Simon. *Z. anorg. allg. Chem.* **165**, 38 (1927).

Antimony (V) Oxide

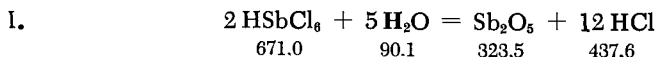

The Sb_2O_5 required for the preparation of chemically pure Sb is made by hydrolysis of hexachloroantimonic acid. The latter is dissolved in some double-distilled water, and the cold solution is diluted with more water. Then C. P. ammonia is added and the solution is heated on a water bath until the Sb_2O_5 precipitate settles. Decantation follows, then repeated washing with chemically pure water and another decantation. Finally, the precipitate is suction filtered through a paper filter. The substance is dried in a dish by heating on a water bath.

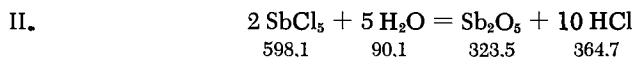

A mixture of SbCl_5 in 20 to 25 times its weight of cold water is prepared. After a few hours, the precipitate is filtered and washed with cold water. It is dried at 275°C to constant weight.

III. Another method of preparation is the precipitation of a potassium antimoniate solution with nitric acid, followed by thorough washing and drying as above.

PROPERTIES:

Fine, pale yellow powder. Cubic. Slightly soluble in H_2O . d 3.78. Loses oxygen on heating above $300^\circ C$ and gradually converts to Sb_2O_4 . New studies have shown that the compound does not correspond fully to Sb_2O_5 , but that it is always somewhat hydrated. When heated for a long time, its composition corresponds to the formula $Sb_2O_5 \cdot SbOOH$. It seems questionable whether pure Sb_2O_5 exists at all.

REFERENCES:

- K. Dählström and A. Westgren. *Z. anorg. allg. Chem.* 235, 153 (1937); 239, 57 (1938);
 A. Simon and E. Thaler. *Z. anorg. allg. Chem.* 162, 260 (1927).

Hydrated Antimony (V) Oxide

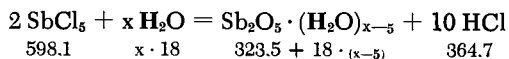
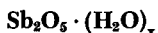

I. Antimony (V) chloride (100 ml.) is added dropwise and with vigorous stirring and constant cooling to $0^\circ C$ to 7.5 liters of ice-cold saturated chlorine water. The liquid becomes cloudy. The copious precipitate is repeatedly washed and decanted with nine-liter portions of water and then purified for 23 days in a rapid dialyzer. The material is filtered through a leaf filter and spread on a clay plate, where it is left to dry in the air. After a number of months, the preparation analyzes as $Sb_2O_5 \cdot 4.58 H_2O$.

II. If precipitation is performed at $100^\circ C$ with only two liters of the precipitation liquid, followed by purification and drying as described in I, the resulting crystals are larger and have the composition $Sb_2O_5 \cdot 4.40 H_2O$.

PROPERTIES:

Insoluble or very slightly soluble in moderately concentrated alkalis and acids. Opaque, white, highly adsorptive mass. Isothermal dehydration at room temperature produces one definitely identified hydrate, $3 Sb_2O_5 \cdot 5H_2O$, which can be prepared by heating for many days in a sealed tube at $300^\circ C$.

REFERENCES:

- G. Jander. Koll. Z. 23, 130 (1918);
 G. Jander and A. Simon. Z. anorg. allg. Chem. 127, 71 (1923);
 A. Simon and E. Thaler. Z. anorg. allg. Chem. 161, 116 (1927).

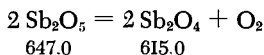
Diantimony Tetroxide

Antimony (V) oxide is ignited to red heat for about two weeks in a Pt crucible at 800-900°C. Other method: boiling Sb_2O_3 with nitric acid, evaporating until fuming, and igniting as above.

PROPERTIES:

Minute, lustrous crystals, yellow when heated. Infusible. Decomposes to Sb_2O_3 and O_2 at very high temperatures. Virtually insoluble in water, dilute acids and alkalis. Soluble in hot concentrated HCl and concentrated H_2SO_4 . d. 6.6-7.5. Cubic or rhombic crystals.

REFERENCES:

- K. Dählström and A. Westgren. Z. anorg. allg. Chem. 235, 153 (1937); 239, 57 (1938).
 A. Simon and E. Thaler. Z. anorg. allg. Chem. 162, 260 (1927).

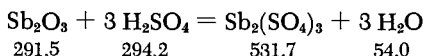
Antimony(III) Sulfate

Antimony (III) oxide is dissolved in hot concentrated H_2SO_4 . Long, silky needles of $\text{Sb}_2(\text{SO}_4)_3$ precipitate on cooling. These are suction filtered on a glass filter crucible and dried on a clay dish. The substance can be obtained free of H_2SO_4 by washing with xylene. Washing is continued until the wash liquor obtained by shaking the xylene with water no longer gives an acid reaction. The crystals are converted to an amorphous mass on washing, but the salt is then very pure.

PROPERTIES:

Colorless crystals, deliquesce in air. Cold water decomposes the substance to a basic sulfate. Complete hydrolysis results on boiling with water. d 3.62.

REFERENCE:

S. Metzl. Z. anorg. allg. Chem. 48, 143 (1906).

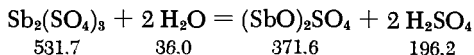
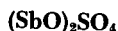
Antimony (III) Oxide Sulfate

Antimony sulfate is treated with 10 times its weight of cold water, the mixture is thoroughly stirred and allowed to stand overnight in the cold. It is then suction-filtered and dried at 100°C.

PROPERTIES:

White powder, insoluble in water, soluble in dilute tartaric acid.

REFERENCE:

S. Metzl. Z. anorg. allg. Chem. 48, 143 (1906).

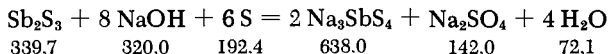
Sodium Thioantimonate (V)

I. A solution of 15 g. of SbCl_3 in 600 ml. of dilute hydrochloric acid is prepared. If a precipitate is produced as a consequence of hydrolysis, concentrated hydrochloric acid is added until the solution becomes clear. Then H_2S is bubbled through the solution, and the precipitate of Sb_2S_3 is filtered off. It is mixed with 60 ml. of 20% NaOH ; 6 g. of S (powder form) is added and the mixture is boiled with constant stirring until the orange-red color turns yellow. The water lost on boiling should be replaced from time to time. The solution is filtered through a fluted filter and

evaporated until crystallization begins. If the solution becomes turbid, a few drops of 20% NaOH are added until it clears. After complete cooling, the crystalline precipitate is suction-filtered, washed with some alcohol, and dried in a desiccator over quicklime to which a few drops of ammonium sulfide solution have been added. The mother liquor can be further concentrated. The preparation can be purified by recrystallization from weakly alkaline solution (a few milliliters of sodium hydroxide are added to the water).

SYNONYM:

Schlippe's salt.

PROPERTIES:

Formula weight ($\text{Na}_3\text{SbS}_4 \cdot 9\text{H}_2\text{O}$) 481.14. Bright yellow, large, tetrahedral crystals. Effloresces readily in air.

REFERENCES:

- C. F. von Schlippe. Schweiggers Journ. f. Chem. and Physik 33, 320 (1821);
E. Riesenfeld. Anorganisch-chemisches Praktikum [Laboratory Manual for Inorganic Chemistry], Leipzig, 1930, p. 238;
H. and W. Biltz. Übungsbeispiele aus der unorganischen Experimentalchemie [Practical Problems in Experimental Inorganic Chemistry], Leipzig, 1920, p. 133;
F. Kirchhof. Z. anorg. allg. Chem. 112, 67 (1920).

Bismuth

Bi

The chemically pure bismuth oxide starting material is prepared from highest purity commercial bismuth nitrate. This is dissolved at 18°C in one half its weight of 8% nitric acid. An equal weight of concentrated nitric acid is added, and the solution is cooled to 0-10°C while well stirred. The resulting crystalline slurry is suction-filtered on a coarse fritted glass filter and washed with some ice-cold, concentrated nitric acid. Further quantities of nitrate may be obtained by concentrating the mother liquor. The purification is repeated as many times as necessary; the nitrate product is decomposed to the basic nitrate by heating in a porcelain dish at 110°C and this is then converted to the oxide by igniting. The oxide is mixed with half its weight of pure KCN and reduced in a porcelain crucible. Reduction in a flow of H_2 is less convenient.

Impurities in the Bi metal thus purified cannot be detected by chemical or spectroscopic means.

Bismuth metal can be purified to a considerable extent by slow crystallization in a large diameter Vycor test tube under paraffin oil. It is permitted to cool, while stirring with a perforated glass ladle, and the precipitated crystals are scooped out of the melt (it must be borne in mind that bismuth expands on solidification and may burst the test tube. A dish is therefore placed underneath). The crystals are melted. This treatment removes all impurities except for Sb, which forms mixed crystals with the bismuth.

PROPERTIES:

Atomic weight 209.00. Brittle, lustrous metal. May be pulverized. M.p. 271°C, b.p. 1560°C; d. 9.80. Insoluble in hydrochloric acid, soluble in nitric acid. Rhombohedral crystals.

REFERENCES:

- O. Hönigschmid and L. Birckenbach. Z. Elektrochem. 26, 403 (1920);
 J. Löwe. Z. analyt. Chem. 22, 498 (1883);
 R. Schneider. J. prakt. Chem. 50, 461 (1894);
 F. Mylius. Z. anorg. allg. Chem. 96, 237 (1916);
 A. Classen. Ber. dtsch. chem. Ges. 23, 938 (1890).

Bismuth (III) Chloride

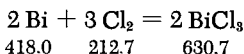

A boat containing Bi is placed in a Vycor tube and heated in an electric furnace. A two-way stopcock permits introduction of either pure N₂ or Cl₂. The air is displaced with N₂ and the apparatus is dried by heating and passage of N₂. Then the chlorine stream is introduced and the temperature is raised until the reaction begins. The BiCl₃ sublimes into the part of the tube that is cooled by a water jacket or with wet filter paper. After about an hour the formation of BiCl₃ ceases. The Cl₂ is displaced with N₂, and the chloride is quickly removed from the tube (Hönigschmid describes a special emptying device).

Other preparative methods: solution of Bi₂O₃ in hydrochloric acid, drying on a water bath, and distilling the residue in a stream of CO₂.

PROPERTIES:

Formula weight 315.37. Colorless crystals. B.p. 447°C, m.p. 233°C; d. 4.75. Soluble in alcohol and hydrochloric acid. Hydrolyzes to BiOCl in H₂O. Deliquesces in air.

REFERENCES:

- O. Hönigschmid and L. Birckenbach. Z. Elektrochem. 26, 403 (1920); Ber. dtsh. chem. Ges. 54, 1889 (1921);
A. Voigt and W. Biltz. Z. anorg. allg. Chem. 133, 293 (1924).

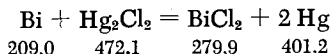
Bismuth Dichloride

An equimolar mixture of Hg₂Cl₂ and powdered Bi is heated for two hours in a sealed tube at 250°C. After heating, the BiCl₂ is separated from the Hg and reheated in the tube.

PROPERTIES:

Microscopically small, black crystals, insoluble in organic solvents. M.p. 163°C; d 4.86. At 300°C, it decomposes to Bi + BiCl₃. When heated in air, produces Bi₂O₃, BiOCl and Cl₂. With H₂O decomposes to BiOCl, Bi and HCl. Yields BiICl₂ with I₂.

REFERENCES:

- A. Schneider. Pogg. Ann. 96, 136 (1855);
E. Montignie. Bull. Soc. Chim. France [5] 4, 588 (1937).

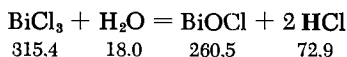
Bismuth Oxide Chloride

A solution of 3 g. of Bi₂O₃ in 300 ml. of hydrochloric acid (d 1.05) is heated to boiling, at which point 2.5 liters of boiling water is added. Boiling is continued until the initial precipitate

has redissolved. The solution is then allowed to cool until crystallization sets in. The BiOCl precipitate is filtered by suction.

PROPERTIES:

Colorless, crystalline powder, very slightly soluble in H_2O . d 7.72. Tetragonal.

REFERENCES:

A. de Schulten. Bull. Soc. Chim. France [3] 23, 156 (1900);
W. Herz. Z. anorg. allg. Chem. 36, 346 (1903).

Bismuth (III) Bromide

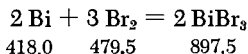

The same type of reaction vessel is employed as in the preparation of BiCl_3 . A stream of N_2 dried with concentrated H_2SO_4 is passed through a wash bottle filled with Br_2 . This flask is slightly heated by a surrounding warm water bath. The N_2 - Br_2 mixture then passes through a P_2O_5 drying tube. The apparatus used for preparation of this gaseous mixture is illustrated in Fig. 206.

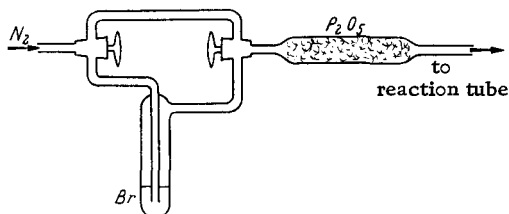

Fig. 206. Generation of a stream of dry bromine vapor for preparation of bismuth (III) bromide.

Other method: Bismuth powder is placed in a retort, Br_2 is poured over it, and the mixture is allowed to stand for a few days and then distilled. It is also possible to heat Br_2 with Bi in a round-bottom flask equipped with a reflux condenser. In both cases purification is by vacuum distillation.

PROPERTIES:

Formula weight 448.75. Orange-yellow, crystalline mass. M.p. 218°C , b.p. 441°C ; d 5.7. Produces BiOBr with H_2O .

REFERENCES:

- O. Hönigschmid and L. Birckenbach. *Z. Elektrochem.* 26, 403 (1920);
 V. Meyer. *Liebigs Ann. Chem.* 264, 122 (1891).

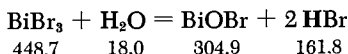
Bismuth Oxide Bromide

A solution of 3 g. of Bi_2O_3 in 50 ml. of hydrobromic acid (d 1.38) is heated to boiling. It is then diluted with 1.5-1.6 liters of boiling water and boiling is continued until the initial precipitate redissolves. The BiOBr crystallizes on cooling in ice. It is washed with dilute hydrobromic acid and then with pure water.

PROPERTIES:

Colorless square crystals or colorless crystalline powder. Very stable, melts at red heat. Soluble in concentrated hydrobromic acid.

Bismuth (III) Iodide

I.

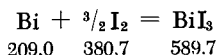

Iodine (20 g.) is ground with 45 g. of finely powdered Bi in a mortar and then rapidly placed in a retort. The mixture is heated until reaction begins. At the end of the reaction, a stream of CO_2 is passed through the warm retort to remove unreacted iodine. The iodide is then sublimed in a stream of CO_2 . Smaller quantities can also be prepared by placing the mixture in a boat inserted into a Vycor tube, heating, and then subliming the BiI_3 in a CO_2 stream.

II.

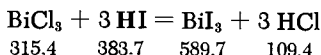

A solution of BiCl_3 in hydrochloric acid is precipitated with concentrated hydriodic acid. The precipitate is filtered in a fritted glass suction funnel and washed free of Cl ions with concentrated

hydriodic acid. The crystals are dried in vacuum over P_2O_5 . They are then heated in vacuum nearly to the melting point and finally sublimed by stronger heating.

PROPERTIES:

Dark crystals with metallic luster. Very similar in appearance to iodine. M.p. slightly above $400^\circ C$. Slightly soluble in alcohol, benzene, and toluene.

REFERENCES:

- L. Birckenbach. Ber. dtsch. chem. Ges. 40, 1404 (1907);
E. Dönges. Z. anorg. allg. Chem. 263, 112 (1950).

Bismuth Oxide Iodide

BiOI

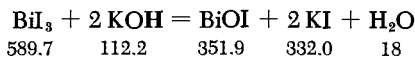

A precipitate of BiOI is formed when BiI_3 is shaken with some dilute KOH. It is suction-filtered, washed and dried.

Other preparative methods: A solution of 20 g. of $Bi(NO_3)_3$ in 30 g. of glacial acetic acid is stirred into a cold solution of 7 g. of KI and 10 g. of sodium acetate in 400 ml. of H_2O . When the precipitate becomes brick red, it is filtered off, washed and dried.

A solution of 0.25 g. of Bi_2O_3 in 40 ml. of hydriodic acid (d. 1.2) is diluted with six liters of water. The whole is heated on a water bath; crystalline BiOI immediately precipitates.

A solution of 30.5 g. of $BiONO_3$ in 30 ml. of concentrated nitric acid is mixed with 60 ml. of H_2O and 60 ml. of glycerol. The solution is stirred with 125 ml. of 25% sodium hydroxide and 175 ml. of H_2O . The clear solution is diluted with H_2O to one liter. Then a solution of 33 g. of KI in 50 ml. of H_2O plus 60 ml. of acetic acid is added. After two hours it is suction filtered and washed. The yield is 32 g. of 91% pure material.

PROPERTIES:

Brick-red crystalline powder or copper-colored crystals. Only slightly attacked by hot water. Fuses at red heat with partial decomposition.

REFERENCES:

- A. deSchulten. Bull. Soc. Chim. France [3] 157 (1900);
B. Fischer. Die neueren Arzneimittel [New Pharmaceuticals], 3rd ed., p. 20.

- F. François and M. L. Delwaille. Bull. Soc. Chim. France [4] 53, 1104 (1933);
 Q. Minigoja and M. P. de Almeida. Arquiv Biol. (São Paulo) 26, 182 (1942) [Chem. Abstr. 1944, 48 759].

Bismuth Oxide Nitrite

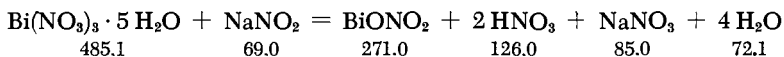

A mixture of 48.4 g. of crystalline bismuth (III) nitrate and 18.2 g. of mannitol is ground in a mortar. The mass is kneaded thoroughly until it is viscous and sticky. It is then allowed to stand until it can be readily stirred with the pestle. Then 100 to 300 ml. of water is added. (The mixture must not be allowed to stand for a long time without water, since it will decompose with generation of NO_2 .) The mixture is stirred until dissolved; it is filtered and a solution of NaNO_2 added. A thick slurry of $\text{BiONO}_2 \cdot 1/2\text{H}_2\text{O}$ crystals precipitates. The slurry is suction-filtered and washed until it no longer shows an acid reaction. It is then dried on clay.

PROPERTIES:

Formula weight ($\text{BiONO}_2 \cdot 1/2\text{H}_2\text{O}$) 280.0. Yellow-white crystals. Loses NO_2 above 60° . Loses its water of crystallization in vacuum over H_2SO_4 .

REFERENCE:

- L. Vanino and E. Hartl. J. prakt. Chem. [2] 74, 150 (1906).

Bismuth (III) Phosphate

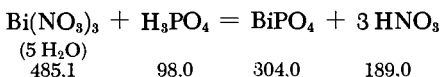

- I. A bismuth (III) nitrate solution (prepared as described above under BiONO_2) is precipitated by H_3PO_4 or a phosphate solution. The precipitate is removed by suction filtration and washed.
 II. A mixture of 15 g. of $\text{Bi}(\text{NO}_3)_3 \cdot 5\text{H}_2\text{O}$ and 7 g. of $\text{Na}_2\text{HPO}_4 \cdot 12\text{H}_2\text{O}$ is placed in a large flask with some water and concentrated

nitric acid and heated on a water bath. Water is added dropwise until microscopic crystals precipitate.

PROPERTIES:

When prepared as described in method I, it contains three moles of water of crystallization. Preparations produced as described in method II contain no water of crystallization. Does not melt on heating. Only slightly soluble in water and dilute acids. Not hydrolyzed by boiling water. *d.* 6.323. The anhydrous form is monoclinic.

REFERENCE:

L. Vanino and E. Hartl. *J. prakt. Chem.* [2] 74, 151 (1906).

Bismuth (III) Borate

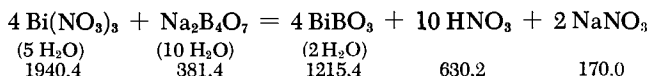
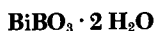

A solution of bismuth (III) nitrate and mannitol, prepared as described above under BiONO_2 , is precipitated with borax solution. The finely granular crystal powder is removed by suction, washed and dried.

PROPERTIES:

Formula weight ($\text{BiBO}_3 \cdot 2\text{H}_2\text{O}$) 303.85. White powder. Attacked by water and alkalis.

REFERENCE:

L. Vanino and E. Hartl. *J. prakt. Chem.* [2] 74, 151 (1906).

Sodium Bismuthate



A) ANHYDROUS

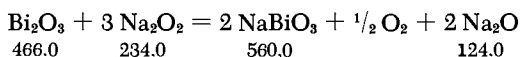

Dry Bi_2O_3 is mixed with half its weight of Na_2O_2 and heated in a vessel protected from access of moisture and CO_2 . The initial

heating (to 350°C) is rapid. It is then continued to about 600°C until gas generation ceases. The cooled sample should evolve no gas when carefully immersed in water. It is preferable to work with sintered magnesia crucibles.

PROPERTIES:

Yellow powder. Rapidly oxidizes acidified manganese (II) sulfate solution to permanganate.

B) HYDROUS

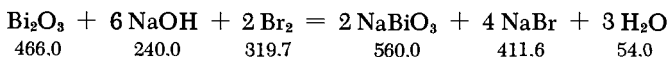

A suspension of 170 g. of Bi_2O_3 in 1.5 liters of 40% sodium hydroxide is vigorously stirred and oxidized at the boiling point by gradually added Br_2 (300 g.). The brown precipitate formed is filtered off, washed with 40% sodium hydroxide, and suspended in three liters of H_2O . The suspension is now agitated for a while, until the color changes from brown through light brown to yellow. The precipitate is then allowed to settle; it is filtered, added to 1.5 liters of 53% NaOH , and refluxed for one half hour. The resultant brown precipitate is readily filtered off after settling. It is washed with 50% sodium hydroxide, placed, while still damp, in three liters of H_2O , and briefly agitated. When the yellow precipitate settles, it is filtered, thoroughly washed with water, and finally dried on clay. The yield is 170 g.

PROPERTIES:

Formula weight 280.0. Fine yellow needles. Variable water content may go as high as 5 H_2O . The usual formula is $\text{NaBiO}_3 \cdot 3.5 \text{H}_2\text{O}$. Reacts with acids with partial decomposition and formation of higher bismuth oxides; oxidizes Mn(II) in H_2SO_4 to MnO_4 in the cold.

REFERENCES:

- E. Zintl and K. Scheiner. *Z. anorg. allg. Chem.* **245**, 32 (1940);
 R. Scholder and H. Stobbe. *Z. anorg. allg. Chem.* **247**, 392 (1941);
 H. Martin-Frere. *Comptes Rendus Hebd. Seances Acad. Sci.* **213**, 436 (1941).

Potassium Bismuthate

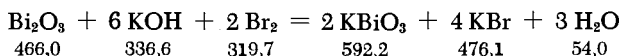

A suspension of 165 g. of Bi_2O_3 in 1.5 liters of 50% potassium hydroxide is oxidized at the boiling point (as described above for

NaBiO₃) with small portions of Br₂ (total 500 g.). A dark violet precipitate results. Now, an additional 500 ml. of hot 40% potassium hydroxide is added and the material is filtered after settling. The precipitate is washed with 40% potassium hydroxide, suspended in 3-5 liters of H₂O, and agitated for a while. The liquid is decanted after some hours; the solid is washed with cold H₂O and filtered. The bright red precipitate is dried over H₂SO₄ in a desiccator. The yield is 205 g. of KBiO₃ · 1/3 H₂O. Formula weight (anhydrous) 296.1.

REFERENCE:

R. Scholder and H. Stobbe. Z. anorg. allg. Chem. 247, 392 (1941).

Dibismuth Tetroxide

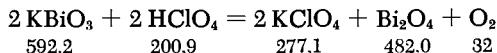

Potassium bismuthate (see above) (50 g.) is boiled for about 10 hours in a large excess of 10% perchloric acid, until a slight residue of only 1-2 g. of an orange-red precipitate is left. The precipitate is filtered off, washed and dried. This is hydrated Bi₂O₄.

REFERENCE:

R. Scholder and H. Stobbe. Z. anorg. allg. Chem. 247, 392 (1941).

*Carbon**a) Elemental Carbon*

U. HOFMANN

Only processes of special importance to the laboratory will be discussed below. The corresponding industrial processes are not described.

The manufacture of diamonds [F. P. Bundy, H. T. Hall, H. M. Strong and R. H. Wentorf. *Nature* (London) 176, 51 (1955)], which involves a great deal of expensive apparatus, will not be treated.

Pure Carbon

The carbon available for industrial or laboratory purposes is not pure. It contains carbon compounds (with H, O, N, S), ash-forming constituents and adsorbed gases or vapors. Preparation of highest-purity carbon, as well as its use in the pure state, may be achieved only in a high-vacuum apparatus [A. Stock et al. *Z. anorg. allg. Chem.* 195, 158 (1931)]. Purity in excess of 99% is usually sufficient. This may be achieved by the following processes, which apply equally to coke-type carbon, carbon black, activated charcoal or graphite.

Removal of ash-forming mineral matter. Exhaustive boiling with dilute HNO_3 or dilute HCl ; ignition to red heat at 900 to 1000°C in a stream of Cl_2 ; treatment with hydrofluoric acid to remove silicates; calcining for several hours at 2000 to 3000°C in vacuum, in CO or in inert gas (this treatment results in structural changes, i.e., graphitization).

Removal of carbon compounds (coking). Solvents are incapable of removing all of these constituents. Complete removal is achieved by calcining for many hours in vacuum or in H_2 , N_2 or inert gas at 900 to 1000°C. If more than a few percent of carbon compounds are present before calcination, the additional formation of C from these carbon impurities will result in structural changes. These structural changes tend chiefly to reduce adsorptive power. This difficulty can be overcome by activation (q.v.) without affecting the purity of the carbon.

Surface oxides (q.v.) can be completely removed as CO and CO₂ at 1000°C.

Removal of adsorbed gases and vapors. It must be borne in mind that adsorptive carbon can take up a few percent by weight of CO₂, H₂O, etc., at room temperature. Purification is achieved by heating for many hours at 300°C in high vacuum.

REFERENCES:

- O. Ruff et al. *Z. anorg. allg. Chem.* 148, 313 (1925).
U. Hofmann et al. *Z. anorg. allg. Chem.* 255, 195 (1947).
U. Hofmann and G. Ohlerich. *Angew. Chem.* 62, 16 (1950).

Special Carbon Preparations

I. CARBON MONOXIDE BLACK

This carbon black deserves more attention because medium-sized graphite crystals of it undergo little aggregation. It is prepared by passing CO over finely divided, pure Fe (e.g., pure iron prepared by reduction of iron carbonyl) at 400-700°C. Depending on the temperature of preparation, the following average crystal sizes are obtained: 50 Å at 400°C, 100 Å at 500°C, 200 Å at 700°C. It should be remembered that any occluded Fe compounds can be removed only by a long purification process (see Pure Carbon).

II. GRAPHITIZED CARBON BLACK

Calcination in vacuum or protective gas for many hours at 2000-3000°C causes the crystallites of the individual carbon black particles to grow into slightly larger crystals, without significantly affecting the size of the particles themselves (channel black about 200 Å, lamp black 500-2000 Å, Thermatomic black about 3000 Å). The product of the calcination is a polyhedron consisting of slightly pyramidal graphite crystals with their vertices directed inward, with its surface composed of the basal planes (001) of graphite.

III. GRAPHITE OXIDE BLACK

This black consists of very thin graphite foils (about 20 to 50 Å thick) the diameter of which, however, may range up to some hundredths of a millimeter, depending on the starting graphite. It is prepared by making graphite oxide from graphite (see Graphite Oxide). The graphite oxide is decomposed by rapid heating to

300–400°C, where it deflagrates. Since the oxygen bound in the graphite oxide evolves as CO and CO₂ in the deflagration, it is possible that the hexagonal network of the carbon black foils contains holes of atomic dimensions.

A better product of otherwise identical properties can be prepared as follows: An alkaline suspension of graphite oxide is reduced with hydroxylamine at 80°C. The agglutination of the foils upon filtering and desiccation can be substantially inhibited by freeze-drying of the salt-free, dialyzed suspension.

In both cases the carbon black contains only about 80% carbon. It also contains O, H, etc., and must be carefully purified by coking and, if necessary, also freed of mineral matter.

IV. LUSTROUS CARBON

Brittle foils with perfectly reflecting surfaces because the basal planes of the graphite crystals are parallel to the foil planes. Surfaces up to several centimeters. Thicknesses up to some tenths of a millimeter. Coatings of lustrous carbon on ceramic materials serve as high electrical resistances. The crystal size is about 25 Å.

The material is prepared by cracking dilute hydrocarbons (e.g., propane vapor at about 10 mm. or N₂ saturated with gasoline vapor at room temperature) at 800 to 1000°C. The material is deposited on a smooth surface such as porcelain or quartz. It is desirable to add some O₂ or water vapor to the hydrocarbon, so as to avoid simultaneous precipitation of reactive, rough-surface carbon. After a thickness of some hundredths of a millimeter has been achieved, the carbon foils either flake off by themselves or may be readily detached after cooling. The best tightly adhering coatings are produced on surfaces that are not completely smooth.

V. GRAPHITE FOILS AND FILMS

a) A sol prepared from 1–2 g. of graphite oxide (q.v.) in 100 ml. of water (well shaken or stirred) is allowed to evaporate. The graphite oxide separates as a foil on the bottom of the vessel. Very careful, slow heating with gradually rising temperature causes the sheet to give off CO, CO₂ and H₂O without deflagration until, at 1000°C, a graphitelike film is obtained. This still contains a few percent of O and H. The size and thickness of the foil is the same as that of the graphite oxide and can therefore be controlled by the amount and concentration of the graphite oxide sol and the size of the vaporization vessel. Films with surfaces as large as 50 cm² can be obtained in this manner.

b) Very pure graphite foils can be produced by igniting foils of lustrous carbon for many hours in vacuum or in CO. The

temperature is 2000-3000°C. The foils are of the same size as those of lustrous carbon, i.e., about 1 cm. in surface diameter.

VI. ADSORPTIVE CARBON (ACTIVATION)

To achieve the best adsorptive power, it is helpful to break down the crystalline aggregations of carbon by careful oxidation. A carbon is considered highly adsorptive if, for example, it adsorbs its own weight of CCl_4 at room temperature from half-saturated CCl_4 vapor.

This breaking down of structure is effected most simply by calcining at 950°C in a stream of CO_2 or H_2O vapor and is continued until half the carbon has burned off. It suffices to pass the CO_2 slowly over the carbon spread in a thin layer in a boat. Subsequent removal of the adsorbed CO_2 or H_2O by heating for many hours at 300°C in high vacuum is recommended. If surface oxides have formed due to adsorbed air, they may be removed by heating to red heat.

REFERENCES:

- I. U. Hofmann. Ber dtsch. chem. Ges. 61, 1180 (1928); Z. Elektrochem. 42, 504 (1936).
- II. U. Hofmann et al. Kolloid-Z. 96, 231 (1941); A. Ragoss et al. Kolloid-Z. 105, 118 (1943); H. P. Boehm. Z. anorg. allg. Chem. 297, 315 (1958).
- III. G. Ruess and F. Vogt. Mh. Chem. 78, 222 (1948).
- IV. K. A. Hofmann and U. Hofmann. Ber. dtsch. chem. Ges. 59, 2433 (1926); G. Ruess. Z. anorg. allg. Chem. 255, 263 (1947).
- Va. H. Thiele, Forschungen und Fortschritte 10, 408 (1934); German patent 600 768.
 - b. U. Hofmann. German patent 752 734.
- VI. O. Ruff and G. Rössner. Ber. dtsch. chem. Ges. 60, 411 (1927); U. Hofmann et al. Z. anorg allg. Chem. 255, 195 (1947).

Surface Compounds of Carbon

This section is devoted to chemical compounds formed on the surface of the graphite crystal.* The internal structure of the crystal is not significantly changed by the surface compounds, which is not the case with graphite compounds.

*Chlorine is probably bound not at the surface of the graphite crystal but by hydrocarbon impurities present in the material (see DEGUSSA, Nachrichten aus Chemie und Technik, August 21, 1954).

I. OXYGEN COMPOUNDS REACTING AS ACIDS IN AQUEOUS SOLUTIONS

Preparation involves heating the carbon for many hours in a stream of O_2 at a temperature as near as possible to the ignition point, i.e., $500^\circ C$. During oxidation, the carbon must be vigorously shaken or, better still, fluidized by the O_2 stream. Since oxidation produces CO_2 , which is then absorbed, it is recommended that the oxidation product be subjected to long heating at $300^\circ C$ in high vacuum. It should be remembered that the oxidation is accompanied by activation with O_2 .

If a highly adsorptive carbon is used, as much as 15 g. of O_2 can be taken up by 100 g. of the carbon. Under the same conditions, steam produces acid groups whose concentration may reach 700 meq. of H^+ ions per 100 g. of the preparation. The material is tested by shaking 0.1 g. of the carbon with 100 ml. of 0.05N alcoholic KOH. The H^+ ions can be replaced by CH_3 groups through methylation with diazomethane. Because of the acidic surface oxides, the carbon is readily wetted by water and poorly by benzene, as contrasted with carbon having no acid surface oxides. Above $500^\circ C$, O_2 is released as CO and CO_2 .

II. OXYGEN COMPOUNDS REACTING AS BASES IN AQUEOUS SOLUTIONS

These compounds are always formed when carbon comes into contact with air or O_2 at room temperature. Their formation can only be avoided when contact is prevented. These basic compounds may coexist on the surface of the carbon with the acid-forming O compounds. With highly adsorptive carbon these compounds may exert, in aqueous solution, an effect equivalent to a concentration of 100 meq. of OH^- ions per 100 g. of carbon.

The material is tested by shaking with 0.05 N HCl. The basic surface oxides probably participate in the catalytic decomposition of H_2O_2 on carbon and when carbon is used as an oxygen electrode.

Above $500^\circ C$, the O is released as CO and CO_2 .

III. SULFUR COMPOUNDS

Carbon and excess S are heated for two days at $600^\circ C$ in a sealed tube. The product is then washed thoroughly in a Soxhlet apparatus with CS_2 , toluene and alcohol. A highly adsorptive carbon can take up as much as 30 g. of S per 100 g. of preparation. Above $500^\circ C$, the preparations release S, and as the temperature rises, CS_2 is also generated.

REFERENCES:

1. H. Kruyt and G. de Kadt, *Kolloid-Z.* **47**, 44 (1929); U. Hofmann and G. Ohlerich, *Angew. Chem.* **62**, 16 (1950).

Regarding preparation with concentrated nitric acid, see U. Hofmann and G. Ohlerich, above.

- II. A. Frumkin. *Kolloid-Z.* 51, 123 (1930); G. Brinkmann. *Angew. Chem.* 61, 378 (1949).
- III. J. P. Wibaut and E. J. v.d. Kam. *Rec. Trav. Chim.* 49, 121 (1930); R. Juza and W. Blanke. *Z. anorg. allg. Chem.* 210, 81 (1933); U. Hofmann and G. Ohlerich. *Angew. Chem.* 62, 16 (1950).

b) Graphite Compounds

W. RÜDORFF

Alkali Graphite Compounds

These may be prepared with melts or vapor of the alkali metals K, Rb and Cs. Depending on the proportions and/or the reaction temperature, the compounds resulting have the following approximate compositions: C_8M (1st stage), $C_{24}M$ (2nd stage), $C_{36}M$ (3rd stage) and $C_{48}M$ (4th stage).

C_8K

The apparatus is that of Fig. 207. Section *B* of the approximately 22 mm. I.D. glass tube is charged with about 1 g. of powdered or ground graphite which prior to use has been thoroughly heated at 900°C in high vacuum. An ampoule or glass tube containing pure K metal is introduced into *A* in a stream of N_2 , the open end facing *a*. After the reactor tube is sealed off at *a*, the K is distilled into *B* in high vacuum. Then an electrical heater maintained at 300°C is placed over *A* and *B*. It is desirable to rotate the tube in ground joint *E* after some time so that even the graphite particles adhering to the glass at the bottom may react as completely as possible. The conversion is complete when the preparation acquires a dark copper color and is homogeneous. If some blue or black particles have formed, then the heating period was too long or the temperature too high. If this is the case, some K is distilled back from *C* to *B* and the heating operation is repeated. After all the excess K has been distilled away from *B*, the material is permitted to cool. The apparatus is then filled with N_2 and sealed off at *b* and *c* and the tube is raised to a vertical position, so that the product is separated from the K-wetted glass wall *C* and collects at *D*. Here the attached storage tubes (only one of which is illustrated) are filled and then torch-sealed.

$C_{24}K$

The preparation corresponds to that for C_8K but the furnace is kept at 360°C. The end of the conversion is identified by the

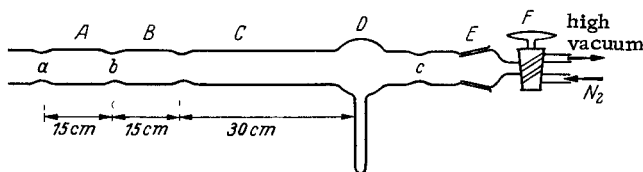

Fig. 207. Preparation of alkali graphite compounds.

uniformly steel-blue color of the preparation. Precautions must be taken to ensure that part of the preparation does not again turn brown by absorbing K vapor when the furnace is cooled. If this is the case, heating must be continued. If heating is continued for too long, the products are poor in K.

$C_{36}M$ AND $C_{48}M$

These are prepared from a stoichiometric mixture of graphite powder or flakes and K metal by heating for 20 hours at 300 to 400°C in an evacuated, sealed tube.

Rubidium graphite and cesium graphite are prepared in similar fashion.

Analysis. After weighing, the tubes containing the substance are cut open and the contents are discharged into a preheated Erlenmeyer flask (C_8M and $C_{24}M$ either ignite or smolder in the flask). After cooling, the graphite is boiled with water, filtered and washed. The alkali in the filtrate is determined by volumetric analysis. The dried graphite, which still contains a few percent of alkali, is repeatedly boiled (until fuming) with concentrated H_2SO_4 and then calcined. The ash content of the starting graphite is calculated from the weight of the alkali sulfate obtained.

PROPERTIES:

C_8K is dark copper-red. Larger crystals have a metallic bronze color. $C_{24}K$ is steel blue with a metallic luster. The compounds poorer in alkali are blue-black to black. These materials are very sensitive to O_2 and moisture. They ignite in air.

Structure of C_8M : there is an expanded graphite lattice, in the c direction, with alkali layers in each vacancy of the C lattice. In $C_{24}M$, $C_{36}M$, $C_{48}M$, each second, third, or fourth layer vacancy of the C lattice is expanded by an intercalated alkali layer.

REFERENCES:

K. Fredenhagen and G. Cadenbach. *Z. anorg. allg. Chem.* **158**, 249 (1926).

K. Fredenhagen and K. Suck. *Z. anorg. allg. Chem.* 178, 353 (1929).
 A. Schleede and Wellmann. *Z. phys. Chem. (B)* 18, 1 (1932).
 W. Rüdorff and E. Schulze. *Z. anorg. allg. Chem.* 277, 156 (1954).

Alkali Ammine Graphite Compounds

Prepared from graphite and alkali metal dissolved in liquid ammonia.

About 2 g. of powdered or flake graphite and the stirring bar of a magnetic stirrer are introduced into vessel *c*, which has a fritted glass disc (Fig. 208). After careful drying of the apparatus

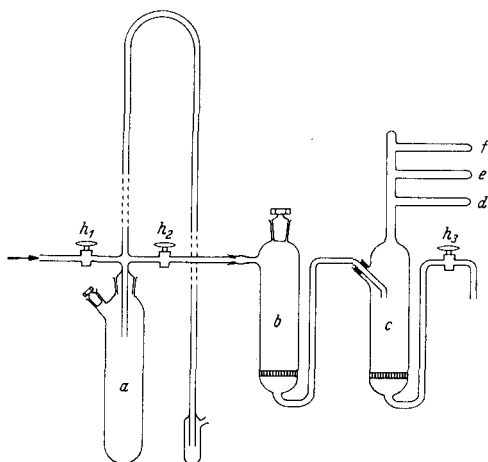

Fig. 208. Preparation of alkali ammine graphite compounds.

and displacement of the air with pure N_2 , NH_3 (liquefied over Na in vessel *a*) is condensed in *b* on the alkali metal (Li, Na, K, Rb or Cs—at least 1/30 gram-atom). Stopcock h_2 is closed and the solution is siphoned from *b* into *c* by cooling vessel *c*. To complete the reaction in *c* the contents are well stirred after removal of the cooling bath. This may cause the solution to boil (if this occurs, stopcock h_2 is opened). The solution must still be blue. If it is not, additional alkali metal must be added. Finally, stopcock h_3 is opened and the solution forced with NH_3 pressure through the frit and into another, well-cooled vessel. To wash the graphite, NH_3 is condensed in *c* once or twice and forced out of the vessel in the same manner as before. Then *c* is brought to room temperature. When no further NH_3 escapes through the pressure release valve, the apparatus is purged with N_2 and the

product is poured into tubes *d*, *e* and *f*, which are then sealed.

Analysis: The contents of a weighed ampoule are placed in an Erlenmeyer flask containing 50-70 ml. of ice-cold 2N H_2SO_4 . The decomposed product is boiled for one half hour and the graphite is filtered off and washed. The alkali is determined as sulfate in an aliquot of the filtrate; KOH is added to another aliquot, and the NH_3 is distilled off and determined by volumetric analysis. The dried graphite is treated as described for potassium graphite compounds.

PROPERTIES:

The compound approximates $C_{12}M(NH_3)_2$. Very dark blue, enlarged crystals. Very sensitive to air and moisture. The K, Rb and Cs compounds can be stored indefinitely, but the Li and Na compounds decompose in a few days to amides, evolving H_2 .

REFERENCE:

W. Rüdorff, E. Schulze and O. Rubisch. Z. anorg. allg. Chem. 282, 232 (1955).

Graphite Oxide

Prepared by oxidation of graphite with $KClO_3$ in a mixture of concentrated sulfuric and nitric acids.

Graphite (10 g.), as ash-free and uniform as possible, is suspended in a mixture of 175 ml. of concentrated H_2SO_4 and 90 ml. of 68% HNO_3 . A total of 110 g. of $KClO_3$ is added in small portions over a period of several days to the cooled flask. The product is repeatedly stirred with 6 to 10 liters of distilled water, then settled and decanted until the wash water is neutral to litmus. As washing progresses the blue-green particles become brown and swell increasingly as the salts are removed. At the end of the washing the settling is slow and incomplete. (Purification requires several weeks, and is shortened somewhat by use of a centrifuge.) The brown slurry is suction-filtered as much as possible, spread out to dry in air, ground and dried to constant weight in vacuum at $50^\circ C$ over P_2O_5 .

A light, almost white graphite oxide is obtained by washing in the dark with 5% HCl , containing ClO_2 . This product contains only about 0.5% ash, but after vacuum-drying still shows a very small amount of chlorine.

Good yields of products with higher oxide contents can be achieved only when a well-crystallized graphite is used as the starting material, since otherwise the resulting oxidation products

are mostly soluble. It is advisable to use a graphite of uniform particle size, in the range 0.01-0.3 mm. The coarser the particles, the longer the time required for oxidation.

Washing of the preparation with acetic acid and ether is not recommended, as this results not only in adsorption but in acetylation of the OH groups of the graphite oxides (see References, G. Ruess).

Additional preparative methods: A faster method (Hummers and Offeman) proceeds as follows: 100 g. of finely milled graphite and 50 g. of NaNO_3 are stirred together in 2.3 liters of ice-cooled concentrated H_2SO_4 . With vigorous stirring, 300 g. of KMnO_4 is added over a period of many hours. The rate of addition is governed by the particle size of the graphite. The temperature of the mixture must not exceed 20°C . The mixture is then heated to 35°C and after 30 minutes is slowly reacted with 4.6 liters of water. The reaction temperature must not exceed 70°C . The hot suspension is then held at 70°C for another 15 minutes. After dilution to 14 liters, the MnO_2 and excess KMnO_4 are reduced with 3% H_2O_2 . The yellow-brown suspension is filtered while still warm and washed as above.

Anodic oxidation in concentrated HNO_3 results in graphite with only a low degree of oxidation.

For methylation of graphite oxide with diazomethane in ether or dioxane solution, see references (Hofmann and Holst; Ruess).

SYNONYMS:

Graphite oxyhydroxide, graphitic acid.

PROPERTIES:

No definite formula. The C:O atomic ratio varies between 6:1 and 6:2.5. The ratio between C atoms and OH groups is about 4:1.

The dry material is brown to black. Very hygroscopic because of intercrystalline swelling. With careful heating to 100°C and above, CO and CO_2 are split off. Deflagrates on rapid heating. Hydrogen ion content (graphitic acid) available for exchange is about 600 meq./100 g. Readily reduced to graphitelike products by Sn^{2+} , Fe^{2+} , HI, N_2H_4 , NH_2OH , etc. Resistivity of the dry preparation is, depending upon the O content, between 10^3 and 10^7 ohm·cm.

Structure: Tetrahedrally inclined C planes with metastable bond at the O and simultaneous bonding of the OH groups.

Applications: Depolarizer in dry cells, membranes for measurement of the partial pressure of water vapor, membrane electrodes.

REFERENCES:

- U. Hofmann and E. König. *Z. anorg. allg. Chem.* 234, 311 (1937).
U. Hofmann and R. Holst. *Ber. dtsch. chem. Ges.* 72, 754 (1939).
G. Ruess. *Kolloid-Z.* 110, 17 (1945); *Mh. Chem.* 76, 381 (1946).
A. Clauss, R. Plass, H. P. Boehm and U. Hofmann. *Z. anorg. allg. Chem.* 291, 205 (1956).
A. Clauss and U. Hofman. *Angew. Chem.* 68, 522 (1956).
A. Clauss, U. Hofmann and A. Weiss. *Z. Elektrochem.* 61, 1284 (1957).
W. S. Hummers and R. E. Offeman. *J. Amer. Chem. Soc.* 80, 1339 (1958).

Carbon Monofluoride

Prepared by fluorination of graphite at 400 to 500°C.

The fluorination apparatus consists of a Cu trap, cooled with liquid nitrogen to remove impurities in the F₂ stream, and a long Cu reactor tube, about 2 cm. in diameter, screwed onto the trap. A cap, opening into a thin Cu tube 1 to 2 mm. in diameter, is screwed to the other end of the Cu tube.

About 1 g. of graphite is spread out in a thin layer in a Cu boat placed in the middle of the reactor tube. The thermocouple is insulated from the tube wall by a thin layer of asbestos. A thicker asbestos layer protects it from contact with the furnace windings. The hot junction is, of course, exposed.

The graphite is thoroughly heated at 800 to 900°C in high vacuum for an hour or two immediately before the fluorination. Only after complete cooling in high vacuum is N₂ admitted.

A slow F₂ stream (3-6 liters/hr) is passed through the apparatus and over the graphite at room temperature for 20 minutes before the start of the fluorination proper. Only then is the furnace turned on. The reaction starts between 420 and 500°C, but the initial conversion proceeds quietly within a narrow range of only about 30°. The temperature at the onset of the reaction is significantly dependent upon the size of the graphite crystals and the HF and O₂ content of the F₂ stream. With very finely powdered graphite of <0.01 mm. particle size and with impure F₂, combustion to volatile carbon fluorides may occur even at 400°C. Preparations that are already well fluorinated will tolerate temperatures as high as 520°C toward the end of the reaction. Deflagration always occurs above 550°C.

The progress of the reaction is followed by cooling the graphite in a stream of F₂ and weighing. If no weight gain occurs within an hour, the reaction may be presumed to be over. The total fluorination time is four to seven hours.

The yield, based on the graphite, is almost quantitative, but when fluorination is continued for longer periods, slight losses,

due to combustion to volatile carbon fluorides, are sustained. The fluorine content computed from the weight gain is usually 1% less than the real content.

Analytical determination of F is accomplished by decomposition with metallic Na in a sealed iron tube at 900°C. The Na is removed with alcohol, and the F precipitated as PbFCl after filtering off the C.

SYNONYM:

Graphite fluoride.

PROPERTIES:

Depending on experimental conditions, the fluorination products have compositions varying between $CF_{0.68}$ and $CF_{0.99}$. When the F content is low, the preparation is gray black, while at very high F contents it is silver white. Depending upon F content, the densities vary between 2.78 and 2.50 (in xylene). The resistivity is greater than 10^6 ohm · cm.

The preparations are not wetted by water and are neutral to acids and bases. Hydrogen has no effect below 400°C. Reduced to graphite on boiling with Zn dust and glacial acetic acid. Above 400°C thermal decomposition to volatile carbon fluorides occurs. When heating is rapid and the temperatures high, this is accompanied by deflagration and flame.

Structure: Tetrahedrally inclined C planes with F atoms bonded above and below the C planes.

REFERENCES:

- O. Ruff, O. Brettschneider and E. Ebert, *Z. anorg. allg. Chem.* **217**, 1 (1934).
W. Rüdorff and G. Rüdorff, *Z. anorg. allg. Chem.* **253**, 281 (1947).

Tetracarbon Monofluoride

Prepared by fluorination of graphite at room temperature in the presence of HF.

A stream of F_2 at 4-5 liters/hr. is passed through a copper wash flask held at 0°C and filled with anhydrous HF, and then through an attached Cu tube (about 2 cm. in diameter). A Cu boat containing a thin layer of about 1 g. of graphite is placed in the tube. The end of the tube is closed with a screw-on cap having a narrow opening. The reaction is finished after one or two hours,

as shown by the constant weight of the product. To remove excess HF, the preparation is washed with dilute base, water and alcohol and dried to room temperature over soda-lime. The yield is quantitative.

Quantitative determination of F is carried out in the same manner as with carbon monofluoride.

PROPERTIES:

The composition lies within the range $C_{3.6}F$ to C_4F . The color of the preparation is velvety black, sometimes somewhat bluish. d (under xylene) 2.05-2.09. Resistivity 2-4 ohm · cm. at 750 kg/cm²

Stable to acids, bases and the common organic reagents. Slowly decomposes when heated for a long period above 100°C. Deflagrates when rapidly heated over a flame, forming sootlike flakes.

Structure: Flat C layers as in graphite, with F atoms bonded above and below the C layers.

REFERENCE:

W. Rüdorff and G. Rüdorff. Ber. dtsh. chem. Ges. 80, 417 (1947).

Graphite Salts

Prepared by oxidation of graphite in the presence of anhydrous acids.

GRAPHITE BISULFATE

An agitated suspension of about 1 g. of graphite (coarse or finely crystalline) in 10 ml. of concentrated H_2SO_4 is mixed with a solution of CrO_3 or $K_2Cr_2O_7$ in concentrated H_2SO_4 . At least 3 meq. of active oxygen (100 mg. of CrO_3 per g. of C) is required for complete oxidation of the graphite. After 15 minutes the graphite is uniformly dark blue and can be suction-filtered through a glass frit and washed with H_2SO_4 . Removal of the adhering H_2SO_4 may be accomplished only by very long washing with sirupy pyrophosphoric acid or quick washing with ice-cold dimethyl sulfate. The reaction is virtually quantitative when coarse crystalline graphite is used, but when fine crystalline carbon is employed, brown, colloidal oxidation products also appear.

When oxidation is incomplete or the blue bisulfate is reduced with Fe (II), Sn (II) or with graphite itself, the product is less highly oxidized and the color is no longer blue.

The analytical composition may be determined from the quantity of oxidants consumed in preparation, from the oxidizing effect

upon reducing agents, or by determination of the sulfate content after washing with $H_4P_2O_7$ or $(CH_3)_2SO_4$.

Additional preparative methods: The graphite may also be oxidized with $S_2O_8^{2-}$, PbO_2 , HIO_3 , HIO_4 , Mn(III) and Mn(IV) compounds, as well as anodically.

PROPERTIES:

The composition of the blue compound corresponds (in acid) to about $C_{24}^+ HSO_4^- \cdot 2 H_2SO_4$.

The product is as crystalline as the initial graphite, but swollen and very dark blue. It may be stored only under concentrated acid. Decomposed immediately by water, humid air, alcohol, ether, acetone and benzene.

STRUCTURE:

In the blue bisulfate, layers of acid anions and molecules are intercalated between the C planes. In the less oxidized black products, acid layers are intercalated in regular sequence in each second, third, fourth, etc., layer vacancy.

GRAPHITE NITRATE, GRAPHITE PERCHLORATE

Prepared by washing graphite bisulfate (see above) with fuming nitric acid (d 1.52) or with 70% $HClO_4$, respectively, until the filtrate is free of sulfate ions, or by oxidation of graphite in the corresponding acids, N_2O_5 being present in the case of nitrate and CrO_3 in the case of perchlorate. The conversion of the bisulfate is reversible.

Properties and structure correspond to those of graphite bisulfate.

For other salt-type graphite compounds with HF, H_2SeO_4 , H_3PO_4 and H_3AsO_3 , see the references.

REFERENCES:

- W. Rüdorff and U. Hofmann. Z. anorg. allg. Chem. 238, 1 (1938).
W. Rüdorff. Z. anorg. allg. Chem. 254, 319 (1947).

Bromine Graphite

Prepared by action of bromine upon graphite.

Coarse or fine crystalline graphite, in a weighing bottle, is allowed to stand over bromine in a desiccator for many hours at room temperature. The maximum weight gain of the graphite is 0.82-0.84 g. per g. of C.

PROPERTIES:

The composition corresponds to an atomic ratio C:Br of about 8:1.

Black to blue-gray crystals, as in the starting graphite, but enlarged. Most of the Br_2 taken up is desorbed in air and can be washed out with water.

Structure: Graphite lattice with a bromine layer in every second layer vacancy.

REFERENCE:

W. Rüdorff. Z. anorg. allg. Chem. 245, 383 (1941).

Metal Halide Graphite Compounds

Prepared from graphite and anhydrous metal halides, e.g., FeCl_3 , AlCl_3 , GaCl_3 , InCl_3 , MoCl_5 , UCl_5 , etc. With the exception of FeCl_3 , these metal halides can be intercalated only in the presence of free chlorine.

A) IRON (III) CHLORIDE GRAPHITE

A glass tube of about 2 cm. I.D. is used. At least 5 g. of anhydrous FeCl_3 is sublimed onto 2 g. of coarse or fine crystalline graphite. The tube is sealed off on both sides and heated for 24 hours in an electric tubular furnace at a constant temperature of 200-300°C. One end of the tube is then withdrawn from the furnace, and the heating is continued at the same temperature until no further uptake of the desublimed FeCl_3 can be observed.

PROPERTIES:

Black, highly enlarged crystals. The FeCl_3 content depends upon the temperature of desublimation and is in the range of 60-70% FeCl_3 . When heating is rapid, there is pronounced swelling with elimination of FeCl_3 . The crystals release FeCl_3 in water, dilute acids, alcohol or benzene. Depending on the size of the crystals, the washed preparations contain 52-56% FeCl_3 .

B) ALUMINUM CHLORIDE GRAPHITE

Preparation is similar to that presented above under (A). About 3-4 g. of AlCl_3 is sublimed in a stream of dry Cl_2 onto 1 g. of graphite. The sealed reaction tube (capacity about 40 cm^2) must

be well filled with Cl_2 . The heating of the reaction mixture and subliming of the excess AlCl_3 are carried out at 150 to 200°C.

PROPERTIES:

Very dark blue, lustrous, highly enlarged crystals; releases AlCl_3 and Cl_2 when heated above 260°C; very hygroscopic. Water and organic solvents dissolve out much of the intercalated AlCl_3 . Precipitates iodine when added to KI solution. The compound corresponds approximately to $\text{C}_{30}^+\text{AlCl}_4^- \cdot 2\text{AlCl}_3$.

Structure of *A* and *B*. Graphite lattice expanded in the *c* direction with a layer of metal halide in each layer vacancy.

REFERENCES:

- W. Rüdorff and H. Schulz. *Z. anorg. allg. Chem.* 245, 121 (1940).
 W. Rüdorff and R. Zeller. *Z. anorg. allg. Chem.* 279, 182 (1955).
 W. Rüdorff and A. Landel. *Z. anorg. allg. Chem.* 293, 327 (1958).

c) Volatile Carbon Compounds

O. GLEMSER

Carbon Monoxide

CO

I. FROM FORMIC ACID

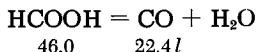

A gas generator (one-liter round-bottom flask with ground glass dropping funnel and gas outlet tube) two-thirds full of concentrated phosphoric acid is heated to 80°C in a water bath. Formic acid is then added slowly, drop-by-drop. Removal of impurities (CO_2 , air, acid vapors, water vapor) is effected by passing the gas successively through 50% KOH solution and an alkaline solution of $\text{Na}_2\text{S}_2\text{O}_4$ (25 g. of $\text{Na}_2\text{S}_2\text{O}_4$ in 125 ml. of H_2O , plus by 20 ml. of 70% KOH) and over KOH, CaCl_2 and P_2O_5 .

Traces of O_2 may also be removed with a glowing carbon filament [K. Clusius and W. Teske. *Z. phys. Chem. (B)* 6, 135 (1929)]. Larger quantities of oxygen are removed in a purification train consisting of three wash bottles in series, two of which contain 100 g. of slightly amalgamated Zn and 100 ml. of 0.1M VOSO_4

solution, while the third contains 100 ml. of H_2O [L. Meites and T. Meites. *Anal. Chem.* **20**, 984 (1948)].

Very pure CO is obtained by liquefaction of the gas and double fractionation (impurities $<10^{-3}$ mole%).

II. FROM OXALIC ACID

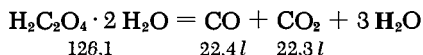

A mixture of 100 g. of oxalic acid dihydrate and 275 ml. of concentrated H_2SO_4 is heated carefully in a round-bottom flask until the onset of gas generation, which must not be allowed to proceed too vigorously. The CO_2 , formed in equal amounts with the CO, is absorbed in two wash bottles each containing 100 ml. of 50% KOH solution. Purification is the same as in method I.

Other preparative methods: III. From formic acid or barium formate and phosphoric acid [J. G. Thompson. *Ind. Eng. Chem.* **21**, 389 (1929)]. This method is particularly suitable for a continuous process and gives a 92% yield.

IV. From concentrated H_2SO_4 and cyanides [J. Wade and L. C. Panting. *J. Chem. Soc. (London)* **73**, 255 (1898)].

V. By dry heating of a mixture of CaC_2O_4 and CaO (A. Klemenc. *Die Behandlung und Reindarstellung von Gasen [Treatment and Purification of Gases]*, Vienna, 1948, p. 159).

Procedures IV and V are not as satisfactory as I.

VI. Small amounts of very pure gas may be prepared by thermal decomposition of $\text{Ni}(\text{CO})_4$ [A. Mittasch. *Z. phys. Chem.* **40**, 1 (1902); C. E. H. Bawn. *Trans. Faraday Soc.* **31**, 440 (1935)].

VII. From CaCO_3 powder and Zn dust at 700 to 750°C; very pure gas results [S. Weinhouse. *J. Amer. Chem. Soc.* **70**, 442 (1948)].

Purification of tank CO: Possible impurities: CO_2 , O_2 , H_2 , CH_4 , N_2 , $\text{Fe}(\text{CO})_5$. The gas is passed slowly through a tube filled with reduced copper wire and heated to 600°C; this removes O_2 and $\text{Fe}(\text{CO})_5$. The activated Cu-filled tube of Meyer and Ronge (see section on Nitrogen, p. 458) may also be used. The CO then flows through a tower filled with moist KOH to absorb the CO_2 . Should further purification (particularly removal of H_2) be necessary, the CO must be liquefied and fractionally distilled.

PROPERTIES:

Formula weight 28.01. Poisonous, colorless and odorless gas. M.p. -205.1°C , b.p. -191.5°C ; crit. t. -140.2°C ; crit. p. 34.5 atm.; triple pt. p. 115.0 mm. Burns with a blue flame; ignition point 700°C in the air; lower explosion limit in moist air: 12.5% CO. At elevated temperatures, decomposes into CO_2 and C. Solubility

in H_2O ($0^\circ C$) 3.3, ($20^\circ C$) 2.3 vols. of $CO/100$ g. H_2O . About seven times as soluble in methyl and ethyl alcohols as in H_2O . Readily soluble in acetic acid, $CHCl_3$ and ethyl acetate. d (liq., $-195^\circ C$) 0.814; d (gas, $0^\circ C$) 1.250 g./liter. Heat of formation -26.39 kcal./mole.

REFERENCES:

- I. E. Rupp. Chem.-Z. 32, 983 (1908); J. Meyer. Z. Elektrochem. 15, 506 (1929).
- II. F. Schacherl. Pub. Fac. Sc. Univ. Masaryk 99, 5 (1928); A. Klemenc. Die Behandlung und Reindarstellung von Gasen [Treatment and Purification of Gases], Vienna, 1948, p. 160.

Carbon Dioxide

 CO_2 PURIFICATION OF TANK CO_2

Possible impurities: water vapor, CO , O_2 and N_2 , sometimes accompanied by traces of H_2S and SO_2 .

I. Moderately Pure CO_2 : The gas is passed sequentially through the following vessels: 1) two wash bottles with $Cr(II)$ acetate solution or $VOSO_4$ solution to remove the bulk of the O_2 (also see CO , method I); 2) a U tube containing small pieces of $KHCO_3$ (for removal of acid vapors); 3) a U tube with pumice impregnated with $CuSO_4$ solution, or a wash bottle filled with 1M $KMnO_4$ solution or 1M $K_2Cr_2O_7$ solution (removal of H_2S); 4) a wash bottle with concentrated sulfuric acid (for drying); and 5) a Meyer and Ronge tube filled with activated Cu and Cu_2O heated to $200^\circ C$ (see description of the purification of N_2 , p. 458) for removal of the last traces of O_2 and CO . Instead of 3 and 4, R. Weber recommends [Angew. Chem. 65, 136 (1953)] that organic compounds and H_2S be removed by passing the gas through a mixture of 100 volumes of H_2SO_4 (d 1.84) and 3.3 volumes of aqueous formaldehyde (40 vol. %).

If a given impurity is not present, the corresponding purification step may be omitted.

II. Purer CO_2 : The gas is passed through saturated $CuSO_4$ through $KHCO_3$ solution, and finally through a fractionator (Klemenc and Bankowski). This apparatus is a portion of the equipment presented in Fig. 153 (p. 345) for the preparation of very pure H_2S . To fractionate CO_2 one employs only the section to the right of wash bottle 4, consisting of eight well-cooled U tubes and two low-temperature traps. Immediately before the last condensation trap A_2 , a mercury manometer tube is inserted on a side tube. The CO_2 is frozen out in A_1 after passing through the first four

U tubes, cooled to the temperatures indicated in the figure. When A_1 is sufficiently full, stopcock a is opened, the tube is sealed off at point c , and the remaining apparatus is evacuated to a low pressure. After the remaining four U tubes have been cooled to -78°C (Dry Ice-acetone), the liquid nitrogen is removed from around A_1 , the first fraction of gas is siphoned off, and condensation vessel A_2 is immersed in liquid nitrogen. The middle fraction is collected in A_2 , the residue being left in A_1 . The material is sublimed twice from A_2 and the purity of the gas is checked by its vapor pressure at various temperatures. The gas is stored in 25-liter glass flasks which have been degassed by heating in high vacuum at 350°C for many hours.

SYNONYM:

Carbonic acid anhydride.

PROPERTIES:

Formula weight 44.01. Colorless, odorless gas. Subl. t. -78.48°C (atmospheric pressure); m.p. -56.7°C (5 atm.); crit. t. 31.3°C ; crit. p. 72.9 atm.; crit. d 0.464; triple pt. -56.6°C at 5.11 atm. Vapor pressure (-120°C) 10.5; (-100°C) 104.2; (-82°C) 569.1 mm.

Solubility in H_2O . (0°C) 171; (20°C) 88; (60°C) 36 ml. of $\text{CO}_2/100$ g. of H_2O .

d (vapor, 0°C) 1.977 g./liter; d (liq., 0°C) 0.914 (34.4 atm.); d (solid, -56.6°C) 1.512. Heat of formation -94.05 kcal./mole.

REFERENCES:

- I. L. Moser. *Z. anorg. allg. Chem.* 110, 125 (1921).
- II. A. Klemenc and O. Bankowski. *Z. anorg. allg. Chem.* 208, 348 (1932); 209, 225 (1932).

Tricarbon Dioxide



I. THERMAL DECOMPOSITION OF MALONIC ACID IN THE PRESENCE OF P_2O_5

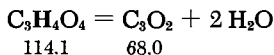

Flask a of the apparatus illustrated in Fig. 209 is charged with 20 g. of malonic acid, 40 g. of calcined sand and 200 g. of fresh, uncaked and well mixed P_2O_5 . The system is evacuated to 0.1 mm.,

stopcock *h* is closed, and the apparatus is left to stand for some hours to complete the drying and to test for leaks. The pump is then started, stopcock *m* is opened once again, *d* is cooled with liquid nitrogen and *a* is heated on an oil bath to 140°C. At this temperature, decomposition is complete within about an hour and impure C_3O_2 condenses in *d*. Now the oil bath is removed, *m* is closed, the pump is stopped, dry air is introduced at *k*, and *a* is removed from the system and sealed off at *c*. The system is again evacuated, *m* is closed, and the contents of *d* are slowly distilled into trap *h*, cooled with liquid nitrogen. Plugging of *h* should not be allowed to occur. Acetic acid and other impurities are absorbed

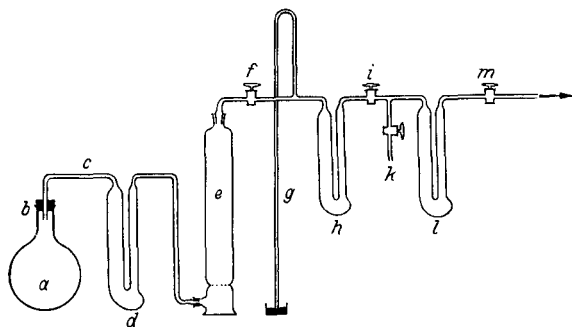

Fig. 209. Preparation of tricarbon dioxide from malonic acid. *a*) one-liter reaction flask; *b*) rubber stoppers, lightly greased; *c*) connecting tube, 10 mm. I.D. *d*, *h* and *l*) traps; *e*) drying tower containing pea-sized, freshly calcined pieces of $CaCO_3$; *g*) 800-mm.-long manometer tube.

in the lime tower and the material is fractionated in high vacuum with stopcock *f* closed. This is done by placing *h* in an alcohol bath ($-110^\circ C$ to $-115^\circ C$), while *l* is cooled with liquid nitrogen, stopcock *i* is closed, and the condensate in *h* is melted. Then *h* is again immersed in the alcohol bath, *i* is opened, and distillation into *l* proceeds. Pressure changes are followed on the manometer. When the manometer pressure is still but a few tenths of a millimeter, the vapor pressure is determined at $0^\circ C$ and compared with that of the pure gas (573.5 mm.).

Separation of the $C_3O_2-CO_2$ mixture (CO_2 is a product of the side reaction $C_3H_4O_4 = CH_3COOH + CO_2$) is difficult. Therefore, when the solid phase (CO_2) has disappeared, it is advisable to reduce the bath temperature to $-125^\circ C$ or $-130^\circ C$ for completion of the separation. Fractionation takes about 15 hours (A. Klemenc, loc. cit.).

A. Klemenc, R. Wechsberg, and G. Wagner have suggested inserting before the lime tower a tube filled with glass wool to retain the P_2O_5 , condensing the reaction products ahead of stop-cock f' in a liquid-nitrogen-cooled vessel, and finally distilling once again into h via a tube filled with glass wool and a lime tower.

The yield of C_3O_2 is 2.94 g. (22%). Determination of yield: C_3O_2 (alone or mixed with other gases) is passed through a solution of aniline in xylene. The malonanilide formed is virtually insoluble in xylene and precipitates as colorless crystals, m.p. 223°C.

Additional preparative method: Thermal decomposition of diacetyltartaric anhydride (Klemenc et al.). The yield is better, but the C_3O_2 contains ketene, which cannot be completely separated.

SYNONYM:

Carbon suboxide.

PROPERTIES:

Formula weight 68.03. Colorless, highly refractive liquid or colorless, poisonous gas of stifling odor. M.p. -112.5°C , b.p. 6.7°C ; d_4^{20} 1.114; vapor pressure (0°C) 573.5 mm. (corr.).

Attacks hydrocarbon but not silicone grease. The gas can be stored at pressures of up to 100 mm., but it is common even at these pressures for polymerization to occur, giving a red, water-soluble product. This invariably occurs at higher pressures or in the liquid state. The presence of P_2O_5 facilitates polymerization. Decomposes when passed through heated glass tubes, forming a mirror surface.

Soluble in CS_2 and xylene. Quantitatively decomposed by water (within one hour) to malonic acid. Forms malonamide with ammonia. Heat of formation 47.4 kcal./mole.

REFERENCES:

- A. Stock and H. Stoltzenberg. Ber. dtsh. chem. Ges. 50, 498 (1917).
- A. Klemenc. Die Behandlung und Reindarstellung von Gasen [Treatment and Purification of Gases], 2nd ed., Vienna, 1948, p. 164.
- A. Klemenc, R. Wechsberg and G. Wagner. Monatsh. Chem. 66, 337 (1935).

Carbonyl Chloride



PURIFICATION OF TANK $COCl_2$

Possible impurities: CO_2 , CO, air, HCl and H_2O , total approximately 1%.

I. *Small quantities*: The COCl_2 is removed from the tank and condensed with an ice-salt mixture. To remove the volatile portion, about a fifth of the condensate is permitted to evaporate, and the residue is fractionated in high vacuum until all fractions have the same vapor pressure. The pure gas has a vapor pressure (0°C) of 556.5 mm.

II. *Larger quantities, moderate purity requirements*: Carbonyl chloride is condensed in a flask with sealed-in gas inlet tube and cooled with an ice-salt mixture. A water-cooled bulb-type reflux condenser is placed on top of the flask. The condenser is connected to a Hempel gas burette filled with $7-8^\circ\text{C}$ water. The burette is joined to a downward condenser (cooled with ice-salt), which in turn is connected to a receiver. The cooling mixture is removed from around the flask, about a fifth of the liquid is permitted to evaporate, and the receiver is cooled, thus condensing the COCl_2 . The impurity content is less than 0.4%.

Analytical determination: Carbonyl chloride is shaken with an aqueous aniline solution and the diphenylurea product is determined gravimetrically or, after conversion to NH_3 , colorimetrically.

SYNONYM:

Phosgene.

PROPERTIES:

Formula weight 98.92. Colorless, highly poisonous gas of stifling odor reminiscent of rotten hay.

M.p. -128°C , b.p. 7.5°C ; crit. t. 181.7°C ; crit. p. 55.3 atm; vapor pressure (0°C) 556.5 mm.

Strongly attacks stopcock grease; may be stored in glass vessels at 0°C . Very slightly soluble in cold water. Hot water hydrolyzes it readily to HCl and CO_2 . Readily soluble in benzene, toluene, glacial acetic acid, CCl_4 and hexamethylenetetramine, as well as in AsCl_3 and S_2Cl_2 . Decomposes to CO and Cl_2 on heating (503°C , 50%; 800°C , 100%).

d (liq., 0°C) 1.436; vapor d (18.6°C) 1.392 g./liter. Heat of formation -53.3 kcal./mole.

REFERENCES:

- I. A. Stock and E. Wustrow. Z. anorg. allg. Chem. 147, 245 (1925).
- II. E. Paternò and A. Mazzuchelli. Gazz. Chim. Ital. 50, 30 (1920).

Carbon Disulfide



PURIFICATION OF COMMERCIAL MATERIAL

Possible impurities: dissolved S, H_2S , H_2SO_3 , H_2SO_4 , organic sulfur compounds, H_2O .

Half a liter of CS_2 is shaken for an hour with 100-200 g. of Hg and some P_2O_5 ; the mixture is filtered and the filtrate is distilled in a column, in the dark if possible. The low-boiling fraction and the high-boiling fraction (recognizable by the yellow color of the residue in the distillation flask) are discarded. The bulk of the distillate is shaken once again with Hg and P_2O_5 and fractionally distilled, and the first and last cuts are discarded. These steps are repeated until no black HgS is formed. If a very pure product is desired, distillation in high vacuum is necessary. If the only impurity is H_2S , a single fractionation is sufficient.

Testing for purity: Residue: When concentrated by evaporation on the water bath, 50 ml. of CS_2 should leave no residue. Dissolved S: When thoroughly agitated with dry Hg in a dry vessel, the Hg must not acquire a dark coating. H_2S : No brown tint should appear on shaking with lead carbonate. For H_2SO_3 and H_2SO_4 : If H_2O shaken with the CS_2 gives an acid reaction, either H_2SO_3 or H_2SO_4 is present.

SYNONYMS:

Carbon bisulfide, dithiocarbonic anhydride.

PROPERTIES:

Formula weight 76.13. The liquid is water clear and highly refractive, with an odor of ether. F.p. -111.6°C , m.p. -108.6°C , b.p. 46.25°C ; crit. t. 273.05°C ; n_D^{20} 1.6295; vapor pressure (0°C) 127.3 mm.

Decomposes on standing for a long time, especially in light. Decomposition is recognized by the unpleasant odor. Burns with a blue flame to CO_2 and SO_2 ; ignition point 236°C .

Slightly soluble in H_2O ; soluble in ethyl alcohol, benzene, ether, and essential and aliphatic oils.

d_4^{20} 1.293, d_4^{20} 1.262. Heat of formation 21.0 kcal./mole.

REFERENCES:

- A. Stock, A. Brandt and H. Fischer. Ber. dtsh. chem. Ges. 58, 643 (1925).
L. Vanino. Handb. d. präp. Chem., 2nd ed., Vol. 1, Stuttgart, 1921.

Tricarbon Disulfide



Prepared by reaction of Zn with liquid CS_2 in an electric arc:

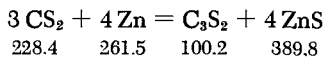

Chemically pure CS_2 (1500 ml.), previously agitated with Hg and P_2O_5 and then fractionated, is placed in a two-liter round-bottom flask immersed in ice up to the neck. A three-hole stopper—for CO_2 inlet tube and for the two 6-mm. brass wires of the electrode holder—is fitted loosely into the flask opening. The cylindrical zinc anode (15–20 mm. long, 6 mm. diameter) is supported on a brass wire with two right-angle bends and is placed just above the bottom of the flask. Opposite it is the graphite cathode (80 mm. long, 12 mm. diameter), mounted on the other brass wire. The upper end of this brass wire is connected to the mechanical adjustment device of a differential arc torch and moved downward to prevent interruption of the arc due to vaporization of the electrodes. A stream of CO_2 is now introduced and the two electrodes are brought together. The current is turned on and the electrodes are separated to strike the arc. The current should be 4–5 amp. with 20–25 volts across the terminals. The CS_2 soon becomes opaque due to finely divided carbon.

The reaction product, a red-brown liquid of stifling odor, is filtered, the filter residue washed with some CS_2 and the filtrate shaken with 200 g. of Hg and some P_2O_5 . After filtering, four fifths of the liquid is vaporized on a water bath and then evacuated at room temperature with a pump until all the CS_2 is expelled. The remaining red fluid is distilled in high vacuum into a receiver cooled to -40°C , in which the C_3S_2 condenses as a yellowish red solid substance of high purity. The yield is 800–850 mg. of C_3S_2 (50% of theoretical) when the arc is on for five hours.

Determination of C_3S_2 : The CS_2 solution, concentrated to about 100 ml., is completely vacuum distilled into a cold flask, and the condensate, consisting solely of CS_2 and C_3S_2 , is treated with excess Br_2 , allowed to stand for a few hours, and evaporated in a stream of dry air. The residue is yellow $\text{C}_3\text{S}_2\text{Br}_6$, stable in air.

SYNONYM:

Carbon subsulfide.

PROPERTIES:

Bright red, highly refractive liquid with a strong odor that affects the mucous membranes. M.p. -0.5°C ; vapor pressure (50°C) 8 mm., (90°C) 48 mm.

Decomposes above 90°C. Solutions of C_3S_2 in CS_2 containing more than 1% C_3S_2 are not stable and gradually precipitate black polymerization products. Sunlight has the same effect, even in dilute solutions. At 160°C, pure C_3S_2 yields a solid black product. With aniline, C_3S_2 forms thiomalonanilide.

REFERENCES:

- A. Stock and P. Praetorius. Ber. dtsh. chem. Ges. 45, 3568 (1912);
 A. Stock, A. Brandt and H. Fischer. Ber. dtsh. chem. Ges. 58,
 643 (1925).

Carbonyl Sulfide

COS



Carbon monoxide is admitted into the apparatus shown in Fig. 210 to expel the air and pure S in σ is heated to the boiling point. The side tube d is heated to 350°C by an electric furnace. The resultant COS flows, together with the CO, through vessels e , f and g , and is condensed in the trap h . Tube g_1 is kept at -20°C; g_2 and g_3 are at -60°C. The condensed gas still contains some 2% of impurities, which are removed by high-vacuum distillation.

The gas rate must be so regulated that excessive quantities of S dust do not reach the vicinity of the cooled rubber stopper, or the tube will readily be plugged. The optimum flow rate is approximately eight liters/hour, in which case the yield is 75%.

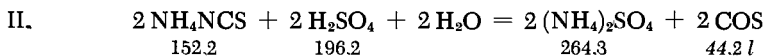

A cooled mixture of 2080 g. of concentrated H_2SO_4 and 1000 g. of H_2O is placed in a round-bottom flask provided with a gas outlet tube and immersed in a water bath. Saturated NH_4NCS solution (200 ml.) is added from a dropping funnel. The water bath is now heated to about 30°C, resulting in a vigorous generation of gas. The solution is shaken back and forth. The evolved gas (impurities consist of NH_3 , H_2S , CS_2 , CO_2 , HCN , H_2O , etc.) passes through a ten-bulb tube filled with 33% NaOH. It is then dried in two lime-filled drying towers and in another filled with $CaCl_2$ and is finally condensed in a U tube kept at -70°C. The yield is 75%, based on $HNCS$.

The gas is separated from the admixed CO_2 (0.1 vol.%) by high-vacuum fractionation. Qualitative test for CO_2 in COS: reaction

with $\text{Ba}(\text{OH})_2$ solution. Pure COS shows no discernible initial reaction.

PROPERTIES:

Formula weight 60.07. Colorless, poisonous gas with a mild odor. M.p. -138.2°C , b.p. -50.2°C ; vapor pressure (-75°C) 210 mm. Mixtures of air and COS are explosive when they contain between 11.9 and 26.5 vol.% COS. At 300°C , COS decomposes to CO and S. In air, burns with a blue flame to give CO_2 and SO_2 . May be stored when dry; hydrolyzed by water and water vapor. Water reacts slowly, yielding CO_2 and H_2S . Absorbed and rapidly decomposed by KOH. Solubility (20°C) 0.54 ml. of COS/g. of H_2O ; (22°C) 8 ml. of COS/ml. of alcohol; (22°C) 15 ml. of COS/ml. of toluene. Solubility in CS_2 is even greater. d (liq., -87°C) 1.24; vapor d (0°C) 1.073 g./liter. Heat of formation -33.9 kcal./mole.

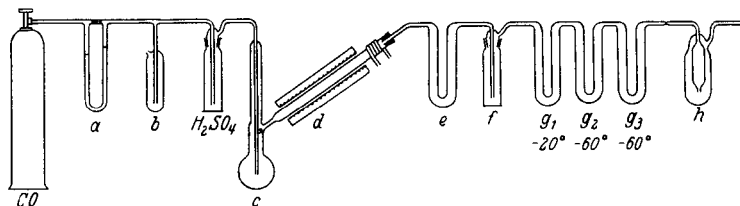
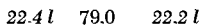

Fig. 210. Preparation of carbonyl sulfide. *a*) manometer-type flowmeter; *b*) safety valve; *c*) reaction vessel; *d*) reaction tube, 400 mm. long and 25 mm. I.D., filled with pea-sized pieces of pumice, the top end wrapped with a water-cooled lead coil and closed with a rubber stopper; *e*) U tube with copper turnings; *f*) wash bottle with 33% NaOH, cooled with ice water; *g*) traps; *h*) trap cooled with liquid nitrogen, preceded by a tube constriction for sealing off.

REFERENCES:

- I. A. Stock and E. Kuss. *Ber. dtsh. chem. Ges.* 50, 159 (1917); A. Klemenc. *Z. anorg. allg. Chem.* 191, 246 (1930).
- II. P. Klason. *J. prakt. Chem.* (2) 36, 67 (1887).

Carbonyl Selenide



Carbon monoxide, generated from formic and phosphoric acids, is passed through 50% KOH solution, dried with KOH, CaCl_2 and

P_2O_5 , and passed through a flow meter into a Vycor or ceramic reaction tube in which Se is heated to 780°C . Because of the Se dust, the apparatus shown in Fig. 210 is used. However, section d is not filled with pumice and is not heated. The gas then passes through the various traps, which are cooled with ice, Dry Ice and liquid nitrogen. The condensate from the trap cooled with liquid nitrogen is fractionated in high vacuum. The yield at 15 liters of CO/hour is about 9.8 vol.% COSe.

Determination of yield: The gas mixture is introduced into a glass bulb of known volume and hydrolyzed for 15 minutes with 2N NaOH; air is then admitted while the solution is heated and the precipitated Se is weighed after washing with water and methyl alcohol and drying at 105°C .

Analysis: A weighed amount of COSe is absorbed in KOBr solution. At the end of the reaction, concentrated hydrochloric acid is added until the solution is mildly acidic. It is then reduced to elemental Se at 70°C by addition of hydrazine sulfate. After cooling, the material is filtered, washed with water and methanol, dried at 105°C and reweighed.

Other preparative method: $\text{Al}_2\text{Se}_3 + 3\text{COCl}_2 = 2\text{AlCl}_3 + 3\text{COSe}$ (O. Glemser and T. Risler).

PROPERTIES:

Formula weight 106.97. Colorless, very poisonous gas, with a characteristic odor reminiscent of H_2Se . M.p. -124.4°C , b.p. -21.7°C ; vapor pressure (-31.4°C) 498.7 mm.; crit. t. 121.1°C .

Hydrolyzes with water or water vapor, precipitating red Se. Acids act slowly, while oxidizing acids and H_2O_2 oxidize it to SeO_3^{2-} . Alkaline solutions hydrolyze it rapidly and quantitatively to Se^{2-} and CO_3^{2-} . Decomposed into CO and Se by porous substances such as activated charcoal. Very soluble in COCl_2 .

d (liq., 41°C) 1.812.

REFERENCES:

T. G. Pearson and P. L. Robinson. J. Chem. Soc. (London) 1932, 652.

O. Glemser and T. Risler. Z. Naturforsch. 3 b, 1 (1948).

Carbon Diselenide

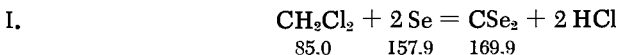

As shown in Fig. 211, a dry stream of N_2 is saturated with CH_2Cl_2 vapor, and the gas mixture is introduced into a Vycor

flask in which Se is heated to 550–600°C. The crude product precipitates in the receiver, equipped with a Liebig condenser. The cooling by the condenser is stopped and the liquid is forced with steam into a cooled flask, separated from the H₂O and dried over CaCl₂. It is then distilled at 46°C and 50 mm. in a fractionating column (30 cm. long).

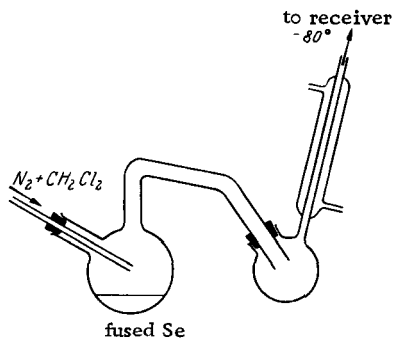
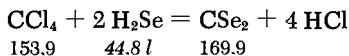

Fig. 211. Preparation of carbon diselenide.

A deposit of C forms in the reaction zone. This may inhibit the reaction under certain conditions. This deposit can be prevented by adding the Se in smaller portions.

The yield is greater if the reaction vessel employed is of the same type as that used to produce COS (Fig. 210) and if the inclined tube *d*, which is empty in this experiment, is heated to 200°C with an electric furnace. The entraining of red Se dust by the gas stream is thus greatly decreased. The yield is 52%, based on the Se charged.

II.



A stream of oxygen-free N₂ is passed into a wash bottle equipped with a glass frit and filled with H₂O. The bottle is held at 64°C (p = 180 mm.) and the gas mixture is run, without condensing the vapor, through a tube filled with finely divided Al₂Se₃ and pumice. The outlet mixture of N₂ and H₂Se gases is dried with CaCl₂. A stream of N₂ is saturated with CCl₄ in the same manner in a second wash bottle (20°C, 90 mm.). The rate of the two gas streams is six liters/hour. The two streams are combined in a 500-mm.-long Pyrex tube heated to 500°C, and then passed

through two traps held at -70°C (Dry Ice-acetone). At the end of the reaction, H_2O is added to the condensate, and CCl_4 and CSe_2 are distilled from the higher boiling impurities (e.g., selenium chlorides). The distillate is fractionated in an efficient column, first at atmospheric pressure, then at 125 mm. At 68°C virtually pure CSe_2 distills over. This is distilled further.

SYNONYM:

Carbon selenide.

PROPERTIES:

Golden yellow, highly refractive liquid; odor of rotten radishes. M.p. -45.5°C , b.p. $125-126^{\circ}\text{C}$ (760 mm.); vapor pressure (0°C) 4.7 mm.; n_D^{20} 1.845.

Very sensitive to light; turns brown and finally black on standing. Burns with difficulty. When heated in a sealed tube to 150°C , solidifies to a black mass (polymerizes?). Insoluble in H_2O ; dissolves, yielding a yellow liquid, in CS_2 , CCl_4 , ether, benzene, nitrobenzene, dioxane, ethyl acetate and acetone. Slightly soluble in glacial acetic acid and alcohol, decomposing these rapidly; pyridine behaves in the same manner. Dissolves copious quantities of flowers of sulfur, but red Se hardly at all. Decomposed on boiling with concentrated nitric acid. Decomposed by concentrated NaOH to a marked degree, but only on heating. d_4^{20} 2.682. Heat of formation 34 kcal./mole.

REFERENCES:

- I. I. G. Ives, R. W. Pittman and W. Wardlaw. *J. Chem. Soc. (London)* **1947**, 1080.
- II. H. G. Grimm and H. Metzger. *Ber. dtsch. chem. Ges.* **69**, 1356 (1936).

Hydrogen Cyanide

HCN

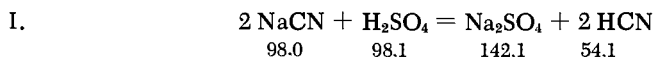

The long-neck, round-bottom flask *a* of the apparatus in Fig. 212, containing 1 kg. of concentrated sulfuric acid, 400 ml. of H_2O , 20 g. of FeSO_4 and a few boiling stones, is heated on a water bath to 90°C and a solution of 1 kg. of commercial NaCN in 1.2 liters

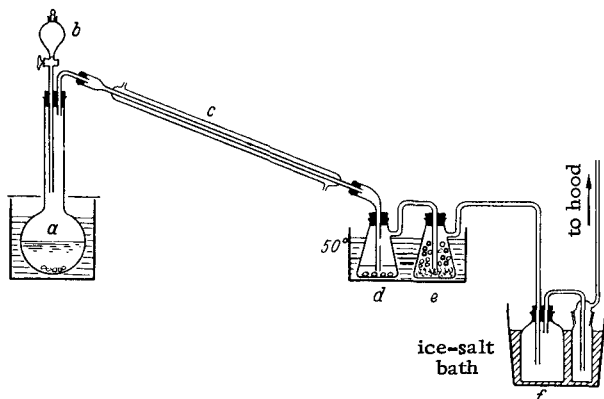
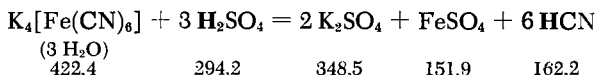

Fig. 212. Preparation of hydrogen cyanide. *a*) five-liter generating flask heated to 90°C; *b*) dropping funnel; *c*) condenser; *d* and *e*) filter flasks; *f*) ground joint flask.

of H₂O is carefully added dropwise. The decomposition ends in 1-1.5 hours. The water bath is then brought to a boil; the HCN is completely driven off within 30 minutes. Water vapor is then removed in condenser *c*, in filter flask *d* containing 20 ml. of 2N sulfuric acid and some boiling stones, and in the second filter flask *e*, containing 200 g. of CaCl₂ over a layer of glass wool. Both the latter and the condenser are heated to 50°C. Hydrogen cyanide is condensed in the ground joint flask *f*, which is cooled with ice-salt mixture. A second condensation flask is attached to the first for safety. The yield is 550 g.

II.



A 200-g. portion of K₄[Fe(CN)₆] · 3H₂O, not too finely crushed, is placed in a round-bottom two-liter flask and a cold mixture of 160 g. of concentrated H₂SO₄ and 250 g. of H₂O is added. The flask is then sealed with a well-seated rubber stopper, through which a 400 mm.-long glass tube of 10 mm. I.D. is inserted. The upper end of the tube connects to a narrow tube, which in turn is connected to three CaCl₂ tubes placed in series below it. These tubes are immersed up to their necks in a 40°C water bath. The last tube has a three-way stopcock which permits discharge to the hood. This stopcock is connected to a mercury check valve, which in turn is connected to a Liebig condenser, the bottom end of which is connected to a well-cooled round-bottom flask by means of a two-hole rubber stopper. An outlet to the hood passes through the other hole.

The flask should be gently heated (sand bath or asbestos plate). The HCN condenses in the Liebig condenser and in the round-bottom flask.

Purification is accomplished by three further distillations, discarding each time the first and last fractions. The material is then fractionated in a vacuum column. High vacuum is used when maximum purity is required.

Storage of HCN: Two drops of concentrated hydrochloric acid are added to the flask, which is then stored in an ice chest. The stopper of the flask should be secured with a wire lock.

Other preparative method: From $\text{Hg}(\text{CN})_2$ and H_2S [J. R. Partington and M. F. Carroll. *Phil. Mag.* (6) 49, 665 (1925)].

SYNONYMS:

Hydrocyanic acid, formyl nitrile, prussic acid.

PROPERTIES:

Formula weight 27.03. Colorless, very poisonous gas; odor of bitter almonds. M.p. -13.24°C , b.p. 25.70°C ; crit. t. 183.5°C ; crit. p. 55 atm.; triple pt. p. 140 mm.; n_D^{20} 1.2675.

Burns with a red-blue flame. Miscible with water, alcohol and ether in all proportions. Weak acid.

d (0°C) 0.715, d (liq., 18°C) 0.691. Heat of formation 30.7 kcal./mole.

REFERENCES:

- I. K. H. Slotta. *Ber. dtsh. chem. Ges.* 67, 1028 (1934).
- II. L. Gattermann. *Liebigs Ann. Chem.* 357, 318 (1907).

Cyanogen

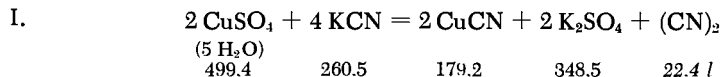

Potassium cyanide solution is permitted to drip on 500 g. of finely pulverized $\text{CuSO}_4 \cdot 5\text{H}_2\text{O}$ placed in a two-liter round-bottom flask with a two-hole stopper for a dropping funnel and gas outlet tube. The rate of addition is determined by the desired rate of gas evolution. If the rate of evolution of $(\text{CN})_2$ becomes too low, the flask is heated on a water bath. The $(\text{CN})_2$ passes through an empty, ice-cooled wash bottle and then a CaCl_2 tube and is condensed in a receiver held at -55°C .

To regenerate the CuCN formed in the flask, the liquid is decanted (after the evolution of gas has ceased) and about 1.2 liters of FeCl₃ solution (d 1.26) is added to the moist cyanide, after which further (CN)₂ may be generated.

For purification, (CN)₂ is passed through an evacuated P₂O₅ tube (300 mm. long, 30 mm. I.D.) and condensed in a flask cooled with liquid nitrogen. The condensate may be redistilled in high vacuum.

II. PREPARATION BY THERMAL DECOMPOSITION OF AgCN

A) SILVER CYANIDE AgCN

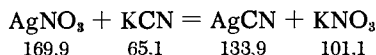

A cold, saturated solution of AgNO₃ is precipitated with the stoichiometric quantity of 78% solution of KCN; the AgCN is rapidly filtered and immediately heated with ammonia (d 0.88). The AgCN that precipitates on cooling is twice recrystallized from ammonia in the same manner and is then dried for four days at 140°C to remove NH₃ and H₂O.

Pale brown powder, stable to light, very slightly soluble in acids.

B) CYANOGEN (CN)₂

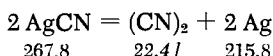

Pulverized AgCN is charged into a Vycor tube connected to a high-vacuum apparatus. The substance is first outgassed in high vacuum at 280-330°C and then heated to 330-380°C, which results in its decomposition and generation of (CN)₂. The gas is passed through a P₂O₅ drying tube and condensed in a receiver cooled with liquid nitrogen. The product, already relatively pure, is refractionated in high vacuum.

Other preparative method: Thermal decomposition of Hg(CN)₂. However, the use of AgCN is more advantageous, because the Hg(CN)₂ readily sublimes without releasing (CN)₂ [J. H. Perry and D. C. Bardwell. J. Amer. Chem. Soc. 47, 2629 (1925)].

SYNONYMS:

Dicyanogen, oxalic acid dinitrile.

PROPERTIES:

Formula weight 52.04. Colorless, poisonous, lachrymatory gas with a stifling odor. M.p. -27.83°C , b.p. -21.15°C ; crit. t. 218.30°C ; crit. p. 59.75 atm.

Burns with a peach-blossom-colored, blue-edged flame; mixtures containing 14 vol.% O_2 are explosive.

Soluble in H_2O , alcohol and ether. The solutions quickly decompose. Polymerizes to solid, brown-black paracyanogen on heating or even in sunlight. Forms HCN and HNCO ("pseudo-halogen") with water.

d (b.p.) 0.954. Heat of formation 62.0 kcal./mole.

REFERENCES:

- I. J. McMorris and R. M. Badger. *J. Amer. Chem. Soc.* **55**, 1954 (1933).
- II. R. P. Cook and P. L. Robinson. *J. Chem. Soc. (London)* **1935**, 1001.

Cyanogen Chloride

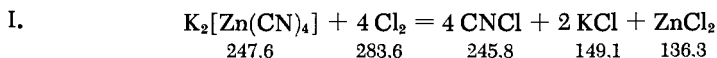
 CNCl 

A solution of 130 g. of KCN in 200 ml. of water is added to a solution of 145 g. of $\text{ZnSO}_4 \cdot 7 \text{H}_2\text{O}$ in 200 ml. of water held in flask *a* (see Fig. 213). This results in a suspension of $\text{K}_2[\text{Zn}(\text{CN})_4]$ in 400 ml. of water. The suspension is vigorously stirred with a ground glass stirrer, the apparatus is purged with N_2 , and Cl_2 is introduced through a fritted glass filter. At a Cl_2 rate of 8 to 10 bubbles per second, a steady, fast stream of CNCl is produced 1-1.5 hours after the start of the run. Prior to gas generation the mixture evolves some heat. This is removed by cooling with running water so as to keep the temperature below 20°C . Foam is broken up by the stirrer in the broad upper section of the reaction flask. The product is dried over CaCl_2 and is frozen out in a receiver cooled with an ice-salt mixture or, even better, with Dry Ice-acetone. After one half of the required quantity has

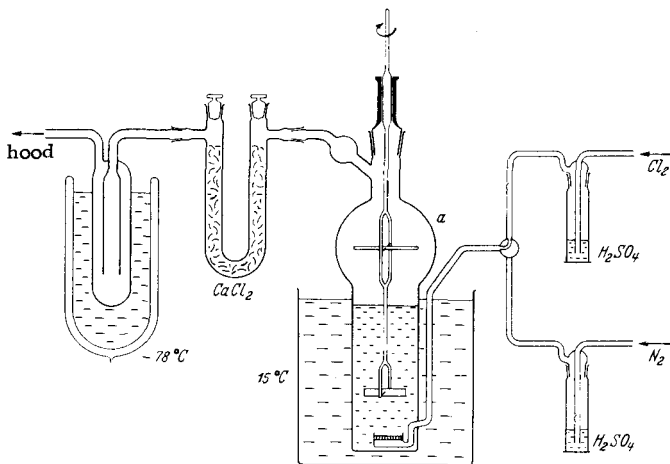
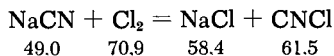

Fig. 213. Preparation of cyanogen chloride.

been introduced the Cl_2 stream rate is reduced every hour by 2 to 3 bubbles per second, so that no unreacted Cl_2 can contaminate the product. After five hours the reaction mixture clears up. The Cl_2 flow is interrupted and the residual CNCl is driven off with N_2 .

The yield of pure CNCl is 98%, based on KCN , and 85% based on Cl_2 . The product requires no further purification. It is entirely free of chlorine. The content of possible impurities other than chlorine is less than 0.1%. The cation bound to the $[\text{Zn}(\text{CN})_4]^{2-}$ complex is not important. Experiments with $\text{Na}_2[\text{Zn}(\text{CN})_4]$ and $\text{Ca}[\text{Zn}(\text{CN})_4]$ result in equally satisfactory yields and equally pure products.

II.



Pulverized NaCN (49 g.) and 170 ml. of CCl_4 are charged into a 500-ml. three-neck flask (see Fig. 214), provided with a mercury seal stirrer and gas inlet and outlet tubes. The flask is cooled to -5 to -10°C in an ice-salt mixture, and the air is displaced with N_2 . Now 2 ml. of glacial acetic acid is added to the reaction mixture, the stirrer is started, and Cl_2 is introduced. The Cl_2 flow rate is adjusted to assure its complete absorption. No gas bubbles

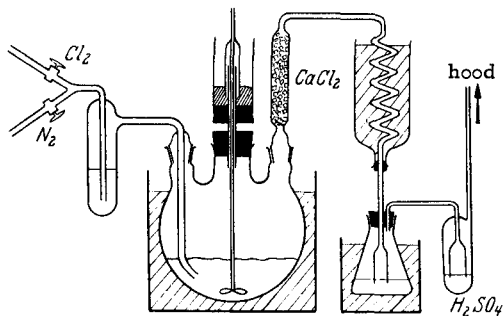

Fig. 214. Preparation of cyanogen chloride.

should form in the wash bottle attached in series with the apparatus. The temperature must be rigorously held at $-5^{\circ}C$ or less, since otherwise $CNCl$ reacts with $NaCN$ to form $(CN)_x$. The reaction ends after about 4.5 hours. The chlorine flow is stopped, the receiver is cooled to $-40^{\circ}C$ with Dry Ice-acetone, the spiral condenser is encased in an ice-salt mixture, and a slow N_2 stream is passed through the apparatus. The temperature of the three-neck flask is allowed to rise to $60-65^{\circ}C$ over a period of 1-1.5 hours, so that all the $CNCl$ distills. The Cl_2 dissolved in the $CNCl$ can be removed either by placing a distillation column cooled with a $-25^{\circ}C$ bath over the Erlenmeyer flask containing the distillate, the $CNCl$ being permitted to reflux while gaseous Cl_2 escapes; or by freezing the product at $-79^{\circ}C$, removing the Cl_2 in a vacuum apparatus, and fractionating the residue. The yield is 44-47 g. (72-77%).

PROPERTIES:

Colorless liquid or colorless, lachrymatory gas. M.p. $-6.5^{\circ}C$, b.p. $13^{\circ}C$; d ($4^{\circ}C$) 1.218. Vapor pressure ($0^{\circ}C$) 445 mm. Attacks Hg slightly. Pure $CNCl$ does not polymerize. Exceptionally poisonous. Therefore, all work must be done under a good hood. The experimenter is strongly advised to protect himself with a gas mask when working with $CNCl$. Solubility: 2.5 liters in 100 ml. of water ($20^{\circ}C$); 10 liters in 100 ml. of alcohol ($20^{\circ}C$); 5 liters in 100 ml. of ether ($20^{\circ}C$).

REFERENCES:

1. H. Schröder. *Z. anorg. allg. Chem.* **297**, 296 (1958); A. Klemenc and G. Wagner. *Z. anorg. allg. Chem.* **235**, 427 (1938).

- II. W. L. Jennings and W. B. Scott. *J. Amer. Chem. Soc.* **41**, 1241 (1919); G. H. Coleman, R. W. Leeper and C. C. Schulze in: W. C. Fernelius, *Inorganic Syntheses*, Vol. II, p. 90, New York—London, 1946.

Cyanogen Bromide

CNBr

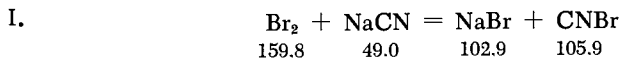

One kilogram of Br_2 (320 ml.) is covered with 150 ml. of water in a two-liter ground joint flask placed under a good hood. The stirrer is then turned on and a solution of 420 g. of NaCN (i.e., one third excess) in 850 ml. of water is added at the rate of 1 drop per second. The temperature of the mixture must be kept below 20°C . Any local excess of cyanide is carefully avoided because it leads to formation of $(\text{CN})_x$. The last 150 ml. of the NaCN solution is diluted with twice that amount of water. Further dropwise addition of the solution is best performed manually, and the flask should be vigorously shaken by hand after each addition. When a persistent brown tint appears the rest of the NaCN solution is discarded. The addition of NaCN takes about five hours.

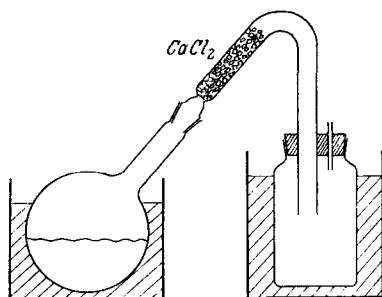

Fig. 215. Preparation of cyanogen bromide.

As shown in Fig. 215, a large diameter tube bent into a V is attached to the round-bottom flask. The shorter arm of the tube is filled with granular CaCl_2 . The flask is placed on a water bath and the CNBr is distilled. It is collected in a 750-ml. powder bottle serving as receiver. The yield of snow-white crystals is 590 g. or 90% of theoretical, based on Br. The material can be stored in this form for a long time. Brownish CNBr is not stable.

The bottles used for storage are preferably closed with corks well coated with paraffin rather than with glass stoppers.

II. A modification of the process in terms of the quantities required is reported by Hartmann and Dreger. Half a kilogram of Br_2 is covered with 50 ml. of water and treated with a solution of 170 g. of NaCN (i.e., about $1/8$ more than the stoichiometric) in 1200 ml. of water (i.e., 2.5 times as much as in method I). The yield is 73-85%.

III. *Other preparative method*: To avoid loss of half the Br_2 in by-product NaBr, Zmaczyński recommends the reaction:

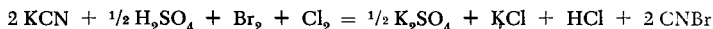

The stoichiometric quantities of H_2SO_4 and Br_2 are added to a KCN or NaCN solution. At the end of the reaction the same quantity of KCN or NaCN is added and Cl_2 is introduced until one drop of the solution causes starch-iodide paper to turn blue. The temperature must be held at 0 to $+5^\circ\text{C}$ during the entire process. Further treatment follows that described in method I.

PROPERTIES:

Formula weight 105.93. Colorless needles. M.p. 52°C , b.p. 61.6°C ; d (20°C) 2.01. Soluble in ether. Because of the high toxicity of the product, all work must be done under an efficient hood. The experimenter should wear a gas mask.

REFERENCES:

- I. K. H. Slotta. Ber. dtsh. chem. Ges. 67, 1029 (1934).
- II. W. W. Hartmann and E. E. Dreger in: Organic Syntheses, Coll. Vol. 2, p. 150, New York, 1948.
- III. E. Zmaczyński. Ber. dtsh. chem. Ges. 59, 711 (1926).

Cyanogen Iodide

CNI

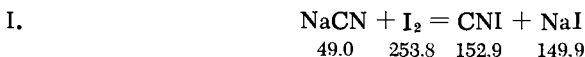

A solution of 27 g. (0.55 mole) of NaCN in 100 ml. of water is allowed to cool to 0°C in a 500-ml., ice-cooled three-neck flask provided with a stirrer and a thermometer and placed under a good hood. Then a total of 127 g. (0.5 mole) of iodine is added in portions of 3-4 g. with vigorous stirring. Each new portion is added only after the previous one has completely reacted. The CNI product

is extracted 10 minutes after the end of the addition, first with 120 ml., then with 100 ml. and finally with 80 ml. of ether. The combined ether extracts are concentrated in vacuum at room temperature. This yields 90 g. of impure, light-brown product. To remove the NaI, which is soluble in the ether solution of CNI [$\text{NaI}_2(\text{CN})$], the crude product is heated to 50°C with 120 ml. of water and shaken for 15 minutes at slightly reduced pressure (about 0.5 atm.). After cooling at 0°C , the colorless, crystalline CNI is separated from the yellow mother liquor by filtration, washed repeatedly with small amounts of ice water, and dried in air (under a hood). The yield is 59 g. (77% based on I).

Cyanogen iodide of highest purity is obtained by recrystallization from chloroform. The total product is dissolved in 150 ml. of boiling chloroform and slowly cooled to -10°C . After filtering, it is again washed with some ice-cold chloroform and dried in air.

II. A modification of this process, in which half of the I_2 is not wasted to form alkali iodide, has been described by Grignard and by Zmaczyński. In accordance with the equation

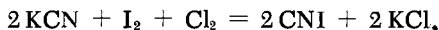

Cl_2 is introduced while the KCN is reacting with the I_2 , or the stoichiometric quantities of H_2SO_4 and I_2 are added to a KCN (NaCN) solution, i.e., one mole of I_2 per mole of starting cyanide. At the end of the reaction, the same amount of KCN or NaCN is added and Cl_2 is introduced until one drop of the solution turns starch-iodide paper blue. The temperature is held at 0 to $+5^\circ\text{C}$ during the entire process. Workup is the same as described above.

PROPERTIES:

Colorless, silky crystalline needles. M.p. (in sealed tube) 146.5°C . Sublimes. Slightly soluble in cold, and readily soluble in hot water; soluble in alcohol and ether.

REFERENCES:

- I. B. Bock and A. Hillebert. *Organic Syntheses* 32, 29, New York-London, 1952.
- II. V. Grignard and P. Crouzier. *Bull. Soc. Chim. France* [4] 29, 215 (1921); E. Zmaczyński. *Ber. dtsch. chem. Ges* 59, 711, (1926).

Cyanic Acid

HNCO

Heating of urea yields cyanuric acid, which is converted to cyanic acid by dry distillation.

A) CYANURIC ACID (CONH)₃

Urea is heated and the resulting crude product is twice recrystallized from hot water. After the first filtration, 10 ml. of concentrated hydrochloric acid is added to one liter of the solution.

Commercial cyanuric acid is purified by recrystallization in the same manner. This step must not be omitted, as otherwise the cyanuric acid will explode on distillation at -30°C , the explosion being accompanied by polymerization.

B) CYANIC ACID HNCO

A 1-m.-long, 25-mm. I.D. Vycor tube is filled with dehydrated cyanuric acid for a length of about 700 mm. in such fashion that a narrow channel remains for dry N_2 , admitted at one end of the tube. The other end of the tube is connected to a 200-ml., two-neck receiver immersed in a cooling bath (Dry Ice-ether). The flow of N_2 is started and the empty section of the tube is brought to red heat with a 250-mm.-long tubular furnace. When the empty section is hot, the end of the furnace is moved toward the cyanuric-acid-filled section and the furnace is advanced as decomposition of the acid proceeds. The reaction product, condensed in the receiver, is evacuated for several hours at -80°C (using an oil pump), shaken with P_2O_5 at -20°C , and distilled into a receiver cooled to -80°C . The final purification proceeds in high vacuum.

The connection between the reaction tube and the receiver must be of large diameter to prevent plugging. The sublimate appearing in the tube itself is not heated, as it will form a great deal of hard-to-separate HCN.

Removal of HCN. Prior to the P_2O_5 treatment, the reaction product is shaken for several hours with some Ag_2O , and distilled over P_2O_5 . The operation is repeated if necessary.

The yield is 80%.

Determination of the HCN content of HNCO. A thin jet of 1 ml. of HNCO is added from a precooled pipette to 40 ml. of 0°C , 1N, vigorously shaken KOH solution. The HNCO is absorbed as cyanate. The CN^- ion is titrated with silver nitrate solution by the Liebig method.

PROPERTIES:

Formula weight 43.03. Colorless liquid with stifling odor. B.p. 23.5°C ; vapor pressure (0°C) 271.0 mm. Soluble in water (dec.). Polymerizes below 150°C to a trimer $(\text{HNCO})_3$ and converts above 150°C to cyanuric acid. At 0°C , liquid cyanuric acid polymerizes within an hour to a mixture of the two substances. Dilute solutions of cyanic acid in ether, benzene or toluene are stable for weeks. $d(\text{liq.}, -20^{\circ}\text{C})$ 1.156. Heat of formation -36.5 kcal./mole.

REFERENCE:

M. Linhard. Z. anorg. allg. Chem. 236, 200 (1938).

Hydrogen Thiocyanate

HNCS

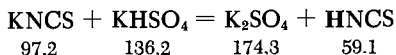

A mixture of KNCS and KHSO_4 is ground together as finely as possible and allowed to stand for 3-4 weeks over P_2O_5 . Then flask *a* of an apparatus such as that shown in Fig. 216 is successively charged (the order of addition should be maintained) with 250 g. of glass beads (6-7 mm. in diameter), 100 g. of KNCS alternated with beads, then a covering layer of glass beads, then the required amount of KHSO_4 mixed with glass beads. Without disturbing these layers, the glass flask is mounted in a rigid support and joined on one side of the horizontal tube *p* via a ground glass spray trap *f*. The other ground glass joint of *a* is closed off with a cap.

Condensation occurs in the two vessels *c* and *d*, in series, the necks of which end in male ground joints. A manifold with ground glass joints connects one neck of each of the vessels to a mercury manometer. An iron-Constantan thermocouple, sealed into a ground joint cap, is inserted into the other neck of each vessel. A side tube from vessel *c* connects it to three-way stopcock h_1 , and vessel *d* is similarly connected to three-way stopcock h_2 . The latter is connected to the pump via a drying tower filled with calcium hydroxide. Air may be admitted via h_2 as required.

Before starting the reaction the vessels are thoroughly dried by heating in vacuum, and then vessel *c* is cooled, with the vacuum on, in a liquid nitrogen bath. The stopcock leading to drying tube *p* is opened. Now flask *a* is rotated on its axis for 5 to 10 minutes, causing the salts to mix and to be ground by the glass beads. The mixing causes HNCS to be generated, cooling flask *a*. It is held at room temperature by a lukewarm water bath. The mixture becomes rose-colored at first $[\text{Fe}(\text{NCS})_3]$ and then turns white to ivory. This color should be maintained until the reaction ends. If the mass becomes yellow, it means that HNCS is decomposing, yielding HCN. In this case, stopcock h_1 must be closed and all further gaseous product is discarded. If the preparation is properly performed, the ivory color remains for 1-1.5 hours. If repeated rotation of *a* results in no further generation of HNCS, the spray device *b* is actuated, which drenches the mass with water vapor

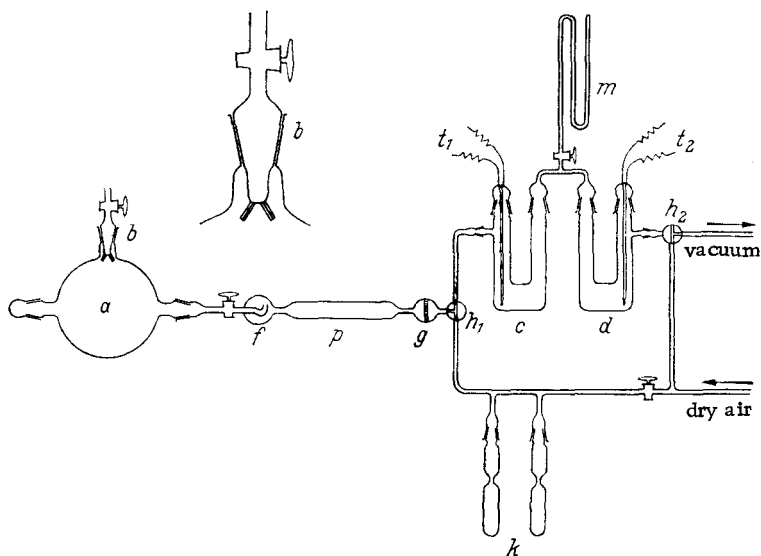

Fig. 216. Preparation of hydrogen thiocyanate. *a*) Pyrex gas generator, two liters; *b*) spray device with two capillary nozzles and stopcock; *f*) spray trap; *p*) drying tube, 500 mm. long, 50 mm. I.D., filled with P_2O_5 , quartz wool, and short glass rods; *g*) fritted glass filter; *h*₁) three-way stopcock, 20 mm. I.D.; *c* and *d*) condenser traps, 400 ml.; *t*₁ and *t*₂) iron-Constantan thermocouples; *h*₂) three-way stopcock; *m*) Hg manometer; *k*) analysis tubes.

and finely divided water droplets when the stopcock is opened and flask *a* is vigorously rotated. Inasmuch as the addition of water significantly influences the amount and purity of the HNCS, it must be held within close limits. The control of the spray is learned with some practice. As the condensation proceeds, the Dewar flask at *c* is moved higher and higher, until finally the entire enlarged section of flask *c* is cooled. If obstructions to gas flow occur in drying tube *p*, then the tube is rotated a few times. The run is ended after 1 to 1.5 hours by closing stopcock *h*₁. It is terminated earlier if the mass in the flasks becomes yellow or the P_2O_5 in tube *p* is exhausted or becomes bright yellow at the points where an obstruction to flow is produced (decomposition of concentrated HNCS solutions in the presence of mineral acids). Finally the product is distilled (in high vacuum) from *c* into *d*. The preparation is virtually pure (m.p. checked with thermocouple *t*₂). The yield is 15-20 g. of solid HNCS.

Analysis of the solid condensate. One part of the substance is distilled into tube *k*, constricted for sealing off (Fig. 216). This tube

is then fused and removed from the apparatus, placed in a measured quantity of excess 0.1N KOH, and the tip is broken off. Removal of the glass fragments by filtration and weighing gives the weight of material by difference. A 100-ml. portion of the filtrate is diluted to 250 ml. and the excess KOH is back-titrated with 0.1N HCl. Another 100 ml. of the filtrate is acidified with nitric acid, and the HNCS content is determined by the Volhard method.

Test for HCN. Volhard method: Titration with AgNO_3 solution in the presence of KI [L. Birckenbach and K. Sennewald. *Liebigs Ann. Chem.* 512, 38 (1934)].

Other preparative possibility: Preparation of a dilute aqueous solution of HNCS from NH_4NCS and water in presence of the hydrogen form of an ion-exchange resin [R. Klement, *Z. anorg. allg. Chem.* 260, 268 (1949)].

SYNONYMS:

Thiocyanic acid, sulfocyanic acid.

PROPERTIES:

White substance with an enamel luster. M.p. -110°C .

Polymerizes between -90 and -85°C to a white crystalline mass. Converts with careful heating in vacuum to bright-yellow, ether-soluble thiocyanuric acid [$(\text{HNCS})_3$?], which readily dissociates into HNCS. If either HNCS or the yellow form is heated at room temperature without evacuation, the material slowly turns dark red, both in the presence and in the absence of air. At about $+3^\circ\text{C}$, a rapid exothermic reaction occurs. The entire mass foams and coalesces into a slurry.

Miscible with water in all proportions. Dilute solutions (<5%) are stable. Very strong acid.

REFERENCE:

L. Birckenbach and E. Buchner. *Ber. dtsh. chem. Ges.* 73, 1153 (1940).

Thiocyanogen



I. A suspension of AgNCS in CS_2 is treated with Br_2 . The AgBr is split off, releasing $(\text{SCN})_2$.

A) SILVER THIOCYANATE AgNCS

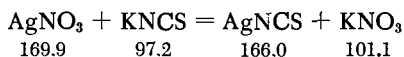

A solution of AgNO_3 is precipitated with the stoichiometric quantity of KNCS ; the precipitate is washed by decantation, filtered and dried at 70°C .

B) THIOCYANOGEN $(\text{SCN})_2$

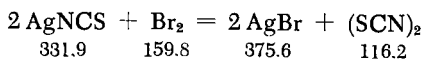

A suspension of 17 g. of AgNCS in 50 ml. of CS_2 (distilled over P_2O_5) is mixed with 8 g. of Br_2 . The suspension is swirled around in the flask during addition. The reaction ends after a few minutes. The resultant AgBr (plus some AgNCS) is filtered off and the solution is cooled in a specimen tube to about -70°C (Dry Ice-acetone cooling bath), precipitating $(\text{SCN})_2$. The thiocyanogen is separated from the CS_2 in the apparatus illustrated in Fig. 217, almost all of which is submerged in a cooling bath held at -70°C (the fritted glass filter should be about 2 cm. below the surface). When filtration is complete, the filter tube is immediately closed off with a rubber stopper and the apparatus is evacuated. After a while, dry air is introduced, the apparatus is removed from the cooling bath, and the receiver containing the mother liquor is rapidly replaced by an empty one. Some concentrated H_2SO_4 is placed in the latter to absorb moisture. The apparatus is then replaced in the cooling bath and evacuated, and once again dry air is introduced after a period of standing in the bath. The operation is repeated three or four times. The yield is 4-5 g. of $(\text{SCN})_2$ (70-90%).

II. Very pure thiocyanogen is obtained by dissociation of nitrosyl thiocyanate in vacuum.

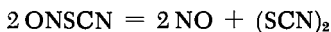
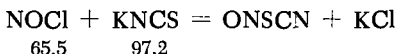

The starting materials are NOCl , free of chlorine and nitric oxide, 2 to 4 g. of which is sealed into ampoules with break-off ends, and anhydrous KNCS , somewhat less than stoichiometrically required for reaction with the NOCl (1 g. of NOCl is equivalent to 1.484 g. of KNCS). About 25 ml. of liquid SO_2 per g. of NOCl (the SO_2 is dried over P_2O_5) is used as the solvent. Finally, a high-vacuum apparatus must be available, to which the

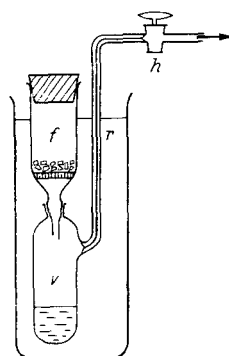

Fig. 217. Preparation of solid thiocyanogen. *f*) filter tube; *v*) receiver (about 50 ml.); *r*) capillary connected to the pump via stopcock *h*.

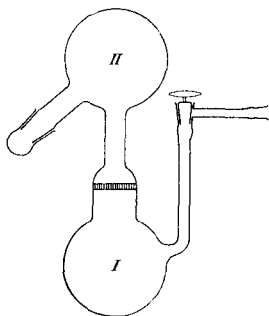

Fig. 218. Preparation of thiocyanogen.

dumbbell apparatus of Fig. 218 and a Stock tip breaker (Fig. 35) can be attached. The latter is used for opening the nitrosyl chloride ampoules.

The KNCS is introduced into the bottom sphere I, and enough SO_2 is condensed on it to cover the salt with a 1.5-cm. layer of liquid. The suspension is then frozen in a liquid-nitrogen bath and the NOCl and finally the remaining SO_2 are condensed on top of the frozen layer. The reaction begins immediately after thawing. The apparatus must be occasionally agitated. The reaction temperature should be about -30°C .

After one hour the resulting deep-red suspension is cooled to -50°C . The apparatus must be immersed in the cooling bath to above the level of the fritted glass filter. The product is evaporated by cooling the flask that originally contained the solvent in a liquid-nitrogen bath. The NOSCN product decomposes at the same time, liberating NO , which is also frozen by the liquid-nitrogen bath. The evaporation must be performed slowly and with care and requires about 10 hours. After the red NOSCN color has almost entirely disappeared, the same amount of solvent is again condensed on the colorless $(\text{SCN})_2$ and the solution is filtered into sphere II. After another careful evaporation at -30°C , completely colorless, pure $(\text{SCN})_2$ is obtained in 100% yield.

Additional preparative method: Electrolysis of NH_4NCS in methyl alcohol solution [H. Kerstein and R. Hoffmann. Ber. dtsch. chem. Ges. 57, 491 (1924)].

PROPERTIES:

White to pale yellow crystals. M.p. $15-16^\circ\text{C}$. At room temperature, explosive conversion to a brick-red, solid material. Decomposed by water to HCN , HNCS and H_2SO_4 . When SCN^- is added to an aqueous $(\text{SCN})_2$ solution, pale yellow $(\text{SCN})_3$ is formed. More electronegative than I_2 ; liberates I_2 from iodides. Soluble in alcohol, ether, CS_2 and CCl_4 .

REFERENCES:

- I. E. Söderbäck. Liebig's Ann. Chem. 419, 217 (1919).
- II. F. Seel and D. Wesemann. Chem. Ber. 86, 1107 (1953).

Ammonium Trithiocarbonate

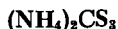

Ammonium pentasulfide (see p. 369) is digested with CS_2 in a wide-neck flask equipped with a reflux condenser and an immersed, water-cooled coil. Colorless $(\text{NH}_4)_2\text{S}$ precipitates on the cold surface of the cooling tube, but is later converted to the pale orange-yellow thiocarbonate.

Other preparative methods: A pure product is obtained from liquid NH_3 , H_2S and CS_2 .

PROPERTIES:

Formula weight 144.27. Pale orange-yellow, very hygroscopic crystals. Decomposes forming CS_2 and $(\text{NH}_4)_2\text{S}$, or CS_2 , NH_3 and NH_4HS . After a long time, the thiocyanate is also formed.

Very soluble in water; slightly soluble in alcohol and ether, soluble in liquid NH_3 , giving a dark-red color. Red, oily H_2CS_3 is produced on addition of concentrated hydrochloric or sulfuric acids.

REFERENCES:

H. Mills and P. L. Robinson. *J. Chem. Soc. (London)* 1928, 2330; G. Gattow, unpublished.

Barium Trithiocarbonate



Prepared by the action of CS_2 on $\text{Ba}(\text{HS})_2$ solution.

Barium hydroxide is dissolved in CO_2 -free distilled water and any precipitated BaCO_3 is filtered off in a nitrogen atmosphere. The solution is then saturated with H_2S . A CS_2 -saturated stream of N_2 is then bubbled through the solution. After addition of ether, the red solution precipitates yellow BaCS_3 . It is separated from the aqueous phase and dried in vacuum or in a stream of N_2 .

Other preparative methods: I. Carbon dioxide-free $\text{Ba}(\text{OH})_2$ is suspended in alcohol, the air is displaced with N_2 , and a CS_2 -saturated stream of N_2 is bubbled through the solution. The $\text{Ba}(\text{OH})_2$ disappears and a yellow precipitate is produced. This is further treated as described above.

II. According to R. Klement and W. Schmidt [*Naturwiss.* 42, 154 (1955)] BaCS_3 can also be obtained on an ion exchanger. A strongly basic OH^- form anion exchanger is converted to the S form by means

of aqueous H_2S or Na_2S . The ion exchanger acquires a greenish color. After washing with water, CS_2 is added to the aqueous suspension of exchanger in an amount corresponding to the exchange capacity. The mixture is shaken until no CS_2 droplets can be discerned. Thus, for example 50 g. of air-dried Amberlite IRA 410 (exchange capacity 4.2 meq./g.) and 4 g. of CS_2 may be used. The ion exchanger, which is now salmon-colored, is placed in an ordinary glass column and eluted with 1.5N $BaCl_2$ until the yellow color of the eluate disappears. When ethanol is added to the eluate, 16 g. of analytically pure $BaCS_3$ (62% of theoretical) is obtained. The exchanger may be reused after successive treatment with acid (2N HCl, for example), base and sulfide.

PROPERTIES:

Formula weight 245.57. Yellow, microcrystalline powder or yellow, hexagonal double pyramids; stable in air; dissolves in water, giving a red color. On heating, decomposes to BaS and CS_2 .

Solubility: 1.08 g./100 g. of H_2O ($0^\circ C$), 1.5 g./100 g. of H_2O ($20^\circ C$). An aqueous solution of $BaCS_3$ dissolves one atom of S per molecule of trithiocarbonate. Heat of formation -130.1 kcal./mole.

REFERENCES:

- E. W. Yeoman. J. Chem. Soc. (London) 119, 38 (1921).
G. Gattow. Symposium über Thermodynamik in Fritzen-Watten (Symposium on Thermodynamics at Fritzen-Watten, Austria), August 20-25, 1959, 19 (1-3), 1959.

Silicon and Germanium

P. W. SCHENK

Silicon

Si

The starting material for preparation of high-purity silicon is either commercial silicon, purified by recrystallization from molten aluminum, or silicon produced by Von Wartenberg's modification of Kühne's method, explained below.

The reaction vessel is a Hessian ceramic crucible or a water-cooled copper ingot mold, which is first packed with finely powdered corundum in the following manner: The bottom is filled to a height of about 1 cm. with corundum powder (sieved through a 0.15-mm. screen), an aluminum tube with a diameter of about 8 cm. (with as smoothly polished a surface as possible) is inserted vertically, and the space between the Al tube and the crucible wall is tightly packed with powdered corundum. The reaction mixture, consisting of one part of Al pellets (99.995%), one part of very pure sulfur (purified by the Bacon and Fanelli or by the Von Wartenberg method, see p. 342), and one part of the purest available quartz sand (rock crystal powder such as used for making transparent fused quartz items—it is especially low in boron), is then packed inside the tube to a height of about 5 cm. The Al tube is then pulled upward 4 cm. and the process is repeated. After three repetitions, the crucible is full. It should not be filled all at once because the friction would make it impossible to withdraw the Al tube. Finally, another 0.5-cm. layer of Al pellets is added and the mass is ignited with an H_2-O_2 torch in order to preclude any contamination of the charge. After cooling, the slag and the product block are easily dumped out; the hard white slag is readily broken up with a hammer. The block with the product contained in it is broken down with water, the $Al(OH)_3$ is dissolved with hydrochloric acid, and the alumina (corundum) thus obtained is filtered off and washed. It may then be reused. The Si block is extracted for several days with boiling 1:2 hydrochloric acid, washed and boiled with $HF-H_2SO_4$. The residue is then melted

for half an hour with KHSO_4 and is then thoroughly washed. From each 350 g. of Al-SiO_2 charge, 120 g. of crude product is obtained. This yields 75 g. of pure silicon, which is then smelted in a stream of argon and chlorine (as shown below) to remove Al and other metal traces. The Si recrystallized from molten Al may also be purified by the following procedure:

A quartz crucible 12 cm. long and 2 cm. in diameter (a pure quartz tube fused at one end) is filled with 20 to 30 g. of powdered Si. This crucible is inserted into another fused quartz tube, which is 60 cm. long and 3 cm. in diameter, and has a male ground joint at the top (Fig. 219). The 5-mm. argon inlet tube is fused at the bottom to a 2-cm.-diameter outer tube, which in turn is sealed to the top of a cap equipped with a female ground joint. The argon thus returns through the annulus between the 2-cm. tube and the quartz tube and may therefore be recovered for reuse. The exit gases flow to the hood through a bubble counter filled with H_2SO_4 . The quartz tube is slipped into a 40-cm.-long platinum-rhodium-ribbon furnace; a shielded thermocouple is inserted immediately underneath the tube. The furnace is brought to a temperature of 1470°C , as measured at the bottom of the reaction tube. An oxygen-free stream of argon (purified in the same manner as N_2 , see p. 458) is fed to the inlet tube via a feed line constructed exclusively of ground-joint-connected elements. Some pure chlorine may be mixed with argon by means of a tee joint. First, all air is displaced from the apparatus until no oxygen can be detected at the outlet (see p. 336, section on oxygen). Heating is then begun and, when the Si is melted, the chlorine stream is started at a rate which will allow 2 to 3 liters of Cl_2 to flow through the apparatus in the course

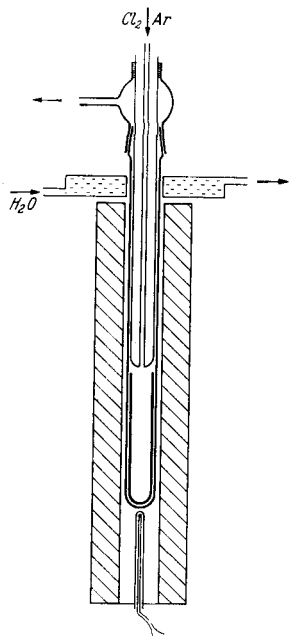

Fig. 219. Smelting of silicon under chlorine according to Von Warntenberg.

of about 3 hours. Besides SiCl_4 , all impurities except boron are thus volatilized. The chlorine flow is then shut off, the temperature allowed to drop to 1300°C , and the furnace removed. The reaction tube may be removed from the stand after about half an hour, and the crucible (which is always cracked) may then be dumped out. The product block is left in pure concentrated hydrofluoric acid for 24 hours so that all the adhering quartz particles may be

removed. Silicon prepared in this manner has a resistivity of 15-17 ohm-cm.

Further purification is possible by the zone melting technique of Pfann. In order to avoid contamination from the walls of the crucible during the melting, a technique similar to that of Verneuil-Miethes is recommended.

Other preparative methods:

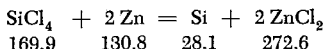

This is basically an old process. As used by DuPont, it is arranged as follows:

The quartz glass tube *A* (Fig. 220), 180 cm. long and 20 cm. in diameter, is heated along its entire length by an electric furnace.

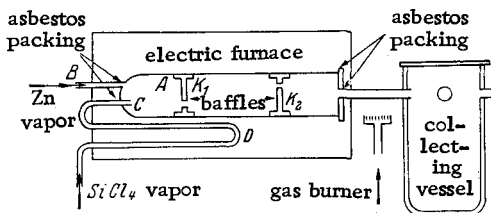

Fig. 220. Preparation of silicon by the DuPont method.

Zinc vapor, produced from high-purity zinc, flows in through *B*; preheated SiCl_4 vapor enters at *C* through the coil *D*. The apparatus is preheated for 5 hours before the reagent vapors are allowed to enter. The two baffles, K_1 and K_2 , are pierced by openings (5-cm. diameter) and break up the rather fast flow of reagent vapors. The yield is about 3 to 4 kg. of silicon over a period of about 24 hours. The product is supposed to be spectroscopically pure after washing with water. This pilot plant apparatus has been miniaturized for laboratory purposes by Von Wartenberg. Further purification is accomplished by his method of melting under Cl_2 , given above.

PROPERTIES:

Friable, mirrorlike (when polished) substance with a bluish luster. Insoluble in acids, including HF. Soluble in sodium hydroxide, evolving H_2 . M.p. 1423°C , b.p. 2630°C ; d 2.4. Lamellae or octahedral crystals. Diamond structure.

REFERENCES:

A. Kühne, *Z. anorg. allg. Chem.* **99**, 123 (1917); German Patent 147 871 Cl. 13 i, *Chem. Zentr.* **1904** I, 64; D. W. Lyon, *J. Electrochem. Soc.* **96**, 359 (1949); H. von Wartenberg, *Z. anorg. allg. Chem.*

265, 186 (1951); 283, 372 (1956); 286, 247 (1957); F. B. Litton and H. C. Anderson, *J. Electrochem. Soc.* 101, 287 (1954); H. C. Theuerer, *Bell Lab. Rec.* 33, 327 (1955), *Chem. Zentr.* 1956, 9938. For literature on zone melting, see W. G. Pfann, *Chem. Eng. News* 34, 1440 (1956); H. Kleinknecht, *Naturwiss.* 39, 400 (1952); S. Müller, *Z. Naturforschg.* 9b, 504 (1954); F. Trendelenburg, *Angew. Chem.* 66, 520 (1954). For melting without crucibles, see P. H. Keck, S. B. Levin, J. Broder and R. Liebermann, *Phys. Rev.* (2) 92, 847; *Bull. Amer. Phys. Soc.* 28, 11 (1953), *Chem. Zentr.* 1954, 7362; C. P. Kempter and C. Alvarez-Tostado, *Z. anorg. allg. Chem.* 290, 238 (1957).

Silanes



Silicon hydrides are prepared either by acid decomposition of magnesium silicide or by reduction of SiCl_4 with LiAlH_4 . Only a relatively modest yield of silane (20-30%) is obtained by the aqueous acid decomposition of silicide, but the proportion of the higher silanes is somewhat greater. If the reaction is carried out in liquid NH_3 or N_2H_4 instead of water, appreciably higher yields (over 80%) are obtained; besides, up to 90% of the product consists of SiH_4 , if one neglects the easily separable H_2 .

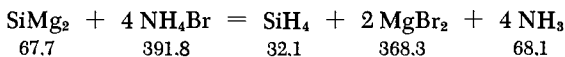

The reaction vessel (Fig. 221) is filled to about two thirds of its height with dry liquid NH_3 (see p. 460). Enough NH_4Br is dissolved in the NH_3 so that an approximately 50% excess is

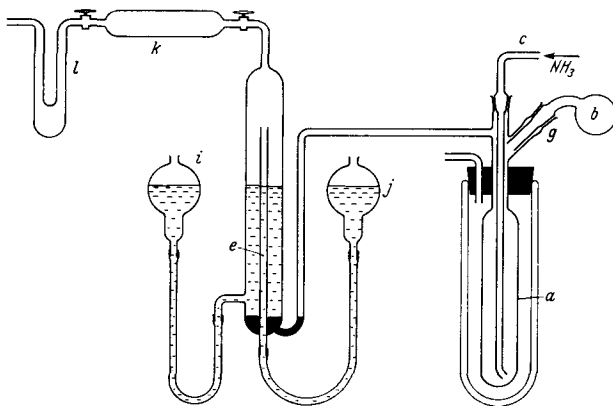
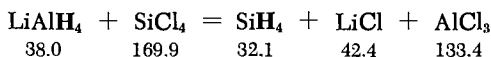

Fig. 221. Preparation of silane.

present; i.e., 85-90 g. NH_4Br should be used for each 10 g. of Mg_2Si . The finely divided silicide (see p. 921) is placed in the side flask *b*. A slow stream of NH_3 is introduced through tube *c* and allowed to bubble through the liquid to provide agitation; portions of the silicide are slowly added by rotating the small flask in the joint *g*. The gas evolved flows through the collecting tube *e*, which is filled with water in order to remove the excess NH_3 . The well-boiled water, acidified with HCl in order to prevent decomposition of the silane, may be replenished as required with the aid of the leveling bulbs *i* and *j*. From the collecting tube, the gas flows through tube *k*, which is packed with P_2O_5 to remove the water, and is then condensed in a trap *l*, which is cooled with liquid N_2 . It is finally fractionated by Stock's procedure (see Part I, p. 66), using high vacuum equipment.



A solution of 0.348 g. of LiAlH_4 (9.19 mmoles) in 12.5 g. of peroxide-free ether is placed in a reaction vessel, which is attached to a vacuum pump through a ground glass joint. The solution is then frozen and 1.33 g. of SiCl_4 (7.82 mmoles) is condensed on the solidified solution (the SiCl_4 is best measured out in the gaseous state). The reactor is now permitted to warm slowly. At about 0°C , a vigorous gas evolution commences. The products are condensed in a liquid-nitrogen-cooled trap, then distilled at -159°C into a trap, also cooled with liquid N_2 . The yield is 175 ml. (99%) of pure SiH_4 .

When LiH (even in very large excess) is used instead of LiAlH_4 , the reaction gives poorer yields. See Peake, Nebergall and Yun Ti Chen for an apparatus used in preparation of larger quantities of SiH_4 by that method.

The starting material for preparation of Si_2H_6 is Si_2Cl_6 . An LiAlH_4 solution is added slowly, drop by drop, to Si_2Cl_6 in ether solution. The LiAlH_4 excess should be about 15%. The Si_2H_6 yield is about 8%.

PROPERTIES:

SiH_4 : M.p. -185°C , b.p. -111.9°C ; *d* (at m.p.) 0.68.

Si_2H_6 : M.p. -132.5°C , b.p. -14.5°C ; *d* (-25) 0.685. Very reactive. Ignites in air.

REFERENCES:

A. Stock, *Hydrides of Boron and Silicon* (Ithaca, 1933). Additional references to the literature are found there. A. Stock, *Z. Electrochem.* **32**, 341 (1926); W. C. Johnson and S. Isenberg, *J. Amer. Chem. Soc.* **57**, 1349 (1935); A. E. Finholt, A. C. Bond, K. E. Wilzbach

and H. J. Schlesinger, *J. Amer. Chem. Soc.* **69**, 2692 (1947); F. Fehrér and W. Tromm, *Z. anorg. allg. Chem.* **282**, 29 (1955); J. S. Peake, W. H. Nebergall and Yun Ti Chen, *J. Amer. Chem. Soc.* **74**, 1526 (1952); H. S. Gutowsky and E. O. Stejskal, *J. Chem. Physics*, **22**, 939 (1954).

Polysilanes

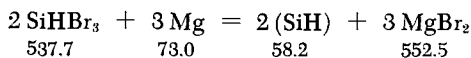
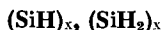

Magnesium turnings (6 to 8 g.) are placed in the reaction chamber *a* (Fig. 222), which is separated by a perforated plate *b* from the filter *g*; the reaction chamber is evacuated and filled with pure N_2 (see p. 458). Vessel *c* is filled with a 30 vol. % solution of SiHBr_3 in absolute ether. With stopcocks *e* and *f* still closed, stopcock *d*

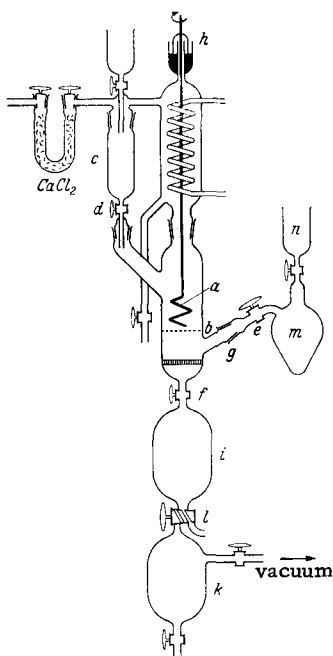

is opened to admit just enough SiHBr_3 solution to cover the Mg turnings. The heat of the instantly commencing reaction causes the ether to boil. The Mg is covered with a yellow incrustation which is broken up by the action of the hand-operated agitator *h*. The reaction product collects on the filter *g*. After about 20 to 30 minutes, the ether and the magnesium bromide etherate are drawn by suction into *i* and are then released into *k*. Absolute ether from vessel *c* is now let in via stopcock *d* and the apparatus is washed several times until test samples drawn out through the two-way stopcock *l* are free of Br. The reaction product is now suspended in ether and, by tipping the apparatus, it is made to overflow into flask *m*; the ether is now pumped out to obtain the dry product. Yield is about one gram.

Fig. 222. Preparation of $(\text{SiH})_x$

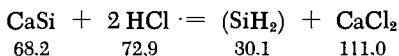

The apparatus is similar to that illustrated in Fig. 222, except that stopcocks *e* and *f* are omitted along with the reflux condenser

and the perforated plate *b*. A 5-g. quantity of CaSi (see p. 946 for preparation) is poured from flask *m* (by rotating the flask in the joint) into 300 ml. of HCl-saturated absolute alcohol, which covers the glass filter plate *g*. The procedure must be carried out in an atmosphere of dry CO₂ with good agitation. The addition of CaSi takes about an hour. Good cooling must be provided. After standing overnight while the evolution of H₂ ceases, the brown precipitate is separated in a CO₂ atmosphere from the supernatant liquid. The precipitate is first washed with ice-cold absolute alcohol and then with absolute ether.

The preparation of the higher unsaturated Si hydrides may be accomplished by cleaving the saturated hydrides with electrical discharge.

PROPERTIES:

(SiH)_x: lemon-yellow substance. Hard, amorphous; oxidizes slowly in air.

(SiH₂)_x: brownish substance. The dry material ignites spontaneously in air, leaving a SiO₂ residue which may be gray because of the presence of iron silicide. Evolves H₂ with alkali hydroxides.

REFERENCES:

G. Schott and W. Herrmann, *Z. anorg. allg. Chem.* 288, 1 (1956); G. Schott and E. Hirschmann, *Z. anorg. allg. Chem.* 288, 9 (1956); A. Stock and K. Somieski, *Ber. dtsch. chem. Ges.* 54, 524 (1921); 56, 247 (1923); R. Schwarz and F. Heinrich, *Z. anorg. allg. Chem.* 221, 277 (1935).

Silicon Tetrachloride

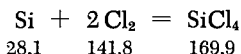

Silicon (prepared as shown above) or coarsely ground ferro-silicon (which should contain as much Si as possible) is placed in a boat inserted into a Pyrex tube about 60 cm. long and 2-3 cm. in diameter, through which a stream of Cl₂ is passed (Fig. 223). The Cl₂ is predried over concentrated H₂SO₄. A condenser is attached to the other end of the tube by means of an adapter; the tube itself is heated in an electric furnace. The tube should incline toward the condenser to prevent the SiCl₄ from backing up.

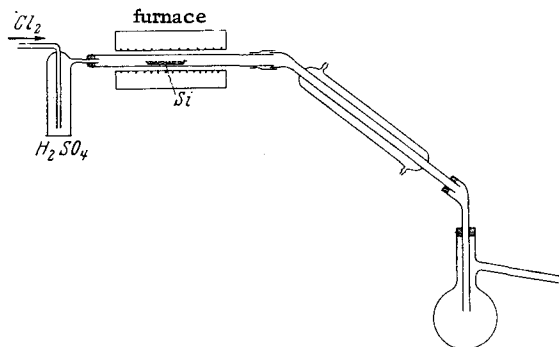

Fig. 223. Preparation of silicon tetrachloride.

The condenser end of the reaction tube should project out of the furnace for some distance so that the invariable byproduct FeCl_3 may deposit without plugging the condenser. The condenser discharges into a distilling flask which is set in an ice bath. All joints must be tight and the entire apparatus carefully dried before the start of the run. A CaCl_2 tube is attached at the end of the side arm of the distilling flask. If this precaution is overlooked, the side arm will immediately be plugged with silicic acid produced by reaction with atmospheric moisture. The reaction tube is heated to about 400°C and the Cl_2 flow is then started.

If, in addition to SiCl_4 , the higher Si chlorides are desired (Si_2Cl_6 and Si_3Cl_8), the temperature of the tube should be as low as possible, but no lower than just below 400°C . When the reaction is well established, heating may be sharply reduced since the reaction itself evolves considerable heat. The crude chloride, which is accumulated in the distilling flask, may be purified by fractional distillation. If an absolutely Cl-free preparation is desired, a second distillation over Cu turnings is performed. Both distillations must be run in absolutely dry equipment. The ampoules into which the SiCl_4 is distilled should be fused to the distillation apparatus, since it is impossible to obtain a non-turbid product if this is not done. Yield is quantitative.

PROPERTIES:

Clear, colorless liquid; fumes heavily upon exposure to air. Rapidly hydrolyzes in water to form a SiO_2 gel. Miscible with benzene, ether, chloroform and saturated hydrocarbons. Forms esters of silicic acid with alcohols. B.p. 57.5°C , m.p. -68°C ; d 1.52.

Higher Silicon Chlorides

If the preparation of SiCl_4 is carried out at temperatures below 400°C , it is possible to isolate very small quantities of Si_2Cl_6 and Si_3Cl_8 from the residue of the final distillation.

Chlorides up to $\text{Si}_6\text{Cl}_{14}$ are best prepared by chlorination of calcium silicide. The procedure is as follows: Cl_2 , dried over concentrated H_2SO_4 , is passed through a vertical glass tube (34-mm. diameter, about one meter long), half filled with bean-size lumps of Ca silicide (about 30-35% Ca). The tube should not be too full, for then it might plug during the run; about 200-250 g. is used. The tube is placed inside a short, movable electric heating coil. It is important that the reaction take place at the lowest possible temperature and that only a short section of the tube be heated at any time. The reaction starts at 250°C . The temperature must then be immediately lowered to 150°C . The Cl_2 flow should not exceed 100 bubbles/minute. The reaction products are accumulated in a cooled receiver via an attached condenser. After 12 to 14 days, during which the heating coil is slowly moved along the entire length of the tube, all the silicide is reacted, and about 700 ml. of chloride mixture is collected. The higher chlorides are obtained from this mixture by fractionation. If a low temperature and a slow flow rate of Cl_2 are used, then about 35% of the product mixture boils at a higher temperature than SiCl_4 . About 30% of this is Si_2Cl_6 , 4%, Si_3Cl_8 , and 1% represents chlorides up to $\text{Si}_6\text{Cl}_{14}$. After evaporation of the SiCl_4 , the residue is fractionated at reduced pressure. Addition of 2 to 5% of an alkali chloride, alkaline earth chloride or ammonium chloride or dilution of the chlorides (e.g., with SiCl_4) should improve the yield.

PROPERTIES:

B.p.: Si_2Cl_6 , 147°C ; Si_3Cl_8 , 216°C ; $\text{Si}_4\text{Cl}_{10}$, 150°C (at 15 mm.); $\text{Si}_5\text{Cl}_{12}$, 190°C (15 mm.); $\text{Si}_6\text{Cl}_{14}$ sublimes in vacuum at 200°C .

According to R. Schwarz, the higher Si chlorides, such as $\text{Si}_{10}\text{Cl}_{22}$, can be prepared by treatment of SiCl_4 in the apparatus illustrated in Fig. 224, which the author calls a "quenching tube." The procedure is as follows.

A silicon carbide rod, held in place by two electrode connector clamps, is fitted into a Liebig condenser. The electrode clamps are sealed into Pyrex caps, which fit over the ground-glass male joints of the condenser.

If the electrical terminals of these clamps consist of water-cooled copper tubing, then the seal to the glass caps is made with rubber tubing. A clamp is made by closing one end of the copper tube, welding on a piece of thin wall stainless steel tube and

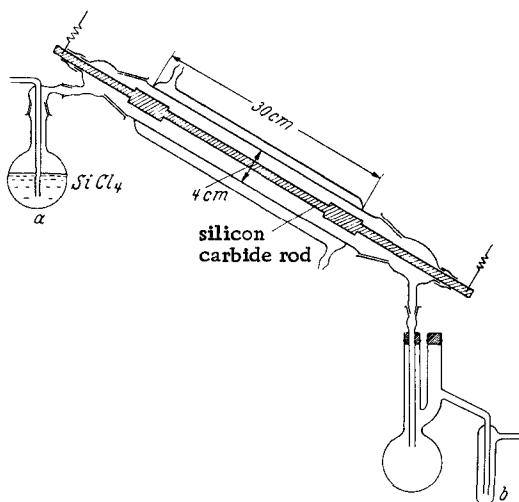

Fig. 224. Preparation of the higher silicon chlorides.

splitting the end of the latter with two lengthwise saw cuts. The SiC rod fits into that end. The open end of the copper tube is closed with a cap which carries the inlet and outlet tubes for the cooling water (the inlet tube extends well inside the closed tube).

Alternatively, iron electrode clamps, sealed to the Pyrex caps with asbestos-waterglass mixture, are used with no cooling. In that case, the Pyrex caps may have to be wound with cotton string, wetted with water to remove the heat.

The "quenching tube" itself can be made of copper. In this case, the glass caps are sealed on with rubber tubing (pieces of bicycle inner tube).

The apparatus is first thoroughly dried by heating in a stream of inert gas, with the cooling water off. After brief cooling, a stream of hydrogen is introduced at *a* and the air is displaced. Then 25 ml. of SiCl_4 is placed in flask *a*, the hydrogen saturated with the SiCl_4 and the heating resumed [the hydrogen is first passed over Pd asbestos to remove O_2 and over P_2O_5 for drying (see section on Hydrogen)].

The first run in a new tube should be made with H_2 ; $\text{Si}_{10}\text{Cl}_{20}\text{H}_2$ is formed under these conditions. If oxygen-free argon and SiCl_4 are used in a later run, $\text{Si}_{10}\text{Cl}_{22}$ is formed. The temperature of the SiC rod should be between 1000°C and 1100°C . A trap *b*, cooled with liquid nitrogen, is connected to the distilling flask which serves as the receiver.

It happens occasionally that the reaction fails to start. In that case, the gas is either not completely water-free or it contains

oxygen. Whenever a new SiC rod is used, the first run should be made with H₂ as the carrier gas, for otherwise the reaction will not start. From 112 g. of SiCl₄ the yield is about 35 g. crude product, from which the lower boiling fractions are stripped off. The Si₁₀Cl₂₀H₂ cannot be distilled without decomposing. The product prepared with argon is fractionated under high vacuum. The Si₁₀Cl₂₂ comes over as a highly viscous oil between 215 and 220°C.

The preparation of the higher Si chlorides by passage of SiCl₄ over Si at 1000°C is described by Rochow and Didschenko; the preparation by means of a glow discharge is described by Hertwig and Wiberg.

PROPERTIES:

Viscous, with a consistency ranging from oily to honeylike. Flammable. Hydrolyzed by water.

REFERENCES:

A. Besson and L. Fournier, *Comptes Rendus Hebd. Séances Acad. Sci.*, 152, 603 (1911); C. Friedel, *Comptes Rendus Hebd. Séances Acad. Sci.* 73, 1011 (1871); C. Friedel and A. Ladenburg, *Liebigs Ann. Chem.* 203, 253 (1880); L. Gatterman and E. Ellery, *Ber. dtsh. chem. Ges.* 32, 1114 (1899); L. Gatterman and K. Weinlig, *Ber. dtsh. chem. Ges.* 27, 1943 (1894); J. W. Mellor, *Comprehensive Treatise on Inorg. Chem.*, VI, p. 971; *Int. Crit. Tabl.*, Vol. I, p. 162; G. Martin, *J. Chem. Soc. (London)* 105, 2836, 2860 (1914); *Ber. dtsh. chem. Ges.* 45, 2097 (1912); 46, 2442, 3289 (1913); L. Troost and P. Hautefeuille, *Ann. Chim. Phys.* (5) 7, 459 (1871); R. Schwarz and H. Meckbach, *Z. anorg. allg. Chem.* 232, 241 (1937); E. G. Rochow and R. Didschenko, *J. Amer. Chem. Soc.* 74, 5545 (1952); H. S. Gutowski and E. O. Stejskal, *J. Chem. Phys.* 22, 939 (1954); D. F. Stedmann, U.S. Patent 2,621,111; W. J. Walton, U.S. Patent 2,602,728 (1952); H. Schaefer, *Z. anorg. allg. Chem.* 274, 265 (1953); C. F. Wilkins, *J. Chem. Soc. (London)*, 1953, 3409; K. A. Hertwig and E. Wiberg, *Z. Naturforsch.*, 6b, 336 (1951); W. C. Schumb and E. L. Gamble in *H. S. Booth, Inorg. Syntheses* New York and London, 1939, Vol. I, p. 42.

Silicon Tetrabromide

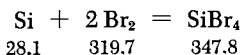

A boat, placed in a Vycor tube, is heated in an electric furnace to about 600°C. The boat contains finely powdered Si (which is

best mixed with about 4% copper dust). An O_2 -free stream of N_2 (from a "copper tower," see p. 458), saturated with Br_2 vapor in a wash bottle, is passed over the silicon. A condenser with a receiver is attached to the other end of the tube, as in the preparation of $SiCl_4$. The crude product is purified by fractional distillation.

PROPERTIES:

Colorless liquid. Easily hydrolyzed. Fumes in air. M.p. $5.2^\circ C$; b.p. $152.8^\circ C$; d 2.789. In contrast to $SiCl_4$ it reacts violently with metallic potassium.

REFERENCE:

L. Gatterman, Ber. dtsch. chem. Ges., 22, 189 (1889).

Silicon (II) Bromide

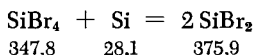

As shown in Fig. 225, an unglazed porcelain boat is charged with 20 g. of very pure silicon and placed in a porcelain or quartz tube (30-40 mm. diameter, 800 mm. long), placed in a Globar tubular furnace. The boat is pushed to the hottest part of the furnace. The temperature should be about $1150^\circ C$ at this point. The ends of the tube, which extend beyond the furnace, are wound with lead cooling coils and are closed with well-seated rubber stoppers *c* and *d*. The stoppers are painted with quick-setting chlorinated rubber cement to ensure a better seal. The flask *a*, which contains $SiBr_4$, is first cooled to at least $-80^\circ C$ and is then very slowly

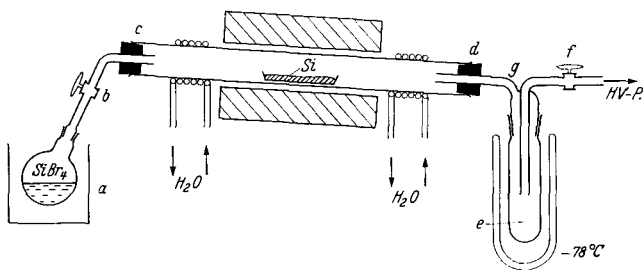

Fig. 225. Preparation of silicon (II) bromide.

evacuated via trap *e* and stopcocks *b* and *f*. Caution is necessary since the Si powder is easily entrained. When a high vacuum has been attained, the furnace is turned on. As soon as the temperature reaches 1100°C, trap *e* is cooled in Dry Ice or liquid nitrogen and flask *a* is set in ice water. Crystals of Si_2Br_6 form immediately at *g* and unreacted SiBr_4 collects in *e*. In six to seven hours, about 40-60 ml. SiBr_4 distills over, of which about 10 ml. is recovered unreacted in *e*. The apparatus is allowed to cool under vacuum, dry N_2 is introduced through *f*, stopper *d* is removed, and the tube is quickly withdrawn from the furnace. A suitable wide-mouth flask, which is kept ready, is pushed over the open end of the tube and, after flask *a* is detached, a stream of dry N_2 is introduced via *b* and *c* into the now inclined tube. The product is melted by careful heating with an open flame (the tube is fanned with the flame) and allowed to flow into the wide-mouth flask. This operation, which takes about 15 minutes, is carried out in an atmosphere of dry N_2 . The product accumulated from several runs is transferred into an Anschütz distillation flask and is heated in high vacuum for half an hour at 170-180°C in order to separate the Si_2Br_6 . About 80% of the product remains behind as a dark brown substance, mixed with powdered Si. This is dissolved in three to four times its volume of dry benzene and filtered while protected from moisture in an apparatus similar to that illustrated in Fig. 49, p. 71; the apparatus, however, has no heating jacket and the horizontal outlets *c* and *d*, this time provided with stopcocks, are fused instead to the middle section. The clear, dark yellow solution is freed from benzene under vacuum and is then heated for another hour in high vacuum at 170°C. Dry air is admitted after cooling and the flask containing the residue is brought to a temperature of -80°C. At this temperature, the SiBr_2 is so brittle that it crumbles easily on slight shaking.

PROPERTIES:

Formula weight 187.92. Brown, friable substance, somewhat like shellac; transparent in thin sheets. Begins to soften at about 60°C; filaments may be drawn at 100-110°C; at 160° to 180°C, it acquires the viscosity of a heavy grease. Decomposition starts at 200°C and Si_2Br_6 is formed. Ignites spontaneously in air at 120°C. Molecular weight from benzene, 3,000-3,600. Hydrolyzes in water, forming subsilicic acids. Strong reducing agent. Soluble in benzene, xylene, CCl_4 , etc.; slightly soluble in ether. Reacts explosively with strong oxidizers such as HNO_3 .

REFERENCE:

M. Schmeisser, private communication, 1958.

Silicon Tetraiodide

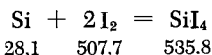

The preparation is carried out in the apparatus shown in Fig. 226. It consists of a quartz tube *a*, which is 500 mm. long and 30 mm. in diameter and has a male ground-glass joint on both ends. Attached to the main tube at a right angle is tube *b*, approximately 50 mm. long, with a female ground joint at the end. The apparatus is filled in the following manner with a mixture consisting of commercial grade powdered silicon plus 4% of copper dust: a 25-cm.-long strip of copper is fashioned into a spiral which is held in place in the quartz tube by a loose plug of asbestos wool. The copper spiral is placed in such a manner that one end of it extends into the joint and the asbestos plug 1 is located about 5 to 6 cm. away from the fitting. The tube is now charged with the silicon and copper powder mixture, which is packed as loosely as possible. The tube is held vertically during the filling and the addition is continued until the copper spiral is just covered. The charge is then held in place by the loose asbestos wool plug 2. The charged tube is inserted in a tubular electric furnace, which is equipped with a thermocouple, in such a way that the upper edge of the charge is even with the end of the furnace; the apparatus is tilted about 40° from the horizontal. A receiver *c* with a glass outlet tube is attached at the lower joint. The upper end of tube *a* is closed by a fitting with a stopcock, through which a stream of oxygen-free nitrogen is introduced at a rate of four bubbles/sec. The N₂ is predried over concentrated H₂SO₄, silica gel and P₂O₅. Flask *k*, containing the iodine, is attached to the arm *b*. The apparatus is first thoroughly heated in a stream of N₂ at 600 to 700°C for one to two hours. The first addition of iodine is then made by rotating the iodine flask *k* in the joint; moderate heat is applied at the upper asbestos plug. Crude SiI₄, contaminated with iodine, immediately flows to the lower end where it collects in the receiver. Care must be taken that solid SiI₄ does not plug the tube. If necessary, the SiI₄ must be melted down by fanning with an open flame. About 150 g. of crude SiI₄ can thus be obtained over several hours. The yield, based on iodine, is 70%. Unreacted Si can be reused in later runs. For purification, the receiver is broken off at *g*, quickly crushed in a mortar and the crushed mass poured into a well-heated distilling flask (see Fig. 227), equipped with an approximately 20-mm.-diameter side arm. The charge *a* is covered with an approximately 5-mm.-thick layer of

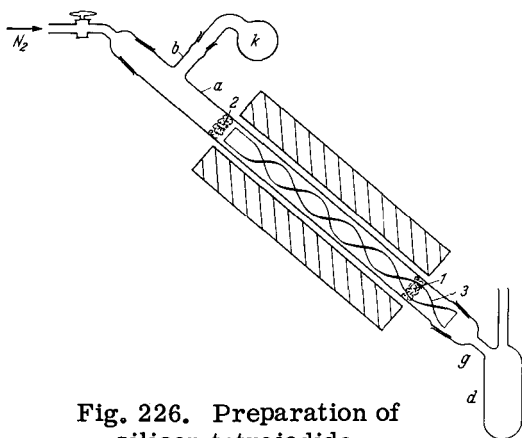

Fig. 226. Preparation of silicon tetraiodide.

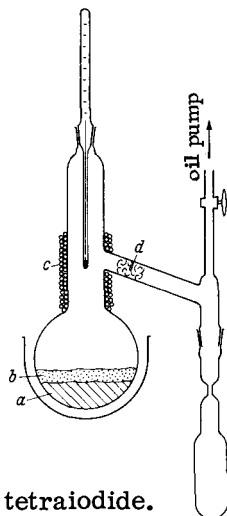

Fig. 227. Distillation of silicon tetraiodide.

powdered copper *b* and a 2-cm.-long loose plug of copper wool *d* is pushed up into the side arm. The distilling flask is now heated in a liquid metal bath and evacuated with an oil pump. Some SiI_4 , together with I_2 , begins to sublime at a bath temperature of 150°C ; the reaction between Cu and I_2 begins at 180°C , and the melt begins to boil at 200°C . The stopcock on the line to the pump is now closed, and the SiI_4 is distilled over. Since some I_2 comes over at the start, the solid SiI_4 is rose-colored. After three distillations, pure white, solid SiI_4 (lemon yellow as a liquid) is obtained. Because some copper dust is occasionally entrained during the distillation, the final distillation of colorless SiI_4 is best done without the addition of copper. The product should be stored under an N_2 blanket in sealed ampoules, which are kept in a dark place.

PROPERTIES:

M.p. 122°C , b.p. 287.5°C . White crystalline substance which melts to a lemon-yellow liquid. Very sensitive to moisture and light; decomposes readily on heating into its elements.

According to Gomberg (see Part III, section on Adsorptive and Catalytically Active Materials), Si_2I_6 is formed when SiI_4 is heated together with very dry, powdered silver at 280°C for six hours in a sealed, evacuated tube.

REFERENCES:

R. Schwarz and A. Pflugmacher, *Ber. deutsch. chem. Ges.* **75**, 1062 (1941); U. Wannagat and R. Schwarz, *Z. anorg. allg. Chem.* **277**,

82 (1954); U. Wannagat and E. Ringel, private communication; F. B. Litton and H. C. Anderson, *J. Electrochem. Soc.* 101, 287 (1954).

Chlorosilanes



Several methods are available for the preparation of the three chlorosilanes. In order to obtain SiHCl_3 as the principal product, the best way is to react Si with HCl in the presence of copper.

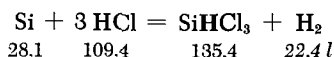

A porcelain boat is filled with finely powdered silicon, which has been purified by boiling with hydrochloric acid and dilute hydrofluoric acid. About 10% CuCl_2 is mixed in with the silicon. The boat is placed in a Pyrex glass tube fitted with an adapter and a condenser, as described in the preparation of SiCl_4 . In this case, however, the end of the condenser should extend into the middle of the distilling flask. The apparatus is first carefully heated. Hydrogen chloride gas is produced from NaCl and H_2SO_4 , without addition of hydrochloric acid, since it must be absolutely dry. The furnace around the tube which contains the boat is heated to 300°C and a slow stream of HCl is introduced. The receiver is cooled with acetone-Dry Ice mixture. Finally, the crude product is distilled directly from the receiver. The first fraction is HCl. The SiHCl_3 comes over at 36.5°C . With a careful fractionation of the forerun, SiH_2Cl_2 may also be recovered. The yield of SiHCl_3 is about 50%. In order to improve the yield of SiH_2Cl_2 , it is recommended that hydrogen be added to the HCl in the ratio of $\text{H}_2:\text{HCl} = 4:1$.

Other preparative possibilities:

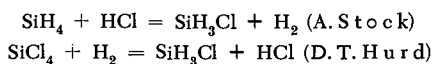

PROPERTIES:

Water-clear, mobile, flammable liquids. Very volatile. Hydrolyzed by water. Fume in air. Remarkably inert toward metals, even sodium.

SiHCl_3 : Synonym: silicochloroform. M.p. -134°C , b.p. 36.5°C ; d 1.35. In the presence of AlCl_3 disproportionates at temperatures above 300°C to SiCl_4 and SiH_2Cl_2 .

SiH_2Cl_2 : M.p. -122°C , b.p. 8.5°C ; d (-122°C) 1.22.

SiH_3Cl : M.p. -118°C , b.p. -30.5°C ; d (-113°C) 1.15.

REFERENCES:

L. Gatterman, Ber. dtsch. chem. Ges. **22**, 190 (1889); O. Ruff and K. Albert, Ber. dtsch. chem. Ges. **38**, 2226 (1905); C. Combes, Comptes Rendus Hebd. Séances Acad. Sci., **122**, 531 (1896); G. H. Wagner, U. S. Patents 2,657,114; 2,627,451; A. Stock and C. Somieski, Ber. dtsch. chem. Ges. **52**, 695 (1919); D. T. Hurd, J. Amer. Chem. Soc. **67**, 1545 (1945); G. H. Wagner, U. S. Patent 2,499,009; see G. Fritz, Z. anorg. allg. Chem., **280**, 134 (1955), for quantitative determination of the Si-H bond energies.

Tribromosilane

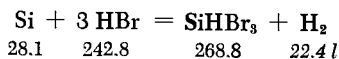

Standard powdered Si (100-mesh, about 97.5% Si) can be used for the preparation; the addition of some CuCl is advisable. The apparatus shown in Fig. 228 should be used. Hydrogen, dried with fused KOH in drying towers *a*, flows through a bubbler *b* which is filled with Br₂ and heated to 45°C on a water bath. The Br₂-laden gas then flows through tube *c*, filled with Pt-asbestos and heated to about 200°C, where it is converted to HBr. Either FeBr₂ (dried at 100°C) or moist red phosphorus is placed in *d*. The towers *e* are

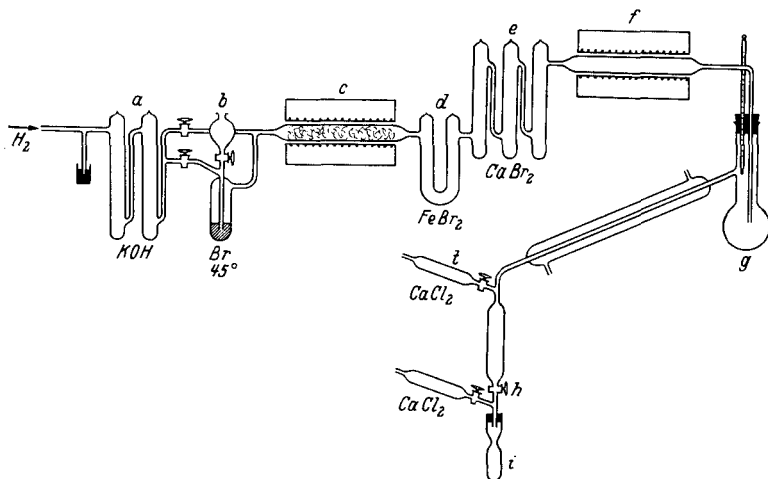

Fig. 228. Preparation of tribromosilane.

filled with CaBr_2 . The charges in d and e must be replenished frequently. Tube f contains the Si; it is heated to $360\text{--}400^\circ\text{C}$. Flask g is placed in a cooling bath at -30°C . If lower temperatures are used, the byproduct SiBr_4 tends to condense and plug the tube.

Before a run, the air is displaced with H_2 and the apparatus is thoroughly dried. The furnaces are then turned on and Br_2 is added to the bubbler from the dropping funnel. The gas stream is so regulated that it passes through the Br_2 at the rate of 3–4 bubbles per second. Under these conditions (45°C), about 60 g. vaporizes in 5 hours. Unreacted HBr and H_2 leave the apparatus through the CaCl_2 tube t . At the end of the run, the product is distilled directly from flask g into reagent bottles i provided with fusible necks. When such a bottle is full, the stopcock h is closed and the bottle is sealed. When a fresh bottle is attached, it is first evacuated and then filled by opening h . These safety measures are important since SiHBr_3 is highly flammable and readily hydrolyzed. The distillation produces two fractions: I, boiling up to 125°C and II, boiling from 125 to 154°C .

Each of these fractions undergoes a final fractional distillation in a column. The apparatus is shown in Fig. 229. The sealed bottles i are arranged on pads of glass wool in receiving vessels. On top of the vials rest glass-encased iron hammers k ; these are later lifted with magnets and used to shatter the tips of the reagent bottles (see Part I, p. 63). The apparatus is evacuated and gently heated by fanning with an open flame. The reagent bottles are now opened, flask b is cooled in a cold bath to -40°C , and the contents of the bottles are distilled into b . The receiving vessels containing the empty reagent bottles are sealed off. The apparatus is now filled with dry N_2 and the distillation is started in a stream of N_2 .

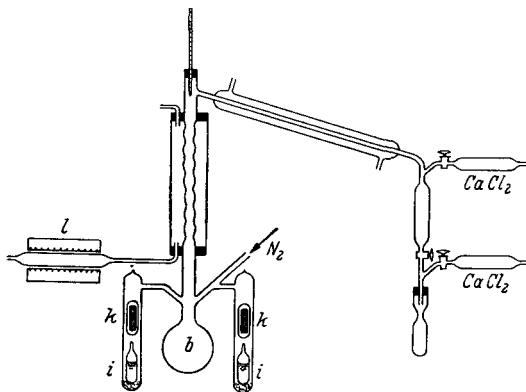

Fig. 229. Fractionation of crude obtained in the preparation of tribromosilane.

The jacket of the column is maintained at a temperature barely under the boiling point by means of a stream of air preheated in *I*. The fractions boiling at 64°C, 111.8°C and 153.4°C are collected. They contain, respectively, SiH₂Br₂, SiHBr₃ and SiBr₄. A total of about 57 g. of the crude is obtained from 60 g. of Br. After fractionation, about 60-70% of the crude is recovered as SiHBr₃.

Purity may be determined conveniently by gasometry, according to the equation: SiHBr₃ + 5 NaOH = 3 NaBr + Na₂SiO₃ + 2H₂O + H₂ or by melting-point and boiling-point determinations.

PROPERTIES:

Colorless, mobile liquid. B.p. 111.8°C, m.p. -73.5°C. Ignites easily in air. Vap. p. (0°C), 8.8 mm. Log p = -1819.5/T + 7.6079. Hydrolyzed in cold water to H₂Si₂O₃ and HBr.

REFERENCES:

A. Besson and L. Fournier, *Comptes Rendus Hebd. Séances Acad. Sci.*, **151**, 1055 (1911); H. Buff and F. Woehler, *Liebigs Ann. Chem.* **104**, 99 (1857); C. Combes, *Comptes Rendus Hebd. Séances Acad. Sci.*, **122**, 531 (1896); *Bull. Soc. Chim. France* (3), **7**, 242 (1892); L. Gatterman, *Ber. dtsch. chem. Ges.* **22**, 193 (1889); W. C. Schumb and R. C. Young, *J. Amer. Chem. Soc.* **52**, 1464 (1930); W. C. Schumb in H. S. Booth, *Inorg. Synthesis*, Vol. I (New York and London, 1939), p. 38; G. Schott and W. Herrmann, *Z. anorg. allg. Chem.* **288**, 4 (1956).

Dimethyldichlorosilane

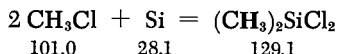
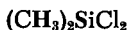

Commercial grade powdered Si (170 g.) is rinsed with hydrochloric acid, placed in a Pt dish and washed with water. It is then heated with hydrofluoric acid and with sulfuric acid, again well washed with water and thoroughly dried. It is then mixed with 30 g. of copper (I) chloride. The resulting powder may be used as is. However, it is preferable to tablet it before placing it in a 40-cm.-long and 3-cm.-diameter Pyrex tube. The tube is wrapped with an asbestos layer, on top of which there is a heating coil. This assembly is then wrapped with a double layer of asbestos tape. One end is closed with a two-hole rubber stopper. A glass tube is inserted through one hole of the stopper and connected

through a bubbler filled with concentrated H_2SO_4 to a cylinder of methyl chloride. The other hole of the stopper is fitted with a thermometer. The other end of the tube is drawn out and slightly bent downward. It is attached to a Liebig condenser provided with a receiver. A trap, maintained at -80°C , is attached to the receiver; and, finally, a CaCl_2 tube is connected to the outlet side of the trap. The entire apparatus is carefully dried prior to the run. The methyl chloride is introduced through the bubbler at a rate of 2 bubbles/second; the temperature of the tube is controlled at 300°C . Condensate immediately appears in the receiver. The run is terminated after about 70 hours; the condensates in the trap and in the receiver are combined and the mixture is fractionally distilled, using a good column. The desired product comes over at 70°C . About 30 to 40% of the crude is $(\text{CH}_3)_2\text{SiCl}_2$; about the same amount of CH_3SiCl_3 (b.p. 65.7°C) is also obtained.

Analysis:

For the determination of Si in low-boiling organic compounds, see B. Smith, *Acta Chem. Scand.*, 11, 579 (1957).

PROPERTIES:

Colorless liquid. M.p. -76.1°C , b.p. 70°C ; d (25°C) 1.06. Hydrolyzes in moist air or water with the formation of polymeric methylsiloxanes.

REFERENCES:

F. Kraus and A. von Grosse, *Die Chemieder metallorganischen Verbindungen* (Berlin, 1937); E. G. Rochow, *J. Amer. Chem. Soc.* 67, 963 (1945); M. J. Hunter, J. F. Hyde, E. L. Warrick and H. J. Fletcher, *J. Amer. Chem. Soc.* 68, 667 (1946); W. Patnode and D. F. Wilcock, *J. Amer. Chem. Soc.* 68, 358 (1946); W. Patnode, U.S. Patent 2,380,997; E. G. Rochow in L. F. Audrieth, *Inorg. Syntheses*, Vol. III (New York-Toronto-London, 1950), p. 56.

Chlorosiloxanes



Powdered silicon is heated in a 2:1 mixture (by volume) of Cl_2 and O_2 , using the same apparatus as for the preparation of SiCl_4 . Both the gases and the apparatus must be carefully dried. The O_2 is introduced first, and then the Cl_2 flow is started. It is best not to rely upon the observation of gas bubbles in the wash bottles for

estimating the gas flow; rather, a flow meter filled with H_2SO_4 should be installed. The receiver is cooled with ice. The reaction product is separated from SiCl_4 by distillation up to 80°C . The Si_2OCl_6 then comes over up to 137°C . It is then refracted at 15 mm.

Other preparative possibilities: Partial hydrolysis of SiCl_4 in ether at reduced temperatures. Heating of SiCl_4 with SO_3 in a sealed tube.

PROPERTIES:

$\text{Si}_4\text{O}_4\text{Cl}_8$; Colorless crystals. M.p. 77°C , b.p. (15 mm.) 91°C . The other members of the series are viscous liquids which solidify as glasses. They are miscible with CCl_4 , CHCl_3 and CS_2 in all proportions. Form esters with absolute alcohol. The latter are quite stable and are only slightly hydrolyzed even when boiled in water.

B.p. (15 mm.) $\text{Si}_3\text{O}_2\text{Cl}_8$, 76°C ; $\text{Si}_4\text{O}_3\text{Cl}_{10}$, $109-110^\circ\text{C}$; $\text{Si}_5\text{O}_4\text{Cl}_{12}$, $130-131^\circ\text{C}$; $\text{Si}_6\text{O}_5\text{Cl}_{14}$, $139-141^\circ\text{C}$; $\text{Si}_7\text{O}_6\text{Cl}_{16}$, $145-147^\circ\text{C}$.

REFERENCES:

W. C. Schumb and D. F. Holoway, J. Amer. Chem. Soc., 63, 2753 (1941); W. C. Schumb and A. J. Stevens, J. Amer. Chem. Soc. 69, 726 (1947); 72, 3178 (1950); 75, 1513 (1953); J. Goubeau and R. Warnick, Z. anorg. allg. Chem. 259, 109 (1949).

Silicon Monoxide

SiO

A mixture of finely divided silicon (about 98.5% Si) and the purest calcined quartz powder is sublimed in a high vacuum.

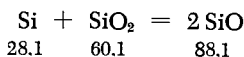

The intimate mixture (preferably in the form of briquettes) is placed in the closed end of a porcelain tube. The tube is attached to a high-vacuum pump. The pressure is reduced to 10^{-3} to 10^{-4} mm. and then the closed end of the porcelain tube is slowly heated in an electric furnace to about 1250°C . The run is complete after about 4 hours. Upon cooling, the SiO is found as a black, compact, shellac-like substance in that part of the tube which has been moderately heated. The transition zone of the tube, heated to about $400-700^\circ\text{C}$ during the run, contains a brown

mass of large volume which consists of a stoichiometric mixture of Si and SiO_2 . The brittle SiO is easily scraped off the wall of the tube with a stainless steel spatula. Occasionally it changes spontaneously to SiO_2 upon exposure to the air; it is therefore desirable to empty the tube in a nitrogen atmosphere.

It is particularly important that the 400–700°C transition zone, in which the already formed SiO decomposes to Si and SiO_2 , be as short as possible. This is best accomplished by the use of ceramic tubes, which are poor heat conductors. On the other hand, this zone would be longer in a metal tube which is a good heat conductor. Such metal tubes were recommended in the past. However, their use may cause a very marked decrease in the yield.

Other preparative methods: Reduction of SiO_2 with charcoal in a vacuum.

Calcining an intimate mixture of Si and SiO_2 for 9 hours at 1300°C, followed by rapid cooling, produces cubic SiO crystals.

PROPERTIES:

Formula weight 44.06. Black to brown-black, amorphous, shellaclike substance or cubic crystals. d 2.18–2.2. Hardness is about equal to Si. Disproportionates between 400 and 700°C to SiO_2 and Si. Nonconducting. M.p. > 1700°C. Produces H_2 with alkali hydroxides and dissolves forming silicates.

REFERENCES:

K. F. Bonhoeffer, *Z. physik. Chem. (A)*, 131, 360 (1928); W. Blitz, *Naturwissen.* 26, 188 (1938); E. Zintl, *Z. anor. allg. Chem.*, 245, 1 (1940); G. Grube and H. Speidel, *Z. Elektrochem.*, 53, 339 (1949); H. Koenig, *Optik*, 3, 419 (1948); H. von Wartenberg, *Z. Elektrochem.*, 53, 343 (1949); M. Hoch and H. J. Johnston, *J. Amer. Chem. Soc.*, 75, 5224 (1953); L. Brewer and R. K. Edwards, *J. Phys. Chem.*, 58, 351 (1954); G. Jacobs, *Comptes Rendus Hebd. Séances Acad. Sci.*, 236, 1369 (1953).

Silicic Acids

There exists a series of true silicic acids with various molecular sizes. The simplest is the ortho form of monosilicic acid, H_4SiO_4 . It is soluble in water and is "molybdate-active" (i.e., it immediately produces a yellow color with ammonium molybdate, a phenomenon which is used in its quantitative determination). Condensation to oligosilicic acids takes place through intermolecular dehydration when the concentration of the solution is greater than 10 mg. SiO_2 /100 ml. H_2O . With higher concentrations, polysilicic acids with high molecular weights and colloidal properties are formed.

1. AQUEOUS MOLECULAR DISPERSIONS OF SILICIC ACID

Immediately after drying, 20 g. of unpulverized silica gel, prepared by the method presented in 3 below, is shaken for 48 hours with 400 ml. of double-distilled water. Upon contact with water and with agitation, the gel crumbles into small granules. Finally it is filtered by means of an ultrafilter. The filtrate contains orthosilicic acid, the concentration of which can be determined either colorimetrically or by evaporation. The initial concentration in a solution prepared in this manner is generally between 12 and 15 mg. $\text{SiO}_2/100$ ml. This is diluted to 10 mg. $\text{SiO}_2/100$ ml. The filtration residue may be reused after drying at 80°C for 24 hours.

2. COLLOIDAL SILICIC ACID

a) A solution of 60 g. of sodium metasilicate (see p. 704) in 200 ml. of warm water is filtered. After cooling, the clear solution is poured into 100 ml. of a solution composed of equal parts of water and concentrated hydrochloric acid; the solution must be well stirred during the addition and the final solution must be acid. The solution is then dialyzed until treatment with AgNO_3 produces only a slight turbidity but no permanent precipitate.

b) Silica gel (20 g.), prepared according to Paragraph 3 below, is shaken with 400 ml. of 5 N ammonia in the manner described in Paragraph 1 above; the solution is filtered and the ammonia is separated by vacuum distillation while cold. Traces of ammonia which remain in the solution stabilize the colloidal suspension.

3. SILICA GEL

The purest grade of silica gel is obtained by hydrolysis of tetramethoxysilane [tetramethylorthosilicate, $\text{Si}(\text{OCH}_3)_4$, the methyl ester of orthosilicic acid, b.p. 121°C], which can be prepared by the procedure given on p. 702. If the ester contains traces of HCl , distillation over dry Ag_2O is recommended. Fifty grams of the ester are added to 80 ml. of double-distilled water in a large platinum dish and heated to $40\text{--}50^\circ\text{C}$ while stirring with a platinum spatula. A homogeneous mass is formed after 15 minutes. A rather voluminous gel is formed after standing for one hour in a warm place. The alcohol and most of the water are removed by drying for 48 hours at 80°C . The dried gel has the appearance of hard, pea-size and pearlike lumps.

Because of its extremely slow rate of hydrolysis, the use of tetraethylorthosilicate for this purpose is not recommended.

4. CRYSTALLINE DISILICIC ACID

Sulfuric acid (80%, 100 ml.) is cooled to 10°C with vigorous mechanical agitation. As soon as this temperature is attained, 5 to 10 g. of finely divided and sieved crystalline sodium disilicate is gradually added, preferably through a sieve, with vigorous stirring. Stirring with cooling is continued for at least another 3 hours. Then, 5 liters of distilled water is added with stirring to the mixture. As soon as a precipitate forms, the solution is decanted and fresh water is poured in. This is again decanted after some stirring; the water is changed in this manner 4 or 5 times. Finally, the mixture is filtered, washed until the filtrate is free of SO_4^{2-} and then rinsed with an alcohol-ether solution. The ether is removed by filtration. Water loss on ignition is about 14% [theoretical ($\text{H}_2\text{Si}_2\text{O}_5$) 13.05%]. After mixing with hydrofluoric acid and evaporating, not more than 0.1% Na_2SO_4 should be present if the washing was thorough and treatment with acid was sufficiently long. An x-ray examination shows the substance to be crystalline.

REFERENCES:

R. Schwarz and E. Barnetzky, *Angew. Chem.* 68, 573 (1956); R. Schwarz and E. Menner, *Ber. dtsch. chem. Ges.* 57, 1477 (1924); R. Schwarz, *Z. anorg. allg. Chem.* 276, 33 (1954); R. Schwarz and H. W. Hennicke, *Z. anorg. allg. Chem.* 283, 346 (1956); private communication from R. Schwarz.

Silicon Oxyhydride

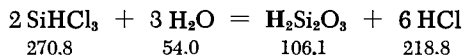

A mixture of equal parts of SiHCl_3 and benzene is poured with stirring into 10 times its volume of ice-water mixture. The SiHCl_3 must be carefully fractionated to free it of SiCl_4 . After a while, the reaction product is filtered off and purified by repeated suspension and washing with water. Complete removal of chlorine is difficult and is possible only by dialysis, as described by Schwarz and Souard. The product prepared as above still contains 0.5% Cl after three washings. It is dried overnight in a stream of air at 125°C.

PROPERTIES:

Fine, light, white powder; amorphous. Wiberg and Simmler describe the preparation of a crystalline substance. Flammable.

Evolves H_2 when treated with alcohols. The Si-H group adds alkenes to alkyl groups and may be chlorinated. When heated above $350^\circ C$ in an inert atmosphere, splits off H_2 and forms Si_2O_3 . At $900^\circ C$, the entire theoretical quantity of H_2 is liberated in a few minutes, leaving Si_2O_3 .

REFERENCES:

R. Schwarz and R. Souard, Ber. dtsh. chem. Ges., 53, 1 (1920); R. Mueller, Chem. Techn., 2, 7, 41 (1950); G. H. Wagner and A. N. Pines, Ind. Eng. Chem., 44, 321 (1952); E. Wiberg and W. Simmler, Z. anorg. allg. Chem., 283, 401 (1956).

Silicon Disulfide

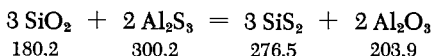

Somewhat more than the stoichiometric quantity of S is melted with 200-300 g. of aluminum pellets in a Hessian crucible. After cooling, some of the same reaction mixture is placed loosely on top of the solid mass. A strip of magnesium is inserted and ignited. After the very vigorous reaction is complete and the mixture has cooled, the contents of the crucible are finely pulverized and mixed with a little more than the theoretical amount of fine quartz sand. The mixture is placed in an unglazed porcelain quartz boat and heated in a stream of pure N_2 in either a porcelain or quartz tube. The reaction starts at $1100^\circ C$. Between 1200 and $1300^\circ C$, a feltlike sublimate of SiS_2 forms at the cooler parts of the tube. The SiS , which is deposited simultaneously, is easily separated from the SiS_2 since their volatilities differ.

Further purification is accomplished by resublimation in a stream of inert gas or in vacuum.

Other preparative possibilities: Passage of dry H_2S over powdered silicon at 1200-1300°C.

PROPERTIES:

Formula weight 92.18. White, fibrous substance. Very sensitive to moisture. M.p. $1090^\circ C$; d 2.02. Burns slowly when heated in air.

REFERENCES:

E. Tiede and M. Thiemann, Ber. dtsh. chem. Ges., 59, 1703 (1926); E. Zintl, Z. physik. Chem. (A), 174, 301 (1935); R. Schwarz, Z. anorg. allg. Chem., 276, 33 (1954).

Silicon Tetraacetate

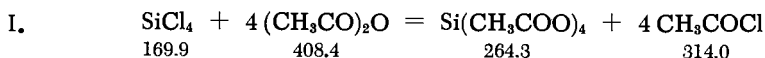

A dropping funnel *b* is used to add 255 g. of SiCl_4 to 744 g. of acetic anhydride, placed in a three-neck, one-liter flask (Fig. 230).

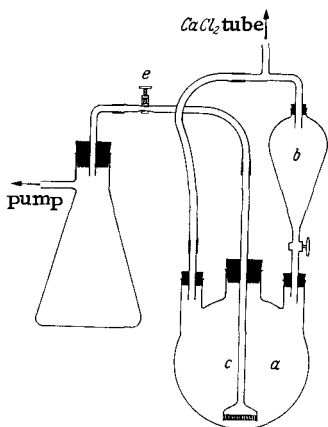

The apparatus must be completely dry and protected from atmospheric moisture. The filter *c* is pulled up and the tube closed by a pinch-clamp *e*. The reaction mixture evolves heat on agitation and crystals of $\text{Si}(\text{Ac})_4$ precipitate at once. The mixture is allowed to stand for several days. It is then cooled with Dry Ice, and filter *c* is lowered until it reaches the supernatant liquid, which is siphoned into the suction flask. Acetic anhydride (100 ml.) is now added to the residue in *a*, the crystals are dissolved by heating at 100°C and allowed to recrystallize by cooling to 0°C , and the mother liquor is removed as above. A second recrystallization proceeds in the same manner, but with 75 ml. of acetic anhydride. The solution adhering to the

Fig. 230. Preparation of silicon tetraacetate.

crystals is removed by evaporation, first at room temperature and then at 100°C (several hours). The yield is 335 g. or about 85%, based on SiCl_4 .

II. Four moles of acetic acid and 1.5 moles of SiCl_4 are refluxed for 48 hours in 200 ml. of absolute ether. After standing for two days in the cold, the precipitated crystals are filtered off with exclusion of moisture. An additional yield is obtained by concentration of the mother liquor. The yield is 70 g., or about 30%, based on acetic acid.

Other possible preparative methods: Reaction of SiCl_4 with thallium (I) acetate. The procedure is described in detail on p. 726 (section on Germanium).

PROPERTIES:

Very hygroscopic. Effervescent reaction with water, producing SiO_2 . Decomposes on heating at $160\text{--}170^\circ\text{C}$. Forms ethyl acetate

and SiO_2 with alcohol. M.p. 110°C , b.p. (5-6 mm.) 148°C . Soluble in acetone and benzene.

REFERENCES:

C. Friedel and A. Ladenburg, *Liebigs Ann. Chem.*, 145, 174 (1868); J. H. Balthis in J. C. Bailar, *Inorg. Synthesis*, Vol. IV (New York-London-Toronto, 1953), p. 45, J. Goubeau and R. Mundiel, *Z. anorg. allg. Chem.*, 272, 313 (1953); H. Schmidt, C. Blohm and G. Jander, *Angew. Chem.* 59, 235 (1947).

Silicon Cyanate and Silicon Isocyanate

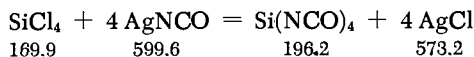

A little less than the stoichiometric quantity of SiCl_4 , dissolved in dry benzene, is added with stirring to a suspension of silver isocyanate, also in dry benzene. The solution is filtered and distilled at 25 mm. The lower-boiling fraction contains the $\text{Si}(\text{NCO})_4$; the higher boiling fraction contains the $\text{Si}(\text{OCN})_4$. The yield of the latter, however, is only about 2.5%.

PROPERTIES:

Colorless crystalline substances. $\text{Si}(\text{NCO})_4$: B.p. 185.6°C , m.p. 26.0°C ; d (20°C) 1.413. $\text{Si}(\text{OCN})_4$: B.p. 247.2°C , m.p. 34.5°C ; d (20°C) 1.414.

REFERENCE:

G. S. Forbes, *J. Amer. Chem. Soc.*, 62, 761 (1940).

Tetraethoxysilane, Tetramethoxysilane

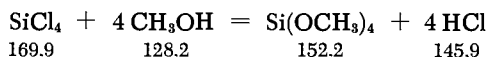
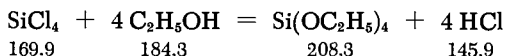
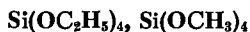

Dehydrated alcohol is distilled from CaO and metallic Ca (or CaC_2) into a one-liter, three-neck flask which has been carefully

predried. A mercury seal stirrer is mounted in the center tube of the flask, and the third tube is fitted with a reflux condenser equipped with a CaCl_2 tube and an exit tube.

When the flask is about half full (about 400 g. of alcohol), the adapter through which the alcohol was introduced is replaced by a dropping funnel. The end of the funnel tube should be several cm. below the surface of the alcohol. The flask is placed in a cold-water bath. The stirrer is now started and the SiCl_4 slowly added from the funnel. Over the course of several hours about 10% less SiCl_4 than that required by the above equation is allowed to flow in, that is, about 330 g. of the ethoxide or 230 g. of the methoxide. Toward the end of the reaction, the liquid foams considerably. Stirring is continued for an additional half hour, and the flask is then slowly heated. Most of the dissolved HCl is volatilized during this procedure and the solution is finally brought to a boil. When no further HCl evolves, the solution is allowed to cool somewhat; the reflux condenser is replaced by a distilling condenser, the excess alcohol is distilled off and the flask is heated to about 100°C . After cooling, some sodium alcoholate (prepared by dissolving some Na in alcohol dried over Ca) is added; the solution is shaken and is then allowed to settle. After several hours, the clear liquid is decanted into a dry distilling flask and fractionated. The yield is 90%.

The yield depends solely on the degree to which moisture is excluded and on the water content of the alcohol. If, for example, 96% alcohol is used instead of absolute alcohol, the principal product will be esters of disilicic acid and polymeric metasilicic acid. Esters of other alcohols can be obtained in the same manner; in the preparation of the methyl ester, however, special care must be taken to exclude moisture, and perfectly dry methanol must be used.

SYNONYM: :

Alkyl ester of silicic acid.

PROPERTIES:

Colorless liquids. B.p. 165°C or 121°C , respectively. Immiscible with water; slowly hydrolyze.

REFERENCES:

P. A. Thiessen and O. Koerner, *Z. anorg. allg. Chem.* **189**, 168 (1930); P. W. Schenk, unpublished research.

Silicates

SODIUM METASILICATE AND SODIUM DISILICATE, Na_2SiO_3 AND $\text{Na}_2\text{Si}_2\text{O}_5$

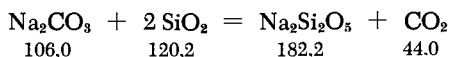
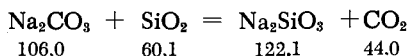

Very pure quartz sand is intimately mixed with Na_2CO_3 (or NaHCO_3) in the appropriate proportions and the mixture is melted in a platinum crucible at 1150°C . Since the metasilicate is especially difficult to obtain in crystalline form, the glassy solid melts must be maintained for considerable time at 700°C (about 100 hours is required for Na_2SiO_3 and 50 hours for $\text{Na}_2\text{Si}_2\text{O}_5$).

PROPERTIES:

M.p.: Na_2SiO_3 , 1089°C ; $\text{Na}_2\text{Si}_2\text{O}_5$, 874°C . Soluble in water, but the solution is not clear because of SiO_2 precipitation.

REFERENCES:

R. Schwarz, Z. anorg. allg. Chem., 126, 62 (1923); R. Schwarz and E. Menner, Ber. dtsch. chem. Ges., 57, 1477 (1924).

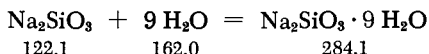
 $\text{Na}_2\text{SiO}_3 \cdot 9 \text{H}_2\text{O}$ 

One part by volume of waterglass (analysis: 35.8 g. SiO_2 and 11.3 g. Na_2O per 100 ml.) is mixed with one part by volume of H_2O and two parts by volume of sodium hydroxide solution (sp. g. 1.27) and allowed to stand. (If there is substantial deviation from the given analysis of the waterglass, the proportion of caustic soda must be adjusted.) The solution is seeded, using seed crystals obtained from precipitation of a part of the solution with alcohol. When the white mass solidifies after several hours, the mother liquor is removed by compression, by suction, or, best, by centrifugation. The product should be recrystallized once or twice from warm 2-3% sodium hydroxide. (Retain some seed crystals.) Finally the precipitate is dried on filter paper.

PROPERTIES:

Colorless, very slightly efflorescent salt in the form of small platelike crystals. M.p. 48°C in its water of crystallization.

REFERENCES:

K. Vesterberg, *Z. anorg. allg. Chem.*, **88**, 341 (1914); H. Lange and M. von Stackelberg, *Z. anorg. allg. Chem.* **256**, 271 (1948).

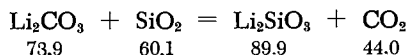
LITHIUM METASILICATE, Li_2SiO_3 

Lithium metasilicate can be prepared in the same way as sodium metasilicate by melting stoichiometric quantities of very pure Li_2CO_3 and quartz sand in a platinum crucible.

PROPERTIES:

Colorless, crystalline substance. M.p. 1201°C . The precise melting point and its excellent crystalline characteristics make it suitable for use as a calibration standard for thermocouples.

REFERENCES:

R. Schwarz and H. Sturm, *Ber. dtsh. chem. Ges.*, **67**, 1737 (1914); F. C. Kracek, *J. Phys. Chem.*, **34**, 2641 (1930).

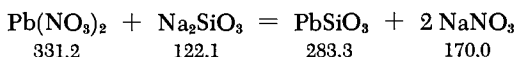
LEAD METASILICATE, PbSiO_3 

Sodium metasilicate, prepared as above from SiO_2 and Na_2CO_3 , is dissolved in water to obtain a 0.2% solution; a 0.5% lead nitrate solution is added with stirring to this solution. After settling, the precipitate is easily filtered off. It is dried on a water bath. A dark-colored preparation can be avoided only by carrying out the procedure in an atmosphere completely free of H_2S .

PROPERTIES:

White powder; m.p. 780°C .

REFERENCES:

R. Schwarz, *Z. anorg. allg. Chem.*, **126**, 76 (1923).

Lemon-yellow, light-sensitive silver metasilicate Ag_3SiO_3 can be obtained in the same manner [R. Schwarz, *Z. anorg. allg. Chem.*, **126**, 76 (1923); *Z. Elektrochem.* **32**, 415 (1926)].

BARIUM METASILICATE, BaSiO_3 , AND BARIUM DISILICATE, BaSi_2O_5

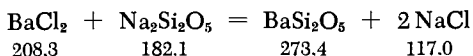
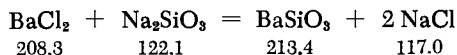

A solution of about 1% sodium silicate is prepared and, after filtering, precipitated by adding 2% BaCl_2 solution with stirring; the BaCl_2 should be in 10% excess. The precipitate is dried by suction and then on a water bath. This yields the disilicate. The metasilicate is formed if NaOH is added to the silicate solution before precipitation so that there are fifteen moles of base to one mole of SiO_2 . This is dried in the same manner as above.

REFERENCE:

R. Schwarz and H. Richter, *Ber. dtsh. chem. Ges.*, **60**, 2269 (1927).

Germanium

The starting material for the preparation of germanium and its compounds in the laboratory is germanite, a copper thio-germanate found at Tsumeb in Southwest Africa. A series of procedures has been developed for laboratory preparation, of which both acid and alkaline decompositions have proved to be suitable. Recovery of germanium by sublimation of GeS in a stream of NH_3 requires somewhat more equipment. Alkaline decomposition is especially recommended when it is also desired to recover the approximately 0.9% of gallium contained in the germanite. All the recovery methods proceed through initial formation of the dioxide, GeO_2 .

Germanium (IV) Oxide

GeO_2

I. ACID DECOMPOSITION

One liter of water and half a liter of concentrated H_2SO_4 are poured over 500 g. of pulverized ore in a 5-liter Erlenmeyer flask, which is placed in a large evaporating dish under an efficient hood or, better still, in the open air. The mixture is shaken and then 1.2 liters of concentrated nitric acid (d 1.4) is added all

at once. When the very vigorous reaction ends (foaming over occurs only with too highly concentrated acid), the mixture is heated for several hours on the water bath until the NO_2 evolution ceases almost completely. The hot solution is filtered rapidly through a suction filter and the filtrate is poured into a flat dish. Copper sulfate crystallizes out overnight. After decanting from the CuSO_4 , the filtrate is reused for processing another 500 g. of ore, for which purpose 200 ml. of concentrated H_2SO_4 and 1 liter of nitric acid are added to it. The residue on the filter is crude GeO_2 contaminated with SiO_2 , and it is purified in the following way.

The crude GeO_2 from 2-4 decomposition runs is placed in a 2-liter Pyrex flask (α in Figure 231) provided with a ground-glass joint, and hydrochloric acid is added. Each decomposition of 500 g.

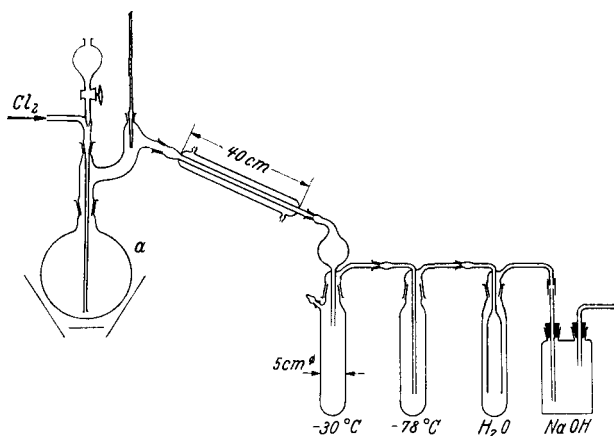
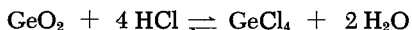

Fig. 231. Distillation of germanium tetrachloride.

of ore yields about 30 g. of GeO_2 . One run consumes 210 ml. of concentrated hydrochloric acid (d 1.19), so that 840 ml. of the 28% technical grade hydrochloric acid is used with the GeO_2 from four decomposition runs. The receivers are then cooled and the flask is very slowly heated while passing through a slow stream of Cl_2 . The receiver filled with water should not be allowed to become warm. If this occurs, either too much HCl was added or the flask was heated too quickly, that is, before the equilibrium



had been established. The GeCl_4 , which is yellow because of the Cl_2 , distills over at 83°C . A second layer, which consists of 20% hydrochloric acid, collects over it later. Toward the end of the

distillation, GeO_2 sometimes settles out in the receiver as a result of hydrolysis. This occurs if too little or too dilute hydrochloric acid has been used. In this case, concentrated hydrochloric acid from a separatory funnel is added to the liquid in the flask. If the receiver containing water should become warm at any time, it should be cooled with ice and, if necessary, the water should be changed. Distillation is carried out until the liquid in the first receiver becomes completely clear and no further GeCl_4 collects there. The clear distillate, which settles out in a fresh receiver, is tested by introducing H_2S , after reducing the dissolved Cl_2 with H_2SO_3 . No white GeS_2 should precipitate. A quicker test for Ge (without removing the Cl_2) is also possible if the solution is somewhat diluted and a 2% tannic solution is added [G. Brauer and H. Renner, *Z. analyt. Chem.* 133, 401 (1951)].

II. ALKALINE DECOMPOSITION

A solution of 500-600 g. of NaOH in an equal quantity of water is prepared and placed in a steel crucible. Then 1 kg. of very finely divided germanite (comminuted in a ball mill) is slowly added to the hydroxide solution. Vigorous agitation with an iron spatula is essential. Sometimes it is also necessary to cool the reaction vessel intermittently with cold water. After completion of the addition the mixture is slowly heated while the agitation is maintained. The heating is continued until the mixture becomes either highly concentrated (thick) or almost dry. At this point, it is scraped out of the crucible and transferred to a flask containing one liter of water. The resulting solution is filtered immediately thereafter (Pyrex glass frit or asbestos paper). The residue on the filter is thoroughly washed until the wash water becomes pale yellow. These procedures yield a total of four liters of filtrate. The residue on the filter, which oxidizes very readily and thus becomes very hot in air, is discarded. It should be noted that the steps subsequent to the solution of the alkaline reaction product in water must follow each other in quick succession to avoid partial oxidation of the product; this leads to formation of colloids, which are difficult to filter. The yellow filtrate is almost neutralized with sulfuric acid and then acidified with nitric acid. After completion of the rather vigorous reaction the brownish foam, which consists chiefly of arsenic sulfide and S, is filtered off. It is processed by evaporating with concentrated H_2SO_4 and HNO_3 in two separate procedures. The filtrate is now neutralized with ammonia using benzylanilineazobenzene sulfonic acid (benzyl orange) as an indicator. The precipitated oxides and hydroxides of Ga and Ge are filtered off. The filtrate is treated with 10% of its volume of concentrated ammonia, and some MgSO_4 is added, whereby the remainder of the germanium is precipitated. A short evaporation

of the gallium-germanium precipitate in contact with H_2SO_4 follows, and after dilution, the mixture is filtered. What remains is GeO_2 , which is purified by distillation together with the residue containing Mg. Since the material is already almost completely free of As, the purification described further below can be carried out immediately. However, the brownish foam, which is GeO_2 contaminated with As, must be distilled twice. The $GeCl_4$ obtained after the first distillation is hydrolyzed, and the GeO_2 obtained is purified as described further below (III).

To recover the valuable Ga, the following procedure is used. The sulfuric acid solution obtained after filtering off the GeO_2 is made alkaline and treated with some Na_2S . It is then acidified, whereby As, W and Mo are precipitated. The precipitate entrains some Ga with it. It is therefore boiled with HCl. The solution is then almost neutralized with ammonia and precipitated with ammonium carbonate. The $Ga(OH)_3$ is dissolved in hydrochloric acid, treated with bromine water, and boiled. The Na_2S precipitation in alkaline solution is now repeated in order to precipitate the Pb. The solution is then acidified in order to separate out the remaining Mo, and finally boiled and precipitated with ammonium carbonate. For additional processing of the crude $Ga(OH)_3$ thus obtained, see the section on Gallium.

Using either of the decomposition methods, more than 90% of the Ge contained in the ore is recovered. About 60 g. of GeO_2 is usually obtained from 1 kg. of ore, while the alkaline decomposition yields, in addition, about 8-9 g. of Ga. Both methods yield an impure material. In the acid decomposition method, crude $GeCl_4$, already freed to a considerable extent of As, is obtained. From this, GeO_2 can be obtained by hydrolysis. The alkaline decomposition method yields an arsenic-free but otherwise still rather impure GeO_2 .

The following method of purification is used to prepare very pure GeO_2 , in which the impurities just barely show on spectroscopic examination (total impurity level well below 0.01%).

III. PURIFICATION OF GERMANIUM OXIDE

The combined distillates of the first distillation or the crude GeO_2 from the alkaline decomposition are added to the flask of the carefully cleaned distillation apparatus described under I (for preparation of especially high purity material, a second apparatus, which is used only for this purpose, is kept on hand). The flask is half filled with pure, 6N hydrochloric acid. If the GeO_2 to be processed comes from alkaline decomposition, then 700 ml. of pure, concentrated, 38% hydrochloric acid (d 1.19) is added for each 100 g. of crude GeO_2 , and the flask may then be filled to the half-way mark with 6N hydrochloric acid. Distillation proceeds

slowly in a stream of Cl_2 , as described under I. Pure distilled water is added to the third receiver. The first two receivers are cooled as described under I. During the distillation, distilled water is frozen to an ice slurry in a carefully cleaned 3-liter glass flask by cooling and shaking (seed with a crystal of ice). One liter of distilled water is used for each 1.5 kg. of ore processed. The ice should crystallize out, as much as possible, during the shaking after inoculation, so that a thick crust of ice does not form on the walls of the flask, since that might lead to cracking of the flask. When a rather thick slush is obtained, the GeCl_4 collected in the receiver is poured into the ice slurry with vigorous shaking. The shaking is continued for 5-10 minutes, and the flask is then allowed to stand for several hours with occasional shaking. The GeO_2 settles out overnight. The strongly acid supernatant liquid is decanted and may be reused for diluting the concentrated hydrochloric acid in further runs. (If there is no need for this, the Ge contained in the liquid may be precipitated with H_2S in the form of GeS_2 , following the removal of dissolved Cl_2 with H_2SO_3 . However, the acid content of the solution must then be brought to 6N.) After decanting the acid supernatant liquid, the GeO_2 is covered with distilled water and allowed to stand for about 2-3 hours, with occasional shaking during the first hour. This treatment serves to remove the tenaciously clinging Cl ions. If this is not done, losses are incurred on later drying. The solid is dried on a fritted-glass suction filter and washed thoroughly with cold water. The GeO_2 is dried in an oven at 200°C while still on the filter. The filtrates and the washing water may be reused for the hydrolysis operation in additional runs. If they are not needed for this purpose, they may be worked up together with the first hydrolysis filtrate to recover the GeS_2 .

Further purification is possible before the hydrolysis by extracting the GeCl_4 with 6N HCl according to the method of Allison and Müller or by fractional distillation in a quartz column according to the method of Green and Kafalas.

PROPERTIES:

Formula weight 104.6. Exists in one amorphous and two crystalline forms. The amorphous form always arises on cooling a melt of either of the crystalline forms and resembles a clear, strongly light-refracting glass (d 3.637). The GeO_2 formed by hydrolysis of GeCl_4 or by decomposition of germanates is of the hexagonal (quartz type) form (d 4.228). M.p. 1115°C . Solubility: 0.435 g. GeO_2 /100 g. H_2O . The tetragonal (rutile) modification, which is almost completely insoluble in water, is obtained either by heating the GeO_2 at 350°C for several hours with water under pressure or by adding some ammonium fluoride to an aqueous

solution of GeO_2 and slowly evaporating. It is then heated for several hours at 380°C (d 6.239). M.p. 1086°C . The GeO_2 preparations obtained by the hydrolysis of GeCl_4 contain Cl ions even after thorough washing with water. The last traces of Cl disappear only on ignition. Pure uncalcined preparations can be obtained only by hydrolysis of a tetraalkoxygermanium. Readily soluble in strong bases and in strong hydrochloric acid.

REFERENCES:

R. Schwarz, P. W. Schenk and H. Giese, Ber. dtsch. chem. Ges. 64, 1828 (1931); R. Schwarz and E. Huf, Z. anorg. allg. Chem. 203, 188 (1931); E. R. Allison and J. H. Müller, J. Amer. Chem. Soc. 54, 2833 (1932); W. C. Johnson, S. Foster and C. A. Kraus, Ibid. 57, 1828 (1935); F. Sebba and W. Pugh, Ibid. 59, 1371 (1937); R. Schwarz and E. Haschke, Z. anorg. allg. Chem. 252, 170 (1943); H. J. Cluly and R. C. Chiruside, J. Chem. Soc. (London) 1952, 2275; W. Fischer and W. Harre, Angew. Chem. 66, 165 (1954); G. H. Morrison, E. G. Dorfman and J. F. Cosgrove, J. Amer. Chem. Soc. 76, 4236 (1954); M. Green and J. A. Kafalas, J. Chem. Soc. (London) 1955, 1604; personal communications from G. Brauer and P. W. Schenk. [For determination of As in Ge, see S. T. Payne, Analyst 77, 278 (1952).]

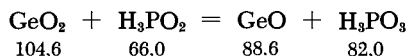
Germanium (II) Oxide**GeO**

A solution of 6 g. of GeO_2 in about 30 ml. of strong sodium hydroxide is prepared, and enough 6N HCl is added to just redissolve the precipitate initially formed. Then 600 ml. of concentrated hydrochloric acid and 45 ml. of 50% H_3PO_2 are added with cooling. The solution is heated at 100°C for 5-6 hours under a CO_2 blanket, cooled and then heated with excess aqueous ammonia to precipitate the GeO. The precipitate is either filtered or centrifuged under N_2 , washed and dried in a vacuum.

Other preparative methods:



The starting materials must be finely ground, intimately mixed and pressed into pellets [A. W. Laubengayer in L. M. Dennis, Z. anorg. allg. Chem. 174, 107 (1928)].

A method of preparation given by E. Gastinger goes back to the same basic reaction [Z. anorg. allg. Chem. 285, 103 (1956)], in

which Ge powder is oxidized with CO_2 or air under reduced pressure. The suitable apparatus is described under gallium (I) sulfide (see Fig. 250, p. 853). Boat *s* is filled with Ge powder; the GeO sublimes at 800 to 900°C in a stream of CO_2 at atmospheric pressure, or in a stream of air at 4 to 34 mm. It precipitates on the cold finger.

PROPERTIES:

Yellow when freshly precipitated, becomes brown on boiling with water. Easily oxidized. Usually contains a few percent of GeO_2 .

REFERENCES:

L. M. Dennis and R. E. Hulse, *J. Amer. Chem. Soc.* **52**, 3553 (1930); H. M. Powell and F. M. Brewer, *J. Chem. Soc. (London)* **1938**, 197; W. L. Jolly, Thesis, 1952, University of California, UCRL-1638.

Metallic Germanium

Ge

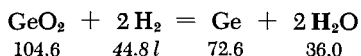

An unglazed porcelain boat, filled with uncalcined GeO_2 , is placed in a porcelain or quartz tube heated in an electric oven at about 600°C, and a vigorous stream of H_2 is passed over it. The outlet end of the tube is slightly bent downward so that condensed water does not back up into the hot tube. With small quantities (under 40 g.), reduction is complete after 3-5 hours. Larger amounts necessitate longer reduction times. The reduction temperature must be watched closely, particularly at the beginning, so it does not exceed the limit. When this happens, sintering may take place and under some conditions GeO may even vaporize, in which case it deposits on the cooler portion of the tube in tuftlike crystals. Only eventually is it reduced to Ge. The Ge is allowed to cool in a stream of H_2 . The powdery, gray-black Ge can be melted down in a stream of H_2 , using an unglazed porcelain crucible with perforated cover (Rose crucible). If a compressor is used, some O_2 must be mixed with the compressed air in order to attain the melting temperature of the Ge. The crucible may occasionally crack because of the expansion of the Ge on hardening. It is therefore advisable to use tubular crucibles (Tammann

crucibles), which are tipped into an almost horizontal position shortly before the hardening of the Ge. The otherwise rather frequent cracking of the crucible is thus definitely avoided.

The melting of the Ge can also be carried out under a layer of table salt.

Other preparative methods: Reduction with powdered charcoal or KCN.

The purest metal is obtained by reduction with H_2 and melting down in a stream of H_2 . Yield: 90%. If the Ge adhering to the crucible wall and to the reaction tube is recovered as $GeCl_4$ by chlorination (see $GeCl_4$), the yield becomes almost quantitative. The material obtained via this procedure is very pure: the only impurities present are those which are occasionally introduced by the crucible material. With pure raw material, spectroscopic examination shows them to be less than 0.01%.

PROPERTIES:

Brittle, shiny metal. Crumbles on a light blow with a hammer. Somewhat deliquescent on long exposure to moist air. In compact form, acid insoluble; soluble as a powder in ammonia plus H_2O_2 . Burns when brought to red glow, releasing thick brown fumes of GeO . Crystals: A4 structure type (diamond). M.p. $959^\circ C$. Used in the communications industry as a detector (tuning) material.

REFERENCES:

R. Schwarz and G. Elstner, Z. anorg. allg. Chem. 217, 289 (1934); private communications from P. W. Schenk and G. Brauer.

Germanium Hydrides

GeH_4 (Ge_2H_6 , Ge_3H_8)

Just as silicon hydrides germanium hydrides, can be prepared either via acid decomposition of magnesium germanide or via the reduction of $GeCl_4$ with $LiAlH_4$; however, only modest yields (20-30%) can be obtained with the latter reaction because of the formation of metallic germanium. The acid decomposition of Mg_2Ge with aqueous hydrochloric acid gives a smaller yield than the corresponding reaction with Si, but, just as in the case of silicon, the higher hydrides such as Ge_2H_6 and Ge_3H_8 can be isolated. The decomposition of Mg_2Ge with NH_4Br in liquid NH_3 gives better yields. However, the yields are again smaller than with Si. As in the latter case, primarily GeH_4 is formed.

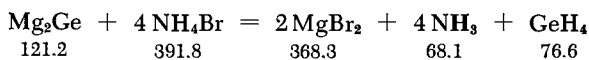

Finely powdered magnesium germanide is placed in reaction vessel *a* (Fig. 232). A 50% excess of NH_4Br is placed in flask *b*. Then enough pure NH_3 is condensed in tube *c* so that *a* is two-thirds filled. A slow stream of NH_3 is allowed to continue to flow in order to provide agitation and NH_4Br is slowly added from *b* by turning the little flask upward. The reaction begins immediately,

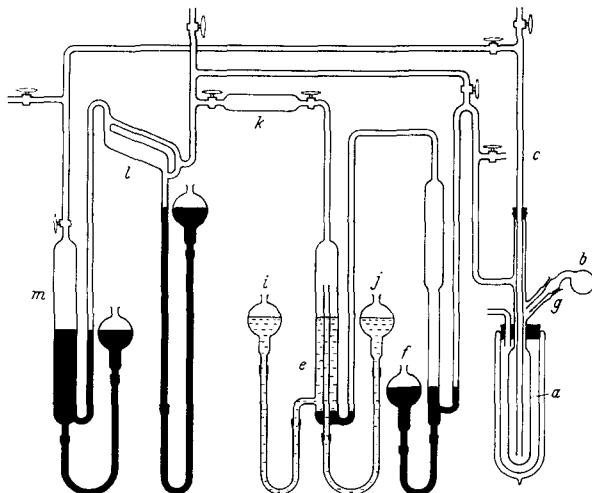

Fig. 232. Preparation of germanium hydrides.

with liberation of gas. The gases pass through the mercury trap *j* at a gage pressure of about 250 mm. and are collected over water in *e*. The water can be changed using flasks *i* and *j*. Toward the end, as the reaction slows down, the remainder of the NH_4Br is added. The reaction takes a few hours. The NH_3 is allowed to vaporize and is absorbed in collecting vessel *e*. The reaction vessel is then heated, whereby some additional gas is evolved. From the collecting vessel the gas is pumped (by the Toeppler pump *l*) through a P_2O_5 drying tube *k*, which retains the remainder of the NH_3 and H_2O , into the collecting tube *m*, where it is stored. Yield of crude germanium hydride, based on the initial Ge, is 60-70%.

The purification of the gas and the preparation of pure GeH_4 can be carried out either through fractional distillation in a Stock vacuum apparatus (whereby the small amount of Ge_2H_6 can be isolated), or by preparing NaGeH_3 or Na_2GeH_2 by the reaction of crude GeH_4 with a solution of Na in liquid NH_3 . Pure GeH_4 can then be obtained by the reaction NH_4Br with NaGeH_3 or Na_2GeH_2 . The higher germanium hydrides Ge_2H_6 and Ge_3H_8 are best prepared via the decomposition of Mg_2Ge with aqueous hydrochloric

acid. The total yield is smaller, but the yield of Ge_2H_6 and Ge_3H_8 is greater.

PROPERTIES:

Colorless gases. GeH_4 ; m.p. -165°C , b.p. -88°C , $d(-142^\circ\text{C})$ 1.523. Ge_2H_6 ; m.p. -109°C , b.p. 29°C , $d(-109^\circ\text{C})$ 1.98. Ge_3H_8 ; m.p. -106°C , b.p. 110.5°C , d 2.2. Decompose in air, often bursting into flames. Decompose to the elements above 350°C .

REFERENCES:

L. M. Dennis, R. B. Corey and R. W. Moore, *J. Amer. Chem. Soc.* 46, 657 (1924); C. A. Kraus and E. S. Carney, *J. Amer. Chem. Soc.* 56, 765 (1934); A. E. Finholt, A. C. Bond, K. E. Wilzbach and H. J. Schlesinger, *J. Amer. Chem. Soc.* 69, 2692 (1947); K. Clusius and F. Faber, *Angew. Chem.* 55, 97 (1942); W. C. Johnson and S. Isenberg, *J. Amer. Chem. Soc.* 57, 1349 (1935).

Germanium (IV) Chloride

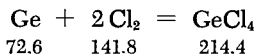

A boat with powdered Ge is placed in the tube used for the reduction of GeO_2 and a fast stream of dry Cl_2 is passed over it while the apparatus is heated. The final temperature is $500-600^\circ\text{C}$. The reaction begins, however, at a much lower temperature, and a Pyrex reaction tube is usually sufficient. The tube can also be filled with broken boats and crucibles, to which Ge still adheres, in order to recover this germanium, which is difficult to reclaim in any other way. The tube, tilted somewhat toward the exhaust end, is connected with a gas trap by means of an adapter. The trap is cooled with ice-salt or, still better, with a Dry Ice-acetone mixture. The distillate, colored yellow by the Cl_2 , is largely freed of the Cl_2 by fractionation and is then redistilled over Cu powder, Hg or Hg_2Cl_2 .

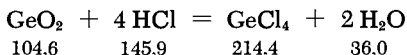

The apparatus and the procedure are the same as used for the purification of the crude germanium oxide. However, no Cl_2 is added since the starting GeO_2 is arsenic-free. It is, of course,

also possible to use the unhydrolyzed GeCl_4 obtained from the purifying distillation. It may be freed almost completely of dissolved Cl_2 by simple distillation, with the remaining chlorine removed by shaking with copper powder. The distilled GeCl_4 is separated from the hydrochloric acid in a separatory funnel, dried with ignited Na_2SO_4 , and decanted from the sediment on the bottom into a distilling flask. After the first fraction has been distilled, some Cu powder or Cu turnings are added: the mixture is shaken for some time and distilled into a well-dried ampoule. The remaining Ge can be recovered as GeO_2 from the first distillate and from the Na_2SO_4 .

III. The GeO_2 (10.4 g.) is heated for eight hours at 170 to 180°C, together with ten times its weight of HCl (d 1.19), using a pressure flask placed in an oil bath. The GeO_2 dissolves. After cooling, the GeCl_4 , which separates as the heavier layer below the hydrochloric acid, is drained off in a separatory funnel and distilled.

The GeO_2 , which adheres tenaciously to the vessels and other apparatus, can be easily dissolved out with strong sodium hydroxide. After acidification, it can be recovered as GeS_2 by introducing H_2S .

PROPERTIES:

Water clear, mobile liquid. Fumes in air and is easily hydrolyzed by H_2O . Peculiar odor, easily distinguished from the simultaneously perceptible odor of HCl. M.p. -49.5°C , b.p. 83.1°C ; d (19.5°C) 1.886.

REFERENCES:

- I and II. See references under GeO_2 .
 III. H. Bauer and K. Burschkies, Ber. dtsh. chem. Ges. 66, 277 (1933); A. W. Laubengayer and D. L. Tabern, J. Phys. Chem. 30, 1947 (1926).

Germanium Dichloride

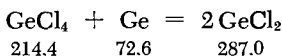

Germanium powder, which has been thoroughly reduced in a stream of H_2 at the lowest possible temperature and cooled in a stream of H_2 , is placed in the small tube ϱ of the apparatus shown in Fig. 233. The small flask α is filled with pure GeCl_4 (dried overnight over CaCl_2 and ignited Na_2CO_3 and distilled into α).

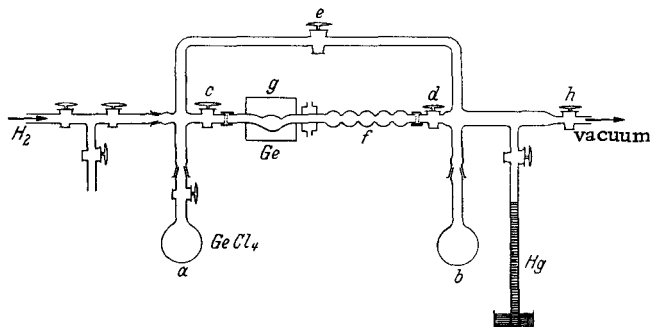
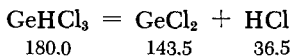

Fig. 233. Preparation of germanium dichloride.

Flask *a* is then cooled with liquid nitrogen, the apparatus is evacuated, and *g* is heated with a small electric furnace. When *g* reaches 300°C, *c* and *d* are opened and *h* is closed. Now *b* is cooled instead of *a*. The temperature of *g* is then elevated to 340°C. The reaction begins at 350°C. After all material distills into *b*, both *c* and *d* are closed and the material is redistilled into *a* via *e*. This is repeated until sufficient GeCl_2 is obtained in *f*.

A modified arrangement for the convenient preparation of GeCl_2 from $\text{Ge} + \text{GeCl}_4$ has been described by R. Schwarz and E. Baronetzki.



Even at -30°C there is an equilibrium between considerable quantities of HCl and GeCl_2 and GeHCl_3 . Therefore, GeCl_2 can be obtained by pumping out the GeHCl_3 at -30°C . In addition to HCl , some GeHCl_3 also distills into a second, liquid-nitrogen-cooled trap. Pure GeCl_2 remains in the first trap.

PROPERTIES:

Colorless, highly reactive. Begins to decompose slightly above room temperature, acquiring a color ranging from yellow to red, giving off GeCl_4 and yielding chlorine-poor germanium chlorides. At an elevated temperature these finally convert to Ge . Soluble in benzene and ether.

REFERENCES:

- I. L. M. Dennis and H. L. Hunter, *J. Amer. Chem. Soc.* **51**, 1151 (1929); R. Schwarz and E. Baronetzki, *Z. anorg. allg. Chem.* **275**, 1 (1954).
- II. C. W. Moulton and J. G. Miller, *J. Amer. Chem. Soc.* **78**, 2702 (1956).

Germanium (IV) Bromide

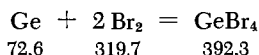

As shown in Fig. 234, a boat containing Ge powder, prepared by reduction of GeO_2 at the lowest possible temperature, is heated in a combustion tube. The tube is connected by means of an adapter

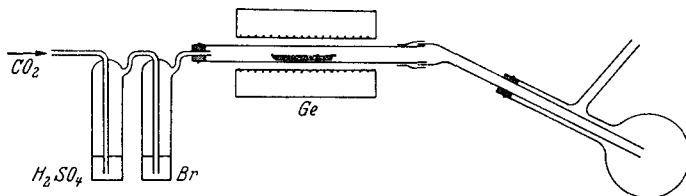
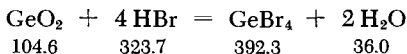

Fig. 234. Preparation of germanium tetrabromide.

(sealed with a piece of rubber tubing) to a distilling flask serving as a receiver. The tube is connected on the other side to two wash flasks, the first with Br_2 and the second with concentrated H_2SO_4 . A stream of thoroughly dried CO_2 is now passed through the apparatus. The reaction starts at a rather low temperature. At 200°C it becomes vigorous, and a crystalline mass, colored yellow by Br_2 , collects in the cooling tube. From time to time it is melted down into the flask with a burner. This product is redistilled. It is not necessary to remove excess Br_2 by treatment with Hg , since this can be accomplished without difficulty by simple distillation. In this way, a pure white product is obtained. The yield is almost quantitative.



A tenfold excess of hydrobromic acid (d 1.78) is heated with 10.4 g. of GeO_2 in a pressure flask. The heating is continued for 24 hours at 180°C in an oil bath. The GeBr_4 formed is separated in a funnel and is distilled.

Additional preparative method: Finely pulverized Ge , reduced at a low temperature, is refluxed in a flask with an excess of Br_2 (about 4 hours at 60°C), the excess Br_2 is distilled off after removing the insoluble residue, and the crude product is fractionated.

PROPERTIES:

White, regular, glittering crystals (flattened octahedra). $d(29^\circ\text{C})$ 3.123. B.p. 185.9°C (corr.), m.p. 26°C . Hydrolyzed by H_2O . Soluble in absolute alcohol, CCl_4 , benzene and ether.

PROPERTIES:

- I. L. M. Dennis and F. E. Hance, *Z. anorg. allg. Chem.* **122**, 256 (1922); F. M. Brewer and L. M. Dennis, *J. Phys. Chem.* **31**, 1101 (1927).
- II. H. Bauer and K. Burschkies, *Ber. dtsch. chem. Ges.* **66**, 277 (1933); A. W. Laubengayer and P. L. Brandt, *J. Amer. Chem. Soc.* **54**, 621 (1932).

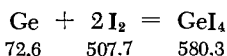
Germanium (IV) Iodide

The preparation of GeI_4 is similar to that of the tetrabromide. The necessary I_2 vapor is produced simply by placing a boat with I_2 in the front part of the tube in which the boat with the Ge powder is resting and heating the I_2 boat as needed. When larger quantities of the I_2 vapor are needed, they are produced in a retort, which is filled with I_2 and through the opening of which CO_2 is introduced. The neck of the retort is inserted into the combustion tube, and the joint is sealed with a piece of rubber tubing. The retort is heated in a water bath. The reaction begins at about 220°C and becomes vigorous after the tube reaches a temperature of 560°C . The GeI_4 is purified in the same way as GeBr_4 .

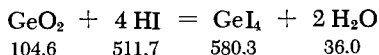

After expelling the air with CO_2 , 28 ml. of constant-boiling, colorless hydriodic acid is poured over 5 g. of GeO_2 in a 100-ml. wide-neck round flask provided with a distilling head and an inlet tube for CO_2 . The contents are slowly heated and kept boiling gently for 10 minutes. The GeO_2 disappears and orange-red crystals are formed. The heating is increased and the water formed is distilled off. Finally the contents of the flask are sucked dry through a fritted glass filter crucible. Drying is continued in a desiccator without a vacuum. The material is purified by vacuum sublimation or, even better, by recrystallization from chloroform.

REFERENCES:

Orange-red, crystalline mass. Crystallizes in the cubic system. Soluble in carbon disulfide, chloroform and benzene, among other solvents. M.p. 146°C , b.p. $\sim 350^\circ\text{C}$; d (26°C) 4.322.

REFERENCES:

- I. L. M. Dennis and F. Hance, *J. Amer. Chem. Soc.* 44, 2854 (1922); *Z. anorg. allg. Chem.* 129, 206 (1923).
- II. A. W. Laubengayer and P. L. Brandt, *J. Amer. Chem. Soc.* 54, 621 (1932); L. S. Foster and A. F. Williston in W. C. Fernelius, *Inorg. Syntheses*, Vol. II, New York-London 1946, p. 112.

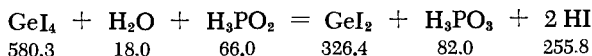
Germanium Diodide

A three-neck, 250-ml. flask with ground joints is filled with 20 g. of GeI_4 . The center neck is provided with a mercury-seal stirrer; the other two carry a reflux condenser and a ground glass stopper. Ten ml. of colorless, 57% hydriodic acid and 20 ml. of H_2O are added, the stirrer is turned on, 7.6 ml. of 50% hypophosphorous acid is added (2 ml. excess), and the glass stopper is inserted. The contents of the flask are refluxed until the red crystals of GeI_4 are transformed into the yellow ones of GeI_2 . This happens in a short time. The material is cooled to 0°C ; the crystals are filtered through a fritted glass filter crucible and washed with dilute hydriodic acid (2 parts H_2O + 1 part 57% HI). The material is vacuum-dried over P_2O_5 in a drying pistol heated with boiling toluene, whereby the remainder of the unreacted GeI_4 is sublimed off. Yield: 9 g. (75% of theoretical, based on GeI_4).

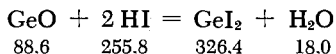

Freshly precipitated GeO (see p. 711), prepared from 6 g. of GeO_2 , is filtered and washed and then reacted with 45 ml. of iodine-free, constant-boiling hydriodic acid. The resulting suspension is heated for half an hour at 80°C with stirring. After cooling, the precipitated crystals of GeI_2 are sucked dry and washed with 50 ml. of hydriodic acid diluted as in I. The drying procedure is the same as in I.

Other preparative method: $\text{GeS} + 2 \text{HI} = \text{GeI}_2 + \text{H}_2\text{S}$

PROPERTIES:

Yellow crystals, CdI_2 structure type.

REFERENCES:

E. A. Flood, L. S. Foster and E. W. Pietrusza in W. C. Fernelius, *Inorg. Syntheses*, Vol. II, New York-London 1946, p. 106; L. S. Foster in L. F. Audrieth, *Inorg. Syntheses*, Vol. III, New York-Toronto-London 1950, p. 63; H. M. Powell and F. M. Brewer, *J. Chem. Soc. (London)* 1938, 197.

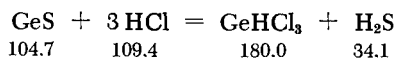
Trichlorogermane

The apparatus consists of a flask with ground joints and with inlet and outlet tubes. Several traps, connected in series, are attached to the outlet. The inlet is connected to a supply of HCl which was either passed over P₂O₅ or prepared from solid NaCl and concentrated H₂SO₄. Vacuum-dried, precipitated GeS is added to the flask. The first trap is cooled with liquid nitrogen. The reaction starts spontaneously upon introduction of HCl. After completion of the run, the HCl supply is shut off, the apparatus is evacuated, and all volatile products of the reaction are condensed in the trap cooled with liquid nitrogen. The third trap is then cooled with liquid nitrogen, while the first is brought to -78°C. After the H₂S and HCl are completely separated out, the second trap is cooled with liquid nitrogen and the first is brought to -45°C (temperature of melting chlorobenzene). Two hours of standing in a vacuum suffices to remove the dissolved gases from the reaction product. The latter can then be fractionated under vacuum in the usual way and distilled into ampoules.

Additional preparative method: passing HCl over powdered Ge (with heating): $\text{Ge} + 3 \text{HCl} = \text{GeHCl}_3 + \text{H}_2$.

PROPERTIES:

Colorless, mobile liquid. Distills at ~75°C. Loses HCl with the formation of GeCl₂ at about -30°C. The HCl remains dissolved in the GeHCl₃. Therefore GeCl₂ can be prepared from GeHCl₃ at -30°C (under suction). Conversely, GeHCl₃ can be obtained from GeCl₂ by condensing HCl upon the latter. M.p. -71°C.

REFERENCES:

L. M. Dennis, W. R. Orndorff and D. L. Tabern. *J. Phys. Chem.* 30, 1049 (1926); C. W. Moulton and J. G. Miller, *J. Amer. Chem. Soc.* 78, 2702 (1956).

Methylgermanium Triiodide

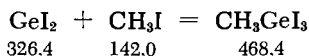

The apparatus shown in Fig. 235 is connected to a vacuum pump. The thick-wall Pyrex ampoule *a* contains 10 g. of GeI_2 . After evacuation, 2.1 ml. (4.8 g.) of CH_3I is allowed to distill from the graduated vessel *b* into the ampoule, which is cooled with acetone-Dry Ice mixture. The ampoule *a* is now sealed at the neck and heated for 24 hours at 110°C . (Caution: danger of explosion, particularly at the beginning, if the ampoule is too weak.) If the initial charge of GeI_2 is oxide-free, the crystals disappear as the reaction proceeds and a clear solution is obtained. Provided too great an excess of CH_3I was not charged in, the yellow solution hardens on cooling. The excess CH_3I is distilled off by cooling the side bulb *c* in a cooling mixture. The vessel is then opened; the contents are placed in a suitable distillation apparatus and, after removing all remaining CH_3I , finally distilled.

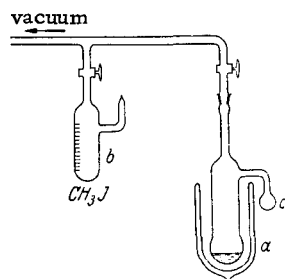

Fig. 235. Preparation of methyl germanium triiodide.

PROPERTIES:

Lemon-yellow rhombic crystals. M.p. 48.5°C , b.p. (752 mm.) 237°C . With rising temperature the crystals become reddish. Soluble in H_2O (with hydrolysis) and in organic solvents, such as petroleum ether.

REFERENCES:

E. A. Flood, K. I. Godfrey and L. S. Foster in L. F. Audrieth, *Inorg. Syntheses*, Vol. III, New York-Toronto-London 1950, p. 64; E. A. Flood, *J. Amer. Chem. Soc.* 55, 4935 (1933).

Germanium Nitride

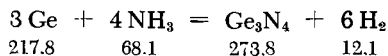

Powdered Ge, freshly reduced in a hydrogen stream at 600°C , is placed in a boat of sintered corundum or quartz. The boat is

placed in an electrically heated quartz or porcelain tube, the temperature of which can be measured with a thermocouple. A stream of NH_3 is passed over the boat. The reaction starts at about 650°C . The temperature must be maintained at about 700°C , since the nitride recombines into its elements above 850°C .

Additional preparative methods: a. Heating GeO_2 in a stream of NH_3 at 750°C : $3 \text{ GeO}_2 + 4 \text{ NH}_3 = \text{Ge}_3\text{N}_4 + 6 \text{ H}_2\text{O}$. b. Thermal decomposition of $\text{Ge}(\text{NH})_2$. The latter is obtained from GeCl_4 by ammonolysis according to the equation $\text{GeCl}_4 + 6 \text{ NH}_3 = \text{Ge}(\text{NH})_2 + 4 \text{ NH}_4\text{Cl}$. The $\text{Ge}(\text{NH})_2$ yields Ge_3N_4 above 300°C , the decomposition going through the $\text{Ge}_2\text{N}_3\text{H}$ stage.

PROPERTIES:

Colorless powder when pure; however, usually brownish. Crystallizes in a phenacite-type structure.

REFERENCES:

R. Schwarz and P. W. Schenk, *Ber. dtsh. chem. Ges.* **63**, 296 (1930); W. C. Johnson, *J. Amer. Chem. Soc.* **52**, 5160 (1930); R. Juza and H. Hah, *Naturwiss.* **27**, 32 (1939); R. Juza and A. Rabenau, *Z. anorg. allg. Chem.* **285**, 212 (1956); H. Hahn and R. Juza, *Z. anorg. allg. Chem.* **244**, 111 (1940).

Germanium Disulfide

GeS_2

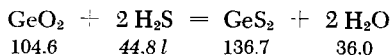

A solution of GeO_2 in 6N HCl is prepared. Alternatively, the solutions remaining from the hydrolysis of GeCl_4 may be used, following removal of Cl_2 with H_2SO_3 . A rapid stream of H_2S is then introduced. The flask is tightly closed with a rubber stopper and is allowed to stand (preferably overnight) under the pressure of a Kipp apparatus. Pure white GeS_2 precipitates out and is filtered off, washed successively with dilute HCl, alcohol and ether, and dried in a vacuum desiccator. The yield is quantitative. May be obtained in crystalline form by sublimation of GeS (at red heat) in a stream of sulfur vapor.

Additional preparative method: Passage of S-containing H_2S over GeO_2 at red heat.

PROPERTIES:

Precipitated: white, heavily chalking powder. Difficult to wet with water. Crystalline: flakes with a mother-of-pearl luster. d (14°C) 2.942. At about 800°C , melts to a dark liquid which hardens to an amber-yellow, transparent mass. Soluble in alkali as a thio salt. Can be converted to GeO_2 by dissolving in ammonia and oxidizing with H_2O_2 . Volatile in an inert atmosphere at 800°C .

REFERENCE:

W. Pugh, J. Chem. Soc. (London) 1930, 2370.

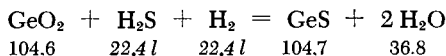
Germanium Monosulfide**GeS**

A boat containing GeO_2 is heated in a combustion tube while a gaseous mixture of H_2S and H_2 is passed over it. The reaction begins at 500°C and gives an almost quantitative yield of the sulfide. A few hours are needed for the conversion of 10 g. of GeO_2 . The GeS formed sublimes and is removed from the tube, pulverized and digested with cold, dilute ammonia. The byproduct GeS_2 is thereby dissolved and solid GeS remains.

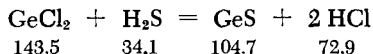

The necessary GeCl_2 solution is prepared by reducing a solution of GeCl_4 with H_3PO_2 under a CO_2 blanket, as described on page 711 for GeO . The reduction is complete when a 5-ml. sample shows at most a clouding, but no precipitate of GeS_2 on addition of 150 ml. of 6N H_2SO_4 and introduction of H_2S . After reduction, the solution is cooled, and concentrated ammonia is added until a permanent precipitate of GeO appears. The solution is then saturated with H_2S under pressure and left to stand under H_2S for about 1 hour, with frequent shaking. The GeS precipitate is filtered and washed with water which has been weakly acidified with HCl . Drying is carried out under vacuum over P_2O_5 .

PROPERTIES:

If prepared according to method I, dark, gray-black crystals in reflected light, red to yellow-red in transmitted light. Red-brown

crystals when prepared according to method II. M.p. $\sim 530^{\circ}\text{C}$, d 4.012. Soluble in HCl, reacts with HCl gas at room temperature according to the equation $\text{GeS} + 2 \text{HCl} = \text{GeCl}_2 + \text{H}_2\text{S}$. Dry GeS is stable in air.

REFERENCES:

W. Pugh, J. Chem. Soc. (London) 1930, 2371; L. M. Dennis and R. E. Hulse, J. Amer. Chem. Soc. 52, 3553 (1930); L. S. Foster in: W. C. Fernelius, Inorg. Syntheses, Vol. II, New York-London 1946, p. 102.

Tetraethoxygermane

Since GeCl_4 does not react, as does SiCl_4 , with alcohol to split off HCl, another procedure must be used:

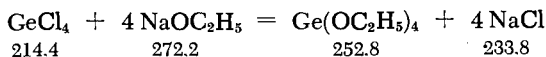

A solution of 9.8 g. of metallic sodium in a considerable excess of absolute alcohol (the latter is distilled from Ca chips) is prepared. A solution of 20 g. of GeCl_4 in absolute ether is added with stirring and exclusion of moisture. The mixture is refluxed for several hours and then decanted from the NaCl which separates. The solid is washed with absolute ether. The washings are combined with the main solution and the solvent is then driven off in vacuum. Finally, the tetraethoxygermane is distilled. It is redistilled at atmospheric pressure.

PROPERTIES:

Water-clear liquid. B.p. 186°C . Hydrolyzes easily, yielding GeO_2 .

REFERENCES:

D. L. Tabern, W. R. Orndorff and L. M. Dennis, J. Amer. Chem. Soc. 47, 2043 (1925); R. Schwarz, P. W. Schenk and H. Giese, Ber. dtsh. chem. Ges. 64, 366 (1931).

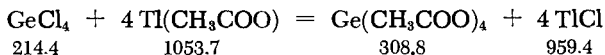
Germanium Tetraacetate

The apparatus consists of a three-neck, ground joint, 150-ml. flask, fitted with a dropping funnel, a mercury-seal stirrer and a reflux condenser equipped with a drying tube. A suspension of 50 g. of thallium acetate in 100 ml. of acetic anhydride is placed in the flask and a solution of 10 g. of GeCl_4 in 20 ml. of the anhydride is added dropwise from the funnel with vigorous stirring. Stirring is continued for 15 minutes on an 80°C oil bath and then at room temperature for another 45 minutes. The resulting TlCl precipitate is filtered off with exclusion of moisture and the filtrate is evaporated to 10 ml. under a vacuum of 20 mm. On cooling, the germanium tetraacetate separates out almost quantitatively in the form of fine needles. These are washed with acetic anhydride and anhydrous ether on a fritted glass filter crucible and dried in a vacuum.

PROPERTIES:

Fine white needles. M.p. 156°C (decomposes before melting if heated too slowly). Hydrolyzes in water to acetic acid and GeO_2 . Soluble in acetic anhydride, benzene and acetone, only slightly soluble in CCl_4 .

REFERENCE:

G. Schmidt, C. Blohm and G. Jander, *Angew. Chem.* 59, 235 (1947).

Tin and Lead

M. BAUDLER

Tin**Sn**

TIN POWDER

Somewhat below its melting point (232°C) tin becomes brittle, so that it can be broken down to a powder. A polymorphic γ -modification, to which this property was formerly ascribed, is not present according to recent x-ray studies.

Powdered tin can be commercially obtained in various grades of fineness. To prepare smaller quantities in the laboratory, pure tin is melted in a porcelain dish and heating is continued until the mass glows dark red. Liquid tin is poured off from the surface oxide scum into a preheated porcelain mortar and is vigorously pounded immediately after hardening. Since the metal cools down quickly to temperatures at which brittleness disappears, the mortar should be kept at about 200°C. If this is not done, the larger unbroken pieces must be heat treated again.

Because of its high reactivity, tin powder is used in place of granulated tin or tin bars for the preparation of various Sn compounds.

REFERENCES:

- L. Vanin. Handb. d. präp. Chem., 3rd Ed., Vol. I, Stuttgart, 1925.
p. 587.
C. L. Mantell. Tin, 2nd Ed., New York, 1949.

GRAY α -TIN

Common, tetragonal β -Sn converts into powdery, gray α -Sn on intense cooling to below 13.2°C, particularly in the presence of suitable catalysts.

Tin filings are mixed with a 10% solution of $(\text{NH}_4)_2\text{SnCl}_6$ in absolute alcohol in a closed flask and, when possible, some α -Sn (about 1/100 of the Sn charge) is added. Complete conversion to gray α -Sn occurs on standing for several days in a refrigerator at -5°C . The recovered powder is carefully washed with cold, dilute hydrochloric acid, then with alcohol and ether, and dried in a vacuum desiccator at low temperatures.

REFERENCES:

- E. Cohen and C. van Eijk. *Z. physik. Chem.* 30, 601 (1899).
 E. Cohen. *Z. physik. Chem.* 35, 588 (1900).

Tin (II) Chloride



Anhydrous tin (II) chloride is obtained by dehydration of the dihydrate:

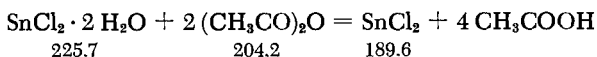

Commercial, crystallized $\text{SnCl}_2 \cdot 2 \text{H}_2\text{O}$ (226 g.) is added with stirring to 204 g. of acetic anhydride (99-100%) in a 600-ml. beaker. The dehydration starts instantaneously with intense heat evolution and the $(\text{CH}_3\text{CO})_2\text{O}$ occasionally reaches boiling (use a hood); the anhydrous salt separates out in fine, white crystals at the same time. After 1.5 hours of this treatment it is filtered to dryness under suction, washed with two 15-ml. portions of dry ether, and dried in a vacuum desiccator. The yield is quantitative (189 g.). The product can be further purified by high vacuum distillation in a Vycor container or, preferably, in one of quartz.

Store in tightly closed ground glass bottles.

PROPERTIES:

White crystalline substance with an oily sheen; relatively stable in air; partial decomposition with hydrolysis and oxidation on continued exposure.

M.p. 247°C ; the melt tends to supercool. B.p. 606°C ; d 3.95. Rhombic crystals.

Readily soluble in water; the dihydrate crystallizes from concentrated solution; at greater dilutions, hydrolyzes with formation of $\text{Sn}(\text{OH})\text{Cl}$; quite soluble in acetone, amyl alcohol, ethyl acetate, and absolute methanol and ethanol.

REFERENCES:

Organic Syntheses, Vol. 23, New York, 1943, p. 63.

H. Stephen. J. Chem. Soc. (London) 1930, 2786.

W. Fischer and R. G \ddot{e} wehr. Z. anorg. allg. Chem. 242, 188 (1939).

Tin (IV) Chloride



I.

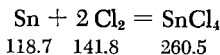

The apparatus shown in Fig. 236 is used, with vessel size chosen according to the amount of SnCl_4 desired. The Pyrex reaction vessel *a* is connected through the overflow tube *e* to the closed receiver *c*. The diameter of tube *e* must be large enough so that the liquid overflowing from *a* does not block the escape of gas from *c* into *d*. Tube *d* is directly connected (via a CaCl_2 drying tube) to the stack part of the hood arrangement. Flask *b* serves as a safety trap in case of liquid backup. Vessel *a* is filled with pure Sn granules to a height of 1-2 cm. below the branching-off point of *e*. If possible, a few milliliters of SnCl_4 are added (to facilitate initiation of the reaction) so that the gas inlet tube *f* just barely dips below the surface of the liquid. A fast stream of pure, dry Cl_2 (see p. 272) is introduced through tube *g*. Immediately following the start of the reaction, *a* is cooled by immersion in water and the Cl_2 stream is so regulated that the SnCl_4 formed does not boil. An occasional glowing of the Sn beneath the liquid causes no harm. The vessel *a* fills rapidly with SnCl_4 , which then overflows into *c*. The

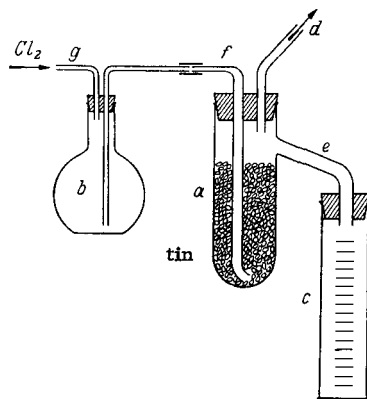
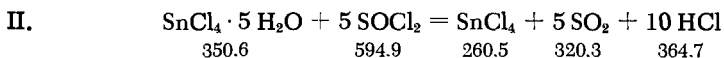

Fig. 236. Preparation of tin (IV) chloride.

yield is almost quantitative. Several kilograms of SnCl_4 can thus be easily prepared within a day. The crude product from c and a is left standing for some time over Sn foil (with occasional shaking) to remove the dissolved Cl_2 . The crude is then separated from excess metal by distillation in a ground glass apparatus, with careful exclusion of moisture; the boiling point of the pure substance is 114°C .



Somewhat more than the theoretically necessary amount of SOCl_2 (see p. 382) is poured over crystallized $\text{SnCl}_4 \cdot 5 \text{H}_2\text{O}$ in a flask with ground glass joints and the mixture is refluxed for a few hours, with a drying tube attached to the condenser. After the reaction, most of the unconverted SOCl_2 is distilled off on a water bath, using the appropriate ground glass attachment. The last traces of SOCl_2 , as well as of dissolved SO_2 and HCl , are removed by repeated evacuation of the reaction flask at room temperature. The crude product is purified by careful fractionation in a column, while preventing access of moisture. The completely colorless middle fraction, boiling at 114°C , is collected.

PROPERTIES:

Colorless liquid, fuming in air; takes up moisture, forming various hydrates and therefore is stable only when kept in hermetically closed vessels.

M.p. -30.2°C , b.p. $+114^\circ\text{C}$; d. (20°C) 2.23.

Dissolves exothermically in water with extensive hydrolysis to colloidal stannic acid; miscible in all proportions with CS_2 .

REFERENCES:

- I. H. Danneel, *Angew. Chem.* 39, 1553 (1926); see also R. Lorenz, *Z. anorg. Chem.* 10, 44 (1895).
- II. H. Hecht, *Z. anorg. Chem.* 254, 37 (1947).

Hexachlorostannic Acid

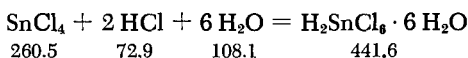

The stoichiometric quantity of H_2O ; in the form of concentrated hydrochloric acid (66.1 g., d 1.19) is added to 100 g. of pure SnCl_4 (see previous section). Considerable heat and HCl evolution accompany the reaction. When the reaction subsides, the flask is closed

with a two-hole rubber stopper with gas inlet and outlet tubes, both of which reach to the bottom of the flask. Pure, dry HCl (see p. 280) is introduced at room temperature. Absorption of the gas is favored by gentle rotation of the flask. At saturation (weight increase of about 8 g.), the gas flow is stopped and the reaction mixture is cooled by placing the flask in cold water. Crystals begin to settle out after a short time, and soon the entire contents of the flask solidify to a flaky, colorless mass. If pure materials have been used as reactants, the product is quite pure at this state. It can be separated into fractions of various grades of purity by repeated melting, partial crystallization and decantation of the mother liquor. The yield is almost quantitative.

Remains stable only when stored in sealed ampoules.

PROPERTIES:

Colorless, flaky crystals; very deliquescent in moist air with simultaneous liberation of HCl and formation of $\text{SnCl}_4 \cdot 5 \text{H}_2\text{O}$.

M.p. 19.2°C ; gives off HCl at somewhat higher temperatures; d ($27\text{--}28^\circ\text{C}$) 1.925.

REFERENCE:

K. Seubert. Ber. dtsch. chem. Ges. 20, 793 (1887).

Ammonium Hexachlorostannate;

Potassium Hexachlorostannate

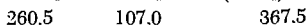
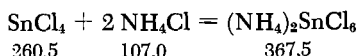

Pure, anhydrous SnCl_4 (see p. 729) is dissolved in an equal weight of H_2O and is decomposed with a 50% excess of saturated M(I)Cl solution. White crystals of $\text{M(I)}_2\text{SnCl}_6$ separate out on cooling. If desired, the volume of solution can be somewhat reduced beforehand by evaporation. To complete the crystallization, the solution is allowed to stand for some time in ice and the crystals are then sucked dry while cold. They are washed with some ice water and dried on clay in a desiccator. A concentrated solution of $\text{SnCl}_4 \cdot 5 \text{H}_2\text{O}$, containing some hydrochloric acid, may also be used in this reaction.

SYNONYM:

The ammonium salt $(\text{NH}_4)_2\text{SnCl}_6$, is known in industry as "pink salt." It is used as a mordant in dyeing.

PROPERTIES:

White, crystalline substances, may be stored in air. Both materials are very soluble in water; boiling causes precipitation of $\text{SnO}_2 \cdot n \text{H}_2\text{O}$ from dilute solutions.

$(\text{NH}_4)_2\text{SnCl}_6$: d 2.39

K_2SnCl_6 : d 2.71

Crystals have a $J 1_1$ -type structure (K_2PtCl_6).

REFERENCES:

- H. F. Walton. *Inorganic Preparations*, New York, 1948, p. 110.
R. G. Dickinson. *J. Amer. Chem. Soc.* 44, 276 (1922).
Bolley. *Liebigs Ann. Chem.* 39, 100 (1841).

Tin (II) Bromide

This compound is prepared by dissolving Sn in concentrated hydrobromic acid and concentrating this solution, thus forming H_2O - and HBr -containing crystals of SnBr_2 . Pure SnBr_2 is formed on further heating.

Concentrated hydrobromic acid is poured over Sn powder (see p. 727) contained in a flask, and the latter is warmed on a sand bath until the initial vigorous hydrogen evolution slows down. The liquid is then decanted from the undissolved Sn and evaporated on a water bath in the presence of some Sn foil until a salt scum forms on the surface. Needle-shaped crystals separate out on cooling. These are quickly sucked dry through a fritted glass filter and are placed in a vacuum over H_2SO_4 , where they are surface-dried for a short time on clay. While still moist, the crystals are put into a round-bottomed Pyrex flask and heated in a stream of pure N_2 . An open flame is used. The flask is at first fanned carefully, then the flame is applied somewhat more directly. The water and the HBr adhering to the crystals come over first. With continued increase in temperature, larger amounts of HBr are liberated because of decomposition of the intermediate compounds present. Heating is continued until no further gas bubbles are produced and a clear melt of SnBr_2 is formed. After cooling in a stream of N_2 , the product may be purified by distillation in a quartz apparatus (under a nitrogen blanket). B.p. (1 atm.) in a weak stream of N_2 : 618°C .

PROPERTIES:

Formula weight 278.53. Bright yellow, crystalline substance; somewhat hygroscopic and sensitive to light.

M.p. 232°C, b.p. 618°C; partially oxidized to Sn (IV) compounds on heating in air; d 4.92.

Hydrolyzed by water but soluble without change in pyridine.

REFERENCES:

- F. Freyer and V. Meyer. *Z. anorg. Chem.* 2, 1 (1892).
 G. Wittig and H. Hartmann. *Ber. dtsh. chem. Ges.* 72, 1387 (1939).
 J. Kendall, E. D. Crittenden and H. K. Miller. *J. Amer. Chem. Soc.* 45, 963 (1923).

Tin (IV) Bromide

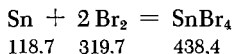

The reaction is carried out in a distilling flask with a long neck, the side arm of which is attached as close to the body of the flask as possible and ends in a CaCl_2 drying tube. Pieces of Sn, 2-3 cm. long, are placed in the flask, which is then closed above with a single-hole rubber stopper. A dropping funnel, with its tube drawn out to a capillary, is inserted in such a way that the tube ends in the lowest part of the neck of the flask but does not penetrate into the body of the flask. Pure Br_2 (see p. 275) is carefully added dropwise; this instantly produces a vigorous reaction, accompanied by a large heat evolution and possible ignition. Further addition of Br_2 must be so regulated that the reaction temperature stays below 59°C (b.p. of Br_2) and no SnBr_4 or Br_2 penetrates into the side arm. When most of the tin is consumed and a sufficient amount of liquid collects on the bottom of the flask, the dropping funnel is replaced by a thermometer and the flask is manipulated so that the side arm points directly upwards. Excess Br_2 is removed by boiling for a few minutes, during which time the SnBr_4 condenses and runs back into the flask. When the product becomes nearly colorless, the flask is restored to normal position and the material is distilled into an attached receiving vessel, taking care to keep atmospheric moisture out. Freezing of the SnBr_4 to a snow-white crystalline mass is accompanied by a small increase in volume (caution, thin-walled receivers may burst). For further purification, the crude product may be remelted, partially solidified and the liquid poured off and discarded. Alternately, the last step may be replaced by fractional distillation in a ground glass apparatus.

To preserve for extended periods of time, must be stored in sealed ampoules or in ground glass bottles with tightly fitting stoppers.

SYNONYM:

Tin tetrabromide, stannic bromide.

PROPERTIES:

White, crystalline substances; fumes somewhat in damp air; hygroscopic.

M.p. 33°C, b.p. 201°C; sublimes readily in a sealed tube; stable even on strong heating; d (35°C) 3.35.

Dissolves in water with complete hydrolysis; soluble without change in AsBr_3 .

Rhombic crystals, D_{2h}

REFERENCE:

R. Lorenz. Z. anorg. allg. Chem. 9, 365 (1895).

Tin (II) Iodide



Pure tin is covered with an excess of concentrated hydriodic acid in a flask with ground joints. A reflux condenser is then attached and the flask contents boiled until the metal dissolves and red crystals of SnI_2 begin to separate out. The copious product which precipitates on cooling is sucked through a fritted glass filter crucible and recrystallized from alcohol. The crystals are finally dried in a vacuum desiccator over P_2O_5 . For a very pure preparation the material can be repurified by high-vacuum distillation in a quartz apparatus.

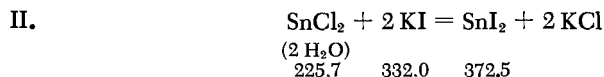

An agitated, moderately concentrated aqueous solution of SnCl_2 is rapidly mixed with a KI solution of about the same concentration containing half the stoichiometric amount of KI. If a larger quantity of KI is added, a yellow double salt coprecipitates with the red SnI_2 and is difficult to separate. After filtering the SnI_2 , additional product may be obtained from the mother liquor by addition of the second half of the stoichiometric amount of KI. This method yields a preparation which, in general, is less pure than that obtained via method I. Purification and drying of the product are as in I.

SYNONYM:

Stannous iodide.

PROPERTIES:

Red, crystalline substance. M.p. 320°C, b.p. 720°C; d 5.28.

Somewhat soluble in water (100 g. of solution contains 0.96 g. of SnI_2 at 19.8°C, 1.72 g. at 49.5°C, 3.70 g. at 97.3°C); also soluble in warm CHCl_3 , CS_2 and C_6H_6 .

Rhombic crystals.

REFERENCES:

- I. W. Reinders and S. de Lange. *Z. anorg. allg. Chem.* **79**, 230 (1913); W. Fischer and R. Gewehr. *Z. anorg. allg. Chem.* **242**, 188 (1939).
- II. B. Köhnlein. *Liebigs Ann. Chem.* **225**, 171 (1884); G. Wagner. *Anorganisch-präparatives Praktikum*, Vienna, 1947, p. 85.

Tin (IV) Iodide

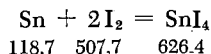

Six parts by weight of very pure CS_2 are poured over one part by weight of Sn powder in a round flask with a ground glass stopper, and four parts by weight of I_2 are gradually added. The stopper must be inserted except during actual addition. If large amounts of reactions are used, the flask must be cooled with ice. The red-brown solution formed is then drawn off from the excess of Sn (keep moisture out) and evaporated to dryness using an aspirator vacuum. Water vapor from the aspirator must be prevented from reaching the product. The red SnI_4 obtained is analytically pure.

SYNONYM:

Tin tetraiodide, stannic iodide.

PROPERTIES:

Orange-red, needle-shaped crystals. Moisture sensitive, hydrolyze completely in water; soluble without change in CS_2 , CHCl_3 and CH_2I_2 . M.p. 143.5°C, b.p. 340°C, d 4.46.

Crystals: D11 structure type.

REFERENCES:

- R. Schneider. Pogg. Ann. 127, 624.
H. Hecht. Präparative anorganische Chemie, Berlin-Göttingen-Heidelberg, 1951, p. 102.

Tin (II) Oxide**SnO**

The preparation involves conversion of tin (II) chloride to hydrated tin (II) oxide, which is then dehydrated to SnO by extended heating in an aqueous solution.

A solution of C.P. $\text{SnCl}_2 \cdot 2 \text{H}_2\text{O}$ is prepared in the smallest possible quantity of hot concentrated hydrochloric acid, and a Na_2CO_3 solution is added until the mixture gives an alkaline reaction with phenolphthalein paper (not litmus paper, since the latter gives a reaction at too small an excess of alkali). The Na_2CO_3 solution must be added carefully and gradually since the mixture foams over quite readily. The white hydrated Sn (II) oxide which settles out is heated for 2-3 hours in the supernatant liquid (bath liquid: saturated solution of NaCl, b.p. 110°C), thus causing quantitative conversion to blue-black, metallicly lustrous SnO. The product is purified by washing several times with distilled water and dried at 110°C . Yield: about 80%.

Pure SnO should yield a clear solution with hydrochloric acid, but a very slight opalescence is acceptable.

SYNONYM:

Stannous oxide.

PROPERTIES:

Formula weight 134.70. Blue-black, crystalline substance with metallic sheen. In air, is oxidized to SnO_2 above 220°C ; in inert gas, decomposes to Sn and Sn_3O_4 at $\sim 400^\circ\text{C}$. An SnO melt is stable and hardens (with simultaneous disproportionation into Sn and Sn_3O_4) at 1040°C . Above 1000°C , SnO attacks silicate-containing materials, forming Sn (II) silicate; vessels made of sintered corundum may be used up to 1600°C . B.p. (estimated) 1700°C , d 6.32.

Insoluble in water; soluble in acids, yielding Sn (II) salts.

Crystals: B 10 structure type.

REFERENCES:

- W. Fraenkel and K. Snipischski. Z. anorg. allg. Chem. 125, 235 (1922).

- M. Straumanis and C. Strenk. *Z. anorg. allg. Chem.* 213, 301 (1933).
C. G. Fink and C. L. Mantell. *J. Phys. Chem.* 32, 103 (1928).
H. Spandau and E. J. Kohlmeyer. *Z. anorg. Chem.* 254, 65 (1947).

Stannic Acids

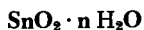

α -STANNIC ACID

I. PREPARATION BY HYDROLYSIS OF AN $\text{Sn}(\text{SO}_4)_2$ SOLUTION

Very pure tin (30 g.) is dissolved in 20 ml. of boiling concentrated H_2SO_4 (at 1.84) and the solution is kept boiling until the separated sulfur agglomerates and the liquid clears. After cooling, the mixture is filtered through a fritted glass filter crucible. Concentrated H_2SO_4 is again added to the filtrate to make the total volume 200 ml. For the hydrolysis the $\text{Sn}(\text{SO}_4)_2$ solution is rapidly and dropwise added to one liter of distilled water (good agitation is necessary). The temperature of the water is maintained at $0-2^\circ\text{C}$ by external cooling. A slightly opalescent liquid is formed. This is diluted the next day with 5 liters of ice-cold distilled water. Milky white α -stannic acid separates out. It is allowed to settle for a short time, and most of the sulfuric acid is removed by washing the precipitate with successively larger amounts of distilled water. This is continued until the wash water gives an almost neutral reaction to litmus. The precipitate is then transferred to a leaf filter and the washing is continued by repeated resuspension in water and filtration. Complete removal of the adsorbed sulfuric acid (negative BaCl_2 reaction in the wash water) is usually attained only after a four-week treatment. The α -stannic acid can be dried in air at room temperature and then ground to powder. However, it partially converts to the β -form during this operation.

II. REACTION OF AN $\text{Me}(\text{I})_2\text{Sn}(\text{OH})_6$ SOLUTION WITH ACID

An agitated solution of $\text{Na}_2\text{Sn}(\text{OH})_6$ (see section on hydroxy salts) is slowly allowed to react with dilute hydrochloric acid at room temperature until the mixture is almost neutral. The copious α -stannic acid precipitate settling out is treated as in method I. Complete removal of adsorbed foreign ions, particularly Na^+ , presents greater difficulty here than in method I, where no alkali is used.

III. REACTION OF AN SnCl_4 SOLUTION WITH AMMONIA

A small excess of ammonia is added to an aqueous solution of $\text{SnCl}_4 \cdot 5 \text{H}_2\text{O}$, which may be cleared by adding a few drops of concentrated hydrochloric acid. The gelatinous white precipitate

of α -stannic acid is purified as in method I. However, the complete removal of adsorbed foreign ions is extremely difficult.

PROPERTIES:

White, gelatinous precipitate; after drying, a white, glassy substance; increased dehydration and conversion to α -stannic acid on aging; this process is accelerated by heat.

Freshly prepared, moist α -stannic acid is soluble in sulfuric, hydrochloric and nitric acids as well as in sodium hydroxide, forming the corresponding Sn (IV) salts.

X-ray analysis shows that freshly prepared α -stannic acid is amorphous; on aging, the material increasingly shows a faded powder pattern with SnO_2 lines.

REFERENCES:

- I. A. Gutbier, G. F. Hüttig and H. Döbling. Ber. dtsh. chem. Ges. 59, 1232 (1926); W. Mecklenburg. Z. anorg. allg. Chem. 74, 207 (1912).
- II. E. Posnjak. J. Phys. Chem. 30, 1073 (1926).
- III. H. B. Weiser and W. O. Milligan. J. Phys. Chem. 36, 3030 (1932).

β -STANNIC ACID

The compound is prepared by oxidation of metallic Sn with concentrated nitric acid.

An excess of concentrated nitric acid (d 1.41) is poured over pure, granulated Sn in a deep porcelain dish, and the mixture is heated on a water bath with repeated addition of fresh acid. After cooling, most of the nitric acid is decanted. The powdered precipitate of β -stannic acid is digested several times with cold distilled water and washed on a filter until the wash water shows no further reaction with diphenylamine (about 25 washings are required). The product may be dried in air at room temperature.

PROPERTIES:

White, microcrystalline powder. Loses water increasingly on heating and finally converts to SnO_2 at red heat.

Insoluble in sulfuric acid (as opposed to α -stannic acid), concentrated hydrochloric and nitric acids, as well as concentrated sodium hydroxide.

Gives the same powder pattern as SnO_2 .

REFERENCES:

- A. Kleinschmidt. Monatsh. Chem. 39, 149 (1918).
- E. Posnjak. J. Phys. Chem. 30, 1073 (1926).
- H. B. Weiser and W. O. Milligan. J. Phys. Chem. 36, 3030 (1932).

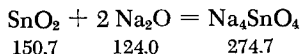
Sodium Orthostannate

Since both the Na_2O starting material and the Na_4SnO_4 product are sensitive to CO_2 and moisture in the air, the pretreatment of starting materials, the reaction itself and the handling of the product must conform to certain rules. An all-glass apparatus is used and the preparation proceeds either in a vacuum or under an inert gas blanket. For details concerning suitable apparatus and its handling, as well as the techniques of working with exclusion of air, see the quoted original literature and Part I, p. 53 ff.

Pure SnO_2 is dried in a vacuum at 500°C and is ground and thoroughly mixed with the stoichiometric amount of Na_2O in a vacuum ball mill (described in Part I, p. 76). When the powder becomes so fine that it begins to adhere to the glass walls, the grinding is stopped and the mixture is transferred into a sintered magnesia boat, excluding air as mentioned above. The boat, in a protective silver tube placed in the heated zone of a high-melting glass tube (I. D. of 25 mm.), is heated in a vacuum for some time at 500°C . Complete conversion to Na_4SnO_4 takes place. The hard product of the reaction is loosened with a chisel while maintaining a flow of purified gas and the exact composition (which varies somewhat with the length of heating time) is determined by analysis. Occasionally, the white salt is tinted green or brown by some Ag from the protective tube; however, this impurity is undetectable by analytical or x-ray techniques.

PROPERTIES:

White, hygroscopic crystalline substance; reacts vigorously with water, forming a slightly cloudy solution, which clears on addition of oxalic acid.

REFERENCE:

E. Zintl and W. Morawietz. *Z. anorg. allg. Chem.* **236**, 372 (1938).

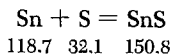
Tin (II) Sulfide**(Crystalline)**

The preparation from the elements cannot be carried out in a single step, since at the high temperatures used a portion of the

sulfur vaporizes before it can react. For this reason an excess of S must be used and the first reaction product must be repeatedly treated with additional sulfur until the approximate composition SnS is attained. Final purification is carried out in a stream of H₂.

A porcelain tube, closed on one side, is filled with a few grams of sulfur and heated in a furnace to about 900°C. A mixture of Sn and double the stoichiometric quantity of sulfur is added in portions to the tube, which by this time is filled with S vapor. A somewhat nonuniform cake is formed. The upper layer contains large, flaky crystals of SnS, while the under side is richer in Sn. After cooling, the product is pulverized, mixed with the same quantity of sulfur as before, and replaced in the heated tube. This second treatment often yields a homogeneous cake with the approximate composition SnS. If this is not the case, the heating must be continued with or without the addition of S, depending on the analysis. For purification, the crude product is transferred into an open porcelain tube and sublimed from a boat in a stream of H₂ at bright red heat. Any excess sulfur which might be present is driven off at lower temperatures and the pure SnS vaporizes at high heat. It condenses near the boat in beautiful shiny crystals.

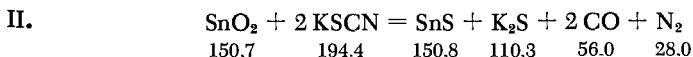

Very pure, completely anhydrous KSCN is used as the starting material. It is obtained by the repeated recrystallization of the commercial product from boiling 96% ethanol and drying under vacuum at 100°C. About 10 parts of the salt are melted in a porcelain crucible until the appearance of a blue color ($t \approx 450^\circ\text{C}$), and 1 part of pure SnO₂ is then gradually added. The reaction is accompanied by a vigorous evolution of gas, and one should wait before each new addition of SnO₂ until a clear, flowing melt is reestablished. The temperature should not exceed the initial value ($\approx 450^\circ\text{C}$) to avoid conversion of the SnS product to K₂SnS₃. When all the SnO₂ has been added, the mixture is further heated for 15 minutes and is then allowed to cool gradually. On treatment with water, the gray melt yields a residue of crystalline, analytically pure SnS.

PROPERTIES:

Dark blue-gray, crystalline mass with a bluish metallic sheen. The crystals are soft, friable and give a colored streak.

M.p. 882°C; on hardening, the melt expands noticeably between 400 and 600°C so that thin-walled vessels may burst. B.p. (in inert gas) $\sim 1230^\circ\text{C}$; heating in air to a high temperature results in oxidation to SnO₂; d 5.08.

Almost insoluble in water ($1.36 \cdot 10^{-6}$ g. in 100 g. at 18°C); soluble (with chemical change) in concentrated hydrochloric acid and yellow ammonium sulfide.

Crystals: B 29 structure type.

REFERENCES:

- I. W. Biltz and W. Mecklenburg. Z. anorg. allg. Chem. 64, 226 (1909); A. Ditte. Comptes Rendus Hebd. Séances Acad. Sci. 96, 1790 (1883).
- II. J. Milbauer. Z. anorg. Chem. 42, 433 (1904).

Tin (IV) Sulfide



(Crystalline)

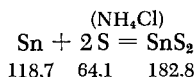

The tin necessary for the preparation is added in the form of a reactive Sn amalgam. The latter is prepared by gently heating 6.5 parts of Hg in an evaporating dish on a sand bath (use a hood) with gradual addition of 13 parts of Sn chips. When the conversion is complete, the product is allowed to cool and is coarsely ground with a glass rod directly after solidification. The mass is then further pulverized. The entire amalgam is then finely ground with 8 parts of flowers of sulfur and 6.8 parts of finely pulverized NH_4Cl . The mixture is then transferred to a Hessian crucible, which may be loosely covered with a clay or porcelain lid. The reaction mixture is moderately heated (about 400°C) on a sand bath for some length of time, either under a good hood or, still better, in the open (caution: mercury vapor). The heating is continued until no further vapors are liberated. The temperature is then quickly raised to red heat. As soon as S vapors begin to evolve or the brown mass begins to blacken at some points, the heating is stopped and the crucible is slowly cooled without increasing the movement of air. Depending on the charge, the reaction will last from 3 to 4 hours. After cooling, the crucible is carefully broken and the well crystallized upper layer, which glistens like gold, is separated. The layers below the topmost also contain SnS_2 . However, it is present in less well developed crystals. The bottom layer often contains some pure S. If the initial charge is too large, decomposition of the product (black discoloration) due to overheating may occur at the bottom and on the walls because of the poor heat transfer, while the center charge may not react thoroughly. The best

crystallizing layer is purified by sublimation on the sand bath. The translucent flakes of SnS_2 thus obtained have a beautiful gold sheen; the yield is about 50%.

This product, under the name of "mosaic gold," is used in the paint industry. As "tin-bronze," it is also employed for bronzing. Instructions for preparing products with somewhat brighter or redder color tones are given in the appended original literature.

PROPERTIES:

Flaky or scaly crystals with a high gold-yellow sheen, soft as talc; very stable in air. On heating, the color deepens reversibly to dark red, then to deep brown, above about 600°C decomposition to SnS and S takes place; d 4.5.

Insoluble in water and mineral acids; soluble (with chemical change) in aqua regia, alkali sulfide and ammonium sulfide solutions.

Crystals: C6 structure type.

REFERENCES:

- W. Obst. *Farbe und Lack* 1927, 57.
 H. Hadert. *Chemiker-Ztg.* 50, 7 (1926).
 J. Lagutt. *Angew. Chem.* 1897, 557.

Sodium Metathioannate

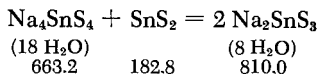
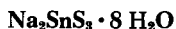

A solution of 50 g. of pure $\text{Na}_4\text{SnS}_4 \cdot 18 \text{H}_2\text{O}$ (see the following preparation) in 1.5 liters of distilled water is prepared. This solution is titrated at the boiling point with 1N HCl until a sample of the liquid gives a yellow color with bromocresol green (pH 4-5). To complete the separation of SnS_2 , the mixture is boiled gently for 4 hours. After cooling, the precipitate is very carefully washed and decanted 10 times (this takes several days) and the excess liquid is removed in a leaf filter. The pure SnS_2 is dried at 120°C and finely pulverized. The brownish powder is then placed in a boiling solution of 50 g. of $\text{Na}_4\text{SnS}_4 \cdot 18 \text{H}_2\text{O}$ in 100 ml. of distilled water, which contains a few Sn grains for protection against air oxidation. Heating is continued until the reaction (with dissolution of the SnS_2) is completed. The mixture is then evaporated

and the concentrated solution is left standing in a crystallizing dish over CaCl_2 . The colorless salt precipitate is separated from the mother liquor, washed with some ice-cold water, and purified by double recrystallization from water. Yield: 37 g. of analytically pure $\text{Na}_2\text{SnS}_3 \cdot 8 \text{H}_2\text{O}$.

PROPERTIES:

Formula weight 405.02. Colorless, prismatic crystals, which lose their water of crystallization in vacuum over P_2O_5 or by heating to 200–250°C. Readily soluble in water; 100 g. of solution at 16°C contains 38.1 g. of $\text{Na}_2\text{SnS}_3 \cdot 8 \text{H}_2\text{O}$.

REFERENCE:

E. E. Jolley. J. Chem. Soc. (London) 1933, 1580.

Sodium Tetrahiostannate (IV)

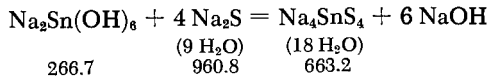
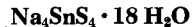

For the preparation, 100 g. of technical grade $\text{Na}_2\text{Sn}(\text{OH})_6$ (about 80% pure) and 250 g. of $\text{Na}_2\text{S} \cdot 9 \text{H}_2\text{O}$ are dissolved in 700 ml. of boiling distilled water. The solution, colored greenish-black by impurities contained in the stannate, is held for 3 hours at 90 to 100°C. Then 40 g. of finely pulverized MgO is added and the solution is heated for another 2–3 hours. The precipitated impurities are suction-filtered and the slightly yellow filtrate is concentrated on a water bath to about 300 ml. On standing, colorless $\text{Na}_4\text{SnS}_4 \cdot 18 \text{H}_2\text{O}$ separates out. The salt is placed on a fritted glass filter, washed with some ice-cold water, and purified by double recrystallization from water. The product is then placed on a clay plate and dried for a short time in air. It then has the composition indicated by the formula. On longer drying, part of the water of crystallization is lost. Yield: 80 g. of $\text{Na}_4\text{SnS}_4 \cdot 18 \text{H}_2\text{O}$.

PROPERTIES:

Colorless, crystalline substance; loses part of its water of crystallization on long standing in air or in vacuum over P_2O_5 or on heating to 200–270°C; the last two moles are given off only at

red heat, but simultaneous decomposition of the salt to SnS and Na_2S_x occurs.

Readily soluble in water (57.1 g. in 100 g. of solution at 18°C).
Monoclinic crystals.

REFERENCE:

E. E. Jelley. J. Chem. Soc. (London) 1933, 1580.

Tin (IV) Sulfate

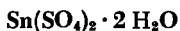

The preparation starts from α -stannic and sulfuric acids.

Freshly precipitated α -stannic acid (see p. 737) is dissolved in an excess of hot, dilute sulfuric acid, and the colorless solution is evaporated. White crystals of $\text{Sn}(\text{SO}_4)_2 \cdot 2 \text{H}_2\text{O}$ separate. These acquire a needle-shaped, platelike, or prismatic appearance with increasing acid concentration. After cooling, the salt is suction-filtered through a fritted glass crucible and left for some times in a desiccator, on clay and over P_2O_5 , in order to free it of the mother liquor. The pure product must be stored in sealed ampoules, since it is very hygroscopic.

PROPERTIES:

Formula weight 346.85. Colorless, crystalline substance; very hygroscopic. Hydrolyzes completely in water, with separation of α -stannic acid. Readily soluble in dilute sulfuric acid.

REFERENCES:

A. Ditte. Comptes Rendus Hebd. Séances Acad. Sci. 104, 172 (1887).

Tetramethyltin



The smoothest conversion and the best yields are obtained in the Grignard reaction whereby SnCl_4 is treated with a CH_3MgBr solution:

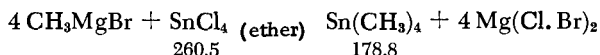
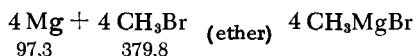

The Grignard reagent (CH_3MgBr) is prepared in a 1-liter, two-neck flask provided with a reflux condenser and a gas inlet tube reaching to the bottom. A CaCl_2 drying tube is attached to the end of the condenser to prevent access of atmospheric moisture. The flask is charged with 24.5 g. of Mg shavings (about 1 gram-atom) and 500 ml. of carefully dried ether. The reaction is initiated with about 1 g. of "activated" Mg turnings. These are prepared as follows: About 1 g. of Mg turnings and 0.5 g. of I_2 are carefully heated in a dry test tube over a free flame, until most of the iodine sublimes onto the cool part of the tube. After cooling in a desiccator the turnings, which are covered with a brownish layer, are placed in the reaction flask. Pure CH_3Br from a cylinder or from a cooled supply trap is slowly added to the liquid via the gas inlet tube. If the conversion to CH_3MgBr does not start within 3 minutes (which can be recognized by the persistence of the iodine color) then the CH_3Br flow is interrupted and the flask is carefully heated on a water bath to 60 to 70°C. A vessel filled with ice water must be on hand to permit rapid cooling if the reaction is too vigorous. Once the reaction starts, the addition of CH_3Br is so regulated that the ether remains at a moderate boil. It is absolutely necessary in further processing that the Mg be completely dissolved. About 120 g. of CH_3Br (about 1.25 moles) is normally needed to accomplish this, but considerably more may be if this reagent is introduced too rapidly. In the latter case, most of the methyl bromide escapes through the condenser without reacting. If necessary, the last traces of Mg can be converted by adding about 5 g. of CH_3I through the reflux condenser. After the addition, the reaction mixture is refluxed for half an hour on the water bath. The flask is then closed off with a CaCl_2 tube and allowed to stand at room temperature until further use.

The reaction with SnCl_2 is carried out under a hood, using a three-neck, 1-liter ground glass flask provided with a reflux condenser, a well-sealed stirrer and a dropping funnel. Both the condenser and the dropping funnel are equipped with CaCl_2 drying tubes. The SnCl_4 cannot be added directly to the Grignard reagent, as is usually done in analogous preparations. This reaction is too violent since even the reaction of SnCl_4 with ether, which yields a crystalline etherate, is very exothermic. It is therefore much more practical to prepare this etherate separately and then add to it the Grignard solution.

The reaction flask is charged with 200 ml. of absolute ether, and 45 g. of anhydrous SnCl_4 (see p. 729) is added dropwise, while vigorously stirring and cooling with ice water. After the addition, the dropping funnel is replaced with a clean one and the ethereal solution of CH_3MgBr is added over a period of 45 minutes with vigorous agitation. That addition proceeds at room temperature.

The reaction is completed by refluxing for 2 days (twice for 10 hours) on the water bath. The product is then checked for malodorous methyltin halides which are initially present. If the odor is present, refluxing must be continued. The reaction mixture is then carefully decomposed with distilled water from the dropping funnel. The flask must be cooled with ice water, and addition is continued until the initial effervescence subsides. Finally, 10% hydrochloric acid is added until the precipitated Mg salt dissolves completely and two layers can be observed in the solution (if necessary, let stand for some time). The ether layer is separated in a separatory funnel and washed successively with some water and a 5% KF solution. Any methyltin halides still present are thus converted to the corresponding fluorides. These are insoluble and can be filtered off. The ether solution is dried for several hours with CaCl_2 . Then most of the solvent is removed in a slow distillation with a suitable column. The remainder is fractionated at atmospheric pressure, using the same column. The boiling point of the pure substance is 76°C . The yield corresponds to about 90% of theoretical, based on the SnCl_4 used.

PROPERTIES:

Water-clear, highly refractive, mobile liquid with an agreeable, sweet, ether odor; poisonous; stable to air and water. B.p. 76°C , d_4^{25} 1.291. Insoluble in water; miscible in all proportions with ether, absolute alcohol and other organic solvents.

REFERENCES:

- F. Ossenbrink. Thesis, Cologne, 1952; see Also E. Krause and A. von Grosse. Die Chemie der metall-organischen Verbindungen, Berlin, 1937, p. 314 ff.

Tetraethyltin

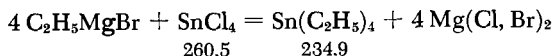
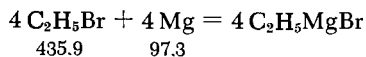

The preparation is analogous to that of $\text{Sn}(\text{CH}_3)_4$. The reader is referred to the detailed description of the procedure given under that compound, unless changes are expressly indicated in what follows.

An identical two-neck flask is used for the preparation of the C_2H_5MgBr solution. However the second neck carries a dropping funnel for the addition of C_2H_5Br instead of a gas inlet tube. About 136 g. of C_2H_5Br is needed for the conversion of 24.5 g. of Mg shavings.

Anhydrous $SnCl_4$ (45 g.; see p. 729) is carefully added dropwise to the absolute ether solution of C_2H_5MgBr in the apparatus previously described for the further reaction. This addition must be done under a hood. The reaction flask is cooled with flowing water. With larger charges the preparation of the $SnCl_4$ etherates should be carried out separately and the Grignard solution should then be added dropwise. After completion of the addition, the mixture is refluxed for one hour and the ether is then completely distilled off on a water bath. The residue is heated for 1/2 hour on a boiling water bath and after cooling is remixed with the ether previously removed. Finally, with the reflux condenser in place, water and 5% hydrochloric acid are carefully added from the dropping funnel until a clear separation of the layers is observed. The ether solution is then processed in the same way as $Sn(CH_3)_4$. Because of its high boiling point, the last fractionation of the very concentrated product is carried out under aspirator vacuum. Boiling point of the pure substance (13 mm.) is $78^\circ C$.

The yield is approximately 75%.

PROPERTIES:

Colorless, highly refractive, mobile liquid with an agreeable, sweet, ether odor; poisonous; stable to air and water; quite flammable.

M.p $-112^\circ C$, b.p. $175^\circ C$; d_4^{25} 1.192.

Insoluble in water; miscible in all proportions with ether, absolute alcohol and other organic solvents.

REFERENCES:

- E. Krause and A. von Grosse. Die Chemie der metall-organischen Verbindungen [The Chemistry of Organometallic Compounds] Berlin, 1937, p. 314 ff.;
 F. Ossenbrink. Thesis, Cologne, 1952.

Tin (IV) Acetate

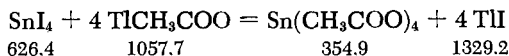

The reaction of $TlCH_3COO$ with SnI_4 requires exclusion of moisture. It proceeds in a 150-ml. three-neck ground glass flask

which is equipped with a mercury-seal stirrer, a straight, ground glass filling tube, and a reflux condenser with a drying tube. The flask is filled with a suspension of 16.8 g. of TiCH_3COO in 100 ml. of pure acetic anhydride and 10 g. of SnI_4 is added by portions with constant, vigorous stirring. The stopper on the filling tube should stay in place except for the actual short addition time. The reaction starts immediately and the yellow, sparingly soluble TiI settles out. After the addition, vigorous stirring is continued for 1.5 hours at 80°C and for 0.5 hour at room temperature. The TiI is then rapidly suction-filtered with exclusion of moisture. The filtrate is concentrated to about 50 ml. with moderate heating at 20 mm. (keep out moisture). On cooling, a precipitate of white needles of $\text{Sn}(\text{CH}_3\text{COO})_4$ is obtained. This is filtered in the absence of moisture, washed with anhydrous ether and finally dried in vacuum. Further concentration of the yellow-orange mother liquor yields an additional pale yellow fraction of the salt which may be further purified by recrystallization from acetic anhydride if necessary. The yield is practically quantitative.

PROPERTIES:

White, crystalline substance; very moisture sensitive. M.p. 253°C . Hydrolyzes in water to stannic and acetic acids; quite soluble in benzene and acetone, moderately soluble in CCl_4 .

REFERENCE:

H. Schmidt, C. Blohm and G. Jander. *Angew. Chem.* A59, 233 (1947).

Lead

Pb

LEAD, PUREST FORM

Commercial electrolytic lead (about 99.995%) is sufficiently pure for most laboratory purposes. However, it contains, depending on the method used in its production, varying concentrations of minute amounts of Cu, Bi, Fe, Zn, Cd, As, Sb, Sn, Se, Te and rare metals, totaling about $5-50 \cdot 10^{-6}$ g. of impurities/g. Pb. No significant purity improvement would be obtained by additional electrolytic refining. Thus, the lead required for special investigations, where the highest purity is needed, must be purified by processes other than electrolytic. One such method consists of the following.

A solution of 10 kg. of C.P. $\text{Pb}(\text{CH}_3\text{COO})_2 \cdot 3 \text{H}_2\text{O}$ in 5 kg. of C.P. glacial acetic acid and 500 g. of C.P. acetic anhydride is prepared by gentle heating of the mixture. After cooling to room temperature, 100 g. of thioacetic acid (pure) is quickly added, while good agitation is maintained. The mixture is then heated on a water bath until the flocculation of the PbS is complete. After standing, it is suction-filtered through fritted glass and the filtrate is diluted with enough double-distilled water so that most of the $\text{Pb}(\text{CH}_3\text{COO})_2 \cdot 3 \text{H}_2\text{O}$ is reprecipitated. The crystalline slurry is refiltered and the dilution procedure is repeated once or twice. Finally the purified salt is dried and portions of it heated in covered porcelain crucibles, whereby metallic Pb and a small amount of oxide are formed. Care must be taken to prevent melting of the PbO formed during the heating. Otherwise a lead silicate slag is formed on the wall of the crucible, from which silicic acid and possibly even molten metals can migrate into the molten Pb. Following the decomposition, the liquid metal is poured into a suitable porcelain vessel, while carefully avoiding contamination by the oxide scum. All vessels and apparatus used in this process must be thoroughly prerinced with a bromine-sulfuric acid mixture and double-distilled water. In place of thioacetic acid, a solution of 100 g. of thiourea (C.P.) in hot absolute alcohol can be used for the precipitation.

The Pb thus obtained is practically free of Se and Te as well as of all those elements whose sulfides have a lower solubility product than PbS. In addition, all colloidal impurities present in $\text{Pb}(\text{CH}_3\text{COO})_2 \cdot 3 \text{H}_2\text{O}$ (for example, Au) are removed. The noble metal content after three purification steps is $10^{-1.2}$ g. Au and $10^{-4.0}$ g. Ag/g. Pb. Very pure Pb is strikingly soft and easy to cut, and on melting is more resistant to air oxidation than the very pure commercial electrolytic material.

In testing for impurities, spectrographic analysis is applicable up to the order of magnitude of 10^{-5} g./g. Pb; Russell recommends colorimetric methods for smaller traces; see also the analytical procedure of Hemingway.

REFERENCES:

- A. E. van Arkel. *Reine Metalle*. [Pure Metals], Berlin, 1939, p. 503.
R. C. Hughes. *J. Electrochem. Soc.* 101, 267 (1954).
F. Haber and J. Jaenicke. *Z. anorg. allg. Chem.* 147, 156 (1925).
R. S. Russell. *Proc. Australasian Inst. Mining Met. (N.S.)* 87, 167 (1932); 95, Appendix I, 152 (1934); Hemingway, *Proc. Australasian Inst. Mining Met. (N.S.)* 47, 245 (1922); *Brit. Eng. Stand. Assoc., Stand. Spec.* 1928, No. 334; *Amer. Soc. Test. Mat. Standards, Triennial Issue 1930, p. 789.*

Lead (IV) Chloride

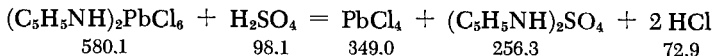
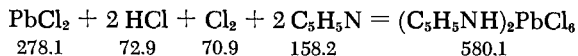

To prepare pyridinium hexachloroplumbate (IV), a 600-ml. wash flask is filled with 20 g. of very finely pulverized PbCl_2 and 400 ml. of concentrated hydrochloric acid. A vigorous stream of Cl_2 (2-3 bubbles/sec.) is then introduced while the flask is frequently shaken. The lead salts dissolve completely within 2-3 hours (if greater amounts of the compound are desired, several wash flasks filled the same way may be connected in series). The contents of the flask are cooled to 0°C and the $(\text{C}_5\text{H}_5\text{NH})_2\text{PbCl}_6$ is precipitated by adding 7 g. of pyridine. An additional 3 g. of pyridine is added to the supernatant liquor. The bright yellow compound, which is suction-filtered, is then washed with about 50 ml. of 96% alcohol and dried at 50°C . Pyridinium hexachloroplumbate (IV) decomposes instantly in water, yielding a precipitate of PbO_2 .

To prepare PbCl_4 , 20 g. of $(\text{C}_5\text{H}_5\text{NH})_2\text{PbCl}_6$ is added with slow stirring to 600 g. of concentrated H_2SO_4 (cooled to -10°C) over a period of 10 minutes. With slow, continuous stirring, the mixture is allowed to warm up to 0°C and is kept at this temperature for 1 hour. A shorter holding time is insufficient for complete separation of the PbCl_4 . A clear yellow oil settles to the bottom of the flasks, and the H_2SO_4 shows a slight milky turbidity caused by the very fine precipitate. The acid is then decanted and the oil is quickly washed in a dry separatory funnel with 50 ml. of concentrated H_2SO_4 , cooled to -10°C . The oil and acid mixture is shaken vigorously, and the pure oil, which settles in a short time, is allowed to flow into a receiver. Yield: 8 g. (66% of theoretical). Since the pure substance decomposes easily in air, especially at somewhat elevated temperatures, it is preferably kept in closed flasks under pure, concentrated H_2SO_4 and stored in the dark at -80°C . The preparation of larger amounts is not entirely without danger, since under certain circumstances an explosive decomposition to PbCl_2 and Cl_2 may occur.

SYNONYM:

Lead tetrachloride, plumbic chloride.

PROPERTIES:

Clear, yellow, highly refractive liquid; fumes in moist air; unstable, yields Cl_2 and forms PbCl_2 (observed as turbidity); may be stored for a time in the dark if kept under concentrated H_2SO_4 and at low temperatures.

M.p. -15°C . Heating accelerates the decomposition and leads under certain circumstances, to explosive decomposition; d (0°C) 3.18.

Hydrolyzes in water, yielding PbO_2 ; soluble in anhydrous CHCl_3 and CCl_4 as well as in concentrated hydrochloric acid.

REFERENCE:

W. Biltz and E. Meinecke. Z. anorg. allg. Chem. 131, 1, (1923).

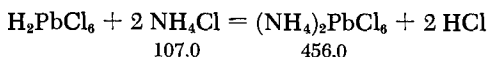
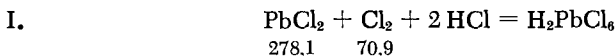
Ammonium Hexachloroplumbate

A large porcelain mortar is used to grind 30 g. of pure PbCl_2 with 60 ml. of concentrated hydrochloric acid (d 1.19), and the resulting suspension is poured into a 1-liter, flat-bottomed flask. The residue of coarser particles remaining in the mortar is treated several times in the same way, each time using the same amount of acid, until all the PbCl_2 is transformed into a fine powder suspended in 600 ml. of concentrated hydrochloric acid. The flask is then cooled in an ice bath and a moderately fast stream of pure Cl_2 (see p. 272) is introduced. Absorption of the gas is facilitated by frequently rotating the flask. The liquid becomes yellow after a short time and the PbCl_2 dissolves in 1-2 hours, forming H_2PbCl_6 . When most of the PbCl_2 has dissolved, the residue may sometimes react very slowly. If that is the case, one can either accelerate the oxidation by adding concentrated HCl and continuing the introduction of Cl_2 , or the loss of yield may be neglected and the suspension transferred to a fritted glass filter.

The clear, ice-cold H_2PbCl_6 solution is then mixed with an ice-cold solution of 12 g. of NH_4Cl in 120 ml. of water and the mixture is left standing for several hours in ice. (If a more concentrated NH_4Cl solution is used, the product is frequently

contaminated with solid NH_4Cl .) A fine, yellow precipitate of $(\text{NH}_4)_2\text{PbCl}_6$ is allowed to settle out and is rapidly filtered through an ice-cooled filter. The filter cake is washed with ice-cold absolute alcohol and ether until the filtrate is free of HCl and Cl_2 . It is then dried on clay in a desiccator. Yield: about 35 g.

II. REACTION OF NH_4Cl WITH AN ELECTROCHEMICALLY PREPARED SOLUTION OF H_2PbCl_6

The electrochemical preparation of an H_2PbCl_6 solution is based upon the electrolysis of hydrochloric acid with a Pb cathode and two anodes. One anode is made of lead and dissolves, yielding Pb^{2+} ions. The other anode, which is not attacked, is made of carbon. Further oxidation of the ions to Pb^{4+} takes place at the carbon electrode.

A clay cup is placed in the center of a battery jar (see Fig. 240) and serves as the cathode compartment. A lead plate (7 cm. long, 3.5 cm. wide) with a strap for lead connection and for support is placed in the jar. The bottom of the jar is covered with a plate of Acheson graphite ($12.5 \times 7.5 = 94 \text{ cm}^2$), which serves as the unattacked anode. A carbon rod (1.5 cm. diameter) is screwed into one corner of the plate. This latter is surrounded by a somewhat larger glass tube, which extends from the base to above the surface of the liquid. Two corrugated Pb metal plates (each 27 cm. long and 5 cm. wide) are placed on either side of the clay cup to serve as dissolving anodes. The upper ends of these anodes are bent over the edge of the jar. All Pb electrodes are well cleaned with a wire brush prior to the run. The carbon rod and Pb anodes are connected in parallel. Since the current should be independently regulated in each anode loop, a rheostat and an ammeter should be included in each circuit. The anode compartment is filled with 1200 ml. of HCl with a density of 1.18, the cathode compartment with 225 ml. of HCl with a density of 1.10. Since the temperature of the anode electrolyte may not rise above 10°C during the experiment, the entire battery jar is cooled from the outside with ice water. Electrolysis proceeds at a potential of 12-14 volts and a current of 2 amp. in each of the two loops, so that the current density on the Pb anode is 0.005 amp./cm^2 , while that on the carbon electrode is 0.03 amp./cm^2 . The length of the run should be governed by the requirement of 20-25 ampere-hours per liter of anode fluid. The current efficiency, based on H_2PbCl_6 , is 70-80% under these conditions. If the electrolysis lasts too long, there is a marked decrease in efficiency since the H_2PbCl_6 becomes increasingly involved in the current passage, with consequent evolution of Cl_2 at the anode. Also, particles which separate from the badly corroded Pb anodes interfere with the electrolysis. The current

is shut off at the end of the run and the orange-yellow anolyte is poured into a beaker.

Precipitation of the solution of H_2PbCl_6 with an excess of 10% NH_4Cl solution and subsequent filtration and drying of the precipitate are carried out as in method I. Yield: about 65 g. of pure $(NH_4)_2PbCl_6$.

The $(NH_4)_2PbCl_6$ is used as a raw material for the preparation of $PbCl_4$.

SYNONYMS:

Ammonium lead (IV) chloride, ammonium plumbic chloride.

PROPERTIES:

Lemon-yellow, crystalline powder; stable in air. Becomes orange-yellow at 70 to 80°C; decomposes above 130°C into Cl_2 , NH_4Cl and $PbCl_2$.

Hydrolytically decomposed by water, separating PbO_2 ; soluble without change in 20% hydrochloric acid.

Crystals: J 1₁ structure type.

REFERENCES:

- I. H. Friedrich. *Monatsh. Chem.* 14, 505 (1893); *Ber. dtsh. chem. Ges.* 26, 1434 (1893); H. Hecht. *Präparative Anorganische Chemie*, Berlin, 1951, p. 151.
- II. K. Elbs and R. Nubling. *Z. Elektrochem.* 9, 776 (1903); E. Müller. *Electrochemisches Praktikum*, 7th Ed., Dresden and Leipzig, 1947, p. 225.

Potassium Hexachloroplumbate

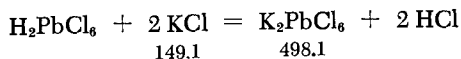
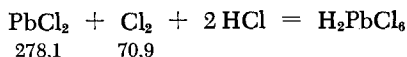

A solution of H_2PbCl_6 is prepared by introducing Cl_2 into a suspension of 30 g. of $PbCl_2$ in 600 ml. of concentrated hydrochloric acid at room temperature [see the procedure under $(NH_4)_2PbCl_6$]. When the solution becomes saturated with Cl_2 , it is decanted from the unreacted $PbCl_2$ and rapidly cooled with

ice. An ice-cold solution of 15 g. of KCl in 200 ml. of water is added to 500 ml. of the clear ice-cold H_2PbCl_6 solution, and a stream of pure HCl gas is introduced into the mixture, which is held at $0^\circ C$ (see also the description of the preparation of ammonium hexachlorotitanate in the section on Titanium). Separation of the lemon-yellow K_2PbCl_6 begins after a short time, and it is completed by further introduction of HCl until the solution is saturated at $0^\circ C$. As soon as the precipitation is complete, the finely crystallized salt is suction-filtered on fritted glass, washed with some cold concentrated hydrochloric acid and dried by pressing on a clay plate in air.

It is essential that the solution of H_2PbCl_6 be used immediately after its preparation. Otherwise some decomposition occurs and $PbCl_2$ is formed. In the presence of the latter an orange-brown, monoclinic product of unknown constitution precipitates out instead of the yellow, cubic salt.

SYNONYM:

Potassium lead (IV) chloride, potassium plumbic chloride.

PROPERTIES:

Lemon-yellow, crystalline powder, stable in air for several days; however, it gradually decomposes with fading of the yellow color (hydrolysis). Decomposes at higher temperatures, evolving Cl_2 .

Hydrolyzes in water, forming PbO_2 . Soluble without decomposition in 20% hydrochloric acid.

Crystal: J_1 structure type.

REFERENCES:

- H. L. Wells. *Z. anorg. allg. Chem.* **4**, 335 (1893).
 K. Elbs and R. Nübling. *Z. Elektrochem.* **9**, 776 (1903).
 A. Gutbier and M. Wissmüller. *J. prakt. Chem.* **90**, 491 (1914).
 G. Engel. *Z. Kristallogr.* **90**, 341 (1935).
 H. Leibiger. Thesis, Univ. of Freiburg in Breisgau, 1951.

Potassium Iodoplumbite

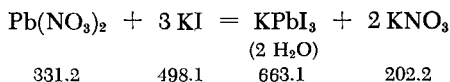
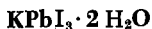

A solution of 4 g. of $Pb(NO_3)_2$ in 15 ml. of warm, distilled water is prepared and mixed with a warm solution of 15 g. of

KI in 15 ml. of distilled water. Good agitation is necessary. Yellow PbI_2 precipitates out, and on cooling gradually transforms to pale yellow $\text{KPbI}_3 \cdot 2 \text{H}_2\text{O}$. On renewed heating, the yellow color of PbI_2 reappears because of the strong secondary dissociation of the complex. The salt is suction-dried in a fritted glass filter and finally dried by pressing between pieces of filter paper or on a clay plate.

The anhydrous compound can be prepared from the dihydrate either by storing the latter for a period of time in a vacuum desiccator over concentrated sulfuric acid or by dissolving it in 15-20 ml. of acetone and then precipitating with a double volume of ether.

Anhydrous KPbI_3 is a sensitive moisture indicator since it produces the yellow PbI_2 rather than the hydrate. See the article by Biltz for particulars of detection of traces of H_2O in gases or organic solvents with either solid KPbI_3 or KPbI_3 dissolved in acetone.

SYNONYMS:

Potassium lead (II) iodide, potassium plumbous iodide.

PROPERTIES:

The dihydrate forms pale yellow, needle-shaped crystals, stable in air. On more rigorous drying in a desiccator, the water of crystallization is given off with the formation of whitish, powdery KPbI_3 , which immediately turns yellow in moist air (formation of PbI_2).

On heating, the water of hydration is given off between 30 and 97°C; this water may decompose the anhydrous salt. M.p. of $\text{KPbI}_3 = 349^\circ\text{C}$, with I_2 beginning to separate at that point. The dihydrate is partially decomposed by pure water, forming PbI_2 ; it is stable in aqueous solution only in the presence of a large excess of KI; quite soluble in acetone, yielding a bright-yellow solution.

REFERENCES:

- C. H. Herty. Amer. Chem. J. 14, 107 (1892).
W. Biltz. Ber. dtsh. chem. Ges. 40, 2182 (1907).

Lead (II,IV) Oxide



(Crystalline)

In contrast to the finely crystalline commercial Pb_3O_4 , which is usually obtained by high-temperature oxidation of PbO or PbCO_3 ,

with air, macroscopic crystals of Pb_3O_4 are prepared by precipitating a solution of potassium plumbite with a solution of potassium plumbate in a strongly alkaline medium:

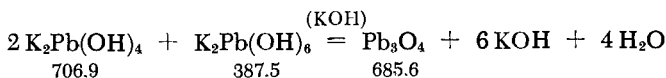

A 0.1 M $K_2Pb(OH)_6$ solution is prepared according to one of the two procedures given in the Hydroxy Salts section (Part III, Section 2) for the preparation of the compound. The alkali concentration is adjusted to about 9 N.

At the same time, twice that volume of 0.1 M $K_2Pb(OH)_4$ solution (≈ 9 N in alkali) is prepared by precipitating lead hydroxide with KOH from the appropriate quantity of lead acetate solution. The precipitate is suction-dried on a fritted glass filter, washed until the wash water gives a neutral reaction, and dissolved in strong KOH. All these steps must be performed in the cold to avoid decomposition (formation of PbO). The K salts are preferred to the Na salts because of their greater solubility. After filtration, the $K_2Pb(OH)_4$ and $K_2Pb(OH)_6$ solutions are thoroughly mixed in a 2 : 1 ratio and allowed to stand at room temperature until crystallization occurs. In order to increase the number of crystallization nuclei some glass wool should be placed in the vessel prior to the run. After some time, Pb_3O_4 settles out. The completion of settling requires several days. Part of the product collects on the bottom of the vessel as a fine, red crystalline powder; the other part settles on the walls and on the glass wool in the form of large, rod-shaped and shiny crystals. Following crystallization, most of the mother liquor is decanted and the precipitate is suction-dried on a fritted glass filter. The crystals are washed with absolute alcohol until the filtrate is no longer alkaline and are dried in a vacuum desiccator over KOH. The Pb_3O_4 is then analytically pure.

See Clark, Schieltz and Quirke for the preparation of still larger single crystals from PbO_2 and NaOH in the presence of H_2O , using a steel bomb at 355 to 375°C.

SYNONYMS:

Plumbous plumbate; trade name "red lead."

PROPERTIES:

Chemical behavior similar to that of the ordinary, finely crystallized material.

d 9.07. Tetragonal crystals, probable space group D_{2h}^7 .

REFERENCES:

- G. Grube. Z. Elektrochem. 28, 273 (1922).
 M. Straumanis. Z. phys. Chem. (B) 52, 127 (1942).
 G. L. Clark, N. C. Schieltz and T. T. Quirke. J. Amer. Chem. Soc. 59, 2305 (1937).

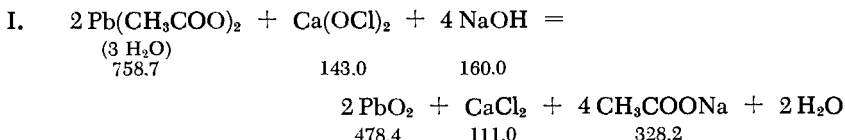
Lead (IV) Oxide

A solution of 20 g. of $\text{Pb}(\text{CH}_3\text{COO})_2 \cdot 3\text{H}_2\text{O}$ in 50 ml. of distilled water is prepared and mixed with a solution of 10 g. of NaOH in 90 ml. of water.

Good agitation is required. At the same time, a hypochlorite solution is prepared from 14 g. of technical grade $\text{Ca}(\text{OCl})_2$ (effective Cl content 70-80%) or from double this amount of technical grade bleaching powder. Either compound is dissolved in 200 ml. of distilled water. After filtering, 80 ml. of this solution is added slowly and with stirring to the alkaline Pb salt solution. The mixture is then heated and boiled for a few minutes. As soon as the brown precipitate of PbO_2 settles out, a few milliliters of the supernatant liquid are tested with a few drops of hypochlorite solution for the completion of oxidation. If further PbO_2 precipitates, an additional 10 ml. of hypochlorite solution is added. This procedure is repeated until no precipitate is observed.

The dark, fine crystals of PbO_2 are washed 5 or 6 times with water. Then the precipitate is stirred with 50 ml. of 3 N HNO_3 in order to remove any Ca or Pb salts or $\text{Pb}(\text{OH})_2$ which might have been formed. After washing several times with hot water, the precipitate is transferred to a Büchner funnel, thoroughly washed again, suction-filtered, and dried in a vacuum desiccator over P_2O_5 . Even after a long time in the desiccator the product still contains small amounts of water which can be removed completely only by heating for 1.5 hours in a stream of O_2 at 160°C . The PbO_2 is then analytically pure; the yield is about 85%.

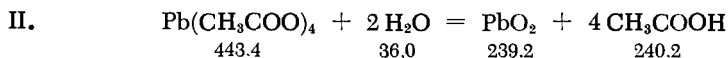

To prepare a particularly active compound for special oxidative reactions (e.g., organic reactions), the following procedure is used:

50 g. of $\text{Pb}(\text{CH}_3\text{COO})_4$ is carefully broken up and ground in a centrifuge tube with 460 ml. of water until all of the lead tetraacetate is hydrolyzed to PbO_2 . The suspension is then centrifuged for 10 minutes, and the sediment is stirred up again with 460 ml. of water and centrifuged. This process is repeated four times. The last supernatant should give a neutral reaction with litmus. Finally the PbO_2 is stirred with 50 ml. of water, suction-dried and washed with an additional 50 ml. of water. When the precipitate on a fritted glass filter is just barely moist, it is washed slowly four times with acetone, using 25 ml. each time, and thereafter four more times with absolute ether, again using 25-ml. portions. The PbO_2 acquires a bright, coffee-brown color at this point. It is immediately dried in a vacuum desiccator. Yield: 23 g. (92% of theoretical).

SYNONYM:

Lead dioxide, erroneously referred to as "lead superoxide" in the older literature.

PROPERTIES:

Formula weight 239.21. A dark brown, heavy, microcrystalline powder with strongly oxidizing properties. Decomposes on heating above 344°C , yielding O_2 and forming Pb_3O_4 and PbO ; d 8.9-9.2.

Insoluble in water; quite soluble in mineral acids, forming Pb (IV) salts; even more soluble in hot, concentrated alkalis, forming hexahydroxyplumbates.

Crystal structure, C 4 type.

REFERENCES:

- I. L. C. Newell and R. N. Maxson in H. S. Booth. *Inorganic Syntheses*, Vol. I, p. 45, New York-London, 1939; H. F. Walton. *Inorganic Preparations*, New York 1948, p. 141; J. Krustinsons. *Z. Elektrochem* **40**, 246 (1934).
- II. R. Kuhn and I. Hammer. *Chem. Ber.* **83**, 413 (1950).

Sodium Metaplumbate

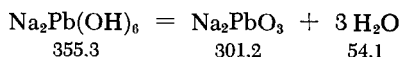

Pure $\text{Na}_2\text{Pb}(\text{OH})_6$ (see section on Hydroxy Salts for method of preparation) is heated over an open flame at 300°C in either a

round-bottom flask or a test tube, using an aspirator. A very good vacuum must be provided. Water is evolved and yellow Na_2PbO_3 is formed.

PROPERTIES:

Yellow powder; more stable in air than the hydroxy salt. Darkens on further heating and decomposes at 700°C with release of oxygen. Hydrolyzed by hot water, forming PbO_2 .

REFERENCES:

G. Grube. Z. Electrochem. 28, 273 (1922); see also A. Simon. Z. anorg. allg. Chem. 177, 109 (1929).

Sodium Orthoplumbate

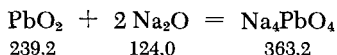

Preparation from PbO_2 and Na_2O is completely analogous to the method of producing Na_4SnO_4 from SnO_2 and Na_2O . The conditions described above (p. 739)—necessity of excluding CO_2 and water vapor, prior pulverization of the reaction mixture, reaction by heating under vacuum in a magnesia vessel—are exactly the same in the preparation of the Pb salt. A furnace temperature of 400°C suffices, however, since Pb compound forms more easily. The conversion is quantitative. At this temperature, the vaporization of Ag from the protective tube, which sometimes causes contamination of the Sn reaction, is precluded. Pure, anhydrous PbO_2 is required as the starting material.

PROPERTIES:

Bright yellow, crystalline solid; hygroscopic. Reacts vigorously with water, producing PbO_2 , probably with $\text{Na}_2\text{Pb}(\text{OH})_2$ as an intermediate.

REFERENCE:

E. Zintl and W. Morawietz. Z. anorg. allg. Chem. 236, 372 (1938).

Calcium Orthoplumbate

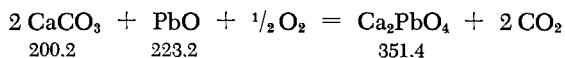

Equal weights of CaCO_3 and PbO are mixed well and heated in a combustion tube to medium red heat (about 800°C), being careful to exclude CO_2 . The temperature should not exceed 850°C , for otherwise the reaction will not be quantitative because of the high oxygen vapor pressure over the Ca_2PbO_4 . Cooled samples of the reaction mixture are periodically tested with dilute HNO_3 for the presence of carbonate ions. The filtrate from this test is treated with H_2S to detect Pb ion. Heating is continued as long as appreciable amounts of the starting materials remain; if necessary, the material should be broken up and remixed to form a homogeneous mixture. The reaction is complete when the carbonate test is negative and when treatment with H_2S produces at most a weak brownish tint in the filtrate. Completion of the reaction may be determined more reliably by repeated volumetric analysis of the reaction products. Pure Ca_2PbO_4 is an orange-red, spongy solid which may be removed easily from the tube and pulverized. A well-stoppered flask is required to protect the product from CO_2 in the air.

PROPERTIES:

Orange-red, microcrystalline powder which gradually turns brown and decomposes with the release of PbO_2 upon exposure to air containing CO_2 ; strong oxidizer. Liberates increasing quantities of O_2 at temperatures above 850°C ; for this reason, the salt was previously used to separate pure O_2 from the air since it could easily be regenerated by heating at lower temperatures. d 5.71.

Insoluble in water; any CO_2 dissolved in the water causes slow decomposition with release of CaCO_3 .

REFERENCES:

- K. Wedemeyer. Arch. Pharm. 230, 263 (1892).
G. Kassner. Arch. Pharm. 228, 109 (1890); 232, 375 (1894).

Lead Sulfide



(Crystalline)

While only amorphous or partially crystallized PbS precipitates when acid solutions of lead salts are treated with H_2S , the

treatment of hot sodium plumbite solution with thiourea results in the formation of crystals of PbS of nearly uniform size.

To a solution of 75 g. of $\text{Pb}(\text{CH}_3\text{COO})_2 \cdot 3\text{H}_2\text{O}$ in one liter of distilled water, just enough concentrated NaOH is added so that the $\text{Pb}(\text{OH})_2$ which forms is immediately redissolved as $\text{Na}_2\text{Pb}(\text{OH})_4$. At the same time a solution of 17 g. of C. P. thiourea, dissolved in one liter of distilled water, is prepared. After filtering, equal volumes of the two solutions are mixed and heated in a beaker with continuous stirring until the liquid boils. The liquid turns brown between 38 and 40°C; at about 50°C, a mirror of PbS is deposited on the walls and bottom of the beaker. If further heating causes bumping, it may be expedient to transfer the liquid to another vessel. Complete precipitation of the PbS requires continued boiling for 10 minutes. The heavy crystalline precipitate is then filtered, washed free of alkali with cold water, and dried in an oven. The yield is quantitative. The pure compound gives a sharp x-ray pattern; microscopic examination shows a well-formed crystal habit.

For the preparation of crystalline PbS by heating amorphous PbS at 1800°C in a nitrogen stream, see Weigel.

PROPERTIES:

Formula weight 239.27. Lead gray, crystalline powder with a metallic glint; chemically identical to the ordinary amorphous or partially crystallized compound. M.p. 1110°C, d 7.48.

Crystal structure, B 1 type.

REFERENCES:

- J. Emerson-Reynolds. J. Chem. Soc. (London) 45, 162 (1884).
 O. Weigel. Nachr. d. Gesellsch. d. Wiss. Göttingen, Math. Phys. Klasse 1906, 8 Dec.; Z. phys. Chem. 58, 293 (1907).

Lead (IV) Sulfate



Lead (IV) sulfate is produced at the anode upon electrolysis of approximately 80% sulfuric acid, using lead electrodes:

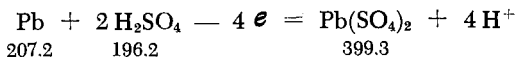

A large battery jar is used for the electrolysis. The cathode is suspended in a ceramic cup. The cathode consists of a coil of lead

tubing, the ends of which are bent over the edges of the battery jar and are fitted with tubing for the passage of cooling water. (Rubber tubing should not be exposed to the ozone-rich oxygen produced at the anode because it will soon deteriorate and begin to leak.) Two rolled lead anodes are suspended in the jar at equal distances from the ceramic cathode cell. The jar and the cathode cup are then filled with concentrated sulfuric acid (d 1.7 to 1.8). The electrolysis proceeds at a current density of 2 to 6 amp./dm.²; the temperature at the anode is prevented from rising above 30°C by continual cooling of the acid at the cathode. If the current density is too low, PbSO₄ is the primary product. Higher temperatures cause hydrolysis of the Pb(SO₄)₂ formed, and yield PbO₂. Should brown flakes of PbO₂ appear at the anodes, they should be withdrawn, washed with an acidified solution of NaNO₂, and rubbed dry with sand. If the electrolysis is carried out correctly, the solution near the anodes becomes turbid, and soon a white scum of crude Pb(SO₄)₂ deposits on the bottom of the jar. The pale green-yellow supernatant liquid is a solution of Pb(SO₄)₂ in sulfuric acid. It is advisable to start with a relatively large quantity of anode solution to compensate for evaporation occurring during the process; it should be remembered that the conductivity falls off in proportion to the amount of solution removed. With care, excessive resistance of the solution during the run may be reduced by dilution. To accomplish this, the solution is cooled as much as possible and then cold, dilute H₂SO₄ is slowly poured down the side of the battery jar. The electrolysis is continued for several hours in order to achieve optimum yield (about 60% based on current). It is advisable to let the temperature at the anode rise to 40-50°C during the last 60 minutes, since this produces better-formed Pb(SO₄)₂ crystals and increases the purity of the precipitate. To stop the reaction, the ceramic cup and the electrodes are removed from the jar, the salt deposit on the anode is scraped into the acid solution, and the nearly clear, pale green-yellow supernatant liquid is siphoned off into a flask fitted with a ground glass stopper. The Pb(SO₄)₂ gradually precipitates on cooling and forms a granular crust. The precipitate is collected on a glass frit by suction filtration; any residual sulfuric acid is to a large extent removed by repeated pressing on clay and leaving it in a desiccator until an apparently dry salt is obtained. It is impossible to remove all the residual sulfuric acid. This salt does not change on prolonged exposure to dry air. The purity of the product ranges from 85-99%. Another fraction of 60-85% purity can be obtained by drying the anode mud; this fraction is still contaminated by PbSO₄.

SYNONYMS:

Lead disulfate, plumbic sulfate.

PROPERTIES:

White to yellow-green crystalline powder; stable for long periods in dry air; indefinitely stable when stored away from light under concentrated H_2SO_4 ; strong oxidant. Hydrolyzes to form PbO_2 ; somewhat soluble in concentrated H_2SO_4 , giving a pale green-yellow solution.

REFERENCE:

K. Elbs and F. Fischer. *Z. Electrochem.* **7**, 343 (1900/01).

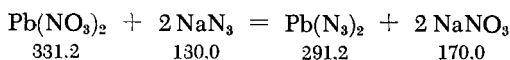
Lead Azide

A solution of $Pb(NO_3)_2$ is added to a solution of NaN_3 , with continuous stirring. Vigorous stirring is necessary to prevent the formation of large crystals, since these may detonate upon later grinding. The crystalline precipitate is collected by suction-filtration, washed with water and dried in a desiccator.

PROPERTIES:

White, finely crystalline powder. Readily soluble in water. Detonates on shock or impact.

Tetramethyllead

The easiest procedure, giving the best yields, is the Grignard reaction of $PbCl_2$ with a solution of CH_3MgCl :

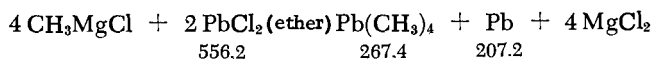
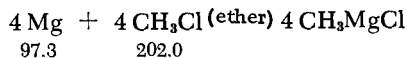

A solution of CH_3MgCl in absolute ether is prepared in a manner analogous to that of CH_3MgBr . (See preparation of tetramethyltin,

p. 744, for apparatus and procedure.) Because of the low boiling point of CH_3Cl (-23.7°C), the gas should be introduced only gradually so that the ether remains just at the boiling point; otherwise, appreciable losses of CH_3Cl are unavoidable. About 4-5 hours are required to completely dissolve 1 gram-atom of Mg. The solution is then refluxed for 30 minutes on a water bath, in the same manner as for the CH_3MgBr solution.

The rest of the procedure must be carried out under an efficient hood because the resulting $\text{Pb}(\text{CH}_3)_4$, like all alkylleads, is extremely toxic. A one-liter, three-neck flask is fitted with a high-efficiency condenser, a sealed stirrer and a straight filling adapter, which may be closed by a ground glass stopper. (The same apparatus may also be used for the preparation of the CH_3MgCl solution.) The condenser is connected to a CaCl_2 tube to eliminate atmospheric moisture. Ground glass and rubber connections must be carefully made since otherwise the yield will be considerably reduced as a result of the extreme volatility of the $\text{Pb}(\text{CH}_3)_4$ in ether. Small portions of finely powdered PbCl_2 (139 g. total) are gradually added to the flask containing the ether solution of CH_3MgCl ; agitation must be continuous and the flask must be cooled with water. The filling aperture is only momentarily unstopped. The mixture is then refluxed for 4-5 hours until the reaction is complete; after cooling, distilled water is added to the liquid, drop by drop, until the layers separate. The ether layer is siphoned off and, after drying over CaCl_2 for several hours, distilled in an efficient fractionating column. The solvent is distilled off at atmospheric pressure on an oil bath. A small flask is then filled with the residue and carefully fractionated in a column, using an oil bath for heating. Under no circumstances should an open flame be used since local overheating of the $\text{Pb}(\text{CH}_3)_4$ in contact with the hot glass may cause explosive decomposition. If the crude product contains appreciable amounts of trimethyllead, a dark lead mirror appears on the walls of the flask because of decomposition of that compound. The fraction coming over between 105 and 115°C is refractionated, yielding about 25 g. of pure $\text{Pb}(\text{CH}_3)_4$, b.p. 110°C (uncorr.) at 760 mm.

Tetramethyllead may be stored for years in a brown, glass-stoppered bottle. Sealing in ampoules should not be attempted under any circumstances because of the danger of explosion (see above).

The compound is the starting material for production of free methyl radicals.

PROPERTIES:

A clear, dense, strongly refractive liquid with a pleasantly sweet odor; extremely toxic; stable in air and water.

M.p. -27.5°C , b.p. 110°C . The vapor pressure at room temperature is exceptionally high so that, despite the high boiling point (over 100°C), rapid evaporation occurs, as in the case of benzene. Very volatile with ether. d (20°C) 1.995.

Insoluble in water and 96% alcohol; miscible in all proportions with absolute alcohol, ether and other common organic solvents.

REFERENCE:

- E. Krause and A. von Grosse. Die Chemie der metall-organischen Verbindungen [The Chemistry of Organometallic Compounds], Berlin, 1937, p. 389.

Tetraethyllead



The preparation is similar to that described for $\text{Pb}(\text{CH}_3)_4$ and is carried out by reacting PbCl_2 with an absolute ether solution of $\text{C}_2\text{H}_5\text{MgBr}$.

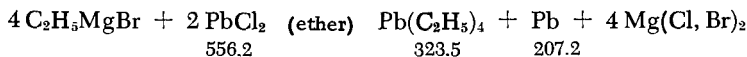
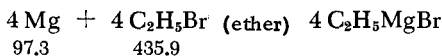

A side reaction results in the formation of considerable quantities of triethyllead. This is best disposed of by brominating the mixture [including the $\text{Pb}(\text{C}_2\text{H}_5)_4$] to form $(\text{C}_2\text{H}_5)_3\text{PbBr}$, which then reacts with the $\text{C}_2\text{H}_5\text{MgBr}$ solution, yielding pure $\text{Pb}(\text{C}_2\text{H}_5)_4$.

The $\text{C}_2\text{H}_5\text{MgBr}$ solution is prepared in a manner similar to that for CH_3MgBr solution (see p. 744). The principal difference is that, instead of gaseous CH_3Br , 136 g. of liquid $\text{C}_2\text{H}_5\text{Br}$ is added to 1 gram-atom of Mg by means of a dropping funnel. The mixture is then refluxed on a water bath for 30 minutes.

The procedure for the reaction of the Grignard solution with PbCl_2 is carried out as in the preparation of $\text{Pb}(\text{CH}_3)_4$ (see preceding preparation). The formation of undesirable triethyllead can be suppressed by adding the PbCl_2 at room temperature, by allowing the reaction mixture to stand for a longer time after the completion of the reaction, and by refluxing for several hours.

After the distilled water has been added and the ether layer separated, it is desirable to remove the $\text{Pb}(\text{CH}_3)_4$ by treating the crude ether solution of $\text{Pb}(\text{C}_2\text{H}_5)_4$ at -70°C with an ether solution of bromine until a persistent red-brown color appears. After

filtering out mechanically occluded impurities and drying over CaCl_2 , the solution is again reacted with an equal amount of $\text{C}_2\text{H}_5\text{MgBr}$. If this treatment is omitted, considerable decomposition occurs in the subsequent distillation step, resulting in the precipitation of free lead. The dry ether solution of $\text{Pb}(\text{C}_2\text{H}_5)_4$ is treated further, removing the solvent by distillation, using a column. The residue is then distilled twice under aspirator vacuum at 83°C (13.5 mm.). The yield is about 50% (based on PbCl_2).

Tetraethyllead is stable for long periods of time if stored in brown, glass-stoppered bottles. Direct exposure to sunlight results in gradual decomposition.

PROPERTIES:

Colorless, mobile liquid with a pleasant, sweet odor; highly refractive; stable in air and water; toxic.

B.p. (13 mm.) 82°C . Decomposes, releasing lead, on further heating at atmospheric pressure. d (20°C) 1.653.

Insoluble in water and 96% alcohol. Miscible in all proportions with absolute alcohol, ether and other common organic solvents.

REFERENCES:

- E. Krause and A. von Grosse. Die Chemie der metall-organischen Verbindungen [The Chemistry of Organometallic Compounds], Berlin, 1937, p. 389;
- G. Gruettner and E. Krause. Ber. dtsch. chem. Ges. 49, 1415 (1916); see also Y. Tanaka and T. Kuwata. Chem. Zent. 1928, I, 2593; Rochow, Hurd and Lewis. The Chemistry of Organometallic Compounds, New York, John Wiley and Sons, 1957, pp. 190-197.

Neutral and Basic Lead Carbonate



(Crystalline)

Prepared by precipitation with urea from an aqueous solution of a Pb salt, using pressure and high temperature.

A mixture of 37.9 g. of $\text{Pb}(\text{CH}_3\text{COO})_2 \cdot 3\text{H}_2\text{O}$ and 11.2 g. of PbO is dissolved in 300 ml. of hot distilled water acidified with acetic acid. After cooling, the solution is treated with 6.0 g. of urea, filtered and heated for 12 hours at 180°C in a thick-wall reaction tube. The resulting mixture of PbCO_3 and $2\text{PbCO}_3 \cdot \text{Pb}(\text{OH})_2$ is easily separated by elutriation. If the

starting solution is dilute, the formation of the basic compound is favored. Both products are visibly crystalline and show well-defined crystals under the microscope.

PROPERTIES:

Formula weight of PbCO_3 , 267.22; of $2\text{PbCO}_3 \cdot \text{Pb}(\text{OH})_2$, 775.66. Chemical properties are the same as for the corresponding ordinary (amorphous or microcrystalline) compounds.

PbCO_3 : d (25°C) 6.524. Crystals are GeO_2 structure type.

$2\text{PbCO}_3 \cdot \text{Pb}(\text{OH})_2$: d (25°C) 6.694. Hexagonal crystals.

REFERENCES:

- A. Lemke and W. Biltz. *Z. anorg. allg. Chem.* **220**, 312 (1934).
L. Bourgeois. *Bull. Soc. min.* **11**, 221 (1888).

Lead (IV) Acetate

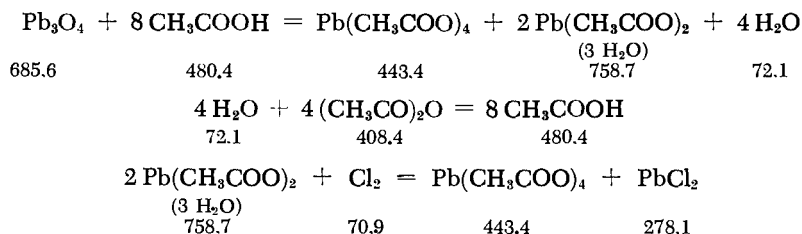

The reaction of Pb_3O_4 with CH_3COOH is carried out in a one-liter, three-neck flask fitted with a sealed stirrer and a thermometer; the third opening may be closed (not too tightly). The required amount of pure Pb_3O_4 is finely pulverized in advance, dried at 200°C and left in a desiccator over P_2O_5 until needed. The flask is charged with 550 ml. of glacial acetic acid and 170 ml. of pure acetic anhydride; the mixture is heated to 40°C , and then 300 g. of Pb_3O_4 is slowly added with vigorous stirring without further external heating. During this procedure, the loosely fitting stopper is removed, but only for brief periods. The reaction is exothermic and the rate at which the Pb_3O_4 is introduced is regulated so that the temperature in the flask remains under 65°C . Otherwise, the freshly formed lead tetraacetate is partially reduced by the acetic anhydride. Running water may also be used to prevent overheating of the flask. After most of the Pb_3O_4 has been added, the temperature gradually falls, and toward the end of the reaction it may be necessary to heat the flask (but never over 65°C).

The clear solution is left to cool protected from atmospheric moisture, and large quantities of colorless $\text{Pb}(\text{CH}_3\text{COO})_4$ precipitate out. The supernatant liquid is decanted, and the precipitate is poured into a large Büchner funnel. The funnel is covered with a cardboard square or a tile to minimize the effects of atmospheric moisture during the very slow suction-filtration. The filter cake is washed several times with glacial acetic acid and dried on a clay tile in a desiccator. The resulting product, usually tinted rose or brownish because of the presence of small amounts of PbO_2 , can be further purified by recrystallization from hot glacial acetic acid. Even after prolonged desiccation a small amount of glacial acetic acid will be retained by the salt. The yield is about 150 g.

Another, less pure quantity of the salt may be recovered from the mother liquor, which is treated in the original reaction flask with dry Cl_2 at 80°C until no further PbCl_2 precipitates. Good stirring must be used. The precipitate is filtered hot and washed with glacial acetic acid, and the solution is left to crystallize. During cooling, about 100 g. of $\text{Pb}(\text{CH}_3\text{COO})_4$ crystallizes out. However, it is contaminated with PbCl_2 . Pure lead tetraacetate can be obtained by repeated further recrystallization from glacial acetic acid.

The procedure may be varied by omitting the acetic anhydride (Dimroth and Schweizer). In this case, however, the maximum temperature must be held below 60°C since the water formed in the reaction is not bound and may hydrolyze the $\text{Pb}(\text{CH}_3\text{COO})_4$ at higher temperatures.

Lead (IV) acetate may be stored only if absolutely dry and when kept in well-closed ground glass bottles. It is used as a selective oxidant in organic syntheses.

SYNONYMS:

Lead tetraacetate, plumbic acetate.

PROPERTIES:

Colorless prismatic crystals, very sensitive to moisture. In the presence of moisture, decomposes hydrolytically to form brown PbO_2 . M.p. $175\text{--}180^\circ\text{C}$ (some decomposition); d (17°C) 2.23. Hydrolyzed by water, forming PbO_2 and acetic acid. Dissolves in hot acetic acid without decomposition; slightly soluble in dry CHCl_3 , CCl_4 and C_6H_6 .

REFERENCES:

H. F. Walton. *Inorganic Preparations*, New York 1948, p. 138.
J. C. Bailar, Jr. in H. S. Booth, *Inorg. Syntheses*, Vol. I, New

York—London 1939, p. 47; see also: O. Dimroth and R. Schweizer, Ber. dtsh. chem. Ges. 56, 1375 (1923).

Lead Thiocyanate

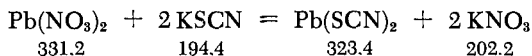

A solution of 150 g. of C. P. $\text{Pb}(\text{NO}_3)_2$ in 1.5 liters of distilled water is prepared and filtered; at room temperature a filtered solution of 90 g. of C.P. KSCN in 840 ml. of distilled water is added with stirring. If the compounds are not available in sufficient purity, they must first be purified by recrystallization, as the properties of $\text{Pb}(\text{SCN})_2$ are greatly affected by the presence of trace metals. After about half of the thiocyanate solution has been added, the solution becomes cloudy and a dense white precipitate of $\text{Pb}(\text{SCN})_2$ begins to separate. To complete the crystallization, the mixture is left to stand for some time in the refrigerator and then filtered cold through a Büchner funnel. The precipitate is washed with ice-cold water and dried in the dark on an unglazed clay dish over CaCl_2 . The yield is approximately 90 g. of analytically pure $\text{Pb}(\text{SCN})_2$. Lead thiocyanate is used as a starting material for the synthesis of $(\text{SCN})_2$.

PROPERTIES:

White, needlelike crystals, light sensitive; Decomposes with discoloration when heated beyond 190°C . d 3.82. Insoluble in cold water. Monoclinic crystals.

REFERENCES:

- Z. Karaoglanov and B. Sagortshev. Z. anorg. allg. Chem. 202, 62 (1931).
 W. H. Gardner and H. Weinberger in H. S. Booth. Inorg. Syntheses, Vol. I, New York—London 1939, p. 84.

Boron

H. J. BECHER

Boron

I. According to Moissan, very impure amorphous boron, containing about 80–90% B, is obtained by the reaction of B_2O_3 with magnesium. According to Kroll the optimum yields are obtained as follows: A fireclay crucible, approximately 20 cm. high and 16 cm. in diameter, is painted with a paste of ignited MgO and sintered $MgCl_2$ and dried in a low-temperature oven. A mixture of 110 g. of B_2O_3 , 115 g. of Mg shavings (the use of Mg powder frequently leads to explosive reactions) and 94 g. of powdered S is placed in the crucible. The reaction is started with an ignition pellet, after which it proceeds vigorously. After the mixture has cooled, it is extracted in water and then in dilute HCl for a week. The residue is treated several times by heating with HF and HCl, washed with water and dried in vacuum at $100^\circ C$. The yields are variable, with a maximum of 46%.

II. According to Kiessling, pure boron can be made by reducing BBr_3 with H_2 at $800^\circ C$. The reaction takes place in the apparatus shown in Fig. 238. The BBr_3 is prepared by the method of Meyer and Zappner from Br_2 and commercial boron (usually 70–80% pure) (cf. the method described on p. 782). Thus, 15 g. of B is pressed into pellets, and the quartz tube *b* is filled with them. The tube is heated to $700^\circ C$ and dry Br_2 is added in drops from dropping funnel *a*. The resulting BBr_3 will then collect in trap *c*, which is cooled with an ice-salt mixture. After about 30 minutes, 5–10 ml. of BBr_3 will have accumulated. The addition of Br_2 is stopped and excess Br_2 from *b* and *c* is flushed out with H_2 . The resulting BBr_3 should be colorless. The H_2 flow is then adjusted to 2–4 bubbles per second, the temperature of the quartz tube heater is raised to 750 – $800^\circ C$, and the BBr_3 in *c* allowed to evaporate in the H_2 stream at ambient temperature. As a result elemental B precipitates in *d*. Unreacted BBr_3 recondenses in *e*, which is cooled with ice-salt mixture. When no further BBr_3 is left in *c*, traps *e* and *c* are interchanged and the decomposition continued in *d*. When the BBr_3 is all reacted, more material is prepared by allowing fresh Br_2 to drop into quartz tube *b*. One charge of 15 g. of B will

be sufficient for preparation of 75 ml. of BBr_3 . Boron that has precipitated in *d* appears to catalyze further decomposition. Therefore, this tube should not be emptied too early. The resulting B is washed and dried with hot H_2O . According to Kiessling the composition is: 98.9% B, 0.04% Al, 0.1% Si and traces of O, H and Mg.

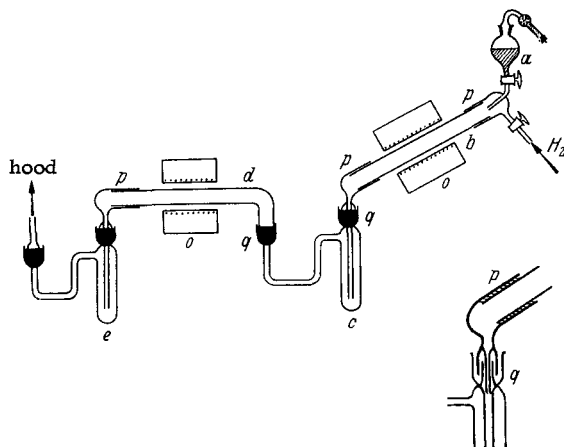

Fig. 238. Preparation of high purity boron. *a*—dropping funnel for Br_2 , protected against atmospheric moisture; *b*—quartz tube for B pellets (10 mm. in diameter and 700 mm. long); *c*—first condensation trap for BBr_3 , capacity about 25 ml.; *d*—quartz tube for re-reduction of BBr_3 ; *e*—second condensation trap for BBr_3 , capacity 25 ml.; *o*—tubular electrical heaters, about 600 mm. long; *p*—joints cemented with picein; *q*—mercury seals; their design is shown enlarged next to the principal figure; it illustrates the seal for the top of the condensation flask.

PROPERTIES:

Atomic weight 10.82. Gray-brown to yellow-brown powder. M.p. 2300°C ; d 2.3. Ignites in air at 700°C . Reacts violently with concentrated HNO_3 .

REFERENCES:

- I. H. Moissan. *Compt. Rend. Hébd. Séances Acad. Sci.* 114, 392 (1892); W. Kroll. *Z. anorg. allg. Chem.* 102, 1 (1918).
 - II. R. Kiessling. *Acta Chem. Scand.* 2, 707 (1948).
- For other procedures, cf. A. W. Laubengayer, D. T. Hurd, A. E. Newkirk and J. L. Hoard. *J. Amer. Chem. Soc.* 65, 1924 (1943).

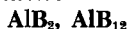
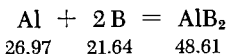
Aluminum Boride**AlB₂**

Finely powdered pure boron and aluminum are mixed in stoichiometric proportions and placed in a graphite tube closed with a graphite stopper. The stopper has a few fine grooves through which the inside of the tube can be degassed. The filled graphite tube is placed inside a quartz tube which has been well prerinsed with helium, and the quartz tube is evacuated. The tube is heated overnight at 800°C. The graphite tube will then contain a gray powder. The x-ray analysis indicates the presence of AlB₂, along with some graphite and B₄C impurities. These impurities are visible and may be mechanically removed.

PROPERTIES:

Dark-gray, finely crystalline material. Fairly resistant to dilute acids.

REFERENCES:

- E.F. Felton. J. Amer. Chem. Soc. 78, 5977 (1956).
 F. Lihl and P. Jenitschek. Z. Metallkunde 44, 414 (1953).

AlB₁₂

A mixture of 50 g. of B₂O₃, 75 g. of S and 100 g. of Al (all the reagents must be dry) is reacted in a fireclay crucible. After cooling, the melt is removed from the crucible and pulverized, and water is added. After elutriation of the slag, the reduced particles are sorted out from the residue, separated as far as possible from the slag, and treated with concentrated HCl until a brilliant black crystalline residue remains. The latter is treated with 40% HF in a Pt crucible, washed with water and left in HCl until gas evolution ceases. It is then filtered, washed and dried.

SYNONYM:

Tetragonal boron.

PROPERTIES:

Very hard, stable black crystals.

REFERENCES:

- H. Biltz. Ber. dtsh. chem. Ges. 41, 2643 (1908).
 H. Lihl and P. Jenitschek. Z. Metallkunde 44, 414 (1953).

For information on many other metal borides, cf. the section on Alloys and Intermetallic Compounds.

Diborane

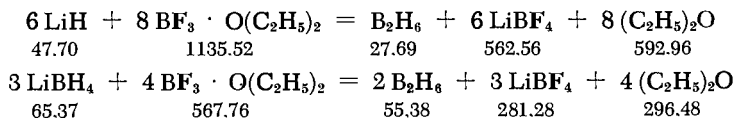

Diborane was first obtained from the mixture of boron hydrides resulting from the hydrolysis of magnesium boride; later it was produced by spark discharge in mixtures of BCl_3 or BBr_3 with H_2 [1, 2, 3]. It now can be produced more easily and in larger quantities by the reaction of LiH , NaH or alkali borohydrides with BF_3 diethyl etherate [4]. To obtain good yields, the alkali hydrides must be very finely powdered. Since alkali hydrides are hygroscopic and difficult to grind, the use of alkali borohydrides, which are fine powders to start with, has certain advantages for laboratory-scale synthesis. On the other hand, LiH is a particularly economical starting material for the production of larger quantities of B_2H_6 .

The procedure to follow can be applied regardless of whether an alkali hydride or alkali borohydride is used. The reaction vessel *a* (Fig. 239), which can have a capacity of 0.5 to 2 liters, depending on need, is used. The cold finger *b* acts as a reflux condenser. From *b*, the product B_2H_6 is passed through four successive cold traps f_1 to f_4 . Ground joints and stopcocks should be greased with silicone lubricant, but in quantitative work it is best to use mercury seals. The four traps are connected to a storage flask which in turn

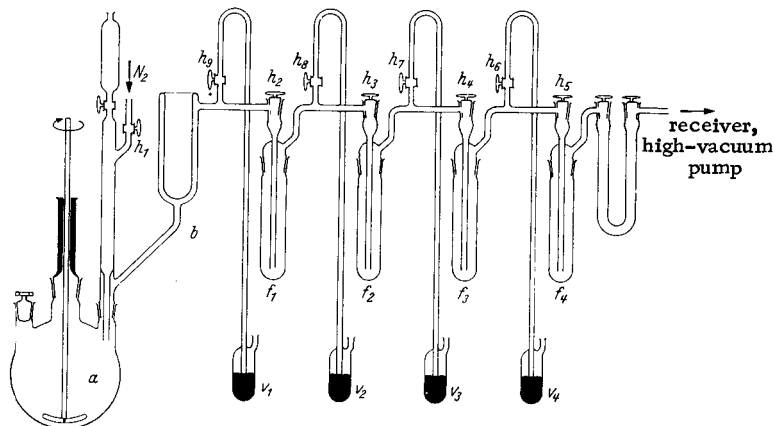

Fig. 239. Preparation of B_2H_6 .

a—reaction vessel; *b*—cold finger; f_1 to f_4 —traps; h_1 to h_5 —stopcocks; v_1 to v_4 —mercury-filled pressure release valves.

is connected to a high-vacuum pump. All the equipment must be thoroughly dried prior to the run. The finely divided hydride or borohydride is placed in the reaction vessel and suspended in some anhydrous ether, and the required quantity of BF_3 etherate is placed in the dropping funnel. Use double the stoichiometric quantity of BF_3 etherate. The entire apparatus is thoroughly flushed with dry, purified N_2 ; the cold finger b and trap f_1 are cooled to -78°C and traps f_2 and f_3 to the temperature of liquid N_2 . When all the equipment is properly flushed with N_2 , stopcocks h_1, h_6, h_7, h_8 and h_9 are closed and the BF_3 etherate is added slowly in drops to the hydride, using constant, vigorous stirring. At the same time the reaction vessel is heated to 60°C . When gas generation ends the B_2H_6 is flushed into the traps (using N_2), where it freezes out at -196°C . After the reaction, some ether and a trace of B_2H_6 will be found in f_1 . The product will be largely in f_2 , with a smaller amount in f_3 . Now stopcocks h_2 and h_3 are closed and the cooling bath under trap f_1 is replaced by a Dewar flask filled with liquid N_2 . This trap is used to collect the residues forming when B_2H_6 is purified by fractional condensation. To purify, traps f_2 to f_4 are evacuated and the B_2H_6 condensed in f_2 . Then trap f_3 is cooled to -100°C and trap f_4 to -196°C , and by slow heating the contents of f_2 are transferred into f_3 and f_4 . After a single fractionation, f_4 will contain pure diborane. The fractionation can be repeated with f_3 cooled to -140°C .

To prevent ignition on disassembly of the apparatus, the flask is flushed again with N_2 , which can escape via v_2 if stopcocks h_2 and h_3 are left open. Some methanol is added dropwise to the reaction flask and the contents of trap f_1 are allowed to thaw. The N_2 will then contain enough methanol vapor to render harmless all B_2H_6 residues in f_1 .

PROPERTIES:

Spontaneously igniting gas with strong, characteristic odor. M.p. -165.7°C , b.p. -92.5°C . Reacts quickly with water to form H_3BO_3 and H_2 .

REFERENCES:

1. A. Stock, E. Wiberg and H. Martin. Z. anorg. allg. Chem. 188, 32 (1930) and earlier reports of Stock et al.
2. H. I. Schlesinger and A. B. Burg. J. Amer. Chem. Soc. 53, 4321 (1931).
3. A. Stock and W. Sütterlin. Ber. dtsch. chem. Ges. 67, 407 (1934).
4. H. I. Schlesinger, H. C. Brown, J. R. Gilbreath and J. J. Katz. J. Amer. Chem. Soc. 75, 195 (1953).

Lithium Borohydride

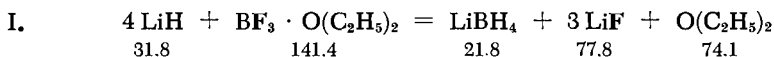

A steel autoclave, provided with a threaded, removable head, is filled with finely powdered LiH, and sufficient absolute ether is added to cover the LiH with a thick layer. Then about 2/3 of the stoichiometric amount of BF₃ ether is added. The autoclave is closed at once, since the reaction starts immediately. The reactants are heated at 120–130°C for several hours. After the autoclave has cooled, it is opened, and its contents are diluted with liberal amounts of ether and transferred to a flask. The ether solution is then decanted and the residual solvent distilled off. The LiBH₄ product is recrystallized from absolute ether, taking care to exclude moisture. The LiBH₄ crystallizes with one mole of ether of crystallization; this can be removed in vacuum at 33°C.

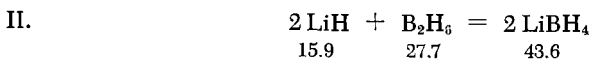

The apparatus shown in Fig. 240 is used. The required amount of B₂H₆ is condensed in trap *f*₁ at –196°C under an N₂ blanket. Then the trap is connected to the apparatus and the dry reaction vessel is filled with 10 g. of finely divided LiH and 400 ml. of absolute ether. Stopcock *h*₄ is opened to allow N₂ to enter. The latter can initially escape via *v*₂ and later, after the stopcocks at trap *f*₁ and *h*₂ have been opened, via *v*₁. The apparatus is thoroughly flushed with N₂; then *h*₄ and *h*₃ are closed. The Dewar flask *f*₁ is removed from trap *f*₁, and trap *f*₂ is then immersed in a Dewar flask at –196°C. As a result, B₂H₆ will slowly evaporate from *f*₁ to *f*₂. Any

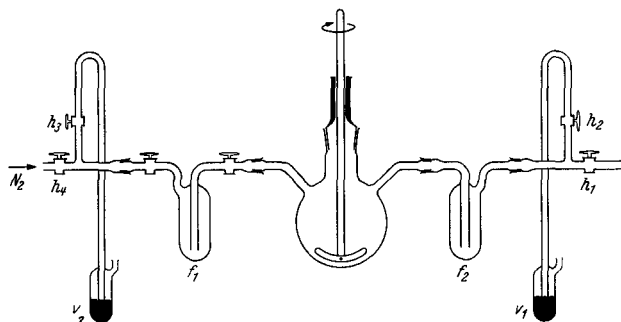

Fig. 240. Preparation of LiBH₄ from LiH and B₂H₆.

*f*₁, *f*₂ —traps; *h*₁ to *h*₄—stopcocks; *v*₁, *v*₂—pressure release valves.

entrained N_2 can escape via v_1 . The reaction vessel is well stirred while B_2H_6 passes through it. Any unreacted B_2H_6 will condense in f_2 . When f_1 is empty, the last traces of B_2H_6 are flushed out from f_1 into f_2 (use N_2). Close h_2 , open h_3 and, by placing the Dewar flask at f_1 and removing it from f_2 , allow B_2H_6 to evaporate in the opposite direction. If the LiH is sufficiently reactive, two such passes of B_2H_6 through the reaction vessel, i.e., once in each direction, will suffice. Nitrogen is allowed to enter via h_1 ; this will flush the remainder of the B_2H_6 into f_1 , where it will freeze out. The trap is then closed and the apparatus may be disassembled. The reaction vessel is rinsed with ether, the combined ether phase is decanted off, and the $LiBH_4$ is isolated by evaporating the solvent.

PROPERTIES:

Loose white powder. Hydrolyzes in the presence of atmospheric moisture. In the presence of H_2O , gives off H_2 in a violent reaction. Approximately 2.5 g. of $LiBH_4$ will dissolve in 100 ml. of ether at $19^\circ C$. Used as a reducing agent in the same manner as $LiAlH_4$.

REFERENCES:

- H. I. Schlesinger. and H. C. Brown. *J. Amer. Chem. Soc.* 62, 3429 (1940).
 G. Wittig and P. Hornberger. *Z. Naturforsch.* 6b, 225 (1951).
 H. I. Schlesinger, H. C. Brown, H. R. Hoekstra and L. R. Rapp. *J. Amer. Chem. Soc.* 75, 199 (1953).

Sodium Borohydride

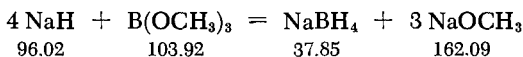

The reaction is carried out in a round-bottom, three-neck cylindrical flask. A mercury-seal Monel stirrer is placed in the central neck. The stirrer is equipped with five blades, arranged one over the other. The blade dimensions should be such that the stirrer can fit through the neck, but still fit the wall of the flask as closely as possible. A thermometer is placed in the second neck and a condenser on the third. The top of the condenser is equipped with a wye-tube adapter, one side of which connects to a dropping funnel and the other to a soda-lime drying tube. The flask is placed in an electric furnace, the top of which is covered with glass wool and an asbestos lid. The thermometer is removed, and the flask flushed with N_2 through this neck. Then 50 g. of NaH is rapidly added and 50 g. of $B(OCH_3)_3$ is placed in the dropping funnel. The stirrer and the furnace are then turned on. As soon as the thermometer indicates

a temperature of 200°C in the flask, the ether is added dropwise at a uniform rate. The addition should require 20–40 minutes, during which the temperature is kept at 230–270°C. The stirring is continued at this temperature for another hour. The flask is then allowed to cool and thoroughly dried isopropylamine or liquid NH₃ is used to extract the NaBH₄ from the now solid mixture, which, however, should have become well pulverized as a result of the constant stirring. The extraction with isopropylamine is carried out by refluxing for a few minutes; the extraction with NH₃ is done by stirring the reaction product for a few minutes. In either case the extract is filtered through a fritted glass filter and the solvent is evaporated. The NaBH₄ remains as a fine white powder, with a purity of 90–96%. The yield is 86–94%. The NaBH₄ is purified by recrystallization from either isopropylamine or water (it forms a dihydrate).

For unknown reasons the nature of the NaH used exerts a great influence on the yield and purity of the final product. Therefore, it is best to check the suitability of the starting material by making a small-scale preparation first. If the product is unsatisfactory, the NaH is preheated to 250°C and a small quantity of impure NaBH₄ from a preceding run is added to start the reaction. The yield can also be improved by a more uniform rate of addition of the B(OCH₃)₃.

PROPERTIES:

Fine, white crystals (cubic system). Decomposes slightly in neutral aqueous solutions, from which it can be partially recrystallized as a dihydrate. Rapidly hydrolyzes in acid solution. Stable up to 400°C.

REFERENCES:

- H. I. Schlesinger, H. C. Brown and A. E. Finholt. J. Amer. Chem. Soc. 77, 205 (1953).

Sodium Trimethoxyborohydride

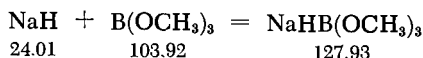

A one-liter, round-bottom flask equipped with a reflux condenser is well dried and flushed with N₂. Finely powdered NaH (43 g.) is added, followed by 230 g. of B(OCH₃)₃, slowly added from a dropping funnel on top of the condenser. The reaction, which begins at once, liberates a considerable amount of heat. After the addition of the ester, the contents are refluxed at 70°C for several hours. This causes a fivefold increase in the volume of the product, which

simultaneously becomes pure white. When the volume no longer increases, the reflux condenser is replaced by a downward condenser and the excess $B(OCH_3)_3$ is distilled off. The yield is nearly quantitative. It is best, however, to pretest the available NaH in a small experimental run and, if necessary, modify the reaction

PROPERTIES:

Loose white powder. Stable in dry air; hydrolyzes slowly in moist air. Decomposes when heated to $230^\circ C$. Rapidly reacts with B_2H_6 to form $NaBH_4$ and $B(OCH_3)_3$. Decomposed by alcohol, forming H_2 .

REFERENCE:

H. C. Brown, H. I. Schlesinger, I. Sheft and D. M. Ritter. J. Amer. Chem. Soc. 77, 192 (1953).

Borine Trimethylaminate

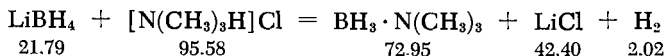

A 100-ml. three-neck flask, equipped with a stirrer, a reflux condenser and a dropping funnel, is used and 1.68 g. of $[N(CH_3)_3H]Cl$ is added to it. A solution consisting of 0.42 g. of $LiBH_4$ in diethyl ether is slowly introduced from the dropping funnel. If vigorously stirred, the reaction proceeds at room temperature. When the generation of H_2 diminishes, the contents are refluxed for another hour. All solvent is then distilled and the solid residue is transferred to a vacuum sublimation apparatus, where the $BH_3 \cdot N(CH_3)_3$ is sublimed in vacuum at $40^\circ C$ and collected in a cooled receiver. The yield is 85%.

PROPERTIES:

White hexagonal crystals. Stable. M.p. $94^\circ C$.

REFERENCES:

- G. W. Schaeffer and E. R. Anderson. J. Amer. Chem. Soc. 71, 2143 (1949).
 A. B. Burg and H. I. Schlesinger. J. Amer. Chem. Soc. 59, 780 (1937).

Borazole

Borazole was discovered when a mixture consisting of B_2H_6 and NH_3 (or the addition product $\text{B}_2\text{H}_6 \cdot \text{NH}_3$) was heated in a sealed tube [1, 2]. It can also be produced by pyrolysis of a mixture of LiBH_4 and NH_4Cl [3]. The best yield is obtained by reducing $(\text{ClBNH})_3$ (see below) with LiBH_4 in n-butyl ether. This reaction also yields B_2H_6 . For details see the literature [4].

SYNONYM:

s-Triazaborane.

REFERENCES:

1. A. Stock and E. Pohland. Ber. dtsh. chem. Ges. 59, 2215 (1926).
2. E. Wiberg and A. Bolz. Ber. dtsh. chem. Ges. 73, 209 (1940).
3. G. W. Schaeffer, R. Schaeffer and H. I. Schlesinger. J. Amer. Chem. Soc. 73, 1612 (1951).
4. R. Schaeffer, M. Steindler, L. Hohnstedt, H. S. Smith, Jr., L. B. Eddy and H. I. Schlesinger, J. Amer. Chem. Soc. 76, 3303 (1954).

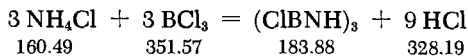
s-Trichloroborazole

A three-neck, two-liter flask equipped with a mercury-seal stirrer and a reflux condenser is used. A cold finger is inserted on top of the condenser and is cooled with a mixture of Dry Ice and acetone. A similar finger, cooled to -78°C , is inserted in the third neck. During the reaction, BCl_3 is introduced through this neck; the reagent condenses on the cold finger and thus is added to the flask dropwise. The flask is filled with a mixture of 50 g. of dry NH_4Cl and powdered glass with 400 ml. of chlorobenzene. The flask is then heated to $140\text{--}150^\circ\text{C}$, the inlet cold finger is connected to a trap with BCl_3 , and the latter is allowed to evaporate at such a rate that a drop of liquid BCl_3 enters the reaction mixture every three seconds. After about five hours the rate of the initially very vigorous generation of HCl drops off. The addition of BCl_3 is

interrupted and the excess BCl_3 still remaining in the flask is allowed to recondense on the inlet cold finger for another hour. The cooling is then stopped and the excess BCl_3 distilled off. The liquid phase is siphoned out from the flask and centrifuged for further clarification, if necessary. The chlorobenzene is distilled until solid $(\text{ClBNH})_3$ remains as a residue. The latter is purified by vacuum sublimation at $50\text{--}60^\circ\text{C}$. The yield is approximately 40%. If the recovered chlorobenzene is recycled back to the flask which still contains the solid residue and if fresh NH_4Cl is added, the yield can be increased appreciably by further reaction.

PROPERTIES:

Colorless crystals, exceedingly sensitive to moisture. M.p. 84°C ; d (25°C) 1.58. Soluble in benzene, CCl_4 and other organic solvents.

REFERENCES:

- Ch. A. Brown and A. W. Laubengayer. *J. Amer. Chem. Soc.* 77, 3699 (1955).
 R. Schaeffer, M. Steindler, L. Hohnstedt, H. S. Smith, Jr., L. B. Eddy and H. I. Schlesinger. *J. Amer. Chem. Soc.* 76, 3303 (1954).

For preparation and properties of some other borazole derivatives, see E. Wiberg, *Naturwiss.* 35, 182, 212 (1948); H. J. Becher and S. Frick, *Z. anorg. allg. Chem.* 295, 83 (1958).

Boron Trichloride

BCl_3

Fairly large quantities of BCl_3 can be produced by heating dilute borax with charcoal in a stream of Cl_2 at temperatures of 400 to 700°C . In the laboratory it is more convenient to produce it from BF_3 and AlCl_3 .

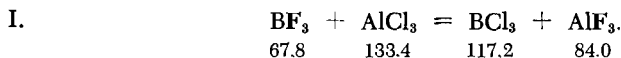

The reaction is carried out in the apparatus shown in Fig. 241. The lower flask has a capacity of one liter; the upper bulb, half that. Anhydrous AlCl_3 (67 g. = 0.5 mole) is placed in the lower flask. The inlet tube is connected to a BF_3 generator and the BF_3 flow adjusted in such a manner that 132 g. or two moles of BF_3 are added to the vessel over a period of 30 minutes. At the same time,

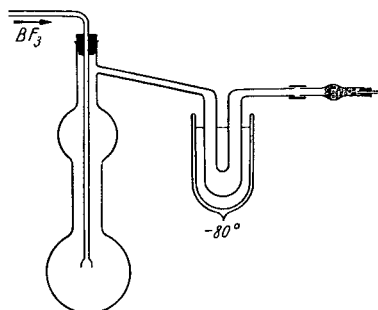
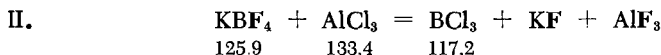

Fig. 241. Preparation of boron trichloride.

the lower flask is heated with an open flame. Later the bulb is also heated. The BCl_3 distills off while the AlF_3 peels off from the walls of the flask as a light powder. The BCl_3 is cooled in a U tube cooled to -80°C . Moisture is excluded by means of a drying tube. The impure product is shaken with some Hg and recondensed. The yield is 47 g.



An intimate mixture of 133.3 g. of AlCl_3 and 62 g. of KBF_4 is placed in the apparatus described above, which is then slowly heated in an oil bath to $150\text{--}170^\circ\text{C}$. Using the method described above, the BCl_3 that has been distilled off is trapped and purified. The yield is poorer than that produced by method I.

PROPERTIES:

M.p. -107°C , b.p. 12.5°C ; d (0°C) 1.434. Colorless liquid, fuming in moist air.

REFERENCES:

I and II: E. L. Gamble in: L. F. Audrieth, *Inorg. Syntheses*, Vol. III, New York-London, 1950, p. 27. Synthesis of BCl_3 from amorphous B and Cl_2 : L. Gattermann. *Ber. dtsch. chem. Ges.* 22, 195 (1889).

Boron Tribromide

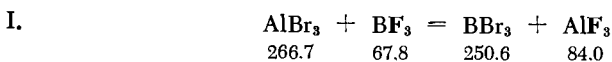

One half mole (133.4 g.) of AlBr_3 is distilled into the flask described for the preparation of BCl_3 ; BF_3 is added while heating

the flask. After some time the flask contents solidify. The heating and admission of BF_3 are continued. As a result, the BBr_3 product distills over into the -78°C trap. The distillate still contains some Br_2 which can then be removed by shaking with Hg. The BBr_3 must be distilled for further purification. The yield is 87.7 g. (70%).

An alternative is to heat a mixture of AlBr_3 and KBF_4 in the flask itself, but this results in a much lower yield of BBr_3 .



This procedure has been previously described in connection with the Kiessling method for preparing pure boron. If BBr_3 is desired, the apparatus shown in Fig. 238 is closed off by means of a drying tube inserted behind condensation trap *c*. Before the reaction the boron is thoroughly dried by prolonged heating at 600°C in a quartz tube flushed with a stream of H_2 . Then dropwise Br_2 addition is started, and the temperature of the reaction tube is raised to $700-750^\circ\text{C}$. The product BBr_3 is purified as in method I.

PROPERTIES:

M.p. -46°C , b.p. 90.8°C ; *d* (0°C) 2.65. Colorless, easily hydrolyzed liquid.

REFERENCES:

- I. E. L. Gamble in: L. F. Audrieth, *Inorg. Syntheses*, Vol. III, New York-London, 1950, p. 27.
- II. Fr. Meyer and R. Zappner. *Ber. dtsh. chem. Ges.* 54, 551 (1921); H. Menzel. Unpublished.

Boron Triiodide

BI_3

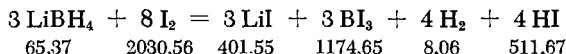

The apparatus shown in Fig. 242 is used and 170 g. of I_2 is added to flask *a*, while 5.1 g. of LiBH_4 is placed in addition bulb *b* under an N_2 blanket. The entire assembly is thoroughly flushed with N_2 by evacuating it several times through *v* and introducing

dry, oxygen-free N_2 through h . Then flask a is slowly heated on a bath until its inside temperature is between 120 and 125°C. The bulb b is turned in the joint so as to add small quantities of $LiBH_4$ to the flask. The reaction with I_2 is very vigorous. Trap f_1 is cooled to 0°C, trap f_2 to -78°C, and trap f_3 to -196°C. At the end of the reaction, the product in a is sublimed into trap f_1 , which is cooled to -78°C. Working under N_2 , trap f_1 is disconnected at d and g and closed with ground glass stoppers. Pure CS_2 is added

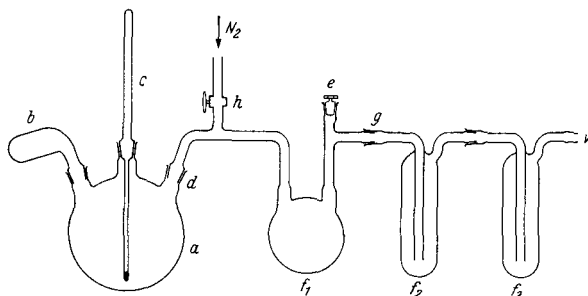

Fig. 242. Preparation of boron triiodide. a) reaction flask; b) addition bulb; c) thermometer; d , g , e , v) ground joints; f_1 to f_3) low-temperature traps; h) stopcock.

through e in order to dissolve the sublimate. Then Hg and Zn dust are added in order to reduce any entrapped I_2 . After it has become colorless, the solution is left to stand, and a small glass wool plug is placed in joint g , connected to a sublimation flask, which in turn is fused to a sublimation tube with three bulb enlargements. The CS_2 solution is carefully poured into the sublimation flask through the glass wool plug. The entire sublimation assembly is then evacuated (high vacuum), thus vaporizing the solvent. The sublimation flask is detached from the remainder of the apparatus and the impure BI_3 is slowly sublimed into the first bulb, then into the second, etc. The final product is pure white and crystalline. If the reaction is carried out in hexane in the presence of an excess of $LiBH_3$, it will go at room temperature.

PROPERTIES:

Colorless shiny crystals when completely pure. M.p. 49.9°C. Soluble in CS_2 . Unstable in air.

REFERENCES:

W. C. Schumb, E. L. Gamble and M. D. Banus. *J. Amer. Chem. Soc.* **71**, 3228 (1949).

E. G. Hofling, Thesis, Stuttgart, 1956.
T. Renner, *Angew. Chem.* 69, 478 (1957).

Boron Trifluoride Dihydrate

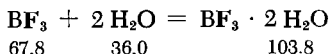
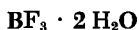

This compound is best prepared by adding the calculated amount of BF_3 to almost ice-cold water. The absorption is slow at first, but then proceeds more rapidly. The intermediate H_3BO_3 separates out, but goes back in solution as BF_3 is added. A clear, mobile liquid, with the composition $\text{BF}_3 \cdot 2\text{H}_2\text{O}$, is obtained. However, on fractional distillation under reduced pressure, partial decomposition occurs, with the formation of $\text{BF}_2\text{OH} \cdot \text{H}_2\text{O}$ and other products. If a small excess of one of the reagents is used in the preparation, pure $\text{BF}_3 \cdot 2\text{H}_2\text{O}$ can be separated out by partial freezing.

PROPERTIES:

M.p. $5.9-6.1^\circ\text{C}$. d (20°C) 1.6315. Crystallizes in rhombic form, is isomorphous with NH_4BF_4 and should probably be written as $\text{H}_3\text{O}[\text{BF}_3\text{OH}]$. The liquid does not attack glass and is stable at room temperature.

REFERENCES:

- H. Meerwein. *Ber. dtsch. chem. Ges.* 66, 411 (1933).
H. Meerwein and W. Pannwitz. *J. prakt. Chem.*, N. S. 141, 123 (1934).
L. J. Klinkenberg and J. A. A. Ketelaar. *Rec. Trav. Chim. Pays-Bas.* 54, 4, 959 (1935); J. S. McGrath. G. G. Stack and P. A. McCusker. *J. Amer. Chem. Soc.* 66, 1263 (1944).

Dihydroxyfluoroboric Acid

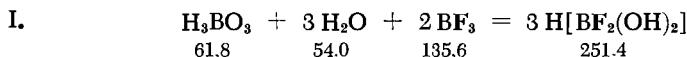
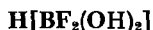

Two moles of BF_3 are stirred into a suspension of one mole of H_3BO_3 in three moles of H_2O . This results in a clear liquid which

distills at 85°C (25 mm.) and which is pure dihydroxyfluoroboric acid.

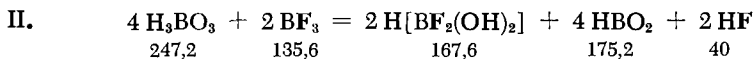

An excess of BF_3 is added to a Pyrex vessel containing some boric acid. The BF_3 is absorbed in an exothermic reaction, with the material in the vessel finally liquefying. The resulting dihydroxyfluoroboric acid can then be distilled off under atmospheric pressure.

This acid is also formed when BF_3 is produced from CaF_2 , B_2O_3 and concentrated H_2SO_4 , or from B_2O_3 and HF , and can be obtained at the end of BF_3 generation by fractional distillation of the residue in the generator.

PROPERTIES:

Colorless, syrupy liquid. B.p. 159-160°C (745 mm.) When the liquid is cooled to 0°C, the compound becomes very viscous, but no definite freezing point can be observed. Does not attack glass. Hydrolyzed by water either to HBO_2 or to H_3BO_3 .

REFERENCES:

- I. J. S. McGrath, G. G. Stack and P. A. McCusker. *J. Amer. Chem. Soc.* **66**, 1263 (1944).
- II. F. J. Sowa, J. W. Kroger and J. A. Nieuwland. *J. Amer. Chem. Soc.* **57**, 454 (1935); **59**, 965 (1937).

Boron Trifluoride Ammoniate

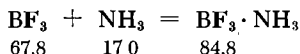

- I. A slow stream of NH_3 gas is led into a three-neck, one-liter flask. When the flask has been flushed, an equivalent amount of BF_3 is allowed to enter the flask through a second neck. An excess of BF_3 can be detected by formation of a white cloud at the flask outlet. The BF_3NH deposits in the flask as a white powder.
- II. A portion of BF_3 diethyl etherate is diluted with twice its quantity of ether. The solution is placed in a flask, and a uniform stream of NH_3 is introduced. The reaction must be conducted in the absence of air and with vigorous stirring. The product settles

as a fine precipitate. After the reaction is complete, the ether is decanted and the residual $\text{BF}_3 \cdot \text{NH}_3$ washed several times with fresh ether.

PROPERTIES:

White, crystalline material. M.p. 163°C . d (25°C) 1.864. Soluble in water. Hydrolyzes slowly in water at 0°C . Decomposes above 125°C .

REFERENCES:

- I. A. W. Laubengayer and G. F. Condikey. J. Amer. Chem. Soc. 70, 2274 (1948).
- II. Ch. A. Kraus and E. H. Brown. J. Amer. Chem. Soc. 51, 2690 (1929).

Boron Trifluoride Etherate

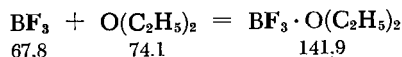

Two moles (135.6 g.) of BF_3 are generated as described on p. 219. It is then introduced into a dry one-liter flask containing 148 g. of diethyl ether. Alternately, the BF_3 may be frozen at liquid nitrogen temperature and added as a solid. The flask is cooled in ice-salt mixture and access of atmospheric moisture is prevented by closing off the flask with a CaCl_2 tube. The stream of BF_3 should not be too fast because some of it will not be taken up by the ether in that case. After the end of the reaction a condenser is connected to the flask and the $\text{BF}_3 \cdot \text{O}(\text{C}_2\text{H}_5)_2$ distilled off at 125°C into a receiver, preferably at reduced pressure. The etherate distills readily at 38°C (6 mm.).

PROPERTIES:

Colorless liquid. M.p. -60.4°C , b.p. $125-126^\circ\text{C}$; d (25°C) 1.125. n_D 1.348. Hydrolyzes quite readily. Used in organic reactions and for reactions with alkali hydrides.

REFERENCES:

- V. Gasselín. Ann. Chim Phys. [7] 3, 5 (1894).
- G. F. Hennion, H. D. Hinton and J. A. Nieuwland. J. Amer. Chem. Soc. 55, 2858 (1933);

- H. Meerwein and W. Pannwitz, *J. prakt. Chem.*, N. S. 141, 123 (1934).
 E. Wiberg and W. Mathing, *Ber. dtsch. chem. Ges.* 70, 690 (1937).
 A. W. Laubengayer and G. R. Finlay, *J. Amer. Chem. Soc.* 65, 884 (1943).
 H. C. Brown and R. M. Adams, *J. Amer. Chem. Soc.* 64, 2557 (1942).

Boron (III) Oxide



VITREOUS B_2O_3

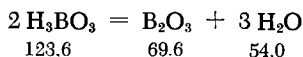

Recrystallized H_3BO_3 (several times from water) is placed in a Pt crucible and dried in vacuum over P_2O_5 , slowly raising the temperature to 200°C . This results in white, only slightly sintered B_2O_3 which is readily powdered.

PROPERTIES:

Amorphous, M.p. 294°C ; d 1.84. The glasslike pieces that are obtained by allowing molten B_2O_3 to solidify are brittle, very hard and hygroscopic.

REFERENCES:

- E. Tiede and A. Ragohs, *Ber. dtsch. chem. Ges.* 55, 594 (1922).
 E. Tiede and P. Wulff, *Ber. dtsch. chem. Ges.* 56, 656 (1923).

CRYSTALLINE B_2O_3

Fused boric acid is heated in a loosely stoppered Pyrex flask to $225\text{--}250^\circ\text{C}$; after this treatment the melt retains 8-15% water. Crystallization requires a few days. If a small amount of crystalline B_2O_3 seed is added to the melt, which contains some water, crystallization occurs very rapidly and the water separates out. Alternatively, fused boric acid is heated to 175°C , at which point crystalline HBO_2 (I) separates. The material is then transferred to a closed tube and the temperature is raised to about 236°C , i.e., just below the m.p. of HBO_2 (I). As a result the latter evolves water and transforms to crystalline B_2O_3 .

PROPERTIES:

M.p. 450°C; d 2.42-2.46. Hexagonal crystals.

REFERENCES:

L. McCulloch, J. Amer. Chem. Soc. 59, 2650 (1937).

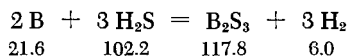
Boron (III) Sulfide

This compound is synthesized by the method of Sliwinski in the apparatus shown in Fig. 243. Before the reaction the apparatus is flushed with dry H_2 until free of explosive oxyhydrogen mixture. Amorphous boron is placed in a Vycor tube and heated to a dull red. A stream of dry, CO_2 -free H_2S is passed over the boron. Molten boron sulfide condenses close to the point where the heat has been applied (point *a*, Fig. 243). Upon cooling, the material becomes transparent. Further downstream, at *b*, porcelainlike sulfide forms, while crystalline B_2S_3 forms at *c*. The sublimation zone should not be cooled or the crystals will not be well formed. A steady stream of H_2S is maintained throughout the entire reaction and controlled to give a flow of approximately 3 liters/hour.

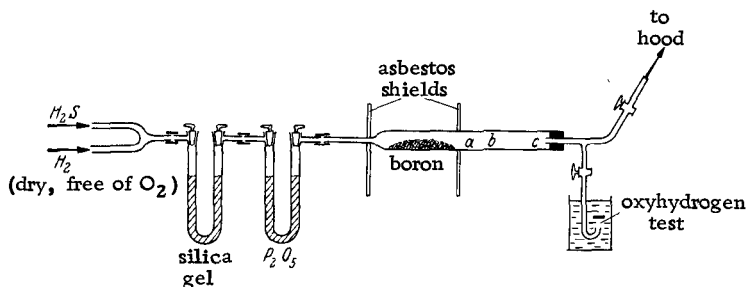

Fig. 243. Synthesis of boron (III) sulfide.

According to Hoffmann it is possible to substitute iron (III) boride for the elemental boron. The iron boride (finely divided powder) is placed in the tube, where it reacts with the H_2S . The reaction starts at 200°C; the optimum temperature lies between 300 and 400°C. The resulting B_2S_3 sublimes into the end of the tube where it forms bundles of fine, hairlike crystals. Vitreous and amorphous residues can be converted to the crystalline form by

cautious heating. The procedure is suitable for the production of relatively large amounts of B_2S_3 .

PROPERTIES:

Extremely readily hydrolyzed; decomposes even in moist air. The products of hydrolysis are H_3BO_3 and H_2S . The crystalline form consists of white, brilliant, needlelike crystals. Also occurs in an amorphous form. Becomes viscous on heating and begins to melt at $310^\circ C$.

REFERENCES:

- P. Sabatier. *Compt. Rend. Hébd. Séances Acad. Sci.* 112, 862 (1891).
 H. Moissan. *Compt. Rend. Hébd. Séances Acad. Sci.* 115, 205 (1892).
 S. Sliwinski. Thesis, Dresden, 1944.
 J. Hoffmann. *Z. anorg. allg. Chem.* 66, 362 (1910).

Boron Nitride

BN

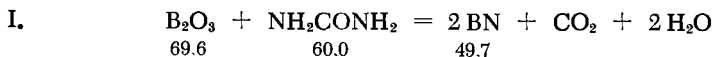

One part by weight of fused, finely divided B_2O_3 is intimately mixed with 1.5-2 parts by weight of urea and ignited in a covered procelain crucible until it becomes red hot. The resulting material is ground and washed with water to which a few drops of HCl have been added. It is then filtered; the resulting boron nitride is oven-dried. The yield is 34%, as B_2O_3 evaporates during ignition.

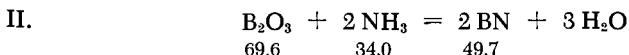

One part of finely divided H_3BO_3 is triturated with two parts of pure $Ca_3(PO_4)_2$ and the mixture is dehydrated in a Hessian crucible. This produces a porous mixture, which is then placed in a crucible covered with a lid through which a clay tube, touching the bottom of the crucible, is passed. The crucible is ignited in a gas-heated furnace. Simultaneously, NH_3 is bubbled slowly through the crucible via the clay tube. When the reaction is complete the cooled crucible contents are stirred with some water and transferred to a beaker; sufficient HCl to dissolve the phosphate is added and the mixture is brought to a boil. The BN residue is washed with acidified water (by decanting) until the wash water is free of both Ca^{2+} and PO_4^{3-} ions. The product is filtered, washed once again with water and dried, first on a clayplate and later in vacuum. The yield is 80-90%, based on B_2O_3 .

Boron nitride synthesized either via method I or method II still contains a few percent of B_2O_3 .

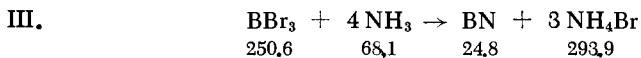

Boron tribromide is added dropwise to an excess of liquid NH_3 , while an H_2 stream is passed through the flask. The NH_3 is then evaporated; the moisture-sensitive white residue is transferred to a combustion tube and heated slowly to $750^\circ C$ is a stream of dry NH_3 . The yield of pure BN is theoretical.

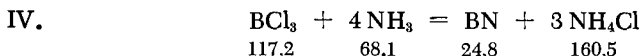

A gaseous mixture of H_2 and BCl_3 is combined with an excess of NH_3 in the front section of a quartz tube, heated to $600^\circ C$. In the middle section of this tube the mixture is then subjected to a temperature which rises from 500 to $1000^\circ C$. When decomposition is complete, heating in the stream of NH_3 is continued at $1000^\circ C$ for another hour. This procedure also yields pure BN.

PROPERTIES:

Light, white powder. Hydrolyzes slowly in boiling water. M.p. above $2800^\circ C$; d 2.34.

REFERENCES:

- I. M. Darmstadt. Liebigs Ann. Chem. 151, 256 (1869).
- II. L. Moser and W. Eidmann. Ber. dtsch. Chem. Ges. 35, 536 (1902).
- III. A. Stock and W. Holle. Ber. dtsch. chem. Ges. 41, 2095 (1908).
- IV. Fr. Meyer and R. Zappner. Ber. dtsch. chem. Ges. 54, 560 (1921).

Sodium Orthoborate



Sodium orthoborate is formed by the reaction of B_2O_3 with Na_2CO_3 at temperatures above $680^\circ C$.

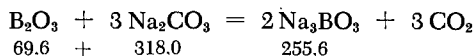

Do not heat above $950^\circ C$.

REFERENCE :

Carrière, H. Guiter and F. Thubert. Bull. Soc. Chim. France [5] 16, 796 (1949).

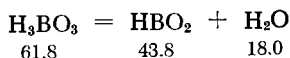
Metaboric Acid

Metaboric acid exists in three modifications:

Modification III occurs when H_3BO_3 is heated to 80-100°C for several days, either in an oven or in a dry air stream, until the calculated amount of water has been removed.

PROPERTIES:

Loose, white powder; rapidly crystallizes from solution. Rhombic crystals. M.p. 176°C.

Modification II can be obtained from modification III by heating the latter in a sealed ampoule at 130-140°C. Under these conditions the loose powder transforms to well-formed monoclinic crystals. The transformation requires several days. M.p. 201°C.

Modification I can be obtained from modification II by further heating the latter at 140°C in a sealed glass ampoule. The progress of the transformation can be followed by observing the structural change.

PROPERTIES:

Modification I is the most stable; crystallizes in the cubic system. Precipitates from water very slowly. M.p. 236°C.

REFERENCE :

F. C. Kracek, G. W. Morey and H. F. Merwin. Am. J. Sci. A35, 143 (1938).

Sodium Metaborate

The hydrates $\text{NaBO}_2 \cdot 4 \text{H}_2\text{O}$, $\text{NaBO}_2 \cdot 2 \text{H}_2\text{O}$ and $\text{NaBO}_2 \cdot \frac{1}{2} \text{H}_2\text{O}$, as well as the anhydrous NaBO_2 are present in the system NaBO_2 - H_2O . The tetra- and dihydrates crystallize from aqueous solution; the hemihydrate can be obtained by cautious decomposition of the dihydrate.

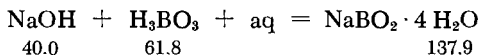
$\text{NaBO}_2 \cdot 4 \text{H}_2\text{O}$ 

Synthesis of this compound requires completely carbonate-free 50% sodium hydroxide. The hydroxide is prepared in accordance with the instructions in Part II, Section 2, Hydroxy Salts.

Carbonate-free 50% sodium hydroxide (50 g.) is placed in a ground glass flask with 69.6 g. of H_3BO_3 and diluted with 85 ml. of H_2O . When crystallization is complete, the slurry is filtered and the crystals are rinsed on the filter with a very small quantity of ice-cold water and dried on a clay plate. The well-formed crystals still contain small inclusions of the mother liquor.

PROPERTIES:

Triclinic crystals. d 1.743. Slightly soluble in water (0°C). The solution hydrolyzes very readily.

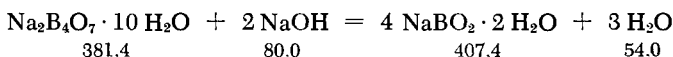
 $\text{NaBO}_2 \cdot 2 \text{H}_2\text{O}$ 

Carbonate-free 50% sodium hydroxide solution (cf. above) is added to $\text{Na}_2\text{B}_4\text{O}_7 \cdot 10 \text{H}_2\text{O}$ and 4 parts H_2O in a ratio of 42:21:8 by weight. The mixture is heated on a steam bath until the material dissolves, and the flask is then slowly cooled. At temperatures above 54°C the dihydrate crystallizes out in the form of needles and flat prisms. While they are still hot, the needles are dried as well as possible by suction filtering through fritted glass. Do not rinse with water, as this leads to the formation of the tetrahydrate. The crystals are first dried on clay plates and then in a vacuum desiccator over KOH.

The dihydrate can also be prepared from the tetrahydrate by isothermal decomposition, using suitable drying agents.

PROPERTIES:

Triclinic crystals. d (25°C) 1.905.

REFERENCES:

H. Menzel and H. Schulz. *Z. anorg. allg. Chem.* **251**, 167 (1943).
W. C. Blasdale and C. M. Slansky. *J. Amer. Chem. Soc.* **61**, 117 (1936).

ANHYDROUS NaBO_2

This can be prepared by stepwise degradation of the tetrahydrate in a vacuum desiccator to the hemihydrate. The latter is then completely dehydrated by heating to 200°C in vacuum over P_2O_5 . Another procedure consists in slowly heating an equimolar mixture of Na_2CO_3 and H_3BO_3 in a Pt dish with a final melting step. On cooling, the clear melt solidifies to a crystalline mass.

PROPERTIES:

Hexagonal crystals. M.p. 965°C ; d 2.34. Water soluble.

REFERENCES:

H. Menzel and H. Schulz. *Z. anorg. allg. Chem.* 251, 167 (1943).
S. S. Coole, S. R. Scholes and C. R. Amberg. *J. Amer. Ceram. Soc.* 18, 58 (1935).

Sodium TetraborateANHYDROUS NaBO_2

To prepare very pure, formula-weight borax as a primary standard, good quality commercial product is recrystallized three times from water and dried to constant weight in a vacuum desiccator over a desiccant with suitable vapor pressure. Recent studies have shown that the best desiccant consists of solid NaCl , sucrose and a saturated sucrose solution. The correct water content (47.21%) is achieved by drying a sample in a Pt crucible, first on a steam bath, then at 200°C , and finally between 700 – 800°C . To check for any further impurities, cf. I. M. Kolthoff, *Gravimetric Analysis*, II (pp. 97–98).

PROPERTIES:

Equivalent weight 190.27. Large, colorless, transparent crystals, which effloresce superficially when stored in dry air. Water is split off on heating; above 350°C , $\text{Na}_2\text{B}_4\text{O}_7$ is formed.

REFERENCES:

H. Menzel. *Z. anorg. allg. Chem.* 224, 10 (1935).

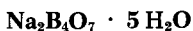

A borax solution, saturated at about 90°C , is concentrated by heating on a constant temperature bath at 65 – 70°C while a stream

of dry air passes over the material. The procedure takes several days; well-formed crystals of the pentahydrate precipitate out. These are filtered at 65°C through a heated suction filter and dried as well as possible between filter papers.

PROPERTIES:

Trigonal crystals. Also called jeweler's borax or, incorrectly, octahedral borax. At temperatures above 88°C at 10 mm. it converts to the dihydrate. d 1.81.

References:

H. Menzel. Z. anorg. allg. Chem. 224, 14 (1935).

$\text{Na}_2\text{B}_4\text{O}_7 \cdot 4\text{H}_2\text{O}$ (SYNTHETIC KERNITE)

A mixture consisting of equal weights of the pentahydrate and the decahydrate is heated in a tightly closed container (either a sealed ampoule or a stoppered flask) at 120°C for 24 hours. The synthetic kernite crystallizes from the partly molten system as well-formed crystals. To separate the latter, the sealed tube is turned over (in the bath), thereby draining the mother liquor from the crystals. The container is opened and the crystals scraped out and dried between filter papers.

The transformation also takes place at 100°C, but it then requires several days.

If the tube is agitated in the bath from the very beginning of the run, the resulting crystals are much smaller. These must then be separated on a suction filter at 100°C. It is not advisable to rinse the crystals with hot water.

PROPERTIES:

Monoclinic prismatic crystals; ready cleavage along the crystal grain. d 1.908.

REFERENCES:

H. Menzel and H. Schulz. Z. anorg. allg. Chem. 245, 157 (1941).

ANHYDROUS $\text{Na}_2\text{B}_4\text{O}_7$

Anhydrous $\text{Na}_2\text{B}_4\text{O}_7$ can be obtained by heating the hydrated salt to above 400°C. The mass swells during heating. The salt, which at first is amorphous, can be crystallized by prolonged heating at 600-650°C.

PROPERTIES:

Formula weight 201.27. d 2.36. On rapid cooling, the anhydrous tetraborate solidifies from a melt in the form of a hard glass. When the cooling is slow, three distinct modifications can be detected by x-ray analysis. Their occurrence depends on the conditions employed.

REFERENCE:

- I. M. Kolthoff. J. Amer. Chem. Soc. 48, 1447 (1926).
H. Menzel. Z. anorg. allg. Chem. 224, 19 (1935).

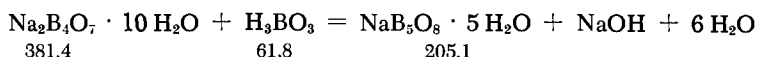
Sodium Pentaborate

A mixture of 34 g. of borax and 34 g. of H_3BO_3 is dissolved in 140 g. of water at 60–70°C, cooled with stirring to 25°C, and allowed to crystallize at that temperature. After decanting, the crystals are suction-dried, covered briefly with ice-cold water, and filtered again. The residue is left to stand for five hours with twice the quantity of absolute alcohol, filtered and rinsed with alcohol. The product is dried on clay plates.

PROPERTIES:

Crystallizes in the form of bevelled, blunt prisms. Solubility (0°C) 9.24 g./100 g. solution.

REFERENCES:

- W. C. Blasdale and C. M. Slansky. J. Amer. Chem. Soc. 61, 917 (1939).
H. Menzel. Z. anorg. allg. Chem. 164, 52 (1927).
A. Rosenheim and F. Leyser. Z. anorg. allg. Chem. 119, 24 (1921).

Sodium Perborate

According to Tanatar, pure sodium perborate can be obtained by allowing H_2O_2 to act on an alkaline solution of borax. Thus, 38.14 g. of borax and 8 g. of NaOH are dissolved in 265 g. of H_2O , and 45 g. of

Perhydrol is added. After some time, crystals of sodium perborate separate out. They are filtered and washed, first with cold H_2O , then with alcohol and ether.

PROPERTIES:

Formula weight 153.88. Crystallizes in large, transparent monoclinic prisms. Melts with decomposition. Solubility ($20^\circ C$) 1.17 g./100 g. H_2O . This compound can also be written as $NaBO_2 \cdot H_2O_2 \cdot 3 H_2O$.

REFERENCES:

- S. Tanatar. Z. phys. Chem. 26, 132 (1899).
 P. Melikoff and L. Pissarjewski. Ber. dtsh. chem. Ges. 31, 678 (1898); Z. anorg. allg. Chem. 18, 59 (1898).

Lindemann Glass

(Lithium Beryllium Borate)

An intimate mixture of 14.4 g. of Li_2CO_3 , 6.44 g. of $Be(OH)_2$ and 50 g. of H_3BO_3 (all finely powdered) is fused in a Pt crucible until no further CO_2 is evolved and the melt has become transparent. The melt is poured into a graphite crucible preheated to $600^\circ C$; the crucible is placed in an electric muffle furnace preheated to $600^\circ C$ and the furnace is allowed to cool to room temperature overnight.

PROPERTIES:

Very transparent to soft x rays. Used in x-ray windows and specimen tubes for powder x-ray work. The melting point is relatively low. Relatively sensitive to moisture and should be stored in a desiccator.

REFERENCES:

- A. Schleede. and M. Wellmann. Z. Kristallogr. (A) 83, 148 (1932).
 H. Menzel and S. Sliwinski. Z. anorg. allg. Chem. 249, 357 (1942).

Boron Phosphate

BPO_4

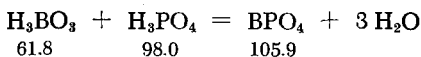

Stoichiometric quantities of pure H_3BO_3 and H_3PO_4 are mixed and heated to $80-100^\circ C$ or, alternatively, a solution containing

equivalent amounts of the two acids is evaporated on a water bath. The amorphous product is converted to crystals by heating for 2 hours at 1000°C. The corresponding quantity of $(\text{NH}_4)_3\text{PO}_4$ may be substituted for the phosphoric acid.

PROPERTIES:

Tetragonal crystals. Slightly soluble in water, not hygroscopic, insoluble in dilute acids, soluble in strong alkalis, stable at red heat.

REFERENCES:

- G. Meyer. Ber. dtsh. chem. Ges. 22, 2919 (1889).
 C. Aschmann. Chem. Ztg. 40, 960 (1917).
 E. Gruner. Z. anorg. allg. Chem. 219, 181 (1934).

Boron Arsenate

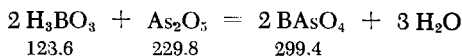

Like BPO_4 , boron arsenate is prepared by evaporation of a solution containing stoichiometric quantities of H_3BO_3 and As_2O_5 . The As_2O_5 must be tested for arsenic content before use.

PROPERTIES:

Structure identical to BPO_4 ; white, porous mass.

REFERENCES:

- E. Gruner. Z. anorg. allg. Chem. 219, 181 (1934).
 G. E. Schulze, Naturwiss. 21, 512 (1933).

Boron Methoxide

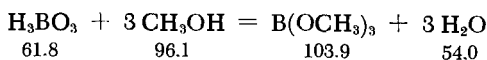
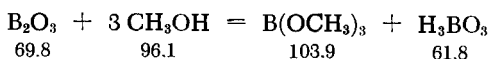

The formation of $\text{B}(\text{OCH}_3)_3$ from H_3BO_3 (or B_2O_3) and CH_3OH may be made to go nearly to completion by using an excess of

methanol and distilling the ester product as an azeotropic mixture (b.p. 54.6°C) with CH_3OH . A three-neck flask, fitted with a mercury-seal stirrer and a reflux condenser, is filled with four moles of CH_3OH . One mole of B_2O_3 is gradually added with stirring through the third neck, causing the solution to boil gently. The mixture is refluxed for one hour, after which the reflux condenser is replaced with a downward condenser and the azeotrope is distilled off together with a small excess of methanol, at a boiling temperature of 70°C. (Similarly, two moles of H_3BO_3 may be reacted with 16 moles of CH_3OH .) The product is isolated by adding to the distillate 12 g. of LiCl or 46 g. of ZnCl_2 for every 100 g. of azeotrope. The liquid separates into two layers, the upper consisting of 99.5% $\text{B}(\text{OCH}_3)_3$; the bottom layer contains the salt, the excess alcohol and a small quantity of ester. The alcohol may be recovered by distillation.

PROPERTIES:

Moisture-sensitive, colorless liquid. Flammable. B.p. 68.5°C.

REFERENCES:

H. I. Schlesinger, H. C. Brown, D. L. Mayerfield and J. R. Gilbreath. *J. Amer. Chem. Soc.* 75, 213 (1953); cites earlier references.

Trimethylboron



I. A Grignard solution is prepared from 72 g. of magnesium turnings covered with 250 ml. of absolute n-butyl ether and 285 g. of CH_3Br dissolved in 500 ml. of n-butylether. The reaction is carried out in a one-liter, three-neck flask equipped with reflux condenser, dropping funnel and mercury-seal stirrer. It requires about six hours for completion. Two traps with stopcocks are then attached through ground joints to the reflux condenser. The last trap is protected from the air by a mercury bubbler. The apparatus is flushed with dry, oxygen-free N_2 through a gas inlet tube on the dropping funnel, and a slow stream of the gas is allowed to bubble in throughout the subsequent reaction. The two traps are now immersed in -78°C baths and a solution of 61 g. of BF_3 in 400 ml. of n-butyl ether is added dropwise over 4 hours from the funnel. The mixture is then warmed to 70°C and maintained at this temperature for two hours more, allowing the product to condense in the cold traps. The yield of crude product is 44 g. The product is best purified by high-vacuum distillation from the -78°C trap into a receiver kept at -124°C .

II. Ethyl ether may be substituted for n-butyl ether in the preparation of the Grignard reagent; the BF_3 is then added in the form of its diethyl etherate or bubbled into the Grignard solution as a gas. The stream of BF_3 gas should not be too fast or it will entrain the $\text{B}(\text{CH}_3)_3$. In this procedure, a wash bottle containing about 5 ml. of concentrated H_2SO_4 is inserted between the condenser and the traps to absorb any ether present in the product gas. The product is not attacked by cold sulfuric acid.

The yield obtained by this method is somewhat lower than that from method I.

PROPERTIES:

Colorless gas, characteristic unpleasant odor. B.p. -20.2°C ; m.p. -161.5°C (Stock and Zeidler). Ignites and burns with a green flame on exposure to air. Not attacked by water at room temperature. At higher temperatures, reaction with water in a sealed tube yields methyl borates and methane. Absorption by aqueous KOH and NH_3 solutions is violent. Ammonia and its derivatives give addition products with trimethylboron.

REFERENCES:

- I. H. C. Brown. J. Amer. Chem. Soc. 67, 374 (1945).
- II. J. Goubeau and H. J. Becher. Z. anorg. allg. Chem. 268, 1 (1952).

Other methods: A. Stock and F. Zeidler, Ber. dtsch. chem. Ges. 54, 535 (1921); E. Wiberg and W. Ruschmann, Ber. dtsch. chem. Ges. 70, 1583 (1937); C. H. Bamford, D. L. Levi and D. M. Newitt, J. Chem. Soc. (London) 1946, 486.

Triethylboron



According to Brown, $\text{B}(\text{C}_2\text{H}_5)_3$ may be prepared analogously to $\text{B}(\text{CH}_3)_3$ by dropwise addition of an n-butyl ether solution of BF_3 to a solution of $\text{C}_2\text{H}_5\text{MgBr}$ in n-butyl ether. When the reaction is complete the product is distilled at 95°C under N_2 . In Meerwein's procedure, ethyl ether is used instead of n-butyl ether, but in this case the ether and triethylboron are first distilled off together and then separated by fractional distillation under a nitrogen blanket.

PROPERTIES:

Colorless liquid, spontaneously flammable. B.p. 95°C ; m.p. -92.5°C . d (23°C) 0.6931.

REFERENCES:

- H. Meerwein. *J. prakt. Chem.* 147, 240 (1937).
 H. C. Brown. *J. Amer. Chem. Soc.* 67, 374 (1945).

Other trialkylboron compounds may be synthesized by addition of BF_3 to the ether solutions of the respective alkyl magnesium bromides.

Trimethylboroxine

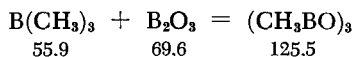

The compound is prepared by heating $\text{B}(\text{CH}_3)_3$ and B_2O_3 together in a sealed tube. The B_2O_3 powder is made by dehydrating H_3BO_3 under vacuum over P_2O_5 , at 220°C (see p. 787). The very hygroscopic oxide is placed with strict exclusion of moisture in a 200-ml. thick-wall Pyrex tube provided with a ground joint, and a melting-point capillary is fastened to the tube just below the joint. The tube is connected to a vacuum pump and immersed in liquid nitrogen, and when a high vacuum has been established, a quantity of $\text{B}(\text{CH}_3)_3$ equivalent to 4.25 g. (0.061 mole) of B_2O_3 is condensed in the tube. The tube is sealed off, heated to 600°C and kept at this temperature for six hours; in the process the contents turn into a clear, colorless liquid. When the tube has cooled down, the tip is broken under a nitrogen blanket and sealed to a tube leading to the vacuum pump. The tube is evacuated and the contents of the tube are transferred into a -78°C trap. The crude product is purified by removing volatile contaminants at -45°C and then distilling the product from a -10°C trap into a receiver held at -78°C .

PROPERTIES:

Colorless liquid. M.p. -38°C , b.p. 79.3°C . Combines with water, yielding $\text{CH}_3\text{B}(\text{OH})_2$. The B and O atoms form a symmetrical six-membered ring.

REFERENCES:

- J. Goubeau and H. Keller. *Z. anorg. allg. Chem.* 267, 1 (1951).
 A.B. Burg. *J. Amer. Chem. Soc.* 62, 2228 (1940).

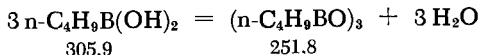
Tri-n-Butylboroxine

The higher homologs of methylboroxine cannot be prepared from B_2O_3 and the corresponding trialkylborons, because the latter decompose at elevated temperatures. Dehydration of the alkylboronic acids is preferable.

Thus, $n-C_4H_9B(OH)_2$ (cf. the following preparation) is heated to $120-140^\circ C$ in a round-bottom flask connected through a stopcock to a vacuum system. The stopcock is then opened for a short time, allowing most of the gas phase to be removed. The stopcock is closed and the dehydration equilibrium reestablished. By repeated opening and closing of the stopcock it is possible to achieve complete dehydration of the n-butylboronic acid, in accordance with the above equation. Some undecomposed acid is volatilized together with the water vapor.

PROPERTIES:

Colorless liquid. Sensitive to air and moisture. M.p. $259^\circ C$ (extrapolated).

REFERENCES:

H. C. Mattraw, Ch. E. Erickson and A. W. Laubengayer. J. Amer. Chem. Soc. 78, 4901 (1956); cites earlier references.

n-Butylboronic Acid

A large number of organoboronic acids have been synthesized by the following procedure, given here for n-butylboronic acid as an example.

A one-liter, three-neck flask is fitted with a mercury-seal stirrer, a low-temperature immersion thermometer and a 500-ml. dropping funnel. An inlet and an outlet for nitrogen are also provided, one at each side neck. The outlet tube terminates in a mercury valve which prevents air from entering the system. A branch line leads nitrogen to the top of the funnel, permitting the addition of the Grignard reagent to be made in an inert atmosphere. The entire apparatus is flushed with dry nitrogen for 20 minutes, and 55 g. of pure $B(OCH_3)_3$ and then 150 ml. of dry ether are added to the flask from the dropping funnel. A 300-ml. portion of a 1.66 N ether solution of n-butylmagnesium bromide is then placed in the funnel and the nitrogen atmosphere is immediately restored. The

reaction flask is now cooled to -75°C , using a large Dewar flask, and the Grignard solution is added dropwise and at a uniform rate over six hours. The temperature is maintained at -70°C during the addition and a continuous, slow stream of nitrogen is led through the flask. Stirring at -70°C is continued for four hours after the addition of reagent has been completed. The mixture is then allowed to stand overnight without further addition of Dry Ice to the low-temperature bath in order to slowly warm the flask contents to room temperature. The contents of the reaction flask then consist of a solid precipitate and a clear supernatant. The dropping funnel is removed and the precipitate carefully broken up with a glass rod. The funnel is replaced and a solution of 30 ml. of concentrated H_2SO_4 in 300 ml. of H_2O is added in drops with stirring. The upper (ether) layer is separated, the aqueous phase is extracted with 50 ml. of ether, and the combined ether fractions are evaporated on a water bath. Toward the end of the evaporation, 20 ml. of water is added and the mixture is again heated on the bath, until no further evaporation occurs on cooling. Crystalline *n*-butylboronic acid separates and is suction filtered. Purification is by drying over 65% H_2SO_4 in a desiccator filled with nitrogen, followed by recrystallization from warm toluene. The pure, dry acid is much more air sensitive than the moist, crude product and must be stored under nitrogen.

PROPERTIES:

Colorless, thin monoclinic flakes. The dry compound undergoes autoxidation. Heating causes reversible dehydration; for this reason the compound does not melt sharply. Alkylboronic acids are extremely weak and cannot be titrated with NaOH even when mannitol is added.

REFERENCES:

- H. R. Snyder, J. A. Kuck and J. R. Johnson. *J. Amer. Chem. Soc.* 60, 105 (1938); cites earlier references.
 H. C. Mattraw, Ch. E. Erickson and A. W. Laubengayer. *J. Amer. Chem. Soc.* 78, 4901 (1956).

***n*-Butylboron Difluoride**

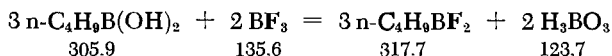

One half mole of crude, still moist *n*-butylboronic acid (cf. preceding preparation) is placed in a 200-ml. flask fitted with a distilling head, a downward condenser and a receiver deeply immersed in a -78°C cooling bath. The receiver is connected to a trap maintained

at the same temperature. A wash bottle with concentrated H_2SO_4 serves to keep the apparatus moisture free. A gas inlet tube leading from a BF_3 generator is inserted through the distilling head so that it reaches to the bottom of the flask. This tube is provided with a pressure release valve filled with mercury or concentrated H_2SO_4 (as shown in Fig. 24). A vigorous stream of BF_3 gas is bubbled through the $n\text{-C}_4\text{H}_9\text{B}(\text{OH})_2$, causing a temperature rise and resulting in liquefaction of the solid. The reaction is prevented from becoming too vigorous by adjustment of the gas flow. When the gas absorption has ceased, heat is applied to the flask and the n -butylboron difluoride still remaining in the mixture distills into the cold receiving flask or into the trap. Finally the contents of the receiver and the trap are combined and fractionated under nitrogen.

Instead of $n\text{-C}_4\text{H}_9\text{B}(\text{OH})_2$, $(n\text{-C}_4\text{H}_9\text{BO})_3$ may be treated with BF_3 , in which case B_2O_3 is produced along with the $n\text{-C}_4\text{H}_9\text{BF}_2$. The procedure described is general and may be used for the preparation of all alkylboron difluorides. Substitution of BCl_3 for BF_3 yields the alkylboron dichlorides.

PROPERTIES:

Colorless liquid. B.p. 36.4°C (742 mm.); d (25°C) 0.851. Not spontaneously flammable, but moisture sensitive.

REFERENCE:

P. A. McCusker and L. J. Glunz. *J. Amer. Chem. Soc.* **77**, 4253 (1955).

Sodium Tetraphenylborate



A mixture of 12.8 g. of magnesium and 80 g. of $\text{C}_6\text{H}_5\text{Br}$ is reacted in 200 ml. of absolute ether to form a Grignard solution which is filtered (except for the last 5 ml., which is kept for later use) into a three-neck flask equipped with a reflux condenser, a dropping funnel and a stirrer. A solution of 13.2 g. of BF_3 etherate in 50 ml. of ether is then added in drops with vigorous stirring. Before the addition of etherate is complete, the presence of excess Grignard reagent in the solution is verified by the Gilman test (see below). If no reagent is detected, the Grignard solution previously set aside is added drop by drop until the test is positive. An oily layer, which finally solidifies to a yellow cake, separates during the reaction. The ether is removed from the mixture by vacuum distillation at 100°C . The solid residue is suspended in 500 ml. of water, evolving a considerable amount of heat. An approximately equivalent amount of sodium carbonate solution is added to precipitate the magnesium salt and facilitate the subsequent suction

filtration. The filtrate is saturated with NaCl, and the Na $[B(C_6H_5)_4]$ separates as a white precipitate, which is filtered with suction and washed with half-saturated NaCl solution. The solid product is dried in vacuum over $CaCl_2$, ground to a fine powder, and dried again. Further purification is achieved by extracting the tetraphenylborate with anhydrous acetone, concentrating the extract until the solid just begins to separate, adding 100 ml. of chloroform, and distilling until the condensate is pure chloroform. The distillation is then stopped and the precipitate is filtered while still warm and washed with some chloroform. Halogen-free product is thus obtained with a total yield of 60%, based on the BF_3 etherate used.

Gilman test: 0.5-1 ml. of the test solution is reacted at room temperature with an equal volume of a 1% solution of Michler's ketone (di-p-dimethylaminophenyl ketone) in dry benzene. After a few minutes, 1 ml. of water is carefully added with shaking. The resulting solution, which may have to be filtered, is tested with a few drops of a 0.2% solution of iodine in acetic acid. A characteristic greenish-blue color appears in the presence of Grignard reagent. [H. Gilman and G. Schulze, *J. Amer. Chem. Soc.* 47, 2002 (1925).]

PROPERTIES:

White, finely crystalline, very stable compound. Analytical reagent for K^+ .

REFERENCE:

G. Witting and P. Raff. *Liebigs Ann. Chem.* 573, 195 (1950).

Aluminum

H. J. BECHER

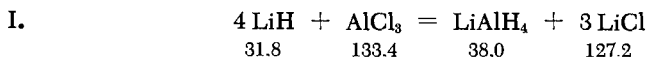
Lithium Aluminum Hydride

For the reaction between LiH and AlCl₃ to occur to a noticeable extent, the thick, hard lumps of lithium hydride must be ground to a very fine powder and then sieved. This treatment is performed under nitrogen. A very reactive ether suspension of LiH is obtained if the material is wet-ground with anhydrous ether in a special ball mill (K. Ziegler et al.) and used immediately.

A fresh suspension of 23.5 g. (2.96 moles) of LiH in 200 ml. of ether is introduced (with exclusion of moisture) into a three-neck flask provided with a dropping funnel, a reflux condenser and a stirrer. A solution of 71.2 g. (0.534 mole) of AlCl₃ in 300 ml. of ether is then added in drops with vigorous stirring. The reaction starts immediately, as shown by the boiling of the ether. The rate is kept uniform by adjustment of the addition rate. When all the AlCl₃ solution has been added, stirring is continued until the reaction has subsided, and the mixture is left to stand for some time. The contents of the flask are then filtered, using nitrogen pressure, through a fritted glass filter, and the clear filtrate is concentrated at atmospheric pressure until it has a syrupy consistency. The residual ether may be evaporated in vacuum at 70°C. The yield of LiAlH₄, based on AlCl₃, is about 85%.

Insufficient grinding of the LiH may prevent the reaction from starting spontaneously, or from going to completion, and lead to sudden, explosive bursts of renewed activity; in such cases the reaction is started by adding 200 ml. of ether, followed by a solution of 3 g. of LiAlH₄ in 30 ml. of ether, to the finely divided LiH. The subsequent procedure is the same as described above. According to Wiberg, a slight quantity of iodine may be used as an initiator instead of the LiAlH₄.

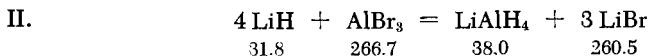

According to Wiberg, the difficulties involved in the preparation of sufficiently reactive LiH are not encountered if AlBr_3 is used instead of AlCl_3 . In this case, coarse LiH can be used:

An ether solution of AlBr_3 is prepared by adding small portions of the material (total 267 g. = 1 mole) to 750 ml. of extremely pure, dry ether in a flask cooled with ice-salt mixture. A 33-g. portion (4.1 moles) of coarsely ground LiH is placed in a three-neck flask with a reflux condenser, a stirrer and a dropping funnel. The hydride is covered with 250 ml. of ether, and the AlBr_3 solution is allowed to run in; the addition takes one to two hours. The stirred mixture is then heated to the boiling point of ether and kept at this temperature for a few hours. The LiBr and unreacted LiH precipitate on cooling. The solution is rapidly decanted through a layer of glass wool in a funnel. The filtrate obtained consists of an ether solution of LiAlH_4 saturated with LiBr. The solution may be stabilized by storing it over a small quantity of LiH.

PROPERTIES:

Colorless solid, stable in dry air at room temperature. The ether solution is used in inorganic and organic chemistry as a reducing and hydrogenating agent.

REFERENCES:

- A. E. Finholt, A. C. Bond and H. I. Schlesinger, *J. Amer. Chem. Soc.* **69**, 1200 (1947).
 J. Mahe, J. Rollet and A. Willemart, *Bull. Soc. Chim. France, Mém. (5)*, **16**, 481 (1949).
 K. Ziegler, H. G. Gellert, H. Martin and K. Nagel, *Liebigs Ann. Chem.* **589**, 91 (1954).
 E. Wiberg, R. Bauer, M. Schmidt and R. Usón, *Z. Naturforsch.* **6 b**, 393 (1951).
 E. Wiberg and M. Schmidt, *Z. Naturforsch.* **7 b**, 59 (1952).

Calcium Aluminum Hydride

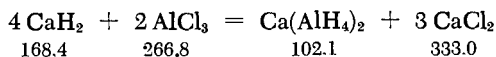

A freshly prepared solution of AlCl_3 in tetrahydrofuran is added to a suspension of finely ground calcium hydride in the same

solvent. A 30% excess of CaH_2 should be used. The mixture is refluxed under nitrogen for several hours in a flask provided with a stirrer and a reflux condenser. When the solution has cooled, it is rapidly suction filtered and the solvent is slowly distilled from the filtrate under nitrogen. The solid residue evolves further tetrahydrofuran when heated to 80–90°C in aspirator vacuum. The nearly colorless residue from this treatment still contains about 50–60% tetrahydrofuran, in addition to the $\text{Ca}(\text{AlH}_4)_2$. The hydride content can be raised to 60% by treatment in high vacuum.

Before the CaH_2 can be used in the reaction, it should be ground for 8–24 hours in a porcelain ball mill. The grinding and subsequent preparation of the tetrahydrofuran suspension are done in the absence of moisture; this ensures sufficient reactivity of the hydride. Before heating the reaction mixture it is recommended that a few crystals of iodine or, better still, a small quantity of a previously prepared tetrahydrofuran solution of $\text{Ca}(\text{AlH}_4)_2$ be added. The AlCl_3 should be sublimed before use. At worst, it may be only slightly yellow.

PROPERTIES:

The tetrahydrofuran solution of $\text{Ca}(\text{AlH}_4)_2$ is rapidly decomposed by moisture. Even on storage in a closed vessel, considerable decomposition occurs after some weeks.

REFERENCE:

W. Schwab and K. Wintersberger, *Z. Naturforsch.* **8 b**, 690 (1953).

Polymeric Aluminum Hydride

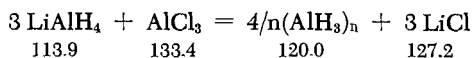
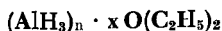

A solution of 1.137 g. of LiAlH_4 in 30 ml. of ether is placed in a small three-neck flask fitted with a nitrogen inlet tube, a reflux condenser and a dropping funnel. The apparatus is thoroughly flushed with dry nitrogen, and a solution of 1.33 g. of AlCl_3 in 20 ml. of ether is dropped in. The ensuing reaction is vigorous, but falls off rapidly. A filter tube with a sealed-in fritted disk is substituted for the funnel, and the solution is filtered out of the flask. The ether is partly evaporated from the filtrate by slowly raising the temperature to 90°C in high vacuum. The white residue has the composition $(\text{AlH}_3)_n \cdot x \text{O}(\text{C}_2\text{H}_5)_2$, the ratio of AlH_3 to ether

depending on the duration and temperature of evaporation; it ranges from 2.8 : 1 to 4.8 : 1. The product cannot be obtained entirely free of ether, since hydrogen slowly splits off at temperatures exceeding 90°C.

Immediately after completion of the reaction, the solute consists of monomeric AlH_3 . After a short while, however, a polymer with a high ether content begins to separate.

REFERENCES:

- A. E. Finholt, A. C. Bond and H. J. Schlesinger, *J. Amer. Chem. Soc.* **69**, 1200 (1947).
 E. Wiberg, H. Graf and R. Usón, *Z. anorg. allg. Chem.* **272**, 221 (1953).

Aluminum Chlorohydride

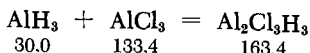

A fresh ether solution of monomeric AlH_3 is prepared as described in the previous section and the LiCl precipitate is removed by filtration or centrifugation. A solution of AlCl_3 in a small volume of ether is immediately added to the clear AlH_3 solution. The two reactants (AlH_3 and AlCl_3) are added in equimolar amounts. The addition of the AlCl_3 prevents the polymerization of the AlH_3 . The ether can then be completely evaporated from the solution, yielding a water-clear liquid, which distills at 80°C without decomposition in high vacuum. It has the composition of $\text{Al}_2\text{Cl}_3\text{H}_3$.

SYNONYM:

Trichlorodialane.

PROPERTIES:

The ether solution of the compound behaves chemically as a mixture of solutions of AlH_3 and AlCl_3 . It has the advantage of being more stable than an ether solution of pure AlH_3 .

REFERENCE:

- E. Wiberg and M. Schmidt, *Z. Naturforsch.* **6 b**, 333, 458, 459 (1951).

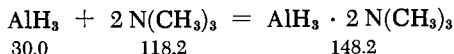
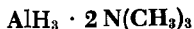
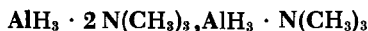
Aluminum Hydride Trimethylamine

As in the preceding two preparations, a fresh ethereal solution of monomeric AlH_3 is prepared and its concentration adjusted to 0.5 M. A 15-ml. portion of a 1 M ether solution of anhydrous trimethylamine is added to 15 ml. of the hydride solution. If a slight turbidity results, the mixture should be centrifuged. The clear solution is left to stand for one half hour. The ether is then vacuum distilled, starting at -78°C and slowly raising the temperature to $+20^\circ\text{C}$. The residue, a white powder, is slowly sublimed in high vacuum into a receiving flask cooled with an ice-salt mixture; the sublimation temperature is 40°C . The composition of the sublimate is $\text{AlH}_3 \cdot 2 \text{N}(\text{CH}_3)_3$.

PROPERTIES:

Colorless crystals. M.p. 95°C ; decomposes above 100°C . Fumes in air and is vigorously hydrolyzed in water. Soluble in tetrahydrofuran, ether and benzene.



The compound is prepared analogously, but using equimolar quantities of the hydride and the amine. The white powder left in the flask after removal of the ether sublimes between 50 and 60°C (1 mm.). The product consists of colorless crystals which have the composition $\text{AlH}_3 \cdot \text{N}(\text{CH}_3)_3$.

PROPERTIES:

M.p. 76°C . Otherwise similar to $\text{AlH}_3 \cdot 2 \text{N}(\text{CH}_3)_3$.

REFERENCE:

E. Wiberg, H. Graft and R. Usón, *Z. anorg. allg. Chem.* **272**, 221 (1953).

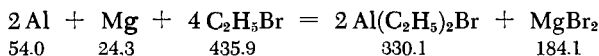
Diethylaluminum Bromide

The reaction is carried out in a one-liter, three-neck flask equipped with a stirrer, a reflux condenser and a dropping funnel,

as well as an inlet tube for dry, oxygen-free nitrogen. The flask is filled with 107 g. of turnings obtained from an alloy of 30% magnesium and 70% aluminum. Small quantities of iodine and ethyl bromide are added. After a short time the halide can be observed to react with the metal. The reaction flask is then immersed in an oil bath and a total of 496 g. of ethyl bromide is added dropwise during 2.5 hours. The flask is then heated to 120-140°C and kept at this temperature for one hour to ensure completion of the reaction. The product is separated from the magnesium bromide by vacuum distillation, using an oil pump, and is redistilled in vacuum (2 mm., 75°C). All operations must be carried out under nitrogen. The yield is 370 g. of $\text{Al}(\text{C}_2\text{H}_5)_2\text{Br}$, contaminated with 2% $\text{AlC}_2\text{H}_5\text{Br}_2$.

REFERENCE:

A. von Grosse and J. M. Mavity, *J. Org. Chem.* 5, 106 (1940).

Triethylaluminum



Sodium wire (50 g.) is introduced under nitrogen into a three-neck flask fitted with a stirrer, a reflux condenser and a nitrogen inlet tube. Then 150 g. of $\text{Al}(\text{C}_2\text{H}_5)_2\text{Br}$ is added dropwise. The flask is heated to 105°C and a vigorous reaction soon begins. The mixture starts to boil and external cooling is necessary. As soon as the reaction quiets down, an additional 186 g. of $\text{Al}(\text{C}_2\text{H}_5)_2\text{Br}$ is added. The temperature is slowly raised to 200°C and maintained there for 10 hours, with constant stirring. The flask is then cooled to room temperature and 2 g. of sodium wire is added to ensure completion of the dehalogenation. Stirring is resumed, and the temperature is again raised to 150°C and held for 1.5 hours. The $\text{Al}(\text{C}_2\text{H}_5)_3$ formed is distilled from the reaction mixture in vacuum (2 mm.). Further purification is achieved by fractionation in a vacuum Podbielniak column; the product boiling between 128 and 130°C and 50 mm. is collected.

PROPERTIES:

Formula weight 114.2. Spontaneously flammable. Immediately hydrolyzed by moisture to $\text{Al}(\text{OH})_3$ and C_2H_6 .

REFERENCES:

A. von Grosse, J. M. Mavity, *J. Org. Chem.* 5, 106 (1940). Recent pressure processes for aluminumtrialkyls starting with Al , H_2 and olefins, as well as their applications to the low-pressure polymerization of ethylene, are given in K. Ziegler et al., *Angew. Chem.* 67, 424 (1955).

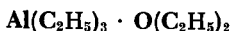
Triethylaluminum Etherate

A 24-g. sample of Electron metal turnings (15.1% Al, the remainder Mg and traces of Si) is covered with 400 ml. of ether in a three-neck flask fitted with a reflux condenser, a stirrer and a dropping funnel; 150 g. of ethyl bromide is added by drops. The reaction may be initiated by the addition of a few crystals of iodine. While the reaction is in progress, the ether should be boiling at a uniform rate. When the metal has completely dissolved, the ether is quickly removed, leaving a solid residue from which the triethylaluminum etherate is distilled at 140-180°C into an ice-cooled receiver. The distillation is carried out slowly under nitrogen at 14-16 mm., using an oil bath. The product is redistilled at 112°C and 16 mm.

PROPERTIES:

Formula weight 188.3. Colorless liquid, sensitive to air and moisture. B.p. 112°C (16 mm.).

REFERENCES:

- E. Krause and B. Wendt, *Ber. dtsch. chem. Ges.* 56, 466 (1923).
 E. B. Baker and H. S. Sisler, *J. Amer. Chem. Soc.* 75, 4828 (1953).

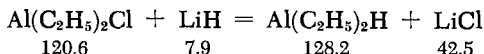
Diethylaluminum Hydride

The ether complex of diethylaluminum chloride is prepared first by adding dropwise one half mole of AlCl_3 , dissolved in some ether, to one mole of $\text{Al}(\text{C}_2\text{H}_5)_3 \cdot \text{O}(\text{C}_2\text{H}_5)_2$. When the evolution of heat ceases, the excess solvent is evaporated and the $\text{Al}(\text{C}_2\text{H}_5)_2\text{Cl}$ etherate is distilled in vacuum. A 76-g. portion of this product is diluted with 120 ml. of absolute ether and placed in a 500-ml., three-neck flask which has been flushed with dry nitrogen. A suspension of LiH in ether (62 ml., 7 M in LiH) is prepared in a dropping funnel under a nitrogen blanket and allowed to flow into the flask. Lithium chloride separates and the reaction mixture boils. Toward the end of the reaction, stirring is applied and the mixture is heated to 40°C for 15 minutes more. The LiCl

rapidly precipitates when the flask is allowed to cool. The clear supernatant is then sampled with a pipette and tested for halogen. If the test is positive, a few more drops of the LiH suspension are added. The supernatant should be just halogen free but should not contain any appreciable amount of excess Li. The mixture is then centrifuged and the clear solution decanted. The precipitate is washed with a small volume of ether, which is then evaporated in an aspirator vacuum, the last traces being removed at 50°C. The residual $\text{Al}(\text{C}_2\text{H}_5)_2\text{H}$ is distilled in high vacuum, holding the flask in a bath maintained at 80°C or lower. It is collected in a receiver cooled to -20°C. The distillate is a water-clear liquid. The entire preparation should be carried out without interruption. The presence of solid deposits during the distillation of the crude product lowers the yield, which otherwise may be as high as 70%.

PROPERTIES:

Air- and moisture-sensitive liquid. B.p. 55-56°C (10⁻³ mm.).

REFERENCE:

K. Ziegler, H. G. Gellert, H. Martin and K. Nagel, *Liebigs Ann. Chem.* 589, 91-121 (1954).

Aluminum Chloride

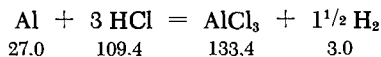

I. One end of a large diameter Vycor tube (25 to 40 mm.) is inserted through one of two holes bored in a cork closing a wide-neck flask. The second hole holds a tube leading to the hood. The cork can be dispensed with if the reaction tube can be made to fit tightly into the neck of a long-neck, round-bottom flask. The reaction tube is placed in an electric furnace. The distance between the hot zone and the receiver flask should not be longer than 8 cm., to prevent plugging of the tube by the sublimate. The cork is protected from the heat by an asbestos wrapping. A porcelain boat containing aluminum turnings or powder is inserted in the reaction tube. Gaseous HCl is then passed through from the end opposite the receiver. The rubber tubing connections should be as short as possible. When the air has been completely displaced by the HCl, the furnace is slowly heated until a white mist begins to appear. The flow of HCl is then increased and the temperature raised to

prevent premature condensation of the sublimate. The reaction is then allowed to continue until the aluminum has been completely consumed.

II. Commercial AlCl_3 , which usually contains iron and traces of oxygen due to hydrolysis, may be purified by the following procedure. The crude material is mixed with about 10% by weight of aluminum turnings and the mixture is placed in a sublimation flask with a side arm through which a moderate stream of dry HCl is fed during the sublimation. A short, wide, curved tube connects the sublimation flask with the receiving flask and the entire system is protected against moisture by a drying tube. Further purification is by resublimation in a nitrogen atmosphere, using the receiver of the first step as a sublimation flask; the rest of apparatus is similar.

PROPERTIES:

M.p. 193°C , b.p. 180°C ; d (17°C) 2.465, d (200°C , liq.) 1.31. Colorless, transparent, hexagonal plates. Very hygroscopic.

REFERENCES:

- I. F. Stockhausen and L. Gattermann, Ber. dtsh. chem. Ges. 25, 3521 (1892).
- II. D. D. Eley and H. Watts, J. Chem. Soc. (London) 1952, 1914.

Aluminum Bromide

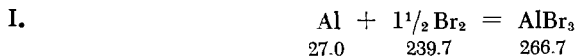

Very pure AlBr_3 may be prepared in the apparatus shown in Fig. 244. The bottom of the reaction flask is covered with a layer of glass wool, and the desired quantity of very pure, degreased dry aluminum turnings is placed on top. Nitrogen, dried over P_2O_5 , is introduced at *e* and escapes at *f*. When the last traces of moist air have been flushed out, stopcock *e* is closed and the stream of nitrogen is passed from *g* to *f*. Dry bromine is then added from the dropping funnel into flask *a*. The rate of addition is adjusted so that the heat of reaction maintains the resulting AlBr_3 at a temperature sufficient for refluxing in the middle section of the air condenser. A considerable excess of Al should remain after all the bromine has been added. The reaction flask is then heated until the liquid flowing down from *b* is colorless.

The direction of the nitrogen stream is reversed, a drying tube filled with P_2O_5 is attached at *g*, and the $AlBr_3$ is distilled from *a* into receiver *c*. When the distillation is complete, the receiver is disconnected without interrupting the nitrogen flow and immediately closed tightly.

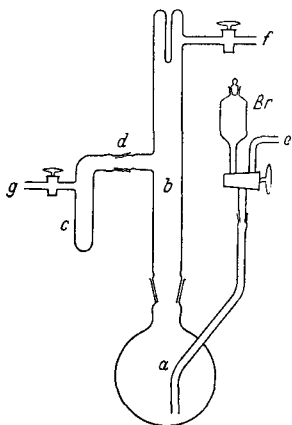

Fig. 244. Preparation of aluminum bromide.

II. When colorless $AlBr_3$ is not required, the procedure described in I may be carried out in a regular distillation flask with a dropping funnel for bromine. The bottom of the flask is again covered with glass wool and the aluminum placed on top. The flask is preheated over an open flame to about $100^\circ C$. The dropwise addition of Br_2 is then carried out at such a rate that it is rapidly consumed. The temperature should remain below the boiling point of $AlBr_3$. When the addition is complete the product is distilled through a descending tube into a receiver.

PROPERTIES:

Colorless, shiny lamellae. Hydrolyzes in moist air. Reacts violently with water (caution!). Soluble in many organic solvents. M.p. $97.5^\circ C$, b.p. $255^\circ C$; d ($18^\circ C$) 3.205, d ($100^\circ C$, liq.) 2.64.

REFERENCES:

- D. G. Nicholson, P. K. Winter and H. Fineberg in: F. Audrieth, *Inorg. Syntheses*, Vol. III, New York-London 1950, p. 33.
 W. Biltz and A. Voigt, *Z. anorg. allg. Chem.* 126, 48 (1923).
 W. Klemm, W. Tilk and S. von Müllenheim, *Z. anorg. allg. Chem.* 176, 14 (1928).

Aluminum Iodide

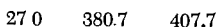
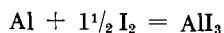

I. Aluminum turnings and a few crystals of iodine are placed in a CO_2 -filled flask and heated until reaction begins. More I_2 is then added until only a small amount of aluminum remains. The

reaction product is kept a little longer in the molten state and then transferred under nitrogen into an Anschütz distillation flask, where it is slowly distilled in an oil pump vacuum. The pump is protected against iodine vapor by two wash bottles filled with activated charcoal.

II. A 20-g. portion of dried and sublimed iodine is dissolved in 80 ml. of CS_2 and heated with 3.5 g. of sheet aluminum in a flask provided with a reflux condenser. When the reaction is over, the mixture is filtered, the filtrate is heated over a water bath (caution: do not use an open flame!) to distill off most of the CS_2 , and the concentrated residue is cooled. Aluminum iodide crystallizes out. The crystals are suction-filtered, washed with hexane and dried at 100°C . The product retains a slight yellow-brown tinge.

PROPERTIES:

Colorless leaflets if pure. Moisture-sensitive. Decomposes to I_2 and Al_2O_3 on heating in air. Soluble in CS_2 , alcohol and ether. M.p. 191°C , b.p. 382°C ; d (17°C) 3.948; d (200°C , liq.) 3.26.

REFERENCES:

- I. W. Biltz and A. Voigt, Z. anorg. allg. Chem. 126, 50 (1923).
W. Klemm, W. Tilk and S. von Müllenheim, Z. anorg. allg. Chem. 176, 15 (1928).
- II. W. Nespital, Z. phys. Chem. (B) 16, 164 (1932).

Aluminum Chloride Hydrate

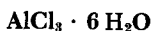

At 0°C , $\text{AlCl}_3 \cdot 6\text{H}_2\text{O}$ is slightly soluble (21 mg./100 ml.) in saturated aqueous HCl and is therefore easily isolated from such a solution. The aluminum is dissolved in concentrated HCl and the solution is transferred into a three-neck flask fitted with a stirrer, an inlet tube for HCl gas and an outlet tube. The flask is cooled to 0°C and HCl gas is introduced into the continuously stirred and cooled solution until it is saturated. The inlet tube should not dip into the solution, since it might become clogged with salt, but sufficient absorption of the HCl is ensured by vigorous stirring. A wash bottle with concentrated H_2SO_4 connected to the outlet of the flask serves to indicate the progress of the saturation. The precipitated hydrate is rapidly suction-filtered and, while still cold, washed with some ether and dried on a clay plate.

REFERENCE:

- W. Fischer and W. Seidel, Z. anorg. allg. Chem. 247, 333 (1941).

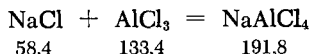
Sodium Tetrachloroaluminate

The reaction is carried out in a Pyrex vessel (Fig. 245), which should be as compact as possible. The stoichiometric amounts of C.P. NaCl and freshly sublimed AlCl_3 are introduced into the pear-shaped part of the reaction vessel.

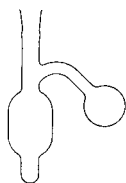

Fig. 245. Preparation of sodium tetrachloroaluminate.

The filling is done under nitrogen and the vessel should be very clean and dry. A melting point capillary is then affixed underneath the ground joint; the apparatus is evacuated to a high vacuum and torch-sealed. It is then immersed as deeply as possible in an oil bath at $200-240^\circ\text{C}$. The AlCl_3 , which tends to sublime onto the cool parts of the wall,

is driven back by passing a luminous flame over the condensate spots. When the flask contents have become a nearly clear melt, they are poured hot into the side flask of the vessel. The product solidifies on cooling.

PROPERTIES:

Colorless, crystalline material. M.p. 156°C .

REFERENCES:

- H. Gerding and H. Houtgraaf, *Rec. Trav. Chim. Pays-Bas* **72**, 21 (1953).
 N. C. Baenziger, *Acta Cryst. (London)* **4**, 216 (1951).

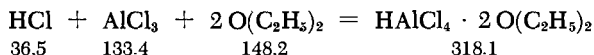
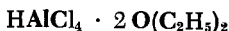
Tetrachloroaluminic Acid Dietherate

Dry HCl gas is passed through absolute ether until a concentrated solution is obtained. Slightly less than the stoichiometric amount of anhydrous AlCl_3 is added with cooling and shaking. A

clear oil separates and slowly forms white crystals when the mixture is cooled to -20°C with stirring. The crystals are filtered under nitrogen on a sintered glass filter and washed with ether. The compound is stable on storage if moisture is excluded.

Analogously, AlBr_3 and HBr may be reacted to form $\text{HALBr}_4 \cdot 2\text{O}(\text{C}_2\text{H}_5)_2$, which is obtained in the form of an oil.

REFERENCE:

- E. Wiberg, M. Schmidt and A. G. Galinos, *Angew. Chem.* **66**, 443 (1954).

Aluminum Chloride Ammoniate

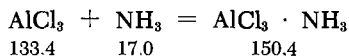

Thoroughly dried ammonia is passed over freshly sublimed AlCl_3 in a long, 20–40 mm. diameter glass tube. Higher ammoniates are formed as the contents melt. The reaction tube is swept with nitrogen and slowly heated in a furnace from 190°C to 360°C at which temperature the monoammoniate $\text{AlCl}_3 \cdot \text{NH}_3$ is obtained. It is purified by vacuum distillation at 2 mm., with the flask on an oil bath at $205\text{--}210^{\circ}\text{C}$.

PROPERTIES:

Moisture-sensitive, colorless substance. M.p. 130°C .

REFERENCES:

- E. Tiede, M. Thimann and K. Sensse, *Ber. dtsch. chem. Ges.* **61**, 1568 (1928).
H. Gerding and H. Houtgraaf, *Rec. Trav. Chim. Pays-Bas* **74**, 15 (1955).

Aluminum Chloride-Sulfur Dioxide Adduct

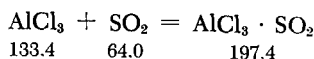

A combustion tube is charged with AlCl_3 , which should be pure and free of iron. An excess of SO_2 is condensed on the chloride.

No moisture should be present during the reaction. The tube is torch-sealed and heated to 50°C for about half an hour. The excess SO₂ is then allowed to escape by heating the sealed end of the tube. The residue is a viscous, colorless liquid, which gradually solidifies. Its composition is AlCl₃ · SO₂.

REFERENCES:

- O. Ruff, Ber. dtsh. chem. Ges. 35, 4954 (1902).
H. Gerding and E. Smit, Z. phys. Chem. (B) 51, 204 (1942).

Aluminum Chloride-Thionyl Chloride Adduct

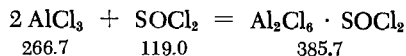

Anhydrous AlCl₃ is dissolved at room temperature in excess SOCl₂. When large quantities are to be prepared, the solubility of the AlCl₃ can be increased by heating the solution. The excess SOCl₂ is distilled from the red-brown solution and the temperature of the bath in which the flask is immersed is then slowly raised. The first fraction is discarded. The Al₂Cl₆ · SOCl₂ distills over at 212 to 216°C in the form of oily droplets which solidify in the receiving flask. The product is purified by fractionation, b.p. 214-215°C.

REFERENCE:

- H. Hecht, Z. anorg. allg. Chem. 254, 44 (1947).

Aluminum Chloride-Phosphorus Pentachloride Adduct

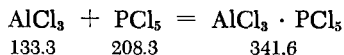
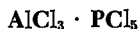

I. Aluminum chloride and more than the stoichiometric amount of PCl₅ are placed in a thick-wall tube sealed at one end. The tube is evacuated using an oil pump and the other end is sealed. The tube is then heated until the solid turns into a clear melt. After cooling, the tube is opened under nitrogen and the contents are poured into a small distillation flask. Vacuum is applied and the temperature slowly raised to 300°C to remove the excess PCl₅.

II. A precipitate of $\text{AlCl}_3 \cdot \text{PCl}_5$ is produced on mixing a chloroform solution of PCl_5 and AlCl_3 .

PROPERTIES:

Colorless powder. M.p. 380°C (383°C , II). Soluble in nitrobenzene. This solution conducts a current and probably contains the ions AlCl_4^- and PCl_4^+ .

REFERENCES:

- I. W. Fischer and O. Jübermann, *Z. anorg. allg. Chem.* **235**, 345 (1938).
- II. Ya. A. Fialkov and Ya. B. Buryanov, *Doklady Akad. Nauk. SSSR* **92**, 585 (1953).

Aluminum Bromide-Hydrogen Sulfide Adduct

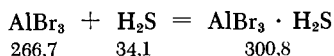
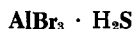

Aluminum bromide is dissolved in liquid H_2S with exclusion of moisture. When solution is complete, the excess H_2S is evaporated. Alternatively, dry H_2S gas may be introduced into a solution of AlBr_3 in CS_2 and the precipitated crystals filtered with exclusion of moisture.

PROPERTIES:

Colorless, moisture-sensitive crystals. M.p. 103°C in a closed tube. Structure: Al tetrahedrally surrounded by 3 Br and 1 S.

REFERENCES:

- W. Biltz and E. Keunecke, *Z. anorg. allg. Chem.* **147**, 174 (1925).
 J. Jakubsohn, *Z. phys. Chem.* **118**, 32 (1925).
 Armin Weiss, P. Plass and Alarich Weiss, *Z. anorg. allg. Chem.* **283**, 390 (1956).

Aluminum Iodide-Hexammoniate

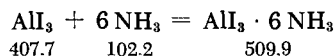
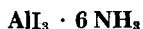

Approximately 1 g. of coarsely ground, pure AlI_3 is placed in a tared dry flask and weighed. A slow nitrogen stream is passed

through a trap containing dry, liquid ammonia at -40°C , and is then introduced into the flask with the AlI_3 , which is kept at -70°C throughout the reaction. The ammonia is absorbed by the iodide, and a fine, white powder forms. Periodic weighing is used as a check for the quantitative absorption of six moles of NH_3 for each mole of AlI_3 present.

If the concentration of ammonia in the nitrogen is too high, or if the cooling is not efficient enough, the reaction may become so vigorous that the iodide will melt and partially sublime. Partial ammonolysis of the AlI_3 may also occur.

REFERENCE:

W. L. Lloyd Taylor, E. Griswold and J. Kleinberg. *J. Amer. Chem. Soc.* 77, 294 (1955).

Aluminum Hydroxide

$\alpha\text{-Al}(\text{OH})_3$ (HYDRARGILLITE)

I. Aluminum hydroxide (C.P. or better) is dissolved with moderate heating in sodium hydroxide solution (saturated in the cold) until saturation is attained. The solution is diluted with water to a density of 1.1, suction-filtered through hard filter paper, and stored for two weeks in a closed vessel. The mother liquor is decanted from the precipitate of $\text{Al}(\text{OH})_3$ formed. The residue is digested for several days with cold water and then washed with hot water until no alkaline reaction is detectable with litmus. The product is dried first over CaCl_2 , then over P_2O_5 . The entire preparation is carried out in Pyrex glassware.

II. Aluminum hydroxide is precipitated from solution by a cold solution of $(\text{NH}_4)_2\text{CO}_3$; the crystals are thoroughly washed on a leaf filter and added in small portions to a 50% NaOH solution until no further solution occurs. The greater part of the solution is filtered. The remainder, which contains a small quantity of undissolved aluminum hydroxide, is used to seed the filtrate. Well-developed crystals of hydrargyllite form in about eight days. They are then washed free of alkali.

PROPERTIES:

Poor adsorptivity. Converted into boehmite (AlOOH) at 180 to 200°C . $d(20^{\circ}\text{C})$ 2.424.

REFERENCES:

- I. R. Fricke and B. Wullhorst, *Z. anorg. allg. Chem.* 205, 127 (1932).
- II. W. Biltz and K. A. Lehrer, *Z. anorg. allg. Chem.* 172, 299 (1928).

β -Al(OH)₃ (BAYERITE)

I. Aluminum hydroxide (C.P. or better) is dissolved with moderate heating in sodium hydroxide solution (saturated in the cold) until saturation is attained. The solution is diluted with water to a density of 1.15 and suction-filtered through hard filter paper. Carbon dioxide is then bubbled through the filtrate for three days. The mother liquor is decanted from the resulting precipitate; the subsequent treatment is identical to that described for hydrargillite (I). The thoroughly washed and dried residue is pure bayerite.

II. Pure aluminum ribbon is cut into strips, degreased and rinsed with freshly distilled acetone. The pieces are covered with a layer of amalgam by a short dip in a 0.1N solution of HgCl₂ and thoroughly washed with distilled water, followed by a final rinsing with double-distilled water. The pieces are then transferred to a Pyrex flask closed off with a soda-lime tube, and covered with double-distilled water. White flakes of bayerite form after a few days.

Initially, the product obtained by procedure II is amorphous according to its x-ray pattern; however, after 25-30 hours, the bayerite lines begin to appear in the powder pattern.

PROPERTIES:

Hexagonal crystals. Considered to be a metastable modification of Al(OH)₃. Industrial Al(OH)₃, which is made by stirring seeded aluminum hydroxide solutions, is chiefly hydrargillite. Precipitation from acid solution, on the other hand, yields exclusively an amorphous product when carried out in the cold, and chiefly boehmite (α -AlOOH) when hot solutions are used.

REFERENCES:

- R. Fricke and B. Wullhorst, *Z. anorg. allg. Chem.* 205, 127 (1932).
H. Schmäh, *Z. Naturforsch.* 1, 323 (1946).
J. Böhm, *Z. anorg. allg. Chem.* 149, 203 (1925).
R. Fricke, *Z. anorg. allg. Chem.* 166, 244 (1927); 175, 249 (1928).

 α -AlOOH (BOEHMITE)

I. As described in method II for preparation of bayerite, C.P. aluminum is coated with a layer of amalgam and thoroughly rinsed with double-distilled water in a ground glass flask with a riser tube. When the water is brought to a boil, a violent reaction ensues which, however, dies down before the aluminum has been entirely consumed. The boehmite obtained is separated by decantation and dried over CaCl₂, followed by drying over P₂O₅.

II. Aluminum hydroxide precipitated in the cold with ammonia solution is covered with water in an autoclave and heated for two hours at 200°C. Pure boehmite is formed.

PROPERTIES:

Boehmite is the chief constituent of bauxite. It is converted into diaspore by heating it in the presence of NaOH for several days at 350°C in an autoclave. Natural diaspore is added as a seeding material [V. K. Drushinida, Doklady Akad. Nauk SSSR, N.S., 88, 133 (1953)].

REFERENCE:

- I. R. Fricke and K. Jockers, Z. anorg. allg. Chem. 262, 3 (1950).
- II. J. Böhm, Z. anorg. allg. Chem. 149, 203 (1925).
H. Ginsberg and M. Köster, Z. anorg. allg. Chem. 271, 41 (1952).

Aluminum Oxide

α -Al₂O₃ (CORUNDUM)

The compound is prepared by heating aluminum hydroxide or α -Al₂O₃ to above 1100°C. Diaspore undergoes rapid conversion above 500°C.

PROPERTIES:

Rhombohedral crystals. M.p. 2050°C.

β -Al₂O₃

The β form crystallizes from molten aluminum oxide containing up to 5% of an alkali oxide. The transition takes place at a temperature not much below the melting point of cryolite (1020°C) when a mixture of cryolite and α -Al₂O₃ is annealed. The α form is converted into β -Al₂O₃ after annealing a mixture containing 15-20% cryolite for 20 hours.

PROPERTIES:

Always contains a small amount of alkali. It is therefore occasionally considered to be a very aluminum-rich alkali aluminate. Hexagonal crystals.

REFERENCE:

- H. Saalfeld, Z. anorg. allg. Chem. 286, 174 (1956).

$\gamma\text{-Al}_2\text{O}_3$

Recent investigations have established that annealing of aluminum hydroxides (with the exception of diaspore) at temperatures between 400 and 1000°C yields not only $\gamma\text{-Al}_2\text{O}_3$, but a series of various phases (χ , η , κ , $\delta\text{-Al}_2\text{O}_3$), all of which probably contain some residual water to stabilize the respective lattices. As far as range of existence and preparative conditions for these modifications is concerned, the original papers should be consulted.

REFERENCES:

- H. C. Stumpf, A. S. Russel and J. W. Newsome, *Ind. Eng. Chem.* 42, 1398 (1950).
 M. R. Teritan, *Compt. Rend. Hebd. Séances Acad. Sci.* 230, 1677 (1950).
 Structure Reports 13, 225 (1950).
 H. Thibon, J. Charrier and R. Tertian, *Bull. Soc. Chim. France*, (Mém) (5) 18, 384 (1951).
 M. K. B. Day and V. J. Hill, *Nature (London)* 170, 539 (1952).

Aluminum Sulfide

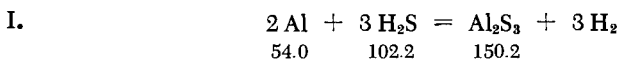

Aluminum turnings are placed in a corundum boat inserted in a quartz or hard porcelain tube. One end of the tube is connected to a generator of pure, dry H_2S ; the other end leads to the hood. The tube is placed in a furnace and H_2S is passed through. The temperature during the first five hours is 600–630°C, and for the following 12 hours, 1000°C. The product consists of 90–94% aluminum sulfide which still contains some unreacted aluminum and 1–3% oxygen. Higher reaction temperatures lead to a higher oxygen content, because the product reacts with the corundum of the boat.



A stoichiometric mixture of aluminum filings and sulfur powder is placed in a graphite crucible and covered with some excess sulfur. The reaction is started by a short circuit between the bottom of the crucible and a carbon electrode immersed in the

crucible. The reaction may also be initiated with a burning magnesium strip. After the reaction is over, the product is placed in a carbon boat or crucible and heated in vacuum for six hours to 1150°C to remove excess aluminum. The molten mass is then allowed to cool slowly. Crystals 1-3 mm. thick are obtained. See also the procedure for deuterium sulfide, p. 134.

PROPERTIES:

Yellowish powder or crystals; excess aluminum gives the compound a gray tinge. Hydrolyzed by water to H_2S and $Al(OH)_3$.

REFERENCES:

- W. Klemm, K. Geiersberger, B. Schaefer and H. Mindt, *Z. anorg. allg. Chem.* 255, 288 (1948); cites earlier references.
 J. Flahaut, *Compt. Rend. Hebd. Séances Acad. Sci.* 232, 334 (1951).

Aluminum Sulfit

BASIC ALUMINUM SULFITE, $Al_2O_3 \cdot 2SO_2 \cdot H_2O$

Sulfur dioxide is introduced into a suspension of $Al(OH)_3$ in water until a clear solution is obtained. The latter is then placed in a flask closed with a Bunsen valve. The flask is heated to 78-80°C with constant shaking. A magnetic stirrer may be used. Sulfur dioxide is evolved in the process, a slight positive pressure being maintained by the valve. Crystallization sets in suddenly and is essentially complete after four hours. The solid product is filtered and dried under vacuum. It consists of $Al_2O_3 \cdot 2SO_2 \cdot 3H_2O$. Heating to 68 to 90°C under vacuum liberates water until the composition $Al_2O_3 \cdot 2SO_2 \cdot 1H_2O$ is attained.

PROPERTIES:

Formula weight 248.08. Heating above 100°C causes decomposition with evolution of SO_2 and water.

REFERENCE:

- E. Rosenkranz and G. F. Hüttig, *Z. anorg. allg. Chem.* 226, 126 (1936).

NEUTRAL ALUMINUM SULFITE, $Al_2O_3 \cdot 3SO_2 \cdot xH_2O$

A concentrated aqueous solution of aluminum sulfite is prepared according to the directions in the preceding method and evaporated

over P_2O_5 in a desiccator. The P_2O_5 should be renewed several times. Sulfur dioxide is passed through the desiccator during the entire drying process, which takes about 10-14 days.

PROPERTIES:

White powder with variable water content.

REFERENCE:

W. Fischer and E. Burger, *Z. anorg. allg. Chem.* **251**, 355 (1943).

Aluminum Selenide

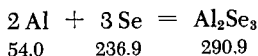

I. Pure, dry aluminum powder (30 g.) is ground together with 50 g. of finely divided, dry precipitated selenium. Then 5 g. of the mixture is transferred into a thick-wall, 200-ml. clay crucible provided with a lid. The crucible is placed in the hood and a small piece of burning magnesium strip is dropped in to ignite the mixture. The crucible is immediately covered again. At intervals of a few seconds the lid is raised a little and about 3 g. of the starting mixture is added until the entire mixture is used up. When the crucible has cooled down, the product is crushed and stored in a closed container.

II. A stoichiometric mixture of aluminum powder and red selenium is placed in a combustion tube, which is evacuated and sealed off. The end of the tube at which the mixture is situated is carefully heated over an open flame until the onset of the reaction, which occurs at the beginning of red heat. The reaction progresses slowly throughout the entire mass and is accompanied by incandescence.

III. Aluminum turnings are placed in a carbon boat inserted in a Pyrex reaction tube. One end of the tube is connected to a source of high vacuum, the other end to a storage tube containing red selenium. The system is evacuated and the selenium is driven into the reaction tube by heating. The reaction tube itself is heated to 600-650°C for 36 hours, which is the time required for complete conversion.

PROPERTIES:

Yellow; slowly hydrolyzed in moist air to H_2Se and $Al(OH)_3$.

REFERENCES:

- I. G. R. Waitkins and R. Shutt in: W. C. Fernelius, *Inorg. Syntheses*, Vol. II, p. 184, New York-London, 1946.
H. G. Grimm and A. Metzger, *Ber. dtsh. chem. Ges.* 69, 1356 (1936).
- II. O. Glemser and T. Risler, *Z. Naturforsch.* 3 b, 2 (1948).
- III. W. Klemm et al., *Z. anorg. Chem.* 255, 289 (1948).
A. Schneider and G. Gattow, *Z. anorg. allg. Chem.* 277, 49 (1954).

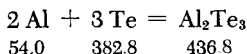
Aluminum Telluride

I. A corundum crucible is placed in a quartz tube sealed at one end. A narrow glass tube is inserted deep into the quartz tube, and is used for introduction of a slow stream of nitrogen during the reaction. The Te is placed in the crucible with the help of a small long-stem funnel and then fused into a solid mass by heating the quartz tube. The calculated amount of aluminum powder is then added in small portions. If the usually vigorous reaction does not occur, it may be started by mixing the melt briefly with an iron wire. When the reaction is over, the product is annealed by heating for half an hour at 800-900°C.

II. A Pyrex tube (12-mm. diameter) is torch-sealed at one end and is slightly constricted 10 cm. from the sealed end. The lower, sealed part of the tube is charged with tellurium, and a porcelain boat containing somewhat less than the calculated amount of aluminum powder is made to slide down into the tube until it is stopped by the constriction. A second constriction is then made at the open end. The tube is evacuated with an aspirator; the aluminum is heated to a light red glow (caution, the glass may warp) and the tellurium melts. The evaporating tellurium reacts with the aluminum. A small fraction of the tellurium condenses on the colder walls above the aluminum. When all the tellurium has evaporated from the lower end of the tube, the latter is sealed and the condensed tellurium is evaporated from the walls and made to pass several times over the aluminum until its quantity appears to remain constant.

PROPERTIES:

Brown-black, metallic sheen, quite hard; hydrolyzes in moist air.

REFERENCES:

- I. W. Klemm et al., Z. anorg. allg. Chem. 255, 291 (1947).
 II. L. Moser and K. Ertl, Z. anorg. allg. Chem. 118, 272 (1921).

Aluminum Nitride

AlN



A nickel boat is filled with very pure aluminum powder which has been degreased and dried either by extraction with ether or by heating to 150°C in a stream of nitrogen. The boat is placed in a quartz or porcelain tube and heated in an electric furnace while purified nitrogen is passed over it. Even though the nitride starts to form on the surface below 650°C, the reaction proper begins only at 820°C, when the entire mass begins to glow. At this point the flow of nitrogen should be increased to prevent the N₂ pressure from decreasing owing to the rapid reaction. When the reaction is essentially complete, the mass is allowed to cool in a stream of nitrogen. Since the product still contains some unreacted metal, it is pulverized and reheated under nitrogen for 1-2 hours at 1100-1200°C. The product obtained is nearly white and has a nitrogen content not far below theoretical.

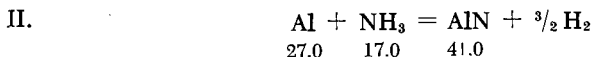

To obtain silicon-free AlN, aluminum powder pretreated as above is placed in a trough of molybdenum sheet inside a nickel reaction tube, and NH₃ is led through while the tube is heated to 1300°C in an electric furnace.

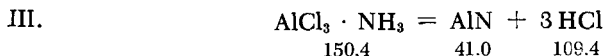

The reaction is performed in the apparatus shown in Fig. 246, which consists essentially of a thick-wall Pyrex tube with an enlargement in the middle and four necks at the top. A thin glass tube (nitrogen inlet) passes through the middle neck and reaches nearly to the bottom. The two side necks contain silver wire leads to a tungsten heating coil *w* suspended in the reaction tube at the level of the bulb. The fourth neck is an outlet for the gas. The reaction tube is thoroughly dried and AlCl₃ · NH₃, prepared

according to the procedure on p. 817, is placed at the bottom. The nitrogen flow is turned on, coil w is heated to about 1000°C , and the $\text{AlCl}_3 \cdot \text{NH}_3$ is evaporated at 400°C into the upper chamber of the tube, where it is remelted by the second heating element h and made to flow down again. The decomposition takes place on the tungsten coil, AlN being deposited. When the reaction is complete, the product is scraped off and freed of residual chlorine by heating to incandescence in a nitrogen atmosphere.

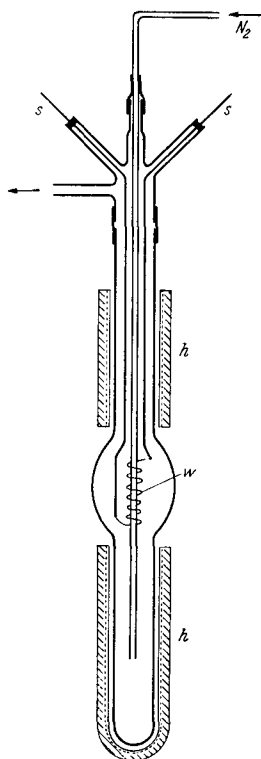

Fig. 246. Preparation of aluminum nitride. h) heater elements; s) electrical leads for heating coil w .

PROPERTIES:

Slowly hydrolyzed in moist air. Dry O_2 and HCl attack the compound only above 800°C . M.p. $2150\text{--}2200^{\circ}\text{C}$; d (25°C) 3.05. Crystallizes in a wurtzite lattice.

REFERENCES:

- I. F. Fichter, *Z. anorg. allg. Chem.* **54**, 322 (1907); **82**, 194 (1912).
J. Wolf, *Z. anorg. allg. Chem.* **83**, 159 (1913); **87**, 123 (1914).
- II, III: E. Tiede, M. Thimann and K. Sensse, *Ber. dtsch. chem. Ges.* **61**, 1568 (1928).
T. Renner, *Z. anorg. allg. Chem.* **298**, 22 (1959).

Lithium Aluminum Nitride

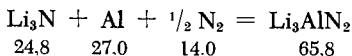

A stoichiometric mixture of Li_3N and cleaned and degreased aluminum bronze (99.3% Al) is placed in a molybdenum boat, which is then inserted in an iron tube and heated to 630°C in a stream of nitrogen. A vigorous reaction ensues and the nitrogen is absorbed. The temperature is raised to 750°C for a short time and the product is then cooled under nitrogen.

Alternative procedures: The compound is also formed when AlN is annealed with Li_3N or when an alloy of 3 Li and 1 Al is heated in a stream of N_2 .

PROPERTIES:

White powder, hydrolyzed by humid air. Thermally stable up to 1000°C. Crystallizes in the cubic system in a CaF₂ superstructure.

REFERENCE:

R. Juza and F. Hund, *Z. anorg. allg. Chem.* **257**, 13 (1948).

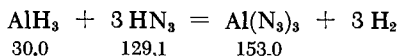
Aluminum Azide

An ether solution of AlH₃ is prepared from LiAlH₄ and AlCl₃, and is then filtered and frozen in a liquid-nitrogen-cooled trap. (cf. p. 807). An excess of anhydrous HN₃ dissolved in ether is added, and the contents of the trap are allowed to melt slowly by gradually removing the Dewar flask. The evolution of hydrogen starts at -116°C. The trap is then allowed to warm to room temperature; vacuum is applied and the ether and excess HN₃ are distilled off with renewed cooling. The product Al(N₃)₃ remains as a white powder.

PROPERTIES:

Very moisture sensitive. The compound may be shock detonated. Soluble in tetrahydrofuran.

REFERENCE:

E. Wiberg and H. Michaud, *Z. Naturforsch.* **9 b**, 495 (1954).

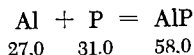
Aluminum Phosphide

1. Very pure, finely divided aluminum powder (1.8 g.) and 2.9 g. of purified, dried red phosphorus are ground together in a mortar.

The mixture is placed in a Vycor reaction tube (diameter 20 mm; a little less at the ends), one end of which is connected to a distillation flask containing additional red P, and the other end to a receiving flask. The apparatus is flushed with pure hydrogen. The distillation flask is heated in a continuous stream of H_2 until some phosphorus condenses on the aluminum-phosphorous mixture in the reaction tube. The mixture is then ignited by means of a small but extremely hot flame. The ensuing reaction is short but vigorous. When it is over, the excess P is driven into the receiving flask by heating the entire reaction tube. The tube is then cut at the site of the reaction and the AlP is ground under H_2 and stored in a closed container. The product contains 92-94% AlP.

II. A somewhat less pure product is obtained when a mixture of 27 g. of aluminum powder and 31 g. of red P is ignited with a burning magnesium strip (use safety goggles!) in an iron crucible. The crucible should not be more than half full, since the mass expands during the reaction and may overflow. In any case, the crucible should be covered with a lid. The yellowish to gray-black reaction mass is ground in a heated mortar.

PROPERTIES:

Yellowish-gray to dark, crystalline. Reacts with water to form PH_3 . Crystallizes in the zinc blende structure.

REFERENCES:

- I. W. E. White and A. H. Bushey, *J. Amer. Chem. Soc.* 66, 1666 (1944).
V. M. Goldschmidt, *Ber. dtsh. chem. Ges.* 60, 1289 (1927).
- II. Fonces-Diacon, *Compt. Rend. Hebd. Séances Acad. Sci.* 130, 1314 (1900).

Lithium Aluminum Phosphide

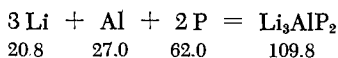

First, Li_3Al is prepared by melting together pieces of Li and Al turnings in a 3:1 atomic ratio. The melting process is carried out at 600-700°C under argon. The alloy is ground under CO_2 in an agate mortar and, as was described for AlP, placed in a Vycor tube, one end of which is connected to a distillation flask containing red P. Instead of placing the alloy in direct contact with the tube,

it is better to pour it into a boat made of sintered corundum or, preferably, ZrO_2 . The tube is heated in an atmosphere of phosphorus vapor until the reaction starts.

PROPERTIES:

Chemical behavior similar to that of AlP. Crystallizes in a rhombically distorted superstructure of the CaF_2 lattice.

The arsenide Li_3AlAs_2 may be prepared by an entirely analogous procedure; its properties are identical to those of Li_3AlP_2 .

REFERENCE:

R. Juza and W. Schulz, *Z. anorg. allg. Chem.* 269, 1 (1952).

Aluminum Orthophosphate



A concentrated sodium aluminate solution is mixed with concentrated H_3PO_4 until the solution is strongly acidic. It is then transferred into a combustion tube, and the tube is sealed and heated to $250^\circ C$ for several hours. The white, crystalline product usually contains other phosphates in addition to $AlPO_4$. These, however, can be removed because of their solubility in 1:5 aqueous HCl.

PROPERTIES:

Formula weight 121.95. M.p. above $1460^\circ C$; d ($23^\circ C$) 2.56. Very slightly soluble in concentrated HCl and HNO_3 . Isomorphous with quartz, the silicon atoms in the lattice being regularly replaced by Al and P atoms. Used for special glasses.

REFERENCES:

H. F. Hüttenlocher, *Z. Kristallogr.* 90, 509 (1935).

A. D. Schulten, *Compt. Rend. Hebd. Séances Acad. Sci.* 98, 1583 (1884).

The arsenate $AlAsO_4$ is isomorphous with $AlPO_4$. For the preparation see F. Machatschki and A. Moser, *Z. Kristallogr. (A)* 90, 314 (1935); 94, 212 (1936).

Aluminum Arsenide

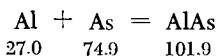

Equimolar amounts of the elements are fused together in an evacuated quartz tube at $800^\circ C$. Alternatively, the compound may

be prepared in a way similar to that described for AlP, by passing As vapors in a stream of hydrogen over finely divided aluminum powder at about 500°C.

PROPERTIES:

Slowly hydrolyzed by cold water, rapidly by hot water. M.p. above 1200°C. Crystallizes in the zinc blende structure lattice type.

The antimonide AlSb may be prepared in the same manner as AlAs, by fusing the elements in an evacuated quartz vessel.

REFERENCES:

- G. Natta and L. Passerini, *Gazz. Chim. Ital.* 58, 458 (1928).
V. M. Goldschmidt, *Skr. Akad. Oslo* 1926, No. 8, 33.

Aluminum Carbide

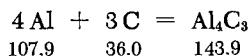

The purest available aluminum powder is mixed with the stoichiometric quantity of pure, finely divided carbon; the mixture is placed in a carbon crucible sealed with a carbon stopper and heated to 2000°C in an atmosphere of H₂. The heating is discontinued after 30 minutes. The product is orange and contains, in addition to Al₄C₃, a small amount of Al metal. The carbide is ground to a powder and the metallic impurity removed by treatment with ice-cold concentrated HCl. The excess carbon floats on the surface and may be skimmed off. The purity of the product is directly related to that of the starting material. The presence of nitrogen results in the formation of nitrogenous compounds.

The conversion may also be achieved by heating in hydrogen for three hours to 1500°C. A bright yellow, microcrystalline carbide results.

PROPERTIES:

Golden yellow, hexagonal leaflets. M.p. 2100°C, decomposes above 2200°C. Methane is evolved on hydrolysis.

REFERENCES:

- O. Ruff and K. Jellinek, *Z. anorg. allg. Chem.* 97, 316 (1916).
M. von Stackelberg et al., *Z. phys. Chem. (A)* 175, 127, 140 (1936).
L. Wöhler and K. Hofer, *Z. anorg. allg. Chem.* 213, 249 (1933).
E. J. Kohlmeyer and S. Lundquist, *Z. anorg. Chem.* 260, 208 (1949).

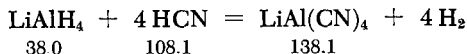
Lithium Aluminum Cyanide

Anhydrous HCN is condensed in vacuum onto a frozen ether solution of LiAlH_4 and the mixture is allowed to melt slowly. The theoretical amount of H_2 is evolved and LiAl(CN)_4 precipitates. If an excess of HCN is used, it may be removed by evacuation, together with the ether. The LiAl(CN)_4 residue is a white powder.

PROPERTIES:

Hydrolyzes readily. Decomposes after some time even in the absence of oxygen and moisture.

Aluminum cyanide Al(CN)_3 may be prepared in a similar manner, by condensing anhydrous HCN onto a freshly prepared ether solution of monomeric AlH_3 . The product precipitates out with one mole of ether of crystallization. It may be stored for some time in the absence of oxygen and moisture.

REFERENCE:

G. Wittig and H. Bille, *Z. Naturforsch.* **6 b**, 226 (1951).

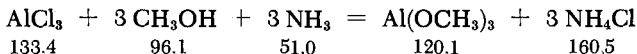
Aluminum Methoxide

A 45-g. portion of freshly sublimed AlCl_3 is dissolved at 0°C in 750 ml. of anhydrous methanol. The solution is allowed to warm up to 5°C and an excess of dry NH_3 is slowly bubbled through the flask. The $\text{Al(OCH}_3)_3$ precipitate is suction-filtered, washed with methanol and dried over P_2O_5 .

REFERENCE:

S. Teichner, *Compt. Rend. Hebd. Séances Acad. Sci.* **237**, 810 (1953).

Aluminum Ethoxide

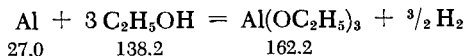

I. Aluminum turnings (27 parts) are covered in a round-bottom flask with 276 parts of anhydrous ethanol. Then HgCl_2 (0.2 part) and a trace of iodine are added to start the reaction. The evolution of hydrogen usually begins after a few seconds. If it fails to occur, the flask may be carefully heated on a water bath. If necessary, the aluminum should be slightly etched with dilute NaOH before use and then rinsed with alcohol.

When the reaction slows down, the flask is heated on the water bath for several hours, until the contents become dry and leafy. The excess alcohol is distilled off on an oil bath at $210\text{--}220^\circ\text{C}$, and the hot, liquid residue is quickly poured into a Claisen flask with a wide, short air condenser. The ethoxide is distilled at 10 mm. and $210\text{--}220^\circ\text{C}$. After a short time, the distillate solidifies to a snow-white mass, which is stored in a well-closed container. The yield is 90%.

II. A 100-g. portion of aluminum turnings is covered with 650 ml. of xylene in a flask equipped with a reflux condenser and a dropping funnel, and the mixture is heated to the boiling point of xylene. Absolute ethanol (440 ml.), containing 0.5 g. of $\text{K}_2\text{Cr}_2\text{O}_7$ and a trace of iodine, is added dropwise. The reaction starts immediately, and the heat source may soon be removed. When 320 ml. of ethanol has been added, the reaction slows down and heating is again required. The addition of the alcohol should take about $1\frac{3}{4}$ hours. Heating is continued somewhat longer, and the mixture is filtered hot through a heated fluted filter. The xylene is completely removed from the filtrate, first by distillation and finally under vacuum. About 400 g. of pure, colorless aluminum ethoxide is left in the flask.

PROPERTIES:

M.p. 130°C , b.p. $210\text{--}220^\circ\text{C}$ (10 mm.). Slightly soluble in hot xylene, chlorobenzene and other high-boiling solvents.

REFERENCES:

- I. German patent 286,596.
- II. H. Meerwein and R. Schmidt, *Liebigs Ann. Chem.* **444**, 232 (1925).

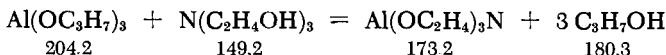
Aluminum Triethanolamine

Aluminum isopropoxide is fused at 150-160°C with an equimolar quantity of triethanolamine. The solidified melt is recrystallized from dioxane, yielding an adduct of $\text{Al}(\text{OC}_2\text{H}_4)_3\text{N}$ containing one mole of dioxane. Then the adduct is heated for a considerable time at 140°C, dioxane splits off and the solvent-free product is obtained.

PROPERTIES:

Cubic crystals hydrolyzed by water. Soluble in chloroform, benzene and other solvents. Sublimes at above 280°C (13 mm.).

REFERENCE:

F. Hein and P. W. Albert, *Z. anorg. allg. Chem.* **269**, 67 (1952).

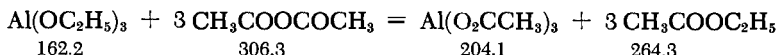
Aluminum Acetate

A 2.81-g. portion of Al ethylate is placed in a small flask equipped with reflux condenser and 15 ml. of acetic anhydride is dropped in. The reaction requires heat. The flask is then heated in an oil bath at 150-160°C for another five hours. After the mixture has cooled, a white product precipitates and is then decanted from the liquid phase. The solid residue is dried at 5 mm. and 100°C for about three hours. The yield is 3.4 g.

PROPERTIES:

Insoluble in benzene. Soluble in water, hydrolyzing to form a gellike precipitate.

REFERENCE:

K. C. Pande and R. C. Mehrotra, *Z. anorg. allg. Chem.* **286**, 291 (1956).

Aluminum Acetylacetonate

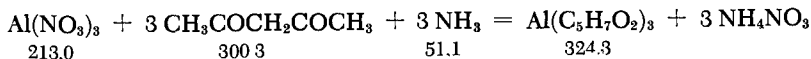

I. A small excess of acetylacetone is added to an aqueous solution of $\text{Al}(\text{NO}_3)_3$. Then a dilute solution of NH_4OH is added very slowly. This procedure gives pure Al acetylacetonate in quantitative yield.

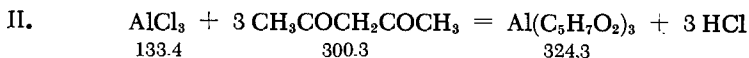

Anhydrous AlCl_3 is dissolved in chloroform, and a slight excess of acetylacetone is added.

PROPERTIES:

Brilliant plaques or prisms, similar to mother of pearl. M.p. 192-194°C. Sublimes at 140°C (10 mm.). d (20°C) 1.27. Decomposes when heated in air. Insoluble in water; slightly soluble in alcohol, ether and benzene. Can be recrystallized from acetone.

REFERENCE:

G. T. Morgan and H. D. Drew, J. Chem. Soc. (London) 119, 1060 (1921).

Gallium, Indium, Thallium

E. DÖNGES

Gallium**Ga**

ELECTROLYTIC SEPARATION OF GALLIUM

In the method of Sebba and Pugh, the electrolysis vessel is a 250-ml. beaker. The inside wall of the beaker is lined with a piece of Pt foil 20 cm. long and 3 cm. wide. This serves as the anode. The cathode consists of a thick sheet of Pt, 1.5 cm. wide and 3 cm. long. Its lower edge is wedge shaped and is sealed into the lower end of a glass U tube (Fig. 247a). This seal point is enlarged to a cuplike shape. The cathode is sealed into the U tube in such a fashion that the connection to the conducting Pt wire is just inside the glass-metal seal. (If the wire were to extend beyond this seal, it would rapidly corrode at the point where it comes in contact with the solution. If the apparatus is arranged as indicated, no corrosion can be observed even after several hundred hours of operation.) The other end of the Pt wire dips into a Hg pool which, in turn, is connected to the power supply by another lead wire.

The "cup" formed at the electrode end of the U tube is 3 cm. in diameter and very shallow; nevertheless, it can hold more than 10 g. of molten Ga. As a result of the heat produced by the high resistance of the cell, the Ga separates as the liquid. Because the Ga is in contact with the cathode during operation, it is also cathodic. Hence it can be readily washed, dried and weighed directly in the cup. This arrangement therefore permits quantitative work.

Before loading the cell the Ga is first precipitated as the hydroxide, using no more than the equivalent of 10 g. of the metal. It is then dissolved in the minimum volume of concentrated NaOH and diluted with H₂O to 150 ml. With a current of 1 amp. (3-4 v.), 6 g. (of the 10) is obtained during the first 24 hours; in the next 24 hours 3.5 g. more separates. The remaining 0.5 g. separates so slowly, however, that it is expedient to precipitate it with sodium hydroxide and to use it in the next electrolysis.

Brauer was also able to obtain good results with a simpler cathode arrangement, shown in Fig. 247 b, when the amount of Ga to be separated exceeds 10 g. In some cases aluminum is an impurity and becomes appreciably concentrated in that portion of the Ga which has not been separated by electrolysis. The two are separated by precipitation with cupferron; the precipitate is ashed and converted to the hydroxide by fusion with NaOH.

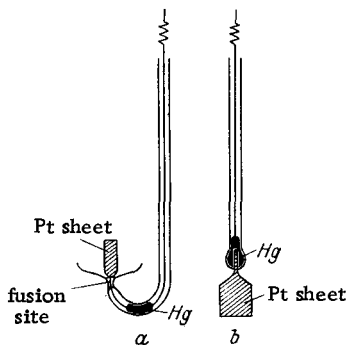

Fig. 247. Cathodes for electrolytic separation of gallium. *a*) according to Sebba and Pugh; *b*) simple arrangement, which has been used successfully in the University of Freiburg Laboratory.

Residual Ga still adhering to the cathode is removed by rinsing down with warm, dilute hydrochloric acid. The Ga immediately forms tiny spheres, which are readily wiped off.

The separated Ga contains traces of Pt. These can be removed, along with any traces of Pb and Sn which may be present, by the following method: Ga is melted under a layer of water and an equal volume of concentrated hydrochloric acid

added. After the metal has been swirled five minutes underneath the acid, the latter is carefully washed out and some concentrated nitric acid is added. The reaction is vigorous at first and the metal is converted to tiny spheres. The acid is diluted with water after a few minutes and carefully washed out after another 10 minutes. The Ga acquires its metallic luster again on renewed washing with dilute hydrochloric acid (probably because of destruction of a surface oxide film), and the tiny spheres coalesce.

About 5% of the Ga dissolves during purification. Although a mixture of hydrochloric and nitric acids (aqua regia) is not used, the Ga is spectroscopically free of Pt (and also of Pb and Sn) after the treatment.

Gallium can also be recovered from weakly acidic solutions via the method suggested by the Electronics Services Research Laboratory. Thus, GaCl_3 is dissolved in distilled water and electrolyzed in a quartz vessel between a Pt anode and a Ta cathode. The gallium separates at the cathode and sinks to the bottom of the vessel. It is separated, washed, and dried.

PROPERTIES:

Atomic weight 69.72. Lead-gray metal with bluish luster. The melt has a silvery-white luster and a marked tendency to supercool,

but solidifies on seeding with solid Ga or a piece of Dry Ice. Stable in air. M.p. 29.78°C, b.p. 2064°C; d 5.90; d (liq., 30°C) 6.09. Crystal type A 11. Hardness 1.5.

REFERENCES:

- F. Sebba and W. Pugh, J. Chem. Soc. (London) 1937, 1373.
L. Moser and A. Brukl, Monatsh. Chem. 51, 325 (1929).
G. Brauer, private communication (1950).
Chem. Eng. News 34, 2887 (1956).

DISSOLVING OF METALLIC GALLIUM IN ACIDS

Gallium is only slightly more noble than Zn. However, it dissolves in mineral acids slowly due to surface passivity phenomena. Hot, concentrated nitric acid is the most effective, dissolving 5 g. of Ga in 10 hours. Sebba and Pugh report achieving rapid solution of Ga in concentrated nitric acid if the metal, which disperses in tiny spheres due to the action of hot acid, is alternately cooled to a powdery acid-metal mixture and then reheated.

GALLIUM (III) PERCHLORATE $\text{Ga}(\text{ClO}_4)_3 \cdot 6\text{H}_2\text{O}$

Foster claims that concentrated perchloric acid (especially when mixed with concentrated sulfuric acid) dissolves Ga significantly more rapidly than concentrated nitric acid: 5 g. of Ga, heated in 60 ml. of 72% HClO_4 , dissolves within an hour.

The resulting $\text{Ga}(\text{ClO}_4)_3 \cdot 6\text{H}_2\text{O}$ separates almost completely on cooling and in such large crystals that it can readily be isolated on a fritted glass filter. The damp crystals should not come in contact with organic materials (e.g., filter paper) since the concentration of the adhering perchloric acid is greater than 72% due to the loss of water in the form of the hexahydrate.

The crystals are vacuum-dried for one hour at 125°C.

PROPERTIES:

Formula weight 476.19. Very readily soluble in water and alcohol; deliquesces in the air. Decomposition begins at 175°C at atmospheric pressure and at 155°C in vacuum. Crystallizes slowly as large octahedra.

REFERENCES:

- F. Sebba and W. Pugh, J. Chem. Soc. (London) 1937, 1373.
L. S. Foster, J. Amer. Chem. Soc. 61, 3122 (1933).

Trimethylgallium, Tetramethyldigallane, Digallane

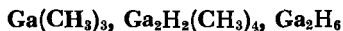

Wiberg and Johannsen state that Ga_2H_6 is formed by the reaction of triethylamine and tetramethyldigallane; the latter is formed by electrical glow discharge in a mixture of H_2 and gallium trimethyl.

The work was carried out in a Stock high-vacuum apparatus (see Part I, p. 66) because of the sensitivity of these compounds to air, moisture, and stopcock grease. The apparatus was constructed according to Wiberg and Sütterlin's directions; however, each trap was also connected to the large diameter pump manifold via a Stock valve so that an optimum vacuum could be maintained by the pump during the transport of material.

The fractionation was carried out in a Clusius and Riccoboni apparatus (see also Part I, p. 70), which was incorporated in the high-vacuum system; this apparatus has been simplified by Clusius so that the vapor stream flows through an adjustable ceramic cone valve into the condensation trap.

A) TRIMETHYL GALLIUM

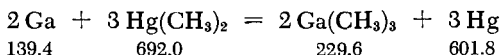

In the method of Wiberg, Johannsen and Stecher, improved by Coates, 6.75 g. of metallic Ga and 37 g. of $\text{Hg}(\text{CH}_3)_2$ are heated to boiling at atmospheric pressure in the presence of a trace of HgCl_2 . A flask with a fused-on 20-cm. fractionating column is used and dry nitrogen is passed through. The column head temperature begins to drop below 92°C [b.p. of $\text{Hg}(\text{CH}_3)_2$] after two hours and remains at $55\text{--}56^\circ\text{C}$ [b.p. of $\text{Ga}(\text{CH}_3)_3$] after five hours. Small quantities of pure $\text{Ga}(\text{CH}_3)_3$ are withdrawn from time to time at the column head over a three-day period, until a residue of about 1 ml. [chiefly $\text{Ga}(\text{CH}_3)_3$] remains along with the Hg formed. Conversion proceeds almost quantitatively and without decomposition.

The $\text{Ga}(\text{CH}_3)_3$ distillate is frozen and transferred under nitrogen to a vacuum apparatus where it can be kept under its own vapor pressure until further use.

PROPERTIES:

Formula weight 114.82. M.p. -15.8°C , b.p. (762 mm.) 55.7 ; vapor pressure (0°C) 64.5 mm. Very sensitive to oxygen.

B) TETRAMETHYL DIGALLANE

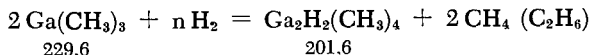

The principle of the experimental electrolyte- H_2 cell was developed by Stock and Sütterlin and further improved by Wiberg and Johannsen and Wiberg and Stecher. The system is saturated with $\text{Ga}(\text{CH}_3)_3$ at 760 mm. and -44°C [the $\text{H}_2:\text{Ga}(\text{CH}_3)_3$ ratio is then 200:1], placed in an ice-cooled cell, and subjected to a 3.4-ma. glow discharge at a cell pressure of 12.2 mm. The hydrogen is freed of O_2 traces by passage over platinized asbestos at 300°C and the resulting moisture removed by freezing out.

The $\text{Ga}_2\text{H}_2(\text{CH}_3)_4$ formed is frozen out of the H_2 stream at liquid nitrogen temperature. It is freed of unreacted $\text{Ga}(\text{CH}_3)_3$ (condensing at -80°C) and byproduct hydrocarbons (condensing at -196°C) by fractionation at room temperature and condensation at -30°C .

The yield is 60-70%.

PROPERTIES:

Colorless, highly viscous, relatively nonvolatile liquid; solidifies to a glass and softens without any well-defined m.p. Decomposes above 130°C into $\text{Ga}(\text{CH}_3)_3$, Ga and H_2 . Calculated b.p. 172°C . Vapor pressure (0°C) 0.5 mm.; (20°C) 2 mm.; (95°C) 64 mm. Very sensitive to O_2 , moisture and stopcock grease.

C) DIGALLANE

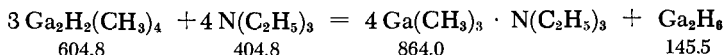

In the method of Wiberg and Johannsen, 235.1 mg. of tetramethyldigallane and 157.5 mg. of triethylamine, which has been completely dried over pieces of Na and then fractionated, are condensed (3:4 mole ratio) in a cold trap. The trap is sealed and the contents are allowed to thaw. Gentle heating results in conversion to a trimethylgallium-triethylamine adduct and digallane. The reaction products are separated by fractionation at room temperature, in which $\text{Ga}(\text{CH}_3)_3 \cdot \text{N}(\text{C}_2\text{H}_5)_3$ (vapor pressure 0.04 mm. at 0°C , m.p. 96°C , b.p. 167°C) is condensed at -10°C and Ga_2H_6 at -196°C .

The yield is 56.5 mg. (theoretical: 56.8 mg.).

PROPERTIES:

Colorless, very mobile liquid. M.p. -21.4°C , vapor pressure (0°C) 2.5 mm.; (54°C) 49.1 mm. Calc. b.p. 139°C , but begins to decompose at 130°C to Ga and H_2 .

REFERENCES:

- E. Wiberg and T. Johannsen, *Die Chemie* 55, 38 (1942).
 T. Johannsen, Thesis, Munich, 1941.
 G. E. Coates, *J. Chem. Soc. (London)* 1951, 2011.
 A. Stock, *Ber. dtsh. chem. Ges. A* 54, 142 (1921); see also Part I, this book, p. 66.
 E. Wiberg and W. Sütterlin, *Z. anorg. allg. Chem.* 202, 1 (1931).
 K. Clusius and L. Riccoboni, *Z. phys. Chem. (B)* 38, 81 (1938).
 A. Stock, *Z. Elektrochem.* 39, 256 (1933).
 E. Wiberg, T. Johannsen and O. Stecher, *Z. anorg. allg. Chem.* 251, 114 (1943).
 E. Wiberg and O. Stecher, private communication.
 A. Stock and W. Sütterlin, *Ber. dtsh. chem. Ges.* 67, 407 (1934); see also E. Wiberg and M. Schmidt, *Z. Naturforsch.* 7 b, 577 (1952).

Lithium Tetrahydrogallate

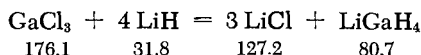

Finholt, Bond and Schlesinger report that LiGaH_4 can be prepared in the same manner as LiAlH_4 (see p. 805). A ground joint flask with a curved tube fused on is used. The flask is charged with 470 mg. of LiH (fourfold excess) and is connected to a Stock high-vacuum system by means of a ball joint, which permits the flask to be moved. Then 599 mg. of anhydrous GaCl_3 is sublimed into the reaction flask and about 5 ml. of dry ether condensed on top of it by cooling the flask in liquid nitrogen. The ether is slowly heated until the GaCl_3 dissolves in it. Then the contents are cooled to -80°C .

Lithium hydride is then added slowly to the ether from the side arm by carefully turning the ball joint. After the initial vigorous reaction has subsided, the flask is allowed to warm gradually to room temperature. Wiberg and Schmidt report a quantitative yield if the ether solution is refluxed for 1.5 hours on a water bath (35°C) after the exothermic reaction stage is over. The ether solution of LiGaH_4 is finally forced through a glass frit with dry, CO_2 -free N_2 and separated from excess LiH and precipitated LiCl. Vacuum distillation of the ether at room temperature leaves a white residue of LiGaH_4 .

The final product is analyzed by hydrolysis and measuring the liberated H_2 ; Ga is determined as the hydroxyquinolate. The

yield is 76%, the purity 93%. The yield depends chiefly on the extent to which the LiCl is washed out, and the purity on the extent to which the ether is removed.

Heating decomposes LiGaH_4 to Ga and probably LiH and H_2 .

REFERENCES:

- A. E. Finholt, A. C. Bond, Jr. and H. J. Schlesinger, *J. Amer. Chem. Soc.* **69**, 1199 (1947); see also E. Wiberg and M. Schmidt, *Z. Naturforsch.* **6 b**, 171 (1951); **7 b**, 576 (1952).

Gallium(III) Chloride

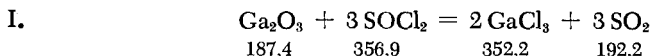

A mixture of 2.5 g. of ignited Ga_2O_3 and about 8 ml. of SOCl_2 (two- to threefold excess) is heated several hours at 200°C in a sealed tube, according to Hecht, Jander and Schlapmann. Complete chlorination of the Ga_2O_3 occurs. The tube is precooled to -10°C before opening, to reduce the positive pressure generated by the SO_2 formed. The SO_2 is allowed to evaporate at room temperature, excess SOCl_2 is distilled off (b.p. 75.7°C), and GaCl_3 is distilled at 220°C .

Fischer and Jübermann state that GaCl_3 can be obtained completely pure by vacuum sublimation in quartz equipment.

II. Klemm and Tilk obtained GaCl_3 by heating Ga_2O_3 in a stream of Cl_2 and CCl_4 ; Cl_2 alone did not react appreciably with Ga_2O_3 up to 800°C .

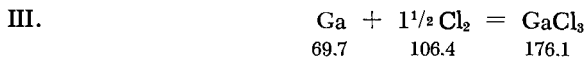

Richards, Craig and Sameshima report formation of GaCl_3 by burning metallic Ga in a stream of Cl_2 . Spectroscopically pure GaCl_3 may be obtained by repeated fractional evaporation in a stream of Cl_2 and N_2 and finally in vacuum.

The following method was developed by the Electronic Services Research Laboratory for preparation of spectroscopically pure GaCl_3 . Chlorine, mixed with N_2 carrier gas, is bubbled through molten commercial Ga. The resultant GaCl_3 is distilled into a Pyrex tube (e.g., 25 cm. long, 2.5 cm. in diameter) under a N_2 protective atmosphere. The tube is sealed when half full and the GaCl_3 subjected to zone melting. If the starting Ga

contains 10–70 mg./kg. of impurities, after 20 passes all impurities are concentrated in one quarter of the preparation. The rest (three quarters) of the ingot so treated consists of a clear, crystalline mass, in which no impurities can be detected by spectroscopic methods. The other quarter, containing the impurities, is unmistakable because of its color and may readily be cut off. The Ga contained in it is recovered by electrolysis (see p. 837).

IV. Heyne claims GaCl_3 is best prepared by heating metallic Ga at 200–400°C in a stream of dry HCl followed by distillation.

PROPERTIES:

Colorless, needle-shaped, very hygroscopic crystals; fumes and deliquesces in air. M.p. 77.9°C, b.p. 201.3°C; d 2.47. Dissolves in water, evolving large quantities of heat. Very readily soluble in ether; shaking a 5.5N HCl (optimum) GaCl_3 solution with the same volume of ether (repeatedly preextracted with 5.5N HCl) extracts 98% of the GaCl_3 (partition coefficient = 75; see Fig. 248) [E. H. Swift, J. Amer. Chem. Soc. 46, 2375 (1924)].

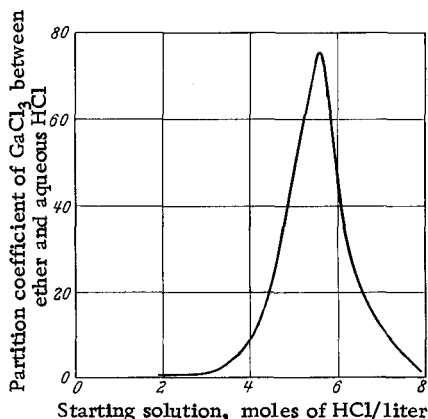

Fig. 248. Partition of Ga(III) chloride between ether and aqueous phase as a function of the HCl concentration in the starting solution.

W. Fischer and S. Lauter [German Patent 801,986 (1949)] claim that other ethers, such as diisopropyl and diisobutyl, are better suited than diethyl ether for the selective extraction from aqueous hydrochloric acid, due to their lower water solubility. Also, their losses would seem to be substantially lower because of their lower solubility, especially in recycle operations. Fischer and Lauter

further demonstrated that optimum conditions for the aqueous phase depend chiefly on the chloride ion concentration, rather than on the HCl concentration, and that therefore a considerable portion of the HCl may be replaced by an equivalent quantity of readily soluble metal chloride.

REFERENCES:

- I. H. Hecht, G. Jander and H. Schlapmann, *Z. anorg. allg. Chem.* 254, 255 (1947).
W. Fischer and O. Jübermann, *Z. anorg. allg. Chem.* 227, 227 (1936).
- II. W. Klemm and W. Tilk, *Z. anorg. allg. Chem.* 207, 161 (1932).
- III. T. W. Richards, W. M. Craig and J. Sameshima, *Proc. Nat. Acad. Sci. Washington* 4, 387 (1918); *Chem. Eng. News* 34, 2887 (1956).
- IV. G. Heyne, Thesis, Rostock, 1935.

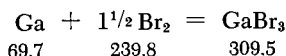
Gallium(III) Bromide

Metallic Ga is heated in a stream of N_2 or CO_2 laden with Br_2 vapor, according to Klemm and Tilk's method. A water-clear melt forms first, becoming yellow to red-brown, due to dissolved Br_2 , when all the Ga has reacted. When the bromination is complete, the GaBr_3 is distilled in an inert, Br_2 -free gas stream into a receiver and thus simultaneously freed of dissolved Br_2 .

Fischer and Jübermann prepared very pure GaBr_3 by vacuum sublimation in quartz equipment.

PROPERTIES:

Colorless, very hygroscopic crystals. M.p. 121.5°C , b.p. 279°C ; d 3.69.

REFERENCES:

- W. Klemm and W. Tilk, *Z. anorg. allg. Chem.* 207, 161 (1932).
W. Fischer and O. Jübermann, *Z. anorg. Chem.* 227, 227 (1936).

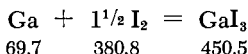
Gallium(III) Iodide

Gallium iodide is prepared by Klemm and Tilk's method in the apparatus shown in Fig. 249. Metallic Ga is placed in the center section of the tube and the stoichiometric quantity of I_2 in the right side flask. After evacuation and sealing at α , I_2 is sublimed back and forth over the Ga, heated to the reaction temperature, until the conversion is complete. The gallium reacts with a clear luminous flame.

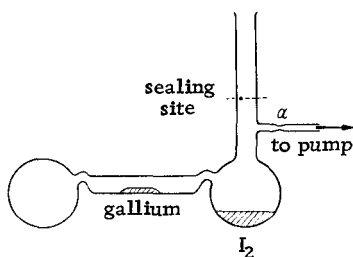

Fig. 249. Preparation of gallium(III) iodide.

orange-brown. M.p. 212°C , b.p. 346°C ; d 4.15.

The iodide is purified by Fischer and Jübermann's method in which it is volatilized in vacuum, using quartz equipment.

PROPERTIES:

Pale yellow, hygroscopic crystals, fuming in air. The melt is

REFERENCES:

- W. Klemm and W. Tilk, *Z. anorg. allg. Chem.* 207, 161 (1932).
 W. Fischer and O. Jübermann, *Z. anorg. allg. Chem.* 227, 227 (1936).
 I. D. Corbett and R. K. McMullan, *J. Amer. Chem. Soc.* 77, 4217 (1955).

Gallium (II) Chloride and Gallium (II) Bromide

GALLIUM (II) CHLORIDE

The compound is prepared according to Miescher and Wehrli, by passing dry HCl over metallic Ga which is gently heated in a Pyrex tube. Partial formation of highly volatile GaCl_3 results. Heating the reaction product with excess Ga metal in a fused, evacuated Pyrex tube gives pure GaCl_2 .

Some Ga readily separates on resublimation, due to partial decomposition of GaCl_2 into GaCl_3 and Ga.

PROPERTIES:

Formula weight 140.63. M. p. 170°C . Disproportionates to GaCl_3 and Ga above 200°C .

GALLIUM (II) BROMIDE

Miescher and Wehrli report preparation of GaBr_2 , in a method identical to that used for GaCl_2 , but employing a stream of dry CO_2 saturated with Br_2 instead of HCl.

REFERENCE:

E. Miescher and M. Wehrli, *Helv. Phys. Acta* 7, 331 (1934).

Gallium Hydroxide



GALLIUM HYDROXIDE

Laubengayer and Engle state that crystalline $\text{Ga}(\text{OH})_3$ can be prepared as follows: a GaCl_3 solution is precipitated at 90°C with NH_3 solution, and the hydroxide is washed thoroughly and heated with 6 ml. of water in a 15-ml. autoclave for about 89 hours at about 167°C . This results in a very fine powder with a moisture content corresponding roughly to that for the trihydroxide and a characteristic, metastable structure, which slowly converts on heating (e.g., a total of 166 hours at 170°C) to the diaspore structure of the metahydroxide $\text{GaO}(\text{OH})$ (see below).

PROPERTIES:

Formula weight 120.74. The crystalline form is soluble in dilute mineral acids.

GALLIUM METAHYDROXIDE

The compound $\text{GaO}(\text{OH})$, with a diaspore structure, is obtained in slow precipitation of a sodium gallate solution by atmospheric CO_2 , according to Böhm and Kahan.

Milligan and Weiser add just sufficient NH_3 solution to a GaCl_3 solution to redissolve the precipitated hydrated oxide and

allow the solution to stand in a desiccator over concentrated H_2SO_4 . In about two weeks almost all the Ga precipitates as the crystalline metahydroxide. It is washed free of Cl^- ions by decantation and dried at room temperature.

A hydrated gallium oxide, precipitated at 30–40°C (or at 90°C) with NH_3 solution by Laubengayer and Engle's method, is washed free of foreign ions and heated with 6 ml. of water in a 15-ml. autoclave for about 100 hours (or even longer) at 110–300°C; this yields the metahydroxide as small but well-defined crystals which can be dried at 105°C without decomposition.

Crystalline $Ga(OH)_3$ may appear as a metastable intermediate at about 170°C (see above).

PROPERTIES:

Formula weight 102.73. The crystalline form dissolves in dilute mineral acids. Diaspore structure (EO_2 structure type). Heating in an autoclave above 305°C converts it to β - Ga_2O_3 .

REFERENCES:

- A. W. Laubengayer and H. R. Engle, *J. Amer. Chem. Soc.* **61**, 1210 (1939).
 J. Böhm and G. Kahan, *Z. anorg. allg. Chem.* **238**, 350 (1938).
 W. O. Milligan and H. B. Weiser, *J. Amer. Chem. Soc.* **59**, 1670 (1937); see also R. Roy, V. G. Hill and E. F. Osborn, *J. Amer. Chem. Soc.* **74**, 719 (1952).

Gallium(III) Oxide

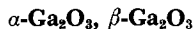

α -GALLIUM (III) OXIDE

A hot, concentrated solution of $NaHCO_3$ is added to a hot $GaCl_3$ solution, according to the methods of Goldschmidt, Barthand Lunde and Laubengayer and Engle. It is then boiled until precipitation of hydrated gallium oxide is complete. The initially gelatinous precipitate is washed free of Cl^- ions with hot water, which causes some deterioration.

The product is air-dried one hour at room temperature and then heated to 425°C in a Pt crucible. Over a period of 24 hours, the hydrated oxide crystallizes and can simultaneously lose its water to such an extent that it finally constitutes only about 1.5–4% of the material; however, it often crystallizes rather poorly and still contains about 20% water even after heating for two weeks.

Complete thermal dehydration of α -Ga₂O₃ is impossible, since the required temperatures convert it to β -Ga₂O₃.

PROPERTIES:

Formula weight 187.44. Very slightly soluble in water, slowly reacts with dilute mineral acids. Corundum structure (D51 type). Heating at 600°C in air produces slow monotropic conversion to β -Ga₂O₃. On heating in an autoclave under water vapor above 305°C converts to β -Ga₂O₃, below 305°C, to GaO(OH) (see above). d 6.44.

β -GALLIUM (III) OXIDE

Klemm and Von Vogel claim that heating in air to temperatures of at least 1000-1250°C is necessary to convert washed hydrated oxide to completely anhydrous, well-crystallized β -Ga₂O₃.

Laubengayer and Engle state that completely anhydrous β -Ga₂O₃ can be prepared by autoclave heating of hydrated gallium oxide under water vapor for 74 hours at 420°C.

PROPERTIES:

M.p. 1740°C. Insoluble in dilute and concentrated mineral acids. Monoclinic or rhombic crystals. d 5.88.

REFERENCES:

- V. M. Goldschmidt, T. Barth and G. Lunde, Skr. Akad. Oslo 1925, No. 7, 24.
 A. W. Laubengayer and H. R. Engle, J. Amer. Chem. Soc. 61, 1210 (1939).
 W. Klemm and H. U. von Vogel, Z. anorg. allg. Chem. 219, 45 (1934); see also R. Roy, V. G. Hill and E. F. Osborn, J. Amer. Chem. Soc. 74, 719 (1952).

Gallium(I) Oxide

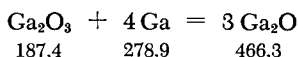

A sample of Ga₂O₃ is triturated with excess fused Ga. The mixture is placed in a corundum boat and heated under vacuum in a quartz apparatus provided with a cold finger, according to the

method of Brukl and Ortner and Klemm and Von Vogel. A trap cooled with Dry Ice must be inserted between pump and apparatus to prevent Hg from condensing on the condenser. Slow heating is necessary to avoid sudden Ga_2O sublimation (which begins at 500°C) and consequent bumping of part of the Ga_2O_3 -Ga mixture into the condenser.

Klemm and Schnick report that only after repeated vacuum distillation over excess metallic Ga does the product acquire the oxygen content calculated for Ga_2O .

PROPERTIES:

Formula weight 155.44. Brown-black powder. Noticeable volatilization at 600°C in an inert gas stream at 1 atm. and at 500°C in high vacuum. Stable in dry air. Decomposes in vacuum at 700°C to Ga_2O_3 and Ga.

REFERENCES:

- A. Brukl and G. Ortner, *Z. anorg. allg. Chem.* **203**, 23 (1931).
 W. Klemm and H. U. von Vogel, *Z. anorg. allg. Chem.* **219**, 45 (1934).
 W. Klemm and J. Schnick, *Z. anorg. allg. Chem.* **226**, 353 (1936).

Gallium(III) Sulfide



Sulfur vapor is passed over metallic Ga heated to 1200 - 1300°C in a stream of N_2 , according to Brukl and Ortner's method; the Ga is converted to yellow Ga_2S_3 . The sulfur is passed twice to ensure complete reaction, the product being powdered between passes.

Hahn and Klingler believe that the direct synthesis of Ga_2S_3 is simpler with the apparatus of Klemm and Vogel (preparation of GaS; see below). The reaction temperature is 1250°C in that case.

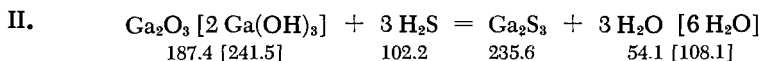

In Klemm and Vogel's method, Ga_2O_3 is heated in a stream of H_2S (purified by liquefaction with CO_2) for 14 hours at 600 - 700°C and finally for four hours at 1200°C . Faintly yellow Ga_2S_3 is obtained, the color depending on the particle size.

Hahn and Klingler state that Ga_2S_3 is prepared more rapidly and at lower temperatures by starting with $\text{Ga}(\text{OH})_3$ dried at 150°C instead of Ga_2O_3 . Heating for about 12 hours below 550°C gives $\alpha\text{-Ga}_2\text{S}_3$ with zinc blende structure (B3 structure type), the high-temperature modification, $\beta\text{-Ga}_2\text{S}_3$ with wurtzite structure (B4 structure type), being formed at 600°C . The stable modification, a wurtzite superstructure with ordered distribution of metal atoms, forms after heating several days above 1000°C .

PROPERTIES:

M.p. (in vacuum) 1255°C . Slow decomposition in air with evolution of H_2S . d (x-ray) α form 3.747, β form 3.676. Transition temperature $550\text{--}600^\circ\text{C}$.

REFERENCES:

- A. Brukl and G. Ortner, *Naturwiss.* 18, 393 (1930).
Monatsh. Chem. 56, 358 (1930).
 H. Hahn and W. Klingler, *Z. anorg. Chem.* 259, 135 (1949).
 W. Klemm and H. U. von Vogel, *Z. anorg. allg. Chem.* 219, 45 (1934).
 W. Klemm, K. Meisel and H. U. von Vogel, *Z. anorg. allg. Chem.* 190, 136 (1930).
 H. Hahn and W. Klingler, *Z. anorg. allg. Chem.* 278, 333 (1955).
 H. Spandau and F. Klanberg, *Z. anorg. allg. Chem.* 295, 300 (1958).

Gallium(II) Sulfide

GaS

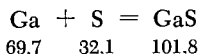

Some Ga is weighed into an 8-mm. quartz tube sealed at one end, and the tube is drawn out to a width of 2 mm. at a distance 5 cm. from the lower end and bent at a right angle, as described by Klemm and Von Vogel. The stoichiometric amount of S for the formation of GaS is placed in the open-end section and the tube sealed under vacuum.

The side containing the S is then heated so as to fill the whole tube with vapor. The Ga on the other side must be heated to reaction temperature with a blast burner, some O_2 being added toward the end of the reaction to raise the temperature.

When the sulfur has reacted completely, the Ga section, which now contains GaS, is cooled with water to condense the balance

of the S. The reaction tube is then melted off at the bend and GaS heated for half an hour in a crucible furnace at 1100°C to complete the reaction. The GaS is readily removed after opening the tube.

PROPERTIES:

Yellow, leafy material. Stable to water. Can be sublimed at 900–950°C in high vacuum to hexagonal prisms; m.p. 965°C. Hexagonal layer lattice. d (x-ray) 3.916.

REFERENCES:

W. Klemm and H. U. von Vogel, *Z. anorg. allg. Chem.* 219, 45 (1934).

H. Hahn and G. Frank, *Z. anorg. allg. Chem.* 278, 340 (1955).

H. Spandau and F. Klanberg, *Z. anorg. allg. Chem.* 295, 300 (1958).

Gallium(II) Sulfide



Direct synthesis from Ga and S is impossible. Thus, excess fused Ga is triturated with GaS, mixed with Ga_2S_3 to promote better wetting, according to the method of Klemm and Von Vogel, developed by Brukl and Ortner. The mixture is placed in a corundum boat inserted in a quartz apparatus, equipped with a cold finger, in high vacuum. The boat contents are heated to 700–720°C. If these temperatures are exceeded, the sublimed Ga_2S has too low a sulfur content.

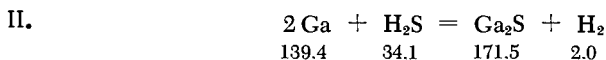

According to Gastinger, Ga_2S is obtained by heating metallic Ga at reduced pressure (10 mm.) to 1000–1200°C in a stream of H_2S . Figure 250 shows the apparatus developed for this purpose.

Reaction tube r (40–50 mm. in diameter), condenser k and boat carrier st , as well as the diffusion unit d/k , are made of quartz. The apparatus is first filled with argon at Ar, with stopcocks h_1 , and h_5 and h_7 closed and all others open. After the tubular furnace ro is adjusted to the prescribed temperature, boat carrier st is pulled out, and boat s carrying the Ga is placed on it and inserted into the furnace, through which the stream of Ar is passing.

Stopcocks h_2 , h_8 and h_3 are then closed, H_2S introduced through h_7 , and the unit connected to a vacuum pump by opening h_1 . The

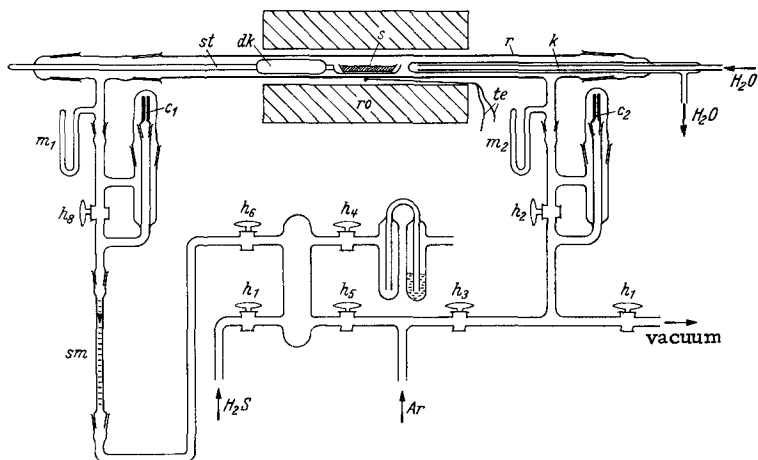

Fig. 250. Apparatus for preparation of Ga_2S_3 by heating metallic Ga in a stream of H_2S .

pressure and rate of the H_2S stream can be adjusted by suitable choice of capillaries c_1 and c_2 . Manometers m_1 and m_2 and flow meter sm serve to check these process parameters. The diffusion unit dk depresses back-diffusion of Ga_2S_3 so that it precipitates only at the water-cooled condenser k .

When reaction is complete, the apparatus is refilled with Ar by closing stopcocks h_7 and h_1 and opening h_5 , and condenser k with its precipitated Ga_2S_3 is withdrawn.

PROPERTIES:

Gray to gray-black. Oxidizes slowly in air with liberation of H_2S , turning greenish. d 4.18.

REFERENCES:

- W. Klemm and H. U. von Vogel, Z. anorg. allg. Chem. 219, 45 (1934).
 A. Brukl and G. Ortner, Monatsch. Chem. 56, 36 (1930).
 E. Gastinger, Z. Naturforsch. 10b, 115 (1955) and detailed private communications to G. Brauer.
 H. Spandau and F. Klanberg, Z. anorg. allg. Chem. 295, 300 (1958).

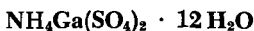
Ammonium Gallium(III) Sulfate

A GaCl_3 solution is evaporated to dryness with the stoichiometric amount of H_2SO_4 (Feit's procedure) and the sulfate is dissolved in water. Stirring solid $(\text{NH}_4)_2\text{SO}_4$ into the solution results in precipitation of the alum as a crystalline powder. Trivial amounts of impurities remain dissolved in the mother liquor.

The alum is purified by recrystallization from water, which should not be too hot in order to avoid formation of basic salts.

SYNONYM:

Ammonium gallium alum.

PROPERTIES:

Formula weight 496.07. Colorless crystals; isomorphous with the corresponding aluminum alum. Solubility at 25°C : 1 part in 3.24 parts water; precipitates basic salts on heating. d. 1.777.

REFERENCE:

W. Feit, *Angew. Chem.* 46, 216 (1933).

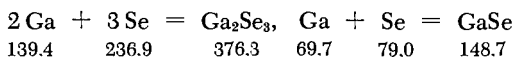
Gallium Selenide **Ga_2Se_3 and GaSe** 

According to Klemm and Von Vogel, Ga_2Se_3 and GaSe are prepared by the method given for GaS (see p. 851). The reaction proceeds with bright red incandescence (flashes of flame).

 Ga_2Se

Klemm and Von Vogel state that Ga_2Se cannot be directly synthesized from the elements. Heating equivalent amounts of Ga and Se via the procedure outlined for the preparation of GaS (see p. 851) gives only higher selenides contaminated with metallic Ga. However, if this intermediate is placed in a corundum boat which

is inserted into a quartz reactor equipped with a cold finger and is heated in high vacuum, a sublimate uniform to x-ray analysis, and having the composition Ga_2Se , is produced.

PROPERTIES:

Ga_2Se_3 : Black aggregate, red when ground. Fairly hard and brittle. M.p. 1020°C , d (x-ray) 5.203. B3 structure type (zinc blende).

GaSe : Dark red-brown, greasy, lustrous leaflets. M.p. 960°C , d 5.03. Hexagonal and rhombohedral modifications.

Ga_2Se : Formula weight 218.40. Black. d 5.02.

REFERENCES:

W. Klemm and H. U. von Vogel, Z. anorg. allg. Chem. 219, 45 (1934).

H. Hahn and W. Klinger, Z. anorg. Chem. 259, 135 (1949).

K. Schubert, E. Dorre and M. Kluge, Z. Metallkunde 46, 216 (1955).

Gallium Telluride



According to Klemm and Von Vogel, Ga_2Te_3 and GaTe are prepared in the manner described for GaS (see p. 851).

PROPERTIES:

Ga_2Te_3 : Formula weight 522.27. Black, hard and fairly brittle. M.p. 790°C , d 5.57.

GaTe : Formula weight 197.33. Black, soft, greasy lustrous leaflets, easy to grind. M.p. 824°C ; d (x-ray) 5.751. B3 structure type (zinc blende).

REFERENCES:

W. Klemm and H. U. von Vogel, Z. anorg. allg. Chem. 219, 45 (1934).

H. Hahn and W. Klinger, Z. anorg. Chem. 259, 135 (1949).

Gallium Nitride

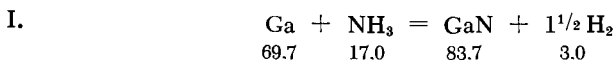

According to the method of Hahn and Juza, developed by Johnson, Parsons and Crew, GaN is prepared by heating metallic

Ga in a corundum boat for two hours at 1100°C in a rapid stream of NH₃ which has been dried over Na. The product is then ground and heated similarly for another two hours. Pale gray, finely crystalline GaN results.

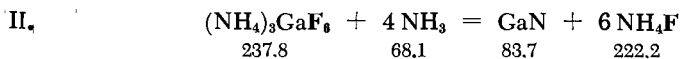

According to Hahn and Juza, (NH₄)₃GaF₆ (see p. 228) is heated 10 minutes at 900°C in a stream of NH₃, analogously to the preparation of InN (see p. 866). Pure, but yellow GaN results.

PROPERTIES:

Slowly dissolved by hot concentrated H₂SO₄ and hot concentrated NaOH, but not by concentrated HCl, HNO₃ and aqua regia. Stable in air, sublimes undecomposed at 800°C. d 6.10. B4 structure type (wurtzite).

REFERENCES:

- H. Hahn and R. Juza, Z. anorg. allg. Chem. 244, 111 (1940); compare also R. Juza and H. Hahn, Z. anorg. allg. Chem. 239, 282 (1938); 244, 133 (1940).
 W. C. Johnson, J. B. Parsons and M. C. Crew, J. Phys. Chem. 36, 2651 (1932).

Gallium Nitrate



The pure hydrate Ga(NO₃)₃·8H₂O, described by Einecke and earlier authors, is difficult to prepare. However, anhydrous Ga(NO₃)₃ is readily prepared as follows.

Gallium metal or oxide is dissolved in nitric acid. The solution is repeatedly evaporated to a very small volume and rediluted with water several times until the concentrated solution no longer has the odor of the acid. It is then diluted with enough water to furnish 26 g. of Ga per 100 ml. of solution. At this concentration a spongy, crystalline mass of Ga(NO₃)₃·xH₂O separates from the viscous solution after 1-2 days. The crystals are filtered by suction and suction-dried in air for a while. The mother liquor still contains a considerable quantity of Ga, due to the high solubility of the salt, and may be reused or worked up. The crystals are dried in a stream of air, first at room temperature and then at 40°C. The dehydration is complete after about two days.

PROPERTIES:

White powder. Yields a clear solution with water; very soluble.

REFERENCES:

- E. Einecke, *Das Gallium*, 1937, p. 98.
G. Brauer and U. Sporkert, 1958, unpublished.

Gallium Phosphide, Arsenide and Antimonide

GaP, GaAs, GaSb

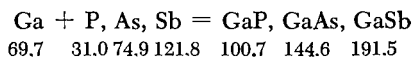

Goldschmidt reports producing the above three compounds via the following methods.

GaP (orange-yellow, hardness 5) is formed by heating hydrated gallium oxide in a stream of H_2 , saturated with P vapor, at 500°C .

GaAs (dark gray, hardness 4.2) is formed by heating Ga_2O_3 in a stream of H_2 containing As vapor. M.p. 1238°C .

GaBi has not yet been prepared; fusion of equimolar quantities of Ga and Bi at 600°C results only in a mixture of the two elements.

All three compounds crystallize in B3 structure type (zinc blende).

REFERENCES:

- V. M. Goldschmidt, *Skr. Acad. Oslo* 1926, No. 8.
W. Köster and B. Thoma, *Z. Metallkunde* 46, 291 (1955).

Indium

In

PREREFINING OF CRUDE INDIUM

Crude indium obtained, for example, as a byproduct of the New Jersey Zinc refining process contains 2-5% impurities, about 0.8% Pb, 0.5% Zn, 0.5% Sn, 0.01-0.1% Cu, and 0.01-0.05% Fe. Since Zn separates together with the In in the subsequent electrolytic refining, crude indium is first freed of Zn as follows: it is heated at $800-1000^\circ\text{C}$ in an iron tube closed at one end and sufficiently long to prevent spray losses. Steam is blown through the melt, by means

of a narrow pipe, for 15 minutes. The zinc volatilizes almost quantitatively as the oxide, and the residual indium contains only 0.008% Zn.

ELECTROLYTIC REFINING

Crude indium is comminuted by rolling and cutting, and dissolved in warm, dilute sulfuric acid containing 100-200 g. H_2SO_4 /liter to make the electrolyte solution. The temperature, quantity and concentration of the acid are such that some In remains behind with the Pb, Sn and Cu, but hydrolysis of the In is prevented. Platinum foil or gauze serves as the anode and should be arranged parallel to the cathode. A thin piece of In foil, if available, is used as the cathode; otherwise, highly polished Al foil (rinsed with benzine) is employed. Evaporation of the benzine leaves a thin, hazy, oil film which later facilitates removal of separated In. The Al cathode should be somewhat larger than the anode and its edges coated with a thick coat of wax to prevent In from creeping around and separating on the rear side; this would complicate removal of In. Electrolysis is conducted at 20-35°C with a current density of 1 amp./100 cm². Smooth deposition is aided by hourly addition of 1 ml. of 1% gelatin or carpenter's glue solution per liter of solution.

The separated In is finally fused to a button at 600-800°C under a mixture of 1 : 1 KCN and NaOH. It is 99.95% pure.

PROPERTIES:

Atomic weight 114.76. Silvery white, highly lustrous, very soft metal. Stable only in dry air. M.p. 156.17°C, b.p. above 1450°C; d 7.31. A6 structure type. Hardness about 1.2.

REFERENCES:

- F. Ensslin, *Die Chemie* 55, 347 (1942) and supplementary personal communications, 1948. Compare also F. Ensslin, *Metall und Erz* 37, 401 (1940).

Indium(III) Chloride

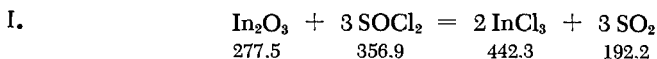

The compound is prepared by the method given for $GaCl_3$ (see p. 843) according to Hecht, Jander and Schlapmann. A narrower (9 mm. I.D.) tube with greater wall thickness (3 mm.) should be

selected because a higher reaction temperature (300°C) is necessary. The InCl_3 can be sublimed out in pure form after removal of excess SOCl_2 (b.p. 75.7°C).



According to Klemm, metallic In is oxidized in InCl_3 in a stream of Cl_2 which has been carefully dried with concentrated H_2SO_4 and P_2O_5 . A very thoroughly dried quartz apparatus, whose components have been fused together or connected by ground joints, is used. Chlorination proceeds rather vigorously at first, with a pale glow, and it proceeds through the mono- and dichloride steps. These compounds are melts. The end product of the chlorination, InCl_3 , sublimes around 600°C as lustrous spangles which appear on the walls of the receiver. The InCl_3 may be purified by subliming in a stream of N_2 (or CO_2) to which some Cl_2 has been added. The sublimate is allowed to cool in a stream of inert, Cl_2 -free gas in order to remove excess chlorine.

PROPERTIES:

Sublimation temperature 498°C. d 3.45. Very hygroscopic. Solubility in water at 22°C, 66.11 g. InCl_3 /100 g. solution (d 1.97). Solubility in absolute alcohol at 22°C, 53.2 g InCl_3 /100 g. solution (d 1.40).

Concentration of aqueous solutions, which are readily obtainable, for example, by dissolving In metal in hydrochloric acid, produces a crystalline hydrate, e.g., $\text{InCl}_3 \cdot 4\text{H}_2\text{O}$.

REFERENCES:

- I. H. Hecht, G. Jander and H. Schlapmann, *Z. anorg. Chem.* 254, 255 (1947).
- II. W. Klemm, *Z. anorg. allg. Chem.* 152, 252 (1926); see also G. P. Baxter and C. M. Alter, *J. Amer. Chem. Soc.* 55, 1943 (1933).
Solutions: F. Ensslin and H. Dreyer, *Z. anorg. allg. Chem.* 249, 119 (1942).
F. Ensslin, B. Ziemeck and L. DeSchaepe dryver, *Z. anorg. Chem.* 254, 293 (1947).

Indium(III) Bromide



According to Thiel, metallic In is heated in a fast air-free stream of CO_2 , which is saturated with Br_2 vapor by passage

through a wash bottle containing Br_2 (the bottle should be placed in a warm water bath). A melt of InBr and InBr_2 forms first. This melt is brown at first, but gradually becomes lighter. Finally it turns to solid InBr_3 . The latter can be readily sublimed to form lustrous crystalline spangles.

To obtain a pure product, it is essential to follow Klemm and Dierks' procedure of eliminating hydrocarbon-lubricated stopcocks. Joints which cannot be dispensed with should be lubricated with phosphoric acid.

II. Ensslin concentrated aqueous solutions of InBr_3 , readily prepared from In and hydrobromic acid, to obtain anhydrous InBr_3 above 33°C . Below 33°C , the solid phase consists of hydrates.

PROPERTIES:

Sublimation temperature 371°C . d 4.74. Deliquesces. Solubility in water at 22°C , 84.64 g. $\text{InBr}_3/100$ g. solution (d 2.84). Solubility in absolute alcohol at 24°C , 74.0 g. $\text{InBr}_3/100$ g. solution (d 2.21).

REFERENCES:

- I. A. Thiel, *Z. anorg. allg. Chem.* **40**, 317 (1904).
W. Klemm and F. Dierks, *Z. anorg. allg. Chem.* **219**, 42 (1934).
- II. F. Ensslin and H. Dreyer, *Z. anorg. allg. Chem.* **249**, 119 (1942).
F. Ensslin, B. Ziemeck and L. DeSchaepdryver, *Z. anorg. Chem.* **254**, 293 (1947).

Indium(III) iodide



In Thiel's method, metallic In is heated at 150 - 200°C in an air-free stream of CO_2 saturated with iodine vapor. When the liquid reaction product turns deep red-brown due to excess I_2 , the latter is removed in a stream of pure CO_2 at 230°C .

Klemm reports purification of InI_3 without decomposition via vacuum distillation.

II. According to Ensslin, anhydrous InI_3 is formed by concentration of its aqueous solutions (e.g., from In and HI). This procedure is only recommended when large amounts of material are available, since the salt is very soluble in H_2O and thus the losses are high.

PROPERTIES:

Pale-yellow crystals, melting to a dark brown liquid at 210°C. d 4.68. Very hygroscopic. Solubility in water at 22°C, 92.91 g. InI₃/100 g. solution (d 3.46).

REFERENCES:

- I. A. Thiel, Z. anorg. allg. Chem. 40, 305 (1904).
W. Klemm, Z. anorg. allg. Chem. 152, 252 (1926).
- II. F. Ensslin, B. Ziemeck and L. DeSchaepdryver, Z. anorg. Chem. 254, 293 (1947).

Indium(II) Chloride, Bromide and Iodide

I.	2 InCl ₃ ,	2 InBr ₃ ,	2 InI ₃	+	In		=	3 InCl ₂ ,	3 InBr ₂ ,	3 InI ₂	
	442.3	709.0	991.0					114.8	557.0	823.8	1105.8

In Klemm and Dierks' method, weighed amounts of the trihalides and the stoichiometric quantity of metallic In are thoroughly fused in an evacuated glass vessel to ensure complete conversion to the corresponding dihalides. The products are purified by vacuum distillation; in the case of InI₂ the apparatus is sealed off after evacuation to prevent changes in product composition due to loss of iodine.

II. Pure InCl₂ can be easily prepared by Alken, Haley and Terry's procedure through heating InCl₃ [preferred to In(OH)₃] in a slow stream of H₂ + 15% HCl at temperatures below 600°C (faint red glow). Complete absence of moisture and O₂ is not necessary. The product is heated for 15 minutes at somewhat above its melting point while a slow stream of N₂ is passed through to remove HCl. The pale-yellow melt solidifies to a glass on cooling.

PROPERTIES:

InCl₂: Formula weight 185.67. Hygroscopic. Decomposes in water to InCl₃ and In. M.p. 235°C; decomposes below the m.p., apparently to InCl₃ and InCl; b.p. ~ 570°C; d 3.65. Rhombic crystals.

InBr₂: Formula weight 274.59. Disproportionates in water to InBr₃ and red InBr; the latter slowly decomposes further to yield InBr₃ and In.

InI₂: Formula weight 368.60. M.p. ~ 210°C; d 4.71.

REFERENCES:

- W. Klemm and F. Dierks, Z. anorg. allg. Chem. 219, 42 (1934).
 J. K. Alken, J. B. Haley and H. Terry, Trans. Faraday Soc. 32,
 1617 (1936).

Indium(II) Chloride, Bromide and Iodide**InCl, InBr, InI**

I.	InCl ₃ ,	InBr ₃ ,	InI ₃	+ 2 In	=	3 InCl,	3 InBr,	3 InI
	221.1	354.5	495.5	229.5		450.7	584.0	725.0

In Klemm and Dierks' procedure, excess In metal is allowed to react with the corresponding trihalides, and the resultant monohalides are distilled off in vacuum.

PROPERTIES:

InCl: Formula weight 150.22. Two enantiotropic modifications; one, yellow and light-sensitive; the other, red and light-insensitive. A mixture of red and yellow modifications forms when the melt solidifies in the dark. Standing in the dark for eight days results in complete conversion to the yellow form. Transition temperature of the latter to the red form is 125-135°C. The yellow modification rapidly turns green-black in light. Water hydrolyzes InCl rather rapidly to InCl₃ and In. M.p. 225°C, b.p. 608°C; d (both forms) 4.18.

InBr: Formula weight 194.68. Forms a red to red-brown melt, almost black in thicker layers, solidifying to a carmine red mass. Hydrolyzes slowly in the cold, but rapidly when heated, to form InBr₃ and In. M.p. 220°C, b.p. 662°C. d 4.96.

InI: Formula weight 241.68. Brown-red when a compact solid; crimson red when finely ground and when sublimed; the melts are darker, almost black at the b.p. Relatively stable to water. M.p. 351°C, b.p. 715°C; d 5.32.

REFERENCE:

- W. Klemm and F. Dierks, Z. anorg. allg. Chem. 219, 42 (1934).

Indium Hydroxide**In(OH)₃**

According to Milligan and Weiser, a small excess of NH₃ solution is added at 100°C to an InCl₃ solution. The precipitate is aged

a few hours at 100°C by letting it stand under its mother liquor, then washed free of chloride and dried at room temperature.

PROPERTIES:

Formula weight 165.78. The product contains some adsorbed water; it is powdery and differs in structure from In_2O_3 .

The same precipitation at room temperature gives a gelatinous product containing more adsorbed water; however, it exhibits the same crystal structure.

REFERENCE:

W. O. Milligan and H. B. Weiser, *J. Amer. Chem. Soc.* 59, 1670 (1937).

Indium (III) Oxide



Thiel and Luckmann report that to obtain pure In_2O_3 it is necessary to ignite the hydroxide to constant weight at 850°C, followed by heating 30 minutes at 1000°C in air.

PROPERTIES:

Formula weight 277.52. Yellow material; the lower the ignition temperature, the more soluble in water; hygroscopic when weakly ignited, nonhygroscopic when strongly ignited. M.p. about 2000°C; d 7.04. C sesquioxide structure type.

REFERENCE:

A. Thiel and H. Luckmann, *Z. anorg. allg. Chem.* 172, 353 (1928).

Indium(I) Oxide

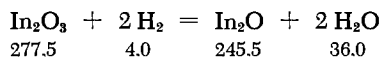

In the method of Klemm and Von Vogel, as developed by Thiel and Luckmann, In_2O_3 is reduced with H_2 at a temperature less than 400°C until the reduction product acquires a composition

approximating In_2O (overreduction results in partial conversion to metallic In). The reduction product is then vacuum-sublimed from a corundum boat in quartz apparatus and collected on a cold finger. The temperature must be so selected that the outside surface of the sublimator is no higher than about 750°C , since decomposition of sublimed In_2O sets in at higher temperatures.

PROPERTIES:

Black, finely crystalline, brittle and fairly hard; virtually nonhygroscopic, stable in cold water; readily soluble in hydrochloric acid, evolving H_2 . Burns to yellow In_2O_3 , when heated in air. *d* 6.99.

REFERENCES:

- W. Klemm and H. U. von Vogel, *Z. anorg. allg. Chem.* 219, 45 (1934).
 A. Thiel and H. Luckmann, *Z. anorg. allg. Chem.* 172, 353 (1928).

Indium Sulfides



In_2S_3

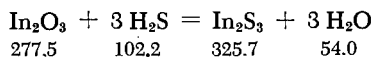

According to Klemm and Von Vogel, In_2O_3 is heated in a stream of H_2S (purified by liquefaction with Dry Ice), first for five hours at 500°C and then for eight hours at 700°C . The product is bright red In_2S_3 , which turns lustrous black after melting.

Hahn and Klingler maintain that this product is the high-temperature modification of $\beta\text{-In}_2\text{S}_3$. The low-temperature $\alpha\text{-In}_2\text{S}_3$ form is obtained by H_2S precipitation of an In(III) salt solution containing an acetic acid-acetate buffer, followed by vacuum drying of the precipitate over P_2O_5 at temperatures below 100°C .

PROPERTIES:

M.p. 1050°C in an evacuated, sealed tube. $\alpha\text{-In}_2\text{S}_3$ is face-centered cubic and isostructural with $\beta\text{-Al}_2\text{O}_3$; hygroscopic, adds 0.5 mole of H_2O and releases it below 300°C in vacuum or a current of dry H_2S ; irreversible transition at about 330°C to non-hygroscopic $\beta\text{-In}_2\text{S}_3$, which is isostructural with $\beta\text{-Al}_2\text{O}_3$ (*D* 5₇ type). *d* (x-ray) 4.648.

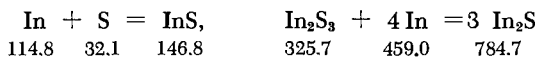
InS and In₂S

According to Klemm and Von Vogel, InS is prepared by direct synthesis from In and S, and In₂S from In and In₂S₃, using the method described for GaS (see p. 851).

According to Gastinger, In₂S is prepared from In and H₂S analogously to the method described for Ga₂S (see p. 852).

PROPERTIES:

InS: Red-brown. M.p. 692°C; d 5.18.

In₂S: Formula weight 261.58. Black in massive form, yellow in thin layers. Stable to cold and hot water. M.p. 653°C; d 5.87.

REFERENCES:

- W. Klemm and H. U. von Vogel, Z. anorg. allg. Chem. 219, 45 (1934).
 W. Klemm, K. Meisel and H. U. von Vogel, Z. anorg. allg. Chem. 190, 136 (1930).
 H. Hahn and W. Klingler, Z. anorg. Chem. 260, 97 (1949).
 E. Gastinger, Z. Naturforsch. 10b, 115 (1955).
 K. Schubert, E. Dorre and E. Gunzel, Naturwiss. 41, 448 (1954).

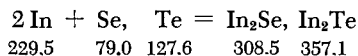
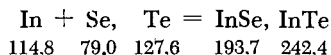
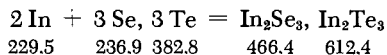
Indium Selenides and Tellurides**In₂Se₃, InSe, In₂Se and In₂Te₃, InTe, In₂Te**

According to Klemm and Von Vogel, mono- to trivalent In selenides and tellurides are synthesized from weighed amounts of the elements by the method described for GaS (see p. 851). Synthesis proceeds with incandescence even at the temperature of a Bunsen burner.

In preparation of In₂Se, a uniform product is obtained only if the melt is quenched. It is preferable to vacuum-sublime the

crude product in quartz equipment provided with a cold finger. The telluride In_2Te can be sublimed in this apparatus as readily and with almost as little residue as Ga_2S . The sublimate corresponds closely to the theoretical composition.

PROPERTIES:

In_2Se_3 : Black, fairly soft, quite soluble in strong acids. M.p. 890°C ; d 5.67.

InSe : Black, dull greasy luster, easily ground (loamy). M.p. 660°C ; d 5.55.

In_2Se : Black, fairly soft. d. 6.17.

In_2Te_3 : Black, hard, brittle. M.p. 667°C ; d (x-ray) 5.798. B3 type (zinc blende).

InTe : Silver gray when hot, steel blue when cold; fibrous, readily ground; not appreciably soluble in HCl. M.p. 696°C ; d. 6.29.

In_2Te : Dark gray, soft, difficult to triturate. d 6.47.

REFERENCES:

W. Klemm and H. U. von Vogel, Z. anorg. allg. Chem. 260, 97 (1949).

K. Schubert, E. Dorre and M. Kluge, Z. Metallkunde 46, 216 (1955).

Indium Nitride

InN

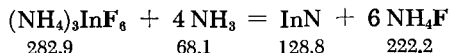

According to Hahn and Juza, InN is prepared by placing 1 g. of finely powdered $(\text{NH}_4)_3\text{InF}_6$ (see p. 228) in a corundum boat and inserting it into the cold zone of a quartz tube heated by an electric furnace. A fast stream of NH_3 (dried over Na) is allowed to flow through the tube. The boat is pulled into the hot zone of the tube when the temperature has reached 630°C . The temperature thereupon drops to $580\text{--}600^\circ\text{C}$ and the material is held at this temperature for 15 minutes. The temperature is then decreased over a period of 10 minutes to 520°C and held there for another 10 minutes to quantitatively drive out the byproduct NH_4F .

Slow heat-up times and longer heating of the $(\text{NH}_4)_3\text{InF}_6$ lead to products low in N.

PROPERTIES:

Black, air-stable powder; dissolved by NaOH and concentrated H_2SO_4 solutions, but not by other mineral acids. d 6.89. B4 structure type (wurtzite).

REFERENCE:

- H. Hahn and R. Juza, *Z. anorg. allg. Chem.* 244, 111 (1940); see also R. Juza and H. Hahn, *Z. anorg. allg. Chem.* 239, 282 (1938); 244, 133 (1940).

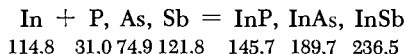
Indium Phosphide, Arsenide and Antimonide**InP, InAs, InSb**

In the method of Jandelli, stoichiometric quantities of the reactants are heated in vacuum to prepare these compounds. Only In and Sb combine with relative ease, In and P reacting only to the extent of 94-95% even after 350-400 hours at 700°C.

All three compounds crystallize with the zinc blende (B3) structure.

REFERENCE:

- A. Jandelli, *Gazz. Chim. Ital.* 71, 58 (1941).

Thallium**Tl**

ELECTROLYTIC SEPARATION OF THALLIUM

I. Richards developed the electrolytic method of separation of thallium from Tl_2SO_4 . It is advisable to treat the solution with H_2SO_4 to avoid cathodic separation of Zn and anodic deposition of Tl_2O_3 . Further, the solution should be sufficiently diluted to depress inclusion of the sulfate in the depositing metal and a low current density should be employed so that the separating metal is as crystalline and compact as possible. Short Pt wires serve as the electrodes. These are immersed in the solution only for a length of 1 cm. The anode, sealed in a glass tube, is inserted into

the solution so that its short free end rests on the bottom of the vessel. The cathode is immersed just below the liquid surface. The separated Tl is frequently removed from the cathode with a narrow glass fork, washed under pure, boiled water and stored there until ready for fusion.

Before fusing, the metal is kneaded into a lump under water and dried as thoroughly as possible between filter papers, and the lumps are beaten together. Fusion at 350–400°C is effected in a graphite crucible under a layer of oxalic acid or in a stream of H₂.

It is advisable to protect Tl from surface oxidation by coating it with a layer of paraffin or storing it under glycerol or petroleum. II. Brown and McGlynn report preparation of a good, smooth, cohesive electrolytic deposit of metallic Tl from a thallium perchlorate bath containing peptone as an anodic depolarizer and cresol as a further additive. Current densities of 0.5 to 1.8 amp./100 cm.² are used.

Thallium perchlorate is readily soluble in water; the solution is a good conductor and does not change on exposure to air. Lower current densities (about 0.5 amp./100 cm.²) provide good deposits on addition of only 10 g. of excess HClO₄/liter. The peptone gives a yellow precipitate, but does not interfere in any way. Higher current densities (0.9–1.8 amp./100 cm.²) also yield good deposits when concentrated solutions with up to 60 g. of free HClO₄/liter are used.

PROPERTIES:

Atomic weight 204.39. The fresh surface has a bright metallic luster. Immediately turns gray on exposure to air; barely attacked by O₂-free H₂O. M.p. 302.5°C, b.p. +1457°C. At room temperature α -Tl, A3 structure type, d 11.84, Mohs hardness 1.3. Transition at 232.3°C to β -Tl, A1 structure type, d 11.88 (measured at room temperature); β -Tl can be supercooled for some time at room temperature without transition.

REFERENCES:

- T. W. Richards and C. P. Smyth, *J. Amer. Chem. Soc.* 44, 525 (1922).
T. W. Richards and J. D. White, *J. Amer. Chem. Soc.* 50, 3292 (1928).
K. Lins, Sachtleben A. G., Homberg/Niederrhein, in: A. E. van Arkel, *Reine Metalle [Pure Metals]*, Berlin, 1939, p. 470.
O. W. Brown and A. McGlynn, *Metal Ind.* 32, 570 (1928); see also E. Bertorelle, L. Giuffrè and A. Tunesi, *Chim. e l'Ind.* 32, 517 (1950).

PURIFICATION OF TECHNICAL GRADE THALLIUM

Technical grade Tl may contain all the flue dust elements, particularly Pb, Ni, Cd, Zn and As. The metal is purified by dissolving in warm, dilute H_2SO_4 , diluting a little and filtering off precipitated PbSO_4 . According to Richards and White, the metal can also be dissolved in hot dilute HNO_3 , since this is a better solvent; the solution of the nitrate is converted to Tl_2SO_4 by heating with a slight excess of concentrated H_2SO_4 until SO_3 fumes are evolved, diluting with water and filtering off insoluble PbSO_4 ; the small amounts of Tl(III) which form are reduced with SO_2 .

The dissolved Tl_2SO_4 is further purified by repeated precipitation (as TlCl) with hydrochloric acid, followed by dissolving in warm, dilute sulfuric acid. The thallium is finally electrolyzed as described above.

REFERENCES:

T. W. Richards and J. D. White, *J. Amer. Chem. Soc.* **50**, 3292 (1928); private communication, Sachtleben A. G., Homberg/Niederrhein.

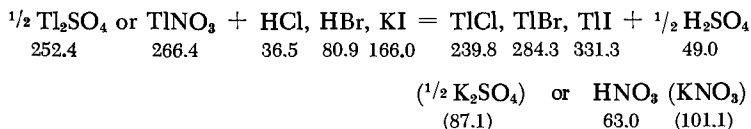
Thallium(I) Chloride, Bromide and Iodide **TlCl , TlBr , TlI** **TlCl**

A boiling dilute (e.g., 2%) Tl_2SO_4 or TlNO_3 solution is treated with dilute HCl until no further precipitate forms. The TlCl is decanted from the mother liquor after cooling, washed with distilled water and dried several hours in an oven at $110\text{--}120^\circ\text{C}$.

According to Hönigschmid, Birkenbach and Kothe, TlCl can be purified by repeated crystallization from hot water, or distillation in a stream of dry air or dry N_2 , using quartz equipment. Rotation of the flask distributes the distilled TlCl in a thin film, thus preventing rupture of the vessel wall by contraction of the adhering TlCl on cooling.

TlBr

According to Hönigschmid and Striebel, TlBr is precipitated from pure dilute HBr , analogously to TlCl . It is harder to

recrystallize and is therefore digested several times with boiling water and well dried by suction. It is then dried over KOH in a desiccator and kept in the dark to prevent decomposition. Like TlCl , it can be fused and distilled in a stream of dry N_2 .

TII

In the Cady and Taft method, TII is precipitated from hot solution with the calculated amount of KI and washed and dried at 110°C .

PROPERTIES:

TlCl : Formula weight 239.85. Completely colorless when freshly prepared; becomes violet on exposure to light. M.p. 430°C , b.p. 806°C . Solubility in water 0.17 g. (0°C); 0.32 g. (20°C); 2.38 g. (100°C) per 100 g. H_2O . d 7.0. B2 structure type.

TlBr : Formula weight 284.31. Pale green-yellow; darkens in light. M.p. 456°C , b.p. 815°C . Solubility in water $2.38 \cdot 10^{-2}$ g. (0°C); $4.76 \cdot 10^{-2}$ g. (20°C); $20.4 \cdot 10^{-2}$ g. (60°C) per 100 g. H_2O . d 7.5. B2 structure type.

TII: Formula weight 331.31. Two enantiotropic modifications. Yellow, rhombic (layer lattice) below $\sim 168^\circ\text{C}$. d 7.29. Discolors in light. M.p. 440°C , b.p. 824°C . Solubility in water (20°C) $6.3 \cdot 10^{-3}$ g. per g. H_2O . Red, B2 structure type above $\sim 168^\circ\text{C}$. d (x-ray) 7.45; supercools.

REFERENCES:

- E. Cohen and K. Piepenbroek, *Z. phys. Chem. (A)* 167, 370 (1933).
 O. Honigschmid, L. Birkenbach and E. Kothe, *Ber. Bayr. Akad.* 1922, 180.
 O. Honigschmid and H. Striebel, *Z. anorg. allg. Chem.* 194, 295 (1930).
 H. P. Cady and R. Taft, *J. Phys. Chem.* 29, 1071 (1925).

Thallium(III) Chloride

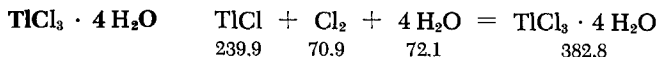

According to Meyer, $\text{TlCl} \cdot 4\text{H}_2\text{O}$ is prepared by passing Cl_2 through a nearly boiling suspension of TlCl in a limited amount of water. After intermediate Tl(I) - Tl(III) chloro compounds have dissolved, the solution is evaporated to a thin syrup with continuous addition of Cl_2 . The water bath temperature should be

60–70°C. The syrup immediately solidifies to a slurry of fine, white needles of $\text{TlCl} \cdot 4 \text{H}_2\text{O}$ on cooling in an ice bath, larger crystals form on slower cooling. The crystals are rapidly filtered and dried 24 hours over H_2SO_4 and KOH (virtually no efflorescence). Cushman claims that $\text{TlCl}_3 \cdot 4 \text{H}_2\text{O}$ crystals can only be dried between filter papers if loss of water is to be avoided. Hecht states that he found no definite tetrahydrates.

PROPERTIES:

Colorless crystals, deliquescing in moist air. M.p. about 43°C. A saturated aqueous solution (about 86% $\text{TlCl}_3 \cdot 4 \text{H}_2\text{O}$ at 17°C) is strongly acidic due to hydrolysis, and precipitates brown $\text{Tl}_2\text{O}_3 \cdot x\text{H}_2\text{O}$ when highly diluted. Readily soluble in alcohol and ether; 90–95% of the TlCl_3 is extracted from a 6N HCl solution of TlCl_3 by shaking with an equal volume of ether.

TlCl_3

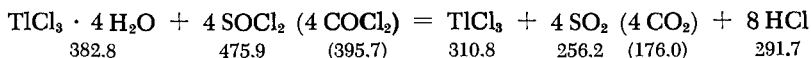

The tetrahydrate is difficult to dehydrate without decomposition to TlCl . Hecht used SOCl_2 or COCl_2 for this purpose. These react with the water of hydration, giving SO_2 or CO_2 and HCl .

A few milliliters of Cl_2 are condensed in an ordinary combustion tube by cooling and are then melted in contact with $\text{TlCl}_3 \cdot 4\text{H}_2\text{O}$ and excess SOCl_2 . A vigorous reaction starts as soon as the mixture reaches room temperature; it is initially controlled by cooling the mixture. Beautiful, white, hexagonal leaflets form at once, even at room temperature. When the reaction is complete, the lower end of the sealed tube is cooled with Dry Ice to reduce internal pressure and then the seal point is opened with a Bunsen flame. Most of the excess SOCl_2 (b.p. 75.7°C) is distilled from the reaction product in a ground joint flask on a water bath. The balance is removed by repeated evacuation. If TlCl_3 is carefully worked up (i.e., warmed slowly to room temperature), it contains not more than 0.2% of TlCl .

Phosgene may be used as the dehydrating agent instead of SOCl_2 . The conditions are the same except that the combustion tube must be heated to 120°C. The TlCl_3 obtained in this manner contains no noticeable traces of TlCl .

PROPERTIES:

Begins to sinter at about 140°C. M.p. 155°C (with Cl_2 evolution). Very hygroscopic. Very soluble in water, alcohol and ether (see $\text{TlCl}_3 \cdot 4\text{H}_2\text{O}$).

REFERENCES:

- R. J. Meyer. *Z. anorg. allg. Chem.* 24, 335 (1900).
 A. S. Cushman. *Amer. Chem. J.* 26, 511 (1901).
 H. Hecht. *Z. anorg. Chem.* 254, 37 (1947).
 E. H. Swift. *J. Amer. Chem. Soc.* 46, 2378 (1924).

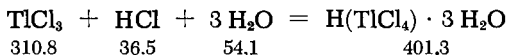
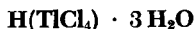
Tetrachlorothallium(III) Acid

This compound is prepared by chlorinating an aqueous suspension of TlCl by Meyer's method, as described in the previous section. The resulting TlCl_3 solution is treated with one mole of HCl per mole of TlCl_3 and then concentrated on a water bath with continuous introduction of Cl_2 . It is finally crystallized by evaporation in vacuum over H_2SO_4 and KOH .

PROPERTIES:

Long, hairlike needles. Extremely hygroscopic; deliquesces in moist air, but stable in dry air.

REFERENCE:

- R. J. Meyer. *Z. anorg. allg. Chem.* 24, 337 (1900).

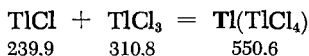
Thallium(I) Tetrachlorothallate(III)

According to Benrath, $\text{Tl}(\text{TlCl}_4)$ is prepared from a boiling aqueous solution of more than nine moles of TlCl_3 /liter. The thallium(I) chloride is dissolved in this solution; the product crystallizes in long, white needles on cooling. These cannot be washed since they decompose to a mixture of TlCl_3 and yellow $\text{Tl}_3(\text{TlCl}_6)$ on contact with water or water-miscible solvents.

REFERENCE:

- A. Benrath. *Z. anorg. allg. Chem.* 93, 161 (1915); 136, 358 (1924).

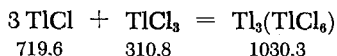
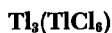
Thallium(I) Hexachlorothallate(III)

According to Meyer, $\text{Tl}_3(\text{TlCl}_6)$ is prepared by saturating a not too dilute, boiling, HNO_3 -acidified TlCl_3 solution with freshly precipitated TlCl and subsequently filtering. The solution takes up three moles of TlCl per mole of TlCl_3 . The $\text{Tl}_3(\text{TlCl}_6)$ crystallizes on cooling as lustrous, lemon-yellow, hexagonal leaflets. The crystals can be recrystallized from 0.01 N HCl (not water) without decomposition; they are dried in vacuum over concentrated H_2SO_4 .

PROPERTIES:

Slightly soluble in pure water: 0.54 g. (35°C); 0.97 g. (55°C) per 100 g. H_2O . Hydrolytic decomposition is inhibited by addition of a few drops of HNO_3 or HCl . Converted to $\text{Tl}(\text{TlCl}_4)$ at concentrations lower than 9M TlCl_3 . m.p. between 400 and 500°C ; d (unfused) 5.9.

REFERENCES:

- R. J. Meyer. *Z. anorg. allg. chem.* 24, 350 (1900);
 A. Benrath. *Z. anorg. allg. Chem.* 93, 161 (1915); 136, 358 (1924).

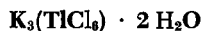
Potassium Hexachlorothallate(III)

According to Lyden, $\text{K}_3(\text{TlCl}_6) \cdot 2\text{H}_2\text{O}$ is prepared by concentrating a 1:3 molar mixture (239.9 g.: 367.7 by weight) of TlCl and KClO_3 with excess concentrated HCl until crystallization occurs.

PROPERTIES:

Formula weight 570.45. Colorless. d 2.859. $J3_1$ structure type. Dehydrates at 150°C .

REFERENCES:

- R. Lyden. *Finska Kemistsamfundets Medd.* 41, 44 (1932);
 J. L. Hoard and L. Goldstein. *J. Chem. Phys.* 3, 654 (1935).

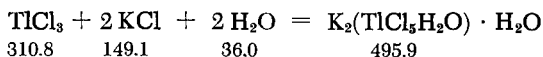
Potassium Pentachloroaquothallate(III)

According to Meyer, $\text{K}_2(\text{TlCl}_5\text{H}_2\text{O}) \cdot \text{H}_2\text{O}$ crystallizes as monoclinic prisms on evaporation of solutions containing less than three moles of KCl per mole of TlCl_3 .

REFERENCE:

R. J. Meyer. Z. anorg. allg. Chem. 24, 343 (1900).

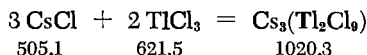
Cesium Nonachlorodithallate(III)

Pratt reports separation of $\text{Cs}_3(\text{Tl}_2\text{Cl}_9)$ as a heavy, white precipitate of hexagonal prisms or plates on addition of 5-29 g. of CsCl to a solution of 40 g. TlCl_3 . It can be recrystallized unchanged from the mother liquor or water.

PROPERTIES:

Stable in air. d 4.31. $K7_2$ structure type.

REFERENCES:

J. H. Pratt. Z. anorg. allg. Chem. 9, 23 (1895).

J. L. Hoard and L. Goldstein. J. Chem. Phys. 3, 199 (1935).

H. M. Powell and A. F. Wells. J. Chem. Soc. (London) 1935, 1008.

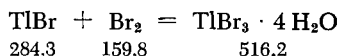
Thallium(III) Bromide

According to Thomas, $\text{TlBr}_3 \cdot 4\text{H}_2\text{O}$ is prepared by treating an aqueous suspension of TlBr with excess Br_2 until solution is

complete and concentrating at 30–40°C (it starts to decompose at higher temperatures as well as at too great concentrations, turning yellow). The concentrate is cooled until crystallization occurs. Persistent supersaturation, which occurs readily, is most easily remedied by abrupt cooling of one point in the solution with a stream of CO₂ gas.

PROPERTIES:

Long, pale-yellowish needles. Readily soluble in water. M.p. about 40°C; however, decomposes in air at 30°C to give dark yellow Tl(TlBr₄) and liberating H₂O and Br₂; in vacuum this occurs even at room temperature. Unstable when anhydrous.

REFERENCE:

V. Thomas. Ann. Chim. Phys. [8] 11, 235 (1907).

Thallium(I) Tetrabromothallate(III)

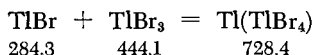

According to Benrath, Tl(TlBr₄) separates as yellow needles on cooling aqueous solutions containing at least 0.3 mole of TlBr₃/liter and saturated at boiling with TlBr. The precipitate cannot be washed, since it decomposes to a mixture of TlBr₃ and Tl₃(TlBr₆) on contact with water and water-miscible solvents; the Tl₃(TlBr₆) decomposes further to TlBr and TlBr₃. See also below.

REFERENCES:

A. Benrath. Z. anorg. allg. Chem. 93, 161 (1915); 136, 358 (1924).

Thallium(I) Hexabromothallate(III)

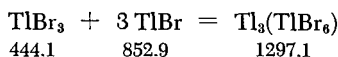

Benrath reports separation of red Tl₃(TlBr₆) crystals from an aqueous solution containing 0.15 mole of TlBr₃/liter and saturated

with TlBr at 80°C, when the solution is cooled from 80°C to 5°C. Below 5°C, Tl(TlBr₄) crystallizes out.

If the 0.15M TlBr₃ solution is saturated with TlBr above 80°C, cooling to 80°C yields TlBr crystals. Further cooling yields Tl₃(TlBr₆) between 80°C and 5°C.

The above crystallization temperatures change with varying TlBr₃ concentrations; e.g., Tl₃(TlBr₆) separates from a 0.1M TlBr₃ solution saturated with TlBr only below 69°C.

The Tl₃(TlBr₆) decomposes to TlBr and TlBr₃ on contact with water. See the preparation above.

REFERENCE:

A. Benrath. Z. anorg. allg. Chem. 93, 161 (1915); 136, 358 (1924).

Rubidium Hexabromothallate(III)

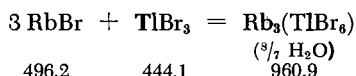
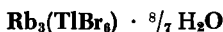

Pratt states that golden yellow crystals of Rb₃(TlBr₆) · $\frac{8}{7}$ H₂O (he reports 1 instead of $\frac{8}{7}$ H₂O) separate from a very concentrated solution of 50 g. of RbBr after addition of a solution of 1.5-24 g. of TlBr₃.

PROPERTIES:

Very soluble in water, but converts to pale-yellow Rb(TlBr₄) · H₂O on recrystallization. d 4.077. J3₁ structure type.

REFERENCE:

J. L. Hoard and L. Goldstein. J. Chem. Phys. 3, 654 (1935).

Thallium Triiodide

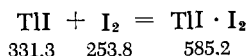
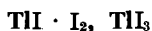

Berry, Lowry and Goldstein report preparation of well-developed TlI · I₂ crystals by refluxing equivalent quantities of TlI and I₂ in

methanol, filtering and evaporating over CaCl_2 in a vacuum desiccator.

PROPERTIES:

Solid-state structure $\text{TlI} \cdot \text{I}_2$; TlI_3 in methanol solution. Black. Rhombic, isomorphic with $\text{RbI} \cdot \text{I}_2$ and $\text{CsI} \cdot \text{I}_2$. Insoluble in water. The additional I content above TlI is split off by water, ethanol, ether, CCl_4 or KI solution.

REFERENCE:

A. J. Berry, T. M. Lowry and R. R. Goldstein. J. Chem. Soc. (London) 1928, 1749.

Thallium(I) Oxide

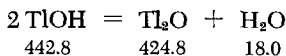

According to Roth and Meichsner, Tl_2O is prepared by careful dehydration of TlOH in high vacuum at close to 50°C . No Tl_2O_3 formation occurs at this temperature. Dehydration is almost complete after 2-3 days.

PROPERTIES:

Black, crystalline. Begins to volatilize in high vacuum at 300°C . B.p. at least 1080°C . Hygroscopic; reacts with water, forming TlOH ; for solubility in water see TlOH . Solubility in absolute ethanol at room temperature: 4.4 mg. $\text{TlO}_2/100$ ml. alcohol; heating produces thallium ethoxide. d 9.52.

REFERENCE:

W. A. Roth and A. Meichsner. Z. Elektrochem. 38, 87 (1932).

Thallium(I) Hydroxide

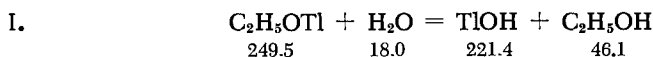

Lamy reports that hydrolysis of thallium ethoxide precipitates TlOH . Thallium ethoxide can be rapidly prepared by the Fricke

and Klein method (further developed by Freudenberg and Uthemann) according to the equation

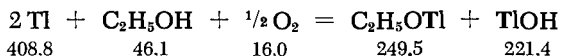

using the device shown in Fig. 251. Ethanol is refluxed in ground joint flask *a* while dry, CO₂-free air is passed through tube *c*, located in the middle of *b*, on top of which there is a reflux condenser, connected by a ground joint. Air flows out the condenser through a soda-lime tube to prevent back-diffusion of CO₂ into the apparatus. Air and alcohol vapor diffuse through Tl turnings (made with a pencil sharpener) held in porcelain sieve *d*. Thus, TlOH and thallium ethoxide are formed. Both are readily soluble in warm alcohol and separate on cooling as a colorless, heavy, oily liquid (which probably represents a compound of TlOC₂H₅ and TlOH) on the bottom of the flask (TlOC₂H₅ d is 3.5).

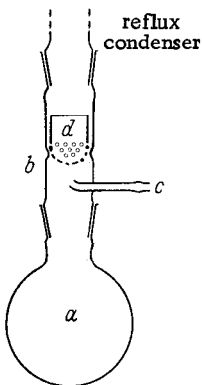
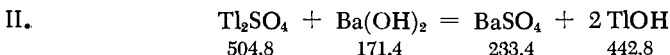

Fig. 251. Preparation of thallium ethoxide.

For the hydrolytic decomposition the thallium ethoxide is cooled in an ice bath without separating excess alcohol (to prevent partial conversion of the TlOH to black Tl₂O) and treated with an equal volume of

boiled and re-cooled distilled water. Alcohol is then evaporated in vacuum. Yellow, crystalline TlOH separates. DeForcrand states that the product still retains 4% moisture after 24 hours of standing in a desiccator on porous tile.



According to Johnston, an aqueous solution of TlOH can be simply prepared by treating a hot solution of pure Tl₂SO₄ with the calculated amount of dissolved Ba(OH)₂ and filtering off the precipitated BaSO₄.

PROPERTIES:

Yellow needles, readily turning dark. Saturated aqueous solutions are 1.15, 1.58 and 6.71N at 0, 19.5 and 99.2°C respectively. They attack glass, especially when hot. High solubility in alcohol. Strongly absorbs CO₂ to form Tl₂CO₃. Vapor pressure about 13 mm. (46°C); 770 mm. (140°C); d 7.44.

REFERENCES:

- I. A. Lamy. *Ann. Chim. Phys.* [3] 67, 395 (1863); [4] 3, 390 (1864); K. Freudenberg and G. Uthemann. *Ber. dtsh. chem. Ges.* 52, 1509 (1919); A. Klein. Thesis, Technische Hochschule, Stuttgart, 1945; R. deForcrand. *Compt. Rend. Hebd. Seances Acad. Sci.* 176, 874 (1923).
- II. J. Johnston. *J. Phys. Chem.* 62, 341 (1908).

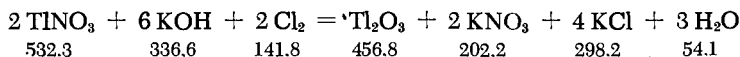
Thallium(II) Oxide

According to Huttig and Mytizek, a solution of 30 g. TlNO_3 in one liter of water is gradually treated with 400 ml. of pure, CO_2 -free, dilute KOH and is then ice cooled and saturated with Cl_2 . When precipitation of $\text{Tl}_2\text{O}_3 \cdot x\text{H}_2\text{O}$ ceases, the solids are washed with a total of 40 liters of water by decantation (the hydrated oxide settles out very slowly). The precipitate is then filtered and washed until free of Cl^- ions. The brown, hydrated oxide still has the composition $\text{Tl}_2\text{O}_3 \cdot 1.47\text{H}_2\text{O}$ after 10 days of drying in an ordinary desiccator over 26% H_2SO_4 . Essentially anhydrous, brown Tl_2O_3 is obtained after four days of drying in vacuum over 32% H_2SO_4 .

Isobaric dehydration of hydrated oxide by heating even below 90°C at 10 mm. results in a small but definite loss of oxygen; this increases above 100°C to the point where the completely dehydrated product, obtained by heating at 330°C has only the composition $\text{Tl}_2\text{O}_{2.8}$. Some elemental Tl also begins to sublime at 330°C .

PROPERTIES:

Tl_2O_3 : brown to black, depending on preparative conditions. M.p. 717°C under 1 atm. of O_2 Insoluble in water. d (x-ray) 10.11. C sesquioxide structure type.

REFERENCES:

- G. F. Huttig and R. Mytizek, *Z. anorg. allg. Chem.* 192, 187 (1930); compare also W. O. Milligan and H. B. Weiser. *J. Amer. Chem. Soc.* 59, 1673 (1937), and H. B. Weiser and W. O. Milligan. *J. Phys. Chem.* 42, 673 (1938).

Thallium Sulfides

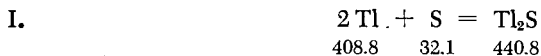
THALLIUM (I) SULFIDE Tl_2S 

According to Ketelaar and Gorter, Tl_2S is formed by fusing equimolar quantities of Tl and S in a sealed, H_2 -filled tube at room temperature and 60 mm. A brown-black button with a metallic luster is formed.

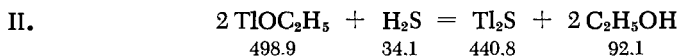

According to Reuter and Goebel, finely divided, very reactive, oxygen-free Tl_2S can be prepared by reaction of dry H_2S with thallium ethoxide dissolved in absolute alcohol.

The ethoxide obtained from 10 g. of Tl [see thallium(I) hydroxide, p. 877, for preparation] is dissolved in 250 ml. of absolute alcohol and passed through a fluted filter into the flask of a distillation apparatus. Air is displaced with pure N_2 , followed by dry H_2S , resulting in a finely divided Tl_2S precipitate. Air is prevented from entering the apparatus by having the condenser tube reach almost to the bottom of the receiver, which contains some alcohol.

The reaction is over within two hours. The gas inlet tube is closed, the alcohol distilled off on a water bath, and the Tl_2S dried by heating on a water bath for two hours and finally in oil pump vacuum.

PROPERTIES:

M.p. $448.5^\circ C$ under N_2 . Volatilization begins above $300^\circ C$. Practically insoluble in water. d (x-ray) 8.39. PbI_2 structure (C6 type) with only small deviations. Finely powdered, deep black Tl_2S smears like graphite when rubbed.

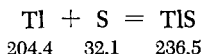
THALLIUM (I, III) SULFIDE $Tl_2S \cdot Tl_2S_3$ or TIS

Hahn and Klingler prepared "TIS" by reaction of equimolar quantities of pure Tl with redistilled S in an evacuated Pyrex tube heated to Bunsen burner temperature. The product is kept 24 hours at $200^\circ C$ for better crystallization.

PROPERTIES:

Black to steel-gray with metallic luster. d (x-ray) 7.61. B37 structure type.

REFERENCES:

- J. A. A. Ketelaar and E. W. Gorter. *Z. Kristallogr.* 101, 367 (1939);
 B. Reuter and A. Goebel. *Z. anorg. allg. Chem.* 268, 101 (1952);
 H. Hahn and W. Klingler. *Z. anorg. Chem.* 260, 110 (1949).

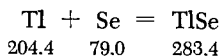
Thallium(I, III) Selenide

According to Ketelaar, Hart, Moerel and Polder, Tl_2Se_3 . Tl_2Se_3 or "TlSe" is prepared by fusing equimolar quantities of Tl and S at 400°C and cooling very slowly, a procedure similar to preparation of Tl_2S . The button fractures under light pressure into tetragonal prisms with a very strong metallic luster.

PROPERTIES:

M.p. 310°C (congruent). Indefinitely stable in dry air. d (x-ray) 8.31. B37 structure type.

REFERENCE:

- J. A. A. Ketelaar, W. H. T. Hart, M. Moerel and D. Polder. *Z. Kristallogr.* 101, 396 (1939).

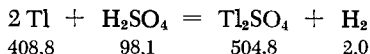
Thallium(I) Sulfate

This compound is prepared by dissolving pure Tl in warm, moderately dilute H_2SO_4 and concentrating until crystallization begins.

Since Tl dissolves more easily in hot, dilute HNO_3 , it is advantageous to prepare the sulfate by evaporating a nitric acid solution containing a small excess of concentrated H_2SO_4 . The small amounts of Tl(III) sulfates formed are reduced with SO_2 (see also Purification of Technical Grade Thallium, p. 869).

Ensslin reports (private communication) formation of Tl(I) sulfate by passing a mixture of steam and air countercurrently to sulfuric acid (150 g. of H_2SO_4 /liter) through a column filled with crude, granulated thallium. The hot effluent, which is almost saturated with Tl_2SO_4 , is filtered on a heated suction filter into a crystallization flask. The mother liquor is reacidified with H_2SO_4 and recycled through the column. In this manner, pure thallium can be obtained via Tl(I) sulfate, starting with crude thallium containing 8% Pb and 1% Cu.

PROPERTIES:

M.p. 632°C; volatilizes undecomposed. Solubility in water 2.7 (0.2°C); 4.3 g. (15.6°C); 18.5 g. (100°C) per 100 g. of H_2O . d 6.765. Isomorphous with K_2SO_4 (H 16 structure type).

Disulfatothallic(III) Acid

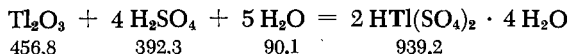
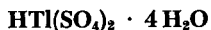

Meyer and Wilk report preparation of $HTl(SO_4)_2 \cdot 4H_2O$ by saturating warm 45-50% H_2SO_4 with Tl_2O_3 or, better still, with $Tl_2O_3 \cdot xH_2O$ (because of its higher rate of solution). Concentration of the clear solution on a water bath yields heavy, colorless crystals, which are dried several days on heated porous tile in a steam-heated drying oven. The crystals cannot be washed with water due to their tendency to hydrolyze. Temperature and concentration of adhering mother liquor may not be changed during drying, to avoid decomposition set-in.

Formula weight 469.58.

REFERENCE:

J. Meyer and H. Wilk. Z. anorg. allg. Chem. 132, 244 (1924).

Thallium(III) Hydroxide Sulfate

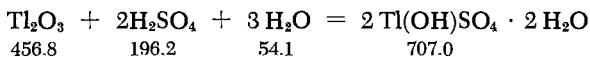

According to Meyer and Wilk, $Tl(OH)SO_4 \cdot 2H_2O$ is formed analogously to $HTl(SO_4)_2 \cdot 4H_2O$, by using 20% H_2SO_4 instead of 45-50%

acid, or when $\text{HTl}(\text{SO}_4)_2 \cdot 4\text{H}_2\text{O}$ is crystallized from 20% H_2SO_4 . Drying is carried out in the same way as in the previous preparation to avoid hydrolytic decomposition.

Formula weight 353.49.

REFERENCE:

J. Meyer and H. Wilk. *Z. anorg. allg. Chem.* 132, 244 (1924).

Thallium(I) Nitride

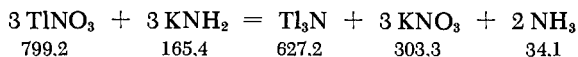

Franklin reports separation of Tl_3N as a black precipitate if a solution of TlNO_3 in liquid NH_3 is treated with the corresponding quantity of KNH_2 in liquid NH_3 .

PROPERTIES:

Explodes on contact with water or dilute acids, also on heating or impact. Soluble in solutions of TlNO_3 or KNH_2 in liquid NH_3 . The sample for analysis is washed with liquid NH_3 , vacuum dried by evaporation of NH_3 and carefully hydrolyzed with steam.

REFERENCE:

E. C. Franklin. *J. Phys. Chem.* 16, 683 (1912).

Thallium(I) Nitrate

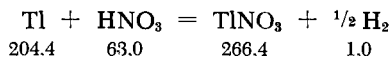

Pure Tl is dissolved in dilute HNO_3 , excess acid evaporated at 110°C , and the nitrate repeatedly crystallized.

PROPERTIES:

M.p. 206°C , b.p. 433°C ; d 5.55. Three enantiotropic modifications: rhombic below about 75°C , hexagonal between about 75°C

and about 142°C, and cubic above about 142°C. Solubility in water at 0, 15, 30 and 104.5°C (b.p.): 4, 8, 14 and 593.9 g. of TlNO_3 /100 g. of H_2O . Densities of these solutions at the same temperatures: 1.035, 1.065, 1.115 and 3.191.

REFERENCES:

- C. van Eyk. *Z. phys. Chem.* **30**, 430 (1899).
Earl of Berkeley. *Phil. Trans. (A)* **203**, 213 (1904).

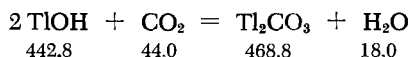
Thallium(I) Carbonate

This compound is prepared by saturating a hot aqueous solution of TlOH with CO_2 and evaporating on a water bath. The Tl_2CO_3 , which separates on cooling, is filtered by suction on a Pyrex filter, recrystallized from hot water (it is best to work in alkali-stable glass vessels) and dried at 105°C.

PROPERTIES:

Colorless, needle-shaped, monoclinic crystals with sharp enantiotropic transition point at 228°C. M.p. 272°C. Solubility in water 5.2 g. (18°C); 22.4 g. (100.8°C) per 100 g. of H_2O ; aqueous solutions are strongly basic due to hydrolysis. Insoluble in absolute alcohol. Not hygroscopic, stable in air up to 175°C without noticeable change. Dissociation pressure of the melt 1 atm. at 368°C. *d* 7.16.

REFERENCES:

- K. Freudenberg and G. Uthemann. *Ber. dtsh. chem. Ges.* **52**, 1509 (1919).

**Thallium(II) Formate, Thallium(I) Malonate,
Clerici's Solution**

Clerici's solution is best prepared starting with the two salts or their solutions separately.

A) THALLIUM (I) FORMATE

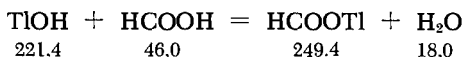
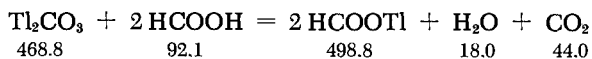

According to Vhay and Williamson, thallium(I) formate is prepared by treating Tl_2CO_3 with formic acid. Excess formic acid is removed by repeated evaporation to dryness on a water bath and redissolving in distilled water until the odor of formic acid disappears.

According to Brauer and Haag, an aqueous solution of TlOH (see p. 877) is prepared, treated with sufficient formic acid to render the solution neutral or weakly acid, and evaporated in vacuum. Evaporation in open porcelain dishes is not recommended, since the residue darkens and becomes partly insoluble.

Brauer and Haag prefer the following procedure as more reliable, even though it is somewhat more tedious: about 30 g. of Tl is cut in small pieces and heated with 150 ml. of about 90% formic acid in a flask with a ground joint and a 1-m.-long air condenser. The heating must be just sufficient to reflux the formic acid gently. Every 12 hours, 10-20 ml. of formic acid is added. Practically all the Tl reacts after about 60 hours and the solution can be evaporated in vacuum.

PROPERTIES:

M.p. 101°C (without decomposition). Melt colorless and mobile. d (104°C) 4.967. Hygroscopic, very soluble in water (500 g. of $\text{TlOOCH}/100$ g. of H_2O at 10°C), forming highly mobile, colorless, odorless, completely stable liquids with high densities. Densities of saturated solutions at 10, 20, 50 and 90°C : 3.31, 3.40, 4.10 and 4.76. Soluble with difficulty in alcohol. Readily soluble in methanol, from which it can be purified by crystallization.

B) THALLIUM (I) MALONATE

Thallium malonate can be prepared by treating Tl_2CO_3 with an equimolar quantity of malonic acid dissolved in water (solubility: 73.5% at 20°C) and evaporating. Thallium malonate deliquesces in air.

C) CLERICI'S SOLUTION

Clerici's solution is prepared by dissolving equal weights of thallium formate and malonate in the minimum amount of water.

The density of the saturated solution at 20°C is 4.324. The solution density may be reduced by addition of water and increased by evaporation. The refractive index is a strictly linear function of the density at constant temperature.

Clerici's solution which has picked up impurities in use and thus become brown (due to malonic acid decomposition products) can be regenerated, according to Rankama, by dilution of the concentrated solution to four times its volume with distilled water, treating with 1 g. of powdered charcoal per 100 g. of concentrated solution, heating, stirring and filtering. The solution is then clear. Thallium is precipitated from it as $TlCl$ and converted to Tl_2SO_4 with H_2SO_4 . The latter is then converted to $TlOH$ (see p. 877) by treatment with $Ba(OH)_3$, which is in turn converted to Tl_2CO_3 (see p. 884) by saturation of the hot solution with CO_2 and evaporation. After recrystallization, the Tl_2CO_3 is used as described above for the preparation of thallium formate and malonate.

REFERENCES:

- E. Clerici. Atti R. Accad. d. Lincei, Roma [5] 16, 1, 187 (1907); see also Z. Krystallogr. 46, 392 (1909);
J. S. Vhay and A. T. Williamson. Amer. Mineralogist 17, 561 (1932);
G. Brauer and H. Haag. Private communication (1952);
R. Jahns. Amer. Mineralogist 24, 116 (1939);
C. J. Payne, L. Franklin and B. W. Anderson. Gemmologist 5, 274 (1936);
K. Rankama. Bull. Commiss. Geol. Finlande 9, 65 (1936).

Alkaline Earth Metals

P. EHRLICH

Beryllium

Be

On a laboratory scale, beryllium is prepared by electrolysis of a mixture of molten beryllium fluoride and alkali or alkaline earth fluorides. The product obtained is 99.7% pure; the commercial material obtained by the same method is < 99%. Industrial electrolysis of beryllium chloride-alkali chloride melts yields beryllium with a purity usually greater than 99.8%.

Very high purity Be is obtained by Kroll's procedure (which is a modification of Sloman's method) which consists in vacuum distillation in the apparatus shown in Fig. 252. The relatively impure beryllium is placed in a BeO crucible and induction heated, and its vapor is condensed in a condensation hood. The latter is tightly joined to the crucible, but has an opening on top, so that the course of the distillation may be observed through a quartz peephole at the top of the apparatus. The BeO crucible is embedded in sintered, powdered BeO, which fills a retaining vessel of sintered alumina.

The whole assembly is placed in a quartz tube which is closed off on top by a special water-cooled adapter. This metallic adapter may be made either of compressed metal powder or of bronze impregnated with tin under vacuum. It is sealed to the quartz tube with high-vacuum silicone grease. The apparatus is connected to a high-vacuum pump by means of a flexible tombac tube. The distillation requires a vacuum of $< 10^{-3}$ mm.

The distillation of crude beryllium is connected with certain difficulties since the metal occludes the electrolyte and alkaline earth metals. These may cause bubbling and spattering of the metallic melt during the distillation. Therefore, preliminary degassing is carried out without the condensation hood until gas evolution ceases. After cooling, the condensation hood is installed, and after high vacuum has been restored the distillation is carried out at a temperature of 1400 to 1500°C. If beryllium flakes are used, they are first compressed and melted. This melt may be

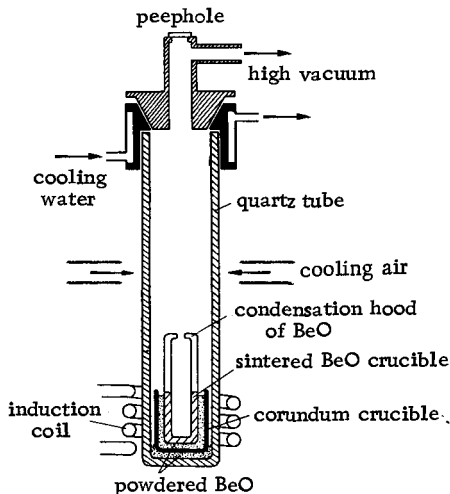

Fig. 252. High-vacuum distillation of beryllium.

distilled at once since it does not contain salt occlusions. The distillation is complete in about 20 minutes. The run is ended when about 75% of the charge has distilled. Depending on the operating temperature, the beryllium collects on the hood in the form of large globules or an incrustation (dendrites). The degree of purity should exceed 99.97%, neglecting the small quantity of oxygen that may be present.

The recovery of Be compounds from gadolinite is described in the section on scandium, yttrium and rare earth metals.

PROPERTIES:

Atomic weight 9.02.

M.p. 1280°C, b.p. 2970°C; crystallizes in structure type A3; brittle at room temperature, ductile at red heat.

In contact with water, Be becomes covered with a thin oxide layer but is not attacked further; however, it dissolves very vigorously in dilute acids.

REFERENCES:

- H. Funk, *Die Darstellung der Metalle im Laboratorium* [The Preparation of Metals in the Laboratory], Stuttgart, 1938, p. 28.
 W. Kroll, Beryllium, in: A. E. van Arkel, *Reine Metalle* [Pure Metals], Berlin, 1939, p. 99.
 W. Kroll, *Metallwirtschaft* 13, 725 (1934); *Metal. Ind.* 47, 29 (1935).
 H. A. Sloman, *J. Inst. Met.* 44, 365 (1932).

Beryllium Chloride

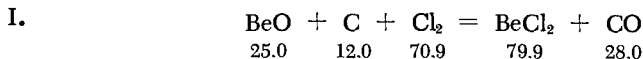

Beryllium halides do not attack Pyrex glass if the temperature is carefully controlled. Therefore, only the actual reaction apparatus must be of quartz, while vacuum sublimation and bottling may be carried out in Pyrex glass.

As shown in Fig. 253, the apparatus consists of a large quartz tube *A* (25-mm. diameter, 400 mm. long), which is connected with a gas drying system by means of a large ground glass joint; its other end is connected, by means of a small ground glass joint *a*, with a Pyrex apparatus. The latter consists of several cylindrical chambers *B*, *C*, *D* and *E* which serve as receivers and resublimation vessels for the halide. Chamber *D* is fitted with a side tube closed off by a breakable bulb. A system of storage bulbs (1, 2, 3, 4) is later sealed to the side arm.

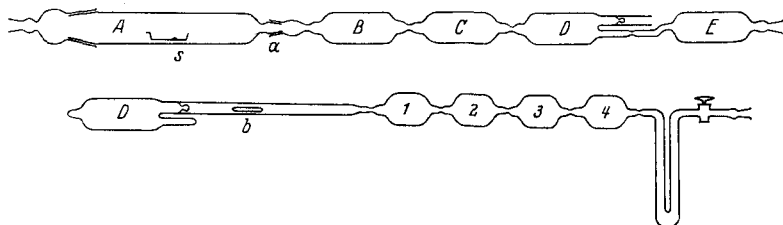

Fig. 253. Preparation and sublimation of beryllium chloride.

An intimate blend of 3.5 g. of BeO and 2.5 g. of charcoal made from calcined sugar is charged into a quartz boat *s*, which is then pushed into tube *A*. After removal of water and other impurities adsorbed on the carbon by heating to about 900°C in a stream of N₂, the nitrogen is replaced by Cl₂ and the reaction temperature is adjusted to 700°C. The sublimate of BeCl₂, which collects over a period of several hours, forms beautiful white, matted crystals in the rear section of tube *A*. After completion of the reaction, pure N₂ is reintroduced and the Pyrex apparatus is connected to joint *a*. The latter is not greased since no vacuum is applied. By proper positioning of the tubular furnace, the halide resublims and deposits in the first chamber *B*, while leaving a residue in *A*. The sublimation takes place at an adequate rate at 380°C. Joint *a* is then melt-sealed at its narrowest point and the apparatus is connected to the high-vacuum pump. A forerun is then sublimed into the fourth chamber *E* by shifting the furnace.

The furnace is then shifted back and the bulk of the material is sublimed into chamber *C*. This may be done at 330°C, provided a high vacuum is maintained. Chamber *B*, still containing a residue, is removed by sealing off.

The material is then resublimed from *C* into *D*. Thus, only chamber *D*, completely evacuated and sealed off on both sides, remains of the entire Pyrex apparatus. The vacuum pump must operate continuously during these sublimations since it has been found impossible to carry them out in an evacuated and sealed apparatus. Small amounts of gas are desorbed from the glass walls, thus decreasing the vacuum. This in turn raises the sublimation temperature. At these higher temperatures, traces of BeCl_2 react with the glass, forming $\text{BeO} + \text{SiCl}_4$, which again leads to deterioration of the vacuum until the sublimation ceases altogether and liquid SiCl_4 forms at the coldest spot. It is best to carry out the entire operation without interruption over a period of about 30 hours.

To bottle BeCl_2 , a 10-cm.-long glass tube is attached to the side tube of *D*, a small glass-covered steel rod *b* is pushed in, and finally the four-bulb assembly is sealed on. The apparatus is connected to the vacuum pump via a ground-glass joint, a cold trap and a stopcock. After thorough heating, the stopcock is closed, the apparatus is detached from the pump, and the little glass bulb is broken by moving *b* with a magnet. The beryllium chloride is sublimed into the individual bulbs at the highest vacuum obtainable, while the trap is cooled with liquid nitrogen; this operation requires about four hours per bulb.

Other preparative methods: The reaction of beryllium with Cl_2 and HCl (II) or the treatment of BeO with CCl_4 (III) may also be recommended.

PROPERTIES:

Snow-white crystals or crystalline mass. M.p. 405°C, b.p. 488°C; d 1.90. Extremely hygroscopic; dissolution in water is highly exothermic. The solution is strongly acid due to hydrolytic cleavage. On evaporation, the hydrate $\text{BeCl}_2 \cdot 4\text{H}_2\text{O}$ crystallizes in monoclinic, deliquescent platelets if the hydrolysis is depressed by the addition of hydrochloric acid; otherwise, basic chlorides precipitate. Anhydrous BeCl_2 is readily soluble in alcohol and ether.

REFERENCES:

- I. O. Hönigschmid and T. Johannsen, *Z. Naturforsch.* **1**, 650 (1946); H. Remy, *Lehrbuch d. anorg. Chem.* [Textbook of Inorganic Chemistry] vol. I, Leipzig 1950, p. 257.

- II. O. Rahlfs and W. Fischer, *Z. anorg. allg. Chem.* **211**, 349 (1933).
 III. J. Besson, *Comptes Rendus Hebd. Séances Acad. Sci.* **214**, 861 (1942).

Beryllium Bromide

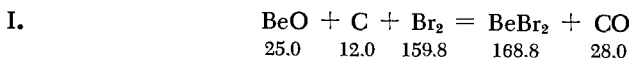

The directions for the preparation of BeCl_2 apply with the following modifications: a nitrogen stream charged with Br_2 vapor is passed over the $\text{BeO} + \text{C}$ mixture at 1200°C . This mixture is very corrosive to quartz. The first sublimation may be completed sufficiently rapidly at atmospheric pressure at 360°C ; for the following sublimations a temperature of 310°C is sufficient, provided a high vacuum is maintained.

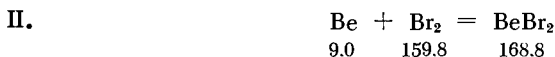

To prepare BeBr_2 directly from the elements, bromine is evaporated in a flask by heating with an infrared lamp and passed in a stream of argon over Be powder in a quartz tube at a temperature of 550°C . The end of the tube protrudes into a cold receiver consisting of a large glass cylinder. In order to avoid plugging of the tube in the transition zone, the interior of the tube is heated with an electrical winding to $450\text{--}500^\circ\text{C}$; the winding is surrounded by a small quartz tube which is sealed at one end. This quartz tube extends from the receiver into the hot zone of the reaction tube. The receiver is separated from the atmosphere by several wash bottles, which also serve as bubble counters.

The anhydrous bromide product is transferred to storage vessels under an inert gas blanket. The yield is 200–250 g. in six hours.

PROPERTIES:

Long, white needles. M.p. 488°C , with sublimation beginning at 360°C ; d 3.47. Very hygroscopic; large heat of solution. The tetrahydrate crystallizes as rod-shaped, hygroscopic crystals when the BeBr_2 solution is evaporated to a sirupy consistency. Gaseous HBr must be added to the solution to avoid precipitation of basic salts due to hydrolysis.

REFERENCES:

- I. O. Höningsschmid and T. Johannsen, *Z. Naturforsch.* 1, 650 (1946).
 II. G. B. Wood and A. Brenner, *J. Electrochem. Soc.* 104, 29 (1957); see also O. Rahlfs and W. Fischer, *Z. anorg. allg. Chem.* 211, 349 (1933).

Beryllium Iodide

Beryllium iodide is formed via the reaction of gaseous I_2 (or a mixture of pure H_2 and I_2) with metallic Be in a quartz tube at dull red heat. It is best to work in a sealed tube; however, the metal and the solid iodine should not be blended with each other, since this may cause bursting of the tube during heating. The metal is inserted separately in a glass container so that it comes in contact only with the I_2 vapor. After 2-3 days at 480°C , little unreacted iodine remains. Thus, each tube contains 4 g. of Be (1.8 g. excess) and 63 g. of iodine. The subsequent sublimation, which gives a pure white product, is carried out as described for BeCl_2 ; however, it is preferable to work in all-quartz equipment in view of the higher temperatures.

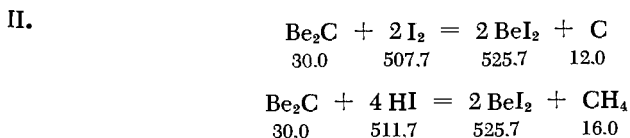

The iodide cannot be prepared in the same fashion as the chloride, i.e., by passing a nitrogen stream charged with I_2 over a mixture of $\text{BeO} + \text{C}$; Be_2C is required as the starting material.

In a quartz tube at about 700°C , Be_2C is allowed to react with carefully purified and dried HI or with a hydrogen stream containing I_2 vapor. The subsequent purification by sublimation is the same as that described above for BeCl_2 .

PROPERTIES:

White needles. M.p. 480°C , b.p. 488°C . Very hygroscopic; hydrolyzes vigorously, evolving HI.

REFERENCES:

- I. G. B. Wood and A. Brenner, *J. Electrochem. Soc.* 104, 29 (1957); see also O. Rahlfs and W. Fischer, *Z. anorg. allg. Chem.* 211, 349 (1933).
- II. P. Lebeau, *Ann. Chim.* [7] 16, 476, 490 (1899); C. Messerknecht and W. Biltz, *Z. anorg. allg. Chem.* 148, 152 (1925).

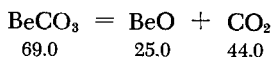
Beryllium Oxide and Beryllium Carbonate

Commercial beryllium carbonate, which usually contains more than 1% of impurities, is mixed in a platinum vessel with hot, twice-distilled acetic acid and the hot solution is filtered through a platinum Gooch crucible. The basic acetate separates as fine crystals on rapid chilling; it is recrystallized from glacial acetic acid three times. Each time, the salt is separated by means of a platinum basket centrifuge. After this preliminary purification, the acetate is sublimed at a temperature of 250°C in a large-diameter glass tube with a stream of pure, dry air flowing through the apparatus. The sublimate is heated in a degassed Pyrex flask with pure concentrated nitric acid to convert it to the nitrate. The latter may be calcined to the oxide at 1100°C; however, the oxide thus prepared always contains about 0.35 ml. of gas (N₂, O₂) per gram of substance.

Very pure oxide may be obtained when the beryllium nitrate prepared as described above is reconverted to the carbonate. An acid solution of the nitrate is evaporated in a platinum dish to remove excess acid, the residue is dissolved in some water, and enough distilled ammonium carbonate solution is added to redissolve the initially precipitated beryllium carbonate and give a clear solution. The solution is then evaporated in a platinum dish until all the beryllium carbonate has separated as a coarse precipitate. After thorough washing with pure water and then with freshly distilled alcohol, the product is dried and finally calcined to the oxide in a platinum vessel placed in an electric furnace at 900°C.

PROPERTIES:

White, loose powder. M.p. 2530°C; d 29. Very sparingly soluble in water (about 0.20 g. per liter). Its solubility in acids depends upon the calcination temperature; dissolves most readily in hydrofluoric acid. Crystallizes in structure type B4.

REFERENCE:

O. Hönigschmid and T. Johannsen, Z. Naturforsch. 1, 650 (1946).

Beryllium Hydroxide

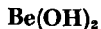

Two crystalline modifications may be obtained, the metastable α -Be(OH)₂ and the stable β -Be(OH)₂.

α -Be(OH)₂

The α form is the primary product of aging of amorphous beryllium hydroxide, which is obtained by the precipitation of a beryllium salt solution with ammonia in the absence of CO₂; α -Be(OH)₂ is then obtained by prolonged heating (about 24 hours) of the amorphous precipitate with 10% ammonium hydroxide solution.

A very pure material may be obtained by electro dialysis of amorphous beryllium hydroxide. This is a slow procedure and takes several days.

β -Be(OH)₂

The beta modification is best prepared by slow hydrolysis of sodium beryllate. Boiling 10N NaOH solution is saturated with pure, amorphous beryllium hydroxide until a permanent turbidity is just evident. A sandy, finely crystalline product separates upon slow cooling. Under the microscope, the crystals appear as beautiful, regular double pyramids. They may be purified, without changing their appearance, with warm water until they no longer show an alkaline reaction; the crystals are then dried at 80°C.

The same mother liquor may be reused several times in the saturation and crystallization sequence.

PROPERTIES:

Formula weight 43.04, d 1.92. Crystalline beryllium hydroxide is very slightly soluble in water and in dilute alkali. Both forms are readily soluble in hot concentrated sodium hydroxide.

REFERENCES:

- L. Havestad and R. Fricke, Z. anorg. allg. Chem. 188, 357 (1930).
R. Fricke and B. Wullhorst, Z. anorg. allg. Chem. 205, 127 (1932).
R. Fricke and G. F. Huttig, Hydroxyde und Oxydhydrate [Hydroxides and Hydrated Oxides], Leipzig 1937, p. 12, as well as the literature cited there.

Sodium Beryllates

I. Concentrated sodium hydroxide saturated with beryllium hydroxide, or alcoholic potassium hydroxide saturated with potassium beryllate, both prepared with exclusion of CO_2 , is filtered in the presence of KOH through an asbestos filter in a silver funnel. The filtrate is vacuum-evaporated in a nickel dish in the presence of H_2SO_4 and KOH. The first precipitate consists of Na_2CO_3 and some $\text{Be}(\text{OH})_2$. As soon as the separation of the snow-white, shining sodium beryllate begins, the filtration is repeated and the solution further evaporated. The product is washed with alcohol and dried in a vacuum desiccator.

II. Monosodium beryllate and $\text{Be}(\text{OH})_2$ exist as the solid-phase components in the system $\text{BeO-NaOH-H}_2\text{O}$ at 30°C , when the concentrations of NaOH and BeOH are about 33% and 4.3%, respectively; at higher sodium hydroxide concentrations, monosodium beryllate is the only solid-phase component.

III. Sodium orthoberyllate with the formula Na_4BeO_3 is obtained as a white powder via the reaction of Na_2O with BeO in a silver boat at 500°C . For techniques of working with exclusion of CO_2 and atmospheric moisture, see Part I, the section on orthostannates and the original literature.

PROPERTIES:

Strongly hygroscopic crystals, decomposed by atmospheric CO_2 .

REFERENCES:

- I. G. Krüss and H. Moraht, *Liebigs Ann. Chem.* 260, 174 (1890).
- II. R. Fricke, A. Münchmeyer and F. Engelhardt, *Z. anorg. allg. Chem.* 166, 247 (1927).
- III. E. Zintl and W. Morawietz, *Z. anorg. allg. Chem.* 236, 372 (1938).

Beryllium Sulfide

BeS

Beryllium sulfide may be prepared either by (I) synthesis from the elements, (II) reaction of the chloride with H_2S (which, however, does not yield chlorine-free material), or (III) from BeSO_4 or BeO .

The last two methods should be used only when metallic Be is unavailable.



Sulfur vapor mixed with H_2 is passed over pure Be at a temperature of about 1150°C . The ground glass apparatus, shown in Fig.

254, consists essentially of a quartz tube with an enlargement at one end to serve as a sulfur receiver; the Be is contained in a boat made of quartz or, still better, of Al_2O_3 or BeO , and placed at the center of the quartz tube. To obtain a quantitative reaction, the product of the first run is finely pulverized in an agate mortar and again reacted with the sulfur vapor.

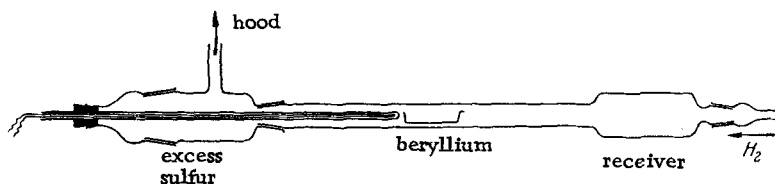
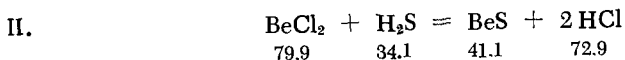

Fig. 254. Preparation of beryllium sulfide.

Von Wartenberg simplified the process as follows: a quartz tube of 15-mm. diameter and 700-mm. length, sealed at the lower end, is charged with 6 g. of Be and 30 g. of distilled S; the tube is slipped into a platinum-wound furnace, which is inclined at a 45° angle; the Be is first ground in a coffee mill and screened to give particles 0.2-0.5 mm. in diameter. The furnace is heated to 1350°C for about two hours; the sulfur evaporates constantly and flows back down the protruding portion of the tube, which acts as a reflux condenser. The sulfur vapor thus excludes air. After removal and cooling of the tube, its lower end is cut off and the easily removed, sintered cake is crushed and again treated with sulfur in the same fashion. The cut-off tube end may be resealed on a new tube section. After the cake is freed of sulfur under vacuum, it still contains Be flakes, which, however, can be separated by pulverizing and screening (0.1-mm. screen) to such an extent that the dirty yellow powder, which still retains a faint odor, no longer evolves H_2 when added to dilute acids. Analysis shows a BeS content of 98% on the basis of the determination of H_2S evolved; however, 2.4% of the product is insoluble in dilute H_2SO_4 .



Beryllium chloride, obtained by passing HCl over a red-hot mixture of $\text{BeO} + \text{C}$, is purified as thoroughly as possible by repeated sublimation in a quartz tube. Without opening the apparatus, the BeCl_2 is reacted with pure H_2S (prepared from S and H_2). Too rapid sublimation of the BeCl_2 (at about 400°C) must be avoided by

increasing the temperature only very gradually if a satisfactory yield is to be obtained. Furthermore, the reaction must be localized by means of a water-cooled quartz tube, which is inserted in the quartz reaction tube. The chloride should be sublimed in the H_2S stream back and forth several times. The product, which still has a high chlorine content, is heated at 850 to 950° in the H_2S stream for an additional hour. This yields a grayish, amorphous sulfide which still contains traces of chloride and which is less stable in air than the product made by method I.

III. Other preparative methods are the dry reduction of $BeSO_4$ with agents containing no hydrogen, e.g., S vapor, CO, CaC_2 , Zn or Al. The best yields are obtained with Al (97%, based on $BeSO_4$). The reduction begins at 560°C.

Beryllium sulfide may also be obtained by reaction of CS_2 with BeO at temperatures above 1200°C.

PROPERTIES:

Gray to white powder with a faint odor of H_2S when exposed to air. Crystallizes in structure type B3 (ZnS). d 2.36.

REFERENCES:

- I. H. von Wartenberg, *Z. anorg. allg. Chem.* **252**, 136 (1943).
- II. E. Tiede and F. Goldschmidt, *Ber. dtsh. chem. Ges.* **62**, 758 (1929).
- III. P. Silber, *Ann. Chim.* (12) **7**, 182 (1952).

Beryllium Selenide and Beryllium Telluride

BeSe, BeTe

BeSe

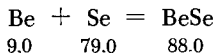

Beryllium selenide is prepared from the elements in a H_2 stream at 1100°C. Pure Se and pure pulverized Be are placed in a quartz reaction tube in separate boats made of Al_2O_3 or BeO, (or at least of quartz). The hydrogen should pass first over the heated Se and then, when laden with its vapor, over the Be. A wash bottle filled with lead acetate is mounted at the exit end of the reaction tube to absorb the very toxic H_2Se present in the discharged gas. The Se is heated with a Bunsen burner; the uniform heat of an electric furnace is required for the Be. The BeSe so obtained often shows a tendency to crystallize in long needles.

BeTe

Beryllium telluride can be prepared from the elements by the same method.

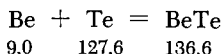

PROPERTIES:

Gray powders, decomposing relatively rapidly in air. Crystallize in structure type B3 (ZnS type). d (BeSe) 4.32, d (BeTe) 5.09.

REFERENCE:

Private communication from E. Tiede.

Beryllium Nitride

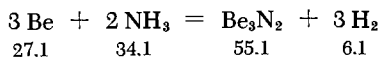

Instead of synthesizing the nitride from the elements, it may be obtained more easily and in higher yield by heating metallic Be in an NH_3 stream.

The commercial metal is crushed in a steel mortar and screened through a 100-mesh (per inch) sieve; the powder is placed in a corundum boat, which is heated in a porcelain tube in a dry NH_3 stream at 850°C for three hours. The reaction product is then pulverized in an agate mortar and heated in the NH_3 stream at 1000°C ; this procedure is repeated three times. The product so obtained usually contains only 94–95% Be_3N_2 . A purer product might be obtained by the use of metal distilled in high vacuum and by careful manipulation.

PROPERTIES:

Gray-white powder; stable in air; decomposes rather slowly on contact with boiling acids. Crystallizes in structure type D5₃ (C sesquioxide type).

REFERENCES:

- F. Fichter and E. Brunner, *Z. anorg. allg. Chem.* 93, 86 (1915).
 J. Rieber, Thesis, Hannover, 1930.
 M. von Stackelberg and R. Paulus, *Z. phys. Chem. (B)* 22, 305 (1933).

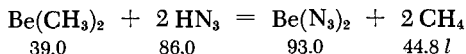
Beryllium Azide

Pure dimethylberyllium is sublimed into a reaction vessel cooled with liquid N_2 ; then an absolutely dry ether solution of excess HN_3 is condensed on top of the dimethylberyllium layer. As the reaction mixture thaws, a vigorous reaction with evolution of methane starts even before all of the ether is melted (m.p. -116°C), and $\text{Be}(\text{N}_3)_2$ separates out as a white precipitate. The ether and excess HN_3 are then distilled off under high vacuum.

PROPERTIES:

White, solid substance; explosive in the presence of a flame; insensitive to shock. Rapidly decomposed in moist air. Hydrolyzes in aqueous solution to such an extent that the substance may not be recovered undecomposed even when the solvent is very carefully distilled off in a high vacuum.

REFERENCE:

E. Wiberg and H. Michaud, *Z. Naturforsch.* 9 b, 502 (1954).

Beryllium Carbides **Be_2C** 

A mixture of metallic Be (turnings or powder) and finely divided graphite or calcined acetylene black is reacted at 1700° for 20 to 30 minutes. The yield is 85%.

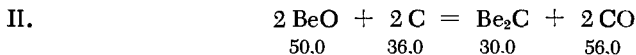

A blend of calcined BeO and half its weight of carbon made from sugar is mixed with 5% of starch and 15% of water, compressed into cylinders, dried, calcined, and finally heated in H_2 at two

atmospheres gauge and 1930°C for 10 to 15 minutes; an 85-92% pure product is obtained as beautiful, brick-red crystals. The reaction does not start below 1700°C, but the carbide decomposes extensively above 2200°C. For this reason, the more convenient electric arc furnace process is not recommended. According to Messersknecht and Biltz, the simplest form of the arc process apparatus consists of a graphite crucible with a carbon electrode immersed in the reactant mixture (110v., 30 amp.).

Low concentration products may be enriched by treatment with hot dilute hydrochloric acid (however, a portion of the carbide is lost by decomposition). The excess C may thus be decanted and the BeO dissolved. In this manner, an enrichment to more than 95% Be₂C is possible; the balance is BeO and free C.

PROPERTIES:

Yellow-red, finely crystalline powder, slowly decomposing in moist air. Crystallizes in structure type C1 (antifluorite type).

REFERENCES:

- I. G. Oesterheld, *Z. anorg. Chem.* **97**, 1 (1916); M. W. Mallett, E. A. Durbin, M. C. Udy, D. A. Vaughan and E. A. Center, *J. Electrochem. Soc.* **101**, 298 (1954).
- II. F. Fichter and E. Brunner, *Z. anorg. Chem.* **93**, 91 (1915); J. Kielland and L. Tronstad, *Kong. Norske Vidensk. Selsk. Forhandl.* **8**, 147 (1936); P. Lebeau, *Comptes Rendus Hebd. Séances Acad. Sci.* **121**, 496 (1895); C. Messersknecht and W. Biltz, *Z. anorg. allg. Chem.* **148**, 153 (1925); M. von Stakkelberg and F. Quatram, *Z. phys. Chem.* (B) **27**, 50 (1934).

BeC₂

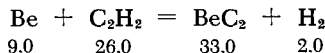

According to Durand, BeC₂ is formed by passing dry acetylene at 450°C over Be powder in a Pyrex tube. The product appears black due to free C formed via thermal decomposition of the acetylene.

PROPERTIES:

Generates acetylene with H₂O and (moderately) with dilute HCl.

REFERENCE:

J. F. Durand, *Bull. Soc. Chim. France* [4] **35**, 1141 (1924).

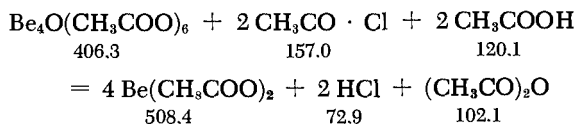
Beryllium Acetate

Basic beryllium acetate (4 g.) is dissolved in 50 ml. of boiling glacial acetic acid and refluxed with 4-5 g. of acetyl chloride for a short time. The precipitate of $\text{Be}(\text{CH}_3\text{COO})_2$ forming after a few minutes is filtered off, washed with glacial acetic acid and with cold chloroform, and dried in a vacuum desiccator. The yield is 90-94%.

PROPERTIES:

Stable for several weeks in a closed vessel at room temperature. Slowly splits off acetic anhydride (rapidly when heated) and is converted to basic beryllium acetate, which sublimes. Undergoes partial decomposition to acetic anhydride and beryllium oxide when heated rapidly.

Barely attacked by cold water, is hydrated at elevated temperature. Insoluble in all solvents for basic beryllium acetate.

REFERENCE:

J. Besson and H. D. Hardt, *Z. anorg. allg. Chem.* 277, 188 (1954).

Basic Beryllium Acetate

I. Basic beryllium carbonate (40 g.) is mixed with 80 ml. of glacial acetic acid and stirred, with heating, until CO_2 evolution ceases. The end of the reaction is also recognized by the start of precipitation of white, semitranslucent crystals; otherwise, there is an amorphous, white residue. The solution is cooled to room temperature and the crystallized basic acetate is filtered off and dried in air.

The crude product is treated with 60-80 ml. of chloroform, and any insoluble residue is removed by filtration. The basic salt, which crystallizes in colorless octahedra, is filtered off and freed of residual chloroform in a vacuum desiccator. The product melts at 284°C and sublimes without a residue at reduced pressure. The yield is 28 g.

II. A method described by Hardt avoids contamination of the product by ammonium salts and solvent occlusions and makes purification by sublimation unnecessary.

Beryllium hydroxide or basic beryllium carbonate is stirred with glacial acetic acid to a paste and evaporated to dryness in a laboratory oven at 120 to 130°C. The crude product thus formed is extracted with glacial acetic acid in a Soxhlet apparatus (using a glass wool filter); after cooling, it crystallizes from the extract in well-formed octahedra, which are filtered off and dried at 130°C.

This is followed by a second Soxhlet extraction with CCl_4 , since the ammonium salts from the starting material still remain undissolved. The product is analytically pure after drying at 100°C.

PROPERTIES:

At room temperature the molecular lattice is of the space group $T_n^4(\alpha)$. Transition to other modifications (γ , β) occurs at 150 to 155°C. Very soluble in chloroform; readily soluble in boiling benzene, toluene, xylene, Tetralin and glacial acetic acid; less soluble in CCl_4 , acetic anhydride and acetyl chloride; sparingly soluble (0.3%) in diethyl ether.

In anhydrous boiling methanol following initial dissolution, splits off acetic anhydride with formation of highly aggregated basic acetates.

Quite stable in cold water, but is rapidly hydrolyzed in hot water.

Begins to sublime at about 200°C, softens at about 280°C to a nematic or smectic (liquid crystal) state and melts at 183 to 184°C with sublimation. May be distilled at 1-2 atmospheres gauge. Pure basic beryllium acetate leaves a residue of 0.3-0.5% BeO after sublimation.

For the preparation of basic beryllium formate and basic beryllium propionate, see the literature cited under II; also H. Hendus and H. D. Hardt, *Z. anorg. allg. Chem.* 277, 127 (1954).

REFERENCES:

- F. Haber and G. van Oordt, *Z. anorg. allg. Chem.* 40, 465 (1904).
A. Stock, P. Praetorius and O. Priess, *Ber. dtsh. chem. Ges.* 58, 1571 (1925). *Übungsbeispiele aus der anorg. Experimentalchemie* [Practical Experiments in Inorganic Chemistry], Leipzig 1920, p. 212.
I. T. Moeller, A.J. Cohen and E. Marvell in: L.F. Audrieth, *Inorganic Syntheses*, Vol. III, New York-Toronto-London 1950, p. 9. p. 9.
II. J. Besson and H. D. Hardt, *Z. anorg. allg. Chem.* 277, 188 (1954); H. Hendus and H. D. Hardt, *Z. anorg. allg. Chem.* 286, 265 (1956); H. D. Hardt, *Z. anorg. allg. Chem.* 286, 254 (1956).

Magnesium

Mg

Generally, very pure magnesium is prepared by refining commercial magnesium via distillation or, still better, by sublimation in high vacuum.

Magnesium is usually made commercially by electrolysis of molten, dehydrated carnallite ($\text{MgCl}_2 \cdot \text{KCl}$), with an Acheson graphite anode and an iron cathode.

The crude metal obtained by electrolysis contains up to 2.7% Cl, besides other impurities (Fe, Al, Si, N). Purification is effected by melting with fluxing agents or, better, by repeated filtration. This may be done simply by pushing a sheet iron screen downward through the melt. This reduces the chlorine content considerably (final content: 0.003% Cl).

Another method of purification consists in refining with Zr. Addition of 2-4% of ZrCl_4 to Mg melts results in precipitation of Fe, Al, Si and Mn but not of Cu. The Zr can be removed by subsequent passage of H_2 , still retaining the degree of purity previously achieved. Magnesium thus prepared is highly resistant to corrosion.

Pure magnesium (99.9%), absolutely free of halogen, is obtained by the Radentheiner process.

I. SUBLIMATION OF THE CRUDE METAL

In the laboratory, the following simplified method may be used: the sublimation vessel shown in Fig. 255 (see also the apparatus described for the distillation of Ca) consists of an iron tube (60-mm. diameter and 500 mm. long), which is closed at one end and has a threaded vacuum-tight lid on the other. The lid is fitted with a nipple for connection to a high-vacuum system. The lower end of this retort contains an iron tube f with the crude magnesium; the open end of the tube is preferably closed by one or two fine-mesh wire screens which are clamped to the tube. The conical iron tube e is inserted into the colder zone of the sublimation vessel. The tube consists of two halves held together by rings (see Fig. 255). Before the preparation, the interior walls of the tube are dusted with MgO in order to prevent sticking of the condensate.

The sublimation temperature is stated in the literature to be about 600°C at a vacuum of 10^{-3} mm. If the condensing surface is at 400 to 500°C , the crystals will be dendritic; larger quantities agglomerate to massive blocks. At higher temperatures (600°C), large single crystals are formed.

The metal obtained after a single sublimation contains Fe, Al, Si and Cl in amounts less than 0.001%. After repeated sublimation the impurities cannot be identified either chemically or spectroscopically. The sublimed metal can be remelted in an argon atmosphere at 300–400 mm.

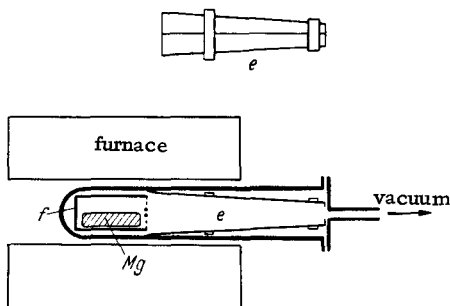

Fig. 255. Purification of magnesium by sublimation.

II. When larger quantities (about 1 kg.) must be sublimed in a single operation, the metal is condensed in an apparatus of larger capacity, using a water-cooled cylinder.

PROPERTIES:

Atomic weight 24.32. M.p. 650°C, b.p. 1102°C; d 1.737. Crystallizes in structure type A3.

Cold water reacts only slowly with magnesium; the reaction is much more rapid in boiling water. The metal dissolves violently in acids.

REFERENCES:

- Gmelin, *Handb. d. anorgan. Chemie*, 8th ed., Vol. 27B (Magnesium), p. 121.
- H. Funk, *Die Darstellung der Metalle im Laboratorium* [Preparation of Metals in the Laboratory] Stuttgart 1938, p. 26.
- K. E. Mann, *Z. Metallkunde* **44**, 264 (1953).
- I. W. Kaufmann and P. Siedler, *Z. Elektrochem.* **37**, 492 (1931).
- II. I. Hérenguel and G. Chaudron, *Comptes Rendus Hebd. Séances Acad. Sci.* **193**, 771 (1931); **195**, 1272 (1932); see also G. Chaudron in *A. E. van Arkel, Reine Metalle* [Pure Metals], Berlin 1939, p. 111.

Magnesium Hydride

Magnesium and hydrogen react at 570°C and 200 atmospheres in the presence of MgI_2 as a hydrogen transfer agent to form MgH_2 . The yield is 60%.

II. Magnesium hydride is formed when magnesium dialkyls (diethyl, dibutyl, diphenyl) or the corresponding Grignard compounds are heated to 175–200°C under high vacuum for several hours.

PROPERTIES:

White, water-sensitive solid; not spontaneously combustible. Insoluble in ether; nonvolatile; stable to 280°C under vacuum.

REFERENCES:

- I. E. Wiberg, H. Goeltzer and R. Bauer, *Z. Naturforsch.* 6 b, 394 (1951); see also F. Ellinger et al. *J. Amer. Chem. Soc.* 77, 2647 (1955).
- II. E. Wiberg and R. Bauer, *Z. Naturforsch.* 5 b, 396 (1950); E. Wiberg and R. Bauer, *Chem. Ber.* 85, 593 (1952).

Magnesium ChlorideANHYDROUS MgCl_2

In the method developed by Richards, MgCl_2 is prepared from a mixture of $\text{NH}_4\text{Cl} + \text{MgCl} \cdot 6\text{H}_2\text{O}$ or from the double salt $\text{NH}_4\text{Cl} \cdot \text{MgCl}_2 \cdot 6\text{H}_2\text{O}$ by dehydration in a HCl stream. The reaction of MgO with a gas mixture of CO and Cl_2 is much better suited for the preparation of larger quantities (more than 100 g.).

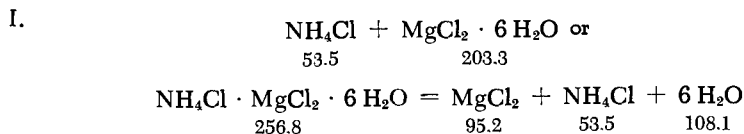

Equimolar quantities of $\text{MgCl}_2 \cdot 6\text{H}_2\text{O}$ and NH_4Cl are crystallized from aqueous solution somewhat above 50°C. After separating

the mother liquor at this temperature the salt is recrystallized once, slightly predried and filled while still hot into a quartz boat, which is then inserted into a quartz tube. Dehydration in a dry HCl stream proceeds first at 100°C for three hours (avoid melting of the hydrated crystals), then at 250°C for one hour, and finally at 400°C for one hour. Finally, the product is quickly melted and freed of HCl while cooling in a stream of CO₂. The salt thus prepared contains about 0.1% MgO and 0.05% SiO₂; it may be stored over P₂O₅.

If high purity is not required, it will suffice to start with a mixture of NH₄Cl and MgCl₂ · 6H₂O.

The consumption of HCl may be reduced substantially through dehydration of the hexahydrate or of ammonium carnallite by heating at 200°C under vacuum or by storage in a desiccator over P₂O₅. The drying with HCl may then be started directly at 200°C.

Even though HCl begins to split off at 106°C when the hexahydrate is heated in air, it is possible to dry the material at 150°C without formation of undesirable amounts of basic salt, provided the evaporation is rapid. It is advisable to place the hexahydrate in a large porcelain dish covered with a wide funnel, which serves as a partial condenser of the hydrochloric acid vapors formed. Thus, the formation of the basic salt is reduced to a minimum. The dihydrate begins to crystallize at 180°C. At this point the melt is poured onto an aluminum sheet and crushed while still warm. This product still contains 2.3-2.8 moles of water per mole of MgCl₂.

According to Treadwell, the HCl may be recycled after drying with concentrated H₂SO₄, but this requires elaborate equipment; besides, traces of chlorosulfonic acid formed react with MgCl₂ to yield MgSO₄.

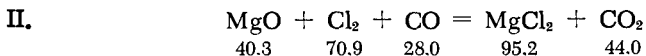

Magnesium oxide can be chlorinated quantitatively only in the presence of a reducing agent (CO). The reaction depends critically on the thermal pretreatment of the MgO; magnesium carbonate calcined at 800°C is still very reactive. Commercial CO in cylinders is not suitable, since the H₂ it contains forms water, which damages the apparatus; for this application CO is prepared in a small generator.

a. Carbon monoxide generator. The reactor is a vertically mounted quartz tube with an I.D. of 20 mm. and length of 600 mm., which is maintained at about 950°C. A somewhat narrower, sealed-off quartz tube is pushed into the lower hot zone; this tube serves as a retaining grating. The reactor is charged

with dry activated carbon of 5-mm. particle size and may be refilled through a side arm sealed on at the upper end. To start the reaction, CO_2 from a cylinder is added from the top. A small CO flame is allowed to burn at a capillary branching off from the outlet tube to provide a simple test for the CO content of the generated gas. The outlet gas passes through a pressure relief valve and a bubble counter and is then mixed with Cl_2 , which is metered by the same method.

b. Magnesium oxide furnace. The reaction vessel is a vertically mounted, 700-mm.-long quartz tube with an I. D. of 35 mm. In the lower portion there is a 4-mm.-diameter, funnel-shaped, centered drip nozzle filled with a layer of quartz fragments to support a charge of 500 g. of MgO . The gas flow rate is 400 ml./min. (200 ml. Cl_2 + 200 ml. CO), and the reaction temperature is 750°C . The exit gas has a 1% excess of CO and this ensures that the Cl_2 content is kept below $3 \cdot 10^{-5}\%$. The gases flow upward, countercurrent to the salt, which drips down. The salt drops emerging from the nozzle should fall free into the receiver which is mounted underneath by means of a ground glass joint. The pure white, brittle rods and grains of MgCl_2 may be easily removed later. However, the entire oxide charge must be wetted with molten chloride before the first drops appear. This occurs only 2-3 hours after the start of the chlorination.

The exit gases from the top of the reactor pass a small dust collector, which retains, aside from the dust, the impurities of the oxide. The gases are then vented. Through a capillary branching off the gas discharge line, a small gas stream may be diverted to a Bunsen flame containing a glowing copper wire. In this way one may test the gas composition. The desired excess of CO can be recognized by a faintly blue cast; traces of Cl give a green copper flame (Beilstein test).

PROPERTIES:

Leafy crystalline mass. Melts at 712°C to a water-clear, mobile liquid. May be distilled at bright red heat in a H_2 stream. d 2.41. More hygroscopic than the chlorides of the higher alkaline earth metals. Liberates Cl_2 when heated to 300°C forming oxides and oxychlorides.

REFERENCE:

1. T. W. Richards and H. G. Parker, *Z. anorg. Chem.* 13, 81 (1897); W. Biltz and G. F. Hüttig, *Z. anorg. allg. Chem.* 119, 116 (1921); W. Biltz and W. Klemm, *Z. phys. Chem.* 110, 331 (1924); W. D. Treadwell and T. Zürzer, *Helv. Chim. Acta* 15, 1271 (1932); K. K. Kelley and G. E. Moore, *J. Amer. Chem.*

Soc. 65, 1264 (1943); J. S. Peake and W. L. Fielder, Proc. Indian Acad. Sci. 63, 113 (1953).

- II. W. D. Treadwell, A. Cohen and T. Zürcher, Helv. Chim. Acta 22, 449 (1939).

$MgCl_2 \cdot 6 H_2O$

Very pure material may be prepared from 500 g. of commercial $MgCl_2 \cdot 6 H_2O$, which is dissolved in water. The solution is saturated with H_2S , some ammonia is added, and the solution is kept warm for several days. The supernatant solution is decanted and Ca is precipitated from it by the addition of a small amount of very pure ammonium oxalate. After settling, the decanting is repeated. The filtrate is tested for completion of the reaction by repeated addition of oxalate, followed by long settling.

The clear solution is evaporated and the salt is calcined. The mixture of MgO and oxychloride thus obtained is washed on a filter for 60 hours with distilled water until the wash water no longer contains any Na and K. Nevertheless, the Mg salt redissolved in pure distilled hydrochloric acid may not be free of these metals; the procedure described above must then be repeated until no further traces of Na and K can be detected.

On concentration, the $MgCl_2 \cdot 6 H_2O$ precipitates from the aqueous solution between -3 and $+116^\circ C$.

Quartz should be used if no platinum equipment is available. It is advisable to use electric heating to avoid contamination by the gases of the flame (sulfur).

PROPERTIES:

The hexahydrate forms bitter, deliquescent, monoclinic crystals. d 1.56.

AMMONIUM CARNALLITE

The ammonium chloride required for the preparation of the double salt is treated with nitric acid to break down any amines and is then dried and sublimed several times. It is then recrystallized 5 to 6 times, and finally repeatedly sublimed in a stream of pure air (which is washed with concentrated K_2CO_3 and concentrated H_2SO_4).

The pure double salt is crystallized from a mixture of one mole of $MgCl_2 \cdot 6 H_2O$ in 30 ml. of water and one mole of NH_4Cl in 70 ml. of water above $50^\circ C$ (preferably after boiling for a few minutes).

REFERENCES:

- T. W. Richards and H. G. Parker, Z. anorg. Chem. 13, 81 (1897).
E. H. Archibald, The Preparation of Pure Inorganic Substances, New York, 1932, p. 89.

For the preparation of the tetra-, di- and monohydrates of MgCl_2 see: C. H. Shomate and E. H. Huffman, *J. Amer. Chem. Soc.* 65, 1625 (1943); see also R. Manocha and G. Sternheim, *J. Sci. Ind. Res.* 15 B, 375 (1956).

Magnesium Bromide

MgBr_2

Magnesium bromide can be obtained by dehydration of the hexahydrate in a stream of HBr (I) or via the reaction of Br_2 with Mg in anhydrous diethyl ether (II).

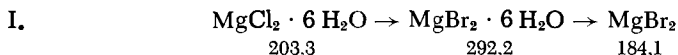

The hydroxide is precipitated with ammonia from MgCl_2 solution. It is then washed until the dissolved sample is halogen-free, suspended in water, and dissolved by the introduction of HBr gas. The salt obtained by concentrating the solution is recrystallized and dehydrated in a stream of HBr . Traces of HBr are removed by heating in dry, oxygen-free N_2 .

If higher purity material is desired, quartz equipment must be used. Ground glass joint apparatus prevents contact of the salt with the atmosphere. The procedure follows the Baxter method for the preparation of alkaline earth halides.



Pure Br_2 is evaporated at 50 to 55°C in a wash bottle and carried by a stream of dry N_2 (15 ml./minute) to the bottom of a round, 500-ml. flask. The flask contains 150 ml. of freshly distilled, anhydrous ether and 10 g. of clean Mg turnings. It is equipped with a high-speed stirrer and a CaCl_2 tube on the gas outlet tube (to exclude atmospheric moisture). Externally the flask is cooled to below room temperature to remove the considerable heat of reaction.

The reaction is stopped when 15 ml. of Br_2 has evaporated. The liquid is decanted into a dry flask and crystallization of the MgBr_2 trietherate is initiated by cooling below 0°C. The mother liquor is discarded. The crystals are immediately treated with anhydrous benzene and allowed to stand at room temperature. The ether-benzene mixture dissolves most of the impurities, while MgBr_2 is only slightly soluble in it. The suspension is then again cooled to 0°C; the crystals are rapidly filtered off and washed

with cold (0°C) benzene. The ether is removed by a water jet aspirator and the etherate is decomposed by raising the temperature to 150–175°C over a period of a few hours. Oil-pump vacuum is applied for one hour to remove residual ether. The yield of MgBr_2 is 60–70%. The salt is 99.3–99.6% pure; without the benzene purification step, the purity is only 90–95%.

PROPERTIES:

Pure white salt. M.p. 711°C; d 3.72. Crystallizes in structure type C6. Very hygroscopic. The melt is decomposed by atmospheric oxygen and turns yellow, forming MgO and Br_2 .

PROPERTIES:

- I. M. Linhard and M. Stephan, *Z. phys. Chem. (A)* 167, 88 (1933); G. F. Baxter and F. N. Brink, *J. Amer. Chem. Soc.* 30, 47 (1908).
- II. H. H. Rowley, *J. Amer. Chem. Soc.* 72, 3305 (1950); B. Menshutkin, *Z. anorg. Chem.* 49, 40 (1906); W. Biltz and G. F. Hüttig, *Z. anorg. allg. Chem.* 119, 115 (1921).

Magnesium Iodide

MgI_2

Magnesium iodide can be prepared either by dehydration of its hydrate in an HI stream (I), from the elements (II), or via the reaction of I_2 and Mg in anhydrous ether (III).

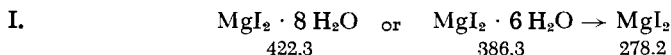

The method is analogous to method (I) for MgBr_2 .



Clean Mg turnings (0.5 g.) are heated to 600°C in a porcelain boat located in the center of a Vycor tube. The tube is evacuated and 5–6 g. of I_2 is placed at one end. The I_2 is sublimed repeatedly from one end of the tube to the other, thus passing over the Mg. Finally, the center only of the tube is heated. The I_2 then collects at the cold ends of the tube, while some Mg remains in the boat. The pure, white MgI_2 platelets deposit on either side of the boat. The tube must be cut open to remove the sublimate.

III. Anhydrous MgI_2 can also be obtained by decomposing the etherate under high vacuum at $230^\circ C$; the etherate may be prepared in the same way as described for $MgBr_2$ (Method II). The method does not seem to offer any special advantage.

PROPERTIES:

Hexagonal platelets. M.p. in hydrogen $650^\circ C$; d 4.43. Crystallizes in structure type C6 (layer lattice). Extremely hygroscopic. At room temperature, crystals of the octahydrate precipitate from aqueous solution; the hexahydrate is stable above $34^\circ C$.

REFERENCES:

- I. M. Linhard and M. Stephan, Z. physik. Chem. (A) 167, 88 (1933).
II, III. W. Blitz and G. F. Hüttig, Z. anorg. allg. Chem. 119, 115 (1921); W. Klemm, K. Beyersdorfer and J. Oryschkewitsch, Z. anorg. Chem. 256, 25 (1948).

Magnesium Oxide

MgO

Magnesium oxide is generally obtained by calcining easily decomposed magnesium compounds such as the hydroxide, the nitrate, the oxalate and other salts of organic acids. However, the principal raw material is the carbonate (the sulfate may also be converted to the oxide at high temperatures).

Basic magnesium carbonate is solidly packed into the lower half of a tall porcelain crucible. An electric crucible furnace is slowly heated. All the CO_2 is removed within about one hour at $600^\circ C$. The still hot crucible is rapidly cooled over P_2O_5 in a desiccator. The MgO is obtained as a loose, white mass which is readily soluble in dilute hydrochloric acid.

PROPERTIES:

Formula weight 40.32. M.p. $2642^\circ C$, b.p. $2800^\circ C$. Crystallizes in structure type B1; d 3.58. The physical properties and the chemical reactivity depend to a large extent on the method of preparation (starting material, calcining temperature, time).

REFERENCES:

Private Communication from E. Tiede.
Gmelin, Handb. der anorg. Chemie, 8th ed., Vol. 27 B (Magnesium) p. 12.

Magnesium Hydroxide



Magnesium hydroxide may be precipitated with alkali from solutions of magnesium salts. It may also be obtained by hydration of magnesium oxide and by the reaction of water with magnesium amalgams.

I. MICROCRYSTALLINE Mg(OH)_2 :

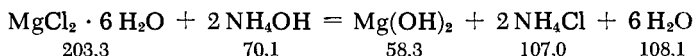

A solution of $\text{MgCl}_2 \cdot 6 \text{H}_2\text{O}$, almost saturated at room temperature, is treated with a large excess of concentrated ammonium hydroxide at 70°C , while high-speed agitation is maintained. Since Mg(OH)_2 is very sensitive to CO_2 , the distilled water employed must be thoroughly boiled before use. The ammonia used for the precipitation is prepared by passing NH_3 gas, from which CO_2 has been carefully removed with solid KOH , into CO_2 -free water. Because of the sensitivity of Mg(OH)_2 to silicic acid, only Pyrex glass vessels should be used.

After the precipitation, the material should remain submerged under the mother liquor for two days. During this time it is reheated to 70°C several times. The precipitate is purified first by washing with CO_2 -free water, then by centrifuging in paraffin-coated nickel tubes. Precipitation and washing are carried out in the apparatus shown in Fig. 256, which is self-explanatory. The substance is dried under vacuum, first over solid KOH and then over P_2O_5 .

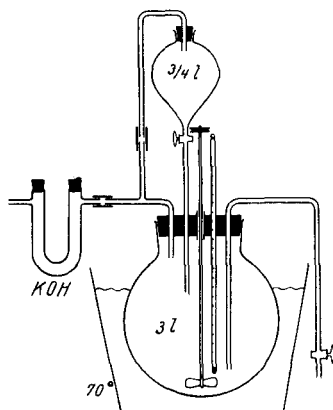
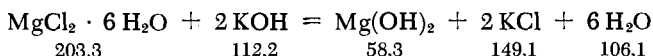

Fig. 256. Preparation of magnesium hydroxide.

The impurities in the material thus prepared are approximately: < 0.1% Cl, 0.27% CO₂, 0.01% SiO₂. Loss on calcining (1000°) 31.36% (theoretical: 30.88%).

II. MACROCRYSTALLINE Mg(OH)₂:



A wide-neck Pt vessel is charged with 1375 g. of KOH, 48.5 g. of MgCl₂ · 6 H₂O and 243 ml. of water. This mixture is heated in an electric furnace to 210°C and held at this temperature until the melt becomes clear (about 30 minutes). It is then allowed to cool to room temperature over a period of 18 hours. The solidified melt is dissolved in water and the solution filtered through a glass frit. The crystals remaining on the filter are washed several times with distilled water and dried at 100°C for two hours. The well-shaped crystals have a diameter of about 0.2 mm; they are free of CO₂ and contain about 0.15% K.

PROPERTIES:

d 2.4. Crystallizes in structure type C6. Readily soluble in acids. Thermal degradation to MgO begins at temperatures above 200°C under vacuum.

REFERENCES:

- I. R. Fricke, R. Schnabel and K. Beck, *Z. Elektrochem.* 42, 881 (1936); for other preparative methods, see there, as well as R. Fricke et al., *Z. Elektrochem.* 41, 174 (1935); *Z. anorg. allg. Chem.* 166, 255 (1927).
- II. A. deSchulten, *Comptes Rendus, Hebd. Séances Acad. Sci.* 101, 72 (1885); W. F. Glauque and R. C. Archibald, *J. Amer. Chem. Soc.* 59, 561 (1937).

Magnesium Sulfide

MgS

The synthesis of MgS from its elements is impractical since the reaction can be very violent. Heating of the metal in a stream of H₂S is more adaptable to the laboratory. Very pure MgS is formed in the reaction of CS₂ with MgSO₄ at 900°C. If one prefers not to use an oxygen-containing compound as a starting material, ammonium magnesium chloride may be reacted in a stream of H₂S.

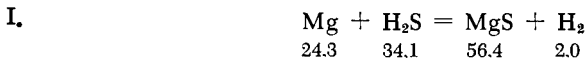

A stream of dry H_2S is passed over Mg turnings placed in a graphite boat or, better, in a boat made of sintered magnesia (H_2S flow rate 8 ml./min.). The reaction starts at 580°C , and once started, may be continued at lower temperature and higher flow rate (15 ml./min.). Unreacted Mg is distilled off by heating to 800°C under high vacuum. The pure white product contains 99.5% MgS; it reacts vigorously with water at room temperature.

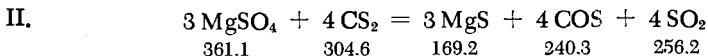

The Von Wartenberg modification of the CS_2 process of Tiede and Richter proceeds as follows: about 20 g. of finely pulverized MgSO_4 (evaporated with a small excess of H_2SO_4) is placed in a quartz tube just before all of the H_2SO_4 has been removed. The sulfate is heated in pure N_2 for half an hour at 700°C and then in N_2 saturated with CS_2 vapor for ten hours at 750°C . At this point, the iodine solution test should show no further SO_2 in the exit gas. The reaction temperature cannot be raised since elemental C begins to separate from the gas at 800°C . The very pure, loose product thus obtained is completely white.

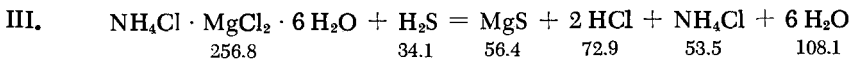

In the Banks modification of the Sarge method, the reaction temperature must be held below the melting point of MgCl_2 for about one hour while H_2S is passed over ammonium carnallite. It is then gradually (90 minutes) raised to 1000°C . The product is a white to cream-colored powder, which is very pure except for traces of chloride.

PROPERTIES:

White powder. M.p. $> 2000^\circ\text{C}$; d 2.86. Crystallizes in structure type B1. Crystalline MgS is only slowly attacked by water; it is completely soluble in dilute HCl.

REFERENCE:

- I. K. Nielsen, Ann. Chm. [12] 2, 354 (1947).
- II. E. Tiede and F. Richter, Ber. dtsch. chem. Ges. 55, 69 (1922); H. von Wartenberg, Z. anorg. allg. Chem. 252, 136 (1934).
- III. T.W. Sarge, US Pat. 2358661, Sept. 19, 1944; E. Banks, V.J. Russo and R. Ward, J. Amer. Chem. Soc. 72, 3173 (1950).

Magnesium Selenide



The preparation of MgSe is analogous to that of BeSe:

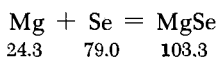

The optimal reaction temperature is 750°C (see also MgTe below).

PROPERTIES:

Slightly gray powder; decomposes very rapidly in air. Crystallizes in structure type B1. d 4.21.

REFERENCES:

Private communication from E. Tiede.

Magnesium Telluride



The direct preparation from the elements proceeds very violently at elevated temperature; it can be controlled by reacting only small quantities at a time.

Commercial Mg of at least 99.8% purity is used; the tellurium must be purified in most cases because of its selenium content. Twice recrystallized basic tellurium nitrate is freed of nitric acid by boiling in concentrated H_2SO_4 , and then HCl gas is passed through the boiling solution for several hours. Finally, the solution is diluted and the Te is precipitated with hydrazine. The Te, still containing some oxide, is distilled under vacuum.

The apparatus for the synthesis of MgTe consists of a tube with male ground joints at both ends. The tube is fitted with a side arm into which a small funnel can be inserted; the funnel may be closed by means of a glass rod. A small amount of a fine mixture of Mg powder and Te (atomic ratio 1 : 1.1 to 1 : 1.2) is added to the funnel and, by lifting the glass rod, dropped into a boat made of corundum or preferably, of carbon (MgO may also be suitable). A hydrogen flow is maintained over the boat during the filling. The boat is then pushed sideways and the contents made to react by fanning with a small flame. This operation is repeated until a sufficient amount has accumulated. A small electric oven is then placed over the

reactor tube, one end and the side arm are closed with ground-glass caps, and the other end is connected to a high-vacuum system. The substance is then heated under high vacuum at 600 to 700°C for a long time in order to distill off excess tellurium. After the completion of this heat treatment, the cooled product is bottled under highly purified nitrogen.

PROPERTIES:

Pure white powder. Decomposes in damp air, forming H_2Te , which then oxidizes to Te and appears on the surface of the telluride as a black deposit. d 3.85. Crystallizes in structure type B4 (wurtzite type).

REFERENCE:

W. Klemm and K. Wahl, *Z. anorg. allg. Chem.* 266, 289 (1951).

Magnesium Nitride



Finely divided Mg reacts with nitrogen at elevated temperatures. The nitrogen must be very pure in order to obtain oxide-free nitride. For this reason, using a dry NH_3 stream, instead of the N_2 , is advisable.

Magnesium filings are placed in a boat made of porcelain or, preferably, of sintered magnesia and inserted into a porcelain tube. This tube is connected by means of a tee with a source of N_2 and an apparatus for generating dry NH_3 . The other end of the porcelain tube is connected to a U tube filled with equal volumes of CaO and KOH pellets. The exit gases are passed through an absorption unit consisting of two Erlenmeyer flasks filled with dilute H_2SO_4 . The inlet tube of the first flask does not dip into the liquid.

After the air is completely displaced from the apparatus by the NH_3 (air bubbles cease to emerge from the second Erlenmeyer flask), the Mg is heated at 800 to 850°C for four hours. The onset of nitride formation is recognized by incandescence of the Mg and the evolution of H_2 . A high NH_3 flow must be maintained at the peak of the reaction to avoid sucking the absorption fluid into the reactor. Since the finished material always contains adsorbed NH_3 , heating in a N_2 stream should be continued at the same temperature for 90 minutes. Because of the high moisture sensitivity of the material, bottling must be carried out with the usual precautions.

PROPERTIES:

Loose powder, green-yellow to yellow-orange; d 271. Crystallizes in structure type D5₃ (carbon sesquioxide type). Very

sensitive to moisture; decomposes rapidly in air to $\text{Mg}(\text{OH})_2$ and NH_3 .

REFERENCES:

- J. Rieber, Thesis, Hannover 1930.
 M. von Stackelberg and R. Paulus, Z. phys. Chem. (B) 22, 305 (1933);
 see also H. Grubitsch, Anorganisch-präparative Chemie [Inorganic
 Preparative Chemistry], Vienna, 1950, p. 306.

Magnesium Azide



The preparation is analogous to that described for beryllium azide (p. 899), using diethylmagnesium in ether-dioxane. The reaction starts on thawing below 0°C .

PROPERTIES:

White substance, sensitive to moisture, insoluble in ether and in tetrahydrofuran. Slightly explosive on contact with a flame. Only the basic azide is recovered from aqueous solutions when the water is distilled off under high vacuum.

REFERENCE:

- E. Wiberg and H. Michaud, Z. Naturforsch. 9 b, 501 (1954).

Magnesium Phosphide and Magnesium Arsenide



I. In the method of Zintl and Husemann, a H_2 stream laden with vapors of P or As is passed over heated pulverized magnesium.

The substances may be prepared in the apparatus shown in Fig. 257 without coming into contact with air. Here S_1 and S_2 are two Vycor boats; S_1 is filled with 5 g. of purified red P (or 12 g. of sublimed As); S_2 is filled with 4 g. of Mg powder, prepared from pure metal with a milling machine in the absence of air. After thorough evacuation, pure H_2 is introduced at H and escapes at A . Boats S_1 and S_2 are separately heated with two electric furnaces O_1 and

O_2 . The initial temperature is 600°C in both furnaces. At the end of the reaction, the product in S_2 is kept at about 700°C for a short time in order to remove the excess of P (or As). The Vycor cylinder Z , which is sealed at one end, prevents the back-diffusion of the P (or As) vapor.

This method yields the compounds in finely crystalline form; the Mg_3P_2 is bright yellow, the Mg_3As_2 , intensely brown-red. The cylinder Z with the two boats is pushed toward B (against the H_2 flow) by means of a glass rod introduced at A . Boat S_2 is then pulled to the left to C and overturned at that point so that the material accumulates at D . Outlet A is then closed off and the compound is pulverized at D by means of a glass rod with a pestle-shaped end, which is introduced at E . The distribution vessel V is then detached at F and is closed (under a hydrogen blanket) by a ground glass plug. A connection is then made at H to a flexible, corrugated tombac tube, which leads to the pump and the hydrogen generator. Rubber tubing is not suitable for this purpose because it gives off moisture. Finally, the powder is distributed into the thin-wall glass bulbs K and tubes M by tilting vessel V . The bulbs and the tubes are melt-sealed. The samples in K are used for analysis; therefore the bulbs are weighed together with their ground joints before assembly and after sealing off. The material thus obtained is very pure.

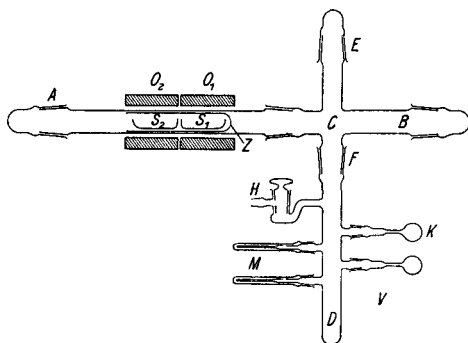

Fig. 257. Preparation of magnesium phosphide and magnesium arsenide.

II. A porcelain boat $10 \times 15 \times 60$ mm.—a boat made of Al_2O_3 or MgO is recommended for the metal—is filled with very fine Mg shavings turned from a solid metal block. A second boat is filled with 6 g. of purified red P (or 14 g. of sublimed As). Both boats are pushed to the closed end of a 500-mm. combustion tube which has a diameter just sufficient to accommodate the boats. The tube is closed with a rubber stopper fitted with a stopcock and evacuated

by means of an oil pump while being gently fanned with a flame. Even better, the tube is drawn out using a torch, and a section 350 mm. long is sealed off under high vacuum.

After the metal has been heated to dull red heat, the P (or As) is heated with a second burner and distilled onto the Mg. The reaction of the two elements is accompanied by bright incandescence. In order to avoid removal of P (or As) from the reaction site while heating the Mg or during the reaction itself, the center portion of the reaction tube is heated by a short multiple-tube burner, so that little or no P or As condenses on the cold surface of the rubber stopper. This also assures that the stopper will be able to relieve any pressure buildup in the tube.

In order to remove excess P (or As) from the finished product, the tube is shifted so that only the two boats are heated by the multiple-tube burner. Heating is continued for 30 minutes. In the case of the arsenide, the excess nonmetal can sometimes be removed only after pulverizing the reaction product. After cooling, the tube is filled with dry Cl_2 . The boat is taken out and the moisture-sensitive substance is sealed into a prepared ampoule as shown in Fig. 258.

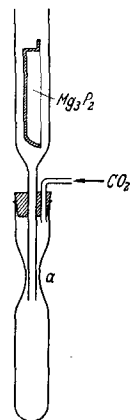

Fig. 258. Bottling of magnesium phosphide under CO_2 blanket.

PROPERTIES:

The phosphide is bright yellow, the arsenide is brown-red. Stable in completely dry air at room temperature, decompose in moist air (Mg_3P_2 decomposes faster than Mg_3As_2). Both crystallize in structure type D5_8 (carbon sesquioxide). d (Mg_3P_2) 2.055; (Mg_3As_2) 3.148.

REFERENCES:

- I. H. Gautier, *Comptes Rendus Hebd. Séances Acad. Sci.* 128, 1168 (1899); E. Zintl and E. Husemann, *Z. phys. Chem. (B)* 21, 138 (1933).
- II. F. Weibke, Thesis, Technische Hochschule, Hannover, 1930; P. Ehrlich, unpublished studies.

Magnesium Carbides

MgC_2 , Mg_2C_3

These compounds cannot be prepared from carbon and the metal since MgC_2 decomposes below $500^\circ C$ and Mg_2C_3 above $700^\circ C$. However, relatively pure products are obtained by passing gaseous hydrocarbons over heated MgO powder (60 microns or smaller). Prior to use, this extremely fine powder is activated by heating under vacuum for a short period of time.

I a. To prepare MgC_2 , about 8 g. of Mg powder is placed in a 10-cm.-long iron boat and covered with some steel wool. The boat is then inserted into a porcelain tube of about 4 cm. diameter. The air is displaced by repeated evacuation and filling with H_2 . The tube is then heated at $700^\circ C$ for 40 minutes while a slow stream of H_2 is passing through it and cooled to $450^\circ C$ at 11 mm. over a period of 10 minutes. Finally, acetylene is introduced over a period of 15 minutes, until atmospheric pressure is restored. Passage of C_2H_2 is then continued for one hour at a flow rate of 6 liters/hour and a temperature of $450^\circ C$. The tube is then removed from the furnace and cooled in a slow H_2 stream. The steel-blue to black, very hard product is ground at once under absolutely dry ether and stored. The crude carbides are purified by dissolving the excess Mg with ethyl bromide in ether, which may be done in a small Soxhlet extraction apparatus. A product containing 70% MgC_2 is obtained.

I b. The preparation of Mg_2C_3 is similar. As above, the air is displaced from the reaction tube, which is then heated to $850^\circ C$ for one hour. After lowering the temperature, pentane is passed at $700^\circ C$ for two hours and $710^\circ C$ for one hour, under slightly reduced pressure (aspirator suction). The pentane is introduced into the reaction tube by means of a dropping funnel. A gas flow rate of 2.5 liters/hour corresponds to 35 ml., or 30 drops per minute. Cooling in a H_2 stream is carried out as above. The light to dark-gray products contain up to 85% Mg_2C_3 .

Other preparative methods: II. Reaction of $MgCl_2$ with CaC_2 (does not, however, result in a purer product). III. Reaction of a ether solution of diethylmagnesium and acetylene.

PROPERTIES:

MgC_2 has a tetragonal and Mg_2C_3 a hexagonal structure. MgC_2 decomposes at about $550^\circ C$, forming Mg_2C_3 and C ; Mg_2C_3 decomposes at 740 to $750^\circ C$ into its elements. On reaction with water, MgC_2 and Mg_2C_3 give C_2H_2 and C_3H_4 , respectively.

REFERENCES:

- I. F. Irmann, *Helv. Chim. Acta* **31**, 1584 (1948).

- II. A. Schneider and J. F. Cordes, *Z. anorg. allg. Chem.* **279**, 94 (1955).
 III. W. H. Rueggeberg, *J. Amer. Chem. Soc.* **65**, 602 (1943).

Magnesium Silicide



An intimate blend of Mg filings and pulverized Si (3 : 1) is charged into a MgO boat and heated under high vacuum. The reaction begins at 450°C, lasts only a few minutes, and is accompanied by a large volume increase. The product contains an excess of free Mg, but no free Si. The metal can either be distilled off at higher temperature (700°C) or extracted by treating the pulverized alloy with ethyl iodide in the presence of anhydrous ether, or with an ether solution of bromobenzene containing a grain of iodine. After washing with ether, the product is first dried at room temperature, then at 300°C. The slate-blue, shiny crystals have the composition Mg_2Si .

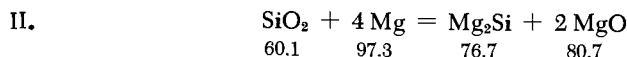

When larger amounts of silicide are required for the synthesis of silanes, the compound is best prepared as follows:

Precipitated silicic acid, free of P and S and containing 0.3 to 0.5% (based on the weight of the anhydrous material) alkaline residue after evaporation is dehydrated by heating at bright red heat for several hours. The carefully pulverized anhydride is intimately blended with twice its amount of Mg powder. This mixture (100 g.) is ignited in an iron crucible of about 1000 ml. capacity, which is well cooled by a large quantity of cold water; the reaction rapidly propagates throughout the entire mass, generating incandescent white heat. Immediately after the onset of the reaction, the crucible is covered with a lid equipped with a gas inlet tube, and a fast H_2 stream is passed over the reactants. Some Mg is forced outside and burns on the lid. After cooling, the product cake adhering to the bottom of the lid can be easily removed.

Other preparative methods: III. Claims have been advanced that high purity Mg_2Si can be prepared by melt electrolysis of magnesium silicate.

PROPERTIES:

Rather hard, very brittle, slate-blue crystals. Crystallizes in structure type C1 (fluorite type). d 1.94. Stable to alkalis. Decomposed by acids, forming silicon hydrides and hydrogen.

REFERENCES:

- I. G. Gire, Comptes Rendus Hebd. Séances Acad. Sci. 196, 1405 (1933); P. Lebeau and P. Bossuet, Comptes Rendus Hebd. Séances Acad. Sci. 146, 284 (1908); L. Wöhler and O. Schliephake, Z. anorg. allg. Chem. 151, 1 (1926).
- II. A. Stock and C. Somieski, Ber. dtsh. chem. Ges. 49, 115 (1916).
- III. J.-L. Andrieux, Congr. Chim. Ind. Nancy 18, I, 124 (1938).

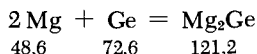
Magnesium Germanide

A homogeneous mixture of finely powdered Ge and Mg (3 : 2) is introduced into a Pyrex tube. The latter is heated by means of a Bunsen burner, while a flow of H_2 is passed through. The temperature is raised gradually. As red heat is approached, an incandescent reaction sets in at one spot and then spreads through the whole mass without further heating.

PROPERTIES:

Dark gray granular product. Characteristic odor of GeH_4 due to reaction with air moisture. M.p. 1115°C .

REFERENCES:

- L. M. Dennis, R. B. Corey and R. W. Moore, J. Amer. Chem. Soc. 46, 657 (1924).
- W. Klemm and H. Westlinning, Z. anorg. allg. Chem. 245, 365 (1940).

Calcium, Strontium, Barium Metals

The available methods of preparation include: I) fusion electrolysis; II) aluminothermic reaction; III) decomposition of azides. The first method (used exclusively in industry) has only occasional laboratory application. Relevant literature references for Ca are listed under I. Method II does not give good yields with Ca, but is

applicable to Sr and Ba. Method III does not yield pure metal and may be used only with small quantities of material, since explosions are possible. The large surface area of the finely divided metal obtained by this method may be useful for special purposes. The procedures for Sr and Ba are similar to those given for Ca.

CALCIUM, Ca

In most cases commercial metal, purified by distillation, is used as the starting material.

Purification by distillation: a) Ca is distilled in an iron tube by directing metal vapor against a steel, nickel or copper cooling finger, which is polished at the lower end. A flange connects the pipe to a high vacuum system. Even better is an apparatus made of a quartz or porcelain tube r , sealed at one end and provided with a ground joint. A tall iron tubular crucible t is inserted into the tube. The latter, reaching into the cold zone, provides protection against corrosion. The arrangement and dimensions are shown in Fig. 259.

For ease of disassembly the high vacuum connection should be made directly at the quartz tube r , rather than at the cap. The tube should thus be elongated accordingly. In such an arrangement the connection to high vacuum need not be broken while the distillate is being removed.

Crude Ca (40 g.) is placed in a crucible (1-mm.-thick walls) made of electrolytic iron, stainless steel or low-carbon steel. To prevent contamination of the distillate with a fine dust consisting of residual calcium oxide and calcium nitride, the metal is covered with a thin layer of steel wool. The latter is well degreased before use and ignited in moist H_2 , as is the crucible, in order to effectively remove P and C. The crucible must be separated from the round bottom of the quartz tube by a narrow porcelain piece p , so that it will not burst the tube on a sharp temperature change. A water-cooled, thin-wall finger f runs axially through a 10-cm.-long glass tube passing through the ground cap. The rod is cemented

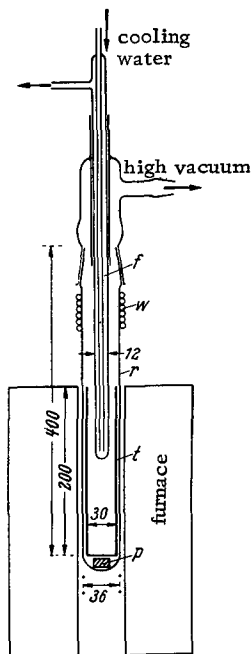

Fig. 259. Purification of calcium by distillation.

The rod is cemented

to the tube with picein, forming an airtight connection. The metal parts must be perfectly smooth and free of oxide. The ground joint is cooled by means of a lead coil carrying water. The apparatus may be arranged vertically so that the cold finger will be suspended without stress in the guide tube of the ground cap. The same apparatus can, however, be operated more conveniently when tilted at about 30° . Aside from this the ground joints are easier to cool in this case.

Before it is put into operation, the apparatus should be tested for leaks under high vacuum. A good diffusion pump (with a capacity of 15-22 liters/sec.) should be in continuous operation in order to maintain a sufficiently high vacuum, since large volumes of gas contained in the crude material are evolved during distillation (especially in the initial stage). The pump is best connected to the apparatus by way of a trap cooled with liquid N_2 . The tubing that connects the pump with the distilling apparatus should be as short and as large diameter as possible.

During the first phase of distillation, at $700^\circ C$, alkali metals (primarily Na, together with some Ca) are deposited upon the cold finger (Mg cannot be separated from calcium by distillation). The apparatus is allowed to cool somewhat and is then filled with purified Ar (or with dry CO_2 if completely cool). At the same time the cold finger and the ground cap are replaced by fresh ones. The alkali metals occasionally ignite on contact with the air when the apparatus is opened.

The main distillation step is carried out under high vacuum ($\leq 10^{-3}$ mm.) at the lowest possible temperature, so as to ensure high-purity metal. The last fraction is discarded. At $850^\circ C$ the calcium deposit on the cold finger builds up as grape clusters of long silver-white, luminous crystallites, which will not tarnish to any appreciable extent on brief exposure to air. At higher temperatures the distillates obtained are richer in chlorine.

The structural characteristics of the separated metal depend markedly on the distillation rate. If the operating temperature is raised by $100-150^\circ$, the metal is deposited more rapidly and will be more compact. The temperature of the cold finger is likewise of importance. The lower the temperature, the smaller the particle size of the deposited metal. With air cooling of the finger the metal will separate in the form of rhombohedra.

After the thoroughly cooled apparatus has been filled with Ar or CO_2 , the tube is opened and the metal dislodged from the cold finger with a spatula or, if necessary, with suitable tongs or forceps. This is best done under toluene or in a cylinder filled with CO_2 .

It is advisable to repeat the distillation several times. The Ca obtained by this procedure is 99.7-99.9% pure and contains a few hundredths of one percent of O, N, Cl, Fe, Si, Mg.

Preparation of high-purity calcium by preliminary distillation followed by fractional distillation (2 mm. Hg) is described by W. J. McCreary, *J. Metals* 10, 615 (1958).

b) The procedure is simplified for lower purity metal. Use of the cold finger is omitted, as is the interruption of distillation for separation of alkali metals.

Crude Ca (20 g.) is placed in a tubular crucible made of low-carbon iron (inside diameter 20 mm., length 150 mm.) smoothly machined on the outside. An open iron pipe (length 150 mm.) smoothly machined on the inside, jackets the crucible with a clearance of only a few tenths of a millimeter. An iron wire is welded to the jacketing tube for more convenient handling. Both the crucible and the jacket must be well cleaned mechanically before the experiment and reduced in moist hydrogen.

The crucible and protective pipe are inserted into a quartz tube tilted about 30° from the horizontal. A ground cap connects the tube with a high-vacuum system. The distillation proceeds under the same conditions as described above. The iron jacket reaches up to the cooling coil. The temperature gradient along this cap is such that the alkali metals are deposited on its upper portion (which often results in ignition on opening of the reactor), while the Ca condenses in the form of beads somewhat below the height corresponding to the rim of the furnace. One of the disadvantages of this arrangement is that the condensation temperature of the calcium is sufficiently high so that the product reacts with the iron of the tube and thus becomes somewhat contaminated.

After cooling, the Ca is chipped off the wall with a chisel. This is best done when the pipe is cut open. If it is desired to compact the metal, the first crucible is removed and a shorter one substituted. This crucible has a larger diameter than the jacket, which dips into it. The Ca can then be melted down from the jacket in the same quartz reactor simply by shifting the furnace. It is best to melt under argon at atmospheric pressure, since too large quantities of the metal vaporize under vacuum.

c) A mild steel apparatus with a capacity of 200 g. of metal is used for distilling larger amounts of Ca.

Remelting: If compact Ca rather than a sponge is desired, the latter must be remelted. The pure distilled Ca (20-25 g.) is ground under Ar or CO_2 with an iron pestle in a crucible (diameter 23 mm., height 75 mm., wall thickness 1 mm.) made of electrolytic iron or low-carbon steel and preignited in moist H_2 . A second crucible is fitted snugly into the first, pushed as far down as possible and welded to it at the rim level. The lower part of the outer crucible is cooled with water. The Ca melts at 900°C after brief heating. On cooling, the crucible is cut open and the compact Ca cylinder is easily loosened from the wall. The metal does not segregate, but the metal surface adhering to the rim absorbs a few

hundredths of a percent of Fe, which may be removed by turning the cylinder on a lathe.

PROPERTIES:

Atomic weight 40.08. Silver-white metal. M.p. 850°C, b.p. 1439°C, d 1.55. The m.p. is lowered considerably by nitrides and other impurities.

Calcium is as soft as Pb. The cubic face-centered α -Ca transforms at 464°C into the hexagonal γ -Ca.

The β -Ca (between 300 and 464°C), until now considered a separate modification, is actually an alloy of Ca and impurities. The purer the metal, the more slowly it tarnishes in the air. It reacts rather slowly with water at ordinary temperatures, but the reaction becomes more vigorous on warming. With dilute acids, the reaction is violent.

REFERENCES:

General: H. Funk, *Die Darstellung der Metalle im Laboratorium* [Laboratory Preparation of Metals], Stuttgart, 1938, p. 29; H. Grubitsch, *Anorganisch-präparative Chemie* [Inorganic Preparative Chemistry], Vienna, 1950, p. 396; G. Chaudron in: A. E. van Arkel, *Reine Metalle* [Pure Metals], Berlin, 1939, p. 126; I. F. Smith, O. N. Carlson and R. W. Vest, *J. Electrochem. Soc.* 103, 409 (1956).

I. Electrolysis: O. Ruff and W. Plato, *Ber. dtsh. chem. Ges.* 35, 3612 (1903); W. Muthmann, H. Hofer and L. Weiss, *Liebigs Ann. Chem.* 320, 231 (1902); B. Neumann and E. Bergve, *Z. Elektrochem.* 20, 187 (1914); M. Trautz, *ibid.* 21, 130 (1915).

Purification by distillation: a) F. W. Dafert and R. Miklaur, *Mh. Chem.* 34, 1685 (1913); W. Biltz and G. F. Hüttig, *Z. anorg. allg. Chem.* 114, 242 (1920); W. Biltz and W. Wagner, *ibid.* 134, 1 (1924); P. S. Danner, *J. Amer. Chem. Soc.* 46, 2382 (1924); A. von Antropoff and E. Germann, *Z. phys. Chem.* 137, 209 (1928); P. Remy-Genneté, *Ann. Chim.* (10) 19, 263 (1933); W. C. Johnson et al., *J. Amer. Chem. Soc.* 61, 318 (1939); P. Ehrlich, unpublished experiments. b) Private communication from Prof. Dr. W. Fischer, Hannover. c) W. D. Treadwell and J. Sticher, *Helv. Chim. Acta* 36 1822 (1953).

Remelting: O. Ruff and H. Hartmann, *Z. anorg. allg. Chem.* 121, 167 (1922); W. Biltz and W. Wagner, *ibid.* 134, 1 (1924).

STRONTIUM, Sr

I. Strontium can be prepared by fusion electrolysis (see references for calcium, part I), by the aluminothermic procedure (II), and by decomposition of azide (III). Strontium prepared by the aluminothermic process, as well as the commercially available metal, is purified by distillation under high vacuum.

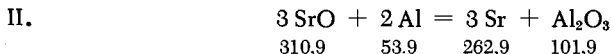

Reaction II is endothermic. It goes to completion because the alkaline earth metals are highly volatile, and thus the equilibrium is continually and favorably shifted by the use of high vacuum.

The apparatus described above (Ca distillation) is charged with a homogeneous mixture of 60 g. of SrO, freshly ignited at 1100°C, and 14 g. of pure Al shot. Larger quantities of the reactants should not be used since the vigorous reaction will cause unnecessarily heavy losses through spattering. The mixture is preheated for an hour. The heating is then continued for four hours at 1010-1030°C under high vacuum (10⁻² mm.). The reduction to powder and the mixing should be done rapidly, so as to keep the oxide as free as possible from hydroxide and carbonate. In spite of these precautions, a temporary deterioration of the vacuum occurs during the heating from 500 to 800°C.

The yield of 98% pure metal is 20-30 g. Strontium reacts rapidly with atmospheric moisture. Consequently, all operations such as opening the apparatus, Sr transfer, etc., should be done in an atmosphere of dry CO₂ or, better, under purified Ar.

The arrangement for distillation of commercial Sr is also the same as in the Ca procedure. Forty grams of crude Sr can be distilled in four hours at 1030°C. Repeated distillation yields 99.9% pure metal.



This method is the same as described for Ba under III. It yields a finely divided black metal powder, which is strongly contaminated with nitride (>10%) and ignites immediately on exposure to air.

PROPERTIES:

Silver-white metal, softer than Ca. M.p. 757°C, b.p. 1364°C; d 2.6. Crystallizes in structure type Al.

Tarnishes in air (becoming yellow-brown) and is finally coated by a layer of white oxide. Finely divided Sr ignites on exposure to air.

REFERENCES:

II. *Aluminothermic reaction*: A. Guntz et al., *Ann. Chim. Phys.* [8] 10, 437 (1907); *Comptes Rendus Hebd. Séances Acad. Sci.* 143, 339 (1906); 151, 813 (1910); *Bull. Soc. Chim. France* [4] 35, 712 (1924).

General: See also references listed for Ca.

BARIUM, Ba

I. The procedures are the same as for Ca and Sr. The pure metal is obtained by repeated redistillation under high vacuum.

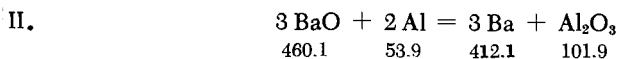

The directions for preparing this metal are the same as for Sr (II), with minor modifications: 72 g. of BaO, nearly free of peroxide, and 11 g. of aluminum shot are heated for one hour. The heating is continued for five more hours at 1100°C under high vacuum (10^{-2} mm.). The yield is < 20 g. of 97-98% pure metal. Commercial BaO usually contains some Sr, which concentrates in the distilled metal. Of the three alkaline earth metals, Ba is the most reactive. Every precaution must be taken when opening the apparatus or transferring the metal, since the deposited metal is finely crystalline and easily ignites in the presence of traces of moisture, especially while being detached from the cold finger. The safest way is to carry out this step under toluene.

In purifying Ba by distillation, the directions given for Ca should again be followed. Forty grams of crude Ba may be distilled at 1050°C in four hours. Triple distillation yields 99.6% pure metal.



Small quantities of Sr and Ba can be obtained by decomposition of the corresponding azides under vacuum. The metals are obtained as finely divided, highly reactive black powders. They may be used in various reactions, which can be carried out directly in the equipment used for preparation. Their isolation, i.e., removal from the apparatus, is hardly possible, because on exposure to air these metals react immediately with ignition. Another problem is contamination of the metal with nitride (>10%) due to a side reaction of the type: $\text{Ba} + 2\text{Ba}(\text{N}_3)_2 = \text{Ba}_3\text{N}_2 + 5\text{N}_2$. By subjecting the $\text{Ba}(\text{N}_3)_2$ to rapid decomposition, the nitride content can be kept down to a low level.

The decomposition equipment consists of a distillation flask (250 ml.) which is connected to a manometer and a vacuum pump. To avoid excessive loss of metal by entrainment, a piece of glass wool is inserted into the outlet tube.

The flask is charged with 10 g. of the azide and sealed on top. After evacuating the flask, heat (small flame) is applied at one point. Occasionally an explosion occurs, accompanied by fire, and the flask of $\text{Ba}(\text{N}_3)_2$ then becomes coated with a black metal film.

The decomposition begins at 160°C; that of $\text{Sr}(\text{N}_3)_2$ at 140°C. Once started, it can be carried to completion at a lower temperature (120°C for Ba and 110°C for Sr).

PROPERTIES:

Silver-white metal. M.p. 710°C, b.p. 1537°C; d 3.76. Crystallizes in structure type A2.

On exposure to air Ba quickly turns gray and finally black. Ignites very readily and reacts very vigorously with water.

REFERENCES:

III. *Azide decomposition*: E. Tiede, Ber. dtsh. chem. Ges. 40, 1742 (1916); P. Remy-Genneté, Ann. Chim. [10] 19, 263 (1933).

General: See references given for Ca and Sr.

Calcium Strontium and Barium Hydrides

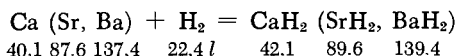

Following repeated redistillation under vacuum, the metal is milled free of the adhering oxide under argon. When the surface of the metal is clean and bright, it is placed in the hydrogenation apparatus described for the preparation of alkali hydrides (p. 971). Air must be excluded. Thoroughly purified and dried electrolytic H_2 is employed for the hydrogenation. The metal is placed in a boat made of pure electrolytic iron, which is inserted into a quartz tube connected to a manometer. A thin-wall tubular insert made of electrolytic iron is fitted into the quartz tube to protect its heated portion from chemical attack.

Hydride formation usually begins between 400 and 500°C for Ca and Sr and between 200 and 300°C for Ba. Thereafter the temperature is raised to 1000°C. As soon as the absorption of H_2 is completed, the reactor is slowly cooled. The hydride is now ready for use, provided air and moisture are absent.

The finely crystalline substances thus obtained resemble the mineral serpentine and retain the fibrous structure of the original metals. The interior of the CaH_2 product in most cases contains a residue consisting of unreacted Ca metal. As the temperature rises above 1000°C the compound, in a stream of H_2 , becomes overheated and dissociation begins. The metal evaporates and the components recombine in the colder areas of the tube. However,

slow distillation yields the hydrides as colorless, lustrous crystals, about 1 mm. wide. A residue is left in the boat.

To arrive directly at very pure hydrides, a special apparatus is used. This is provided with a mechanical arrangement for continuous grinding of the reaction product as it is formed during the hydrogenation. W. D. Treadwell and J. Sicher, *Helv. Chim. Acta* 36, 1938 (1953), used such equipment to obtain nearly 99.9% pure CaH_2 .

ANALYSIS:

The hydride samples are removed from the apparatus in the absence of air and moisture and are then decomposed with air-free water under vacuum. The H_2 formed in the decomposition is cooled to a low temperature to condense out the moisture. It is then dried over P_2O_5 , transferred to a gas burette by means of a Toepler pump, and measured.

PROPERTIES:

Colorless, lustrous rhombic crystals, the stability decreasing from CaH_2 to BaH_2 . The hydrides react vigorously with water, evolving H_2 . The heats of formation from the elements are remarkably high.

d (CaH_2) 1.90; (SrH_2) 3.27; (BaH_2) 4.15.

REFERENCES:

- E. Zintl and A. Harder, *Z. Elektrochem.* 41, 33 (1935).
Simplified procedures yield substances of lower purity (~90%):
C. B. Hurd and K. E. Walker, *J. Amer. Chem. Soc.* 53, 1681 (1931).
P. Remy-Genneté, *Ann. Chimie* (10) 19, 263, 353 (1933).
W. C. Johnson, M. F. Stubbs, A. E. Sidwell and A. Pechukas, *J. Amer. Chem. Soc.* 61, 318 (1939).

Calcium, Strontium, Barium Halides

The anhydrous halides of Ca, Sr and Ba are prepared in the same way as described for the corresponding compounds of Be and Mg.

Anhydrous iodides can also be obtained from the hydrides by using nonaqueous solvents as reaction media. In pyridine solution, for example, the reaction is: $\text{BaH}_2 + 2\text{NH}_4\text{I} = \text{BaI}_2 + 2\text{NH}_3 + 2\text{H}_2$. Most of the pyridine is then distilled off and the residual, bound solvent is removed under vacuum at 150-160°C. The yield is 97%.

REFERENCE:

- M. D. Taylor and L. R. Grant, *J. Amer. Chem. Soc.* 77, 1507 (1955).

Calcium Oxide

CaO



Calcium oxide is obtained by igniting calcium carbonate or calcium oxalate at about 800°C.

Purification of calcium salts: Very pure calcium oxide, such as needed in the preparation of phosphorus, is obtained according to Tiede and Riemer in the following way:

Carrara marble is dissolved in very pure nitric acid. The CO₂ is completely removed by boiling and the hot solution is treated with Ca(OH)₂ solution to precipitate traces of salts of foreign metals (primarily Cu, Fe and Mg). The filtrate is heated almost to boiling and CO₂ is passed through. The bicarbonate is formed in proportion to the amount of added Ca(OH)₂ and is subsequently decomposed by boiling the solution until it is neutral. The Ca is finally precipitated as the carbonate, carrying along traces of Fe. The filtered Ca(NO₃)₂ solution is treated with a concentrated solution of pure (NH₄)₂CO₃ which contains one third by volume of concentrated ammonia. The CaCO₃ precipitates on cooling. The precipitate is washed well, dried and ignited to the oxide. A quartz crucible and an electric furnace are used for this last reaction. For best results, no more than 2-3 g. should be prepared at a time.

Other methods: II. A purification procedure including an even greater number of steps is described in a thesis by Riemer. The process yields CaCO₃ and CaO of extreme purity such as employed in the production of luminescent materials. III. Very pure CaCO₃ is prepared according to the method of Richards and Hönigschmid. Calcium nitrate solution is slightly acidified with nitric acid and treated with a slight excess of pure Ca(OH)₂ solution to precipitate Fe(OH)₃ and most of the Mg(OH)₂. Impurities consisting of Ba, Sr and Mg salts are removed by repeated recrystallization of the nitrate. The (NH₄)₂CO₃ required for the precipitation of the carbonate is purified by distillation with water. Further details will be found in the original report.

PROPERTIES:

Crystallizes in structure type B1. M.p. 2572°C, b.p. 2850°C; d 3.35. Treatment with water yields the hydroxide.

REFERENCES:

- I. E. Tiede: Private communication, 1949.
- II. F. Riemer: Thesis, Berlin, 1920.

- III. T. W. Richards and O. Hönigschmid, J. Amer. Chem. Soc. **32**, 1577 (1910); E. H. Archibald, The Preparation of Pure Inorganic Substances, New York, 1932, p. 71.

Strontium Oxide

SrO

I. Strontium oxide can be obtained by heating pure SrCO_3 in a stream of H_2 at 1300°C for several hours, by dehydration of $\text{Sr}(\text{NO}_3)_2 \cdot 4\text{H}_2\text{O}$ with subsequent calcining at 1100°C for 1.5 hours, or by dehydration of $\text{Sr}(\text{OH})_2$ above 850°C . If a high-purity product is desired the heating (as in the case of BaO) is done in a stream of N_2 or H_2 , free of O_2 and CO_2 . The vessels must be made of nickel or sintered alumina.

Purification of strontium salts: II. Highest purity SrO is obtained by way of the nitrate, which is prepared as follows. Strontium carbonate is treated with 500 ml. of distilled water in a five-liter flask. This suspension is slowly dissolved in 830–840 ml. of concentrated nitric acid. Next, 7 ml. of concentrated H_2SO_4 is added to precipitate most of the Ba, and the solution is brought to boiling. The hot solution (pH ~6) is treated for 30 minutes with H_2S , previously passed through $\text{Ba}(\text{OH})_2$ solution. After the precipitate has settled, it is suction-filtered through a glass frit to avoid contamination of the filtrate with dust.

The filtrate is treated with 45 ml. of saturated ammonium oxalate solution and the Ca precipitated on addition of ammonia to a pH of 7. The mixture is brought to boiling and, while hot, treated again with H_2S . It is left to stand overnight and filtered the next morning. Nitric acid is added until the pH is reduced to 3, and 2–3 ml. of Br_2 is added to oxidize Fe and Mn. Excess Br_2 is removed by boiling. The solution is then made alkaline with ammonia (pH 8) and H_2S is admitted briefly. After standing a few hours the solution is filtered and the filtrate is reacidified with nitric acid (pH 3). After heating to boiling, the filtration is repeated. The $\text{Sr}(\text{NO}_3)_2$ solution is by this time sufficiently free of heavy metal impurities.

III. The last traces of Ca and Mg can be removed by precipitating the Sr as SrSO_4 . In most cases, however, repeated recrystallization (3 or 4 times) of strontium nitrate in Pt or quartz vessels will suffice. By passing very pure NH_3 and CO_2 , Sr can be precipitated as SrCO_3 from a solution containing 200 g. of $\text{Sr}(\text{NO}_3)_2 \cdot 4\text{H}_2\text{O}$ in one liter of water. The precipitate is washed 8 to 10 times by decantation. After filtration and drying in an electric furnace it is calcined to form the oxide.

PROPERTIES:

Formula weight 103.63. White powder. M.p. 2430°C; d 5.02. Crystallizes in structure type B1. Converted to $\text{Sr}(\text{OH})_2$ by moisture or water.

REFERENCES:

- I. A. Guntz and F. Benoit, Bull. Soc. Chim. France [4] 35, 712 (1924); G. F. Hüttig and A. Arbes, Z. anorg. allg. Chem. 192, 225 (1930).
- II. A. L. Smith, R. D. Rosenstein and R. Ward, J. Amer. Chem. Soc. 69, 1725 (1947).
- III. T. W. Richards, Proc. Amer. Acad. 30, 376 (1894); E. H. Archibald, The Preparation of Pure Inorganic Substances, New York, 1932, p. 75.

Barium Oxide

BaO

I. Thermal decomposition of the nitrate (which melts and decomposes with effervescence), iodate or peroxide is used to obtain the oxide. The final temperature must be above 800°C. Normally the compound is heated in air to 1100°C, to remove any peroxide impurity present.

The highest purity product is obtained by thermal decomposition of BaCO_3 under high vacuum. The most expedient procedure is to liberate most of the CO_2 at 950°C and the remainder at 1100–1150°C. This prevents melting of the product.

Another method for preparing BaO is based on careful dehydration of $\text{Ba}(\text{OH})_2 \cdot 8\text{H}_2\text{O}$, which has been repeatedly recrystallized before use. The mass is then heated for two hours at 800°C in a stream of dry N_2 or H_2 , free of O_2 and CO_2 . Melting of the $\text{Ba}(\text{OH})_2$ cannot be avoided since the temperature reaches 700°C; hence, it is advisable to use vessels made of sintered corundum or pure nickel. Other materials such as Pt, stainless steel, quartz, porcelain, etc., are corroded.

Purification of barium salts: II. Impurities which can be separated as sulfides are removed by following the directions given for SrO (II). The hydroxide octahydrate is not altogether suitable for further purification (removal of residual traces of Sr, Ca, Mg, etc.) since its recrystallization, while removing all traces of Ca, does not lead to complete removal of Sr. The nitrate, on the other hand (according to Richards), is very well suited for removal of the last traces of Sr, Ca, Mg, K and Na from Ba salts.

Very pure commercial barium nitrate is recrystallized eight times from very pure water in Pt containers. If Pt is not available, quartz vessels may be used. The mother liquor is separated by centrifuging in a Pt tube, this procedure being about ten times as efficient as suction filtration. At the beginning, as well as toward the end of the recrystallization process, the nitrate solution is filtered through a fine glass frit. Every precautionary measure to exclude dust and harmful vapors is observed during the procedure. The simplest way to achieve this is to use the particular laboratory premises for no other work but the above procedure.

To obtain BaCO_3 (as the starting material for various Ba salts), a hot, pure barium nitrate solution is precipitated, with $(\text{NH}_4)_2\text{CO}_3$, which is prepurified by distilling its aqueous solution through a Pt condenser into a Pt receiver. The BaCO_3 is separated from the mother liquor in a Pt centrifuge tube.

PROPERTIES:

Formula weight 153.36. White powder. M.p. 1923°C ; d 5.98. Crystallizes in structure type B1.

Converted to the hydroxide by moisture. The carbonate is formed on exposure to the CO_2 of the air.

REFERENCES:

- I. G. F. Hüttig and A. Arbes, *Z. anorg. allg. Chem.* 196, 403 (1931).
- II. O. Hönigschmid and R. Sachtleben, *Z. anorg. allg. Chem.* 178, 1 (1929); E. H. Archibald, *The Preparation of Pure Inorganic Substances*, New York, 1932, p. 77.

Calcium Hydroxide

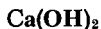

Calcium hydroxide is formed on addition of water to CaO , provided the latter has not been overheated during calcination. Another way is to treat aqueous solutions of calcium salts with alkalis.

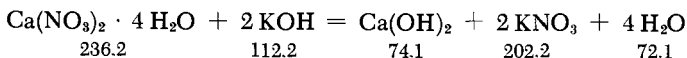

I. Boiled water (500 ml.) is used to dissolve 46 g. of $\text{Ca}(\text{NO}_3)_2 \cdot 4\text{H}_2\text{O}$. To this solution, 500 ml. of 1N C. P. potassium hydroxide solution (CO_2 free) is added in small portions with shaking, the temperature being kept at 0°C . The product is washed a number of times with a total of 12 liters of water, filtered and again washed on

the filter. The precipitate is dried for 20 hours under vacuum over sulfuric acid (d 1.355); it then has a composition corresponding to its formula.

In all of these procedures the CO_2 of the air must be carefully excluded.

II. Crystalline $\text{Ca}(\text{OH})_2$ can be obtained by the diffusion method. Two 50-ml. beakers are placed in a vessel equipped with a removable lid. One of them contains 30 g. of recrystallized $\text{CaCl}_2 \cdot 6\text{H}_2\text{O}$ dissolved in 50 ml. of H_2O ; the other contains 12 g. of NaOH in 50 ml. of H_2O and a small quantity of $\text{Ba}(\text{OH})_2$ to precipitate the carbonate. Enough water is poured into the vessel to cover the beakers 2 cm. above the rim. After four weeks, the 1-cm.-long crystals are collected on a filter crucible and washed quickly with water, dilute hydrochloric acid, water, alcohol and ether. They are then dried for a short time at 110°C .

III. Small crystals can be obtained in a few hours by treating a $\text{Ca}(\text{OH})_2$ solution, saturated at 10°C , with 20 ml. of 20% potassium hydroxide solution.

PROPERTIES:

Hexagonal crystals, which decompose before melting. At a water vapor pressure of 10 mm., the decomposition temperature is 380°C . Moderately soluble in water. d 2.08.

REFERENCES:

- I. G. F. Hüttig and A. Arbes, *Z. anorg. allg. Chem.* 191, 161 (1930).
- II. J. Johnston and C. Grove, *J. Amer. Chem. Soc.* 53, 3976 (1931).
- III. C. Nogareda, *Anales Soc. Espanola Fisica Quim.* 29, 556 (1931).

Strontium Hydroxide



When SrO is moistened with the theoretical amount of water, a vigorous reaction occurs, with formation of $\text{Sr}(\text{OH})_2$ (white powder) and evolution of heat. On further addition of water, the mono-, hepta-, or octahydrate is formed. Because of its low solubility, the octahydrate can be prepared from any soluble Sr salt by precipitating with a strong base.

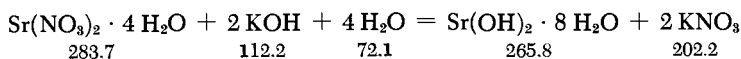

A solution containing 20 g. of $\text{Sr}(\text{NO}_3)_2 \cdot 4\text{H}_2\text{O}$ in 40 ml. of distilled water is cooled to 0°C and treated in the absence of CO_2 with

the equivalent amount of KOH dissolved in 100 ml. of H_2O . The alkali is added drop by drop. The precipitate is washed with 1.5 liters of H_2O and is then free of both K and NO_3 ions.

PROPERTIES:

Prismatic, tetragonal crystals. The first mole of water of crystallization apparently is more readily given off than the others. The dehydration curve shows that, at $p = 10$ mm. H_2O , $Sr(OH)_2$ is stable from 100 to $450^\circ C$. M.p. $375^\circ C$.

REFERENCE:

G. F. Hüttig and A. Arbes, Z. anorg. allg. Chem. 192, 225 (1930).

Calcium, Strontium, Barium Peroxides

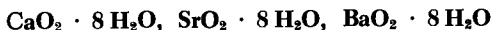

CaO₂

In common with the corresponding magnesium compound, and in contrast to SrO_2 and BaO_2 , CaO_2 cannot be obtained through direct reaction of O_2 with either CaO or Ca. It is found only by heating $CaO_2 \cdot 8H_2O$ above $130^\circ C$. Nearly anhydrous peroxide, $CaO_2 \cdot 0.38 H_2O$, is obtained by direct precipitation from aqueous solutions, e.g., by treating 11 g. of $CaCl_2 \cdot 6H_2O$, dissolved in 50 ml. of 3% H_2O_2 , with 7 ml. of 25% ammonia in 100 ml. of H_2O . The temperature should either be above $60^\circ C$, or the amount of water should be reduced to 30 ml. at $20^\circ C$.

SrO₂

This compound is usually prepared by slow (several hours) dehydration of the octahydrate at $300^\circ C$. It can also be obtained, but not entirely water-free (0.68 mole of H_2O), by precipitating a solution of 5 g. of $Sr(NO_3)_2$ in 5 ml. of 30% H_2O with 7 ml. of 25% ammonia at $55^\circ C$.

Very pure SrO_2 can be prepared from SrO under an O_2 pressure of 200 to 250 atm. at $350-400^\circ C$. The starting material must be free from hydroxide or carbonate and the O_2 should be thoroughly dried.

BaO₂.

The peroxide is prepared by careful dehydration of the octahydrate, first in a desiccator under reduced pressure, and then in a drying pistol over P₂O₅ at 100°C.

According to Bernal et al., preparations containing 100% BaO₂ (or SrO₂) may be obtained only by drying for one month in O₂ at room temperature.

High grade BaO₂ can also be prepared by heating loose BaO at 500°C in a stream of O₂ which has been thoroughly dried and freed of CO₂.

PROPERTIES:

Formula weights: CaO₂ 72.08; SrO₂ 119.63; BaO₂ 169.36. Of the three peroxides (all white) BaO₂ is the most stable and its solubility in water is the highest. When immersed in water, the peroxides gradually form the octahydrates at room temperature. Decomposed by acids with liberation of H₂O₂. Both SrO₂ and BaO₂ crystallize in the tetragonal system. They are face-centered and are isostructural with CaC₂.

REFERENCES:

- CaO₂: R. de Forcrand, *Comptes Rendus Hebd. Séances Acad. Sci.* 130, 1250, 1308, 1388 (1900); E. H. Riesenfeld and W. Nottebohm, *Z. anorg. allg. Chem.* 89, 408 (1914).
- SrO₂: E. H. Riesenfeld and W. Nottebohm, *Z. anorg. allg. Chem.* 89, 408 (1914); C. Holtermann and P. Lafitte, *Comptes Rendus Hebd. Séances Acad. Sci.* 208, 517 (1939).
- BaO₂: P. Askenasy and R. Rose, *Z. anorg. allg. Chem.* 189, 1 (1930); J. D. Bernal, E. Djalowa, I. Kasarnowski, S. Reichstein and A. G. Ward, *Z. Kristallogr.* 92, 344 (1935); C. Engler and W. Becker, *Ber. Heidelberger Akad.* No. 15, 5 (1909/10).

THE OCTAHYDRATES

The peroxide hydrates are formed when alkaline solutions of alkaline earth salts are treated with H₂O₂. To avoid the formation of dihydrates or of anhydrous salts, the following directions must be complied with when working with a Ca salt, for example: 11 g. of CaCl₂ · 6H₂O is dissolved in 5 ml. of H₂O and treated with 50 ml. of 3% H₂O₂. To this solution, 7 ml. of 25% ammonia in 100 ml. of H₂O is added.

The procedure is the same as for the preparation of SrO₂ · 8H₂O. At room temperature BaO₂ · 8H₂O is formed only in strongly alkaline solutions. An excess of H₂O₂ must be avoided. For example,

100 ml. of $\text{Ba}(\text{OH})_2$ solution, previously saturated at 14°C , is treated with 5 ml. of 3% H_2O_2 .

PROPERTIES:

Formula weights: $\text{CaO}_2 \cdot 8\text{H}_2\text{O}$ 216.20; $\text{SrO}_2 \cdot 8\text{H}_2\text{O}$ 263.75; $\text{BaO}_2 \cdot 8\text{H}_2\text{O}$ 313.48.

Lustrous, white crystals. The three compounds are isomorphous. In air, they become opaque and are slowly converted to the carbonates by the CO_2 . They hydrolyze in water and are dehydrated in absolute alcohol.

REFERENCES:

- E. H. Riesenfeld and W. Nottebohm, Z. anorg. allg. Chem. 89, 405 (1914).
 C. Nogareda, Anales Soc. Espanola Fisica Quim. 28, 475 (1930).

Calcium, Strontium, Barium Sulfides

CaS, SrS, BaS

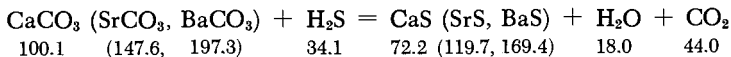

Alkaline earth sulfides can be easily prepared in small quantities (3-5 g.) by heating their pure carbonates (C.P.) for about two hours at about 1000°C in a fast stream of an equimolar mixture of H_2S and H_2 . When water ceases to evolve, H_2 alone is passed through for about half an hour to decompose the polysulfides. The product is left to cool in a stream of H_2 .

Other preparative methods: Larger amounts of sulfides, though of lower purity, can be obtained by heating the carbonates in a crucible with an excess of elemental S. Here, tight closure of the crucible is essential and use of an autoclave is advantageous. This procedure is mostly used to produce phosphors based on alkaline earth sulfides.

PROPERTIES:

White powders (BaS is often grayish). M.p. $> 2000^\circ\text{C}$. d CaS 2.59; SrS 3.65; BaS 4.36. Crystallize in structure type B1. Oxidize in dry air and are decomposed by moisture and, more rapidly, by acids, with which they evolve H_2S .

REFERENCES:

- P. Sabatier, Comptes Rendus Hebd. Séances Acad. Sci. 88, 651 (1879); Ann. Chim. Phys. 5, 22, 6 (1881).
 E. Tiede: Private communication; see also H. von Wartenberg, Z. anorg. allg. Chem. 252, 136 (1943) and A. Guntz and F. Benoit, Bull. Soc. Chim. France (4) 35, 712 (1924).

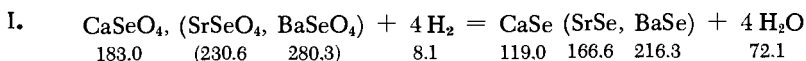
Calcium, Strontium, Barium Selenides**CaSe, SrSe, BaSe**

Small quantities of alkaline earth selenides are obtained by the method of Berzelius, through reduction of the corresponding selenates in a H_2 stream. The water formed in this reaction decomposes the selenides, forming H_2Se . In turn, the latter is thermally cleaved into H_2 and Se, imparting a reddish hue to the preparation. It is therefore highly important to work with a fast H_2 stream and use only small amounts of starting material.

The selenates are prepared from the corresponding alkaline earth nitrates. The salt is added to a concentrated solution of K_2SeO_4 (H_2SeO_4 neutralized with potassium hydroxide). The precipitate is filtered off and dried at 200°C .

The selenate (about 1 g.) is distributed in a thin layer over a quartz boat 10 cm. long and 1 cm. wide. The drying at 200°C is repeated, this time in a reaction tube and in a stream of N_2 . Reduction in a stream of H_2 follows. It should continue for two hours between $400\text{--}500^\circ\text{C}$ for CaSeO_4 , at 600°C for SrSeO_4 , and at 500°C for BaSeO_4 . A pure white product is obtained for SrSe and BaSe, but in the case of CaSe the white color occasionally shows a reddish tint.

To avoid undesirable decomposition caused by air moisture, transfer of the product from the boat must be carried out in the absence of air. Special devices are used for this purpose. These are connected to the reaction tube by means of ground-glass joints, so that the boat contents can be emptied into a side attachment (see Part I, p. 75).

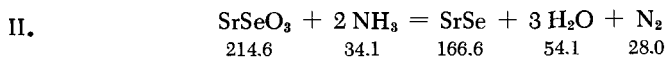

Pure SrSe is best obtained from the selenite by high-temperature reduction with NH_3 . The SrSeO_3 is prepared by dissolving repeatedly sublimed SeO_2 in water and adding the theoretical amount

of hot strontium nitrate solution (for a special method of purifying the salt, see Smith, Rosenstein and Ward). After neutralizing the solution with ammonia, the strontium selenite is filtered off, washed six times with water until free of nitrate, and dried at 200°C. The salt is reduced in a fast stream of NH₃ at 860°C. The reaction is completed in 2-3 hours.

When NH₃ is used as the reducing agent, side reactions take place.

Occasionally, N₄Se₄ forms in the colder portion of the tube and explodes when the boat is taken out.

The same method is used to prepare CaSe.

PROPERTIES:

White powders. d CaSe 3.82; SrSe 4.54; BaSe 5.02. Crystallize in structure type B1.

In air, the powders acquire a reddish color within a few minutes and turn light brown in a few hours. Decomposed by water. Treatment with HCl produces H₂Se gas, and red Se separates.

REFERENCES:

- I. F. A. Henglein and R. Roth, Z. anorg. allg. Chem. 126, 227 (1923); E. Tiede and E. Blasius, unpublished experiments.
- II. A. L. Smith, R. D. Rosenstein and R. Ward, J. Amer. Chem. Soc. 69, 1725 (1947).

Calcium, strontium and barium tellurides, although not perfectly pure, can be obtained similarly by reduction of the tellurates in a hydrogen stream (CaTe at 680°C, SrTe at 690°C, BaTe at 580°C).

REFERENCE:

M. Haase, Z. Kristallogr. 65, 509 (1927).

Calcium, Strontium, Barium Nitrides

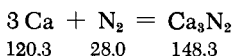

Distilled, finely divided Ca metal is placed in a Ni boat and in a nitrogen stream for 3-4 hours at 450°C. At this temperature the

nitriding is particularly rapid, because the lattice of the metal becomes less compact as a result of structural changes in the crystals (transition point).

Contradictory data have been published on the nitriding temperature for Ca. The reaction has been reported to proceed at a measurable rate only above 800°C. The discrepancies, it seems, can be traced to use of metal which is not quite pure, or of N₂ still containing traces of O₂.

Small amounts of Na vapor absorbed by the surface of the metal prevent the formation of a continuous nitride film; hence, they activate the metal. The latter, in the active form, is an agent for purifying argon; see p. 82.

When Ca metal is treated with NH₃ at 800°C, some hydride is formed simultaneously.

PROPERTIES:

α -Ca₃N₂ (structure type D5₃) transforms into β -Ca₃N₂ at 700°C. Depending on the temperature of formation the nitride powder is colored black (350°C) to golden yellow (1150°C), or else acquires mixed coloration (at intermediate temperatures). *d* 2.62. Decomposes in water to Ca(OH)₂ and NH₃.

REFERENCES:

- F. W. Dafert and R. Miklauz, *Monatsh. Chem.* 34, 1685 (1913).
P. Dutoit and A. Schnorf, *Comptes Rendus Hebd. Séances Acad. Sci.* 187, 300 (1928).
A. von Antropoff and E. German, *Z. phys. Chem.* 137, 209 (1928).
J. Rieber, Thesis, Technische Hochschule, Hannover, 1930.
M. von Stackelberg and R. Paulus, *Z. phys. Chem. B* 22, 305 (1933).

Sr₃N₂ and Ba₃N₂

The nitriding temperatures for Sr and Ba are 460 and 560°C, respectively. To achieve complete conversion to the nitride, the heating must be continued for a long time or the temperature must be raised to 700-750°C on cessation of absorption of N₂.

REFERENCES:

- F. W. Dafert and R. Miklauz, *Monatsh. Chem.* 34, 1685 (1913).
A. Guntz and F. Benoit, *Ann. Chim.* (9) 20, 15 (1923).

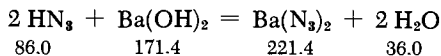
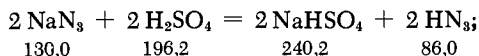
Barium Azide

Hydrazoic acid is formed on dropwise addition of sulfuric acid (1 : 1) to NaN_3 solution. The acid is next distilled into a receiver, which contains a $\text{Ba}(\text{OH})_2$ suspension (2/3 of the calculated amount). The distillation temperature should be about 60°C (or lower, if the pressure is reduced). A few drops of phenolphthalein are added to the reaction mixture and, toward the end of distillation, the remaining $\text{Ba}(\text{OH})_2$ is added continually to a neutral reaction (disappearance of red color). The work must be done under a good hood (strong draft), because the HN_3 vapor is highly toxic.

Another way of preparing the azide is to place the entire quantity of $\text{Ba}(\text{OH})_2$ in the receiver and use a higher dilution. The excess of hydroxide is then removed by passage of CO_2 , and the precipitated BaCO_3 is filtered off.

The $\text{Ba}(\text{N}_3)_2$ solution is crystallized in a vacuum desiccator over CaCl_2 . The resultant monohydrate is completely dehydrated over P_2O_5 . A preliminary recrystallization of the salt is advisable.

The strontium salt is prepared by a similar procedure.

PROPERTIES:

Crystallizes in cylindrical crystals. On impact, explodes with mild force, bursting into flames. d 2.94.

REFERENCE:

P. Remy-Genneté: *Ann. Chimie* (10) 19, 289 (1933).

Calcium Phosphide

To prepare this salt, distilled Ca is heated with red P in a thoroughly evacuated combustion tube. The heating is continued

until the reaction becomes spontaneous. This is accompanied by incandescence. Milder reaction conditions result in a higher quality product. To this end, Ca is heated to dull red heat in a corundum boat, and P is slowly distilled onto the Ca. After cooling, the sealed end of the tube is broken off, and the tube is filled with dry CO_2 , using the same procedure as described for Mg_3P_2 (II).

To ensure that no excess metal remains in the preparation, the product must be heated again with P for a long time at 600°C . An evacuated, sealed tube is used for this purpose.

Where purity requirements are particularly high, Ar should be used as carrier gas, following the directions given for Mg_3P_2 (I).

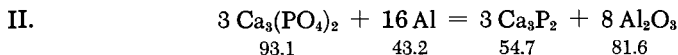

If Ca_3P_2 is to be used only as a raw material for the preparation of PH_3 , it can be prepared by the aluminothermic method. The drawback of this procedure is that the product phosphide cannot be separated from the Al_2O_3 .

Powdered, predried calcium phosphate (232 g.) and 108 g. of Al shot are ground to a homogeneous mixture. An igniting mixture is used to kindle the reaction. In most cases it is necessary to preheat the crucible to 500°C .

PROPERTIES:

Crystalline, red-brown powder. d 2.51. Decomposes slowly in moist air and more vigorously in water yielding $\text{Ca}(\text{OH})_2$ and PH_3 .

REFERENCES:

- I. F. Weibke, Thesis, Technische Hochschule, Hannover, 1930.
- II. C. Matignon and R. Trannoy, Comptes Rendus Hebd. Séances Acad. Sci. 148, 167 (1909).

Calcium Carbide



The CaC_2 obtained on reversal of the reaction producing CaCN_2 or on heating a mixture of CaCN_2 and C under high vacuum is much purer than that from the synthesis from the elements or the reaction between CaO and C.

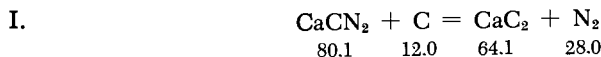

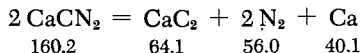

A sintered clay boat is charged with pure CaCN_2 , either alone or with an added amount (somewhat below the calculated value) of well-charred sugar charcoal or acetylene black. The boat is inserted into a ceramic tube (inside diameter 30 mm., length 500 mm.). The tube is provided with a ground stopper at one end and sealed at the other. It is connected to a high-vacuum system and heated by means of an electric furnace with a molybdenum wire winding to temperatures above 1350°C .

The cyanamide (or the mixture with carbon) is heated in two stages. The first heating is continued for 2-3 hours at 1100 - 1150°C to remove most of N_2 , which is drawn off under high vacuum. It is imperative that the temperature does not exceed 1170°C , since this is the eutectic temperature for the system CaCN_2 - CaC_2 . By that time the cyanamide is so far decomposed that mixed crystals of CaC_2 and CaCN_2 cannot be formed during the second heating stage at a higher temperature (1350°C , one hour), and thus the last traces of N_2 are quantitatively expelled. The product is pure white and contains over 99% CaC_2 , with no impurities, except traces of CaO and C .

The very slight corrosion of the Al_2O_3 boat by the CaCN_2 cannot be entirely avoided. However, the loosely adhering product layer is easily detached.

II.

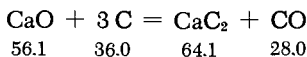

Laboratory preparation of calcium carbide via the reaction of pure CaO with very pure carbon in an electric arc at 2000°C is carried out as follows.

A large porcelain crucible, at least 80 mm. in diameter on top and 60 mm. high, is filled with a well-blended, dry mixture of equal parts of quicklime and wood charcoal to a level 10 cm. below the rim. The ingredients are not too finely powdered to prevent elutriation losses during later gas evolution. The crucible is placed on top of a brick. Two carbon rods (carbon welding electrodes, or rods made of electrolytic graphite), at least 15 mm. in diameter and 200 mm. long, are tapered to a point at their lower ends, while slotted (and thus flexible) brass caps are affixed on their upper ends. Each cap has a clamp screw, which serves as an electric terminal. A horizontal hole is drilled through each carbon rod and cap combination, and a 1-2 mm. connective copper wire is fitted snugly into the hole and bent back at both ends so that the cap is securely attached to the electrode. The electrodes are attached to a stand in such a way that they reach

down to the center of the crucible, and their points are about 10 mm. apart. The asbestos insulated clamps connecting the electrodes to the stand are attached just below the brass caps. The lime-charcoal mixture is piled up in the center of the crucible and the latter is then covered with an asbestos sheet. Insulated copper wires (cross section 16 mm.) connect the electrodes to the power supply. The electrodes are in series with 0-50 amp. ammeter, a 40 amp. rheostat (6 ohms at 220 v., 3 ohms with a line voltage of 110 v.) and a double-pole knife switch. Where a suitable rectifier is available the use of direct current is preferred since a D.C. arc is far smoother than an A.C. arc. The potential across the electrodes is measured with a voltmeter.

The current is switched on with the rheostat set at maximum. It takes some time before the electric arc is initiated. The current is then set at 30-40 amp. The voltmeter should register a potential of 50-70 v. If the reading is much higher, the carbons are too far apart (and vice versa). The current must be shut off before any adjustment is made. When the operation is properly conducted, long tongues of burning CO escape from the crucible together with occasional puffs of dust from the charge. The current is shut off after 5-10 min. and the crucible is left to cool. A few grams of sintered or lump calcium carbide will be found under the electrode ends.

Other methods: III. Heating distilled Ca metal with C produces dark-colored or black carbides which are 94% pure, at best. IV. Technical grade carbide, 75-89% pure, can be enriched to 92% grade (containing residual Ca and C) by remelting a number of times at 2100°C, separation of strata, and compressing.

PROPERTIES:

When pure, colorless and crystalline. M.p. ~2300 C; d 2.22. The structure of pure CaC_2 differs from that of the commonly used "technical" carbide which is contaminated with impurities (pseudocubic, tetragonal, face-centered). Decomposes in water, evolving acetylene.

REFERENCES:

- I. H. H. Franck, M. A. Bredig and K. H. Kou, *Z. anorg. allg. Chem.* 282, 75 (1937).
- II. W. Fischer, private communication; see also H. Grubitsch, *Präparative Anorganische Chemie*, Vienna, 1950, p. 333.
- III. E. Botolfsen, *Ann. Chim.* [9] 18, 5 (1922); O. Ruff and E. Foerster, *Z. anorg. allg. Chem.* 131, 321 (1923); O. Ruff and B. Josephy, *Z. anorg. allg. Chem.* 153, 17 (1926); H. H. Franck, M. A. Bredig and K. H. Kou, *Z. anorg. allg. Chem.* 232, 75

(1937); see also H. H. Franck and H. Endler, *Z. phys. Chem.* (A) 184, 127 (1939).

IV. O. Ruff and E. Foerster, *Z. anorg. allg. Chem.* 131, 321 (1923).

Calcium Cyanamide

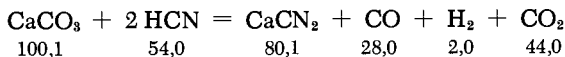

Pure CN, previously dried over CaCl_2 and P_2O_5 , is condensed in a receiver cooled to a low temperature. The amount used is three times the stoichiometric quantity. A stream of N_2 is bubbled, preferably mixed with NH_3 , through the receiver and becomes laden with HCN. It is then passed over CaCO_3 , which fills a porcelain boat inserted into a porcelain tube. The cooled HCN receiver is warmed to 18°C when a reaction temperature of 700 to 850°C is reached in the porcelain tube, but not before. Heating for three hours yields a perfectly white, 99.4% pure product (34.8% N).

PROPERTIES:

Colorless crystals. M.p. $\sim 1200^\circ\text{C}$. Gradually decomposed by water. Simultaneous treatment with CO_2 and water liberates free cyanamide. Warming a cyanamide solution to 70°C yields urea.

REFERENCE:

H. H. Franck and H. Heimann, *Angew. Chem.* 44, 372 (1931).

Calcium Silicides

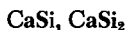

CaSi

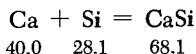

A mixture of Ca chips and pure Si (15% excess) is placed in a boat made of unglazed hard porcelain. The boat is immediately pushed into the hot (1000°C) zone of a quartz tube through which a CO_2 stream is passed. Within a few seconds a vigorous reaction

sets in and the mass begins to melt. The boat is then withdrawn from the hot zone, thus immediately quenching the product. When crushed to a powder, the grayish-black, porous, solid mass disintegrates into CaSi flakes, which have a metallic luster. The thin crust of CaO is easily removed.

PROPERTIES:

Covering CaSi with dilute hydrochloric acid causes vigorous decomposition. Spontaneously igniting silanes are formed, with white silicic acid as the residue.

CaSi₂

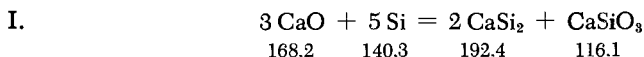

Following Goldschmidt's procedure, CaSi₂ is prepared by fusing high purity CaO (53.6%) and Si (26.4%) in the presence of suitable fluxes (12% CaF₂ and 8% CaCl₂) at 1400°C. The melt must be thoroughly stirred with an Al₂O₃ rod so that the molten CaSi₂ will separate on the surface of the melt. The hot, viscous reaction mixture disintegrates on cooling, freeing silicidic particles. The product obtained by this method is always rich in Si.

Larger charges result in improved yields.

II. Simple fusion of the elements does not produce pure CaSi₂. Therefore, for smaller quantities and higher purity, it is preferable to heat CaSi with the stoichiometric amount of Si.

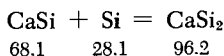

The mixture is placed in a Ni boat and heated in a stream of H₂ at 1000°C. The last phase of conversion proceeds very slowly and requires up to 15 hours of heating.

Other methods: CaSi₂ can also be prepared, according to Doderò, by melt electrolysis above 1000°C using a flux. The proportions of the components are: 3SiO₂ + 3CaCO₃ + 6 CaF₂ + CaCl₂.

PROPERTIES:

Hexagonal lead-gray tablets, with a bright metallic luster. M.p. 1020°C; d 2.5. Crystallizes in structure type C12. If not sufficiently cooled with ice, reaction with HCl is violent and the disilicide dissolves while a characteristic greenish-yellow product separates out.

For the preparation of strontium and barium silicides, see Wöhler and Schuff. The reaction proceeds as in the case of calcium silicide, through at a somewhat higher temperature.

REFERENCES:

- L. Wöhler and F. Müller, *Z. anorg. allg. Chem.* 120, 49 (1922).
 L. Wöhler and W. Schuff, *Z. anorg. allg. Chem.* 209, 33 (1932).
 M. Dodero, *Comptes Rendus Hebd. Séances Acad. Sci.* 198, 1593 (1934).

Calcium Germanide**CaGe**

Calcium turnings are ground to a fine powder in a ball mill under anhydrous benzene. Traces of benzene are then removed under vacuum.

Using the method described on p. 712, GeO_2 is reduced to metal powder with the aid of H_2 .

The metal powders are mixed in stoichiometric proportions in an alundum boat. The boat is placed in an evacuated quartz tube and the reaction is started by bringing the boat contents to red heat. Suddenly a bright glow appears at one spot, spreading within seconds throughout the boat and causing partial pulverization of its contents. The reaction is finished at that point, but the product still contains some unreacted Ge. This happens even when an excess of calcium is used.

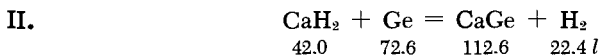

Germanium powder is mixed with an equimolar quantity of CaH_2 , previously pulverized under N_2 blanket. The hydride is taken in slight excess. The mixture is placed in an iron boat and the latter inserted into an electrically heated ceramic tube. The atmosphere within the tube is inert at that point. The tube is then connected to a high-vacuum system. The reaction begins at about 450°C and is finished at about 950°C , provided the H_2 formed in the process is removed at regular intervals. The temperature is then raised to 1000°C and gas removal continued for another half hour to achieve complete removal of the last traces of H_2 . After cooling under vacuum, the tube is opened and the product is pulverized as rapidly as possible and placed in sealed ampoules. It still contains traces of Ca.

PROPERTIES:

Dark-gray powder. Rapidly turns yellow on exposure to atmospheric moisture.

REFERENCES:

- P. Royen and R. Schwarz, Z. anorg. allg. Chem. 211, 412 (1933).
With regard to Ca_2Ge see also P. Eckerlin and E. Wölfel, *ibid.* 280, 321 (1955).

Alkali Metals

E. DÖNGES

Alkali Metal Compounds from Minerals

LITHIUM CARBONATE FROM LEPIDOLITE

Lepidolite contains 1.2-6% (average 4-5%) LiO_2 . According to a patent (Metallbank, Metallurgische Ges. A.G.), lepidolite is converted to Li_2CO_3 (and LiF or Li_3PO_4) in the following way.

Lepidolite is decomposed with concentrated H_2SO_4 and is then well calcined to decompose aluminum and iron sulfates. The aqueous extract of the roasted material contains impurities composed of salts of Al, Fe, Mg, Mn, etc. Most of these are separated by treatment with lime and calcium hypochlorite (to oxidize Mn). This purified liquor contains, in addition to Li and K sulfates (e.g., 6.6 g. of lithium/liter), traces of other salts such as CaSO_4 and occasionally MnSO_4 and MgSO_4 . For this reason, a concentrated solution (about 1%) of Li_2CO_3 , LiF , or Li_3PO_4 is added to the liquor until a precipitate ceases to form. About 100-150 ml. of the carbonate solution is required per liter of liquor, depending on how well the latter was prepurified. It is better to precipitate the last traces of impurities with a lithium salt, rather than with some other alkali salt, because an excess of the former precipitating agent causes no loss of original Li.

The liquor is then repeatedly purified until the Li_2CO_3 , precipitated on addition of pure K_2CO_3 and filtered, washed and dried, is of analytical priority. Since the solubility of LiCO_3 is very high, large quantities of Li are still present in the mother liquor. This solute can be precipitated as the phosphate or the fluoride. These salts will also be very pure. Needless to say, all the Li can be precipitated as pure phosphate or fluoride without going through the partial precipitation of the carbonate.

This method can also be used for the purification of technical grade Li salts contaminated with Ca, Mg, Fe, etc.

Solubility of Li_2CO_3 (0°C) 1.54; (20°C) 1.33; (100°C) 0.73 g./100 g. of H_2O .

Solubility of LiF (18°C) 0.27 g./100 g. of H_2O .

Solubility of Li_3PO_4 (25°C) 1 g./3360 g. of H_2O .

REFERENCES:

Metallbank, Metallurgische Gesellschaft A. G., German Patent 413723 (1925). Inventor H. Weidmann.

RUBIDIUM AND CESIUM CHLORIDES FROM CARNALLITE

Natural carnallites contain, on the average, 0.02% RbCl and 0.0002% CsCl . "Synthetic carnallites," which are obtained as intermediates in the manufacture of potassium chloride through recrystallization of natural carnallite, have a much higher Rb and Cs content.

I. According to Jander and Faber, as well as Jander and Busch, the first step in the simultaneous production of RbCl and CsCl from synthetic carnallite is recrystallization of the latter. Thus, synthetic carnallite (6.5 g.) is boiled in 2.3 liters of water. The hot liquor (d. 1.3) is suction filtered on a Büchner funnel to separate the solid KCl precipitate. The residue is placed in a dish and treated with 400 ml. of hot water to extract all soluble material. Next, it is washed on the filter with 150 ml. of cold water. While still somewhat moist it weighs about 1300 g. and is free from both Rb and Cs . [A sample dissolved in dilute HCl and treated with a silicomolybdate solution (see below) forms no precipitate even after standing for several hours.] The combined filtrates are evaporated until crystallization begins. The "second synthetic carnallite" precipitated overnight from the cooled solution amounts to about 2270 g. and contains all the Rb and Cs . The concentration of these elements is thus three times higher than in the first synthetic carnallite. The mother liquor gives no precipitate on addition of a silicomolybdate solution even if allowed to stand for many hours.

The second synthetic carnallite can be further enriched by repetition of the crystallization. However, this is not necessary.

To precipitate the silicomolybdate salts, 2.3 kg. of the second carnallite is dissolved in 2.9 liters of warm water and treated with 0.9 liter of concentrated hydrochloric acid. The KCl (about 70 g., free of Rb and Cs) which separates out on cooling to room temperature is filtered off and the solution is reheated to 60–70°C. Vigorous agitation is then started and the solution is treated with sufficient amount of molybdosilicate solution (see p. 953) to precipitate one-tenth of the total available silicomolybdate $\text{Rb}_4[\text{SiMo}_{12}\text{O}_{40} \cdot 2\text{H}_2\text{O}]$ and $\text{Cs}_4[\text{SiMo}_{12}\text{O}_{40} \cdot 2\text{H}_2\text{O}]$. The required quantity of solution is determined on a sample. Usually, more reagent will be needed than indicated by stoichiometry. The precipitate starts to form on cooling to 40–50°C and requires 12–15 hours for complete settling.

The clear supernatant liquid is then decanted. The scaly precipitate, which adheres to the walls of the container, detaches after brief drying in air and is quantitatively collected. The precipitate now contains all of the Cs and one tenth of the Rb. The Cs:Rb ratio is now 1:10, instead of the original 1:100. The silicomolybdate precipitate is then worked up to obtain the CsCl. It is placed in a porcelain boat, which is then inserted in a Pyrex tube. If larger quantities are handled, the precipitate may also be placed in a second tube and distributed in a layer not more than 0.5 cm. thick. This second tube is then concentrically inserted into the first. The assembly is heated in an electric furnace to 450°C while HCl gas, saturated with CCl₄ in a wash bottle filled with liquid CCl₄, is allowed to flow through the tube. The CCl₄ vapor is thermally decomposed to C₂Cl₆ and Cl₂. The latter is to prevent the formation of a small amount of volatile low-valence Mo compounds. Loose crystalline deposits of Mo(OH)₂Cl₂ are formed in the rear, cold portion of the tube. The exit HCl gas is passed through a water-filled wash bottle to absorb any entrained Mo(OH)₂Cl₂. To remove all traces of Mo from the product mixture of alkali chlorides, Cl₂ is passed through the apparatus for a short time. This is done toward the end of the reaction, which lasts 1.5 hours. During the final stage of conversion the temperature is increased to incipient red heat.

The pure white residue consists of RbCl, KCl, CsCl and SiO₂. It is repeatedly extracted with hot water, and the silicic acid is filtered off. The filtrate is evaporated to dryness. To separate KCl and RbCl from CsCl, 16 g. of dry residue is dissolved in 40 ml. of warm 2.5N HCl and treated with 50 ml. of warm 96% alcohol. After cooling, the first KCl-RbCl precipitate is filtered off and the filtrate is heated and again treated with 300 ml. of warm 96% alcohol. Upon cooling, the second RbCl-KCl precipitate is filtered off and the filtrate once more treated with 50 ml. of alcohol and filtered as above. The filtrate is evaporated; the residue contains all the CsCl. It is dissolved in 20 ml. of 2.5N HCl and treated with 5 ml. of 20% SbCl₃ solution in 7.5N HCl. After a while, the Cs precipitates out as the chloroantimonate. The concentration of RbCl in the entire resulting solution must not exceed 1 M following the addition of the SbCl₃, since otherwise rubidium chloroantimonate is coprecipitated. The cesium chloroantimonate is then placed in a boat and heated in a stream of HCl gas at 250°C. The SbCl₃ distills off and the CsCl remains as a residue. It can be tested spectroscopically for K and Rb.

The mother liquor from the cesium chloroantimonate precipitate still contains a considerable amount of Cs. It is evaporated to dryness and the residue is freed of SbCl₃ by distillation in a stream of HCl. The resulting mixture of CsCl, RbCl and some KCl is added to the material treated with alcohol to separate the RbCl.

To obtain rubidium, the filtrate from the first fractional precipitation of silicomolybdates is used to dissolve the first fraction of the RbCl-KCl precipitate obtained during the separation of CsCl by treatment with alcohol. Next, the silicomolybdate reagent is added until the solution acquires a permanent yellow color, and most of the Rb present completely precipitated. The precipitate is washed four times (vigorous stirring) with 200-ml. portions of 2.5N HCl, filtered through a fritted glass filter, dried in a vacuum desiccator, decomposed in an HCl stream, and is finally freed of SiO_2 , as described above.

The dry residue so obtained consists of RbCl-KCl and is combined with the second and third RbCl-KCl fractions previously obtained in the separation of CsCl by alcohol treatment. The combined residue is redissolved in 180 ml. of 2.5N HCl and once more treated with the silicomolybdate reagent. The latter is added in portions with vigorous stirring until complete precipitation results. The precipitate is washed twice (vigorous stirring) with 60-ml. portions of 2.5N HCl, filtered as above and dried. Finally, it is converted to the chloride and freed of SiO_2 . The purity of the resulting RbCl can be tested spectroscopically.

If the negligible amount of CsCl carried along with the RbCl is not harmful, the latter can be completely precipitated in a single step.

If larger quantities are desired, the wet method of silicomolybdate decomposition is more convenient. The latter complex is treated with barium hydroxide solution saturated at low temperature. (To avoid working with excessive quantities of liquid, part of the $\text{Ba}(\text{OH})_2$ can be added as the solid.) The amount added must exceed by 20% the amount required to decompose the complex into barium molybdate, barium silicate and RbOH (CsOH). The mixture is then boiled for thirty minutes. Flame gases containing CO_2 should not come in contact with the mixture or large amounts of $\text{Ba}(\text{OH})_2$ will be converted to worthless BaCO_3 . The barium molybdate and barium silicate which separate are not filtered off until after the reaction mixture has cooled. The filtrate is then saturated with CO_2 and boiled for fifteen minutes. The BaCO_3 precipitate is filtered off and the filtrate is evaporated with simultaneous addition of hydrochloric acid. The residue contains RbCl and CsCl free of Mo and Ba.

Preparation of silicomolybdate reagent: A boiling solution of 60 g. of NaOH in 400 ml. of H_2O is prepared, and 172 g. of MoO_3 , free of ammonium salts, is added in small portions over a period of 10-15 minutes. Heating is then stopped and 500 ml. of cold water is poured into the solution. Next, 250 ml. of HNO_3 (d. 1.39) is diluted with water to a volume of 350 ml. and is added. Although the addition should be rapid, only small portions are added at one time. Vigorous agitation must be maintained throughout. No

permanent precipitate should form during these additions. Immediately thereafter, a silicate solution is added in a thin jet and with vigorous stirring. The solution is prepared from 28 g. of $\text{Na}_2\text{SiO}_3 \cdot 9\text{H}_2\text{O}$ dissolved in 125 ml. of 2N NaOH and boiled for 10-15 min.

The deep-yellow silicomolybdate solution is concentrated on a water bath to a volume of 700-800 ml. At this point some ammonium silicomolybdate may separate out if the MoO_3 used was not completely free of the NH_4^+ salt.

Recovery of molybdosilicate solution. The silicate-containing precipitate of barium molybdate is boiled for 30 minutes with a slight excess of sodium carbonate solution, using vigorous stirring. On cooling, the silicate and carbonate are filtered off. A silicomolybdate solution is then prepared from the filtrate, which contains all of the molybdic acid in the form of Na molybdate. The directions are the same as given above. The only difference is that 280 ml. of concentrated nitric acid is required here, instead of 250 ml., because the Na molybdate solution still contains a slight excess of Na_2CO_3 (caution: violent foaming occurs on addition).

The excess of silicomolybdate reagent, which is added to the HCl solution of carnallite in order to completely precipitate the Rb, can be separated off as yellow ammonium silicomolybdate upon addition of an excess of a concentrated aqueous solution of NH_4NO_3 . Molybdic acid is recovered from the above ammonium salt by the same method as used for processing Rb silicomolybdate.

II. *Other methods.* The industrial D'Ans process uses tetraoxalates in the preparation of Rb (and Cs) from carnallites. In this method rubidium carnallite, previously isolated by a series of fractional precipitations, is dissolved in a small amount of water and the hot solution treated with an excess of oxalic acid. This excess should be so large that after cooling and separation of $\text{RbH}_3(\text{C}_2\text{O}_4)_2 \cdot 2\text{H}_2\text{O}$ the strongly acid solution (HCl) will still be saturated with oxalic acid. This can be easily checked under a microscope. The well-crystallized tetraoxalate is suction filtered and recrystallized from hot water. The tetraoxalates of Rb and Cs are similar, both being readily soluble in hot water. If it is desired to obtain the Cs, which is present together with the Rb, a brief series of fractional precipitations of the oxalate must be performed. As a result, the Cs, which is the more soluble component, will concentrate in the mother liquor. The Rb tetraoxalate is converted to carbonate by calcination at a moderate temperature, immediately yielding a pure-white product free of traces of Cs.

The precipitation of Rb and Cs in the laboratory is not quite complete. Even though the mother liquor, containing hydrochloric

and oxalic acid, can be further processed to obtain the residual amounts of Rb and Cs [together with $Mg(OH)_2$], this can be done effectively only on an industrial scale.

PROPERTIES:

RbCl: Formula weight 120.9. M.p. $717^\circ C$, b.p. $1383^\circ C$. Solubility ($0.55^\circ C$) 77.34; ($18.70^\circ C$) 90.32; ($114.0^\circ C$) (b.p.) 146.65 g. RbCl/100 g. H_2O . Solubility in ethyl alcohol ($25^\circ C$): 0.078 g. RbCl/100 g. alcohol. d. (x-ray) 2.79. B1 structure type.

CsCl: Formula weight 168.4. M.p. $645^\circ C$, b.p. $1303^\circ C$. Solubility ($0.70^\circ C$) 162.29; ($16.20^\circ C$) 182.24; ($119.4^\circ C$) (b.p.) 289.98 g. CsCl/100 g. H_2O . d. (x-ray) 3.99. B2 structure type.

REFERENCES:

- I. G. Jander and H. Faber, *Z. anorg. allg. Chem.* 179, 321 (1929).
G. Jander and F. Busch, *Z. anorg. allg. Chem.* 187, 165 (1930);
194, 38 (1930).
- II. J. D'Ans, *Angew. Chem.* 62, 118 (1950).

CESIUM CHLORIDE AND CESIUM ALUM FROM POLLUCITE

CESIUM CHLORIDE

Pollucite (pollux) is a cesium aluminum silicate, about one-third of which is Cs_2O . Lenher, Kemmerer and Whitford recommend the following method for obtaining Cs from this mineral.

The mineral is thoroughly pulverized and about 5 kg. of it is passed through a fine-mesh flour sieve. Such fine division of the mineral ensures slow but complete decomposition with concentrated hydrochloric acid. After evaporating the hydrochloric acid and dehydrating the silicic acid at $110^\circ C$, the mass is extracted with 3N HCl (this is the optimal concentration for subsequent precipitation of Cs-Sb chloride) and the Cs is precipitated as cesium antimony chloride, $3CsCl \cdot 2SbCl_3$, on adding a slight excess of a solution of $SbCl_3$ in 3N HCl. A small amount of CsCl remaining in solution can be recovered by evaporating the filtrate, dissolving the residue in 3N HCl, and precipitating with the $SbCl_3$ solution.

The cesium antimony chloride is hydrolyzed by boiling with water. The solution contains the Cs, a very small amount of Sb, and traces of Fe and Al. The Sb is precipitated with H_2S ; the CsCl is either obtained directly by evaporating the solution, or else it is converted first to nitrate and then to carbonate (see "Very Pure Alkali Metal Carbonates"). The yield is about 37%, based on the original pollucite.

CESIUM ALUM

The alkali metals and Al are present in pollucite in about the right proportions for the formation of alum. Hence, the procedure of Clusius and Stern can be followed. The mineral is decomposed with hydrochloric acid and Cs is precipitated as a low-solubility alum by treatment with sulfuric acid. Thus, for example, 0.5 kg. of very finely pulverized (0.01 mm.) pollucite in one liter of 18% hydrochloric acid is evaporated to dryness on a water bath. This procedure is repeated three times, and each time the dry residue is extracted with one liter of H₂O + 100 ml. of concentrated hydrochloric acid. This is followed by suction filtration on a filter cloth. The filtered extracts are combined and concentrated to one liter, and the silicic acid, which separates out almost completely, is decanted. The alum is then gradually precipitated with 200 ml. of concentrated H₂SO₄. After cooling, about 545 g. of crude yellowish alum is obtained. The mother liquor is practically free of Cs. The crystallization is repeated several times, in each case dissolving 250 g. of the alum in 2.5 liters of boiling water in a four-liter Erlenmeyer flask. On slow cooling (constant agitation, 10 hours) the alum again separates out. The material obtained after six crystallizations shows no traces of other alkali metals. One way to ensure pure alum is to check the purity of the mother liquor from which it is precipitated. The specific conductivity of a pure Cs alum solution is $1.39 \cdot 10^{-3} \Omega^{-1} \cdot \text{cm.}^{-1}$ (measured at 25°C, saturated solution).

REFERENCES:

- V. Lenher, G. Kemmerer and E. Whitford, *Ind. Eng. Chem.* **16**, 1280 (1924).
 K. Clusius and H. Stern, *Helv. chim. Acta* **33**, 462 (1950).

Free Alkali Metals

ELECTROLYTIC PREPARATION OF LITHIUM

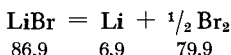

Pure Li is prepared (via the method of Ruff and Johannsen) from LiBr which is melted in an electric arc in the presence of 10-15% LiCl (the LiBr is obtained from Li₂CO₃ by evaporating the latter from hydrobromic acid). Fig. 260 is a scale drawing (1:5) of the Muthmann electrolysis vessel used for the melting procedure. It is made of copper and its upper part is cooled with water. While

the melting point of pure LiBr is about 546°C and that of LiCl is 606°C , a mixture of LiBr with 13% LiCl solidifies at 520°C . The electrolysis proceeds at 10 v. (as measured across the terminals)

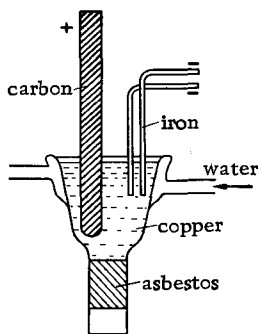

Fig. 260. Electrolytic preparation of lithium. The electrolysis vessel, made of copper, has a diameter of about 8 cm. at the top and about 2.5 cm. at the bottom.

and 100 amp. A graphite rod is used as an anode and two 4-mm. iron wires serve as cathodes. The metal, which deposits at the cathodes, is scooped up from time to time with a flat iron spoon and, while still liquid, is separated from the solidified melt on a cold stone plate. It is next freed of adhering salt using Borchers' method, i.e., by immersion in a paraffin bath ($180\text{--}200^{\circ}\text{C}$). The salt settles to the bottom, while the metal rises to the surface. After cooling, it is washed with ligroin. It is stored under ligroin (d. 0.56) in completely filled, tightly closed vessels.

REFERENCES:

- O. Ruff and O. Johannsen, *Z. Elektrochem.* 12, 186 (1906).
 W. Borchers, *ibid.* 3, 39 (1895).

PURIFICATION OF TECHNICAL GRADE LITHIUM: REMOVAL OF POTASSIUM

Technical grade lithium prepared by electrolysis of a fused, low-melting mixture of LiCl and KCl is, according to Ruff and Johannsen, contaminated with a few percent of potassium. The latter is removed by the Guntz and Broniewski procedure. The Li is converted to LiH by heating in a stream of H_2 at $700\text{--}800^{\circ}\text{C}$ (see the preparation of LiH). The potassium volatilizes in the metallic form, since its hydride is unstable at this high temperature. The LiH is then decomposed under vacuum at 1000°C , the purified Li being condensed on a water-cooled iron cylinder mounted in the reaction vessel.

REFERENCES:

- O. Ruff and O. Johannsen, *Z. Elektrochem.* 12, 186 (1906).
 A. Guntz and W. Broniewski, *J. Chim. phys.* 7, 468 (1909).

ALKALI METALS OBTAINED BY REDUCTION WITH ZIRCONIUM

Dissolved gases trapped during preparation are particularly difficult to remove from alkali metals. The removal of these gases

requires repeated distillation under vacuum, and even then the complete separation is difficult to achieve. Therefore, laboratory methods for preparation of pure alkali metals should avoid any contact of gases with the nascent metal. According to De Boer, and also Broos and Emmens, the reduction of alkali chromates as well as of bichromates, molybdates and tungstates with zirconium powder meets the above specification, particularly well.

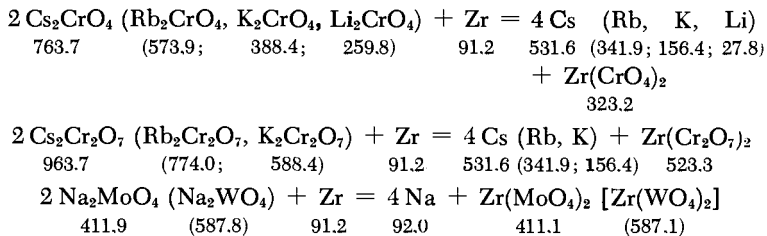

To prepare pure Cs, Rb or K, one part by weight of Cs_2CrO_4 (Rb_2CrO_4 or K_2CrO_4) is mixed with four parts by weight of fine Zr powder. The mixture is compressed into rods and heated in a highly evacuated, thoroughly preheated quartz tube (or other suitable apparatus).

The reactions start smoothly at 725°C (700 or 800°C). The heating is continued until a temperature of 1000°C is reached. The alkali metals form oxide-free shiny, mirrorlike deposits on the colder parts of the tube. Yields: Cs 90-96%; Rb practically quantitative; K up to 80%.

To prepare Li it is necessary to mix Li_2CrO_4 with eight parts by weight of Zr to prevent explosive reduction between 450 and 500°C. The yield of the metal is very low.

In cases where, for reasons associated with the limitations of equipment, the temperatures required for the preparation of pure Cs, Rb and K from chromates cannot be used, bichromate mixtures consisting of one part of $\text{Cs}_2\text{Cr}_2\text{O}_7$ ($\text{Rb}_2\text{Cr}_2\text{O}_7$, $\text{K}_2\text{Cr}_2\text{O}_7$) to ten parts of Zr must be used. A smooth reduction will start at about 380°C (370°, 380°C). The yield of Rb is 80-90%. It is free of oxide, as is the potassium formed in this reaction. The Cs product, however, contains some oxide, but, if the mixture ratio is changed to one part of $\text{Cs}_2\text{Cr}_2\text{O}_7$ to 20 parts of Zr, the Cs will be free of oxide.

To prepare pure Na it is best to replace the deliquescent chromate or bichromate by Na_2MoO_4 or Na_2WO_4 , which is mixed with four parts by weight of Zr powder. Evolution of sodium vapor begins smoothly at about 550° or 450°C, respectively. With Na_2MoO_4 the yield is practically quantitative, and with Na_2WO_4 it is 80%. The Na is free of oxide. For the preparation of Rb and Cs chromates or bichromates, see the section on chromium.

According to the following equations, Li_2CrO_4 is formed on boiling a solution of $(\text{NH}_4)_2\text{Cr}_2\text{O}_7$ with LiOH ; Na_2MoO_4 and Na_2WO_4 are obtained by the reaction Na_2CO_3 with MoO_3 , or WO_3 respectively.

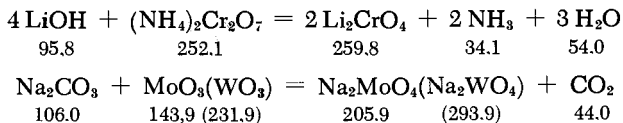

REFERENCES:

J. H. De Boer, J. Broos and H. Emmens, *Z. anorg. allg. Chem.* 191, 113 (1930).

ALKALI METALS OBTAINED BY DECOMPOSITION OF AZIDES

Suhrmann and Clusius succeeded in preparing very pure, gas-free alkali metals by thorough decomposition of their azides under high vacuum.

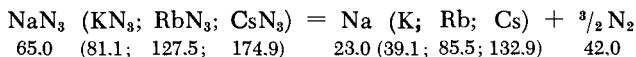

The equipment used (Fig. 261) must be Pyrex which is not seriously attacked by Na, K, Rb, Cs or Li.

When "physically pure" alkali metals are to be prepared, all the glass parts of the equipment are joined by fusion and there

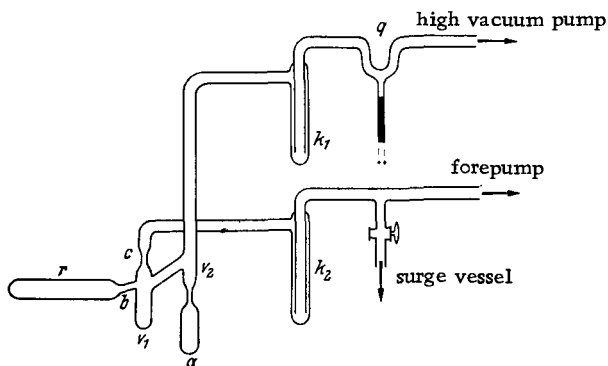

Fig. 261. Preparation of alkali metals from azides. *r*) Decomposition tube; *v*₁, *v*₂) receivers; *a*) ampoule for storing the metal; *b*, *c*) fused joints; *k*₁, *k*₂) cooling traps; *q*) mercury valve.

are no greased stopcocks in that part of the apparatus which is under vacuum. In other cases, where purity requirements are less vigorous, the use of ground joints and stopcocks is permissible. These, however, must not come in contact with the liquid alkali metal or its vapor.

The azides are finely pulverized in an agate mortar and placed in a retort r (amounts: 10–12 g. of NaN_3 or KN_3 , 6–7 g. of RbN_3 or CsN_3). The salt, which fills about one quarter of the retort, is then distributed over the entire tube. However, RbN_3 and CsN_3 are not placed directly in the retort. Instead, a quartz tube sealed at one end is filled with the salt and inserted into the retort. Next, r is sealed onto the rest of the apparatus and the latter is evacuated by means of a high-speed forepump. (In the original preparation, a mercury diffusion pump made of glass was used.) At the same time the apparatus is thoroughly heated to remove traces of gases. The cooling tubes k_1 and k_2 are kept immersed in liquid nitrogen until the end of the experiment. An electric heater is pushed over r and a temperature of 200°C is maintained for 12 hours, while the apparatus is continuously evacuated. A Geissler tube, connected to the apparatus as a vacuum gauge, must always show a high vacuum (ready discharge). Next, the furnace temperature is gradually raised and the mercury valve q is closed, to avoid entrainment of the azide by the free N_2 during the subsequent decomposition and its deposition in receiver v_2 . The decomposition temperatures of the azides are: NaN_3 , 275°C ; KN_3 , 355°C ; RbN_3 , 395°C (quartz tube); CsN_3 , 390°C (quartz tube). Decomposition of NaN_3 begins before the melting point is reached; KN_3 melts at 343°C , RbN_3 at 321°C , CsN_3 at 326°C . At the start of the decomposition, the temperature is adjusted in such a way that pressure in the apparatus is not above 0.1 mm. To prevent a sudden pressure rise, a surge vessel is connected to the apparatus via a stopcock. This is an eight-liter vessel, thoroughly evacuated by means of the forepump. To assure rapid pressure relief all tubing must be 12 to 16 mm. in diameter. The decomposition sometimes does not start until 3–4 hours after the proper temperature is reached (especially in the case of KN_3). The azides, should not be overheated because an explosive decomposition may occur and the apparatus destroyed.

The end of the decomposition is indicated by cessation of discharge of the Geissler tube (high vacuum). As the N_2 pressure decreases, the alkali metal formed is distilled from r into collector v_1 . The retort r is then sealed off at point b and the stopcock to the surge vessel is closed, while the forepump is still operating. The high-vacuum pump (in the original, a mercury diffusion pump made of glass) is then started and the mercury valve q is opened. Then the connection to the forepump is sealed off at c . The pressure in the apparatus is reduced to below 10^{-7} mm. Under these

conditions the alkali metal readily distills from v_1 to v_2 on slight heating with an electric heater. The metal in v_2 is then melted so that it flows into ampoule a , which is eventually sealed.

In more successful work the decomposition is completed in 3 to 4 days as described provided the pressure is not allowed to rise above 0.1 mm.; in less successful preparations it takes 6 to 8 days. The alkali metals thus obtained are completely free of gas, so that no pressure rise is observed on heating them under high vacuum.

The yield of these alkali metals is approximately 100% for NaN_3 , 80% for KN_3 , 60% for RbN_3 , and 90% for CsN_3 . The residue is light brown in the case of KN_3 , blue-green in the case of RbN_3 , and yellowish-gray in the case of CsN_3 . It consists of the nitride mixed with silicate and undecomposed azide.

REFERENCES:

R. Suhrmann and K. Clusius, *Z. anorg. allg. Chem.* **152**, 52 (1926).

RUBIDIUM AND CESIUM OBTAINED FROM THE CHLORIDES

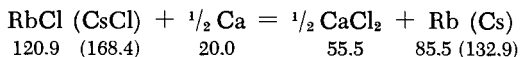

This method, proposed by Hackpill, uses the apparatus shown in Fig. 262. A weighed amount of RbCl (CsCl) is thoroughly pre-dried in an oven at about 150°C and mixed with the required amount of Ca turnings. An iron insert crucible b is filled with the mixture and stoppered with a plug c made of fine steel wool. A ratio of 10 g. of RbCl (15 g. of CsCl) to 8 g. of Ca has proven satisfactory. The apparatus (Fig. 262) with a reaction vessel 30-35 mm. in diameter, will hold a maximum of about 35 g. of RbCl (50 g. of CsCl), together with the appropriate amount of Ca .

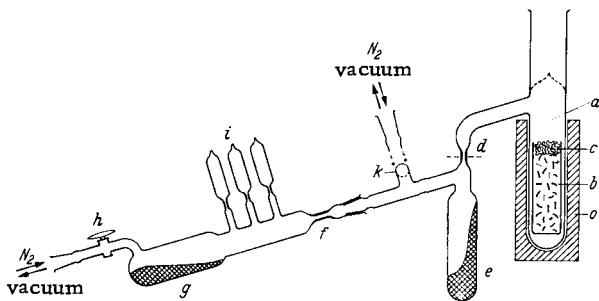

Fig. 262. Apparatus for preparation of metallic rubidium (or cesium) by reduction of the chloride with calcium.

After reaction vessel *a* has been opened, the filled crucible is placed in it and the vessel sealed directly above the side tube (dotted line in figure), leaving as little dead space as possible. The reaction vessel is placed inside the heater *o* and its top is wrapped as well as possible in asbestos wool, to prevent cold spots where later on the alkali metal vapor could condense. Heating under high vacuum is then started. The temperature is checked with a thermocouple, protected by a thin ceramic sheath and inserted between the vessel wall and the heater. The thermocouple sheath must not touch the vessel wall and is prevented from adhering to the latter by a few tufts of asbestos.

As the temperature rises to 250°C, large quantities of gases are released from the mixture. It is sometime before the vacuum pump is able to remove these. During this time all glass parts of the apparatus, are uniformly heated by fanning with a gas flame. After 2-3 hours, when the evolution of gas subsides, the temperature is raised further until all of the alkali metal slowly distills into receiver *e*. The distillation lasts 2-3 hours. Toward the end the temperature in the reaction vessel rises to about 650°C. The reactor is then disconnected from the remainder of the apparatus by melt-sealing constriction *d* while vacuum is maintained. This must be done before the heating is shut off, since vessel *a* is deformed by heat and will usually break on cooling.

The crude metal is distilled from collector *e*, using a tubular heater. The liquid metal runs through the ground joint and through constriction *f* into the second receiver *g*. (The ground joint should be carefully greased to prevent grease spillover into the passage.) The temperature in this vessel is considerably lower and the vacuum higher than in the first distillation stage. If very pure, the twice distilled metal will not wet the glass walls. Receiver *g* is finally sealed off under vacuum at constriction *f*. It thus becomes free and can be tipped in such a way that the metal, melted with low heat, will flow into ampoules *i* attached on the side. The number and size of these ampoules can be varied as desired. The liquid metal filling the ampoules will solidify more rapidly if externally cooled with a piece of Dry Ice. The ampoules are finally filled with very pure N₂ through stopcock *h* and sealed off at the constriction points in their connecting tubes. If the ampoules are weighed before and when filled, the weight of the contents can be determined to 0.01 g.

Somewhat larger quantities of alkali metal can be prepared in a stainless steel reactor (Fig. 263). A steel pipe *l* (inside diameter about 38 mm.), is filled with the reaction mixture *m*, covered with a steel wool plug *n* and closed with a heavy steel cap. The latter is sealed on with a lead gasket covered with a very thin copper foil sheath to protect it against corrosion by the alkali metal vapor. Just as in the case of the glass apparatus, the upper part

of the reactor (including the cap) must be thoroughly insulated. The metal vapor condenses in the water-cooled section of the side arm pipe. The cooling should not be too intensive and the liquid metal should be able to flow (without solidifying) into the next part of the apparatus via ground joint *p*. This remaining part of the apparatus is made of glass and, beginning with constriction *d*, is identical to that shown in Fig. 262.

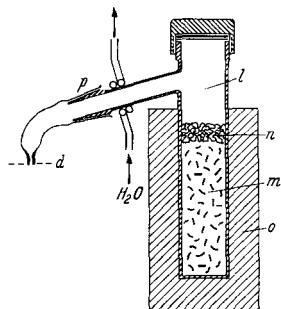

Fig. 263. Steel reactor for preparation of metallic rubidium (or cesium) by reduction of the chloride with calcium.

Such steel reactors allow processing 100 g. of RbCl, or 150 g. of CsCl in a single run. The yield of double-distilled metal is 90-98%.

REFERENCES:

- L. Hackspill, *Helv. chim. Acta* **11**, 1008 (1928).
 W. Biltz, F. Weibke and H. Eggers, *Z. anorg. allg. Chem* **219**, 119 (1934).
 G. Brauer, private communication.

PROPERTIES OF ALKALI METALS

	Atomic weight	M.p.°C	B.p.°C	d (18°C)	Hardness (mohs)
Li	6.940	179.0	1336	0.534	0.6
Na	22.997	97.8	883	0.97	0.4
K	39.096	63.5	762	0.86	0.5
Rb	85.48	39.0	696	1.52	0.3
Cs	132.91	28.6	670	1.89	0.2

Very soft. Fresh surface is silver-white. Highly reactive. Immediately form hydroxide-carbonate crusts in air, usually accompanied in the case of Cs, by ignition. Water and alcohol are decomposed with liberation of H₂. (Storage, see below.) A2 structure type.

PURIFICATION OF ALKALI METALS BY VACUUM DISTILLATION

(See also the introduction to the section on Preparation of Alkali Metals by Reduction with Zirconium.)

Fig. 264 shows Brauer's apparatus for distilling Cs and Rb. Ordinary chemical glassware may be used. (However, according to Hevesy and Lögstrup, distillation of potassium requires Pyrex apparatus.) Tube *B* is slightly inclined. The ampoules are

melt-sealed to *D* in such a way that they are horizontal during the early distillation stage. The apparatus is initially sealed off at

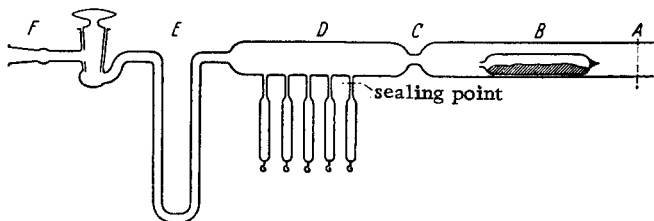

Fig. 264. Distillation of cesium (also rubidium, potassium, sodium). Scale 1:7. In the actual arrangement the ampoules, sealed to tube *D*, lie in a plane perpendicular to that of the drawing; hence, they remain horizontal during the distillation and do not become prematurely filled with liquid cesium. Tube *B* is likewise not quite coaxial with *D* but is inclined slightly downward.

point *A* and evacuated by means of a mercury diffusion pump connected to the ground glass joint *F*. The evacuation continues for several hours, during which all of the apparatus, from *A* to *E*, is dried by heating to 400–500°C. The system is then filled (through *F*) with pure dry N_2 . The tube end is broken off at *A* and a boat containing benzine-covered cesium is introduced into tube *B*. The metal should be free from any incrustations and washed in light benzine (mineral spirits). The cesium in the boat must at all times be protected either by the benzine layer or by a blanket of dry N_2 , or by both, as in the present example, where the benzine-covered metal is pushed into the tube from which a stream of N_2 is issuing. Following the insertion of the boat, the benzine is volatilized, *B* is resealed at *A*, and the apparatus is evacuated to at least 10^{-4} mm. Next, an electric oven is placed around *B*, reaching close to *C*, and the metal is heated until all of it distills into *D*. Simultaneously, the U tube *E* is cooled with liquid nitrogen or with Dry Ice-acetone mixture to keep Hg and oil vapor away from the metal. Where purity is not critical, the U tube can be dispensed with. Following the distillation, the molten metal in tube *D* can be distributed among the storage ampoules by rotation of the apparatus. After cooling, the apparatus is refilled with N_2 and the ampoules are sealed off.

If the metal must be distilled several times, several *B* tubes are sealed on to *D*.

The vacuum distillation of Li is carried out according to method of Remy-Genneté, using the same procedure as for Ca, Sr or Ba.

The apparatus in this case is a vertical tube. An iron crucible with the metal is inserted and the latter is allowed to distill from the crucible onto a cold finger hanging above. An apparatus of this type, improved by Ehrlich, is shown in Fig. 259 and is discussed under the distillation of Ca.

To prepurify the Li by removing the more volatile impurities, the first fraction is taken off by heating a fairly long time at a relatively low temperature. The apparatus is then cooled under vacuum and opened, and the first fraction of the metal is discarded. The actual distillation is then performed at a higher temperature. The charge should not be distilled to dryness. A residue of Li, containing high-boiling impurities, should be left behind in the crucible.

Lely and Hamburger describe a similar apparatus for the distillation of Na.

REFERENCES:

- G. Brauer, *Z. anorg. Chem.* **255**, 11 (1947).
P. Remy-Genneté, *Ann. Chim.* (10) **19**, 263 (1933).
P. Ehrlich, see the section on Alkaline Earth Metals, Ca.
D. Lely, Jr., and L. Hamburger, *Z. anorg. Chem.* **87**, 209 (1914).
G. von Hevesy and M. Lögstrup, *Z. anorg. allg. Chem.* **171**, 3 (1928).

STORAGE AND HANDLING OF ALKALI METALS BEFORE USE

Lithium is stored in tightly closed vessels, completely filled with petroleum ether. Sodium is usually stored under kerosene. To clean the surface before use, the metal pieces are dried with filter paper, treated with absolute alcohol, and washed with pure petroleum ether. Potassium is usually also stored under kerosene. According to Wislicenus, Elvert and Kurtz, rolling potassium shot around under ether containing a few drops of alcohol will remove the brown crust from the surface. Rubidium and cesium are generally stored under paraffin oil, since they react rapidly under kerosene. Before use these metals are washed with petroleum ether or benzene, thoroughly predried with Na, to remove the oil. The solvents are evaporated in a current of dry CO₂ or removed under vacuum.

To remove oxide-hydroxide-carbonate crusts from Na and K, the following simple treatment has been suggested by Bornemann: a clean wire screen with 1-mm. openings, is inserted into a melting tube 50 cm. long and 15-20 mm. in diameter. The tube is sealed at one end and constricted in the middle to a diameter of 3-4 mm. The constricted section should be very short. The screen is bent to a hemispherical shape so that it fits snugly in the tube. It is pushed down the tube until it reaches the constriction. The tube

above the screen is half filled with freshly cleaned, well-dried pieces of Na or K. The tube is then sealed at a point about 20 cm. above the constriction. Over several hours the metal will have absorbed all the H_2O , O_2 and CO_2 from the air in the tube and will thus be essentially under an N_2 blanket. To check this, the metal is melted and left to resolidify, while the tube is horizontal (so that the metal will not run through the sieve). This procedure is repeated until the bright metal surface ceases to dull, even after a considerable time, indicating that the last traces of O_2 have been absorbed. The tube is then set vertically and its lower end heated to a temperature above the melting point of the metal so that the latter slowly melts. It gradually runs through the sieve, while the oxide, hydroxide and carbonate are left behind. Should the constriction become plugged, this spot is not heated. Instead, the flow is helped along by lightly tapping the tube against a soft support. At the end of filtration the metal is sealed in lower part of the tube by melting the constriction. No metal vapors must be allowed to form during sealing since they might attack the glass as well as cause pressure inside the tube.

A hopper designed by Zintl, Goubeau and Dullenkopf (Fig. 265) is used to fill small thin-walled glass spheres with high-purity Na (or K, etc.). The sphere is placed in the hopper and predried under vacuum for a long time. It is next weighed, together with its long, narrow capillary. Finally, it is put back into the hopper, with the capillary opening directed downward, as shown in the figure. The hopper is evacuated via ground joint adapter *a*. This takes a long time and high vacuum must be used. Simultaneously with the evacuation, the lower half of the hopper is heated to about $200^\circ C$ on an oil bath to remove the water film lining the inner wall surface of the sphere. After cooling, pure dry N_2 is allowed to flow through *a*, the ground cap *b* is lifted momentarily, and a compact chunk of distilled Na (or K, etc.) is quickly inserted and placed as indicated in the figure. The metal should be as free from oxide as possible. The evacuation is immediately repeated. After a while, the heating on the oil bath is resumed in order to slowly melt the metal. Bright metal flows into the attached bulb *c* leaving behind all of the oxide in the form of a continuous film. Enough pure N_2 is then carefully let in to force the liquid metal into the sphere *k* so that its lower half is filled. Next, sufficient N_2 is pumped out to siphon the metal back into the capillary

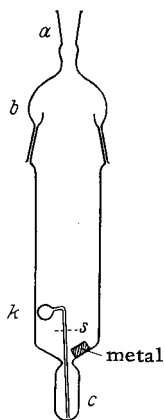

Fig. 265. Filling of glass spheres with oxide-free alkali metal.

down to level *s*, thus forming a discontinuity. The metal will be retained in the sphere only if the latter has been thoroughly pre-dried or it will empty as the *N* is pumped out. The metal is cooled until solid and the *N* pressure in the hopper is raised to 1 atm. The cap *b* is then removed and bulb *c* is immersed in a warm bath. As soon as the metal in *c* has melted, the sphere is withdrawn with glass hooks. This is done rapidly, while the capillary is still plugged with solid material. The capillary is then melt-sealed at the metal-free discontinuity close to the sphere. The filled sphere is weighed together with the cleaned capillary.

Sodium residues, which are still usable, are melted under toluene or xylene. Small amounts of residual sodium are rendered unreactive by being placed in portions in alcohol containing only a small amount of water.

REFERENCES:

- W. Wislicenus, H. Elvert and P. Kurtz, Ber. dtsch. chem. Ges. 46, 3398 (1913).
G. Bornemann, Angew. Chem. 35, 227 (1922).
E. Zintl, J. Goubeau and W. Düllenkopf, Z. phys. Chem. A 154, 21 (1931).

SODIUM DISPERSIONS IN INERT LIQUIDS

Dispersions of molten Na (d. at 100°C, 0.928) in inert liquids containing about 50% metallic Na (particle size 1-20 millimicrons) can be prepared in the laboratory by mechanical dispersion. The boiling point of the inert liquid must be higher than the melting point of Na (97.5°C). Such liquids include toluene, xylene, some light mineral spirits, kerosene, heptane, n-octane, mineral oil, and naphthalene. Appropriate agents (0.25-1%) contribute to the reduction of particle size (soot, copper powder, pyridine, etc.) or stabilize the dispersion (oleic acid, aluminum stearate, calcium stearate, etc.).

The usual safety devices generally employed in working with Na and with flammable solvents (such as goggles, safety shields, gloves, purged and sealed heaters, etc.) must be used in the preparation of N_2 dispersions. In case of fire, the burning Na should be covered with dry soda. Carbon tetrachloride extinguishers should not be used. Carbon dioxide extinguishers may be used in fighting solvent fires.

Disk-shaped stirrers with beveled teeth* (see Fig. 266c) as well as turbine-type agitators** which entrain the liquid along the

*Manufactured by Cowles Dissolver Co., Cayuga, N.Y., and others.

**Manufactured by Premier Mill Corp., Geneva, N.Y., and others.

axis and eject it centrifugally through narrow slots (Fig. 266*p*) are effective devices for dispersing Na.

The U.S. Industrial Chemicals Co. has suggested using a two-liter vessel, (diameter about 15 cm.) with a disk stirrer about 7.5 cm. in diameter, rotating at 4000-6000 r.p.m. (see Fig. 266). With an agitator diameter of 2.5 cm. and a speed of 8000-15,000 r.p.m., a half- to three-liter flask is recommended.

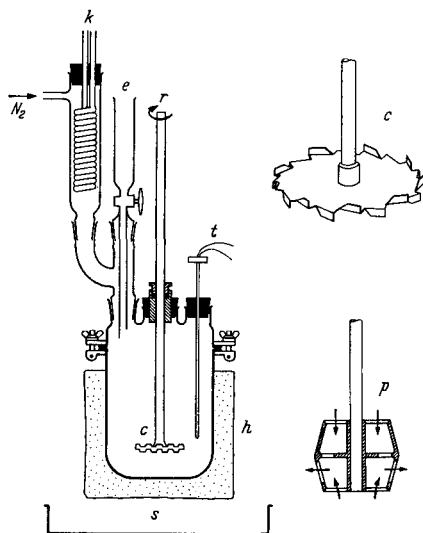

Fig. 266. Vessel and stirrers for Na dispersion in inert liquids.

A cleaned and dried apparatus is charged with 400 g. of dry dispersing medium and the substance selected as a dispersion aid is added to the latter with slow stirring. The air is displaced with nitrogen, the stirring is stopped, and 400 g. of bright Na shavings is introduced into the apparatus. The apparatus is then again flushed with N_2 . All of the Na melts on heating to $105^\circ C$, and the stirrer is restarted and brought slowly to top speed.

As the particle size decreases, the mixture turns a deeper shade of gray. In most cases, the particle size drops to 10-15 microns within 10-15 min. If the particles still appear too large when examined under a microscope, the stirring is continued for another five minutes. The dispersion is then left to cool to or below $80^\circ C$ without any stirring. The stirring can be resumed below $80^\circ C$ since the particles will not recombine. When the dispersion is at room temperature it may be poured into dry storage vessels.

Sodium dispersions should be stored in tightly closed vessels under a nitrogen blanket. Air or moisture destroy the dispersion and may easily cause a fire. For safety the glass storage vessels should be placed inside a protective vessel and embedded in diatomaceous earth. Iron vessels are also worth considering as storage containers. Storage vessels must be free of Na traces both on the outside and in the area of the stopper. Filter paper used to remove the sodium remnants must be well impregnated with kerosene. Dry paper, linen and the like ignite as soon as they come in contact with Na dispersions.

Where less concentrated dispersions are used, it is best to dilute the stock just before use. The dilution fluid should have a boiling point below the melting point of Na.

After emptying the apparatus the reactor is first rinsed with kerosene and then treated with water vapor (which must be free of liquid water) to react the last traces of Na.

REFERENCES:

- Sodium Dispersions, U.S. Industrial Chemical Co., 1957.
V. L. Hansley, U.S. Patents 2,394,608 (1946) and 2,487,334 (1949).

FINELY SUBDIVIDED SODIUM ADSORBED ON INERT SOLIDS

Molten Na spreads spontaneously on the surface of inert solids at 100 to 200°C in a N_2 atmosphere; monatomic sodium layers can thus be achieved. Suitable solid substances are NaCl, Na_2CO_3 , carbon (charcoal), metal powders, Al_2O_3 and SiC. In some cases the reaction products prepared with the aid of finely subdivided metallic Na themselves prove to be effective carriers. Carrier materials consisting of fine particles coated with metallic Na remain free flowing over a wide range of temperatures and concentrations. Depending on its grain size, common salt will adsorb 2-10% Na. Soda adsorbs 10% Na, aluminum oxide 20-25%, activated carbon 30%. These substances remain free flowing up to the melting point of Na. At high Na contents, the materials convert to pastes.

The table below gives the optimum dispersing temperatures, the contents of finely subdivided Na and the appearance of the mixtures with some carrier materials.

According to a laboratory manual published by the National Distillers Chemical Co. a well-dried three-necked Pyrex flask, capacity 1-3 liters, may be used as the reactor (see Fig. 267). A stirrer with a graphite-packed gland is inserted through the middle neck. The other two necks serve for filling and temperature measurement.

Carrier material	Optimal dispersing temperature, C	Sodium content, %	Appearance
Activated alumina	140-160	20-25	black
Activated coconut charcoal	120	>35	silver to black (pyrophoric)
Iron powder (150 μ)	150-200	5	gray
Colloidal carbon	170	>30	black (pyrophoric)
Common salt (180-420 μ)	150	2-10	gray to black
White sand (420-840 μ)	150-165	5	gray
Calc. soda (50-150 μ)	150	10	gray to black
Zirconium oxide (50 μ)	250	10	dark gray

A tube on each neck serves as the inlet and outlet for the nitrogen. The flask is heated by means of a tightly fitting electrical heating mantle. A dish is placed below the apparatus as a safety pan in case of breakage. An oil bath may also be used for heating. The same safety measures as those mentioned in the preceding section must be observed.

The flask is charged with, for example, 300 g. of dried, calcined sodium carbonate and the air is displaced with dry N_2 . By stirring at 100-300 r.p.m., the soda is whipped to about twice the original volume, while it is heated to 150°C. Then 10 g. of Na (in pieces weighing 2-5 g.) is added through the filling neck. As soon as the Na melts the stirring is accelerated and the high speed is maintained for about five minutes. As the Na distributes over soda, the latter changes from white to gray.

Wherever possible, finely subdivided Na is used directly following its preparation, and the reaction for which it is intended is carried out in the same vessel in which the Na dispersion has been prepared. If, however, the dispersion must be stored in another container for future use, the transfer should be done under N_2 , after precooling of the apparatus in a nitrogen stream. Well-dried metal storage containers should be used for this purpose. They must be kept in a dry place and away from flammable materials.

To decompose Na finely dispersed on solid materials, it is burned in some safe spot, inside an open iron vessel. If necessary, a little kerosene may be added beforehand to produce complete combustion. Small residues of fine Na remaining in the reaction vessel are reacted with dry steam (or rapid stream—use a protective shield) in the reactor previously flushed and filled with N_2 .

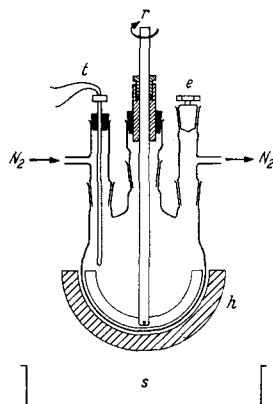

Fig. 267. Apparatus for dispersion of sodium on inert solids.

REFERENCES:

High Surface Sodium, National Distillers Chemical Co., Ashtabula (Ohio) 1953.

Alkali Hydrides

NaH, KH, RbH, CsH and LiH

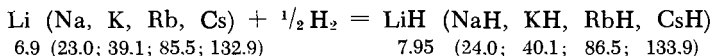

NaH, KH, RbH, CsH

The hydrogenation apparatus shown in Fig. 268 is designed to prepare NaH, KH, RbH and CsH following the procedure of Zintl and Harder. A seamless steel liner tube a is inserted into a quartz or Vycor tube r as protection against corrosion by alkali metal vapors. Liner a is preheated for many hours in moist H_2 at 900°C to decarbonize the steel. An iron boat c is placed in sheet iron cylinder b , which is closed on one side. After prolonged evacuation of the apparatus the surfaces of a , b and c are deoxidized by passage of electrolytic H_2 (inlet at h and outlet at the loosely fitting joint s_1) and simultaneous prolonged heating of a , b and c to dull red heat, using an electric oven.

The electrolytic H_2 must be very thoroughly freed of O_2 and H_2O and before entering the reaction zone must pass through a large U tube filled with resublimed P_2O_5 .

Sodium (or potassium) must be freed from adhering high-boiling hydrocarbons prior to use. To this end, they are remelted repeatedly under xylene and, when as oxide-free as possible, are placed in boat c .

Rubidium and cesium can be prepared in the reactor itself (see section on Alkali Metals Obtained by Reduction with Zirconium, p.957). In this procedure, the boat is charged with a mixture of Rb_2CO_3 or Cs_2CO_3 and magnesium powder, using a mole ratio of 1:3 (weight ratios are 231.0:73.0 or 325.8:73.0, respectively). The mixture is predried under vacuum at 150°C . The apparatus is evacuated and cylinder b with boat c are slowly heated. In the case of Na and K, the temperature is raised to $300\text{--}350^\circ\text{C}$ (at which temperature the metals distill). In the case of Rb and Cs, the temperature is 620°C . The alkali metals condense inside the steel liner at a . After cooling, tube b with boat c containing impurities and/or residues are pulled out from the reaction zone (still under a H_2 stream) through ground glass joints s_2 . With manometric valve v reconnected, the air is displaced with

H_2 and the alkali metal is slowly evaporated by heating at 300–400°C and 1 atm. in a stationary hydrogen atmosphere. The hydride formed under these conditions is deposited on both sides outside the heated zone, mostly in the form of cottonlike clusters of colorless, crystalline needles. If the evaporation of the metal is too rapid, the hydride becomes contaminated with condensed metal. From time to time the tube is refilled with H_2 to keep the pressure at 1 atm. When the manometric valve v shows no further pressure drop over a period of 24 hours, the hydride is removed (under a hydrogen stream) from a by pushing it into tube d with a small Pt scoop sealed onto a long glass reaction rod and introduced through s_1 . Tube r is then removed and s_3 is closed off. The hydride can then be transferred to other containers by opening s_4 , under a stream of H_2 .

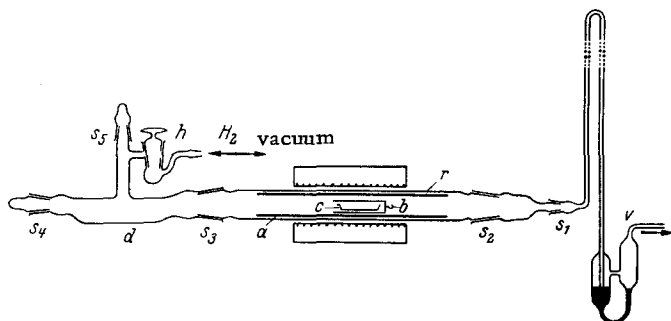

Fig. 268. Preparation of alkali metal hydrides; r) quartz or Vycor reaction tube; a) protective iron liner; b) boat-shielding iron cylinder; c) iron boat.

A finely subdivided NaH suspension may be prepared following a procedure suggested by Ziegler, Gellert, Martin, Nagel and Schneider.

Metallic Na and a dispersing medium are heated at 200–220°C with brisk stirring, using an autoclave provided with a magnetic stirrer (rotary and rocking autoclaves are less suitable). At the same time, electrolytic H_2 is forced in from a steel cylinder or with a compressor. Hydrogenation takes place at all pressures. The higher pressure level is important only insofar as it determines the rate of H_2 uptake.

For each liter of reaction volume, 500 ml. of dispersing agent and 75 g. of Na are used. Suitable dispersing media include hexane, heptane, octane (alone or in mixtures), cyclohexane, methylcyclohexane and ethylcyclohexane. It is best to use a dispersing medium with a critical temperature above 200°C. Aromatic media cannot be used since NaH is a very active hydrogenation catalyst

at high temperatures, and thus H_2 would be lost through hydrogenation of the dispersing medium.

When the H_2 uptake ceases, the coarse-grained suspension of NaH may be removed from the autoclave. If the suspension is then ground in a ball mill, its color changes sharply from white to gray-black. The reason for this is that the residual metallic Na in the product becomes finely subdivided. In such cases, the hydrogenation must be repeated, as above. The final pure white suspension will retain its color even after wet grinding. If, following the first hydrogenation, the heating is continued for 2-3 hours at 280-300°C under compressed H_2 , the suspension will remain white even upon first wet grinding. Repeated hydrogenation for such material is superfluous.

LiH

Zintl and Harder prepared LiH in a boat made of electrolytic iron and charged with shiny Li under Ar. Since molten Li diffuses through iron, a second electrolytic iron liner is inserted into steel tube a . The hydrogenation proceeds rapidly at 600°C and is complete at 700°C. At this temperature, the LiH product is liquid (m.p. 680°C). On cooling, it becomes coarsely crystalline and appears completely colorless and transparent. The boat is pushed into tube d with a long rod (see above) and ground joint s_1 is shut. A rotary steel milling cutter, about 5 mm. in diameter (see section on Intermetallic Compounds), is then inserted at s_5 in order to pulverize the hydride. A bulge in the lower half of tube d provides the necessary support for the boat during this operation.

Following the Albert and Mahé procedure, LiH is prepared in quantities of 1 kg. in a low-carbon steel pot, externally protected from scaling with an aluminized steel jacket. The upper part of the pot and its flat, rubber-gasketed lid are water cooled. The lid has nozzles for H_2 input, a vacuum connection, and a thermocouple. Two concentric cylindrical "Armco" iron crucibles are placed inside the pot. These fit snugly inside each other and in the pot.

For 1 kg. of LiH (about 890 g. of Li) the innermost crucible should measure 125 mm. in diameter, 350 mm. in height and have walls 2 mm. thick.

The Li is introduced, and the apparatus is evacuated, filled with H_2 and heated. Hydrogen uptake starts at 500°C and becomes vigorous at 650°C. A steady pressure of 0.25 atm. gauge is maintained; heating above 700°C must be avoided. The reaction time is about three hours. After the complete cooling, the LiH is taken out under a blanket of CO_2 to prevent spontaneous ignition of readily oxidizable sublimates which deposit on the cold parts of the apparatus.

The entire operation lasts about eight hours and yields well-crystallized, hard LiH about 99.6% pure. It is bluish in spots due to contamination with a slight excess of Li.

PROPERTIES:

Colorless substances, decomposed by moisture. Stability to O₂ decreases sharply from LiH to CsH: LiH reacts only at red heat; NaH ignites in O₂ at about 230°C; KH, RbH and CsH react at room temperature. Equilibrium hydrogen pressure for LiH is 0.023 mm. at 23.5° and 70 mm. at 640°C (m.p. 680°C). Vacuum sublimation at 220°C results in partial decomposition. Equilibrium H₂ pressure for NaH is 8.0 mm. at 300°C; for KH, 7.3 mm. at 300°C; for RbH, about 100 mm. at 370°C; for CsH, 0.3 mm. at 200°C and 27.8 mm. at 300°C. d. (x-ray) for LiH to CsH: 0.77; 1.36; 1.43; 2.59; 3.41. Crystal structure B1 type.

REFERENCES:

- E. Zintl and A. Harder, *Z. phys. Chem. (B)* 14, 265 (1931); see E. Zintl, A. Harder and S. Neumayr, *Z. phys. Chem. (A)* 154, 92 (1931).
 K. Ziegler, H. G. Gellert, H. Martin, K. Nagel and J. Schneider, *Liebigs Ann. Chem.* 589, 91 (1954).
 P. Albert and I. Mahé, *Bull. Soc. Chim. France* [5] 17, 1165 (1950).
 G. F. Hüttig and A. Krajewski, *Z. anorg. allg. Chem.* 141, 133 (1924).
 F. Ephraim and E. Michel, *Helv. Chim. Acta* 4, 724, 900 (1921).

Alkali Metal Oxides



LITHIUM OXIDE

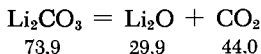

Zintl, Harder and Dauth prepared Li₂O by thermal decomposition of pure Li₂CO₃. Pure lithium carbonate (for purification see p. 987) is decomposed in a Pt boat set inside a porcelain tube which is connected to a mercury diffusion pump. Gas evolution ceases after heating for 50 hours at 700°C, as indicated by a McLeod gauge. The boat then contains pure white oxide, the composition of which can be checked by titration of samples.

For preparation of Li_2O from Li_2O_2 , see under Li_2O_2 (p. 979).

PROPERTIES:

More stable than the other alkali oxides; begins to sublime below 1000°C . M.p. above 1625°C . Reaction with water less vigorous. d. (x-ray) 2.00. C1 structure type, (Fluorite).

REFERENCES:

E. Zintl, A. Harder and B. Dauth, *Z. Elektrochem.* **40**, 588 (1934).

SODIUM OXIDE

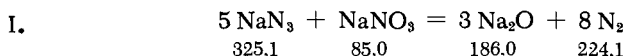

Direct oxidation of Na cannot be used to prepare pure Na_2O , since the simultaneously formed peroxide is reduced only with great difficulty to Na_2O by the excess Na. Zintl and Von Baumbach give the following directions for the preparation of pure Na_2O .

A nickel boat *s* (Fig. 269), lined with pure sodium azide, is charged with a finely powdered mixture of NaNO_3 (purified by recrystallization and dried at 200°C) and about 5.5 times (by weight) as much NaN_3 . The boat is placed in a Pyrex tube *a* and slowly heated by means of an electric furnace to 200°C in vacuum (Hg diffusion pump). When the reagents have thus been freed of moisture, the temperature is slowly raised to $270\text{--}290^\circ\text{C}$. (An explosion may occur on too rapid heating). The azide decomposes, imparting a dark gray color to the salt mixture. The stopcock

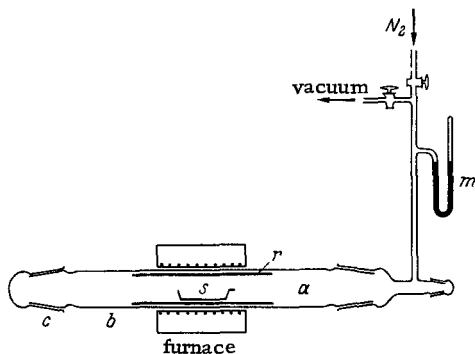
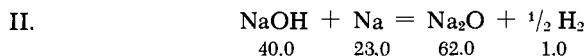

Fig. 269. Preparation of sodium oxide; *a*) Pyrex tube; *r*) nickel tube; *s*) nickel boat.

leading to the pump is occasionally closed so that the course of the reaction can be followed by means of manometer *m*. The brown color (nitride formation) disappears with rising temperature. When N₂ evolution decreases, the temperature is raised to 350°C. Finally, the excess Na is distilled off in vacuum at 350–400°C. The Ni tube *r* protects the Pyrex from corrosion by Na vapor. Before cooling, the Na mirror is removed from the lower half of tube *b* by heating with a flame. Thus, no sodium should adhere to the boat as it is withdrawn from the tube. While the Na is being removed from the tube, the furnace must be left on to prevent Na condensation on top of the Na₂O in the boat. The boat containing the preparation is then pulled out through ground joint *c*, making sure that air is completely excluded. It takes 3 to 5 hours to prepare 0.3–0.5 g. of Na₂O. The yield is quantitative, based on NaNO₃.



This method, according to Klemenc, Ofner and Wirth, enables the preparation of up to 8 g. of Na₂O in a single batch. A nickel crucible is placed in a Pyrex tube, closed off at the bottom and connected at the top to a vacuum line and a long-stem manometer. A mixture of NaOH granules and small Na pieces is used. Because NaOH generally contains a few percent of water, a correspondingly larger quantity of Na must be weighed out. Reaction begins at 300–320°C and the H₂ formed is continuously pumped out, maintaining the pressure at 30–40 mm. Finally, the slight excess of Na is distilled off under high vacuum. The product should be pure white. Its average composition is 96% Na₂O, 2% NaOH, 2% Na₂CO₃. It is best stored under anhydrous benzene.

PROPERTIES:

Fine, white powder. *d.* (x-ray) 2.39. CaF₂ lattice (C1). For corrosion resistance of various crucible materials to molten Na₂O and Na₂O₂, see E. G. Bunzel and E. J. Kohlmeyer, *Z. anorg. Chem.* **54**, 4 (1947). According to this reference, Al₂O₃ and NiO are relatively corrosion-resistant pure oxides.

REFERENCES:

- I. E. Zintl and H. H. von Baumbach, *Z. anorg. allg. Chem.* **198**, 88 (1931).
- II. A. Klemenc, G. Ofner and H. Wirth, *Z. anorg. allg. Chem.* **265**, 221 (1951).

POTASSIUM OXIDE

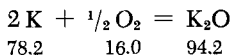

According to Zintl, Harder and Dauth, K_2O is best prepared in the following way. Metallic K is repeatedly remelted under xylene to remove high-boiling oils. It is next degassed by double distillation in a Pyrex tube connected to a vacuum pump and finally filtered under high vacuum through a capillary into a Vycor boat. Thoroughly purified dry air is admitted in small quantities to the mildly heated bright metal. The oxide as finely divided particles absorbs the unreacted metal, liquefied by the heat of reaction, like a sponge. A mass having a mosslike structure and a metallic sheen is obtained. Only a portion of the K is thus oxidized at one time (to prevent peroxide formation). The excess metal is distilled off in high vacuum at 350°C . The K_2O which remains in the boat is free of peroxide and is at least 99.5% pure.

PROPERTIES:

Loose powder, yellow when hot but white at room temperature. Deliquescent in air. Reacts vigorously with H_2O . At $350\text{--}400^\circ\text{C}$ disproportionates into $\text{K}_2\text{O}_2 + \text{K}$. d. (x-ray) 2.33. CaF_2 lattice (C1).

REFERENCES:

E. Zintl, A. Harder and B. Dauth, *Z. Elektrochem.* 40, 588 (1934).
E. Rengade, *Comptes Rendus Hebd. Seances Acad. Sci* 144, 754 (1907).

RUBIDIUM OXIDE

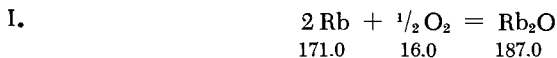

According to Helms and Klem, Rb_2O is prepared by the same method as K_2O . The metal is reacted in a glass apparatus with a quantity of O_2 insufficient to prevent peroxide formation. The excess metal is then distilled off.

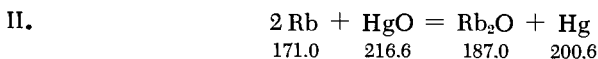

Another way to prepare Rb_2O is to react the metal with less than the stoichiometric quantity of HgO . The metal vapor must be distilled into the HgO in small portions to reduce the intensity of the reaction. After the preparation has been held 12 hours at 200°C ,

the excess Rb and the Hg formed in the reaction are distilled off in high vacuum at about 200°C. The Rb₂O remains.

PROPERTIES:

Colorless powder at room temperature, yellow when heated. Decomposed by light, turning dark. Vigorous reaction with H₂O. Above 400°C disproportionates into Rb₂O₂ + Rb. d. (x-ray) 3.72. CaF₂ lattice (C1).

REFERENCES:

A. Helms and W. Klemm, Z. anorg. allg. Chem. 242, 33 (1939).
E. Rengade, Compt. Rend. Hebd. Séances Acad. Sci. 144, 754 (1907).

CESIUM OXIDE

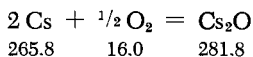

According to Helms and Klemm, the reaction of Cs with HgO cannot be used to prepare pure Cs₂O. Instead, in a procedure identical to that described for K₂O and Rb₂O, metallic Cs is incompletely oxidized and the excess metal is distilled away in high vacuum at 200°C. Care must be taken that no cesium diffuses back into the Cs₂O during cooling.

Brauer has described an apparatus for the preparation of Cs₂O, shown in Fig. 270. Boat *a* is shaped like a slipper so that it is able to contain liquid Cs in both vertical and horizontal positions. A nitrogen stream is passed through the horizontal reactor tube, which is open at the ground glass joint. A weighed ampoule, fastened to a wire and filled with pure Cs, is inserted into the reactor tube as shown. Prior to its insertion, the pointed end of the ampoule is scratched a little and tapped with a hot glass rod, so that it may be broken off later on. After insertion, the point is broken off, with the ampoule at *H* and under a N₂ blanket. The broken off piece of glass is removed. The tube is then set vertically, the ampoule suspended inside, and a ground cap put on. Next the tube is evacuated and the Cs is transferred into the boat by careful melting. After cooling, the empty ampoule is pulled out (still under a stream of N₂) and reweighed. Electrolytic O₂ is measured out by means of a glass burette (using Hg as the sealing

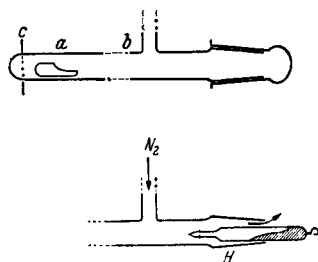

Fig. 270. Preparation of cesium oxide.

is inserted into the reactor tube as shown. Prior to its insertion, the pointed end of the ampoule is scratched a little and tapped with a hot glass rod, so that it may be broken off later on. After insertion, the point is broken off, with the ampoule at *H* and under a N₂ blanket. The broken off piece of glass is removed. The tube is then set vertically, the ampoule suspended inside, and a ground cap put on. Next the tube is evacuated and the Cs is transferred into the boat by careful melting. After cooling, the empty ampoule is pulled out (still under a stream of N₂) and reweighed. Electrolytic O₂ is measured out by means of a glass burette (using Hg as the sealing

liquid), the amount introduced being insufficient for complete oxidation of the Cs to Cs_2O . The oxygen is added to the reaction tube through a short capillary tube, which had been thoroughly evacuated during the evacuation of the main reactor tube. On its way from the burette to the reactor, the oxygen passes through a small U tube, cooled to a low temperature in order to condense the Hg and H_2O . Before entering the burette, the O_2 is purified by passing through a cotton filter, a layer of palladium asbestos heated to 400°C , and a low-temperature trap.

The oxidation begins as soon as O_2 reaches the Cs. To avoid an excessively vigorous reaction, the tube is cooled and the O_2 is admitted in small portions. The product develops a brown-black color, and then becomes liquid, but resolidifies as the oxidation proceeds. To keep it liquid, which ensures a more thorough reaction, the cooling is stopped. When conditions warrant it, some heat is applied, but care must be taken to prevent the Cs from evaporating. Finally, the excess Cs is slowly distilled off, with the tube in the horizontal position and the furnace over the tube. The Cs is allowed to condense in portion *b* of the tube, which is enclosed in a cardboard box filled with solid CO_2 . After the bottom end of the tube is broken off at *c*, the boat containing the pure Cs_2O is transferred to another vessel under a blanket of nitrogen.

PROPERTIES:

Orange, but dark in transmitted light. Habit: according to Helms and Klemm, matted needles; according to Brauer, soft laminae cleaved along the base. *d.* (x-ray) 4.68. Probably has a CdI_2 lattice (C6). M.p. (dec.) about 490°C . Deliquescent in air. Vigorous reaction with water (ignites), less violent with alcohol.

REFERENCES:

- A. Helms and W. Klemm, *Z. anorg. allg. Chem.* 242, 33 (1939).
 G. Brauer, *Z. anorg. Chem.* 255, 119 (1947).
 E. Rengade, *Compt. Rend. Hebd. Séances Acad. Sci.* 144, 753 (1907);
Ann. Chim. Phys. [8] 11, 384, 388 (1907).

Lithium and Sodium Peroxides



LITHIUM PEROXIDE

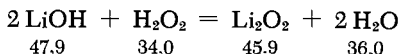

According to Pierron, Li_2O_2 is prepared by treating a boiling, saturated solution of LiOH in 95% alcohol with the stoichiometric

quantity of Perhydrol. The solution is decanted from the precipitate. The latter is boiled twice (30 minutes each time) in 95% alcohol, separated, and then dried overnight in vacuum over P_2O_5 . The product contains 99.4% Li_2O_2 . Starting with 10 g. of $LiOH$, 5-6 g. of Li_2O_2 is obtained. The Li in the alcoholic mother liquor can, however, be reused.

Very pure Li_2O_2 can easily be obtained from Li_2O_2 , which can initially contain Li_2O for this purpose, by heating in a glass tube at $300^\circ C$ in vacuum. Pure Li_2O forms in theoretical amounts as a perfectly white powder.

PROPERTIES:

d. 2.14. Structure: probably similar to $Hg(I)$ halides ($D3_1$ type).

SODIUM PEROXIDE

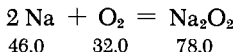

In preparing Na_2O_2 it is advantageous to oxidize metallic Na to Na_2O in an atmosphere containing less O_2 than air. The Na_2O is then oxidized completely to Na_2O_2 in an atmosphere containing more O_2 than air, at temperatures ranging from 200 to $350^\circ C$. If the Na_2O is ground before the second oxidation step (to facilitate the reaction), air moisture must be excluded during grinding and reaction.

PROPERTIES:

Yellowish. M.p. $460^\circ C$ (does not decompose). Forms H_2O_2 with H_2O . At red heat decomposes, evolving O_2 . d. 2.47. Structure probably similar to $Hg(I)$ halides ($D3_1$ type).

REFERENCES:

- P. Pierron, Bull. Soc. Chim. France (5) 6, 235 (1939).
 F. Fehér, Angew. Chem. 51, 497 (1938).
 Roessler and Hasslacher Chem. Co., British patent 264,724 (1926).

Alkali Dioxides

NaO_2

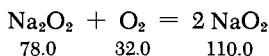

In the method of Stephanou, Schlechter, Argersinger and Kleinberg, 92% pure Na_2O is prepared by the action of O_2 on Na_2O_2 at

$\sim 500^\circ\text{C}$ and 300 atm. A high-grade steel bomb (180-ml. capacity) provided with a thermocouple is connected through a needle valve to a vacuum pump and an oxygen cylinder. A weighed amount (about 10 g.) of very pure Na_2O_2 , free from carbonate, is placed in an open Pyrex vessel and introduced into the bomb. After evacuating for several hours at 1-3 mm., enough O_2 is pumped to raise the initial pressure in the bomb to about 300 atm. when the latter is heated to 500°C . The valve is then closed. When no further pressure drop is noted, indicating that the reaction has been completed (in 100 hours, at the most), the bomb is left to cool. The fused product is readily powdered in the absence of moisture.

KO_2 , RbO_2 and CsO_2

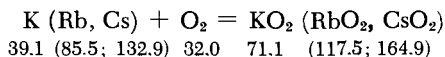

According to Klemm and Sodomann, as well as Helms and Klemm, the best method for preparing KO_2 , RbO_2 and CsO_2 is by oxidation of the elements, dissolved in liquid NH_3 , with O_2 at -30 to -50°C . Intermediate products appear first. Their color is light yellow when fresh, then dark. Finally, yellow dioxides are formed. To prevent an explosion, which is common in this reaction, Lux and Kuhn suggest the following procedure, using K_2O as an example.

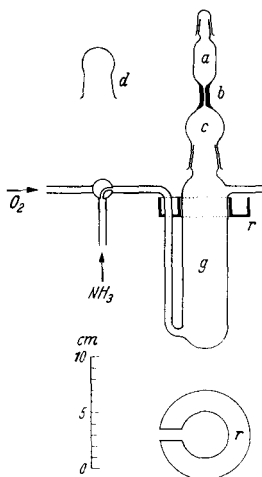

Fig. 271. Reaction vessel for preparing alkali dioxides by oxidation with O_2 of alkali metals dissolved in liquid NH_3 .

Ammonia gas, predried with KOH , is first passed for 2-3 hours through reaction vessel g (Fig. 271) until all of the O_2 is displaced. An acetone-Dry Ice bath (about -50°C) is then placed under the vessel. The circular copper channel r is fitted tightly around the upper third of g . It is filled with an acetone-Dry Ice mixture at -70 to -80°C . As soon as the lower third of reaction vessel g is filled with liquid NH_3 , a piece of potassium is placed in the adapter a and carefully melted by electrical heating. The reasonably pure metal trickles through capillary b (diameter about 1 mm.) into the liquid NH_3 . Spattered K , which might easily cause an explosion, is completely washed off the walls by refluxing NH_3 , using channel r as a reflux condenser.

After all the K is dissolved, adapter c is quickly replaced with a plain cap d . The stopcock is then quickly switched over to

admit O_2 , prepurified with soda-lime, $CaCl_2$ and P_2O_5 . A white precipitate of K_2O_2 appears first, followed by a brick-red intermediate product (possibly K_2O_3). The latter is finally converted to yellow KO_2 . After about four hours, the coolant is removed and all remaining NH_3 is evaporated in a stream of O_2 . Finally, the freshly formed KO_2 is heated, in an oil-pump vacuum, with a non-luminous flame and transferred to a suspended collector tube. The oxygen content of the preparation is close to theoretical.

PROPERTIES:

Yellow substances, decomposed by H_2O with evolution of O_2 . The structure of NaO_2 is similar to that of $NaCl$, with O_2^- replacing the Cl^- ions. Structures of KO_2 , RbO_2 and CsO_2 : CaC_2 lattice (C11).

	d. (x-ray)	M. p. °C
NaO_2	2.21	—
KO_2	2.14	380
RbO_2	3.06	412
CsO_2	3.80	432

REFERENCES:

- NaO_2 : S. E. Stephanou, W. H. Schlechter, W. I. Argersinger and J. Kleinberg. *J. Amer. Chem. Soc.* 71, 1819 (1949); D. H. Templeton and C. H. Dauben, *J. Amer. Chem. Soc.* 72, 2251 (1950);
- KO_2 , RbO_2 , CsO_2 : W. Klemm and H. Sodomann, *Z. anorg. allg. Chem.* 225, 273 (1935); A. Helms and W. Klemm, *Z. anorg. allg. Chem.* 241, 97 (1939); H. Lux and R. Kuhn, 1957; A. Joannis, *Compt. Rend. Hebd. Séances Acad. Sci.* 116, 1370 (1893); C. A. Kraus and E. F. Parmenter, *J. Amer. Chem. Soc.* 56, 2384 (1934).

Lithium Hydroxide

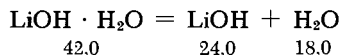
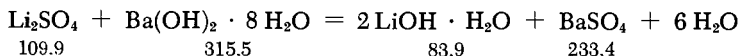

To prepare lithium hydroxide by the method of Barnes, equivalent amounts of aqueous solutions of Li_2SO_4 and $Ba(OH)_2$ are

reacted and the filtrate is concentrated in vacuum on a Pt dish. The product solution tends to become supersaturated. It takes three weeks before large needle-shaped crystals of the monohydrate $\text{LiOH} \cdot \text{H}_2\text{O}$ are formed.

According to De Forcrand, the powdered monohydrate is converted to LiOH on drying for several days over P_2O_5 in vacuum. The dehydration can also be accomplished by slow heating of the monohydrate of 140°C in a silver boat, white in a stream of pure H_2 . If the temperature is raised too rapidly, the preparation melts at 445°C and converts to a hydrate $8\text{LiOH} \cdot \text{H}_2\text{O}$, which can be dehydrated only with difficulty. At $660\text{--}780^\circ\text{C}$ the compound loses all its water and Li_2O remains as a residue.

PROPERTIES:

LiOH : white, translucent, less hygroscopic than NaOH . M.p. 462°C . d. 1.46 B10 structure type.

$\text{LiOH} \cdot \text{H}_2\text{O}$: a saturated solution at 25°C contains 7.15% Li_2O . d. 1.51 B36 structure type.

REFERENCES:

E. Barnes, J. Chem. Soc. (London) 1931, 2605.

De Forcrand, Comptes Rendus Hebd. Séances Acad. Sci. 146, 803 (1908).

Rubidium and Cesium Hydroxides

RbOH , CsOH

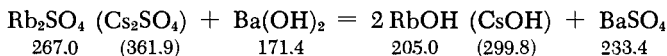

To prepare RbOH and CsOH according to Barnes, aqueous solutions of Rb_2SO_4 (or Cs_2SO_4) and $\text{Ba}(\text{OH})_2$ are reacted in equivalent proportions. The filtrate is concentrated in a Pt dish in vacuum over solid KOH and heated slowly at 300°C in a silver boat in a stream of CO_2 free hydrogen.

According to Von Hevesy, the last persistently adhering traces of water are removed by bubbling through purified and dried N_2 through the melt with the aid of a thin Ag tube.

According to Winslow, Liebafsky and Smith, pure RbOH and CsOH are prepared by electrolysis of the chlorides, using an amalgam procedure carried out in a multicell apparatus.

The hydroxides can be worked up to the azides, chromates and iodides.

PROPERTIES:

White, crystalline, very hygroscopic substances. RbOH and CsOH: m.p. 301°C and 272.3°C, Enantiotropic transformation points 245°C and 223°C. Saturated aqueous solutions at 30°C contain 65.56% Rb₂O and 70.63% Cs₂O. Soluble in alcohol. d. 3.20 and 3.675.

REFERENCES:

G. von Hevesy, Z. phys. Chem. 73, 667 (1910).

A. F. Winslow, H. A. Liebhafsky and H. M. Smith, J. Phys. Colloid. Chem. 51, 967.

Lithium Nitride

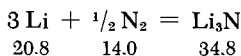

The method of Zintl and Brauer uses pieces of pure Li milled clean under an Ar blanket. These pieces are then transferred in the absence of air to a vessel described by Zintl and Woltersdorf (Fig. 272) and nitrided. The crucible *t* is made of zirconium dioxide coated with fused lithium fluoride (m.p. 840°C). In contrast to most ceramic and metal vessels, these crucibles are completely resistant to liquid Li up to 800°C, thus allowing the preparation of pure Li compounds from the metal. Crucible *t* is set inside an iron protective crucible *e*, which is placed in a ceramic tube *r*. The top adapter *g* is cemented to *r* with sealing wax. A lead cooling coil is wrapped around the cemented area. Stopcock *h* may be used both as a vacuum connection and a gas inlet. A peephole *f* cemented onto *g*, permits observation of the material in the crucible.

Large crystallites are more likely to be obtained if the nitridding is started at 400°C, the temperature is gradually raised to 800°C, and the thoroughly purified and dried N₂ is diluted with about 20 vol. % Ar.

Fig. 272. Preparation of lithium nitride: *t*) crucible made of ZrO₂ coated with LiF; *e*) iron protective crucible; *r*) ceramic outer tube; *g*) glass adapter with a glass peephole *f* and stopcock *h*.

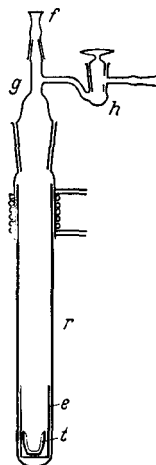

PROPERTIES:

Ruby-red, translucent crystallites, decomposed by moisture with evolution of NH_3 . d. (x-ray) 1.28. Hexagonal.

REFERENCES:

- E. Zintl and G. Brauer, Z. Elektrochem. 41, 102 (1935).
E. Zintl and G. Woltersdorf, Z. Elektrochem. 41, 876 (1935).

Phosphides, Arsenides, Antimonides and Bismuthides of Alkali Metals from the Elements

		+ P 31.0	+ As 74.9	+ Sb 121.8	+ Bi 209.0
3 Li 20.8	Li_3P 50.8	Li_3As 95.7	Li_3Sb 142.6	Li_3Bi 229.8	
3 Na 69.0	Na_3P 99.0	Na_3As 143.9	Na_3Sb 190.7	Na_3Bi 278.0	
3 K 117.3		K_3As 192.2	K_3Sb 239.0	K_3Bi 326.3	

According to Brauer and Zintl, the phosphides, arsenides, antimonides and bismuthides of Li, Na and K are prepared as follows.

Preparation of starting materials: Alkali metals stripped of crusts under light benzine, then freed of the latter in high vacuum; red phosphorus prepared from freshly distilled, completely dry yellow phosphorus by prolonged heating at 275°C ; As, sublimed in a nitrogen stream; Sb and Bi of highest purity (see also the related sections of this book).

Li_3P , Li_3As , Li_3Sb and Li_3Bi

To prepare Li_3P (or Li_3As), Li and red P (or Li and As) are fused in a crucible made of zirconium dioxide and lined with LiF (see under Li_3N). The crucible is hermetically sealed in an iron crucible and heated to 680°C for Li_3P and to 800°C for Li_3As . Very pure red-brown Li_3P , or brown-black Li_3As , is obtained. It is transferred from the crucibles to glass vessels provided with ground stoppers and stored under Ar. The product should not come in contact with air at any time.

To obtain Li_3As and Li_3Sb , a suspension of freshly powdered As (or Sb) in anhydrous liquid NH_3 is prepared. A solution of Li in dried liquid ammonia is added, in small portions, to the suspension. The reaction begins on shaking. Its termination is indicated by the appearance of a blue color in the supernatant fluid, due to a slight excess of Li. The NH_3 is boiled out, with the last

traces removed by vacuum. The products are either the brown Li_3As powder (very air sensitive; must be stored under pure N_2 or Ar) or blue-gray β - Li_3Sb powder. The particle size of the latter can be increased by heating at 650°C . Another modification, α - Li_3Sb , is obtained by quenching of the melt (m.p. between 1150 and 1300°C) under Ar in a thick-walled iron crucible with welded-on lid.

According to Zintl and Brauer, Li_3Bi is prepared by melting together stoichiometric quantities of Li and Bi in tall, narrow iron crucibles, followed by slow cooling. The crucibles are filled with Ar and tightly closed with welded-on iron stoppers. (See also Part III, section on intermetallic compounds.)

Na_3P , Na_3As , Na_3Sb and Na_3Bi

The phosphide forms when stoichiometric quantities of Na and red P are fused under a protective Ar blanket in a Tamman crucible. The latter is made of sintered corundum and is hermetically sealed in an outer iron crucible.

To prepare Na_3As , Na vapor is passed over heated As. An iron boat filled with Na is placed inside an evacuated Vycor tube, together with another boat made of sintered corundum and filled with As powder. Using small movable electric tubular heaters, the Na is vaporized at 350 – 450°C and the vapor is passed over the As, preheated to 180 – 200°C . Conversion to brown-violet Na_3As is complete. The excess Na is removed from the apparatus on heating to 450°C in high vacuum.

Both Na_3Sb and Na_3Bi are obtained from stoichiometric quantities of the respective reactants which are melted together in tall, narrow crucibles (filled with Ar and tightly closed with welded-on iron stoppers) at temperatures exceeding the melting point (856°C and 775°C , respectively) by 50 – 100°C . (See the section on Intermetallic Compounds, Part III.) After slow cooling, the crucibles are cut open under a protective gas blanket. The products are brittle, bluish or violet-gray, and have a slight metallic sheen.

K_3As , K_3Sb and K_3Bi

The arsenide is obtained in a manner analogous to Na_3P at 800°C . It is a very brittle substance with a greenish metallic luster.

Both K_3Sb and α - K_3Bi are prepared in the same manner as the corresponding Na compounds (m.p. 812°C for K_3Sb and 671°C for K_3Bi). Both substances are very brittle, with a green-yellow sheen resembling that of fuchsin crystals (β - K_3Bi is stable only above 280°C).

PROPERTIES:

β -Li₃Sb and Li₃Bi crystallize in DO₃ structure type; all the others, in type DO₁₈. D. (x-ray): Li₃P 1.43; Li₃As 2.42; α -Li₃Sb 2.96; β -Li₃Sb 3.29; Li₃Bi 5.03; Na₃P 1.74; Na₃As 2.36; Na₃Sb 2.67; Na₃Bi 3.70; K₃As 2.14; K₃Sb 2.35; K₃Bi 2.98.

REFERENCES:

- G. Brauer and E. Zintl, Z. phys. Chem. (B) 37, 323 (1937).
E. Zintl and G. Brauer, Z. Elektrochem. 41, 297 (1935).

Sodium and Lithium Carbides

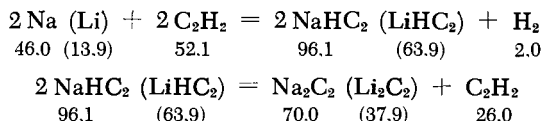
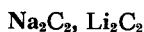

In the method of Antropoff and Müller, Na₂C₂ may be prepared by letting acetylene react with Na dissolved in liquid NH₃. The sodium acetylide thus formed loses acetylene at 145°C in vacuum and is converted to Na₂C₂. The latter is obtained as a pure white product, containing 1.3-3.0% undecomposed acetylide.

Lithium carbide, obtained in a similar way, invariably contains 20% acetylide, even when heated in vacuum to the decomposition temperature of the carbide (about 300°C).

PROPERTIES:

Na₂C₂ is very hygroscopic. d. 1.575. Li₂C₂ is white and crystalline; decomposed by water. d. 1.65.

REFERENCES:

- A. von Antropoff and J. Fr. Müller, Z. anorg. allg. Chem. 204, 306 (1932).
E. Masdupuy and F. Gallais, Compt. Rend. Hebd. Séances Acad. Sci. 232, 1837 (1951).

Alkali Metal Carbonates of Highest Purity

To purify commercial Li₂CO₃ (as well as lithium carbonate obtained from minerals), it is dissolved in acetic acid, following

the method of Zintl, Harder and Dauth; the Ca is precipitated with ammonium oxalate and the Mg with $\text{Ba}(\text{OH})_2$ solution. The barium is removed from the filtrate by precipitation with sulfuric acid. The solution, separated from the precipitate, is evaporated to dryness and the residue mildly calcined to remove ammonium salts. It is then dissolved in hydrochloric acid and treated with distilled ammonium carbonate to precipitate pure Li_2CO_3 .

Pure Na_2CO_3 , K_2CO_3 , Rb_2CO_3 and Cs_2CO_3 are prepared by the method of Suhrmann and Clusius, starting with pure alkali chlorides. These salts are converted to the nitrates by treatment with excess nitric acid in steamed-out Pyrex vessels. After removal of the chlorine, the nitrates are treated in a Pt dish with a fourfold amount of crystallized oxalic acid and are finally calcined to the pure carbonates. No foreign metals are used in this method; hence no impurities can be introduced.

PROPERTIES:

Li_2CO_3 : formula weight 73.9. Colorless monoclinic crystals. M.p. 735°C , b.p. 1200°C . Solubility at 0°C , 1.54; at 20°C , 1.33; and at 100°C , 0.73 g./100 g. of H_2O . d. 2.1.

Na_2CO_3 : formula weight 106.0. Transition point 450°C . m.p. 860°C . Solubility at 20°C (solid phase $\text{Na}_2\text{CO}_3 \cdot 10\text{H}_2\text{O}$), 21.58 g.; at 35°C (solid phase $\text{Na}_2\text{CO}_3 \cdot 7\text{H}_2\text{O}$), 49.25 g.; and at 75°C (solid phase $\text{Na}_2\text{CO}_3 \cdot \text{H}_2\text{O}$), 45.88 g./100 g. of H_2O . CO_2 pressure 1 mm. at 700°C . d. 2.53.

K_2CO_3 : formula weight 138.2. Transition point 140°C . m.p. 891°C . Hygroscopic. Solubility at 0°C , 105 g.; at 20°C , 112 g.; and at 100°C , 156 g./100 g. of H_2O . CO_2 pressure 1.2 mm. at 950°C . d. 2.43.

Rb_2CO_3 : formula weight 231.0. m.p. 837°C . On melting, attacks Pt. Very hygroscopic. Solubility in water at 20°C , 69.01 g./100 g. of saturated solution. Solubility in absolute alcohol at 19°C , 0.74 g./100 g. of alcohol. CO_2 pressure 2 mm. at 740°C ; 10 mm. at 900°C .

Cs_2CO_3 : formula weight 325.8. Melts at red heat. Deliquescent in air. Solubility in H_2O : at 20°C , the saturated solution contains 72.34% Cs_2CO_3 . Solubility in absolute alcohol at 19°C , 11.1 g./100 g. of alcohol; at the b.p. of alcohol, 20.1 g. CO_2 pressure 2 mm. at 610°C ; 44 mm. at 1000°C .

REFERENCES:

- E. Zintl, A. Harder and B. Dauth, *Z. Elektrochem.* **40**, 588 (1934).
 R. Suhrmann and K. Clusius, *Z. anorg. allg. Chem.* **152**, 52 (1926).

Silicides and Germanides of Alkali Metals

from the Elements

NaSi, KSi, RbSi, CsSi, NaGe, KGe, RbGe, CsGe

		+ Si	28,1	+ Ge	72,6
Na	23.0	NaSi	51.1	NaGe	95.6
K	39.1	KSi	67.2	KGe	111.7
Rb	85.5	RbSi	113.5	RbGe	158.1
Cs	132.9	CsSi	161.0	CsGe	205.5

The alkali silicides and germanides are very moisture sensitive. In the method of Hohmann the synthesis is carried out in corundum crucibles set in vacuum-tight, Ar-filled iron bombs (Fig. 273, *A* and *B*). The corundum crucible *t* is thoroughly ignited before being charged with a small amount (a fraction of a gram) of Si (or Ge) which has been finely ground in an agate mortar. Crucible *t* is then placed in small bomb *b*, and the latter set on the stem of a Pyrex device (Fig. 274) designed for transfer of alkali metals. The apparatus is carefully evacuated through *c* (so as not to lose any Si or Ge through dusting), and Ar gas is let in through the same route and escapes through *e*. Next, ampoule *f*, containing the alkali metal and already opened at the bottom, is introduced through *e* and allowed to slide down into the slightly tilted apparatus. Ground cap *e* is then replaced and the apparatus is evacuated at once. The area *B* is then thoroughly heated with a gas burner. The alkali metal (present in a three- or fourfold excess) is caused to flow into the crucible by heating area *f* with a flame. After cooling, Ar is reintroduced and the bomb removed in a strong Ar stream through the bottom by lifting cap *a*. The bomb is immediately tightly closed with cone *l*, ring (or plate) gasket *h* and screw-cap *n* (see Fig. 273).

Following completion of the reaction (see below), the bomb is slowly cooled and opened by unscrewing the cap until 0.5 mm. of the thread is left, and then breaking off the cap is on a bench vise. The open bomb is quickly pushed into the distillation tube (Fig. 275), through which either Ar or N₂ is flowing. After evacuating briefly, Ar is again admitted and the tube sealed at *m*. Finally, an electric furnace is slid over the tube and the excess of alkali metal is separated from the product by distillation in high vacuum and condensed in *n*. This may take several days. After breaking off the end of the tube at *m*, bomb *b* containing the corundum crucible is taken out in a stream of Ar. If necessary, the product can be ground in an apparatus proposed by Klemm and Dinkelacker, in the absence of air and moisture. (See section on Intermetallic Compounds.)

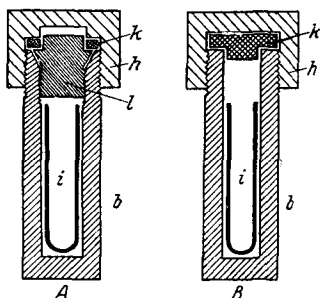

Fig. 273

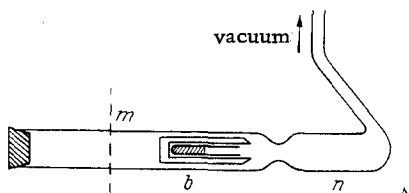

Fig. 274

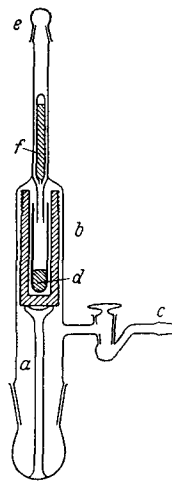

Fig. 275

Fig. 273. Iron bombs used in the preparation of alkali metal silicides and germanides: *A*—bomb for preparation of Rb and Cs compounds; *B*—bomb for the Na and K compounds. *b*—Iron bomb; *h*—iron screw-on cap; *i*—corundum crucible; *k*—copper gasket; *l*—iron cone.

Fig. 274. Filling (transfer) apparatus for preparing alkali metal silicides and germanides: *b*—iron bomb; *d*—silicon or germanium; *f*—ampoule containing alkali metal.

Fig. 275. Separating the excess alkali metal from the silicide or germanide by distillation.

Supplementary Synthesis Data

	Optimum reaction temperatures	Reaction time	Distillation temperature time	
NaSi	700°C	1-2 days	280-300°C	4 days
KSi	650	4-5 days	240-250	
RbSi	600	3-4 days	180-200	several days
CsSi	600	3-4 days	150-180	
NaGe	650-700	2 days		
KGe, RbGe, CsGe		600	several days	

PROPERTIES OF SILICIDES:

Very sensitive to moisture. Reactivity increases from NaSi to CsSi: NaSi self-igniting only as a loose powder; KSi self-igniting with detonation. All four silicides ignite explosively on contact with water or dilute acids. With dilute alkalis the reaction is milder.

NaSi: Long needles, metallic luster.

KSi: Hard, poorly crystallized substance with dark luster.

RbSi: Small dark crystals.

CsSi: Brittle, brass-colored compact mass; also single crystals.

Decomposition temperatures in high vacuum; NaSi 420°C; KSi 360°C; RbSi and CsSi 350-360°C. Decomposition products: Na + Si, KSi₃, RbSi₃ and CsSi₃.

PROPERTIES OF GERMANIDES:

Sensitive to moisture, but less reactive than the silicides. Decompose in air into alkali hydroxide and brown germanium monohydride (GeH)_x. Decompose rapidly, with occasional igniting in water, dilute acids or dilute alkalis.

NaGe: Small, well-formed needles, metallic luster.

KGe: Loose, dark-colored substance; no well-defined crystals.

RbGe: Bronze-colored crystals.

CsGe: Crystals of a beautiful jet-black color.

Decomposition temperature in high vacuum: NaGe 480°C; KGe 400-420°C; RbGe and CsGe 390-410°C. Decomposition products: Na + Ge, KGe₄, RbGe₄ and CsGe₄.

Li₂Si, Li₄Si

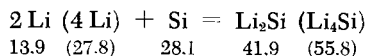

In the method of Klemm and Struck, Li₂Si and Li₄Si are prepared in small tubular nickel crucibles. These are charged with weighed amounts of Si and Li in the absence of air and moisture and heated under argon in a Thermax steel bomb provided with a screw-on cap. The reaction temperature for Li₂Si is 530°C and for Li₄Si, 630°C. After cooling, the products can be ground, if needed, in an apparatus proposed by Klemm and Dinkelbacker. (See section on Alloys and Intermetallic Compounds.)

PROPERTIES:

Sensitive to moisture. Li₂Si is dark violet; Li₄Si is silver-gray.

REFERENCES:

- E. Hohmann, Z. anorg. Chem. 257, 113 (1948).
L. M. Dennis and N. A. Skow, J. Amer. Chem. Soc. 52, 2369 (1930).
E. Zintl and H. Kaiser, Z. anorg. allg. Chem. 211, 120 (1933).
W. C. Johnson and A. C. Weatley, Z. anorg. allg. Chem. 216, 282 (1934).
W. Klemm and F. Dinkelacker, Z. anorg. Chem. 255, 2 (1947).
W. Klemm and M. Struck, Z. anorg. allg. Chem. 278, 117 (1955).

Formula Index

A	(AlH ₃) _n · xO(C ₂ H ₅) ₂ 807	B
Ag 279	AlI ₃ 814	B 770
Ag(CF ₃ COO) 205	AlI ₃ · 6NH ₃ 819	B ₂ Al 772
AgCN 661	AlN 827	B ₁₂ Al 772
AgF 240	Al(N ₃) ₃ 829	BasO ₄ 797
AgF ₂ 241	Al ₂ O ₃ 822	BBr ₃ 770, 781
Ag ₂ F 239	Al(OCH ₃) ₃ 833	B(CH ₃) ₃ 798
AgNCS 671	Al(OC ₂ H ₅) ₃ 834,	B(C ₂ H ₅) ₃ 799
Ag ₂ N ₂ O ₂ 493, 514	835	B(C _n H _{2n+1}) ₃ 800
AgPO ₂ (NH ₂) ₂ 582	Al(OC ₂ H ₄) ₃ N 835	BCl ₃ 780
Ag ₂ SiO ₃ 705	Al(OD) ₃ 134	BCl ₂ (C _n H _{2n+1}) 803
AlAs 831	Al(OH) ₃ 676, 810,	BF ₃ 219
AlAsO ₄ 831	820	BF ₂ (n-C ₄ H ₉) 802
AlB ₂ 772	AlOOH 820	BF ₃ · 2H ₂ O 784
AlB ₁₂ 772	Al ₂ O ₃ · 2SO ₂ · H ₂ O	BF ₃ · NH ₃ 785
AlBr ₃ 806, 813	824	BF ₃ · O(C ₂ H ₅) ₂ 786
AlBr ₃ · H ₂ S 819	Al ₂ O ₃ · 3SO ₂ · xH ₂ O	B ₂ H ₆ 773
Al ₄ C ₃ 832	824	BH ₃ · N(CH ₃) ₃ 778
Al(C ₂ H ₅) ₃ 810	AlP 829	BI ₃ 782
Al(C ₂ H ₅) ₂ Br 809	AlPO ₄ 831	BN 789
Al(CH ₃ COO) ₃ 835	Al ₂ S ₃ 134, 700,	B(N ₃) ₃ 476
Al(C ₂ H ₅) ₂ Cl · O(C ₂ H ₅) ₂	823	B ₃ N ₃ Cl ₃ H ₃ 779
811	AlSb 831	B ₃ N ₃ H ₆ 779
Al(C ₂ H ₅) ₂ H 811	Al ₂ Se ₃ 825	B ₂ O ₃ 787
Al(C ₅ H ₇ O ₂) ₃ 836	Al ₂ Te ₃ 826	B(OCH ₃) ₃ 797
Al(C ₂ H ₅) ₃ · O(C ₂ H ₅) ₂	Ar 82	B ₃ O ₃ (CH ₃) ₃ 800
811	As 591	B ₃ O ₃ (n-C ₄ H ₉) ₃ 801
Al(CN) ₃ · O(C ₂ H ₅) ₂	AsBr ₃ 597	B(OH) ₂ CH ₃ 800
834	AsCl ₃ 596	B(OH) ₂ (n-C ₄ H ₉) 801
AlCl ₃ 680, 805,	AsF ₃ 179, 197	BPO ₄ 796
812	AsF ₅ 198	B ₂ S ₃ 788
Al ₂ Cl ₃ H ₃ 808	AsH ₃ 593	Ba 922
AlCl ₃ · 6H ₂ O 815	As ₂ H ₄ 594	BaBr ₂ 930
AlCl ₃ · NH ₃ 817	AsI ₂ 598	Ba(BrO ₃) ₂ · H ₂ O 316
AlCl ₃ · PCl ₅ 818	AsI ₃ 597	BaCO ₃ 933
AlCl ₃ · SO ₂ 817	As ₂ O ₃ 600	BaCS ₃ 674
Al ₂ Cl ₆ · SOCl ₂ 818	As ₂ O ₅ 601	BaCl ₂ 930
AlF ₃ 225	As ₂ O ₅ · ⁵ / ₃ H ₂ O 601	Ba(ClO ₃) ₂ · H ₂ O 314
AlF ₃ · 3H ₂ O 225	As ₂ S ₅ 603	Ba(ClO ₄) ₂ 320
AlH ₃ · N(CH ₃) ₃ 809	As ₄ S ₄ 603	Ba(ClO ₄) ₂ · 3H ₂ O 320
AlH ₃ · 2N(CH ₃) ₃ 809	As ₂ Zn ₃ 594	BaF ₂ 234

- BaGeF₆ 215
 BaH₂ 929
 Ba₃H₄(IO₆)₂ 326
 Ba(H₂PO₄)₂ · H₂O 557
 BaH₂P₂O₆ · 2H₂O 562
 BaI₂ 930
 Ba(N₃)₂ 942
 Ba(N₃)₂ · H₂O 942
 Ba₃N₂ 940
 BaO 933
 BaO₂ 937
 BaO₂ · 8H₂O 936
 Ba₃(PO₄S₂)₂ · 8H₂O 572
 BaS 938
 Ba(SO₃F)₂ 173
 BaS₂O₆ · 2H₂O 397
 BaSe 939
 BaSeO₄ 939
 BaSi 947
 BaSiO₃ 706
 BaSi₂O₅ 706
 BaTe 940
 Be 887
 BeBr₂ 891
 BeC₂ 899, 900
 Be₂C 899
 Be(CH₃COO)₂ 901
 BeCO₃ 893
 BeCl₂ 889
 BeF₂ 231
 BeI₂ 892
 Be(N₃)₂ 899
 Be₃N₂ 898
 BeO 893
 Be₄O(CH₃COO)₆ 901
 Be₄O(C₂H₅COO)₆ 902
 Be(OH)₂ 894
 Be₄O(HCOO)₆ 902
 BeS 895
 BeSe 897
 BeTe 897
 Bi 620
 BiBO₃ · 2H₂O 627
 BiBr₃ 623
 BiCl₂ 622
 BiCl₃ 621
 BiF₃ 201
 BiF₅ 202
 BiI₃ 624
 BiICl₂ 622
 Bi₂O₃ 620
 Bi₂O₄ · aq 629
 BiOBr 624
 BiOCl 622
 BiOI 625
 BiONO₂ 626
 BiONO₂ · 0.5H₂O 626
 BiONO₃ 620
 BiPO₄ 626
 BiPO₄ · 3H₂O 626
 Br₂ 275
 BrCN 665
 BrF₃ 156
 BrF₅ 158
 Br₂ · 8H₂O 276
 BrN₃ 476
 Br(NO₃)₃ 328
 BrO₂ 306
 Br₂O 307
 [BrPy_x]ClO₄ 328
 [BrPy₂]F 328
 [BrPy_x]NO₃ 328
- C**
- C 630
 C₃₀AlCl₄ · 2AlCl₃ 644
 C₈Br 643
 CClF₃ 205
 CCl₂F₂ 151, 205
 C₂Cl₂F₄ 205
 C₂Cl₃F₃ 205
 C₈Cs 635
 C₂₄Cs 635
 C₃₆Cs 635
 C₄₈Cs 635
 C₁₂Cs(NH₃)₂ 637
 CF 640
 CF₄ 203, 207
 C₄F 641 f
 CF₃COOAg 205
 C₂HCl₃F₂ 205
 CHF₃ 204
 (C₅H₅NH)₂PbCl₆ 750
 C₂₄HSO₄ · 2H₂SO₄ 642
 CIF₃ 205
 C₈K 635
 C₂₄K 635
 C₃₆K 636
 C₄₈K 636
 C₁₂K(NH₃)₂ 637
 C₁₂Li(NH₃)₂ 637
 (CN)₂ 661
 CNBr 665
 CNCl 662
 CNI 666
 C₁₂Na(NH₃)₂ 637
 CO 645
 CO₂ 647
 C₃O₂ 648
 COBrF 210
 COCl₂ 650
 COClF 208
 COF₂ 206, 210
 COIF 211
 (CONH)₃ 668
 COS 654
 COSe 655
 C₈Rb 635
 C₂₄Rb 635
 C₃₆Rb 635
 C₄₈Rb 635
 C₁₂Rb(NH₃)₂ 637
 CS₂ 652
 C₃S₂ 653
 C₃S₂Br₆ 653
 CSe₂ 656
 Ca 922
 Ca(AlH₄)₂ 806
 CaBr₂ 930
 CaC₂ 943
 CaCN₂ 946
 CaCO₃ 931
 CaCl₂ 930
 Ca(ClO₄)₂ 320
 Ca(ClO₄)₂ · 4H₂O 320
 CaF₂ 233
 CaGe 948

CaH₂ 929
 CaI₂ 930
 Ca₃N₂ 940
 CaO 931
 CaO₂ 936
 CaO₂ · 8H₂O 936
 Ca(OH)₂ 934
 Ca₃P₂ 942
 Ca₁₀(PO₄)₆(OH)₂ 545
 Ca₂PbO₄ 760
 CaS 938
 CaSe 939
 CaSeO₄ 939
 CaSi 946
 CaSi₂ 946
 CaTe 940
 CdF₂ 243
 CeF₃ 247
 CeF₄ 247
 Cl₂ 272
 (ClBNH)₃ 779
 ClCN 662
 ClF 153
 ClF₃ 155
 Cl₂ · 6H₂O 274
 ClN₃ 476
 ClNH₂ 477
 ClNO₃ 326
 ClN(SO₃K)₂ 508
 ClO₂ 301
 Cl₂O 299
 Cl₂O₆ 303
 Cl₂O₇ 304
 ClO₂F 165
 ClO₃F 166
 ClO₄F 167
 [ClPy_x]NO₃ 328
 CoCl₂ 267
 CoF₂ 267
 CoF₃ 268
 CoSO₂ · 3H₂O 393
 CrF₂ 256
 CrF₃ 257
 CrF₃ · 3H₂O 258
 CrF₄ 258
 CrO₂F₂ 258
 Cs 958

CsAl(SO₄)₂ · 12H₂O
 956
 CsBrCl₂ 294
 CsC₈ 635
 CsC₂₄ 635
 CsC₃₆ 636
 CsC₄₈ 636
 Cs₂CO₃ 987
 CsCl 951, 955
 CsGe 989
 CsH 971
 CsIBr₂ 297
 CsICl₂ 296
 CsN₃ 476
 Cs(NH₃)₂C₁₂ 637
 CsO₂ 981
 Cs₂O 974
 CsOH 983
 Cs₂S₂ 369
 Cs₂S₃ 369
 Cs₂S₅ 369
 Cs₂S₆ 369
 Cs₂SeCl₆ 425
 CsSi 989
 Cs₂TeCl₆ 444
 Cs(Tl₂Cl₉) 874
 CuF₂ 238
 CuF₂ · 5H₂O · 5HF
 238
 Cu₂P₄O₁₂ 553

D

D₂ 121
 DBr 131
 DCl 129
 DF 127
 DH 126
 DI 133
 D₂O 119
 D₃PO₃ 132
 D₃PO₄ 138
 D₂S 134
 D₂SO₄ 135

E

EuF₂ 248

F

F₂ 143
 F₂O 163
 F₂O₂ 162
 FSO₂NO 186
 FeF₂ 266
 FeF₃ 266

G

Ga 837
 GaAs 857
 GaBr₂ 846
 GaBr₃ 845
 Ga(CH₃)₃ 840
 Ga(CH₃)₃ · N(C₂H₅)₃
 841
 GaCl₂ 846
 GaCl₃ 843
 Ga(ClO₄)₃ · 6H₂O 839
 GaF₃ 227
 Ga₂H₆ 840
 Ga₂H₂(CH₃)₄ 840
 GaI₃ 846
 GaN 855
 Ga(N₃)₃ 476
 Ga(NO₃)₃ 856
 Ga₂O 849
 Ga₂O₃ 848
 Ga(OH)₃ 847
 GaO(OH) 847
 GaP 857
 GaS 851
 Ga₂S 852
 Ga₂S₃ 850
 GaSb 857
 GaSe 854
 Ga₂Se 854
 Ga₂Se₃ 854
 GaTe 855
 Ga₂Te₃ 855
 Ge 712
 GeBr₄ 718
 Ge(CH₃COO)₄ 726
 GeCH₃I₃ 722
 GeCl₂ 716

- GeCl_4 707, 715
 GeF_4 215
 GeH_4 713
 Ge_2H_6 713
 Ge_3H_8 713
 GeHCl_3 717, 721
 GeI_2 720
 GeI_4 719
 Ge_3N_4 722
 $\text{Ge}(\text{NH})_2$ 723
 $\text{Ge}_2\text{N}_3\text{H}$ 723
 GeO 711
 GeO_2 706
 $\text{Ge}(\text{OC}_2\text{H}_5)_4$ 725
 GeS 723, 724
 GeS_2 723
- H**
- H_2 111
 $\text{HAlBr}_4 \cdot 20(\text{C}_2\text{H}_5)_2$
 817
 $\text{HAlCl}_4 \cdot 20(\text{C}_2\text{H}_5)_2$
 816
 H_3AsO_4 601
 $\text{H}_3\text{AsO}_4 \cdot 0.5\text{H}_2\text{O}$ 601
 H_7AsO_6 601
 HBF_4 221
 $\text{H}[\text{BF}_2(\text{OH})_2]$ 784
 $(\text{HBNH})_3$ 779
 HBO_2 791
 HBr 282
 HBrO_3 315
 HCN 658, 668
 H_2CS_3 674
 HCl 280
 HClO 308
 HClO_3 312
 HClO_4 318
 HD 126
 HF 145
 HI 286
 $\text{HICl}_4 \cdot 4\text{H}_2\text{O}$ 299
 HIO_3 316
 H_5IO_6 322
 $\text{HIO}_3 \cdot \text{I}_2\text{O}_5$ 307
 HN_3 472
- HNCO 667, 668
 HNCS 669
 HNO_3 491
 $\text{H}_2\text{N}_2\text{O}_2$ 492
 H_2O 117
 H_2O_2 140
 H_3PO_2 555
 H_3PO_3 554
 H_3PO_4 543
 $\text{H}_4\text{P}_2\text{O}_6$ 558
 $\text{H}_4\text{P}_2\text{O}_6 \cdot 2\text{H}_2\text{O}$ 559
 $\text{H}_4\text{P}_2\text{O}_7$ 546
 HPO_2Cl_2 538
 $\text{HPO}_2(\text{NH}_2)_2$ 582
 $\text{H}_2\text{PO}_3\text{NH}_2$ 579
 $\text{H}_3\text{PO}_3\text{S}$ 568
 H_2S 344
 H_2S_2 350
 H_2S_3 350
 H_2S_4 353
 H_2S_5 353
 H_2S_6 353, 355
 H_2S_7 353, 355
 H_2S_8 353, 355
 H_2S_x 346
 H_2SO_5 388
 $\text{H}_2\text{S}_2\text{O}_8$ 389
 $\text{H}_2\text{S}_x\text{O}_3$ 405
 $\text{H}_2\text{S}_x\text{O}_6$ 405
 HSO_3Cl 385
 HSO_3F 177
 HSO_3NH_2 508
 $\text{HSbCl}_6 \cdot 4.5\text{H}_2\text{O}$ 611
 H_2Se 418
 H_2SeO_3 430
 H_2SeO_4 432
 H_2SiF_6 214
 $\text{H}_2\text{Si}_2\text{O}_3$ 694, 699
 $\text{H}_2\text{Si}_2\text{O}_5$ 699
 H_4SiO_4 697
 H_2Te 438
 H_2TeO_3 449
 H_6TeO_6 451
 $\text{H}(\text{TlCl}_4) \cdot 3\text{H}_2\text{O}$ 872
 $\text{HTl}(\text{SO}_4)_2 \cdot 4\text{H}_2\text{O}$ 882
 $\text{H}_2\text{SnCl}_6 \cdot 6\text{H}_2\text{O}$ 730
 He 82
- Hg 28
 Hg_2CO_3 243
 HgF_2 244
 Hg_2F_2 243
 HgO 299
 HgSeF_4 180
- I**
- I_2 277
 IBr 291
 $[(\text{C}_5\text{H}_5\text{N})_2]\text{ClO}_4$ 327
 ICN 666
 ICl 290
 ICl_3 292
 $\text{I}(\text{ClO}_4)_3$ 330
 IF_5 159
 IF_7 160
 $\text{I}(\text{IO}_3)_3$ 331
 $\text{I}(\text{NO}_3)_3$ 329
 I_2O_4 333
 I_2O_5 307
 I_4O_9 331
 $\text{I}_2\text{O}_5 \cdot \text{HIO}_3$ 307
 $(\text{IO})_2\text{SO}_4 \cdot \text{H}_2\text{O}$ 342
 $[\text{IPy}_x]\text{ClO}_4$ 328
 $[\text{IPy}_2]\text{F}$ 328
 $[\text{IPy}_x]\text{NO}_3$ 328
 $\text{I}_2(\text{SO}_4)_3$ 329
 In 857
 InAs 867
 InBr 862
 InBr_2 861
 InBr_3 859
 InCl 862
 InCl_2 861
 InCl_3 858
 InF_3 228
 InI 862
 InI_2 861
 InI_3 860
 InN 866
 In_2O 863
 In_2O_3 863
 $\text{In}(\text{OH})_3$ 862
 InP 867
 InS 864

- In_2S 864
 In_2S_3 864
 InSb 867
 InSe 865
 In_2Se 865
 In_2Se_3 865
 In_2Te 865
 In_2Te_3 865
 IrF_4 271
 IrF_6 270
- K**
- K 958
 K_3As 986
 KAsH_2 595
 KBF_4 223
 KBF_3OH 223
 K_3Bi 986
 $\text{KBiO}_3 \cdot \frac{1}{3}\text{H}_2\text{O}$ 628
 KBrF_4 237
 $\text{KBrO} \cdot 3\text{H}_2\text{O}$ 311
 KC_8 635
 KC_{24} 635
 KC_{36} 635
 KC_{48} 635
 K_2CO_3 987
 K_3COF_7 269
 K_2CrF_6 269
 K_3CUF_6 269
 KF 236
 $\text{KF} \cdot \text{HF}$ 237
 K_2FeF_6 269
 KGe 989
 K_2GeF_6 216
 KH 971
 KHF_2 146
 KHPO_3NH 579
 KI 290
 KIBr_2 296
 KICl_2 295
 KICl_4 298
 KIF_6 238
 $\text{KI}_3 \cdot \text{H}_2\text{O}$ 294
 KIO_4 325
 K_2MnF_6 264, 269
 KN_3 476
- $\text{K}(\text{NH}_3)_2\text{C}_{12}$ 636
 K_2NbF_7 255
 K_2NiF_6 269
 KO_2 981
 K_2O 974
 KPF_6 196
 $\text{K}_3\text{PO}_4 \cdot 8\text{H}_2\text{O}$ 545
 $\text{K}_4\text{P}_2\text{O}_8$ 562
 K_2PbCl_6 753
 KPbI_3 754
 $\text{KPbI}_3 \cdot 2\text{H}_2\text{O}$ 754
 K_2S 360
 K_2S_2 363
 K_2S_3 364
 K_2S_4 366
 K_2S_5 367
 K_2S_6 368
 KSCN 739
 $\text{K}_2\text{S}_2\text{O}_8$ 392
 $\text{K}_2\text{S}_3\text{O}_6$ 398
 $\text{K}_2\text{S}_4\text{O}_6$ 399
 $\text{K}_2\text{S}_5\text{O}_6 \cdot 1.5\text{H}_2\text{O}$ 401
 $\text{K}_2\text{S}_6\text{O}_6$ 403
 KSO_2F 178
 $\text{K}_2\text{SO}_3(\text{NO})_2$ 504
 K_3Sb 986
 $\text{KSbCl}_6 \cdot \text{H}_2\text{O}$ 612
 K_2Se 421
 K_2SeCl_6 425
 KSi 989
 K_2SnCl_6 731
 K_2TaF_7 256
 K_2Te 441
 K_2TeCl_6 444
 $\text{K}_2(\text{TlCl}_5\text{H}_2\text{O}) \cdot \text{H}_2\text{O}$
 874
 $\text{K}_3(\text{TlCl}_6) \cdot 2\text{H}_2\text{O}$ 873
 K_2VF_6 269
- L**
- LaF_3 246
 Li 956
 Li_3Al 830
 Li_3AlAs_2 831
 $\text{LiAl}(\text{CN})_4$ 833
 LiAlH_4 680, 805
- Li_3AlN_2 828
 Li_3AlP_2 830
 Li_3As 985
 LiBH_4 775
 $\text{LiBH}_4 \cdot \text{O}(\text{C}_2\text{H}_5)_2$ 775
 Li_3Bi 985
 Li_2C_2 987
 Li_2CO_3 950, 987
 LiF 235
 LiGaH_4 842
 LiH 971, 805
 LiN_3 475
 Li_3N 984
 LiNH_2 463
 Li_2NH 464
 $\text{Li}(\text{NH}_3)_2\text{C}_{12}$ 636
 Li_2O 974
 Li_2O_2 975, 979
 LiOH 983
 $\text{LiOH} \cdot \text{H}_2\text{O}$ 983
 Li_3P 985
 Li_3Sb 985
 Li_2Si 991
 Li_4Si 991
 Li_2SiO_3 705
- M**
- Mg 903
 Mg_3As_2 917
 MgBr_2 909
 MgC_2 920
 Mg_2C_3 920
 MgCl_2 905
 $\text{MgCl}_2 \cdot 6\text{H}_2\text{O}$ 906
 $\text{MgCl}_2 \cdot \text{NH}_4\text{Cl} \cdot 6\text{H}_2\text{O}$
 906
 $\text{Mg}(\text{ClO}_4)_2$ 320
 $\text{Mg}(\text{ClO}_4)_2 \cdot 6\text{H}_2\text{O}$ 320
 MgF_2 232
 Mg_2Ge 922
 MgH_2 905
 MgI_2 910
 $\text{Mg}(\text{N}_3)_2$ 917
 Mg_3N_2 916
 MgO 911
 $\text{Mg}(\text{OD})_2$ 137

- Mg(OH)₂ 912
 Mg₃P₂ 917
 MgS 913
 Mg₃Sb₂ 606
 MgSe 915
 Mg₂Si 921
 MgTe 915
 MnF₂ 262
 MnF₃ 263
 MoF₆ 259
- N**
- N₂ 457
 N₃Br 477
 NBr₃ · 6NH₃ 480
 NCl₃ 479
 N₃Cl 476
 (NCl)₃(SO₃)₃ 412
 NCl(SO₃K)₂ 508
 ND₃ 137
 NF₃ 181
 NH₃ 460
¹⁵NH₃ 461
 N₂H₄ 469
 N₂H₄ · H₂O 469
 NH₄AlF₄ 227
 (NH₄)₃AlF₆ 226
 (NH₄)₃AsO₄ · 3H₂O 602
 (NH₄)₃AsS₄ 604
 (NH₄)₂BeF₄ 232
 NH₂Br 480
 (NH₄)₂CS₃ 674
 NH₂Cl 477
 NH₄ClO₃ 313
 NH₄F 183
 NH₄F · HF 183
 (NH₄)₃GaF₆ 228
 NH₄Ga(SO₄)₂ · 12H₂O 854
 NH₄HPO₃NH₂ 584, 588
 (NH₄)₂HPO₃S 584
 NH₄HS 357
 (NH₄)₃InF₆ 229
 NH₄I 289
- NH₂NO₂ 496
 NH₂OH 501
 (NH₃OH)₃AsO₄ 501
 (NH₃OH)₂C₂O₄ 501
 (NH₃OH)Cl 498
 (NH₃OH)HSO₄ 499
 (NH₃OH)₃PO₄ 500, 501
 NH₂OSO₃H 511
 NH₄PF₆ 195
 (NH₄PO₃)_x 580
 NH₄PO₂F₂ 196
 (NH₄)₂P₂O₅(NH₂)₂ 588
 (NH₄)₂PbCl₆ 751
 (NH₄)₂S₅ 369
 NH₃SO₄ 510
 (NH₄)₂S₂O₈ 390
 N₂H₆SO₄ 468
 NH₂SO₃H 508
 NH(SO₃K)₂ 506
 NH₂SO₃K 507
 N₂H₂(SO₃K)₂ 504, 509
 N₂H₂(SO₃NH₄)₂ 509
 N₂H₂(SO₃Py)₂ 510
 (NH₄)₂SbBr₆ 615
 (NH₄)₂SeCl₆ 425
 (NH₄)₂SnCl₆ 731
 (NH₄)₂TeCl₆ 444
 NI₃ · NH₃ 481
 NO 485
 NO₂ 488
 N₂O 484
 N₂O₃ 487
 N₂O₄ 488
 N₂O₅ 489
 NOBF₄ 224
 NOBF₄ · H₂O 224
 NO₂[BF₄] 187
 N₂O₅ · BF₃ 187
 NOBr 513
 NOCl 511
 NO₂Cl 513
 NOClO₄ 320
 NO₂ClO₄ 321
 NOF 184
- NO₂F 186
 NO₃F 187
 (NO)HSO₄ 406
 NOH(SO₃K)₂ 503
 NO₂NH₂ 497
 NO₂NHCOOK 497
 NOSO₂F 186
 NO(SO₃K)₂ 504
 NO(SbCl₆)₂ 612
 NO₂(SbCl₆)₂ 612
 N₂(SO₃K)₂ 510
 N(SO₃K)₃ · 2H₂O 506
 Na 958
 NaAlCl₄ 816
 Na₃As 986
 NaAsH₂ 595
 Na₃AsO₂S₂ · 11H₂O 605
 Na₃AsO₃S · 12H₂O 605
 Na₃AsS₄ · 8H₂O 604
 Na[B(C₆H₅)₄] 803
 NaBF₄ 222
 NaBH₄ 776
 NaBH₄ · 2H₂O 777
 NaBO₂ 791, 793
 NaBO₂ · 0.5H₂O 791
 NaBO₂ · 2H₂O 791
 NaBO₂ · 4H₂O 791
 NaBO₂ · H₂O₂ · 3H₂O 796
 NaBO₃ · 4H₂O 795
 NaB₅O₈ · 5H₂O 795
 Na₂B₄O₇ 794
 Na₂B₄O₇ · 2H₂O 794
 Na₂B₄O₇ · 4H₂O 794
 Na₂B₄O₇ · 5H₂O 793
 Na₂B₄O₇ · 10H₂O 793
 Na₃BO₃ 790
 Na₄BeO₃ 895
 Na₃Bi 986
 NaBiO₃ 627
 NaBiO₃ · nH₂O 628
 NaBrO · 5H₂O 310
 Na₂C₂ 987
 Na₂CO₃ 988
 NaClO 309

- $\text{NaClO} \cdot 5\text{H}_2\text{O}$ 309
 $\text{NaClO}_2 \cdot 3\text{H}_2\text{O}$ 312
 NaF 235
 NaGe 989
 NaGeH_3 714
 Na_2GeH_2 714
 NaH 971
 $\text{NaH}_2\text{AsO}_4 \cdot \text{H}_2\text{O}$ 602
 $\text{NaHB}(\text{OCH}_3)_3$ 777
 $\text{Na}_3\text{H}_2\text{IO}_6$ 323
 $\text{Na}_3\text{HP}_2\text{O}_7$ 548
 $\text{NaH}_2\text{PO}_4 \cdot 2\text{H}_2\text{O}$ 544
 $\text{Na}_2\text{H}_2\text{P}_2\text{O}_6 \cdot 6\text{H}_2\text{O}$
 560
 NaHS 357
 NaHSe 419
 $\text{Na}_2\text{H}_4\text{TeO}_6$ 453
 $\text{Na}_2\text{H}_4\text{TeO}_6 \cdot 3\text{H}_2\text{O}$
 454
 NaIO_3 323
 NaIO_4 323, 324
 $\text{NaIO}_4 \cdot 3\text{H}_2\text{O}$ 324
 NaN_3 474
 Na^{10}N_3 466
 NaNH_2 465
 $\text{Na}^{15}\text{NH}_2$ 466
 $\text{Na}(\text{NH}_3)_2\text{C}_{12}$ 636
 NaNO 514
 Na_2NO_2 515
 $\text{Na}_2\text{N}_2\text{O}_3$ 517
 $\text{Na}_2\text{N}_2\text{O}_2 \cdot 9\text{H}_2\text{O}$ 495
 NaO_2 980
 Na_2O 974
 Na_2O_2 979
 NaOD 121
 Na_3P 986
 NaPH_2 530
 $\text{NaPH}_2 \cdot 2\text{NH}_3$ 530
 Na_2PH 530
 $(\text{NaPO}_3)_x$ 549
 $(\text{NaPO}_3)_y$ 550
 $(\text{NaPO}_3)_z$ 551
 $\text{Na}_3\text{P}_3\text{O}_9 \cdot 6\text{H}_2\text{O}$ 552
 $\text{Na}_4\text{P}_2\text{O}_6 \cdot 10\text{H}_2\text{O}$ 561
 $\text{Na}_4\text{P}_4\text{O}_{12} \cdot n\text{H}_2\text{O}$ 553
 $\text{Na}_5\text{P}_3\text{O}_{10}$ 547
 $\text{Na}_5\text{P}_3\text{O}_{10} \cdot 6\text{H}_2\text{O}$ 547
 $\text{Na}_6\text{P}_4\text{O}_{13}$ 548
 $\text{Na}_6\text{P}_4\text{O}_{13} \cdot \text{aq}$ 548
 $(\text{Na}_2\text{PO}_3)_3\text{N}$ 590
 $\text{Na}_2\text{PO}_3\text{NH}_2$ 588
 $\text{Na}_2\text{PO}_3\text{NH}_2 \cdot 6\text{H}_2\text{O}$
 581
 $\text{Na}_4\text{P}_2\text{O}_6\text{NH}$ 589
 $\text{Na}_4\text{P}_2\text{O}_6\text{NH} \cdot 10\text{H}_2\text{O}$
 589
 $\text{Na}_3\text{POS}_3 \cdot 11\text{H}_2\text{O}$
 571
 $\text{Na}_3\text{PO}_2\text{S}_2 \cdot 11\text{H}_2\text{O}$
 570
 $\text{Na}_3\text{PO}_3\text{S} \cdot 12\text{H}_2\text{O}$
 569
 $\text{NaPOS}(\text{NH}_2)_2$ 589
 $\text{Na}_3\text{PS}_4 \cdot 8\text{H}_2\text{O}$ 572
 Na_2PbO_3 758
 Na_4PbO_4 759
 Na_2S 358
 Na_2S_2 361
 Na_2S_4 365
 Na_2S_5 367
 $\text{Na}_2\text{S}_7\text{O}_4 \cdot 2\text{H}_2\text{O}$ 393
 $\text{Na}_2\text{S}_7\text{O}_6 \cdot 2\text{H}_2\text{O}$ 395
 Na_3Sb 986
 $\text{Na}_3\text{SbS}_4 \cdot 9\text{H}_2\text{O}$ 619
 Na_2Se 421
 Na_2Se_2 421 f
 $\text{Na}_2\text{SeO}_3 \cdot 5\text{H}_2\text{O}$ 431
 Na_2SeO_4 433 f
 $\text{Na}_2\text{SeS}_4\text{O}_6 \cdot 3\text{H}_2\text{O}$
 434
 NaSi 989
 Na_2SiO_3 704
 $\text{Na}_2\text{SiO}_3 \cdot 9\text{H}_2\text{O}$ 704
 $\text{Na}_2\text{Si}_2\text{O}_5$ 704
 $\text{Na}_2\text{SnS}_3 \cdot 8\text{H}_2\text{O}$ 742
 Na_4SnO_4 739
 $\text{Na}_4\text{SnS}_4 \cdot 18\text{H}_2\text{O}$ 743
 Na_2Te 441
 Na_2Te_2 442
 Na_2TeO_3 449
 Na_2TeO_4 449, 453
 Na_6TeO_6 453
 $\text{Na}_6\text{TeO}_6 \cdot 2\text{H}_2\text{O}$ 453
 $\text{Na}_2\text{TeS}_4\text{O}_6 \cdot 2\text{H}_2\text{O}$ 454
 NbF_5 254
 Ne 82
 NiF_2 269
- O**
- O_2 334
 O_3 337
 OF_2 163
 O_2F_2 162
 $[\text{OS}(\text{NCl})_3]$ 412
- P**
- P 518
 PCl_2F 191
 PCl_2F_3 192
 $\text{PCl}_4 \cdot \text{PF}_6$ 193
 PF_3 179, 189
 PF_5 190, 194
 PH_3 525
 P_2H_4 525
 PH_4I 531
 PI_3 540
 P_2I_4 539
 P_3N_5 574
 $(\text{PNBr})_n$ 578
 $(\text{PNCl})_n$ 575
 $(\text{PNF})_3$ 194
 $(\text{PNF})_4$ 194
 P_2O_5 541, 825
 POBr_3 534
 $\text{P}_2\text{O}_3\text{Cl}_4$ 536
 $\text{P}_4\text{O}_4\text{Cl}_{10}$ 536
 $\text{POCl}(\text{OC}_6\text{H}_5)_2$ 579
 $\text{POCl}_2(\text{OC}_6\text{H}_5)$ 582
 POF_3 179, 193
 $\text{PO}(\text{NH}_2)_3$ 584
 $\text{P}_2\text{O}_3(\text{NH}_2)_4$ 588
 $[\text{PO}(\text{NH})\text{NH}_2]_n$ 588
 $[\text{PO}(\text{NH}_2)_2]\text{NH}$ 587
 $[\text{PO}(\text{NH}_2)_2\text{NH}]_2\text{PONH}_2$
 587
 $\text{PONH}_2(\text{OC}_6\text{H}_5)_2$ 577
 $\text{PO}(\text{NH}_2)_2(\text{OC}_6\text{H}_5)$
 582
 P_2S_5 567

- $P_2S_5 \cdot 7NH_3$ 574
 P_4S_3 563
 P_4S_5 565
 P_4S_7 566
 P_4S_{10} 567
 $PSBr_3$ 535
 $PSBr_3 \cdot H_2O$ 536
 $PSCl_3$ 532
 $PS(NH_2)_3$ 587
 P_4Se_3 573
 Pb 748
 $Pb(CH_3)_4$ 763
 $Pb(C_2H_5)_4$ 765
 $Pb(CH_3COO)_4$ 767
 $PbCO_3$ 766
 $2PbCO_3 \cdot Pb(OH)_2$
 767
 $PbCl_4$ 750
 PbF_2 218
 PbF_4 219
 $Pb(N_2)_2$ 763
 PbO_2 757
 Pb_3O_4 755
 $Pb_2P_2O_6$ 558
 PbS 760
 $Pb(SCN)_2$ 769
 $Pb(SO_4)_2$ 761
 $PbSiO_3$ 705
- R**
- Rb 958
 RbC_8 635
 RbC_{24} 635
 RbC_{36} 635
 RbC_{48} 635
 Rb_2CO_3 987
 $RbCl$ 951
 $RbGe$ 989
 RbH 971
 RbN_3 476
 $Rb(NH_2)_2C_{12}$ 637
 RbO_2 981
 Rb_2O 974
 $RbOH$ 983
 Rb_2S_2 369
 Rb_2S_3 369
- Rb_2S_5 369
 Rb_2SeCl_6 425
 $RbSi$ 989
 Rb_2TeCl_6 444
 $Rb(TlBr_4) \cdot H_2O$ 876
 $Rb_3(TlBr_6) \cdot \frac{8}{7}H_2O$
 876
 ReF_6 264
- S**
- S 341
 S_2Br_2 377
 S_3Br_2 379
 S_4Br_2 379
 S_5Br_2 379
 S_6Br_2 379
 S_7Br_2 379
 S_8Br_2 379
 $(SCN)_2$ 671
 SCl_2 370
 SCl_4 376
 S_2Cl_2 371
 S_3Cl_2 373
 S_4Cl_2 372, 375
 S_5Cl_2 372, 375
 S_6Cl_2 372, 375
 S_7Cl_2 372, 376
 S_8Cl_2 372, 376
 SF_4 168
 SF_6 169
 S_2N_2 409
 S_4N_2 408
 S_4N_4 406
 $S_4(NH)_4$ 411
 S_7NH 411
 $S_3N_2O_2$ 413
 $S_3N_2O_5$ 414
 SO 379
 $(SO_3-d)_x$ 382
 S_2O 380
 S_2O_3 380
 $SOBr_2$ 387
 SO_2BrF 176
 $SOCl_2$ 382
 SO_2Cl_2 383
 $S_2O_5Cl_2$ 386
- $SOCIF$ 174
 SO_2ClF 175
 SOF_2 170, 179
 SOF_4 171
 SO_2F_2 173
 $S_3O_8F_2$ 174
 $(SO_2N)_3Ag_3 \cdot 3H_2O$
 483
 $SONH$ 480
 $(SO_2NH)_3$ 483
 $SO_2(NH)_2$ 482
 $SO_2(NHAg)_2$ 483
 Sb 606
 $SbBr_3$ 613
 $SbCl_3$ 608
 $SbCl_5$ 610
 $SbCl_5 \cdot H_2O$ 610
 $SbCl_5 \cdot 4H_2O$ 610
 $SbCl_2F_3$ 200
 SbF_3 199
 SbF_5 143, 200
 SbH_3 606
 SbI_3 614
 Sb_2O_3 615
 Sb_2O_4 618
 Sb_2O_5 616
 $Sb_2O_5 \cdot (H_2O)_x$ 617
 $SbOCl$ 611
 $Sb_4O_5Cl_2$ 611
 $(SbO)_2SO_4$ 619
 $Sb_2(SO_4)_3$ 618
 ScF_3 245
 Se 415
 $SeBr_4$ 427
 Se_2Br_2 426
 $SeCl_4$ 423
 Se_2Cl_2 422
 SeF_4 180
 SeF_6 179
 Se_4N_4 435
 SeO_2 428
 $SeOCl_2$ 429
 $SeO(OC_2H_5)_2$ 435
 $SeSO_3$ 435
 Si 676
 $SiBr_2$ 687
 $SiBr_4$ 686, 688

Si_2Br_6 688
 $\text{Si}(\text{CH}_3\text{COO})_4$ 701
 SiCH_3Cl_3 695
 $\text{Si}(\text{CH}_3)_2\text{Cl}_2$ 694, 695
 SiCl_4 680, 682
 Si_2Cl_6 680
 Si_3Cl_8 684
 $\text{Si}_4\text{Cl}_{10}$ 684
 $\text{Si}_5\text{Cl}_{12}$ 684
 $\text{Si}_6\text{Cl}_{14}$ 684
 $\text{Si}_{10}\text{Cl}_{22}$ 684
 $\text{Si}_{10}\text{Cl}_{20}\text{H}_2$ 685
 SiF_4 212
 $(\text{SiH})_x$ 681
 $(\text{SiH}_2)_x$ 681
 SiH_4 679, 680
 Si_2H_6 679
 Si_3H_8 679
 SiHBr_3 692
 SiH_2Br_2 694
 SiHCl_3 691
 SiH_2Cl_2 691
 SiH_3Cl 691
 SiHF_3 214
 SiI_4 689
 Si_2I_6 690
 $\text{Si}(\text{N}_3)_4$ 476
 $\text{Si}(\text{NCO})_4$ 702
 SiO 696
 Si_2O_3 700
 $\text{Si}(\text{OCH}_3)_4$ 702
 $\text{Si}(\text{OC}_2\text{H}_5)_4$ 702
 $\text{Si}(\text{OCN})_4$ 702
 Si_2OCl_6 696
 $\text{Si}_3\text{O}_2\text{Cl}_8$ 696
 $\text{Si}_4\text{O}_3\text{Cl}_{10}$ 696
 $\text{Si}_4\text{O}_4\text{Cl}_8$ 695
 $\text{Si}_5\text{O}_4\text{Cl}_{12}$ 696
 $\text{Si}_6\text{O}_5\text{Cl}_{14}$ 696
 $\text{Si}_7\text{O}_6\text{Cl}_{16}$ 696
 SiS 700
 SiS_2 700
 Sn 727
 SnBr_2 732
 SnBr_4 733
 $\text{Sn}(\text{CH}_3)_4$ 744
 $\text{Sn}(\text{C}_2\text{H}_5)_4$ 746

$\text{Sn}(\text{CH}_3\text{COO})_4$ 747
 SnCl_2 728
 SnCl_4 729
 SnF_2 217
 SnF_4 217
 SnI_2 734
 SnI_4 735
 SnO 736
 SnO_2 738
 $\text{SnO}_2 \cdot n\text{H}_2\text{O}$ 737
 SnS 739
 SnS_2 741
 $\text{Sn}(\text{SO}_4)_2 \cdot 2\text{H}_2\text{O}$ 744
 Sr 922
 SrBr_2 930
 SrCO_3 931
 SrCl_2 930
 $\text{Sr}(\text{ClO}_4)_2$ 320
 $\text{Sr}(\text{ClO}_4)_2 \cdot 4\text{H}_2\text{O}$ 320
 SrF_2 234
 SrH_2 929
 SrI_2 930
 $\text{Sr}(\text{N}_3)_2$ 941
 Sr_3N_2 940
 SrO 932
 SrO_2 936
 $\text{SrO}_2 \cdot 8\text{H}_2\text{O}$ 935
 $\text{Sr}(\text{OH})_2 \cdot 8\text{H}_2\text{O}$ 935
 SrS 938
 SrSe 939
 SrSeO_3 939
 SrSeO_4 939
 SrSi 947
 SrTe 940

T

TaF_5 255
 Te 437
 TeBr_4 445
 TeCl_4 442
 TeF_6 180
 TeI_4 447
 TeO_2 447
 TeO_3 450
 $\text{Te}_2\text{O}_3(\text{OH})\text{NO}_3$ 437, 447

TeSO_3 455
 TiF_3 248
 TiF_4 250
 TiH_2 114
 Tl 867
 TlBr 869
 $\text{TlBr}_3 \cdot 4\text{H}_2\text{O}$ 874
 Tl_2CO_3 884
 TlCl 869
 TlCl_3 870
 $\text{TlCl}_3 \cdot 4\text{H}_2\text{O}$ 870
 TlF 230
 TlF_3 230
 TlI 869
 $\text{TlI} \cdot \text{I}_2$ 876
 TlI_3 876
 Tl_3N 883
 TlNO_3 883
 Tl_2O 877
 Tl_2O_3 879
 $\text{Tl}_2\text{O}_3 \cdot x\text{H}_2\text{O}$ 879
 TlOH 877
 $\text{Tl}(\text{OH})\text{SO}_4 \cdot 2\text{H}_2\text{O}$ 882
 $\text{Tl}_2(\text{OOC})_2\text{CH}_2$ 884
 TlOOCH 884
 Tl_2S 880
 $\text{Tl}_2\text{S} \cdot \text{Tl}_2\text{S}_3$ 880
 Tl_2SO_4 881
 $\text{Tl}_2\text{Se} \cdot \text{Tl}_2\text{Se}_3$ 881
 Tl_2TeCl_6 444
 $\text{Tl}(\text{TlBr}_4)$ 875
 $\text{Tl}_3(\text{TlBr}_6)$ 875
 $\text{Tl}(\text{TlCl}_4)$ 872
 $\text{Tl}_3(\text{TlCl}_6)$ 873

U

UD_3 123
 UF_4 261
 UF_6 262
 UH_3 113

V

VF_3 252
 VF_4 252
 VF_5 253

FORMULA INDEX

W WF_6 260**Y** YF_3 246**Z** Zn_3As_2 594 ZnF_2 242 ZnS_2O_4 394 ZrF_4 251

PREPARED IN COLLABORATION WITH

M. Baudler, Cologne	R. Klement, Munich
H. J. Becher, Stuttgart	W. Kwasnik, Leverkusen
E. Dönges, Gersthofen	H. Lux, Munich
P. Ehrlich, Giessen	W. Rüdorff, Tübingen
F. Fehér, Cologne	H. Sauer, Hofheim/Ts.
O. Glemser, Göttingen	P. W. Schenk, Berlin
H. Grube, Hanau	M. Schmeisser, Aachen
B. Grüttner, Wiesbaden	R. Scholder, Karlsruhe
F. Hein, Jena	F. Seel, Stuttgart
S. Herzog, Greifswald	F. Wagenknecht, Sprend- lingen/Offenbach am Main
U. Hofmann, Heidelberg	R. Wagner, Stuttgart
G. Jander, Berlin	H. v. Wartenberg, Göttingen
R. Juza, Kiel	K. Wetzell, Leipzig

HANDBOOK OF PREPARATIVE INORGANIC CHEMISTRY

VOLUME 2 • SECOND EDITION

Edited by GEORG BRAUER

PROFESSOR OF INORGANIC CHEMISTRY
UNIVERSITY OF FREIBURG

TRANSLATED BY SCRIPTA TECHNICA, INC.

TRANSLATION EDITOR
PAUL G. STECHER

MERCK SHARP & DOHME RESEARCH LABORATORIES

1965



ACADEMIC PRESS • New York • London

COPYRIGHT© 1965 BY ACADEMIC PRESS INC.

ALL RIGHTS RESERVED

NO PART OF THIS BOOK MAY BE REPRODUCED IN ANY FORM
BY PHOTOSTAT, MICROFILM, OR ANY OTHER MEANS,
WITHOUT WRITTEN PERMISSION FROM THE PUBLISHERS

ACADEMIC PRESS INC.

111 FIFTH AVENUE
NEW YORK, NEW YORK 10003

United Kingdom Edition

Published by
ACADEMIC PRESS INC. (LONDON) LTD.
BERKELEY SQUARE HOUSE, LONDON W. 1

Library of Congress Catalog Card Number: 63-14307

Translated from the German

HANDBUCH DER PRÄPARATIVEN ANORGANISCHEN CHEMIE
BD. 2, pp. 885-1611, 1962

Published by
FERDINAND ENKE VERLAG, STUTTGART

PRINTED IN THE UNITED STATES OF AMERICA

Translation Editor's Preface

The English version of Volume II of Brauer's "Handbook" follows the path of the very well received translation of Volume I. Again, some of the material and particularly the bibliography has been corrected and brought up to date. The nomenclature has been revised where necessary, with the Stock and the Stock-Werner systems (the practice of using Roman numerals to define oxidation states of atoms) adopted as much as possible. This conforms with current I. U. P. A. C. and Chemical Abstracts practice [for details of this, see Robert C. Brasted, *J. Chem. Education* 35, 136 (1948)]. The references to laboratory equipment and techniques reflect current U. S. usage, but useful European methods have been retained.

It is hoped that this volume will be as well received as the preceding one. Comments from users are invited to help improve future editions.

Paul G. Stecher

Rahway, N. J.
May 1965

Contents

TRANSLATION EDITOR'S PREFACE	V
--	---

Part II (continued)

Elements and Compounds

SECTION 19. COPPER, SILVER, GOLD	1003
Copper (Pure Metal)	1003
Colloidal Copper	1003
Copper Hydride CuH	1004
Copper (I) Chloride CuCl	1005
Copper (I) Bromide CuBr	1006
Copper (I) Iodide CuI	1007
Copper (II) Chloride CuCl_2	1008
Copper (II) Bromide CuBr_2	1009
Copper Oxychloride $\text{CuCl}_2 \cdot \text{Cu(OH)}_2$	1010
Copper (I) Oxide Cu_2O	1011
Copper (II) Oxide CuO	1012
Copper (II) Hydroxide Cu(OH)_2	1013
Potassium Cuprate (III) KCuO_2	1014
Schweizer's Reagent	1016
Copper (I) Sulfide Cu_2S	1016
Copper (II) Sulfide CuS	1017
Copper (I) Selenide Cu_2Se	1019
Copper (I) Telluride Cu_2Te	1019
Copper (I) Sulfate Cu_2SO_4	1020
Tetraamminecopper (II) Sulfate $[\text{Cu(NH}_3)_4]\text{SO}_4 \cdot \text{H}_2\text{O}$	1021
Copper (I) Nitride Cu_3N	1021
Copper (II) Azide $\text{Cu(N}_3)_2$	1022
Copper Phosphide Cu_3P	1023
Copper Diphosphide CuP_2	1024
Basic Copper Carbonates $\text{CuCO}_3 \cdot \text{Cu(OH)}_2$ (Green Cupric Carbonate)	1024
$2 \text{CuCO}_3 \cdot \text{Cu(OH)}_2$ (Blue Cupric Carbonate)	1025
Copper (I) Acetylide $\text{Cu}_2\text{C}_2 \cdot \text{H}_2\text{O}$	1026
Paris Green (Copper Acetoarsenite)	1027
Fehling's Solution	1027
Very Pure Silver	1028
Silver Powder	1029
Silver from Residues	1029
Silver Mirrors	1031
Colloidal Silver	1034
Silver Iodide AgI	1035
Silver Chlorate AgClO_3	1037

Silver Oxide Ag_2O	1037
Silver Peroxide Ag_2O_2	1038
Sodium Orthoargentite Na_3AgO_2	1039
Silver (I) Sulfide Ag_2S	1039
Silver (I) Selenide Ag_3Se	1041
Silver (I) Telluride Ag_2Te	1042
Silver Sulfate Ag_2SO_4	1042
Silver Sulfite Ag_2SO_3	1043
Silver Amide AgNH_2	1043
Silver Azide AgN_3	1045
Silver Nitride Ag_3N	1046
Silver Acetylde Ag_2C_2	1047
Silver Cyanamide Ag_2CN_2	1047
Silver Carbonate Ag_2CO_3	1048
Silver Nitrite AgNO_2	1048
Silver Tartrate $\text{Ag}_2\text{C}_4\text{H}_4\text{O}_6$	1049
o-Phenanthrolinesilver (II) Persulfate $[\text{Ag phen}_2]\text{S}_2\text{O}_8$.	1050
Tris- α, α' -dipyridylsilver (II) Perchlorate [$\text{Ag}(\text{dipyr})_3](\text{ClO}_4)_2$	1050
Very Pure Gold	1052
Colloidal Gold	1053
Gold from Residues	1054
Gold (I) Chloride AuCl	1055
Gold (III) Chloride AuCl_3	1056
Hydrogen Tetrachloroaurate (III) $\text{HAuCl}_4 \cdot 4 \text{H}_2\text{O}$	1057
Potassium Tetrachloroaurate (III) $\text{KAuCl}_4 \cdot \frac{1}{2} \text{H}_2\text{O}$. .	1058
Gold (III) Oxide Au_2O_3	1059
Gold (III) Hydroxide $\text{Au}(\text{OH})_3$	1060
Potassium Aurate $\text{KAuO}_2 \cdot 3 \text{H}_2\text{O}$	1061
Gold (I) Sulfide Au_2S	1061
Gold (II) Sulfide AuS	1062
Gold (III) Sulfide Au_2S_3	1063
Gold (I) Acetylde Au_2C_2	1063
Gold (I) Cyanide AuCN	1064
Potassium Dicyanoaurate (I) $\text{K}[\text{Au}(\text{CN})_2]$	1065
SECTION 20. ZINC, CADMIUM, MERCURY.	1067
Zinc Zn	1067
Zinc Hydride ZnH_2	1069
Zinc Chloride ZnCl_2	1070
Zinc Hydroxychloride $\text{Zn}(\text{OH})\text{Cl}$	1071
Ammonium Tetrachlorozincate $(\text{NH}_4)_2\text{ZnCl}_4$	1072
Zinc Bromide ZnBr_2	1072
Zinc Iodide ZnI_2	1073
Zinc Hydroxide (crystalline) $\epsilon\text{-Zn}(\text{OH})_2$	1074
Zinc Sulfide ZnS	1075
Zinc Formaldehydesulfoxylate $\text{Zn}(\text{SO}_2 \cdot \text{CH}_2\text{OH})_2$	1076

Ammonium Zinc Sulfate $(\text{NH}_4)_2\text{Zn}(\text{SO}_4)_2 \cdot 6\text{H}_2\text{O}$	1077
Zinc Selenide ZnSe	1078
Zinc Amide $\text{Zn}(\text{NH}_2)_2$	1079
Zinc Nitride Zn_3N_2	1080
Zinc Phosphides Zn_3P_2 , ZnP_2	1080
Zinc Phosphate $\text{Zn}_3(\text{PO}_4)_2 \cdot 4\text{H}_2\text{O}$	1081
Zinc Hydroxyphosphate $\text{Zn}_2(\text{OH})\text{PO}_4$	1082
Zinc Arsenides Zn_3As_2 , ZnAs_2	1083
Zinc Thioantimonate $\text{Zn}_3(\text{SbS}_4)_2$	1083
Diethylzinc $\text{Zn}(\text{C}_2\text{H}_5)_2$	1084
Zinc Carbonate ZnCO_3	1086
Zinc Acetate $\text{Zn}(\text{CH}_3\text{COO})_2$	1087
Zinc Cyanide $\text{Zn}(\text{CN})_2$	1087
Potassium Tetracyanozincate $\text{K}_2\text{Zn}(\text{CN})_4$	1088
Zinc Silicate Zn_2SiO_4	1089
Zinc Fluorosilicate $\text{ZnSiF}_6 \cdot 6\text{H}_2\text{O}$	1090
Zinc Ferrate (III) ZnFe_2O_4	1090
Rinmann's Green	1092
Cadmium (needles) Cd	1092
Cadmium Chloride CdCl_2	1093
Cadmium Hydroxychloride $\text{Cd}(\text{OH})\text{Cl}$	1094
Potassium Cadmium Chloride $\text{CdCl}_2 \cdot \text{KCl} \cdot \text{H}_2\text{O}$	1095
Cadmium Bromide CdBr_2	1096
Cadmium Iodide CdI_2	1096
Cadmium Hydroxide $\text{Cd}(\text{OH})_2$	1097
Cadmium Sulfide CdS	1098
Cadmium Nitride Cd_3N_2	1100
Cadmium Amide $\text{Cd}(\text{NH}_2)_2$	1100
Cadmium Phosphides Cd_3P_2 , CdP_2 , CdP_4	1101
Cadmium Arsenides Cd_3As_2 , CdAs_2	1103
Diethylcadmium $\text{Cd}(\text{C}_2\text{H}_5)_2$	1103
Cadmium Carbonate CdCO_3	1104
Cadmium Acetate $\text{Cd}(\text{CH}_3\text{COO})_2$	1105
Cadmium Cyanide $\text{Cd}(\text{CN})_2$	1105
Potassium Tetracyanocadmiate $\text{K}_2\text{Cd}(\text{CN})_4$	1106
Cadmium Thiocyanate $\text{Cd}(\text{SCN})_2$	1106
Cadmium Silicate Cd_2SiO_4	1107
Cadmium Ferrate (III) CdFe_2O_4	1107
Mercury (II) Oxychloride $\text{HgCl}_2 \cdot 4\text{HgO}$	1108
Mercury (II) Bromide HgBr_2	1109
Potassium Triiodomercurate (II) $\text{KHgI}_3 \cdot \text{H}_2\text{O}$	1110
Copper (I) Tetraiodomercurate (II) Cu_2HgI_4	1110
Mercury (II) Sulfide HgS	1111
Mercury (II) Selenide HgSe	1113
Mercury (II) Amide Chloride HgNH_2Cl	1114
Diamminomercury (II) Dichloride $\text{HgCl}_2 \cdot 2\text{NH}_3$	1114
Mercury (II) Iminobromide $\text{Hg}_2(\text{NH})\text{Br}_2$	1115

Millon's Base $\text{NHg}_2\text{OH} \cdot x\text{H}_2\text{O}$	1116
Bromide of Millon's Base NHg_2Br	1117
Mercury (I) Thionitrosylate $[\text{Hg}_2(\text{NS})_2]_x$	1117
Mercury (II) Thionitrosylate $[\text{Hg}(\text{NS})_2]_x$	1118
Diethylmercury $\text{Hg}(\text{C}_2\text{H}_5)_2$	1118
Mercury (I) Acetate $\text{Hg}_2(\text{CH}_3\text{COO})_2$	1120
Mercury (II) Acetate $\text{Hg}(\text{CH}_3\text{COO})_2$	1120
Mercury (II) Cyanide $\text{Hg}(\text{CN})_2$	1121
Potassium Tetracyanomercurate (II) $\text{K}_2\text{Hg}(\text{CN})_4$	1122
Mercury (I) Thiocyanate $\text{Hg}_2(\text{SCN})_2$	1122
Mercury (II) Thiocyanate $\text{Hg}(\text{SCN})_2$	1123
Potassium Tetrathiocyanomercurate (II) $\text{K}_2\text{Hg}(\text{SCN})_4$	1124
SECTION 21. SCANDIUM, YTTRIUM, RARE EARTHS	1125
Pure Scandium Compounds	1125
Treatment of Monazite Sand	1127
Treatment of Gadolinite	1129
Pure La, Pr and Nd Compounds from Cerium Earths by Ion Exchange	1131
Pure Cerium Compounds	1132
Pure Samarium Compounds	1135
Pure Europium Compounds	1136
Pure Ytterbium Compounds	1138
Metallic Rare Earths	1141
Rare Earth Trichlorides LnCl_3 (anhydrous)	1146
Rare Earth Tribromides LnBr_3 (anhydrous)	1148
Rare Earth Triiodides LnI_3 (anhydrous)	1149
Rare Earth Dihalides LnX_2 (anhydrous)	1150
Cerium (III) Oxide Ce_2O_3	1151
Praseodymium (IV) Oxide PrO_2	1151
Rare Earth Hydroxides $\text{Ln}(\text{OH})_3$ (crystalline)	1152
Lanthanum Sulfide La_2S_3	1153
Lanthanum Selenide La_2Se_3 , La_2Se_4	1154
La, Ce, Pr and Nd Monochalcogenides LnS , LnSe , LnTe	1155
Europium (II) Chalcogenides EuS , EuSe , EuTe	1155
Rare Earth Sulfates $\text{Ln}_2(\text{SO}_4)_3 \cdot n\text{H}_2\text{O}$	1156
Rare Earth Nitrides LnN	1157
Rare Earth Nitrates $\text{Ln}(\text{NO}_3)_3$ (anhydrous)	1158
Rare Earth Cyclopentadienides $\text{Ln}(\text{C}_5\text{H}_5)_3$	1159
SECTION 22. TITANIUM, ZIRCONIUM, HAFNIUM, THORIUM	1161
Titanium Ti	1161
Zirconium, Hafnium Zr, Hf	1172
Thorium Th	1174
Separation of Zirconium and Hafnium	1179
Titanium, Zirconium and Thorium Hydrides	1184
Titanium (II) Chloride, Bromide and Iodide TiCl_2 , TiBr_2 , TiI_2	1185

Titanium (III) Chloride, Bromide and Iodide $TiCl_3$, $TiCl_3 \cdot 6 H_2O$; $TiBr_3$, $TiBr_3 \cdot 6 H_2O$; TiI_3	1187
Titanium (IV) Chloride $TiCl_4$	1195
Ammonium Hexachlorotitanate $(NH_4)_2[TiCl_6]$	1199
Titanium (IV) Bromide $TiBr_4$	1201
Zirconium (IV), Hafnium (IV) and Thorium (IV) Chlorides and Bromides $ZrCl_4$, $HfCl_4$, $ThCl_4$; $ZrBr_4$, $HfBr_4$, $ThBr_4$	1203
Thorium Chloride $ThCl_4 \cdot 8 H_2O$	1204
Titanium (IV), Zirconium (IV) and Thorium (IV) Iodides TiI_4 (ZrI_4 , ThI_4)	1205
Titanium (III) Oxychloride $TiOCl$	1209
Titanium (IV) Oxychloride $TiOCl_2$	1209
Zirconium Oxychloride $ZrOCl_2 \cdot 8 H_2O$	1210
Hafnium Oxychloride	1213
Lower Titanium Oxides TiO , Ti_2O_3	1214
Titanium (IV) Oxide TiO_2	1216
Titanium (IV) Oxide Hydrate $TiO_2 \cdot n H_2O$	1218
Peroxo-titanic Acid H_4TiO_5	1219
Zirconium (IV) Oxide ZrO_2	1220
Hafnium (IV) Oxide HfO_2	1221
Thorium (IV) Oxide ThO_2	1221
Titanium, Zirconium and Thorium Sulfides TiS_3 , TiS_2 , $TiS_{<2}$	1222
Zirconium Sulfides	1226
Thorium Sulfides	1226
Titanium (III) Sulfate $Ti_2(SO_4)_3$	1226
Titanoxy Sulfate $TiOSO_4$	1228
Zirconium Sulfates	1231
Purification of Zr Salts via the Tetrahydrate	1232
Titanium, Zirconium and Hafnium Nitrides TiN , ZrN , HfN	1233
Thorium Nitride Th_3N_4	1236
Titanium Tetranitrate $Ti(NO_3)_4$	1237
Thorium Nitrate $Th(NO_3)_4 \cdot n H_2O$	1238
Titanium Oxonitrate, Zirconium Oxonitrate $TiO(NO_3)_2$, $ZrO(NO_3)_2$	1241
Titanium Phosphide, Zirconium Phosphides, Thorium Phosphide TiP , ZrP_2 , ZrP , Th_3P_4	1241
Zirconium and Hafnium Phosphates	1244
Titanium, Zirconium and Hafnium Carbides TiC , ZrC , HfC	1245
Thorium Carbides ThC , ThC_2	1248
Titanium, Zirconium and Thorium Silicides $TiSi_2$, $ZrSi_2$, $ThSi_2$	1249
SECTION 23. VANADIUM, NIOBIUM, TANTALUM	1252
Vanadium V	1252

Vanadium (II) Chloride VCl_2	1255
Vanadium (III) Chloride VCl_3 , $VCl_3 \cdot 6 H_2O$	1256
Vanadium (IV) Chloride VCl_4	1259
Vanadium (II) Bromide VBr_2	1260
Vanadium (III) Bromide VBr_3	1260
Vanadium (II) Iodide VI_2	1261
Vanadium (III) Iodide VI_3	1262
Vanadium Oxychloride $VOCl$	1262
Vanadium Oxydichloride $VOCl_2$	1263
Vanadium Oxytrichloride $VOCl_3$	1264
Vanadium Dioxychloride VO_2Cl	1265
Lower Vanadium Oxides	1266
Vanadium (III) Hydroxide $V(OH)_3$	1268
Vanadium (V) Oxide V_2O_5	1270
Ammonium Metavanadate NH_4VO_3	1272
Alkali Vanadates	1273
Vanadium Sulfides	1274
Vanadium Selenides	1276
Vanadium (II) Sulfate $VSO_4 \cdot 6 H_2O$	1277
Hydrogen Disulfatovanadate (III) $HV(SO_4)_2 \cdot 4 H_2O$	1282
Ammonium and Potassium Disulfatovanadate (III) $NH_4V(SO_4)_2$, $KV(SO_4)_2$	1283
Vanadium (IV) Oxsulfate (Vanadyl Sulfate) $VOSO_4$	1285
Vanadium Nitrides	1286
Vanadium Phosphides VP_2 , VP , $VP_{<1}$	1287
Vanadium Carbides VC , V_2C	1288
Dibenzenevanadium (0) $V(C_6H_6)_2$	1289
Potassium Hexathiocyanatovanadate (III) $K_3V(SCN)_6$	1291
Niobium Metal, Tantalum Metal	1292
Niobium, Niobium and Tantalum Hydrides	1295
Niobium (II) Chloride $NbCl_2$	1296
Niobium (III) Chloride $NbCl_3$	1297
Niobium (IV) Chloride $NbCl_4$	1299
Tantalum (IV) Chloride $TaCl_4$	1301
Niobium (V) and Tantalum (V) Chlorides $NbCl_5$, $TaCl_5$	1302
Niobium Oxytrichloride $NbOCl_3$	1307
Niobium (III) Bromide $NbBr_3$	1309
Tantalum (IV) Bromide $TaBr_4$	1310
Niobium (V) and Tantalum (V) Bromides $NbBr_5$, $TaBr_5$	1311
Niobium Oxytribromide $NbOBr_3$	1313
Niobium (IV), Niobium (III) and Niobium (II) Iodides NbI_4 , NbI_3 , NbI_2	1314
Niobium (V) Iodide NbI_5	1315
Tantalum (V) Iodide TaI_5	1316
Niobium (II) Oxide NbO	1317
Niobium (IV) Oxide NbO_2	1318

Niodium (V) and Tantalum (V) Oxides Nb_2O_5 , Ta_2O_5 . . .	1318
Alkali Niobates and Tantalates	1323
Peroxy niobic and peroxytantalic Acids $HNbO_4 \cdot n H_2O$, $HTaO_4 \cdot n H_2O$	1324
Potassium peroxy niobate, potassium peroxytantalate K_3NbO_8 , K_3TaO_8	1325
Niobium and tantalum sulfides	1327
Niobium and tantalum nitrides	1328
Niobium and tantalum phosphides NbP_2 , TaP_2 , NbP , TaP	1330
Niobium and tantalum carbides	1331
SECTION 24. CHROMIUM, MOLYBDENUM, TUNGSTEN, URANIUM. . .	1334
Chromium Cr	1334
Chromium (II) chloride $CrCl_2$	1336
Chromium (III) chloride $CrCl_3$	1338
Chromium (II) bromide $CrBr_2$	1340
Chromium (III) bromide $CrBr_3$	1341
Chromium (II) iodide CrI_2	1341
Chromium (III) iodide CrI_3	1344
Chromium (III) hydroxide $Cr(OH)_3 \cdot n H_2O$	1345
Chromium sulfides CrS , Cr_2S_3	1346
Chromium nitride CrN	1347
Hexa-aquochromium (III) chloride $[Cr(OH_2)_6]Cl_3$	1348
Chloropenta-aquochromium (III) chloride $[CrCl(OH_2)_5]Cl_2 \cdot H_2O$	1350
Hexaamminechromium (III) chloride and nitrate $[Cr(NH_3)_6]Cl_3$, $[Cr(NH_3)_6](NO_3)_3$	1351
Chloropentaamminechromium (III) chloride $[CrCl(NH_3)_5]Cl_2$	1352
Triethylenediaminechromium (III) sulfate, chloride and thiocyanate $[Cr en_3]_2(SO_4)_3$, $[Cr en_3]Cl_3 \cdot 3.5 H_2O$, $[Cr en_3](SCN)_3 \cdot H_2O$	1354
cis-Dichlorodiethylenediaminechromium (III) chloride $[CrCl_2 en_2]Cl \cdot H_2O$	1356
trans-Dithiocyanatodi(ethylenediamine)chromium (III) thiocyanate $[Cr(SCN)_2 en_2]SCN$	1357
trans-Dichlorodi(ethylenediamine)chromium (III) chloride $[CrCl_2 en_2]Cl$	1357
Dichloroaquotriamminechromium (III) chloride $[CrCl_2(OH_2)(NH_3)_3]Cl$	1358
Hexaurea-chromium (III) chloride $[Cr(OCN_2H_4)_6]Cl_3 \cdot$ $3 H_2O$	1359
Rhodochromium chloride $[(NH_3)_5Cr(OH)Cr(NH_3)_5]Cl_5$	1359
Erythrochromium chloride $[(NH_3)_5Cr(OH)Cr(NH_3)_4(OH_2)]Cl_5$	1360

Tris(2,2'-dipyridyl)chromium (II) Perchlorate [Cr(dipy) ₃](ClO ₄) ₂	1361
Tris(2,2'-dipyridyl)chromium (I) Perchlorate [Cr(dipy) ₃]ClO ₄	1362
Tris(2,2'-dipyridyl)chromium (0) [Cr(dipy) ₃]	1363
Hexaphenylisonitrilochromium (0) [Cr(C ₆ H ₅ NC) ₆]	1363
Chromium Orthophosphate CrPO ₄	1364
Chromium (II) Sulfate CrSO ₄ · 5 H ₂ O	1365
Chromium (II) Salt Solutions	1366
Chromium (II) Acetate Cr ₂ (CH ₃ COO) ₄ · 2 H ₂ O	1368
Chromium (II) Oxalate CrC ₂ O ₄ · 2 H ₂ O	1370
Hexaquo chromium (III) Acetate [Cr(OH ₂) ₆](CH ₃ COO) ₃	1371
Dihydroxohexaacetatotrichromium (III) Acetate and Chloride [Cr ₃ (OH) ₂ (CH ₃ COO) ₆](CH ₃ COO) · n H ₂ O, [Cr ₃ (OH) ₂ (CH ₃ COO) ₆]Cl · 8 H ₂ O	1371
Potassium Trioxalatochromate (III) K ₃ [Cr(C ₂ O ₄) ₃] · 3 H ₂ O	1372
Potassium Hexacyanochromate (III) K ₃ [Cr(CN) ₆]	1373
Potassium Hexathiocyanatochromate (II) K ₃ [Cr(SCN) ₆] · 4 H ₂ O	1374
Trilithium Hexaphenylchromate (III) Li ₃ Cr(C ₆ H ₅) ₆ · 2.5 (C ₂ H ₅) ₂ O	1375
Ammonium Tetrathiocyanatodiamminechromate (III) NH ₄ [Cr(SCN) ₄ (NH ₃) ₂] · H ₂ O	1376
Tetrathiocyanatodiamminechromic (III) Acid H[Cr(SCN) ₄ (NH ₃) ₂]	1377
Ammonium Tetrathiocyanatodanilinochromate (III) NH ₄ [Cr(SCN) ₄ (C ₆ H ₅ NH ₂) ₂] · 1 1/2 H ₂ O	1378
Potassium Tetrathiocyanatodipyridinochromate (III) K[Cr(SCN) ₄ py ₂] · 2 H ₂ O	1379
Trichlorotriaquo chromium [CrCl ₃ (OH ₂) ₃]	1380
Trichlorotriethanolochromium [CrCl ₃ (C ₂ H ₅ OH) ₃]	1380
Trichlorotriamminechromium [CrCl ₃ (NH ₃) ₃]	1381
Trichlorotripyridinechromium [CrCl ₃ py ₃]	1381
Chromium (III) Glycinate (H ₂ NCH ₂ COO) ₃ Cr	1382
Chromium (III) Xanthate [C ₂ H ₅ OCS ₂] ₃ Cr	1383
Chromium (III) Acetylacetonate (C ₅ H ₇ O ₂) ₃ Cr	1383
Chromyl Chloride CrO ₂ Cl ₂	1384
Chromium Trioxide-Pyridine CrO ₃ · 2 py	1385
Chromyl Nitrate CrO ₂ (NO ₃) ₂	1386
Chromyl Perchlorate CrO ₂ (ClO ₄) ₂	1387
Rubidium Chromate Rb ₂ CrO ₄	1388
Rubidium Dichromate Rb ₂ Cr ₂ O ₇	1388
Cesium Chromate Cs ₂ CrO ₄	1389
Cesium Dichromate Cs ₂ Cr ₂ O ₇	1389
Potassium Fluorochromate K[CrO ₃ F]	1390
Potassium Chlorochromate K[CrO ₃ Cl]	1390

Potassium Tetraperoxochromate (V) K_3CrO_8	1391
Ammonium Pentaperoxodichromate (NH_4) ₂ Cr ₂ O ₁₂ · 2 H ₂ O	1392
Diperoxotriamminechromium (IV) (NH_3) ₃ CrO ₄	1392
Barium Orthochromate (IV) Ba ₂ CrO ₄	1393
Barium Chromate (V) Ba ₃ (CrO ₄) ₂	1394
Sodium Thiochromite NaCrS ₂	1394
Dibenzenechromium (0) (C ₆ H ₆) ₂ Cr	1395
Bis(diphenyl)chromium (0) (C ₁₂ H ₁₀) ₂ Cr	1396
Dibenzenechromium (I) Iodide [(C ₆ H ₆) ₂ Cr]I.	1397
Bis(diphenyl)chromium (I) Iodide [Cr(C ₁₂ H ₁₀) ₂]I	1397
(Diphenyl)(benzene)chromium (I) Iodide [(C ₁₂ H ₁₀)Cr(C ₆ H ₆)]I	1398
Molybdenum Mo	1401
Dibenzene-molybdenum (0) (C ₆ H ₆) ₂ Mo.	1402
Molybdenum (II) Chloride Mo ₃ Cl ₆	1403
Molybdenum (III) Chloride MoCl ₃	1404
Molybdenum (V) Chloride MoCl ₅	1405
Molybdenum (III) Bromide MoBr ₃	1407
Tribromotripyridine-molybdenum [MoBr ₃ py ₃]	1408
Potassium Hexachloromolybdate (III) K ₃ MoCl ₆	1408
Molybdenum (IV) Oxide MoO ₂	1409
γ-Molybdenum Oxide Mo ₄ O ₁₁	1410
Lower Molybdenum Hydroxides	1411
Molybdenum (VI) Oxide MoO ₃	1412
Molybdic Acid H ₂ MoO ₄ · H ₂ O	1412
Ammonium Oxopentachloromolybdate (V) (NH ₄) ₂ [MoOCl ₅]	1413
Potassium Hydrogen Diperoxomonomolybdate KHM ₂ O ₆ · 2 H ₂ O	1414
Tetraamminezinc Tetraperoxomolybdate (VI) [Zn(NH ₃) ₄]MoO ₈	1414
Molybdenum (IV) Sulfide MoS ₂	1415
Ammonium Tetrathiomolybdate (NH ₄) ₂ MoS ₄	1416
Potassium Octacyanomolybdate (IV) K ₄ [Mo(CN) ₈] · 2 H ₂ O	1416
Tungsten W.	1417
Tungsten (V) Chloride WCl ₅	1419
Tungsten (VI) Chloride WCl ₆	1420
Tungsten (IV) Oxide WO ₂	1421
γ-Tungsten Oxide W ₁₈ O ₄₉	1422
Tungsten Blue H _{0.5} WO ₃	1423
Tungsten (VI) Oxide WO ₃	1423
Yellow Tungstic Acid H ₂ WO ₄	1424
Tungsten Oxytetrachloride WOCl ₄	1425
Tungsten (IV) Sulfide WS ₂	1425
Tungsten Hexaphenoxide W(OC ₆ H ₅) ₆	1426

Potassium Enneachloroditungstate (III) $K_3W_2Cl_9$	1427
Hexachlorotripyridineditungstate (III) $W_2Cl_6PY_3$	1429
Potassium Octacyanotungstate (IV) $K_4[W(CN)_8] \cdot 2H_2O$	1429
Potassium Octacyanotungstate (V) $K_3[W(CN)_8] \cdot H_2O$..	1430
Uranium U	1431
Uranium Hydride UH_3	1434
Uranium (III) Chloride UCl_3	1435
Uranium (IV) Chloride UCl_4	1436
Uranium (V) Chloride UCl_5	1438
Uranyl Chloride UO_2Cl_2	1439
Uranium (IV) Bromide UBr_4	1440
Uranium (IV) Oxide UO_2	1442
Uranium (VI) Oxide UO_3	1442
Alkali Uranates (VI) Li_2UO_4 , Na_2UO_4 , K_2UO_4	1445
Alkali Uranates (V) $LiUO_3$, $NaUO_3$	1445
Uranium Peroxide $UO_4 \cdot 2H_2O$	1446
Uranium (IV) Sulfide US_2	1446
Uranium (IV) Sulfate $U(SO_4)_2 \cdot 8H_2O$ or $4H_2O$	1447
Ammonium Uranyl Carbonate $(NH_4)_4[UO_2(CO_3)_3]$	1449
Uranium (IV) Oxalate $U(C_2O_4)_2 \cdot 6H_2O$	1449
Potassium Tetraoxalouranate (IV) $K_4[U(C_2O_4)_4] \cdot 5H_2O$	1450
Uranium (V) Ethoxide $U(OC_2H_5)_5$	1451
Uranium (VI) Ethoxide $U(OC_2H_5)_6$	1452
Uranyldibenzoylmethane $UO_2(C_{15}H_{11}O_2)_2$	1453
SECTION 25. MANGANESE	1454
Manganese Mn	1454
Manganese (II) Oxide MnO	1455
Manganese (II) Hydroxide $Mn(OH)_2$	1456
Manganese (III) Oxide γ - Mn_2O_3 , γ - $MnO(OH)$	1457
Manganese (IV) Oxide MnO_2	1458
Manganese (VII) Oxide Mn_2O_7	1459
Sodium Manganate (V) $Na_3MnO_4 \cdot 0.25NaOH \cdot 12H_2O$.	1460
Potassium Manganate (VI) K_2MnO_4	1461
Barium Manganate (VII) $Ba(MnO_4)_2$	1462
Silver Manganate (VII) $AgMnO_4$	1463
$BaSO_4$ - $KMnO_4$ Solid Solution	1463
Potassium Manganese (III) Chloride K_2MnCl_5	1464
Potassium Hexachloromanganate (IV) K_2MnCl_6	1464
Manganese (II) Sulfide MnS	1465
Manganese (III) Sulfate $Mn_2(SO_4)_3$	1467
Cesium Manganese (III) Sulfate $CsMn(SO_4)_2 \cdot 12H_2O$..	1468
Manganese Nitride Mn_4N	1468
Manganese (III) Acetate $Mn(CH_3COO)_3$, $Mn(CH_3COO)_3 \cdot$ $2H_2O$	1469

Potassium Trioxalatomanganate (III)	
$K_3[Mn(C_2O_4)_3] \cdot 3 H_2O$	1470
Potassium Dioxalatomanganate (IV)	
$K_2[Mn(C_2O_4)_2(OH)_2] \cdot 2 H_2O$	1471
Potassium Hexacyanomanganate (I) $K_5Mn(CN)_6$	1472
Potassium Hexacyanomanganate (II) $K_4Mn(CN)_6 \cdot 3 H_2O$	1473
Potassium Hexacyanomanganate (III) $K_3Mn(CN)_6$	1474
SECTION 26. RHENIUM	1476
Rhenium Metal.	1476
Rhenium (III) Chloride $ReCl_3$	1476
Rhenium (V) Chloride $ReCl_5$	1477
Potassium Rhenium (IV) Chloride K_2ReCl_6	1478
Rhenium (VI) Oxochloride $ReOCl_4$	1479
Rhenium (VII) Oxochloride ReO_3Cl	1480
Rhenium (IV) Oxide ReO_2	1480
Rhenium (VI) Oxide ReO_3	1481
Rhenium (VII) Oxide Re_2O_7	1482
Rhenium Rhenate (IV) Na_2ReO_3	1483
Ammonium Perrhenate NH_4ReO_4	1484
Barium Perrhenate $Ba(ReO_4)_2$	1485
Barium Rhenate (VI) $BaReO_4$	1485
Rhenium (IV) Sulfide ReS_2	1486
Rhenium (VII) Sulfide Re_2S_7	1487
Barium Mesoperrhenate $Ba_3(ReO_5)_2$	1487
Workup of Rhenium Residues	1488
SECTION 27. IRON	1490
Metallic Iron	1490
Iron (II) Chloride $FeCl_2$	1491
Iron (III) Chloride $FeCl_3$	1492
Iron (II) Bromide $FeBr_2$	1493
Iron (III) Bromide $FeBr_3$	1494
Iron (II) Iodide FeI_2	1495
Iron (II) Oxide FeO	1497
Iron (II) Hydroxide $Fe(OH)_2$	1498
Iron (II, III) Oxide Fe_3O_4	1499
Iron (III) Hydroxide $Fe(OH)_3$	1499
Iron (III) Oxochloride $FeOCl$	1501
Iron (II) Sulfide FeS	1502
Iron Nitrides Fe_2N , Fe_4N	1502
Iron Carbide Fe_3C	1503
Lithium Ferrate (III) $LiFeO_2$	1504
Potassium Ferrate (VI) K_2FeO_4	1504
Potassium Iron (III) Sulfide $KFeS_2$	1507
Basic Iron (III) Sulfate $Fe_3(SO_4)_2(OH)_5 \cdot 2 H_2O$ or	
$3 Fe_2O_3 \cdot 4 SO_3 \cdot 9 H_2O$	1507

Basic Iron (III) Acetate	
[Fe ₃ (CH ₃ COO) ₆ (OH) ₂]CH ₃ COO · H ₂ O	1508
Hexacyanoferric (II) Acid H ₄ Fe(CN) ₆	1509
Ammonium Hexacyanoferrate (II) (NH ₄) ₄ Fe(CN) ₆	1509
Hexacyanoferric (III) Acid H ₃ Fe(CN) ₆	1510
Sodium Hexathiocyanoferrate (III) Na ₃ Fe(SCN) ₆ ·	
12 H ₂ O	1511
Sodium Pentacyanoamminoferrate (II)	
Na ₃ [Fe(CN) ₅ NH ₃] · 3 H ₂ O	1511
Sodium Pentacyanoamminoferrate (III)	
Na ₂ [Fe(CN) ₅ NH ₃] · H ₂ O	1512
SECTION 28. COBALT, NICKEL	1513
Metallic Cobalt	1513
Cobalt (II) Chloride CoCl ₂	1515
Hexaamminecobalt (II) Chloride [Co(NH ₃) ₆]Cl ₂	1516
Cobalt (II) Bromide CoBr ₂ , CoBr ₂ · 6 H ₂ O	1517
Cobalt (II) Iodide α-CoI ₂ , β-CoI ₂ , CoI ₂ · 6 H ₂ O	1518
Cobalt (II) Oxide CoO	1519
Cobalt (II, III) Oxide Co ₃ O ₄	1520
Cobalt (III) Hydroxide CoO(OH)	1520
Cobalt (II) Hydroxide Co(OH) ₂	1521
Cobalt Sulfides CoS, CoS ₂ , Co ₃ S ₄ , Co ₉ S ₈	1523
Cobalt (III) Sulfate Co ₂ (SO ₄) ₃ · 18 H ₂ O	1524
Cobalt Aluminate CoAl ₂ O ₄	1525
Hexaamminecobalt (III) Nitrate [Co(NH ₃) ₆](NO ₃) ₃	1526
Cobalt (III) Amide Co(NH ₂) ₃	1526
Dicobalt Nitride Co ₂ N	1529
Cobalt Nitride CoN	1529
Cobalt Phosphides CoP ₃ , CoP, Co ₂ P	1530
Dicobalt Carbide Co ₂ C	1531
Hexaamminecobalt (III) Chloride [Co(NH ₃) ₆]Cl ₃	1531
Chloropentaamminecobalt (III) Chloride [Co(NH ₃) ₅ Cl]Cl ₂	1532
Nitropentaamminecobalt (III) Chloride	
[Co(NH ₃) ₅ NO ₂]Cl ₂	1534
Nitritopentaamminecobalt (III) Chloride	
[Co(NH ₃) ₅ ONO]Cl ₂	1535
Carbonatotetraamminecobalt (III) Sulfate	
[Co(NH ₃) ₄ CO ₃] ₂ SO ₄ · 3 H ₂ O	1535
Dichlorotetraamminecobalt (III) Chloride	
[Co(NH ₃) ₄ Cl ₂]Cl	1536
Triethylenediaminecobalt (III) Bromide [Co en ₃]Br ₃	1538
Decaammine-μ-peroxocobalt (III) Cobalt (IV) Sulfate	
[(NH ₃) ₅ Co ^{III} (O ₂)Co ^{IV} (NH ₃) ₅](SO ₄) ₂ · SO ₄ H · 3 H ₂ O	1540
Sodium Hexanitritocobaltate (III) Na ₃ [Co(NO ₂) ₆]	1541
Potassium Hexacyanocobaltate (III) K ₃ [Co(CN) ₆]	1541

Hexacyanocobaltic (III) Acid	1542
Metallic Nickel	1543
Nickel (II) Chloride NiCl_2	1544
Hexaamminenickel (II) Chloride $[\text{Ni}(\text{NH}_3)_6]\text{Cl}_2$	1545
Nickel (II) Bromide NiBr_2	1545
Nickel (II) Iodide NiI_2	1547
Nickel (II) Oxide NiO	1548
Nickel (II) Hydroxide $\text{Ni}(\text{OH})_2$	1549
β -Nickel (III) Hydroxide $\text{NiO}(\text{OH})$	1549
γ -Nickel (III) Hydroxide $\text{NiO}(\text{OH})$	1550
Nickel (II, III) Hydroxide $\text{Ni}_3\text{O}_2(\text{OH})_4$	1551
Nickel (II) Sulfide NiS	1551
Nickel (IV) Sulfide NiS_2	1554
Nickel (II) Amide $\text{Ni}(\text{NH}_2)_2$	1554
Trinickel Dinitride Ni_3N_2	1555
Trinickel Nitride Ni_3N	1555
Nickel Carbide Ni_3C	1556
Nickel (II) Carbonate	1556
Nickel (II) Thiocyanate $\text{Ni}(\text{SCN})_2$	1558
Di- μ -sulfido-tetrakis(dithiobenzoato)dinickel (IV) ($\text{C}_6\text{H}_5 \cdot \text{CSS}$) $_2\text{NiS}_2\text{Ni}(\text{SSC} \cdot \text{C}_6\text{H}_5)_2$	1558
Potassium Tetracyanonickelate (II) $\text{K}_2[\text{Ni}(\text{CN})_4] \cdot \text{H}_2\text{O}$	1559
SECTION 29. THE PLATINUM METALS	1560
Pure Platinum Pt	1560
Reclaimed Platinum	1561
Platinum Sponge	1562
Platinum Black	1562
Platinized Asbestos	1563
Handling of Platinum Equipment	1564
Platinum Electroplating	1565
Platinum Chlorides	1567
Hexachloroplatinic (IV) Acid $\text{H}_2\text{PtCl}_6 \cdot 6 \text{H}_2\text{O}$	1569
Tetrachloroplatinic (II) Acid H_2PtCl_4	1570
Ammonium Hexachloroplatinate (IV) $(\text{NH}_4)_2\text{PtCl}_6$	1570
Potassium Hexachloroplatinate (IV) K_2PtCl_6	1571
Sodium Hexachloroplatinate (IV) Na_2PtCl_6 , $\text{Na}_2\text{PtCl}_6 \cdot 6 \text{H}_2\text{O}$	1571
Potassium Tetrachloroplatinate (II) K_2PtCl_4	1572
Platinum (II) Oxide PtO	1573
Platinum (IV) Oxide $\text{PtO}_2 \cdot x\text{H}_2\text{O}$	1574
Hexahydroxyplatinate (IV) $\text{Na}_2\text{Pt}(\text{OH})_6 \cdot x\text{H}_2\text{O}$, $\text{K}_2\text{Pt}(\text{OH})_6 \cdot x \text{H}_2\text{O}$	1575
Platinum (II) Sulfide PtS	1575
Platinum (IV) Sulfide PtS_2	1576

Potassium Tetracyanoplatinate (II) and Barium Tetracyanoplatinate (II) $K_2Pt(CN)_4 \cdot 3 H_2O$, $BaPt(CN)_4 \cdot 4 H_2O$	1576
Ammine Complexes of Platinum (II) (Platinum Amines) [Pt(NH ₃) ₄][PtCl ₄] and [Pt(NH ₃) ₄]Cl ₂ · H ₂ O	1577
Reiset's Second Chloride trans-[PtCl ₂ (NH ₃) ₂]	1578
Peyrone's Chloride cis-[PtCl ₂ (NH ₃) ₂]	1578
cis-Dinitrodiammineplatinum (II) [Pt(NO ₂) ₂ (NH ₃) ₂]	1579
Pure Palladium Pd	1580
Colloidal Palladium	1581
Palladium Black	1581
Palladized Asbestos	1582
Palladium (II) Chloride PdCl ₂	1582
PdCl ₂ Solution for the Detection of CO	1582
Palladium (II) Oxide PdO	1583
Tetrachloropalladates (II) K_2PdCl_4 , Na_2PdCl_4 , (NH ₄) ₂ PdCl ₄	1584
Hexachloropalladates (IV) K_2PdCl_6 , (NH ₄) ₂ PdCl ₆	1584
Diamminepalladium (II) Salts [PdCl ₂ (NH ₃) ₂], [PdBr ₂ (NH ₃) ₂]	1585
Pure Rhodium Rh	1585
Rhodium (III) Chloride RhCl ₃	1587
Hexachlororhodates (III)	1587
Rhodium (III) Oxide Rh ₂ O ₃	1588
Rhodium Sulfate	1589
Chloropentaamminerhodium Salts [RhCl(NH ₃) ₅]Cl ₂ , [RhCl(NH ₃) ₅](NO ₃) ₂	1590
Pure Iridium Ir	1590
Iridium (IV) Oxide IrO ₂	1590
Hydrated Iridium (IV) Oxide IrO ₂ · 2 H ₂ O	1591
Hydrated Iridium (III) Oxide Ir ₂ O ₃ · x H ₂ O	1592
Iridium (III) Chloride IrCl ₃	1592
Hexachloroiridic (IV) Acid H ₂ IrCl ₆	1593
Potassium Hexachloroiridate (IV) K ₂ IrCl ₆	1593
Ammonium Hexachloroiridate (IV) (NH ₄) ₂ IrCl ₆	1594
Potassium Hexachloroiridate (III) K ₃ IrCl ₆ · 3 H ₂ O	1595
Pure Ruthenium Ru	1595
Ruthenium (IV) Hydroxychloride Ru(OH)Cl ₃	1597
Ruthenium (III) Chloride RuCl ₃ , RuCl ₃ · H ₂ O	1597
Ammonium Hexachlororuthenate (IV) (NH ₄) ₂ RuCl ₆	1599
Ruthenium (IV) Oxide RuO ₂	1599
Ruthenium (VIII) Oxide RuO ₄	1599
Potassium Ruthenate and Potassium Perruthenate $K_2RuO_4 \cdot H_2O$, KRuO ₄	1600
Pure Osmium Os	1601
Osmium (IV) Chloride OsCl ₄	1601
Sodium Hexachloroosmate (IV) Na ₂ OsCl ₆ · 2 H ₂ O	1602

Ammonium Hexachloroosmate (IV) $(\text{NH}_4)_2\text{OsCl}_6$	1603
Osmium (IV) Oxide OsO_2	1603
Osmium (VIII) Oxide OsO_4	1603
Potassium Osmate (VI) $\text{K}_2\text{OsO}_4 \cdot 2 \text{H}_2\text{O}$	1604
Potassium Osmiamate $\text{K}(\text{OsO}_3\text{N})$	1605

Part III

Special Compounds

SECTION 1. ADSORBENTS AND CATALYSTS	1609
Introduction	1609
Active Metals	1613
Pyrophoric Cobalt	1615
Ni-Mg Mixed Oxalate Catalyst (1:1)	1615
Tungsten	1622
"“Molecular”" Silver	1623
Raney Nickel	1625
Nickel Formate-Paraffin Catalyst	1631
Active Copper	1633
Carbonyl Iron	1636
Explosive Antimony	1638
Silver (Active Agent for Reductors)	1641
Deposition of Metals from the Vapor Phase	1643
Hydrated Oxide Gels	1646
Hydrated Chromium Oxide Gel	1648
Silica Gel	1648
Aluminum Hydroxide Gel	1652
"“Glimmering”" Hydrated Iron (III) Oxide	1654
Active Metal Oxides	1656
Aluminum Oxide	1660
α -Iron (III) Oxide	1661
Magnesium Oxide	1663
Zinc Oxide	1664
Lead (IV) Oxide	1668
Colloidal Suspensions of Oxides in Gases (Smokes)	1669
Copper-Chromium Oxide	1672
Hopkalite (Hopcalite)	1674
SECTION 2. HYDROXO SALTS	1677
General	1677
Handling of Concentrated Alkali Hydroxides	1679
Sodium Hydroxozincates	1681
Sodium Tetrahydroxomagnesate $\text{Na}_2[\text{Mg}(\text{OH})_4]$	1683
Sodium Tetrahydroxocuprate (II) $\text{Na}_2[\text{Cu}(\text{OH})_4]$	1684
Barium Hexahydroxocuprate (II) $\text{Ba}_2[\text{Cu}(\text{OH})_6]$	1685
Sodium Tetrahydroxoferrate (II) $\text{Na}_2[\text{Fe}(\text{OH})_4]$	1686

Strontium Hexahydroxonickelate (II) $\text{Sr}_2[\text{Ni}(\text{OH})_6]$	1686
Sodium Trihydroxostannate (II) $\text{Na}[\text{Sn}(\text{OH})_3]$	1687
Sodium Hexahydroxochromate (III) $\text{Na}_3[\text{Cr}(\text{OH})_6]$	1688
Sodium Hydroxoferrates (III)	1689
Barium Hydroxoferrates (III)	1690
Alkali Aluminates.	1692
Sodium Hexahydroxostannate (IV) $\text{Na}_2[\text{Sn}(\text{OH})_6]$	1694
Sodium Hexahydroxoplumbate (IV) $\text{Na}_2[\text{Pb}(\text{OH})_6]$	1694
Barium Oxohydroxostannate (II) $\text{Ba}[\text{Sn}_2\text{O}(\text{OH})_4]$	1696
SECTION 3. ISO- AND HETEROPOLY ACIDS AND THEIR SALTS	1698
Introduction.	1698
General Methods	1700
Isopoly Compounds	1702
Isopolyvanadates	1702
Isopoly niobates	1705
Isopoly tantalates	1707
Isopoly arsenates	1709
Isopoly molybdates	1710
Isopoly tungstates	1712
Isopoly sulfates	1714
Heterpoly Compounds	1716
12-Tungstic Acid-1-Borates.	1716
12-Tungstic Acid-1-Silicates	1717
10-Tungstic Acid-1-Silicates	1719
12-Tungstic Acid-1-Phosphates	1720
22-Tungstic Acid-2-Phosphates	1722
21-Tungstic Acid-2-Phosphates	1722
18-Tungstic Acid-2-Phosphates	1723
12-Tungstic Acid-1-Arsenates	1724
18-Tungstic Acid-2-Arsenates	1725
6-Tungstic Acid-1-Tellurates.	1726
Metatungstates, Dodecatungstates	1727
12-Molybdic Acid-1-Silicates	1729
12-Molybdic Acid-1-Phosphates	1730
18-Molybdic Acid-2-Phosphates	1732
12-Molybdic Acid-1-Arsenates	1734
18-Molybdic Acid-2-Arsenates	1734
6-Molybdic Acid-2-Arsenates.	1736
12-Molybdic Acid-2-Chromites.	1737
6-Molybdic Acid-1-Periodates	1738
48-Vanadic Acid-2-Phosphates and 24-Vanadic Acid-2- Phosphates.	1739
SECTION 4. CARBONYL AND NITROSYL COMPOUNDS	1741
General Information	1741
Chromium, Molybdenum, Tungsten Carbonyls $\text{Cr}(\text{CO})_6$, $\text{Mo}(\text{CO})_6$, $\text{W}(\text{CO})_6$	1741

Iron Pentacarbonyl $\text{Fe}(\text{CO})_5$	1743
Diiron Nonacarbonyl $\text{Fe}_2(\text{CO})_9$	1744
Triiron Dodecacarbonyl $[\text{Fe}(\text{CO})_4]_3$ or $\text{Fe}_3(\text{CO})_{12}$	1745
Cobalt Carbonyls $[\text{Co}(\text{CO})_4]_2$, $[\text{Co}(\text{CO})_3]_4$	1746
Nickel Carbonyl $\text{Ni}(\text{CO})_4$	1747
Dipyridine Chromium Tetracarbonyl, Tripyridine Chromium Tricarbonyl $\text{Cr}(\text{CO})_4 \text{py}_2$, $\text{Cr}(\text{CO})_3 \text{py}_3$	1749
o-Phenanthroline Nickel Dicarboxyl $\text{Ni}(\text{CO})_2 \text{C}_{12}\text{H}_8\text{N}_2$	1750
Iron Tetracarbonyl Halides $\text{Fe}(\text{CO})_4 \text{X}_2$	1751
Iron Tetracarbonyl Dihydride $\text{Fe}(\text{CO})_4 \text{H}_2$	1752
Cobalt Tetracarbonyl Hydride $\text{Co}(\text{CO})_4 \text{H}$	1753
Iron Carbonyl Mercury $\text{Fe}(\text{CO})_4 \text{Hg}$	1755
Cobalt Carbonyl Mercury $[\text{Co}(\text{CO})_4]_2 \text{Hg}$	1755
Ethylenediamine Iron Carbonyl $[\text{Fe en}_3] [\text{Fe}_2(\text{CO})_8]$	1756
Pyridine Iron Carbonyl $[\text{Fe py}_6] [\text{Fe}_4(\text{CO})_{13}]$	1758
Potassium Nitrosyl Tricarbonyl Ferrate $[\text{Fe}(\text{CO})_3 \text{NO}] \text{K}$	1759
Iron Dinitrosyl Dicarboxyl $\text{Fe}(\text{NO})_2(\text{CO})_2$	1760
Cobalt Nitrosyl Tricarbonyl $\text{Co}(\text{NO})(\text{CO})_3$	1761
Dinitrosyl Cobalt Halides $(\text{NO})_2 \text{CoCl}$, $(\text{NO})_2 \text{CoBr}$, $(\text{NO})_2 \text{CoI}$	1761
Sodium Dinitrosyl Thioferrate $\text{Na}[(\text{NO})_2 \text{FeS}] \cdot 4 \text{H}_2\text{O}$	1763
Ammonium Heptanitrosyl Trithiotetraferrate $\text{NH}_4[(\text{NO})_7 \text{Fe}_4 \text{S}_3] \cdot \text{H}_2\text{O}$	1764
Ethyl Dinitrosyl Thioferrate $[(\text{NO})_2 \text{FeSC}_2\text{H}_5]_2$	1765
Potassium Dinitrosyl Thiosulfatoferrate $\text{K}[(\text{NO})_2 \text{FeS}_2\text{O}_3] \cdot \text{H}_2\text{O}$	1766
Potassium Nitrosyl Cyanomolybdate $\text{K}_4[(\text{NO})\text{Mo}(\text{CN})_5] \cdot \text{H}_2\text{O}$	1766
Potassium Nitrosyl Cyanomanganate $\text{K}_3[(\text{NO})\text{Mn}(\text{CN})_5]$	1767
Sodium Nitrosyl Cyanoferrate $\text{Na}_2[(\text{NO})\text{Fe}(\text{CN})_5] \cdot 2 \text{H}_2\text{O}$	1768
Sodium Carbonyl Cyanoferrate $\text{Na}_3[(\text{CO})\text{Fe}(\text{CN})_5]$	1769
SECTION 5. ALLOYS AND INTERMETALLIC COMPOUNDS	1771
General Remarks	1771
Purity of the Starting Materials	1772
Form of the Starting Materials	1773
Preparation of Starting Mixtures	1773
Crucible and Ampoule Methods	1774
Heating and Cooling	1782
Alloy Synthesis under Pressure	1784
Melting Without a Container	1786
Comminution in the Absence of Air	1786
Distillation Method	1789
Residue Methods	1791
Special Processes	1793
Silicides	1795
Borides	1798

Amalgams	1801
Potassium-Sodium Alloy (liquid).....	1808
Low-Melting Alloys	1808
FORMULA INDEX	1811
SUBJECT INDEX	1828
INDEX OF PROCEDURES, MATERIALS AND DEVICES	1855
ERRATA FOR VOLUME I	1859

Copper, Silver, Gold

O. GLEMSER AND H. SAUER

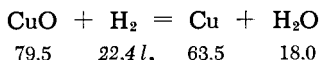
Copper (Pure Metal)

A solution of electrolytic copper in 30% nitric acid is evaporated to dryness. The resultant nitrate is converted to the oxide by heating for 15 hours in an electrical furnace at 850°C. The oxide is then reduced at low temperature (250-300°C). The product is finely divided metallic copper.

Alternate method: Reduction of copper oxalate with hydrogen [K. Fischbeck and O. Dorner, *Z. anorg. allg. Chem.* **182**, 228 (1928)]. For preparative directions, see subsection on CuS, p. 1018.

PROPERTIES:

Atomic weight 63.54; m.p. 1084°C, b.p. 2595°C; d_4^{20} 8.93. Crystal structure: type A1.

REFERENCE:

H. Haraldsen. *Z. anorg. allg. Chem.* **240**, 339 (1939).

Colloidal Copper

An ammoniacal solution of CuSO_4 (1:1000) is treated with a dilute solution of hydrazine hydrate (1:2000) in the presence of acacia (gum arabic). The hydrosol obtained upon heating is immediately poured into a parchment paper bag which has been pre-soaked in water for some time; it is dialyzed against water for four days.

PROPERTIES:

The hydrosol is copper-red under incident light and blue under transmitted light. If protected from air, it is stable for a limited time.

REFERENCE:

A. Gutbier and G. Hofmeier. *Z. anorg. allg. Chem.* **44**, 227 (1905).

Copper Hydride

CuH

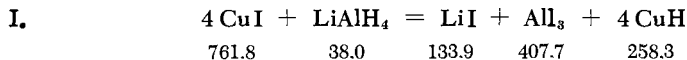

A pyridine solution of CuI is made to react at room temperature with a solution of LiAlH₄ in ether-pyridine (the latter being prepared by mixing a concentrated ether solution of LiAlH₄ with absolute pyridine), yielding a blood-red pyridine solution of CuH. The mixture is allowed to stand at room temperature for 4-6 hours to complete the reaction. The AlI₃ co-product is sparingly soluble in pyridine and precipitates to a large extent. It is then readily separated from the clear supernatant liquor by centrifugation. The residual AlI₃ and the soluble LiI are separated from the CuH by addition of an at least equal volume of ether to the pyridine solution. The resultant red-brown precipitate of CuH is separated by centrifugation, washed with ether, dissolved in pyridine, and reprecipitated with ether. This purification procedure is repeated twice. The ether is then evaporated in a high vacuum.

The reaction may also be carried out by treating a solution of CuI in pyridine-tetrahydrofuran-ether with an ether solution of lithium aluminum hydride. In this case, CuH precipitates as soon as the two solutions are mixed, while both AlI₃ and LiI remain in solution. The CuH precipitate is then purified as above (by dissolving in pyridine and reprecipitating with ether).

II. PREPARATION OF COPPER HYDRIDE BY REDUCTION OF SOLUTIONS OF COPPER SALTS WITH HYPOPHOSPHOROUS ACID

A 65°C mixture of 25 g. of CuSO₄·5 H₂O in 100 ml. of water and 20 ml. of 2N H₂SO₄ is added to a solution of 21 g. of H₃PO₄ in 300 ml. of water. After standing for 24 hours, the resultant precipitate is filtered and washed successively with water, alcohol and ether. Although the precipitation is not quantitative under these conditions, the product is relatively pure.

Small amounts of iron salt or halogen ion impurity interfere with the precipitation.

PROPERTIES:

Formula weight 64.55. Light red-brown color. Anhydrous when obtained by method I. Undecomposed (metastable) up to about 60°C; decomposes into the elements above this temperature, and

rapidly at 100°C. Quite stable in 0°C water; just as in the thermal decomposition, dissociates into metallic copper and H₂ from 45°C on, rapidly at 65°C. Dark red pyridine solution. Crystal structure: type B4 (expanded Cu lattice). Heat of formation: 5.1 kcal./mole.

REFERENCES:

- I. E. Wiberg and W. Henle. *Z. Naturforsch.* **7b**, 250 (1952).
- II. O. Neunhoeffer and F. Nerdel. *J. prakt. Chem.* **144**, 63 (1935);
G. F. Hüttig and F. Brodkorb. *Z. anorg. allg. Chem.* **153**, 235, 242 (1926).

Copper (I) Chloride

CuCl

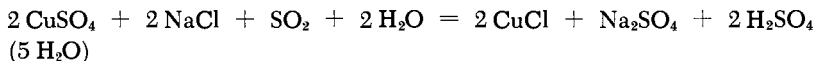

499.4 116.9 22.41. 36.0 198.0 142.1 196.2

Gaseous SO₂ is bubbled through an aqueous solution of 50 g. of CuSO₄ · 5 H₂O and 24 g. of NaCl at 60–70°C until CuCl ceases to precipitate. The product is suction-filtered and washed with sulfurous acid, then with glacial acetic acid until the latter becomes colorless. The moist product is placed in a shallow dish or on a large watch glass and heated on a water bath until the odor of acetic acid is no longer detectable. It is stored in a tightly closed container.

Alternate methods: a) Acetyl chloride is added in drops to a boiling solution of cupric acetate in glacial acetic acid containing at least 50% of acetic anhydride by volume. When the color changes to yellow, the addition is stopped and the mixture is refluxed for 15 minutes. The resultant white solid is suction-filtered, washed with acetic anhydride, and dried at 140–150°C (D. Hardt, private communication).

b) Cupric chloride is heated to 150–200°C in glycerol. The CuCl obtained is filtered, washed with alcohol, and dried in vacuum [B. K. Vaidya, *Nature (London)* **123**, 414 (1928)].

c) Reduction of CuCl₂ · 2 H₂O in a Na₂SO₃ solution (R. N. Keller and H. D. Wycoff in: W. C. Fernelius, *Inorg. Syntheses*, Vol. II, New York-London, 1946, p. 1).

d) A solution of crystalline CuCl₂ in hydrochloric acid is reduced over copper with exclusion of air (use a Bunsen valve; for a description of the valve, see Hackh's *Chemical Dictionary*, 3rd ed., the Blakiston Co., Phila.-Toronto, 1944). The product is poured into water [M. Denigés, *Compt. Rend. Hebd. Séances Acad. Sci.* **108**, 567 (1889)].

e) A mixture consisting of 1 part of CuSO₄ · 5 H₂O, 2 parts of NaCl and 1 part of Cu turnings is heated (use a Bunsen valve) with

10 parts of H₂O until the color disappears completely. The mixture is poured into water, and CuCl crystallizes out [M. Denigés, Comptes Rendus Hebd, Séances Acad. Sci. 108, 567 (1889)].

f) Sublimation of commercially pure CuCl over copper in a stream of HCl and argon at 900°C [J. B. Wagner and C. Wagner, J. Chem. Physics 26, 1597 (1957)].

SYNONYM:

Cuprous chloride.

PROPERTIES:

Formula weight 99.00. White crystalline material. M.p. 432°C, b.p. 1490°C; d_4^{25} 4.14, d_4^{22} 3.677. Sparingly soluble in water (25°C): 1.53 g./100 g. (partial decomposition in water: 2CuCl = Cu + CuCl₂). Forms a green basic chloride in air. Soluble in hot conc. hydrochloric acid, conc. alkali chloride solutions, conc. aqueous ammonia. Crystal structure: type B3. Conversion into high-temperature modification of type B4 at 410°C. Heat of formation (25°C): - 32.2 kcal./mole.

REFERENCE:

M. Rosenfeld. Ber. dtsch. chem. Ges. 12, 954 (1879).

Copper (I) Bromide

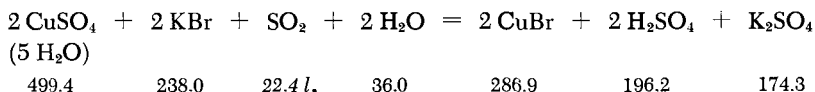

Stoichiometric quantities of pure CuSO₄·5 H₂O and KBr are dissolved in boiled distilled water and the solution is filtered through hard filter paper. It is then heated to a moderate temperature and a fast stream of pure SO₂ is passed through, with stirring, for about two hours. The passage of gas is continued until the mixture has cooled completely; the CuBr precipitates in the form of fine yellowish-white crystals. The solid is filtered while carefully excluding all light, resuspended 5-7 times in boiled distilled water into which some SO₂ is bubbled, and filtered again. The product is finally washed with SO₂-containing alcohol, followed by SO₂-containing ether. The salt is dried for 3-4 days over H₂SO₄ and KOH in a hydrogen atmosphere, and then in vacuum.

Alternate methods: a) Acetyl bromide is added in drops to a boiling solution of cupric acetate in glacial acetic acid, containing at least 50% of acetic anhydride by volume, until the solution becomes light green and a pure white precipitate appears (D. Hardt, private communication).

b) Another starting material consists of the mixture used in the preparation of ethyl bromide from alcohol, Br_2 and red phosphorus. The mixture is filtered and an excess of $\text{CuSO}_4 \cdot 5 \text{H}_2\text{O}$ is added to the clear solution. The dark green solution is brought to a boil; crystallization soon follows [D. B. Briggs, J. Chem. Soc. (London) 127, 496 (1925)].

c) Synthesis from the elements [J. B. Wagner and C. Wagner, J. Chem. Physics 26, 1597 (1957)].

SYNONYM:

Cuprous bromide.

PROPERTIES:

Formula weight 143.46. Colorless crystals. M.p. 498°C , b.p. 1345°C ; d_4^{25} 4.72. Insoluble in H_2O ; soluble in hydrogen halide solutions, nitric acid and aqueous ammonia. Heat of formation (25°C): -24.9 kcal./mole.

CuBr exists in three modifications: γ - CuBr (type B3) below 391°C , β - CuBr (type B4) between 391 and 470°C , α - CuBr (cubic) above 470°C .

REFERENCE:

J. N. Frers. Ber. dtsch. chem. Ges. 61, 377 (1928).

Copper (I) Iodide

CuI

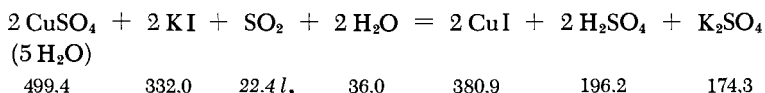

The compound is obtained as a pure white solid by precipitation of a solution of $\text{CuSO}_4 \cdot 5 \text{H}_2\text{O}$ with KI in the presence of a slight excess of sulfurous acid. The product is washed with water containing a small amount of SO_2 , then (with exclusion of air) with pure alcohol, and finally with anhydrous ether. It is then filtered with suction and freed in vacuum of the last traces of ether. Residual strongly adhering traces of water are best removed in a high vacuum, first at 110°C and finally somewhat above 400°C . A better product is obtained if a small quantity of iodine is added to the material after it has been dried at 110°C . This iodine is entirely removed at 400°C .

Alternate methods: a) Analogous to the preparation of CuBr from the reaction mixture used in the synthesis of ethyl iodide. Crystalline CuI is obtained [D. B. Briggs, J. Chem. Soc. (London) 127, 496 (1925)].

b) Synthesis from the elements [J. B. Wagner and C. Wagner, *J. Chem. Physics* 26, 1597 (1957)].

SYNONYM:

Cuprous iodide.

PROPERTIES:

Formula weight 190.45. Pure white crystalline powder. M.p. 605°C, b.p. 1336°C; d_4^{25} 5.63. Quite stable in light and air, melts without decomposition in high vacuum and in a stream of oxygen-free N_2 . The solidified melt is clear and colorless (impure materials yield dark melts). Insoluble in H_2O ; soluble in acids and aqueous ammonia; soluble in alkali iodides. Heat of formation (25°C): -16.2 kcal./mole.

CuI exists in three modifications: γ -CuI (type B3) below 402°C, β -CuI between 402 and 440°C, and α -CuI (cubic) above 440°C.

REFERENCE:

C. Tubandt, E. Rindtorff and W. Jost. *Z. anorg. allg. Chem.* 165, 195 (1927).

Copper (II) Chloride



I. DEHYDRATION OF THE HYDRATE IN A STREAM OF HCl

Pure $CuCl_2 \cdot 2 H_2O$ is recrystallized from dilute hydrochloric acid to remove traces of basic salt, and is then heated to constant weight at 140-150°C in a stream of dry HCl. The $CuCl_2$ is stored in a desiccator over H_2SO_4 and NaOH until all remaining traces of adhering HCl have been absorbed by the NaOH.

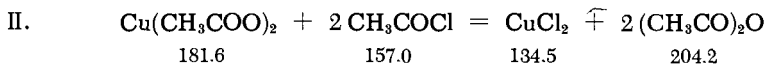

A) CUPRIC ACETATE SOLUTION

Glacial acetic acid containing a small quantity of acetic anhydride is placed in the solvent flask of a Soxhlet extractor. The extraction section of the apparatus is filled with copper turnings, air is introduced, and the solvent is brought to a boil. The solution becomes saturated with copper acetate after 1-2 hours.

B) ANHYDROUS CUPRIC CHLORIDE

The solution prepared in the Soxhlet via (A) is allowed to cool to 35°C, decanted from the solid which crystallizes out, and precipitated at 40–50°C with the stoichiometric quantity of acetyl chloride. Calculation of the stoichiometric quantity may be based on the solubility of cupric acetate in glacial acetic acid: 20 g./liter at 35°C. The precipitate is washed with either hot glacial acetic acid or cold acetic anhydride, both of which may be removed by a final washing with anhydrous ether. The product is dried at 120°C.

Alternate methods: a) High-vacuum dehydration of $\text{CuCl}_2 \cdot 2\text{H}_2\text{O}$ at 100°C [W. Biltz, *Z. anorg. allg. Chem.* **148**, 207 (1925)].

b) Refluxing of $\text{CuCl}_2 \cdot 2\text{H}_2\text{O}$ in SOCl_2 . Removal of the excess SOCl_2 by distillation and evaporation of residual solvent in vacuum [H. Hecht, *Z. anorg. allg. Chem.* **254**, 37 (1947)].

SYNONYM:

Cupric chloride.

PROPERTIES:

Formula weight 134.45. Yellow, deliquescent mass. M.p. 630°C, b.p. 655°C; d_4^{25} 3.387. Soluble in H_2O and alcohol. Solubility in ethyl alcohol (0°C) 31.9 g.; in methyl alcohol (15.5°C) 67.8 g./100 ml. Soluble in acetone, yielding a dark green solution, which becomes yellow at high dilution. Heat of formation (25°C): - 49.2 kcal./mole.

REFERENCES:

- I. H. C. Jones and W. R. Veazey. *Z. phys. Chem.* **61**, 654 (1908).
- II. D. Hardt. *Z. anorg. allg. Chem.* (in press); private communication.

Copper (II) Bromide

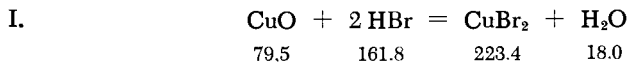

The stoichiometric quantity of CuO [or $\text{Cu}(\text{OH})_2$] is dissolved in aqueous hydrobromic acid and the solution is evaporated in vacuum over H_2SO_4 .

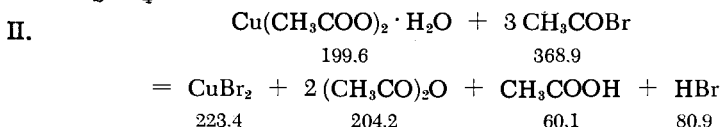

Finely divided $\text{Cu}(\text{CH}_3\text{COO})_2 \cdot \text{H}_2\text{O}$ (4.0 g.) is placed in a Pyrex tube (18 × 200 mm.) which is closed off with a rubber stopper

provided with a dropping funnel and a filtering tube. Agitation (magnetic stirrer) is started; 15 ml. of benzene is added, followed slowly by a 10% excess of CH_3COBr . The mixture is stirred for 30 minutes. The CuBr_2 precipitate is allowed to settle and the supernatant is siphoned off through the filtering tube. The reaction is brought to completion by treating the residue with additional benzene and CH_3COBr . The supernatant liquid is removed by filtration and the CuBr_2 is washed 3-4 times with anhydrous benzene. The product is dried at 150°C for two hours under nitrogen.

SYNONYM:

Cupric bromide.

PROPERTIES:

Black crystals, very deliquescent. M.p. 498°C , b.p. 900°C ; d_4^{20} 4.710. Highly soluble in H_2O , yielding a green solution; solubility (15°C) 122 g./100 g. H_2O ; soluble in acetone, alcohol and pyridine. Dry heating causes decomposition into CuBr and Br_2 . Evaporation of an aqueous solution also causes decomposition (at the b.p.). Depending on the temperature, CuBr_2 crystallizes from aqueous solutions with two or four molecules of water of crystallization, yielding highly deliquescent, brownish-green crystals. Crystal structure: monoclinic. Heat of formation (25°C): -33.2 kcal./mole.

REFERENCES:

- I. L. Vanino. *Handbuch der präp. Chemie* [Handbook of Preparative Chemistry], Part I, 2nd Ed., Stuttgart, 1921.
- II. G. W. Watt, P. S. Gentile and E. P. Helvenston. *J. Amer. Chem. Soc.* 77, 2752 (1955).

Copper Oxychloride

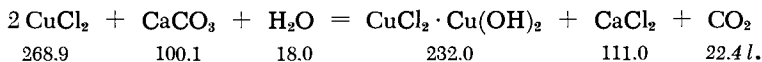

Stoichiometric quantities of cupric chloride, calcium carbonate (marble) and water are allowed to react in a bomb tube for 48 hours at 200°C . The product is filtered, freed from unreacted CuCl_2 by washing with boiling alcohol, and dried in a desiccator.

Alternate method: A conc. solution of CuCl_2 is boiled for several hours with CuO . The liquid is decanted; the product is washed with acetone and dried [E. Hayek, *Z. anorg. allg. Chem.* 210, 241 (1933)].

PROPERTIES:

Dark yellowish-green powder, decomposed by boiling water.
Crystal structure: monoclinic.

REFERENCE:

G. Rousseau, Compt. Rend. Hebd. Séances Acad. Sci. 110, 1262 (1890).

Copper (I) Oxide

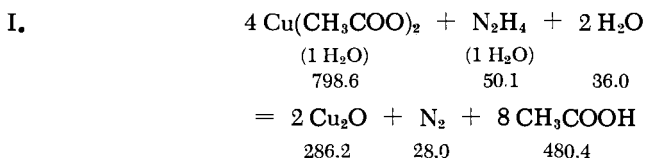

A 20% hydrazine hydrate solution (3-5 ml.) is added to 50 ml. of concentrated copper acetate solution. The solution turns green, nitrogen evolves, and a yellow to orange precipitate of Cu_2O separates on standing. The product is washed with H_2O , followed by alcohol and ether. Care must be exercised to avoid an excess of hydrazine in the reduction, since such an excess causes reduction to metallic copper.

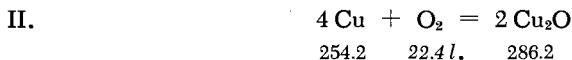

Small copper plates (e.g., 5 mm. \times 20 mm. \times 10 μ) are hung from platinum wires placed in a vertical tubular furnace; the latter is then heated to 1000°C in an atmosphere of technical grade N_2 (1% O_2). While bringing to the desired temperature and cooling down, use only pure N_2 . The reaction is completed after about 24 hours. The product composition corresponds approximately to Cu_2O [cf. C. Wagner and H. Hammen, Z. physik. Chem. B40, 197 (1938)].

Alternate methods: a) Equivalent amounts of CuO and Cu are heated in vacuum for five hours at 1000°C. The product is homogenized and reheated [F. W. Wrigge and K. Meisel, Z. anorg. allg. Chem. 203, 312 (1932)].

b) Reduction of Fehling's solution with hydrazine sulfate [M. C. Neuburger, Z. Physik 67, 846 (1931)].

c) Electrolysis of a weakly alkaline solution of NaCl at 80°C, using copper electrodes [B. B. Dey, A. Jorgarao, H. V. K. Udupa, S. Sampath and R. Viswanathan, J. Sci. Ind. Research (India) 13B, 219 (1954); Hira Lal, J. Sci. Ind. Research (India) 12B, 424 (1953)].

SYNONYM:

Cuprous oxide.

PROPERTIES:

Formula weight 143.08. Yellow powder. Red Cu_2O is identical with the yellow variety, the difference in color being caused by particle size. M.p. 1232°C ; d_4^{25} 6.04. Insoluble in H_2O ; soluble in aqueous ammonia, conc. aqueous hydrogen halide solutions, markedly soluble in alkali hydroxides. Soluble in dilute oxyacids, with formation of Cu and Cu^{++} . Crystal structure: type C3. Heat of formation (from $2\text{Cu} + \frac{1}{2}\text{O}_2$): -40.0 kcal./mole (25°C).

REFERENCES:

- I. M. Straumanis and A. Cirulis. *Z. anorg. allg. Chem.* **224**, 110 (1935).
- II. H. Dünwald and C. Wagner. *Z. phys. Chem.* **B22**, 215 (1933); E. Engelhard, *Ann. Phys. (V)* **17**, 501 (1933).

Copper (II) Oxide

CuO

The starting material, cupric nitrate, may be obtained by dissolving electrolytic copper in nitric acid and evaporating the solution to dryness on a steam bath:

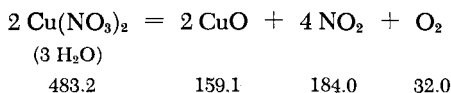

The cupric nitrate is dried in a drying oven, in which the temperature is raised very slowly from 90 to 120°C . After the material has been completely converted to the green, loose basic salt (24 hr.), it is boiled with water and filtered. The dried salt is first heated slowly to 400°C , resulting in removal of most of the nitric acid; it is then pulverized, slowly heated further to 850°C , and maintained at this temperature for one hour. It is again ground to a fine powder, reheated for several hours to about 700°C , and allowed to cool in a desiccator.

Alternate methods: a) Precipitation of $\text{Cu}(\text{OH})_2$ from a CuSO_4 solution with ammonia, followed by calcination to CuO . The product is free of sulfate. Calcination temperature 600 – 700°C [A. A. Kazantsev, *Khim. Zh., ser. B (Zh. Prikl. Khim.)* **77**, 1108 (1938)].

b) Oxidation of very pure thin copper foil at 1000°C in a stream of pure O_2 [H. H. von Baumbach, H. Dünwald and C. Wagner, *Z. phys. Chem.* **B22**, 226 (1933); K. Hauffe and P. Kofstand, *Z. Elektrochem.* **59**, 399 (1955)].

c) Precipitation from $\text{CuCl}_2 \cdot 4 \text{H}_2\text{O}$ with sodium hydroxide in the presence of CH_3OH [R. Fricke and J. Kubach, Z. Elektrochem. 53, 76 (1949)].

SYNONYM:

Cupric oxide.

PROPERTIES:

Formula weight 79.54. Black powder. M.p. 1336°C ; $d_4^{25} 6.315$. Soluble in acids and ammonia. After calcination at high temperatures, soluble only in boiling conc. acids. Crystal structure: type B26. Heat of formation (25°C): -37.1 kcal./mole .

REFERENCE:

R. Ruer and J. Kuschmann. Z. anorg. allg. Chem. 154, 69 (1926).

Copper (II) Hydroxide

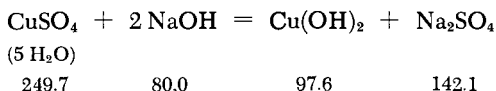
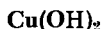

I. A solution of $\text{CuSO}_4 \cdot 5 \text{H}_2\text{O}$ is treated at 70°C with 10% aqueous ammonia until a deep blue color appears. The solution is then allowed to react with the stoichiometric quantity of NaOH, yielding a precipitate which settles well. This is filtered, washed repeatedly with warm water, and dried in vacuum over conc. H_2SO_4 .

II. Aqueous ammonia is added in drops to a boiling solution of $\text{CuSO}_4 \cdot 5 \text{H}_2\text{O}$ until the initially green precipitate acquires a blue color. The crystalline basic sulfate thus obtained is filtered and carefully washed with water. It is then digested with a moderately concentrated NaOH solution, filtered, washed, and dried in vacuum over CaO or H_2SO_4 .

SYNONYM:

Cupric hydroxide.

PROPERTIES:

Light blue, crystalline powder. Insoluble in H_2O ; soluble in acids and aqueous ammonia; fairly soluble in concentrated NaOH. The crystalline form is stable at 100°C . Heating of the freshly

precipitated hydroxide results in conversion to black, water-containing cupric oxide. d_{4}^{20} 3.368. Heat of formation (18°C): -106.7 kcal./mole.

REFERENCES:

- I. A. N. Agte and N. S. Golyenko. *Trudy Leningr. Khim.-Tekh. Inst.* **8**, 140 (1940).
- II. L. Vanino and E. Engert. *Chemiker-Ztg.* **48**, 144 (1927); B. Röttger. *J. prakt. Chem.* **73**, 491 (1858); R. Fricke and J. Kubach. *Z. Elektrochem.* **53**, 76 (1949).

Potassium Cuprate (III)



A mixture of any available finely divided potassium oxide with CuO is heated to 400-500°C in carefully dried oxygen at 760 mm. Hg.

A) POTASSIUM OXIDE, KO_x

The sealed (20 cm. long) glass tube *d* containing distilled potassium is placed in the constricted side tube *b* of the apparatus depicted in Fig. 276; the system is evacuated and flame-dried, then filled with dry nitrogen; tube *a* is fixed so that it slopes somewhat toward *c*. Tube *d* is raised above *b* and its lower end broken in a stream of nitrogen; it is then replaced in *b* by means of a wire attached to hook *e*. The system is again evacuated; the potassium inside *b* is melted and allowed to flow into *a*, care being taken to avoid plugging of the gas inlet.

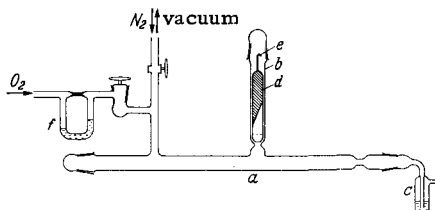

Fig. 276. Preparation of finely divided potassium oxide.

Oxidation of the potassium is achieved by admixing increasing amounts of oxygen to the nitrogen. The quantity of O_2 is adjusted by means of flowmeter *f*. When the reaction is complete, the resultant loose powder is homogenized in a vacuum ball mill (Fig. 55, p. 76) in a stream of dry N_2 , and stored in sealed glass ampoules.

ANALYSIS:

Potassium is determined as KClO_4 ; the product may also be hydrolyzed and titrated as KOH .

B) REACTION OF KO_x WITH CuO

The potassium oxide prepared in (A) is ground with the stoichiometric amount of CuO ($\text{K}:\text{Cu} = 1:1$) in the vacuum ball mill mentioned above. The grinding is carried out with careful exclusion of moisture, and is continued until the powder clings to the walls. This usually takes 5-20 minutes. The inner ground joint s_2 of the ball mill is then connected to the outer joint s_2 of the transfer device shown in Fig. 277 in such a manner that the T-shaped transfer piece is horizontal. It contains a movable aluminum pin n which fits fairly loosely into opening s_3 . To start with, s_3 is closed off with a ground cap. The mixture of oxides is transferred from the ball mill to the transfer device by shaking and knocking at the walls. The transfer device is disconnected from the mill in a stream of dry N_2 and joint s_2 is closed with a ground stopper; cap s_3 is then removed and s_3 is connected to joint s_3 on the side tube a of the main apparatus of Fig. 277. A silicon carbide boat k is located exactly below s_3 . Stopper s_2 is removed, dry N_2 is introduced through s_4 , and a small portion of the material is pushed into the boat by raising and lowering the aluminum pin n . Careful shifting of the boat followed by repeated movement of the pin allows the boat to be filled completely.

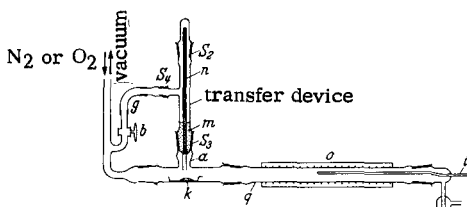

Fig. 277. Charging and heating of the KO_x - CuO mixture.

While the stream of dry N_2 continues to flow, the boat is shifted to reactor tube g , placed in furnace o (Fig. 277), which consists of an electrically heated quartz tube surrounded by a transparent protective tube. The mixture is heated to 450°C in very pure O_2 ; the formation of KCuO_2 is complete after 24 hours.

PROPERTIES:

Formula weight 134.64. Crystalline powder, steel blue to deep blue. Decomposes vigorously in water, yielding a brown-black

precipitate. Decomposes in dilute acids, evolving O_2 and forming cupric salts. Evolves chlorine and oxygen in conc. hydrochloric acid. Decomposes with loss of weight on heating above $500^\circ C$ in a stream of oxygen. Nonmagnetic; shows a characteristic x-ray diffraction pattern.

REFERENCE:

K. Wahl and W. Klemm. *Z. anorg. allg. Chem.* 270, 69 (1952).

Schweizer's Reagent

I. Copper turnings are covered with 20% ammonia containing some NH_4Cl , and air is bubbled through the suspension. An azure-blue solution of $[Cu(NH_3)_4](OH)_2$ is formed. Evaporation of the solution in a stream of dry NH_3 yields long, azure-blue needles of $[Cu(NH_3)_4](OH)_2$.

II. Freshly precipitated $Cu(OH)_2$ is dissolved in 20% ammonia solution.

PROPERTIES:

Formula weight 165.68. Schweizer's reagent dissolves cellulose.

REFERENCE:

M. E. Schweizer. *J. prakt. Chem.* 72, 109, 344 (1857).

Copper (I) Sulfide

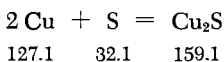

I. A mixture of stoichiometric quantities of Cu and S is placed in a quartz tube, which is sealed in high vacuum. The tube is heated until the mixture melts.

II. An evacuated, sealed glass tube contains very pure Cu at one end, while the other is charged with the stoichiometric quantity of S purified by the method of von Wartenberg (p. 342). The reaction is complete after heating 1-2 days at $400^\circ C$.

Alternate methods: a) Cupric sulfide is heated in vacuum to the melting point of cuprous sulfide. The reaction is preferably

carried out in a graphite crucible inside an evacuated tube [E. Posnjak, E. T. Allen and H. E. Merwin, *Z. anorg. allg. Chem.* **94**, 95 (1916)].

b) Cupric sulfide obtained by precipitation from a CuSO_4 solution with H_2S is reduced in a stream of $\text{H}_2/\text{H}_2\text{S}$. The optimum conditions are: a temperature of 700°C , a gas composition of 4.6% H_2 and 95.4% H_2S , and a reaction time of one hour. The product is crystalline and quite pure [N. P. Diyev and E. M. Yakimets, *Izv. Ural. Fil. Akad. Nauk SSSR* **1955**, No. 3, 5; abstract in *Chem. Abstr.* 13,638a].

SYNONYM:

Cuprous sulfide.

PROPERTIES:

Blue to blue-black. M.p. 1127°C ; d_4^{20} 5.6. Solubility (18°C): 4.95×10^{-5} g./100 g. H_2O . Very sparingly soluble in hydrochloric acid. Heat of formation (25°C): -19.6 kcal./mole.

Exists in two modification: β - Cu_2S (hexagonal) below 91°C , α - Cu_2S (type C 1) above 91°C . The latter exists only with a copper deficiency, the composition being approximately $\text{Cu}_{1.9}\text{S}$.

REFERENCES:

- I. P. Rahlfs. *Z. phys. Chem. (B)* **31**, 157 (1936); P. Ramdohr. *Z. prakt. Geol.* **51**, 1 (1943).
- II. C. Wagner. Private communication.

Copper (II) Sulfide

CuS

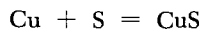

63.5 32.1 95.6

The sulfide precipitated when cupric salt solutions are treated with H_2S is not uniform. A better product is obtained from the reaction of a solution of sulfur in CS_2 with pure copper powder obtained from copper oxalate. Copper from CuO is unsuitable; it strongly absorbs H_2O vapor and thus still contains some oxygen.

A) COPPER OXALATE

A solution of $\text{CuSO}_4 \cdot 5 \text{H}_2\text{O}$ in water is reacted with an equal volume of conc. H_2SO_4 . The solution is brought to a boil, and a slight excess of boiling aqueous oxalic acid is introduced in a thin stream. The crystalline, easily filtered oxalate is repeatedly

washed with pure water, filtered through a filter crucible, and further washed until no acid can be detected.

B) COPPER POWDER

The copper oxalate is heated at 130°C to remove as much water of crystallization as possible. It is then placed in an electric furnace and heated to 320°C in a stream of purified H₂. The decomposition starts suddenly and is accompanied by a rise in temperature. Heating is continued at 220-260°C, and the product is then allowed to cool (both operations are conducted under a stream of H₂). The copper powder is stored under hydrogen.

C) COPPER SULFIDE

The copper powder obtained above is finely ground and covered with CS₂ in a beaker. Somewhat more than the theoretical amount of S is dissolved in a large volume of CS₂ and added to the contents of the beaker (the sulfur required may be obtained in sufficiently pure form by dissolving pure S in CS₂, filtering the solution through a glass filter crucible, and precipitating the filtrate with low-boiling petroleum ether). The resultant Cu₂S is transferred with the adhering CS₂ to a bomb and covered with twice the amount of S required for the formation of CuS. The bomb is filled as completely as possible with CS₂ and sealed. Then it is rotated along its long axis for four hours while surrounded with steam. The bomb is opened and contents filtered through a glass filter crucible and washed with CS₂; the residual, adhering CS₂ is removed in vacuum. The product is dried for 1-2 hours at 90-100°C in a vacuum of 0.1-1 mm. Hg.

SYNONYM:

Cupric sulfide.

PROPERTIES:

Black. M.p. (dec.) 200°C; d_4^{20} 4.6. Insoluble in H₂O, alcohol and dilute acids. Solubility (18°C): 33.6×10^{-6} g./100 g. H₂O. Somewhat soluble in solutions of (NH₄)₂S and alkali polysulfides. Soluble without residue in KCN solution. Crystal structure: type B 18. Heat of formation (25°C): -12.1 kcal./mole.

REFERENCE:

K. Fischbeck and O. Dorner. Z. anorg. allg. Chem. 182, 228 (1928).

Copper (I) Selenide

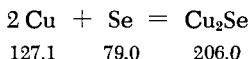

Selenium vapor carried in a stream of nitrogen is passed over Cu placed in a porcelain boat. The Se is also in a porcelain boat located ahead of the Cu in the quartz reaction tube. A thermal gradient is obtained by means of two electric heaters which maintain the temperature of the Cu at about 400°C and that of the Se at about 300°C. A well-crystallized product is obtained.

Alternate methods: a) Heating a stoichiometric mixture of Cu and Se in an evacuated, sealed quartz tube [P. Rahlfs, Z. phys. Chem. (B) 31, 1957 (1936)].

b) Preparation of Cu_2Se and CuSe from Cu and Se in a Cu_2SO_4 solution [C. Gorla, Gazz. Chim. Ital. 70, 461 (1940)].

c) Passage of H_2Se through solutions of Cu salts. Formation of CuSe and Cu_2Se [L. Moser and K. Atynski, Mh. Chemie 45, 235 (1925)].

d) Reduction of the basic selenite $\text{CuO} \cdot \text{CuSeO}_3$ [W. Geilmann and F. R. Wrigge, Z. anorg. allg. Chem. 210, 373 (1933)].

SYNONYM:

Cuprous selenide.

PROPERTIES:

Black. d_4^{21} 6.84. Exists in two modifications: tetragonal β - Cu_2Se (below 110°C), cubic α - Cu_2Se (above 110°C) (essentially a defect lattice deficient in copper). Heat of formation (25°C): -14.2 kcal./mole.

REFERENCES:

- P. Rahlfs. Z. phys. Chem. (B) 31, 157 (1936); W. Borchert. Z. Kristallogr. 106, 5 (1945); G. Gattow and A. Schneider. Z. anorg. allg. Chem. 286, 296 (1956).

Copper (I) Telluride

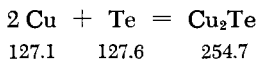

Obtained by fusing electrolytic Cu with pure Te in a crucible under a protective layer of NaCl and KCl.

SYNONYM:

Cuprous telluride.

PROPERTIES:

Gray-blue, brittle; homogeneous; contains 33 and 35 atom % Te. M.p. about 900°C. d_4^{25} 7.338. Crystal structure: hexagonal (special type), defect lattice at $\text{Cu} <_2 \text{Te}$.

REFERENCE:

H. Nowotny. Z. Metallforsch. (Metallkunde) 1, 40 (1946).

Copper (I) Sulfate

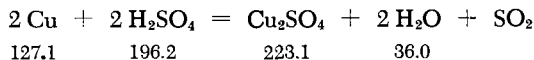

Copper turnings are placed in conc. H_2SO_4 at a temperature of 200°C. The resultant green solution is added dropwise, through an asbestos filter, to an alcohol-ether mixture (1:1) or to methanol, causing Cu_2SO_4 to precipitate in the form of almost white crystals. The product is decanted, washed with alcohol, and dried in vacuum. It cannot be prepared by treating CuCl or CuI with H_2SO_4 .

Alternate method: Double decomposition of Cu_2O with neutral dimethyl sulfate under anhydrous conditions [A. Recoura, Comptes Rendus Hebd. Séances Acad. Sci. 148, 1105 (1909)].

SYNONYM:

Cuprous sulfate.

PROPERTIES:

Nearly white crystals or grayish powder. Decomposes in water to CuSO_4 and Cu . Stable in dry air; decomposes slowly in moist air. Easily decomposed by heating; oxidizes at 200°C to CuO and CuSO_4 . Heat of formation (25°C): -197.2 kcal./mole.

REFERENCE:

J. G. F. Druce and G. Fowles. Chem. News 137, 385 (1928).

Tetraamminecopper (II) Sulfate

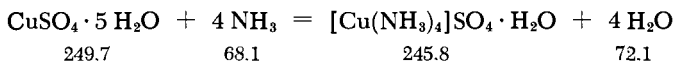
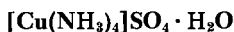

A solution of 50 g. of finely divided $\text{CuSO}_4 \cdot 5 \text{H}_2\text{O}$ in 75 ml. of conc. ammonia and 50 ml. of water is filtered and precipitated by slow addition of 75 ml. of alcohol. After standing for several hours in the cold, the crystals are filtered on a Büchner funnel, washed with a mixture of alcohol and conc. ammonia (1:1) and then with alcohol and ether, and dried by suction.

Large crystals may be obtained by covering a layer of alcohol with a layer of an ammonia solution of CuSO_4 (G. Bornemann, *Anorgan. Präparate [Inorganic Preparations]*, Leipzig, 1926, p. 156).

SYNONYM:

Cuprammonium sulfate.

PROPERTIES:

Deep blue crystals. d_4^{20} 1.81. Solubility (21.5°C): 18.5 g./100 g. H_2O . Decomposes in air. Loses H_2O and 2NH_3 on heating to 120°C; the remaining ammonia is evolved at 160°C.

REFERENCES:

H. and W. Biltz. *Übungsbeispiele aus der anorg. Chemie [Exercises in Inorg. Chem.]*, Leipzig, 1920; F. Mazzi. *Acta Cryst.* 8, 137 (1955); M. Simerská. *Czechosl. J. Phys.* 4, 3 (1954).

Copper (I) Nitride



This compound is prepared by treating CuF_2 with NH_3 .

A) STARTING MATERIALS

1. According to L. Balbiano [*Gazz. Chim. Ital.* 14, 78 (1884)] $\text{CuF}_2 \cdot 2 \text{H}_2\text{O}$ is prepared by dissolving CuO in 40% hydrofluoric acid, precipitating the fluoride with alcohol, and drying in a vacuum.

2. NH_4F is dried in vacuum over NaOH .

3. NH_3 and N_2 are carefully dried.

B) DEHYDRATION OF $\text{CuF}_2 \cdot 2\text{H}_2\text{O}$

About 1.5 g. of a mixture of 5 parts of $\text{CuF}_2 \cdot 2\text{H}_2\text{O}$ and 1 part of NH_4F , in a corundum boat placed in a quartz tube set in an electric resistance furnace, is slowly heated for two hours to 280°C in a stream of N_2 . (The NH_4F serves to depress hydrolysis during the dehydration.)

C) PREPARATION OF Cu_3N

The anhydrous CuF_2 , at 280°C (see above), is immediately reacted for three hours at the same temperature with a fast stream of NH_3 . Heating above 300°C gives products deficient in nitrogen.

SYNONYM:

Cuprous nitride.

PROPERTIES:

Formula weight 204.63. Dark green powder, stable in air at room temperature; oxidizes at 400°C in a stream of O_2 with pronounced incandescence. Decomposes spontaneously in vacuum at about 450°C . Soluble in dilute mineral acids and conc. hydrochloric acid with formation of the corresponding ammonium salt and partial formation of Cu metal. Decomposes violently with conc. H_2SO_4 and HNO_3 . d_4^{25} 5.84. Crystal structure: type D0_9 . Heat of formation (25°C): +17.8 kcal./mole.

REFERENCES:

R. Juza and H. Hahn. *Z. anorg. allg. Chem.* 239, 282 (1938); 241, 172 (1939); R. Juza. *Ibid.* 248, 118 (1941).

Copper (II) Azide

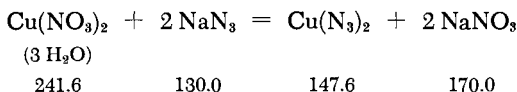

A solution of 5 g. of $\text{Cu}(\text{NO}_3)_2 \cdot 3\text{H}_2\text{O}$ in 200 ml. of H_2O is treated in the cold with 50 ml. of a solution containing 2.5 g. of NaN_3 . The resultant precipitate is suction-filtered and washed several times with cold water. The wet product is left to stand 24 hours in 50 ml. of a 2% solution of hydrazoic acid, suction-filtered, washed with alcohol and ether, and dried at room temperature. The yield is 2.5 g. of azide in the form of a brown-black mass with a reddish shine.

Alternatively, finely powdered basic CuCO_3 may be treated with an excess of 2% HN_3 , after which the workup is the same as above.

Alternate methods: a) Reaction between $\text{Cu}(\text{NO}_3)_2 \cdot 3 \text{H}_2\text{O}$ and $\text{LiN}_3 \cdot \text{H}_2\text{O}$ in alcoholic solution and decomposition of the $\text{Cu}(\text{N}_3)_2 \cdot 2 \text{NH}_3$ [M. Straumanis and A. Cirulis, Z. anorg. allg. Chem. 251, 315 (1943)].

b) Determination of azide nitrogen according to F. Feigl and E. Chargaff, Z. anal. Chem. 74, 376 (1928).

SYNONYM:

Cuprous azide.

PROPERTIES:

Black-brown powder or black-brown, opaque crystal needles, depending on the method of preparation. Very sparingly soluble in H_2O and organic solvents. Readily soluble in acids, including CH_3COOH , and in ammonia. Decomposes on heating in air into Cu and N_2 . Can be easily reduced to white CuN_3 in an aqueous solution of hydrazine. Crystal structure: orthorhombic.

Explosive properties: Harmless when moist, quite sensitive to rubbing when dry or moistened with ether. Explodes when placed in a flame. Six times stronger than $\text{Pb}(\text{N}_3)_2$ and 450 times stronger than mercury fulminate when used as a detonator.

REFERENCE:

M. Straumanis and A. Cirulis. Z. anorg. allg. Chem. 251, 315 (1943).

Copper Phosphide

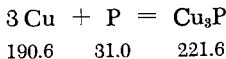

Stoichiometric amounts of Cu and red P are heated for 20 hours at 640°C in an evacuated, sealed Vycor glass tube. The reaction product is homogenized, melted in a sealed quartz tube, and heated for five hours at 1000°C .

PROPERTIES:

Silvery, shiny material with metallic appearance. Insoluble in nitric acid. d_4^{25} 7.147. Crystal structure: hexagonal. Heat of formation (25°C): -36.0 kcal./mole.

REFERENCE:

H. Haraldsen. Z. anorg. allg. Chem. 240, 337 (1939).

Copper Diphosphide

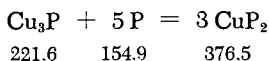

A mixture of Cu_3P with the calculated amount of red phosphorus is heated in a quartz tube for 24 hours at 600°C .

PROPERTIES:

Formula weight 125.49. Gray-black, grainy powder. Slowly dissolves in boiling nitric acid (1.2). d_4^{25} 4.201. Heat of formation (25°C): -23.5 kcal./mole.

REFERENCE:

H. Haraldsen. Z. anorg. allg. Chem. 240, 337 (1939).

Basic Copper Carbonates

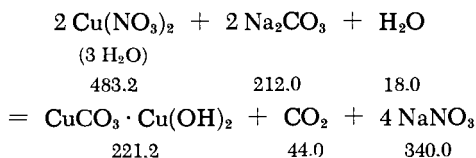

An aqueous solution of $\text{Cu}(\text{NO}_3)_2 \cdot 3\text{H}_2\text{O}$ is allowed to react at room temperature with a solution containing the equivalent amount of sodium or potassium carbonate. The greenish blue, partially colloidal precipitate of varying composition that forms is gradually transformed under the mother liquor into crystalline $\text{CuCO}_3 \cdot \text{Cu}(\text{OH})_2$. Instead of $\text{Cu}(\text{NO}_3)_2 \cdot 3\text{H}_2\text{O}$, $\text{Cu}(\text{CH}_3\text{COO})_2 \cdot \text{H}_2\text{O}$ or $\text{CuSO}_4 \cdot 5\text{H}_2\text{O}$ may be used.

Alternate methods: a) Precipitation of 100 ml. of 1N CuSO_4 with 110 ml. of 1N Na_2CO_3 , followed immediately by filtering, washing with warm water, and drying after standing for 24 hours [M. Gröger, Z. anorg. allg. Chem. 24, 127 (1900)].

b) Hot CuSO_4 solution is precipitated with sodium hydroxide. The precipitate is decanted and washed until the solid is free of alkali. It is then dissolved in acetic acid, the solution is evaporated to dryness, and the residue is taken up in water and added to a 100°C solution containing $4/5$ of the equivalent quantity of K_2CO_3 . The supernatant is decanted and the precipitate is washed with hot water and dried [W. C. Reynolds, Proc. Chem. Soc. (London) 190, 53 (1897/98)].

PROPERTIES:

Malachite-green powder, insoluble in H_2O , soluble in aqueous ammonia. On boiling in water, particularly when the latter contains alkali carbonate, deposits brown oxide. Stable to 150°C in the absence of alkali, decomposes at 220°C . Unstable toward H_2S . d_4^{25} 3.85.

REFERENCE:

G. Bornemann. Anorg. Präparate [Inorganic Preparations], Leipzig, 1926, p. 156.

$2 \text{CuCO}_3 \cdot \text{Cu}(\text{OH})_2$ (Blue Cupric Carbonate)

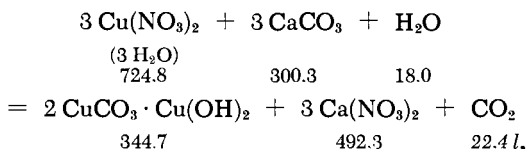

A solution of copper nitrate is mixed with an excess of pieces of chalk, and the mixture is placed in a large-diameter tube of strong glass connected to a mercury manometer. The tube is then sealed. The azurite forms at room temperature when the liberated CO_2 creates a pressure of 5–8 atm.

Alternate methods: a) From precipitated green basic copper carbonate under a CO_2 pressure of 4 atm. The reaction is markedly accelerated by the addition of azurite [V. Auger, Comptes Rendus Hebd. Séances Acad. Sci. 158, 944 (1914)].

b) A soluble copper salt is added in portions to a solution containing Na_2CO_3 , NaHCO_3 and suspended blue copper carbonate. A new portion is added only after the previous one has been converted from the green basic carbonate to the blue [V. Auger, loc. cit.].

c) Formation from $\text{CuCO}_3 \cdot \text{Na}_2\text{CO}_3 \cdot 3 \text{H}_2\text{O}$ (from saturated NaHCO_3 solution and precipitated basic CuCO_3) and moist CO_2 at 40 atm. [V. Auger, loc. cit.].

PROPERTIES:

Azure-blue crystalline powder. M.p. (dec.) 220°C; d_4^{20} 3.88. Insoluble in water. Converts to the green compound in humid air. Soluble in ammonium salt solutions. Crystal structure: orthorhombic.

REFERENCE:

H. J. Debray. Comptes Rendus Hebd. Séances Acad. Sci. 49, 218 (1859).

Copper (I) Acetylide

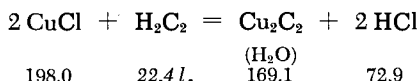
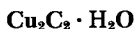

Pure CuCl (10 g.) is added in vacuum to a solution of 30 g. of NH₄Cl in 100 ml. of H₂O; it dissolves after addition of 50 ml. of conc. ammonia. A solution of 20 g. of hydroxylammonium chloride in 100 ml. of H₂O is then added, and the entire mixture is diluted with 150 ml. of H₂O. The solution becomes completely colorless after a few minutes. It is then siphoned into an evacuated vessel, and acetylene is introduced. The acetylene (from a steel cylinder) passes through a purification train consisting of sealed wash bottles equipped with fritted glass plates and filled (in succession) with HgCl₂ solution, 2N NaOH, Cu(NO₃)₂ in nitric acid and 2N H₂SO₄, followed by two wash bottles filled with 2% leuco-indigo carmine solution (made from indigo carmine and zinc dust), for the detection and absorption of O₂, and a glass-bead trap for catching any entrained liquid droplets. Upon contact with the cuprous salt solution, acetylene produces a bright red, flocculent and very voluminous precipitate. The product is suction-filtered on a fritted-glass funnel and washed with boiled water and acetone, all operations being carried out in vacuum. After thorough suction-drying, it is dried at 100°C (in high vacuum) in a drying pistol. The product contains about 95% Cu₂C₂ · H₂O and is stored in sealed ampoules filled in high vacuum.

PROPERTIES:

Brownish-red powder. Insoluble in H₂O, soluble in HCl and KCN solutions. On heating with HCl, moist, freshly prepared Cu₂C₂ · H₂O decomposes into C₂H₂ and CuCl (and a small amount of vinyl chloride). Oxidizes in air to Cu₂O, C and H₂O, the color changing to dark brown.

REFERENCES:

- R. Klement and E. Köddermann-Gros. *Z. anorg. Chem.* **254**, 201 (1947); L. Ilsvay. *Ber. dtsh. chem. Ges.* **32**, 2697 (1899).

Paris Green (Copper Acetoarsenite)

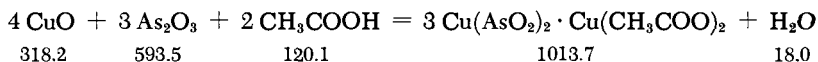

Cupric oxide is heated with 8% acetic acid, As_2O_3 is added, and the mixture is refluxed for two hours. The product is allowed to cool for half an hour, filtered, washed and dried.

Alternate method: Dilute acetic acid is allowed to react with an excess of freshly precipitated $\text{Cu}(\text{OH})_2$ and the product is separated by filtration. Dilute acetic acid is added to a solution of As_2O_3 in boiling NaOH until the color of phenolphthalein disappears. The hot solutions are mixed (mole ratio of $\text{CuO}:\text{As}_2\text{O}_3 = 4:3$) and allowed to stand for several days [S. Avery, *J. Amer. Chem. Soc.* **28**, 1159 (1906)].

PROPERTIES:

Emerald green, crystalline powder, stable to air and light. Insoluble in H_2O . Decomposes on prolonged heating in H_2O . Unstable in acids, bases and toward H_2S . Toxic.

REFERENCE:

- G. D. Luchinskiy and U. F. Churilkina. *Zh. Prikladnoy Khim.* **13**, 558 (1940).

Fehling's Solution

SOLUTION 1

34.6 g. of $\text{CuSO}_4 \cdot 5 \text{H}_2\text{O}$ dissolved in 500 ml. of H_2O .

SOLUTION 2

173 g. of crystalline potassium sodium tartrate (Rochelle salt) and 53 g. of NaOH are dissolved in H_2O and diluted to 500 ml.

Equal volumes of the two solutions are mixed before use.

PROPERTIES:

Deep blue solution, reduced to Cu_2O on heating with reducing agents (sugar test in urine).

REFERENCE:

J. D'Ans and E. Lax, Taschenbuch für Chemiker und Physiker [Pocket Book for Chemists and Physicists], Berlin, 1943, p. 1779.

Very Pure Silver

Crude silver (e.g., from silver residues, see p. 1029) is dissolved in conc. nitric acid, and the diluted solution is precipitated in the cold with a solution of very pure NaCl . The precipitate is washed several times with cold water and dissolved in freshly prepared ammonia solution. After several hours of standing, the solution is filtered. Silver chloride is precipitated from the filtrate with very pure nitric acid, washed with H_2O until no further nitrate can be detected, and reduced in a silver dish with invert sugar* and NaOH (from Na metal) at 60°C , with sucrose and NaOH , or with a boiling alkaline solution of formaldehyde (the formaldehyde should be distilled prior to the preparation; sugar solutions should be filtered through bone charcoal and recrystallized). The resultant silver slurry is filtered, carefully washed free of chloride ion with water, dried and melted down to small ingots over pure CaO . If the metal is heated no longer than absolutely necessary for melting, and if the resultant metal grains are cooled in a reducing flame, the silver obtained is quite pure; it contains about 0.001% S and traces of C, AgCl and O.

The silver obtained in this manner is further purified by electrolysis. The greater part of the grains is used as the anode (fritted glass finger filled with the Ag) against a cathode of pure silver (wire or sheet). The electrolyte is a 10% AgNO_3 solution prepared from the remaining melted silver and very pure nitric acid. The power supply lead is a strip of fine sheet silver whose upper surface is protected by a layer of asphalt or Bakelite lacquer. The electrolysis is carried out at a constant voltage of 1.39 v. across the terminals. The silver flakes depositing on the cathode are removed from time to time, carefully washed, dried and fused to ingots in a stream of pure hydrogen in a boat made of very pure CaO .

*A 1:1 mixture of dextrose and levulose.

PROPERTIES:

Atomic weight 107.88. M.p. 960.5°C, b.p. 2170°C; d_4^{20} 10.497. Crystal structure: type A 1.

REFERENCES:

- O. Hönigschmid and R. Sachtleben. Z. anorg. allg. Chem. 195, 207 (1931); Th. W. Richards and R. C. Wells. Z. anorg. allg. Chem. 47, 56 (1905); O. Hönigschmid, E. Zintl and M. Linhard. Z. anorg. allg. Chem. 136, 263 (1924).

Silver Powder

Pure AgCl is stirred with water, allowed to react with sodium hydroxide, and reduced with glucose, which is added to the boiling suspension in small portions. Samples are removed from time to time, filtered and carefully washed. If the Ag yields a completely clear solution on heating in chloride-free HNO₃, the reduction is complete. The medium must be kept alkaline throughout the reaction; an excess of glucose should be avoided. The product is filtered, washed free of base, and dried at 100°C.

Alternate methods: a) Reduction of AgCl with aqueous formaldehyde [L. Vanino, Ber. dtsh. chem. Ges. 31, 1764 (1898)].

b) Heating finely powdered Ag₂O to 500°C [F. Jirsa and J. Jelinek, Z. anorg. allg. Chem. 158, 63 (1926)].

c) Reduction of Ag₂O with H₂O₂ and drying at 250°C [F. Jirsa and J. Jelinek, loc. cit.].

PROPERTIES:

Gray, crumbling powder. According to Vanino, the product of the reduction is a loose, black powder.

REFERENCE:

- G. Bornemann. Anorg. Präparate [Inorganic Preparations], Leipzig, 1926, p. 161.

Silver from Residues

I. The collected residues are allowed to react with hydrochloric acid (1:1). The precipitate is allowed to settle and the supernatant is siphoned off. The precipitate is washed free of iron by repeated decantation with hydrochloric acid and water, filtered with suction,

placed in a large porcelain dish, mixed with HCl (1:1), and reduced with Zn rods with stirring. After disappearance of the white particles of AgCl, the Ag slurry is washed free of acid and Zn with hot water and filtered. The washings should be tested for the presence of Zn. The resultant silver slurry can be processed further either to Ag or AgNO₃ (when only pure AgCl is required, an ammonia solution of the salt may be reduced with 20% hydrazine hydrate).

a) The silver slurry is dried and fused with a small quantity of borax in a Hessian crucible. The fused Ag is made into granules by careful pouring into water.

b) The silver slurry is dissolved in nitric acid (1:1); the solution is filtered and evaporated in a porcelain dish on a steam bath until crystallization. The last traces of nitric acid are removed by drying in a vacuum or by fusion.

Alternate methods: The silver obtained from the reduction with Zn is dissolved in dilute nitric acid. The solution is filtered and AgCl is precipitated by addition of dilute hydrochloric acid to the hot solution. The precipitate is filtered, carefully washed with warm water, and dried. Then 20 parts of AgCl are mixed in a mortar with 10 parts of Na₂CO₃ and 3 parts of KNO₃. The mixture is placed in a red-hot Hessian crucible. The reduction proceeds according to $2 \text{AgCl} + \text{Na}_2\text{CO}_3 = 2 \text{Ag} + 2 \text{NaCl} + \text{CO}_2 + \frac{1}{2} \text{O}_2$. The AgCl may also be added in portions to the mixture heated slightly above 960°C. A melt of Ag is formed immediately. The Ag ingot is cleaned by boiling in water containing sulfuric acid (G. Bornemann, Anorg. Präparate [Inorganic Preparations], Leipzig, 1926, p. 160).

REFERENCES:

Handbuch für das Eisenhüttenlaboratorium [Handbook for the Iron Works Laboratory], Vol. I, p. 317 (1939). F. Specht. Quantitative anorganische Analyse in der Technik [Quantitative Inorganic Analysis in Engineering], 1953.

II. SILVER FROM PHOTOGRAPHIC SOLUTIONS

The photographic solution is made alkaline with ammonia and allowed to react with a slight excess of ammonium sulfide. The mixture is allowed to stand overnight and the supernatant liquid is siphoned off. The residue is suction-filtered and washed with water. The precipitate, after addition of a small amount of anhydrous borax, is placed in a Hessian crucible, dried and calcined at 960°C. The borax is leached out of the product with hot water.

Alternate methods: a) Zinc rods are placed in exhausted fixing solutions and allowed to stand for about one week with frequent

agitation. The precipitated Ag slurry is filtered off and cupellated with lead (H. Grubitsch, *Anorg. präparative Chemie [Inorganic Preparative Chemistry]*, Vienna, 1950, p. 454; for description of cupellation, see also Hackh's *Chemical Dictionary*, 3rd ed., The Blakiston Co., Philadelphia-Toronto, 1944).

b) The pH of the solution is adjusted to 6.9-7.2 with soda, and CuSO_4 or $\text{Al}_2(\text{SO}_4)_3$ is added. Silver precipitates with the corresponding hydroxide (when the Ag is not present as AgCl , FeCl_3 is added). The voluminous precipitate is treated after 3-4 days with sulfuric acid of increasing concentration (up to 96%), which removes hydroxides, gelatin and other impurities and concentrates the Ag to 20-50% of the total. The Ag is fused in a crucible after adding some borax (U.S. Pat. 2,131,045).

REFERENCE:

Handbuch für das Eisenhüttenlaboratorium [Handbook for the Iron Works Laboratory], Vol I, p. 318 (1939).

Silver Mirrors

Of the two methods given below, the first is best for flat surfaces, while the second is used for concave surfaces, such as vacuum jackets. With variations, however, they may also be used in other applications. Careful and thorough cleaning of the mirror surface (glass, quartz, porcelain, mica, plastic, etc.) is a necessary condition for any successful silvering effort.

I. A) PREPARATION OF THE MIRROR SURFACE

The silver coating on old mirrors is dissolved with nitric acid and the surface is rinsed with water. The hands are scrubbed with soap, and the soap foam is transferred to the surface, which is then scrubbed for some time with the foam. Scrubbing is continued while the surface is rinsed, first with tap water, then with distilled water. In the end, the units surface must be perfectly wetted by the water. If any greasy, water-repellent area remains, the entire operation must be repeated. After rinsing, the piece to be mirrored is placed in a dish of distilled water.

If it is desired to polish the silver mirror after deposition, the surface is first covered with a thin paste prepared from equal parts of alcohol, ammonia and precipitated calcium carbonate, and the paste is rubbed in vigorously with cellulose pulp. This cleaning mixture may then be removed with some fresh cellulose.

B) PREPARATION OF THE SOLUTION

The following are weighed into three clean test tubes: 1) 5 ± 0.1 g. of AgNO_3 , 2) 1.1 ± 0.05 g. of AgNO_3 , 3) 0.9 ± 0.05 g. of Rochelle salt. The second and third of these compounds are dissolved in a few milliliters of distilled water.

The following are held in readiness: two dark brown bottles (500 ml.) with ground stoppers; three beakers or Erlenmeyer flasks with capacities of a) 800, b) 300, c) 100 ml.; a 20-ml. burette; a glass funnel.

C) SILVER SOLUTION

The 5 g. of AgNO_3 (test tube 1) is dissolved in 50-100 ml. of distilled water in vessel *b*; one third of the solution is held in reserve in *c*. Ammonia is added (with vigorous swirling) from the burette to the larger portion in *b* until the resultant deep brown precipitate just dissolves. Some AgNO_3 solution is then added from the reserve, ammonia is again added in drops, and the procedure is repeated until the reserve has been exhausted. The last solution added should be AgNO_3 , and the mixture should be somewhat turbid. If the solution is clear at the end of the operation, a few crystals of AgNO_3 are dissolved in distilled water and added to the mixture until turbidity sets in. The Ag solution is diluted to 500 ml. with distilled water and transferred without filtering to one of the brown bottles. Thus protected against light, it may be stored almost indefinitely.

D) REDUCING SOLUTION

The solution of Rochelle salt (test tube 3) is added to 500 ml. of distilled water in vessel *a*; the mixture is brought to a boil, and the AgNO_3 solution from test tube 2 is added, first in drops (the addition causes a boiling point elevation and thus a delay in boiling—do not add the AgNO_3 too fast!), then more rapidly. The resultant brown-colored turbidity gradually transforms into a greenish-gray precipitate. The solution is boiled over a small flame for six additional minutes, filtered and stored in the second brown bottle. In this bottle the solution is stable for several months.

E) SILVERING

Small mirrors are best made in a thoroughly cleaned crystallizing dish or a photographic developing tray. Larger mirrors are best prepared by creating a 5-cm.-high leakproof rim of paraffined paper at the edge of the surface, so that the surface itself serves as the bottom of the dish.

Equal volumes of the silver-containing and reducing solutions are measured out in a graduated cylinder in amounts sufficient to cover the mirror surface with a layer of liquid 1 cm. deep. The mixture is then immediately poured on to the surface and the dish is vigorously rocked. A bluish, rapidly thickening deposit is formed after a few minutes on the mirror and the glass walls. The solution becomes turbid and small silver particles appear on the surface of the liquid. The solution is poured off, the mirror rinsed with distilled water, and the silvering process repeated with fresh solution. Finally, the silvered piece is rinsed with distilled water followed by alcohol, and the mirror is allowed to dry while standing on end. It is advisable to grip the mirror with lab. tongs or forceps and not to touch it with the fingers.

In the case of mirrors silvered on the back, the silver layer is protected with a lacquer coating (shellac, varnish). The Ag precipitated on the glass side is removed with a cotton pad moistened with highly diluted nitric acid.

F) POLISHING

The operation is carried out on the day following the silvering. A piece of dust-free chamois leather is tightened around a ball of wool ("polishing ball"). The surface is then carefully gone over with the ball and is then rubbed with increasing pressure. If this does not produce the desired result, some jeweler's rouge is spread on the ball, the excess is brushed off, and polishing is continued.

The mirror prepared as above has a golden sheen (on the back side).

II. A) PRETREATMENT

The glass surface to be treated, such as the inner space of a jacket, is cleaned for 30 minutes at 60°C with freshly prepared cleaning solution and is then thoroughly rinsed with water. This is followed by a 10-minute treatment with 1.4% hydrofluoric acid and another rinse with water. Then the surface is treated for 10 minutes with technical grade conc. nitric acid (d 1.52) and rinsed with water; the final rinse is distilled water.

B) SILVERING

The following three solutions are prepared separately:

- 1) 50 g. of AgNO_3 in two liters of water; stored in the dark in a ground-joint bottle;
- 2) 90 g. of very pure, chlorine-free KOH in two liters of water; rubber-stoppered bottle;

3) 80 g. of sugar in 800 ml. of water; a mixture of 100 ml. of 96% alcohol and 3.5 ml. of very pure, chlorine-free nitric acid (d 1.42) is added to this solution, which is then stored for at least one week before use in a ground-joint bottle.

The three solutions (16:8:1) are mixed as follows: conc. ammonia is added in drops with stirring to solution (1) until the initially formed precipitate just dissolves. Solution (2) is then added, yielding a dark brown to black precipitate (a green precipitate indicates a deficiency of ammonia and the material must be rejected). If the precipitate is of the right color, ammonia is again added slowly with stirring until the precipitate just disappears. A slight excess of ammonia delays the deposition of silver in the next stage, but does not prevent it. The resultant mixture of (1) and (2) may be stored, at most, for one hour. Solution (3) is added immediately before use. The deposition of silver lasts 10 to 30 minutes, depending on the excess of ammonia. Its completion is recognizable by the appearance of a flocculent precipitate. The solution must be removed at this point to avoid harm to the mirror. The surface is thoroughly rinsed with distilled water to remove all residues (including silver slurry) and dried, preferably in vacuum. The silver layer and the glass do not separate on heating to 450°C in a high vacuum of 10^{-5} mm., which is particularly important in silvering of vacuum jackets for distillation columns.

REFERENCES:

- I. W. Bothe. J. prakt. Chem. 42, 191 (1863); R. Böttger. Polytechn. Notizbl. 38, 217 (1883); 39, 324 (1884); H. Kreuzler, Die Sterne 9, 42 (1929); E. von Angerer. Techn. Kunstgriffe [Industrial Techniques], 5th ed., Braunschweig, p. 61.
- II. P. W. Schenk. Private communication.

Colloidal Silver

A mixture of 200 ml. of 30% FeSO_4 solution, 280 ml. of 40% sodium citrate, and about 50 ml. of 10% NaOH is added to 200 ml. of 10% AgNO_3 solution. The resultant colloidal silver precipitate is allowed to settle and washed 4-5 times with 10% ammonium nitrate solution and finally twice with 96% alcohol. The mixture is centrifuged and the product carefully dried on a water bath or in a desiccator.

Alternate methods: a) A 0.001N AgNO_3 solution (100 ml.) is treated with a few drops of freshly prepared tannin solution and one drop of 1% sodium carbonate solution. Heating the mixture results in formation of a sol (W. Ostwald, Kleines Praktikum der Kolloidchemie [Lab. Manual for Colloid Chem.], 7th ed., 1930, p. 4).

b) A warm 0.001N solution of AgNO_3 is reduced by dropwise addition of 0.005% hydrazine hydrate solution (Ag sol according to Gutbier, cited in W. Ostwald, loc. cit.).

c) Silver sol by electrical atomization: Two silver rods, 2-3 mm. in diameter, are bent at right angles 2 cm. from their ends and the bent sections immersed in a beaker with distilled water so that they form a U figure. A current of 4-6 amp. should flow at 110 volts through the short-circuited electrodes (rheostat control). Clouds of colloidal Ag are formed when an electric arc is passed through the gap between the two ends. Addition of a few drops of 2% sodium carbonate solution is recommended [G. Bredig, *Angew. Chem.* 951 (1898)].

PROPERTIES:

Black, grainy powder containing about 97% Ag. Soluble in water, yielding a red-brown to black, extremely finely divided Ag sol.

REFERENCE:

M. Carey Lea. *Amer. J. Sci.* 37, 476 (1889).

Silver Iodide

AgI

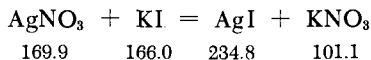

At atmospheric pressure silver iodide exists in three modifications: α -form (cubic, type B3), β -form (hexagonal, type B4) and γ -form (cubic, type B3). At room temperature, the rate of interconversion between the α - and β -forms is so low that the two forms are stable when stored alone or as a mixture. The silver iodide precipitated from solutions usually consists of a mixture of these two modifications. When physical uniformity of the product is not a factor, chemically pure AgI may be prepared in large quantities by the following method.

Very pure KI (83 g.) is dissolved in 8.3 liters of distilled water, and 85 g. of very pure AgNO_3 in 8.5 liters of water. The KI solution is added, with constant stirring, to the AgNO_3 solution. A milky liquid is initially formed; flocculation occurs only later. The supernatant is siphoned off after standing 2-3 hours, the precipitate is transferred to a three-liter bottle, two liters of distilled water is added, and the mixture is shaken vigorously to

disperse the small clumps of iodide. The flocculent precipitate settles rapidly, and the clear supernatant may be siphoned off after about five minutes. The product is cleaned by decantation until all the KNO_3 has been removed. The wash water is allowed to remain in contact with the precipitate overnight to remove all of the possibly adsorbed electrolyte (which is hard to dislodge). (Test for KNO_3 : evaporation to dryness of 200 ml. of the wash water in a platinum dish. Blank test with the distilled water used for washing.) The precipitate is placed on a piece of hard filter paper and dried at $110\text{--}120^\circ\text{C}$. The dry AgI is easily ground to a fine powder.

The mixing of the solutions and the washing operations must be carried out in the absence of daylight. The product may be exposed to daylight only when it is completely free of impurities.

PROPERTIES:

Yellow, crystalline. M.p. 556.8°C , b.p. 1506°C . Insoluble in H_2O ; solubility (25°C): $0.25 \cdot 10^{-6}$ g./100 g. H_2O ; almost insoluble in ammonia; appreciably soluble in conc. hydriodic acid and conc. solutions of alkali iodides, particularly when hot; soluble in $\text{Na}_2\text{S}_2\text{O}_3$ solution. Heat of formation -14.95 kcal. per mole.

HEXAGONAL β - AgI

Silver iodide as precipitated above is dissolved in a conc. solution of potassium iodide. The solution is filtered and poured into water. The AgI precipitates as a thick flocculate. It is washed with water (by decantation) until the iodide ion is no longer detectable by the AgNO_3 test. The AgI is filtered and dried at room temperature.

d_4^{20} 5.696; crystal structure: type B4.

CUBIC α - AgI

a) Cubic AgI is always formed when hexagonal or mixed AgI is pulverized.

b) Silver iodide is dissolved in a conc. solution of AgNO_3 . The solution is filtered and poured into water. Fine-grained, slowly coagulating AgI is formed. It is washed by decantation until the silver ion cannot be detected in the wash water. The mixture is filtered and the product dried at room temperature.

d_4^{20} 5.680; crystal structure: type B3.

REFERENCE:

N. H. Kolkmeijer and J. W. A. van Hengel. *Z. Kristallogr.* **A 88**, 317 (1934).

Silver Chlorate

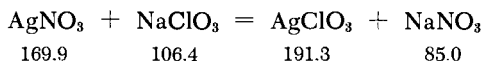

Solutions of 170 g. of AgNO_3 and 106 g. of NaClO_3 , each dissolved in 100 ml. of 85°C water, are combined and cooled to 0°C . The supernatant is carefully decanted and 50 ml. of H_2O (0°C) is added to the residue. The resultant crystals are suction-filtered; they are 95% pure.

A purer product may be obtained by dissolving the residue remaining after the above decantation in 125 ml. of H_2O at 90°C , cooling to 0°C , and suction-filtering. The crystals are redissolved in 120 ml. of H_2O at 90°C , cooled to 0°C , suction-filtered, and dried in a desiccator. The yield is about 118 g. of 99.7% AgClO_3 .

The compound should be stored in dark flasks. Since AgClO_3 is a strong oxidant, extreme care should be exercised when it is brought into contact with easily oxidized materials, especially organic substances.

PROPERTIES:

White crystals. M.p. 230°C , decomposes at 270°C ; d 4.43.

REFERENCE:

- D. G. Nicholson and C. E. Holley in: W. C. Fernelius, *Inorg. Syntheses*, Vol. II, New York-London, 1946, p. 4.

Silver Oxide

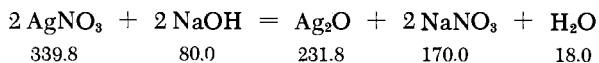

Equivalent quantities of a conc. solution of AgNO_3 and a dilute solution of NaOH (both prepared with CO_2 -free water) are mixed; the resultant precipitate is decanted and washed with CO_2 -free water. The precipitate is centrifuged, suction-filtered, and dried at 85 - 88°C in a stream of CO_2 -free air.

Alternate methods: a) Precipitation of a dilute AgNO_3 solution with $\text{Ba}(\text{OH})_2$, with careful exclusion of CO_2 [E. Laue, *Z. anorg. allg. Chem.* 165, 336 (1927)].

b) Electrolytic preparation: A 25-30% NaNO_3 solution is electrolyzed at room temperature at minimum current density (anode current density is important), using a silver anode and a nickel cathode positioned as close as possible. [K. Merei, Magyar. Chem. Folyoirat 45, 197 (1913)].

PROPERTIES:

Dark brown to brown-black powder. M.p. (dec.) 300°C ; d_4^{25} 7.220. Insoluble in water [solubility (20°C): $2.14 \cdot 10^{-3}$ g./100 g. H_2O]; somewhat soluble in NaOH . Moist Ag_2O is quite insensitive to light. Some decomposition occurs on drying. Crystal structure: type C3. Heat of formation (25°C): -7.3 kcal./mole.

REFERENCE:

E. H. Madsen. Z. anorg. allg. Chem. 79, 197 (1913).

Silver Peroxide

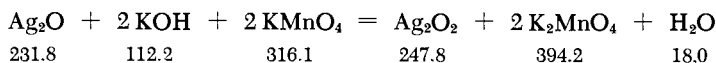

Solutions of AgNO_3 and KMnO_4 are combined and an excess of KOH is added. The resultant precipitate is filtered in a glass filtering crucible, washed with ice-cold water until the filtrate is colorless, dried for two hours at 110°C , and placed for 24 hours in a desiccator over P_2O_5 . An anhydrous product containing up to 60% Ag_2O_2 is obtained.

Alternate methods: a) Treatment of AgNO_3 solution with a solution of potassium or ammonium persulfate [H. Marshall, J. Chem. Soc. (London) 59, 775 (1891)].

b) Reaction of metallic Ag with ozone-containing O_2 at 240°C ; use of lower temperatures is also possible if Fe_2O_3 or Pt is used as catalyst [W. Manchot and W. Kampschulte, Ber. dtsh. chem. Ges. 40, 2891 (1907)].

c) Reaction of NaOCl with Ag_2O at $75-80^\circ\text{C}$ [R. L. Dutta, J. Indian Chem. Soc. 32, 95 (1955)].

d) Hydrolysis of $\text{Ag}_7\text{NO}_{11}$ (from anodic oxidation of AgNO_3 solutions) and thermal decomposition of $\text{Ag}_7\text{NO}_{11}$ [G. M. Schwab and G. Hartmann, Z. anorg. allg. Chem. 281, 183 (1955)].

PROPERTIES:

Gray-black powder. Decomposes above 100°C into Ag and O_2 ; d_4^{25} 7.483. Soluble in conc. HNO_3 , from which it precipitates

on dilution. Decomposes in hot conc. H_2SO_4 with evolution of O_2 . Strongly oxidizing.

REFERENCE:

F. Jirsa. Z. anorg. allg. Chem. 225, 302 (1935).

Sodium Orthoargentite

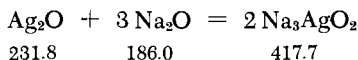

Stoichiometric quantities of pure, absolutely dry Na_2O and dry Ag_2O (dried in vacuum at 80°C) are weighed in the absence of moisture and CO_2 . The two starting materials are ground to a fine powder and intimately mixed in the vacuum ball mill shown in Fig. 55, p. 76. The mixture is transferred (with exclusion of air) to a sintered magnesia boat placed in a protective tube of Fe or Ag which itself is positioned in a heating tube (Vycor or quartz). The heating tube is evacuated and the mixture heated to 400°C . The product is homogenized by grinding and reheating.

PROPERTIES:

Formula weight 208.85. Light green powder, highly sensitive to moisture. Decomposed to a black substance even by small quantities of water vapor. Stable up to 450°C in vacuum.

REFERENCE:

E. Zintl and W. Morawietz. Z. anorg. allg. Chem. 236, 372 (1938).

Silver (I) Sulfide

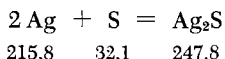

I. Pure sulfur vapor, carried in a stream of N_2 , is passed over pure Ag at 250°C . The S and Ag are in two separate boats placed in a quartz tube. Alternatively the S may be placed in a quartz

tube 18 cm. long and 16 mm. I.D. with a constriction in the middle (Fig. 278). That tube is open at one end and narrows to a conical nozzle at the other. The Ag is placed in a quartz tube, of the same diameter and about 9 cm. long, constricted at both ends in such a way that one of the ends fits the nozzle of the other tube. The other end is attached by means of a ground joint to an outlet tube for unreacted S vapor. The S, in a boat, is placed in the first of the two chambers formed by the 18-cm.-long quartz tube. Then the tubes containing the S and Ag are placed inside a larger quartz tube set in an electric furnace. The furnace is heated to 350°C in such a way that sulfur is distilled from the first into the second chamber of the 18-cm.-long tube (purification). The furnace is then set at 250°C and heating is continued in a stream of N₂.

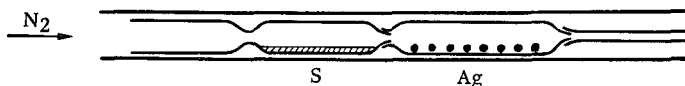

Fig. 278. Preparation of silver (I) sulfide.

Plugging of the outlet tube with excess S is prevented by heating the tube (if necessary, with an additional electric furnace). Depending on the flow rate, the conversion of 10 g. of Ag requires 6 to 8 hours. The excess S remaining in the Ag₂S after completion of the reaction is removed by heating in a stream of N₂. The temperature is maintained below 300°C to prevent sulfur from being driven off from the Ag₂S.

II. Very pure Ag and S are placed at opposite ends of an evacuated, sealed glass tube previously cleaned by the von Wartenberg method (p. 342). An excess of S is used. The tube is heated for 1-2 days at 400°C. It is then pulled (halfway) out of the furnace so that the end containing the sulfur is exposed on the outside. This enables the free sulfur to sublime from the product onto the cold excess sulfur. The reaction is complete within about 12 hours.

Alternate methods: a) Precipitation of an ammoniacal solution of AgNO₃ with H₂S. The precipitate is washed with water and dried at 150°C in a stream of CO₂. Excess S is removed by heating for one hour at 350-400°C in a stream of H₂ [E. von Britzke and A. F. Kapustinski, Z. anorg. allg. Chem. **205**, 95 (1932)].

b) Fusion of the calculated amounts of Ag and S in a pressure vessel [A. M. Gaudin and D. W. McGlashan, Econ. Geol. **33**, 143 (1932)].

SYNONYM:

Argentous sulfide.

PROPERTIES:

Black, crystalline. M.p. 845°C; d_4^{20} 7.234, $d_4^{17.6.4}$ 7.072. Soluble in KCN solution, insoluble in aqueous ammonia. Transition point β -Ag₂S (rhombic) \rightarrow α -Ag₂S (cubic): 179°C. Heat of formation (α -Ag₂S, 25°C): -7.5 kcal./mole.

REFERENCES:

- I. O. Hönigschmid and R. Sachtleben. Z. anorg. allg. Chem. 195, 207 (1931).
- II. C. Wagner. Private communication.

Silver (I) Selenide

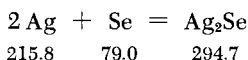
Ag₂Se

A boat containing selenium and (behind it) a boat containing metallic silver are placed inside a quartz tube. The tube is surrounded by two electrical furnaces, so that the Se is heated to 300°C, while the Ag is at 400°C. A stream of O₂-free nitrogen carries the Se to the silver (see Fig. 278, preparation of Ag₂S). The Se vapor is passed over the metal until large amounts of Se begin to accumulate behind the Ag. The heat is maintained at 400°C for some time after that to remove any Se which may have adhered to the product surface. The conversion of 5 g. of Ag requires 6-8 hours. Dissociation begins above 400°C.

Alternate method: Reaction of soluble Ag salts with CuSe. The reactions with Cu₂Se and Cu₃Se₂ give metallic Ag as a by-product [W. Geilmann and Fr. W. Wrigge, Z. anorg. allg. Chem. 210, 378 (1933)].

PROPERTIES:

Black, crystalline. d_4^{24} 8.187. Crystal structure: at 75°C tetragonal with $c/a = 0.66$; at 80°C tetragonal with $c/a = 0.94$; at 240°C cubic. Heat of formation (cubic Ag₂Se, 25°C): -5.0 kcal. per mole.

REFERENCE:

- O. Hönigschmid and W. Kapfenberger. Z. anorg. allg. Chem. 212, 198 (1933).

Silver (I) Telluride

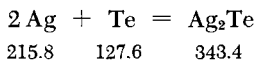

Prepared by passing Te vapor over Ag. Nitrogen serves as the carrier gas and the reaction temperature is 470°C. The flow rate of the Te vapor should be slow; i.e., the amount of Te entering the reaction chamber should not exceed the reactive capacity of the Ag. The apparatus is identical to that used for Ag₂Se. The conversion of 3 g. of Ag requires 72-96 hours. Excess Te is removed by heating to 500-540°C in high vacuum. Well-crystallized products are obtained.

Alternate method: Heating Ag in a porcelain crucible in an atmosphere of Te, with exclusion of air [P. Rahlfs, Z. phys. Chem. (B) 31, 157 (1936)].

PROPERTIES:

Gray-black, crystalline. d_4^{25} 8.318. Transition point β -Ag₂Te (rhombic) \rightarrow α -Ag₂Te (cubic): 149.5°C. Heat of formation (β -Ag₂Te, 25°C) -5.0 kcal./mole.

REFERENCE:

O. Hönigschmid, Z. anorg. allg. Chem. 214, 281 (1933).

Silver Sulfate

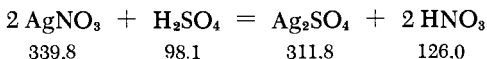

A solution of AgNO₃ in some H₂O is treated with 1:1 sulfuric acid. The Ag₂SO₄ precipitate is centrifuged, dissolved in hot conc. H₂SO₄ (in a Pt dish if high product purity is required), and boiled for several minutes to expel the nitric acid. The acid sulfate which crystallizes on cooling is centrifuged and treated with water in a Pt dish. The normal sulfate thus crystallizes as a fine powder (evolution of heat). The supernatant is decanted and the crystals washed with pure water until free of acid. The Ag₂SO₄ is centrifuged and dried on an air bath at 110°C. The entire operation must be conducted in a dustproof atmosphere.

Alternate methods: a) Treatment of AgNO₃ solution with Na₂SO₄ solution [O. Hönigschmid and R. Sachtleben, Z. anorg. allg. Chem. 195, 207 (1931)].

b) Solution of Ag metal in sulfuric acid (O. Hönigschmid and R. Sachtleben, loc. cit.).

c) Finely divided Ag_2SO_4 is obtained by precipitation of its aqueous solution with alcohol. The product is dried in vacuum at 100°C [H. Hahn and E. Gilbert, Z. anorg. allg. Chem. 258, 91 (1949)].

PROPERTIES:

Colorless crystals. M.p. 657°C , decomposes at 1085°C ; d_4^{15} 5.460. Sparingly soluble in water; solubility (18°C): $2.57 \cdot 10^{-2}$ g./100 g. H_2O . Slightly decomposed by light, acquiring a light-violet color. Dissociates on melting, acquiring a yellow color which disappears on treatment with gaseous SO_2 . Crystal structure: orthorhombic. Heat of formation (25°C): -170.5 kcal./mole.

REFERENCE:

Th. W. Richards and G. Jones. Z. anorg. allg. Chem. 55, 72 (1907).

Silver Sulfite

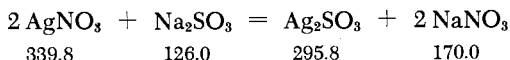

A solution of AgNO_3 is treated at room temperature with the stoichiometric quantity of Na_2SO_3 solution, yielding a precipitate of Ag_2SO_3 , which is filtered, washed with well-boiled water, and dried in vacuum.

Alternate method: Precipitation of aqueous AgNO_3 with sulfurous acid [J. Muspratt, Liebigs Ann. 50, 286 (1853)].

PROPERTIES:

Colorless powder. Sparingly soluble in water, soluble in aqueous ammonia. Decomposes in light and on heating, forming the dithionate and sulfate. Insoluble in liquid SO_2 .

REFERENCES:

P. Berthier. Ann. Chim. Phys. (3) 7, 82 (1817); K. Seubert and M. Elten. Z. anorg. allg. Chem. 4, 44 (1894).

Silver Amide

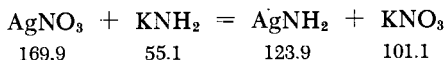

Silver amide is formed in the reaction between potassium amide and silver nitrate, both dissolved in liquid ammonia. Good

results are obtained with the two-arm tube shown in Fig. 279, in which KNH_2 solution is allowed to flow into excess AgNO_3 solution, causing precipitation of AgNH_2 .

A) KNH_2

First, KNH_2 is prepared in arm *B* from potassium metal and NH_3 . To achieve this, inlet tube *c* is connected to a source of absolutely dry NH_3 and the entire apparatus is dried by passing through NH_3 and heating. Then *a* is temporarily closed off with a stopper and oxide-free K, together with a few milligrams of sponge Pt as catalyst, is introduced at *b* in a stream of NH_3 . Inlet tube *b* is melt-sealed to a pressure-resistant tip, the pressure gradient required for the glass-blowing operation being achieved by brief alternate closing and opening of inlet *a* with a finger. The AgNO_3 is now introduced into arm *A* and dried in a stream of NH_3 . Arm *A* is then melt-sealed at *a* in the same way as *b*, the pressure gradient being achieved by removing the plug from stopcock *h* and closing the resultant two openings (when required) with a finger. Arm *B* is then immersed in ice water and NH_3 is allowed to condense in it until it fills 1/4 of the volume. In the presence of Pt, 1 g. of K is converted to KNH_2 within 15 minutes. After completion of the reaction, the H_2 by-product is allowed to escape via stopcock *h*.

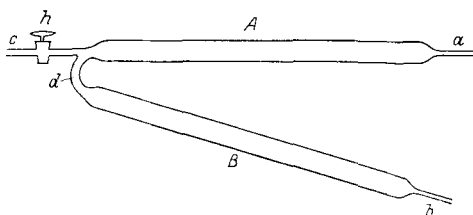

Fig. 279. Preparation of silver amide.

B) AgNH_2

The AgNO_3 in arm *A* is dissolved in a manner similar to that presented above, and both arms are then filled to half their volume with liquid NH_3 . After the solutions have become homogeneous, they are combined by allowing the KNH_2 solution to flow into the AgNO_3 solution. The resultant precipitate of AgNH_2 settles well and is purified by decantation with liquid NH_3 . This is carried out by pouring the supernatant liquid NH_3 into arm *B* and redistilling it into *A* (*B* is then in lukewarm water, *A* in ice water). The precipitate is vigorously agitated, together with the NH_3 which condenses on it, and is then allowed to settle. The

supernatant liquid NH_3 is again poured off into *B*. This operation is repeated several times. Finally a deep layer of liquid NH_3 is condensed onto the precipitate in *A*. This arm is then immersed in a -35°C bath in order to establish atmospheric pressure inside the apparatus, stopcock *h* is opened, and the tube is fused at *d*. The liquid NH_3 is allowed to evaporate slowly through stopcock *h* and the tube is evacuated to remove residual NH_3 .

These reactions may also very conveniently be carried out in the apparatus of Fig. 69, p. 87; this apparatus is an improved version of the one described above.

PROPERTIES:

White, quite voluminous precipitate (when moist). Soluble in ammonium salt solutions, absolute ammonia, and excess KNH_2 ; insoluble in excess AgNO_3 . Blackens on exposure to light. The precipitate shrinks considerably on drying and acquires color. Extraordinarily explosive when dry. Apparently impossible to obtain an absolutely pure state.

REFERENCES:

E. C. Franklin. *Z. anorg. allg. Chem.* **46**, 1 (1905); R. Juza. *Z. anorg. allg. Chem.* **231**, 121 (1937).

Silver Azide

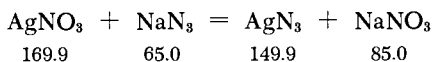

A solution of NaN_3 is treated in the cold with a slight excess of AgNO_3 solution. The AgN_3 precipitate is decanted, filtered, washed with water, alcohol and ether, and dried in vacuum over conc. H_2SO_4 .

Alternate methods: a) Slow addition of a 1% AgNO_3 solution to 1.5% aqueous HN_3 , prepared by distillation of a solution of NaN_3 in H_2SO_4 . The product is washed free of Ag ion [F. V. Friedländer, *J. Amer. Chem. Soc.* **40**, 1945 (1918); T. Curtius, *Ber. dtsh. chem. Ges.* **23**, 3027 (1890)].

b) Precipitation of a cold, saturated solution of AgNO_3 with hydrazine sulfate [A. Angeli, *Atti Acad. dei Linc.* **2**, 569 (1893)].

PROPERTIES:

Colorless crystalline needles. M.p. 252°C . Sparingly soluble in water and nitric acid; readily soluble in aqueous ammonia.

Highly explosive. Sensitive to shock and heat. The white color changes to gray-violet on heating to 170-180°C. Detonation temperature about 300°C. Crystal structure: orthorhombic. Heat of formation: +67.3 kcal./mole.

REFERENCE:

G. Tammann and C. Kröger. Z. anorg. allg. Chem. 169, 16 (1928).

Silver Nitride



Potassium hydroxide pellets are added to a solution of AgCl in conc. ammonia until the effervescence, caused by the evolving NH_3 , stops. The mixture is diluted with distilled water, filtered through filter paper, and washed with water until the filtrate is neutral. The moist product is transferred from the filter paper to a porcelain dish, where it may be stored under water for some time.

The product contains small amounts of AgCl and Ag, but is free of Ag_2O .

Alternate methods: a) A solution of Ag_2O in conc. aqueous ammonia is allowed to stand in air or heated on a water bath. The same may be achieved by precipitation with alcohol. The product is impure, with a variable content of Ag_2O and Ag [F. Raschig, Liebigs Ann. 233, 93 (1886)].

b) Solid $\text{AgF} \cdot 2\text{NH}_3$ is stored for several days over H_2SO_4 in a desiccator. The product is free of Ag_2O and rich in Ag; the yield is small [L. J. Olmer and Dervin, Bull. Soc. Chim. France (4) 35, 152 (1924)].

SYNONYM:

(Berthollet's) fulminating or detonating silver.

PROPERTIES:

Formula weight 337.65. Black flakes, sometimes shining black; crystalline appearance (when prepared according to Raschig, see above). Insoluble in H_2O , soluble in dilute mineral acids, explosive reaction with conc. acids. Both the dry and the moist product may be stored in air at room temperature for a long time. Slowly decomposes at 25°C. Decomposes at room temperature in vacuum. Decomposes explosively in air at about 165°C. Very sensitive

(explodes) when touched with objects of great relative hardness, even when moist. Extremely sensitive when dry, but relatively easy to handle when moist. Explodes readily when prepared by Raschig's method. d_4^{20} 9.0. Crystal structure: cubic. Heat of formation (25°C): +61.0 kcal./mole.

REFERENCE:

H. Hahn and E. Gilbert. *Z. anorg. Chem.* 258, 77 (1949).

Silver Acetylide

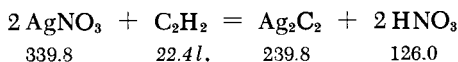

Pure acetylene is introduced into a solution of AgNO_3 which has been treated with a large excess of ammonia. The white precipitate of Ag_2C_2 is filtered, washed with water, then with alcohol and ether, and dried over P_2O_5 in a desiccator.

PROPERTIES:

White powder, light sensitive, very explosive, particularly when dry. Soluble (decomposition) in KCN solution, yielding C_2H_2 . Decomposed by HCl into AgCl and C_2H_2 . Decomposes hydrolytically in water and alkalis.

REFERENCE:

J. Eggert. *Z. Elektrochem.* 24, 150 (1918).

Silver Cyanamide



Careful addition of HNO_3 to commercial CaCN_2 at 0°C and pH 6 yields H_2CN_2 . The solution thus obtained, which contains about 10% H_2CN_2 , is treated with an ammoniacal solution of AgNO_3 (added in small portions). The resultant Ag_2CN_2 is purified by solution in dilute HNO_3 and reprecipitation with dilute NH_3 ; it is washed and rapidly dried at 130°C.

PROPERTIES:

Formula weight 255.79. Yellowish-white powder containing 99.5% Ag_2CN_2 . Soluble in KCN: $\text{Ag}_2\text{CN}_2 + 4 \text{KCN} = 2\text{K}[\text{Ag}(\text{CN})_2] + \text{K}_2\text{CN}_2$. Pyrolysis in vacuum proceeds via the intermediate

silver dicyanamide, AgC_2N_3 , which is stable up to 600°C . The decomposition is complete at 750°C . The residue consists of Ag which is free of cyanide and N_2 . If the temperature rise is too rapid, the pyrolysis becomes explosive.

REFERENCE:

- A. Chrétien and B. Woringer. *Compt. Rend. Hebd. Séances Acad. Sci.* 232, 1114 (1951).

Silver Carbonate

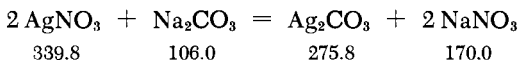

A solution of AgNO_3 is treated with alkali carbonate or bicarbonate. When precipitating with the carbonate, avoid an excess of the reagent, since the Ag_2CO_3 precipitate may then contain oxides. The product is filtered, washed with water, and dried to constant weight over H_2SO_4 and P_2O_5 . It still contains traces of water.

Due to its sensitivity to light, a pure silver carbonate can be obtained only when the preparation is carried out in red light.

Alternate method: Electrolysis of a 0.02M solution of NaHCO_3 using a silver anode and platinum cathode. The crystalline precipitate at the anode is Ag_2CO_3 [P. Demers, *Canad. J. Res. (A)* 17, 77 (1939)].

PROPERTIES:

Light-yellow powder. Very sparingly soluble in water; solubility (25°C): $3.2 \cdot 10^{-3}$ g./100 g. H_2O . Soluble in conc. alkali carbonate solutions, KCN solution, HNO_3 and H_2SO_4 . Splits off CO_2 on heating (CO_2 pressure at $218^\circ\text{C} = 752$ mm.). d_4^{20} 6.077. Heat of formation (25°C): -120.8 kcal./mole.

REFERENCE:

- G. H. G. Jeffrey and A. W. Warrington. *Chem. News* 132, 373 (1939).

Silver Nitrite

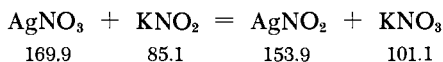

A solution of 5 parts of KNO_2 is added to a solution of 8 parts of AgNO_3 . The resultant pale yellow precipitate is usually

contaminated with some Ag_2O , which is removed by recrystallization from water at 70°C . On cooling, AgNO_2 crystallizes in the form of hair-thin, almost colorless needles. It is best to work under red light to prevent decomposition.

PROPERTIES:

Colorless to yellow needles. Somewhat soluble in water; the solubility increases markedly with temperature: (15°C) 0.28, (60°C) 1.38 g./100 g. H_2O . Soluble in excess nitrites, with formation of complex salts. Blackens in light. Decomposes at 140°C ; dissociates into Ag and NO_2 on dry heating. In aqueous solution, gradually decomposes into Ag, AgNO_3 and NO . d_4^{25} 4.453. Crystal structure: orthorhombic. Heat of formation: -11.6 kcal./mole.

REFERENCE:

J. A. A. Ketelaar. Z. Kristallogr. (A) 95, 383 (1936).

Silver Tartrate

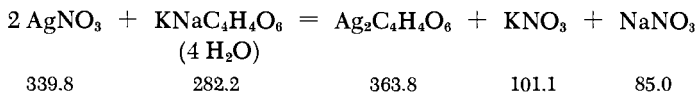

Stoichiometric quantities of AgNO_3 and potassium sodium tartrate (Rochelle salt) are dissolved in water and the solutions combined. On addition of alcohol (in which silver tartrate is insoluble), the product precipitates as a white, cheeselike deposit which is immediately filtered through a suction or Büchner filter. The precipitate is washed with aqueous alcohol until no further Ag^+ ion is detectable. Further purification may be achieved by crystallization from 80°C water, a small quantity of Ag_2O being formed in the process. The aqueous solution is filtered and alcohol is again added. The precipitate is filtered, washed first with aqueous, then with absolute alcohol or acetone, and dried in vacuum over H_2SO_4 .

Due to the light sensitivity of the compound, it is best to work in the dark.

Alternate method: A hot, moderately conc. solution of Rochelle salt is added to an 80°C dilute solution of AgNO_3 ; the reaction (addition) is complete when the continually forming precipitate no longer dissolves. The silver tartrate crystallizes on cooling in the form of fine flakes which acquire a white, metallic sheen on washing.

PROPERTIES:

White powder or crystalline flakes, not entirely stable in daylight. Soluble in dilute nitric acid, sparingly soluble in H₂O (solubility at 25°C: 0.20 g./100 g. H₂O); insoluble in alcohol, acetone and ether. Decomposes in ammonia and NaOH, yielding Ag₂O. Evolves CO₂ on dry heating, leaving pyrotartaric acid and Ag as residue. d_4^{25} 3.432.

REFERENCES:

L. Redtenbacher. Liebigs Ann. 38, 132 (1841); H. Sauer. Unpublished.

o-Phenanthrolinesilver (II) Persulfate

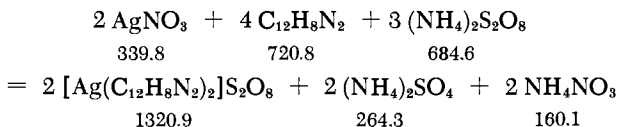

Two equivalents of an aqueous solution of o-phenanthroline are added to a solution of AgNO₃. A colorless, gelatinous precipitate is formed; it rapidly turns red-brown on addition of a conc. solution of (NH₄)₂S₂O₈, and settles on standing as fine crystals. The product is suction-filtered, washed with cold water, and dried, first with alcohol and ether and then in a desiccator. The yield is quantitative.

PROPERTIES:

Formula weight 660.44. Chocolate brown, very stable crystalline powder. Insoluble in water. Readily soluble (without decomposition) in cold conc. nitric acid, yielding a dark brown solution from which the perchlorate may be precipitated by addition of an excess of conc. NaClO₄ solution. Forms AgO in alkali hydroxides.

REFERENCE:

W. Hieber. Ber. dtsch. chem. Ges. 61, 2149 (1928).

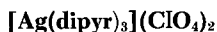
Tris- α, α' -dipyridylsilver (II) Perchlorate

The reaction between silver nitrate and α, α' -dipyridyl yields bis- α, α' -dipyridylsilver nitrate [Ag(dipyr)₂]NO₃, which is converted into bis- α, α' -dipyridylsilver (II) persulfate [Ag(dipyr)₂]S₂O₈

with $K_2S_2O_8$. Treatment of this compound with nitric acid yields tris- α, α' -dipyridylsilver (II) nitrate $[Ag(dipyr)_3](NO_3)_2$; addition of $NaClO_4$ to an aqueous solution of this nitrate yields a precipitate of the corresponding perchlorate.

A) BIS- α, α' -DIPYRIDYLSILVER NITRATE $[Ag(dipyr)_2]NO_3$

A hot solution of 16.9 g. of $AgNO_3$ in aqueous ethanol is added to a hot solution of 31.2 g. of α, α' -dipyridyl in ethanol, yielding a precipitate of $[Ag(dipyr)_2]NO_3$. Additional product is recovered upon concentration of the mother liquor. The compound is re-crystallized from hot dilute ethanol.

PROPERTIES:

Formula weight 482.27. Yellow needles. Decomposes at $155^\circ C$. Decomposes slowly in light. Sparingly soluble in cold and hot water and in common organic solvents (except alcohols).

B) BIS- α, α' -DIPYRIDYLSILVER (II) PERSULFATE $[Ag(dipyr)_2]S_2O_8$

The yellow needles of $[Ag(dipyr)_2]NO_3$ are stirred into an excess of cold, saturated aqueous $K_2S_2O_8$; a deep red-brown precipitate of the complex persulfate is produced. The reaction is complete after two hours of constant stirring. The precipitate is washed with cold water.

PROPERTIES:

Formula weight 612.39. Red-brown precipitate. Decomposes at $137^\circ C$. Very sparingly soluble in water, insoluble in the common organic solvents. In air, converts to the corresponding hydrogen sulfate.

C) TRIS- α, α' -DIPYRIDYLSILVER (II) NITRATE $[Ag(dipyr)_3](NO_3)_2$

Product (B) is triturated in a mortar with cold nitric acid (d 1.4). The excess acid is removed and the residue extracted with warm water. The brown aqueous extract is treated with an excess of aqueous NH_4NO_3 and cooled with ice, thus precipitating small, dark-brown needles of the dinitrate. The precipitate is purified by solution in warm water and reprecipitation with aqueous NH_4NO_3 .

PROPERTIES:

Formula weight 700.47. Dark-brown needles. Decomposes at $176^\circ C$. Soluble in water; the aqueous solution decomposes slowly, evolving O_2 . Powerful oxidant.

D) TRIS- α, α' -DIPYRIDYLSILVER (II) PERCHLORATE $[\text{Ag}(\text{dipyr})_3](\text{ClO}_4)_2$

This compound is precipitated when NaClO_4 is added to an aqueous solution of $[\text{Ag}(\text{dipyr})_3](\text{NO}_3)_2$. The precipitate is washed with warm water.

PROPERTIES:

Formula weight 775.36. Orange-brown crystals. Detonates on heating. Very sparingly soluble in water.

ANALYSIS:

Determination of the Ag (II) in compounds B-D: the complex salts are treated with cold aqueous KI, yielding iodine: $\text{AgX}_2 + 2 \text{KI} \rightarrow 2 \text{KX} + \text{AgI} + \frac{1}{2} \text{I}_2$. The iodine is titrated with $\text{Na}_2\text{S}_2\text{O}_3$ solution.

REFERENCES:

G. T. Morgan and F. H. Burstall. *J. Chem. Soc. (London)* 1930, 2594; H. Kainer. Thesis, Heidelberg, 1952.

Very Pure Gold

Gold (20 g.) is dissolved in aqua regia in an 800-ml. beaker, and the solution is concentrated to a thick sirup. The nitric acid is expelled by evaporating the solution five times on a steam bath, each time with 20 ml. of hydrochloric acid (4:1). The residue is taken up in 650 ml. of hot water and digested until all soluble material is dissolved. It is then allowed to settle for eight days in a dust-free atmosphere. The precipitate consists of AgCl containing small amounts of Au, Pd, SiO_2 , etc. The gold solution is filtered through a double layer of thick filter paper, without disturbing the precipitate. This and all later precipitates are not worked up further to obtain gold.

Experience indicates that the gold refined by use of SO_2 still contains some Pd, while that precipitated with oxalic acid contains Cu, Pb and other metals. Therefore both of these procedures must be used to obtain gold of the desired purity. Sulfur dioxide is passed through the warm gold solution (80°C) obtained above; the gold precipitates quantitatively on careful neutralization with ammonia (1:1). The product is allowed to settle overnight and the deposit of spongy gold is washed by decantation with hot water; it is then heated for four hours on a steam bath with conc. hydrochloric acid and washed free of acid with hot water. Then it is redissolved

in a beaker. The entire procedure is repeated eight times in order to remove Ag, Cu, Ni, Zn and Pb. The product is then digested for 12 hours with ammonia (1:1), washed free of ammonia with water, heated for four hours on a steam bath with hot conc. nitric acid, and decanted. Ammonia (1:1) is again added and later removed by washing with water. The gold sponge is dissolved in dilute aqua regia; after addition of HCl, the solution is concentrated by evaporation, diluted with H₂O, decanted and filtered. The gold is precipitated by careful addition (there is a danger of foaming over) of small portions of powdered, crystalline oxalic acid. If the solution retains a yellow color, it is carefully neutralized with ammonia and more oxalic acid is added; the addition of the acid is continued until the solution remains colorless. The resultant gold sponge is dissolved and reprecipitated with oxalic acid. It is then Pd-free. Finally the gold is redissolved, precipitated with SO₂, digested with conc. hydrochloric acid, and washed with water. The last traces of HCl are removed with ammonia. The product is transferred to a glazed porcelain dish and dried at 110°C. Yield 75-80%. The gold prepared in this manner is spectroscopically pure (free of metallic Cu, Ag, Ni, Zn and Pt).

Alternate methods: a) Preparation of pure gold by the method of G. Krüss. The product is probably not as pure as that prepared by the method described above [G. Krüss, Liebigs Ann. 238, 43 (1887)].

b) Extraction of AuCl₃ with ether. Total impurities in the product, about 0.001% [F. Mylius, Z. anorg. allg. Chem. 70, 203 (1911)].

PROPERTIES:

Atomic weight 197.0. M.p. 1063°C, b.p. 2960°C; $d_4^{17.5}$ 19.29. Crystal structure: type Al.

REFERENCE:

T. A. Wright. Metals and Alloys 3, 146 (1932).

Colloidal Gold

A mixture of 120 ml. of very pure, twice-distilled water (silver condenser) and 2.5 ml. of a solution of 6 g. of H₂AuCl₄ · 4 H₂O in one liter of water is prepared and brought to a boil as rapidly as possible. Shortly before the boiling point is reached, 3 ml. of 0.18N solution of very pure potassium carbonate is added. As soon as the solution begins to boil, it is rapidly swirled around

(or stirred with a Pyrex glass rod), while 3-5 ml. of a dilute solution of formaldehyde (1.3 ml. of 40% formaldehyde in 100 ml. of water) is added. Stirring is continued until a reaction is evident (this usually occurs within a few seconds—one minute at most), whereupon the solution becomes bright red. It is again brought to a boil and held at the b.p. for a short time until the odor of formaldehyde disappears.

Alternate methods: a) Reduction with ethereal solution of phosphorus (R. Zsigmondy and P. A. Thiessen, *Das kolloide Gold* [Colloidal Gold], Leipzig, 1925, p. 487).

b) Reduction with hydrazine hydrate or phenylhydrazonium chloride [A. Gutbier and F. Resenscheck, *Z. anorg. allg. Chem.* **39**, 112 (1904)].

c) Reduction with sodium anhydro methylene citrate (citramin) [L. Vanino, *Kolloid-Z.* **20**, 122 (1917)].

d) Reduction with alkaline formaldehyde solution [P. P. von Weimarn, *Kolloid-Z.* **33**, 75 (1923)].

e) Sol of gold by pulverization in an electric arc [Th. Svedberg, *Ber. dtsh. chem. Ges.* **39**, 1705 (1906); G. Bredig, *Angew. Chem.* **950** (1898); E. F. Burton, *Phil. Mag.* **11**, 425 (1906)].

PROPERTIES:

Bright red sol, particle size about $1-6 \cdot 10^{-7}$ cm. Highly sensitive to electrolytes. Concentrated solutions (up to 0.12% gold) may be obtained by dialysis.

REFERENCE:

R. Zsigmondy and P. A. Thiessen. *Das kolloide Gold* [Colloidal Gold], Leipzig, 1925, p. 33.

Gold from Residues

I. FROM PLATING BATHS

A clay cell filled with NaCl solution and provided with a zinc electrode is placed in the gold solution. An electrode made of a piece of brass sheet is immersed in the gold solution and the two electrodes are connected into a circuit. The gold is deposited quantitatively on the brass electrode over a period of a few weeks, during which the brass electrode is replaced once or twice and the Zn electrode is pickled several times.

II. FROM WASTE CONTAINING GOLD AND SILVER

The particles are calcined and the resultant powder is boiled with conc. nitric acid to remove Ag and other metals. The diluted

solution is filtered and the residue is heated with aqua regia on a steam bath for 24 hours. The gold is precipitated from the filtrate with FeSO_4 and worked up.

III. FROM INDUSTRIAL ALLOYS

The gold alloy is ground as finely as possible and heated with conc. hydrochloric acid on a sand bath, conc. nitric acid being added in drops from time to time. When solution is complete, the mixture is evaporated in a porcelain dish placed on a steam bath (dust-free atmosphere) until the liquid solidifies on cooling. The residue is taken up in a large quantity of water and allowed to stand for some time; the precipitated AgCl is then filtered off. The solution is heated and the gold is precipitated with excess aqueous FeCl_2 . The supernatant is decanted and the residue boiled with dilute hydrochloric acid until the HCl ceases to yellow. The solution is then filtered, dried and fused with borax in a porcelain crucible. If higher purity is desired, the procedure is repeated. If present, Pt, Pd and Tl may be removed from the filtrate with Fe or Zn.

Alternate methods: a) Reduction with alkaline H_2O_2 [L. Vanino and L. Seemann, Ber. dtsch. chem. Ges. 32, 1968 (1899)].

b) The gold solution is added at 100°C to a solution of $\text{Hg}_2(\text{NO}_3)_2$, yielding very finely divided gold (L. Vanino, Handbuch der präp. Chemie [Handbook of Prep. Chemistry], Stuttgart, 1921, Vol. I, p. 520).

c) Electrolysis of Ag- and Pt-containing alloys [W. Möbius, Berg- und hüttenm. Ztg. 44, 447 (1885); 47, 324 (1888); Chemiker-Ztg. 15, Rep. 18 (1891); E. Wohlwill, Z. Elektrochem. 4, 379 (1897)].

REFERENCES:

- I. Plage. Industr.-Bl. 190 (1878).
- II. W. Adolphi. Chemiker-Ztg. 52, 109 (1928).
- III. A. Bender. Anleitung z. Darstellung anorg. Präparate [Introduction to the Preparation of Inorganic Compounds], Stuttgart, 1893.

Gold (I) Chloride



Prepared by thermal decomposition of an auric chloride obtained from hydrogen tetrachloroaurate (III).

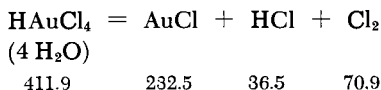

Gold (5-10 g.) is dissolved in aqua regia and the solvents are removed by vacuum distillation (aspirator) at water bath temperature.

The solution is protected by a blanket of CO_2 introduced through a capillary. The nitric acid is expelled by double evaporation with conc. hydrochloric acid, and the resultant dark red-brown melt is poured into a dish where it congeals to a crystalline mass. This is heated to 100°C in high vacuum, until no vapor pressure is evident. Since the HAuCl_4 liquefies again during this operation, care should be exercised to avoid spattering. After all water is expelled, the residue is heated to 156°C (boiling bromobenzene bath). At higher temperatures (170 – 205°C) the decomposition is complete within a few hours.

Alternate methods: a) Thermal decomposition of AuCl_3 in air at 185°C [J. Thomsen, J. prakt. Chem. 13, 337 (1876)].

b) Decomposition of AuCl_3 in a stream of dry HCl at 175°C [M. E. Diemer, J. Amer. Chem. Soc. 35, 552 (1913)].

c) Decomposition of AuCl_3 in a stream of dry air [F. H. Campbell, Chem. News 96, 17 (1907)].

The products prepared by methods a-c are not completely pure.

SYNONYMS:

Aurous chloride, gold monochloride.

PROPERTIES:

Light yellow crystals, not deliquescent. M.p. (dec.) 289°C ; d_4^{25} 7.4. Soluble in alkali chloride solutions. Decomposes on solution in water. Heat of formation (25°C): -8.4 kcal./mole.

REFERENCE:

W. Biltz and W. Wein. Z. anorg. allg. Chem. 148, 192 (1925).

Gold (III) Chloride

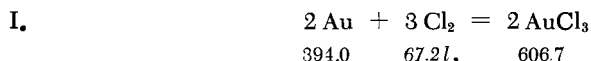

Finely divided gold is treated at 225 – 250°C (but not higher) with gaseous Cl_2 at a pressure of 900 – 950 mm. (The gold powder is obtained by precipitating a solution of a gold salt with sulfurous acid, washing and drying at 180°C .) The powder is in a porcelain boat which is placed in a glass tube. At the point immediately adjoining the boat, the tube widens into a sphere with outlets at

top and bottom. Excess Cl_2 escapes through the upper outlet; this outlet also carries a rod, which can be used to push the AuCl_3 (which condenses in the sphere) into a storage flask via the lower outlet. The yield is 0.1-0.2 g. per hour of large (up to 10 mm. long) crystals.

II. About 0.2-0.6 g. of freshly precipitated gold is placed in a 50-ml. flask connected to the atmosphere via a reflux condenser and a drying tower. Molten iodine monochloride is added in drops through a side tube. The reaction starts when the flask is heated. When the reaction subsides, an excess of ICl is added and the mixture is heated for a short time until boiling just begins. The solution is cooled and extracted several times with CCl_4 (distilled over P_2O_5). The suspension is then filtered (suction) in a stream of N_2 through a sintered glass funnel; the residue is washed with CCl_4 and freed of CCl_4 in vacuum. The yield is quantitative.

Alternate method: $\text{HAuCl}_4 \cdot 4 \text{H}_2\text{O}$ is carefully heated in a stream of Cl_2 ; final heating for half an hour at 200°C [M. E. Diemer, J. Amer. Chem. Soc. 35, 553 (1913)].

SYNONYMS:

Auric chloride, gold trichloride.

REFERENCES:

Formula weight 303.37. Ruby-red crystals (when sublimed) or red-brown to dark ruby-red crystalline mass. M.p. 229°C , b.p. (dec.) 254°C ; d_4^{20} 3.9. Melts at 288°C under a Cl_2 pressure of 2 atm. Sublimes at 180°C . Hygroscopic; soluble in H_2O with formation of $\text{H}_2[\text{AuCl}_3\text{O}]$. The neutral aqueous solution decomposes gradually with separation of metallic gold; acidic solutions are more stable. Soluble in alcohol and ether. Heat of formation (25°C): -28.3 kcal./mole.

REFERENCES:

- I. M. Petit. Bull. Soc. Chim. France, Mém. 37/38, 1141 (1925);
W. Fischer and W. Biltz. Z. anorg. allg. Chem. 176, 81 (1928).
- II. V. Gutmann. Z. anorg. allg. Chem. 264, 169 (1951).

Hydrogen Tetrachloroaurate (III)

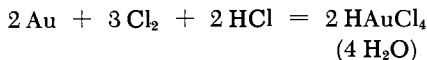
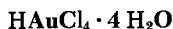

394.0	212.7	72.9	823.8
-------	-------	------	-------

Precipitated gold is dissolved in aqua regia and the solvent is evaporated at steam bath temperature (aspirated vapor). The nitric

acid is expelled by repeating the procedure twice with conc. hydrochloric acid, which is itself removed by evaporation. The resultant melt is poured into a dish, where it congeals to a crystalline mass. The residual mother liquor is decanted, and the crystals are crushed to allow rapid drying in a drying closet. The mass is pulverized several times during the drying operation until it is completely dry.

PROPERTIES:

Formula weight 411.90. Elongated, light-yellow needles, deliquescent in moist air. Soluble in water, alcohol and ether. The anhydrous compound crystallizes from alcohol. One molecule of H_2O is given off on prolonged standing in dry air. Crystal structure: monoclinic. Heat of formation: -4.5 kcal./mole.

SYNONYMS:

Gold trichloride acid; chloroauric acid; aurochlorohydric acid; hydrochloroauric acid.

REFERENCES:

W. Biltz and W. Wein. *Z. anorg. allg. Chem.* **148**, 192 (1925);
J. Thomsen. *Ber. dtsch. chem. Ges.* **16**, 1585 (1883).

Potassium Tetrachloroaurate (III)

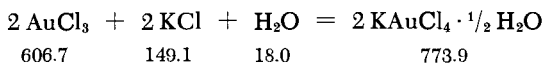
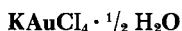

An aqueous solution of $AuCl_3$ or $HAuCl_4$, strongly acidified with HCl , is treated with an equimolar quantity of conc. aqueous KCl , and the mixture is evaporated over H_2SO_4 or at a moderately high temperature.

PROPERTIES:

Formula weight 386.94. Light-yellow needles, stable in air. Soluble in water and alcohol, insoluble in ether. Loses water of crystallization at $100^\circ C$. Crystal structure: monoclinic.

SYNONYM:

Auric potassium chloride.

REFERENCE:

H. Topsöe. Ber. Wien. Akad. II, 69, 261 (1874).

Gold (III) Oxide

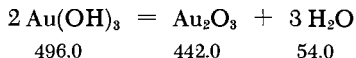

Gold hydroxide is made according to the procedure outlined in the next preparation and heated to constant weight at 140-150°C.

It is best to start from Au metal if the product must be entirely free of nitrogen oxides. The gold is dissolved in aqua regia and the nitric acid is removed completely by evaporation with hydrochloric acid, repeated five times. The hydroxide is precipitated with a small excess of Na_2CO_3 (very slight blue color on litmus paper), washed several times with water, centrifuged and purified by electrodialysis for 14 days. The product is dried and converted to Au_2O_3 at 140-150°C.

Crystalline Au_2O_3 cannot be obtained by dehydration of $\text{Au}(\text{OH})_3$.

Alternate methods: a) By atomization of gold by means of a high-frequency spark in ozonized O_2 . The oxidation product contains about 40% Au_2O_3 , the rest being elemental Au (see Thiessen and Schütza, as well as Schütza and Schütza, in references below).

b) Precipitation of $\text{Au}(\text{OH})_3$ from AuCl_3 solution with potassium hydroxide by Fremy's method [W. E. Roseveare and T. F. Buehrer, J. Amer. Chem. Soc. 49, 1221 (1927)].

DETERMINATION OF ACTIVE OXYGEN

The solution is boiled in 0.1N oxalic acid and back-titrated with KMnO_4 solution.

SYNONYMS:

Gold trioxide; gold sesquioxide; auric oxide.

PROPERTIES:

Black to brownish black. Soluble in conc. acids, markedly soluble in glacial acetic acid. Decomposes above 160°C into Au and O_2 . Heat of formation (25°C): +19.3 kcal./mole.

REFERENCES:

- P. A. Thiessen and H. Schütza. *Z. anorg. allg. Chem.* 243, 32 (1939); H. Schütza and I. Schütza. *Z. anorg. allg. Chem.* 245, 59 (1940); G. Lunde. *Z. anorg. allg. Chem.* 163, 345 (1927).

Gold (III) Hydroxide

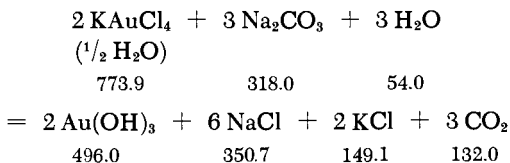
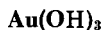

A solution of KAuCl_4 is heated for several hours on a water bath with an excess of Na_2CO_3 . The resultant precipitate is filtered, thoroughly washed, digested with warm, dilute sulfuric acid, and carefully washed in a glass filter crucible until the filtrate is free of H_2SO_4 . The product is dried at room temperature over H_2SO_4 .

Alternate methods: a) Precipitation of AuCl_3 solution with MgCO_3 [G. Krüss, *Liebigs Ann.* 237, 290 (1887)].

b) Hydrolysis of gold sulfate or nitrate [P. Schottländer, *Liebigs Ann.* 217, 312 (1883)].

c) Fusion of gold with Na_2O_2 and decomposition of the resultant sodium aurate with dilute sulfuric acid [F. Meyer, *Compt. Rend. Hebd. Séances Acad. Sci.* 145, 805 (1907)].

d) Anodic oxidation of gold in 1N sulfuric acid [F. Jirsa and O. Buryánek, *Z. Elektrochem.* 29, 126 (1923); W. G. Mixter, *J. Amer. Chem. Soc.* 33, 688 (1911)].

SYNONYM:

Auric hydroxide.

PROPERTIES:

Formula weight 248.02. Brown powder. Insoluble in H_2O , soluble in conc. acids and hot KOH . When dried over P_2O_5 in vacuum, the compound is converted to AuO(OH) (slowly at room temperature, rapidly at 100°C), whereby the color changes, the final one ranging from yellowish red to ochre-brown. Converts to Au_2O_3 at $140\text{--}150^\circ\text{C}$.

REFERENCE:

R. Lydén. Z. anorg. allg. Chem. 240, 157 (1939).

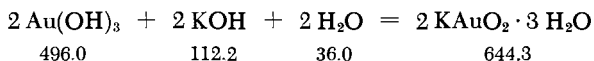
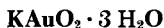
Potassium Aurate

Auric hydroxide is reacted with warm conc. KOH in the absence of atmospheric CO₂. After filtration the solution is allowed to evaporate in the dark. The precipitated crystals are dried in vacuum over H₂SO₄.

PROPERTIES:

Formula weight 322.15. Light-yellow needles, soluble in water, giving a highly alkaline reaction. Decomposes on gentle heating, giving off water and oxygen. The residue consists of Au, KOH and KO₂.

REFERENCES:

F. Meyer. Compt. Rend. Séances Acad. Sci. 145, 805 (1907);
E. Frémy. Ann. Chim. Phys. 31, 483 (1853).

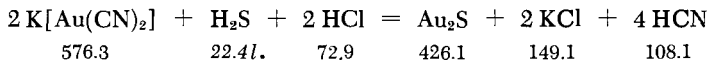
Gold (I) Sulfide

A conc. solution of K[Au(CN)₂], obtained by treatment of a solution of AuCl₃ with excess KCN, is saturated with H₂S. Hydrochloric acid is added to the clear solution and the mixture is heated, resulting in the appearance of a brown color. A heavy, rapidly settling precipitate is formed on boiling. This is filtered, washed with water, and then successively with alcohol, ether, CS₂ and finally again with ether. The product is dried to constant weight over P₂O₅.

The product usually contains sulfur and some moisture, which are difficult to remove. It may be freed of S by dissolving in KCN, filtering and reprecipitating with boiling hydrochloric acid.

PROPERTIES:

Brown-black powder when dry, steel-gray when moist. The freshly precipitated compound is readily soluble in water, forming a colloid, particularly in the presence of H_2S . Easily reoagulated by hydrochloric acid and salts. Insoluble after drying over P_2O_5 . Resistant to conc. hydrochloric acid and H_2SO_4 , as well as to KOH . Oxidized by aqua regia and strong oxidants. Soluble in solutions of KCN and alkali polysulfides. Decomposes at 240°C into Au and S .

REFERENCE:

L. Hoffmann and G. Krüss. Ber. dtsch. chem. Ges. 20, 2361 (1887).

Gold (II) Sulfide

AuS

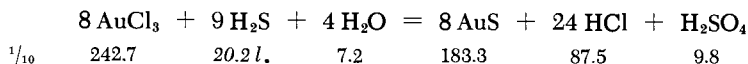

A neutral 1-3% solution of AuCl_3 is precipitated in the cold (the temperature must not exceed 40°C) with H_2S or an alkali sulfide. The precipitate is filtered, thoroughly washed with water, and treated with alcohol, anhydrous ether, CS_2 and again with ether. The product is dried at 130°C over P_2O_5 .

Alternate method: A solution of AuCl_3 is added in drops to an aqueous solution of sodium dithiosulfatoaurate (I) (for preparation, see under Au_2C_2) (Antony and Lucchesi, see references below).

PROPERTIES:

Formula weight 229.07. Deep black. Insoluble in water and acids; soluble in aqua regia and solutions of potassium cyanide and alkali polysulfides. Resistant to KOH in the cold, decomposes after prolonged boiling, liberating gold. Thermal decomposition begins at 140°C .

REFERENCES:

U. Antony and A. Lucchesi. Gazz. Chim. Ital. 19, 552 (1889); 20, 61 (1890); L. Hoffmann and G. Krüss. Ber. dtsch. chem. Ges. 20, 2704 (1887).

Gold (III) Sulfide

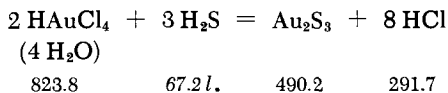

A fast stream of H₂S is introduced into 1N hydrochloric acid at -2 to -4°C; simultaneously, a cooled solution of HAuCl₄ · 4 H₂O is allowed to flow in. The black precipitate is digested with water, washed free of acid, treated with alcohol and ether, extracted with CS₂ in a Soxhlet extractor, washed with ether, and dried in vacuum over P₂O₅.

Alternate methods: a) A solution of AuCl₃ in absolute ether is saturated with H₂S. The product is washed with CS₂ and alcohol [K. A. Hofmann and F. Höchtlen, Ber. dtsh. chem. Ges. 37, 245 (1904)].

b) Completely dry LiAuCl₄ · 2 H₂O is treated with H₂S at -10°C. The product is extracted with alcohol, CS₂, and again with alcohol and ether, and dried at 70°C in pure N₂ [U. Antony and A. Lucchesi, Gazz. Chim. Ital. 19, 552 (1889)].

PROPERTIES:

Deep black. Insoluble in water. Resistant to hydrochloric and sulfuric acids and dilute nitric acid. Vigorous reaction with conc. nitric acid. Soluble in conc. Na₂S solution, alkali polysulfides and KCN. d_4^{20} 8.754.

REFERENCE:

A. Gutbier and E. Dürnwächter. Z. anorg. allg. Chem. 121, 266 (1922).

Gold (I) Acetylide



Prepared by precipitating a solution of sodium dithiosulfatoaurate (I), Na₃[Au(S₂O₃)₂] · 2 H₂O, with acetylene.

A) SODIUM DITHIOSULFATOAUROATE (I)

A solution of 3 parts of Na₂S₂O₃ · 5 H₂O in 50 parts of water is reacted (stirring) with a solution of 1 part of AuCl₃ in 50 parts

of water. The gold solution is added in portions, each portion being added only after the red color resulting from the previous addition has disappeared. The compound is precipitated from this solution with 96% alcohol and purified by repeated solution in water and reprecipitation with alcohol.

B) GOLD (I) ACETYLIDE

A solution of $\text{Na}_3[\text{Au}(\text{S}_2\text{O}_3)_2]$ is reacted with an excess of strong aqueous ammonia and then slowly saturated with C_2H_2 . The solution becomes yellow, and a yellow precipitate deposits after some time. It is washed by decantation with water and alcohol, filtered and dried over H_2SO_4 .

PROPERTIES:

Formula weight 418.02. Yellow powder. Insoluble in water; decomposes in boiling water without evolution of C_2H_2 ; decomposes slightly in hydrochloric acid with evolution of C_2H_2 . Extremely explosive when dry. Detonates at 83°C if rapidly heated.

REFERENCE:

A. Mathews and L. L. Watters. J. Amer. Chem. Soc. 22, 108 (1900).

Gold (I) Cyanide

AuCN

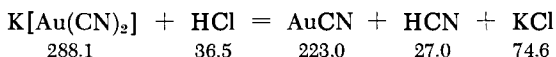

An aqueous solution of $\text{K}[\text{Au}(\text{CN})_2]$ is mixed in the cold with hydrochloric acid and warmed to 50°C . Most of the AuCN precipitates. The mixture is evaporated to dryness on a steam bath, resulting in removal of HCN. The residue is taken up in water, filtered, thoroughly washed (in the absence of sunlight) to remove KCl, and dried over H_2SO_4 or P_2O_5 .

Alternate methods: a) Precipitation of a solution of AuCl_3 with KCN [P. O. Figuiet, J. Pharm. Chim. 22, 329 (1836)].

b) Decomposition of $\text{Na}[\text{Au}(\text{CN})_2]$ with HCl [A. Wogrinz, Metalloberfläche 8, 11, 162 (1954)].

PROPERTIES:

Lemon-yellow crystalline powder. Stable in air. Sparingly soluble in water and dilute acids. Soluble in solutions of alkali

cyanides, KOH, ammonia, $\text{Na}_2\text{S}_2\text{O}_3$ and $(\text{NH}_4)_2\text{S}$. Decomposes with separation of Au on dry heating. Unstable in light when moist. d_4^{20} 7.12. Crystal structure: hexagonal.

REFERENCE:

K. Himly. Liebigs Ann. 42, 157 (1842).

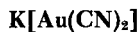
Potassium Dicyanoaurate (I)

Formed when "fulminating gold" is dissolved.

Pure gold (10 g.) is dissolved in 50 ml. of aqua regia (34 ml. of conc. hydrochloric acid and 16 ml. of nitric acid, d 1.33) on a steam bath. When solution is complete (after about two hours), "fulminating gold" is precipitated by addition of an excess of ammonia. It is washed until Cl-free, dissolved while still moist in a slight excess of KCN solution, concentrated on a steam bath, and allowed to crystallize overnight. Additional salt may be recovered from the mother liquor. The product is recrystallized from an equal amount of boiling water, and dried over P_2O_5 or conc. H_2SO_4 . Yield 90%.

Alternate methods: a) Electrolytic solution of Au in warm aqueous KCN [J. Glassford and J. Napier, Phil. Mag. 25, 61 (1844)].

b) To prepare solutions of $\text{K}[\text{Au}(\text{CN})_2]$ or $\text{Na}[\text{Au}(\text{CN})_2]$ for use in gold-plating baths and still avoid using gold sponge or evolution of HCN, HAuCl_4 , in an amount corresponding to 3 parts by weight of Au, is dissolved in 50 parts by weight of water. The flask contents are swirled around while Na_2CO_3 or K_2CO_3 is added until a test with Congo paper no longer yields a blue color. The gold solution is then poured into a porcelain dish and allowed to react (stirring) with 5.2 parts by weight of NaCN or 6.8 parts of KCN; the solution becomes warm and colorless. Six parts of annealed 0.02-mm.-thick gold foil, cut into small chips, are added, and the mixture is heated for several hours on a water bath with stirring and replenishing of the evaporating water. Residual unreacted gold is removed and the solution is evaporated to dryness [A. Wogrinz, Prakt. Chem. (Vienna) 3, 216 (1952)].

SYNONYM:

Gold potassium cyanide.

PROPERTIES:

Formula weight 288.14. Colorless crystals. Readily soluble in H_2O , sparingly soluble in alcohol, insoluble in ether and acetone.

Precipitated from saturated aqueous solution by sulfuric acid, hydrochloric acid, nitric acid and alcohol. Decomposes on boiling with acids. Stable in air and light. d_4^{20} 3.45.

REFERENCE:

F. Chemnetius. Chemiker-Ztg. 51, 823 (1927).

Zinc, Cadmium, Mercury

F. WAGENKNECHT AND R. JUZA*

Zinc

Zn

VERY PURE ZINC

Certain grades of commercial zinc are quite pure. The highest purity may be achieved by distillation (Procedure I) or, starting from ZnSO_4 , by purification of the salt and electrolytic isolation of the metal (Procedures I and II). Extreme purity of zinc salts is particularly important in the preparation of scintillators.

1. PURIFICATION OF ZINC SULFATE IN SOLUTION

Alumina, standardized by the method of Brockmann, is introduced in portions into a glass tube (30 cm. long, 4 cm. diameter) provided with a fritted glass disk at one end. After each addition the adsorbent is compacted with a glass pestle or by applying a vacuum. The material is allowed to fill $2/3$ to $4/5$ of the tube length. The material is prevented from fluidizing by placing a piece of filter paper on top. The flask containing the solution is above the column; the liquid flows into the column through an inlet tube bent at an acute angle. The bottom end of the column is placed in a suction flask. Continuous operation of the system is achieved by applying a slight vacuum. The adsorbent removes As, Sb, Bi, Cr, Fe, Hg, U, Pb, Cu and Ag.

To remove Ni or Co, the ZnSO_4 solution is made alkaline with ammonia and filtered through alumina that has been pretreated with an alcoholic solution of, respectively, diacetyldioxime or α -nitroso- β -naphthol.

Manganese may be removed by adding to the ZnSO_4 solution 0.5 g. of $(\text{NH}_4)_2\text{PbCl}_6$ hydrolyzed in one liter of redistilled (!) H_2O , heating the mixture for a short time to the boiling point,

*The second edition was revised by Dr. H. U. Schuster.

and filtering off the deposit of PbO_2 flakes after 24 hours. Traces of the Pb are removed by passing the solution through an Al_2O_3 column and concentrating the product. Solutions purified with Al_2O_3 as above satisfy the most stringent requirements.

II. ELECTROLYTIC SEPARATION

The electrolyte should contain 40–60 g./liter of Zn (calculated as the sulfate). A piece of silk taffeta serves as the membrane. Pure ZnO is suspended by stirring in the anode chamber. The cathode is Al or Pt, the anode is Pt. The current density is 0.01–0.03 amp./cm.² The Zn deposit may be peeled off cleanly from the aluminum sheet by cutting off its edges. Inclusions are removed by fusing with a small quantity of NH_4Cl in a porcelain crucible. The ingot is pickled clean with HCl and thoroughly washed with distilled water.

III. DISTILLATION OF METALLIC ZINC

The last step in the purification of the Zn metal is a double vacuum distillation. The operation is carried out in a Vycor tube shaped as in Fig. 280. After the distillation (650°C), a

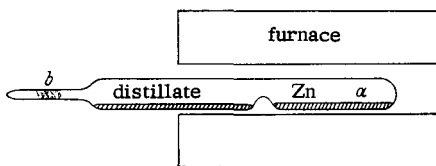

Fig. 280. Distillation of zinc.

slight gray deposit, which is separate from the main body of the distillate, may be observed at *b*. It contains Cd. Traces of a black, very fluffy impurity are left at *a*. No impurity deposit is formed at *b* during the subsequent second distillation. To prevent contamination of the final product

with some heavy, low-volatility components still present, the second distillation is stopped before the material at *a* is depleted. The resultant Zn product is spectroscopically pure. If a quartz tube is used and larger amounts of Zn (e.g., 30 g.) are distilled, the distillate adheres very strongly to the tube wall.

PROPERTIES:

Atomic weight 65.38. Bluish white. Solubility in Hg (18°C) 2.2 g. Zn/100 g. Hg. M.p. 419.4°C , b.p. 905.7°C ; *d* 7.133. Hardness 2.5. Crystal structure: type A3 (Mg type). Electrochemical equivalent $1.220 \text{ g. (amp.} \cdot \text{hr.)}^{-1}$.

REFERENCES:

- I. E. Tiede and W. Schikore. Ber. dtsch. chem. Ges. 75, 586 (1942); W. Schikore and E. G. Müller. Z. anorg. Chem. 255,

- 327 (1948); W. Schikore and T. Pankow. *Ibid.* 258, 15 (1949).
 II. F. Mylius and O. Fromm. *Z. anorg. allg. Chem.* 9, 144 (1895).
 III. R. Petermann. Thesis, Bern, 1946; O. Hönigschmid and M. von Mack. *Z. anorg. allg. Chem.* 246, 363 (1941).

Zinc Hydride

ZnH₂

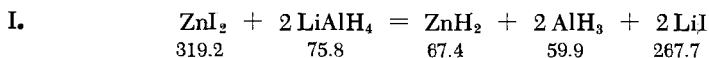

Ether solutions of ZnI₂ and LiAlH₄ (mole ratio 1:2) are mixed at -40°C or below; a white precipitate forms. The product must be separated immediately by centrifugation to prevent contamination by polymeric (AlH₃)_x, which begins to form after some time. The LiI remains in the supernatant solution.

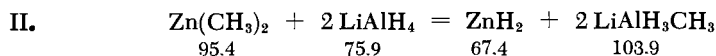

Dimethylzinc (0.57 g., ~6 mmoles) is distilled in a completely dry atmosphere into an ice-cold solution of 0.59 g. (~15.6 mmoles) of LiAlH₄ in 10 g. of absolute ether (predried over LiAlH₄). The white precipitate obtained on heating the mixture to room temperature is filtered, washed several times with absolute ether, and freed of adhering ether by heating to 50°C in vacuum.

The dimethylzinc needed for this preparation is obtained by heating Hg(CH₃)₂ (p. 1119) with a large excess of zinc shot in a closed tube. At 120°C the yield is quantitative after 64 hours. The dimethylzinc may be distilled at atmospheric pressure in a stream of N₂. B.p. 46°C.

PROPERTIES:

Solid, white, nonvolatile when pure. Readily oxidized; reacts with H₂O or humid air, evolving H₂. This reaction is very vigorous in the case of old preparations, which often ignite spontaneously. Stable for some time at room temperature in dry air; in high vacuum at 90°C, gradually decomposes to the elements.

REFERENCES:

- I. W. Wiberg, W. Henle and R. Bauer. *Z. Naturforschg.* 6b, 393 (1951).
 II. G. D. Barbaras, A. E. Finholt, H. J. Schlesinger et al. *J. Amer. Chem. Soc.* 73, 4585 (1951).

Zinc Chloride

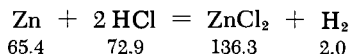

I. Very pure, anhydrous ZnCl_2 is prepared by treating Zn with dry HCl at 700°C in a quartz boat placed in a tube of high-melting glass. At this temperature, the formation and sublimation of ZnCl_2 proceed at sufficiently high rates. The sublimed chloride is collected in a section of the tube which is kept cool for this purpose. Temperatures above 700°C should be avoided, since entrainment of zinc vapor with the chloride may result, a phenomenon recognizable by the appearance of a color in the otherwise colorless sublimate. For additional purification, the chloride may be resublimed in a stream of HCl.

II. The same reaction can be carried out in anhydrous ether. Ether and excess HCl are removed on a steam bath (vacuum).

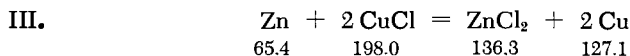

A 6.7% solution of CuCl in pure, dry acetonitrile (distilled several times over P_2O_5) is electrolyzed at room temperature with a Pt cathode and a Zn anode (voltage across the terminals is 12 v.). The electrolysis proceeds under a blanket of absolutely dry N_2 . The reaction is complete when a gray coating of Zn is observed on the Cu deposited at the cathode. The solvent is evaporated in vacuo, and the acetonitrile solvate of ZnCl_2 is converted into the unsolvated salt by careful heating. Yield 96-98%.

If the appropriate copper salts are used, the process may also be employed for the preparation of ZnBr_2 and ZnI_2 , and by substituting a cadmium anode for the zinc electrode, CdBr_2 and CdI_2 may be prepared.

Zinc chloride exists in three different crystal modifications. Details on the preparation and the structure of the pure individual modifications are given by H. R. Oswald and H. Jaggi [Helv. Chim. Acta 43, 72 (1960)].

PROPERTIES:

Colorless, highly hygroscopic, small crystals. M.p. 313°C , b.p. 732°C ; d (pyncn.) 2.93. Solubility per 100 ml. of H_2O : (0°C) 208 g., (20°C) 367 g. (d 2.08), (100°C) 614 g. Crystallizes in the

anhydrous form only above 28°C. Soluble in methanol, ethanol, ether, acetone and other organic solvents.

REFERENCES:

- I. O. Hönigschmid and M. von Mack. *Z. anorg. allg. Chem.* **246**, 366 (1941); for apparatus, see O. Hönigschmid and F. Wittner. *Ibid.* **226**, 295 (1936).
- II. R. T. Hamilton and J. A. V. Butler. *J. Chem. Soc. (London)* **1932**, 2283.
- III. H. Schmidt. *Z. anorg. allg. Chem.* **271**, 305 (1953).

Zinc Hydroxychloride

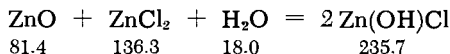

Zinc hydroxychloride is one of the basic zinc halides which can be prepared as well-defined crystalline compounds by several methods, for example, by dissolving ZnO in zinc halide solutions of definite concentration.

The compound is prepared by adding 6-7 g. of ZnO to 100 ml. of a 70% solution of ZnCl₂ and heating to about 150°C until solution is complete. (If seeding crystals are present, the solution becomes turbid and crystallization begins at 133°C.) A coarsely crystalline product is obtained by cooling the solution to 50°C (where the first crystals separate), then heating to 135°C and allowing the mixture to cool slowly to room temperature over a period of 24 hours. Most of the crystals deposit between 130 and 100°C. The mass is carefully crushed and washed with acetone until the filtrate exhibits only a weak opalescence on addition of AgNO₃. The product is dried in vacuum over CaCl₂.

SYNONYM:

Zinc chloride hydroxide.

PROPERTIES:

Formula weight 117.85. Colorless hexagonal leaflets. The chloride content is removed by water.

REFERENCES:

- Driot. *Comptes Rendus Hebd. Séances Acad. Sci.* **150**, 1426 (1910);
W. Feitknecht. *Helv. Chim. Acta* **13**, 22 (1930).

Ammonium Tetrachlorozincate

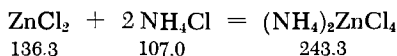
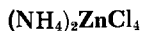

A solution of 70 g. of ZnCl_2 and 30 g. of NH_4Cl is prepared by heating with 29 (!) ml. of hot H_2O . It is advisable to measure the water with a balance. The homogeneous diammonium salt crystallizes on cooling. Yield 45 g.

The three-component system ZnCl_2 - NH_4Cl - H_2O has been investigated by Meerburg. It was found that $(\text{NH}_4)_2\text{ZnCl}_4$ can be precipitated only from solutions which have higher concentrations of ZnCl_2 than the desired salt. A solution containing ZnCl_2 and NH_4Cl in a 1:2 ratio usually yields the salt $\text{ZnCl}_2 \cdot 3\text{NH}_4\text{Cl}$.

PROPERTIES:

Shiny, orthorhombic leaflets, crystallizable only from ZnCl_2 solutions. M.p. $\sim 150^\circ\text{C}$; d 1.88. Crystal class D_{2h} .

REFERENCE:

P. A. Meerburg. Z. anorg. allg. Chem. 37, 199 (1903).

Zinc Bromide

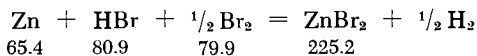

The purest material is obtained by electrolytically dissolving purified Zn in a mixture of aqueous HBr and Br_2 in a quartz dish. The solution is digested with an excess of Zn, filtered and crystallized by evaporation. The crystals are recrystallized from dilute hydrobromic acid and separated from the mother liquor by centrifugation. The product is then sublimed in a stream of HBr-N_2 .

Alternate method: See under zinc chloride, p. 1070.

PROPERTIES:

Colorless, highly hygroscopic crystals. Sublimes, producing lustrous needles. M.p. 394°C , b.p. 650°C ; d 4.201. Solubility (0°C)

388 g. (2 H₂O); (100°C) 675 g. (anhydrous ZnBr₂)/100 ml. H₂O. Anhydrous when crystallized above 37°C. Soluble in alcohol and ether. Crystal structure: tetragonal; space group I4₁/acd.

REFERENCES:

- G. P. Baxter and M. R. Grose. J. Amer. Chem. Soc. 38, 868 (1916);
G. P. Baxter and J. R. Hodges. Ibid. 43, 1242 (1921).

Zinc Iodide

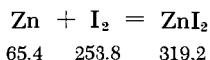

I. One part of zinc dust is digested with three parts of iodine and 10 parts of H₂O until disappearance of the I₂. The mixture is filtered and concentrated over H₂SO₄ and NaOH in a vacuum desiccator (N₂ atmosphere). The ZnI₂ which crystallizes out is vacuum-distilled at about 400°C.

Well-dried ZnI₂, prepared by the wet method, is sublimed in an oil-pump vacuum. The evolving iodine is expelled from the apparatus. The compound is obtained as a pure white sublimate.

II. One part of zinc dust is refluxed with two to four parts (depending on the quality of the Zn dust) of iodine and 10 parts of absolutely anhydrous ether until the initial coloration of the liquid disappears completely. The residual Zn-ZnO slurry is removed from the ether solution by filtration through a fritted glass filter. Most of the ether is distilled off, leaving a product containing about 0.5 mole of ether per mole; the ether is driven off in vacuum (fanning of the flask with a flame will help).

Alternate method: See under zinc chloride, p. 1070.

PROPERTIES:

Colorless, highly hygroscopic crystals. M.p. 446°C, b.p. 624°C; d 4.736. Solubility (18°C) 432 g.; (100°C) 510 g. (anhydrous salt)/100 ml. H₂O. Below 0°C, ZnI₂ · 2H₂O crystallizes out of solution. Soluble in ethanol, ether, acetone and dioxane. Sublimes in vacuum (crystal needles). Decomposes on heating in air. Crystal structure: tetragonal; space group I4₁/acd.

REFERENCES:

- I. T. J. Webb. *J. Phys. Chem.* **27**, 450 (1923); W. Biltz and C. Messerknecht. *Z. anorg. allg. Chem.* **129**, 161 (1923).
- II. Unpublished experiments of P. Laurer and R. Platz, Heidelberg.

Zinc Hydroxide

(crystalline)

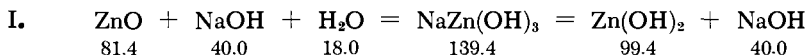
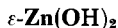

Analytical grade ZnO (160 g.) is refluxed in a round-bottom flask containing a solution of 600 g. of NaOH in 300 ml. of H₂O. After the ZnO is dissolved, the solution is diluted with 300 ml. of H₂O and cooled to 60°C. At this point, the volume of the solution is about 900 ml. It is filtered and diluted 10 times with water. Crystalline Zn(OH)₂ separates out after 2-3 weeks. This is filtered, washed first with cold water, then several times with warm water, and dried over conc. H₂SO₄.

Small needles are formed during the initial stages of crystallization; however, standing converts them into the other crystal form.

II. Amorphous Zn(OH)₂ is prepared by adding the stoichiometric quantity of ammonia to a solution containing a known quantity of ZnSO₄. The precipitate is filtered and washed thoroughly to remove as much of the adsorbed sulfate as possible [if the Zn(OH)₂ is worked up without preliminary washing, the product consists of basic sulfates]. The moist, washed precipitate is dissolved in the required amount of conc. ammonia. Then NH₃ is slowly separated from the solution by placing the beaker with the ammonia solution together with a beaker with H₂SO₄ under a bell jar. A large quantity of crystals is obtained within a week. It is important that the initial removal of NH₃ be slow; then the resultant crystals are 0.5 cm. long, on the average.

PROPERTIES:

Colorless crystals. In equilibrium with water, stable up to 39°C; decomposes at higher temperature. d 3.053. Crystal structure: type C31 [$\epsilon\text{-Zn(OH)}_2$ type].

In addition to the stable ϵ -Zn(OH)₂, there are five additional crystalline forms of the compound, which are unstable and convert spontaneously to ϵ -Zn(OH)₂.

REFERENCES:

- I. R. Scholder and G. Hendrich. Z. anorg. allg. Chem. 241, 76 (1939).
- II. H. G. Dietrich and J. Johnston. J. Amer. Chem. Soc. 49, 1419 (1927).

Zinc Sulfide

ZnS

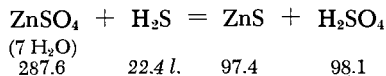

I. Zinc sulfide is preferably precipitated from a slightly acidic buffered aqueous solution: an aqueous solution of ZnSO₄ is treated with ammonium acetate; it is then saturated with H₂S with heating and frequent stirring (optimum pH for precipitation: 2-3). The precipitate is allowed to settle and the supernatant is decanted. The precipitate is shaken with 2% acetic acid saturated with H₂S; the solid is allowed to settle and the washing is repeated. To obtain an oxide-free product, the filtration and drying should be carried out in the absence of air.

II. Well-crystallized zincblende is obtained from pure, dry precipitated zinc sulfide by heating the sulfide in a stream of nitrogen for eight hours at 600-650°C. The reactor is a ceramic tube.

Pure wurtzite may be prepared from the same ZnS precipitate by heating in a stream of N₂ for one hour at 1150°C.

PROPERTIES:

White powder. M.p. ~ 1650°C (appreciable volatilization); distills without decomposition at high vacuum ($5 \cdot 10^{-4}$ mm.), d 4.14. Solubility (18°C) 0.688 mg. (freshly precipitated)/100 ml. H₂O. Soluble in dilute mineral acids. Hardness 3.5-4 (both modifications). The low-temperature modification (sphalerite) crystallizes in the cubic B3 system (zincblende), the high-temperature modification (wurtzite) in the hexagonal B4 system. Transition point: about 900°C. Grinding at room temperature converts the metastable wurtzite to zincblende.

REFERENCE:

H. Platz and P. W. Schenk. *Angew. Chem.* **49**, 822 (1936).

Zinc Formaldehydesulfoxylate

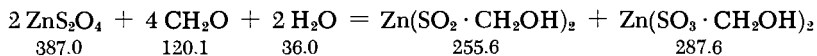
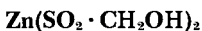

A 33% solution of ZnS_2O_4 (1300 g.) is added to 600 g. of a 30% formaldehyde solution; the addition is accompanied by a temperature rise to 50°C. The liquid is stirred and the temperature maintained at 60-65°C for some time. The mixture is filtered and set aside for 2-3 days. The clear solution is again filtered and concentrated in vacuum while SO_2 is aspirated in through a boiling capillary. The zinc formaldehydesulfoxylate is the first to precipitate. The crystals are separated from the mother liquor by centrifugation and dried by heating in vacuum.

The trihydrate is obtained at 60°C from a solution of 100 g. of the anhydrous salt in 100 ml. of H_2O , the tetrahydrate by allowing a solution saturated at 20°C to stand for some time.

The ZnS_2O_4 solution required in the preparation cannot be prepared according to the directions given on p. 394, since the latter procedure yields aqueous solutions containing only about 10% ZnS_2O_4 . In this case it is better to react a mixture of the purest possible Zn dust (200 g.) and H_2O (400 ml.) with SO_2 , which should be prewashed with an alkaline solution of $\text{Na}_2\text{S}_2\text{O}_4$. The reaction proceeds according to:

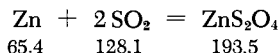

and is carried out in a wide-neck Erlenmeyer flask at 35-40°C (stirring). Initially, the mixture must be cooled; later it should be warmed. After several hours the reaction slurry is allowed to settle and the product is filtered through a Buchner funnel. The concentration of the viscous, unstable solution is determined by titration with a 0.01 M solution of indigo carmine [1 mole of indigo is equivalent to 1 mole of $\text{S}_2\text{O}_4^{2-}$; for additional analytical methods see G. Panizzon, *Melliand Textilber.* **12**, 119 (1931)].

A method for the preparation of secondary zinc formaldehydesulfoxylate is described in M. Bazlen, *Ber. Dtsch. chem. Ges.* **60**, 1470 (1927); cf. also K. Jellinek, *Das Hydrosulfit* [Hydroxysulfit], Part II, Stuttgart, 1912.

SYNONYMS:

Primary zinc oxymethanesulfinate; monozinc formaldehyde-sulfoxylate.

A technical-grade product containing over 90% of the anhydrous compound is available under the names Dekrolin soluble conc. (BASF), water-soluble Hydrosulfit BZ (Ciba), Sulfoxite S conc. (Du Pont), etc.

PROPERTIES:

Colorless crystal needles. The anhydrous salt is stable in air. The trihydrate (flakes with a nacreous luster) and the tetrahydrate (rhombohedral leaflets) are more labile. Soluble in H_2O . The solution acts as a bleaching agent and is quite resistant to acids. The reducing activity increases markedly with temperature; the rH values of a formic acid solution at pH 3 are: (25°C) 15; (50°C) 2; (90°C) a maximum of 0.5. Decomposes on prolonged boiling. The warm solution turns alkaline indanthrene yellow G paper blue and decolorizes an alcoholic solution of neutral red.

REFERENCES:

- K. Winnacker and E. Weingaertner. Chem. Technologie, Vol. 2, p. 80, Munich, 1950; BIOS Final Report No. 422, London, 1945; H. von Fehling. Neues Handwörterb. d. Chemie [New Handbook of Chemistry], Vol. X, p. 291, Braunschweig, 1930; A. Schaeffer. Melliand Textilber. 30, 111 (1949).

Ammonium Zinc Sulfate

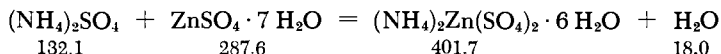

A solution of 45.2 g. of $ZnSO_4 \cdot 7H_2O$ and 20.8 g. of $(NH_4)_2SO_4$ is prepared in 75 ml. of boiling H_2O . The solution is filtered through a jacketed funnel heated with hot water. The crystals precipitating from the filtrate are separated from the mother liquor and dried in vacuum over anhydrous ammonium zinc sulfate or H_2SO_4 . Yield 50 g.

PROPERTIES:

Water-clear, efflorescent, monoclinic crystals. Solubility of the anhydrous salt (0°C) 7.3 g.; (20°C) 12.6 g.; (85°C) 46.2 g. per 100 ml. H_2O . d 1.93. Space group C_{2h}^5 .

Zinc Selenide

ZnSe

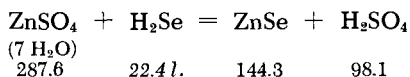

I. A dilute solution of ZnSO_4 , buffered with ammonium acetate, is added dropwise to a saturated aqueous solution of H_2Se , while a stream of H_2Se (from Al_2Se_3 and dilute HCl), diluted with oxygen-free N_2 or H_2 , is passed through the liquid. The precipitation vessel is heated on a steam bath. The excess H_2Se bubbling out of the solution is absorbed in a wash bottle filled with conc. nitric acid. If the Zn salt solution is introduced too rapidly or in too high a concentration, a white precipitate is formed; it requires a very long time to convert to the yellow ZnSe. Since the yellow ZnSe precipitate is difficult to filter, it is centrifuged and then washed (by centrifugation) first with boiled, weakly ammoniacal H_2O and then with methanol. It is dried in a vacuum desiccator over CaCl_2 , then at 120°C in a drying pistol over P_2O_5 .

When moist, zinc selenide is very sensitive to air. Therefore, to remove oxidation products the dry product is placed in a tube and heated for 2-4 hours at 600°C in a stream of H_2 or H_2Se . A boat containing a small amount of Se is placed ahead of the product. The heating is continued until all the Se in the boat evaporates. The cubic modification is thus obtained.

The hexagonal modification is obtained by treating ZnCl_2 vapor with H_2Se .

II. ZnSe may be prepared by a dry method from a mixture of 4 g. of ZnO, 2.5 g. of ZnS, and 6 g. of Se according to:

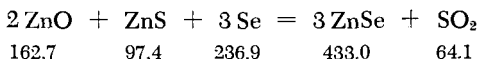

The mixture is heated for 15 minutes at 800°C in a covered quartz crucible.

It is also possible to start from 5 g. of ZnS and 6.5 g. of H_2SeO_3 , and then proceed as above. The reaction is formulated as:

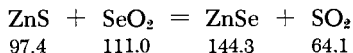

PROPERTIES:

Lemon-yellow powder. Soluble in fuming hydrochloric acid with evolution of H_2Se . d (pycn.) 5.30. Crystal structure: type B3 (zincblende type) or B4 (wurtzite type).

REFERENCES:

- I. R. Juza, A. Rabenau and G. Pascher. *Z. anorg. allg. Chem.* **285**, 61 (1956); Fonzes-Diacon. *Comptes Rendus Hebd. Séances Acad. Sci.* **130**, 832 (1900).
- II. A. Schleede and J. Glassner. German Patent 699,320 (1938), issued to Telefunken Co.

Zinc Amide

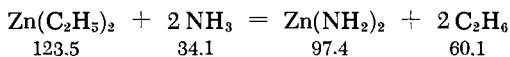

The preparation is carried out in the apparatus of Fig. 281. Diethylzinc is introduced into the storage vessel through the side tube, a blanket of CO_2 being provided; the side tube is then sealed. For each run, about 3 g. of $\text{Zn}(\text{C}_2\text{H}_5)_2$ is vacuum-distilled from *a* to *b*. The apparatus is then filled through stopcock *c* with very pure N_2 . The tube connecting the two vessels is broken at *d*, and 50 ml. of absolute ether, carefully dried with Na wire, is added through *e*. During these manipulations, the system is flushed with a fast stream of N_2 , which is introduced at *c* and leaves the apparatus through a CaCl_2 tube attached at *d*. The $\text{Zn}(\text{NH}_2)_2$ is precipitated from the ether solution by a stream of carefully purified NH_3 . Simultaneously, the ether in *b* is evaporated, an operation which requires about two hours. The product is comminuted by shaking (glass slug *f* is already present in *b*). Ammonia is then passed over the product for five hours at 150°C and for 12 hours at room temperature.

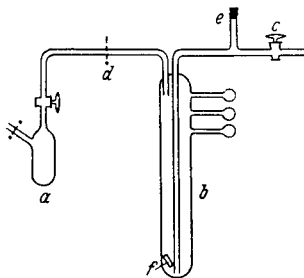

Fig. 281. Preparation of zinc amide.
a storage vessel for diethylzinc; *f* glass slug.

PROPERTIES:

Colorless, amorphous; decomposes slowly in air. d 2.13.

REFERENCE:

R. Juza, K. Fasold and W. Kuhn. Z. anorg. allg. Chem. 234, 86 (1937).

Zinc Nitride

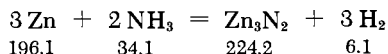

A porcelain boat containing ~7 g. of zinc dust is placed in a Vycor tube. The material is heated in a rapid stream of NH_3 for 17 hours at 500°C , for eight hours at 550°C , and finally for 16 hours at 600°C . In the process, about 3 g. of Zn is lost by distillation. The remainder is converted to Zn_3N_2 . This procedure assumes that the zinc does not fuse into a solid mass, even though it requires temperatures above the melting point for complete conversion to the nitride.

PROPERTIES:

Gray-black; quite stable in air. d (x-ray) 6.40. Crystal structure: type D5_3 (Mn_2O_3 type).

REFERENCE:

R. Juza, A Neuber and H. Hahn. Z. anorg. allg. Chem. 239, 273 (1938).

Zinc Phosphides

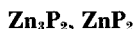

I. Weighed quantities of zinc and a very slight excess of red phosphorus (total about 12 g.) are slowly heated to 700°C in an evacuated quartz tube, about 12 cm. long and 10-12 mm. I.D.,

placed in an electric furnace. One end of the tube is allowed to project from the furnace to condense the volatilized phosphorus, which when liquid reacts very rapidly with the zinc. The Zn_3P_2 is then heated to $850^\circ C$, sublimed to the other end of the tube, which is maintained at $760^\circ C$, and kept at this temperature for about one day. A dense, homogeneous sublimate is obtained.

II. A mixture of Zn_3P_2 and ZnP_2 is obtained by passing phosphorus vapor over hot zinc (the procedure is outlined in the case of Zn_3As_2 , method I; see p. 1083).

PROPERTIES:

Zn_3P_2 : Gray. d (x-ray) 4.54. Evolves PH_3 with acids. Crystal structure: tetragonal, type $D5_9$ (Zn_3P_2 type).

ZnP_2 : Orange to red needles. d (x-ray) 3.51. Sublimes without decomposition in an atmosphere containing phosphorus vapor; insoluble in nonoxidizing acids. Crystal structure: tetragonal; space group D_4^4 or D_4^8 .

REFERENCES:

- I. R. Juza and K. Bär. Z. anorg. allg. Chem. 283, 230 (1956).
- II. M. von Stackelberg and R. Paulus. Z. phys. Chem. (B) 28, 427 (1935).

Zinc Phosphate

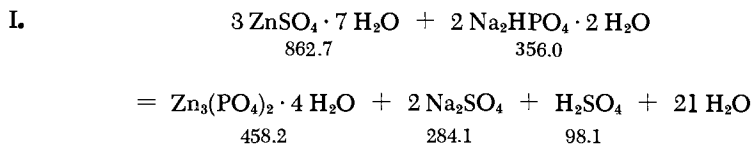
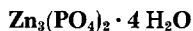

A solution of 5.8 g. of $ZnSO_4 \cdot 7H_2O$ in 400 ml. of H_2O is stirred at the boiling point with a solution of 2.5 g. of $Na_2HPO_4 \cdot 2H_2O$ in 100 ml. of H_2O . The crystalline precipitate which forms immediately is analytically pure.

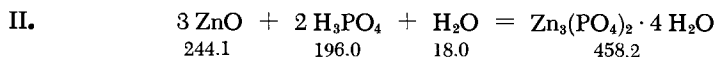

A 69% solution of H_2PO_4 (d 1.52, 100 g.) is saturated at the boiling point ($121^\circ C$) with ZnO (about 42 g.), taking care to replenish the evaporated water. The solution is then cooled to room

temperature and finally placed in ice. Ten parts (by volume) of ice-cold water is added with vigorous stirring and the solution is filtered into a porcelain dish, in which it is heated (with stirring) on a steam bath. The transparent lamellae of the tetrahydrate precipitate after a short time; they are suction-filtered, washed with boiling water, and dried on a clay plate. Yield 16 g.

PROPERTIES:

Colorless crystals, needle-shaped and tabular. Solubility in H_2O decreases with increasing temperature; can be recrystallized only from solutions containing phosphoric acid. Soluble in dilute acids and dilute ammonia. Loses two moles of H_2O at $100^\circ C$, a third mole at $190^\circ C$; the anhydrous salt is obtained at about $250^\circ C$. d 3.109. Hardness 2-3. Crystal structure: orthorhombic.

SYNONYM:

Zinc orthophosphate.

REFERENCES:

- I. E. Thilo and J. Schulz. *Z. anorg. allg. Chem.* **265**, 201 (1951).
- II. N. E. Eberly, C. V. Gross and W. S. Crowell. *J. Amer. Chem. Soc.* **42**, 1432 (1920).

Zinc Hydroxyphosphate

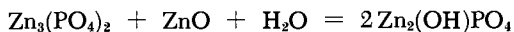

$4 H_2O$			
458.2	81.4	18.0	485.5

An intimate mixture of 1.146 g. (0.0025 mole) of $Zn_3(PO_4)_2 \cdot 4H_2O$ (cf. p. 1081) and 1.63 g. (0.02 mole) of ZnO is placed in a porcelain crucible and covered with water; the crucible is half full at this point. The crucible is heated in an autoclave for seven hours at $190^\circ C$ and 12 atm. The product is digested with 8% methanolic acetic acid on a fritted glass filter and is then washed until the filtrate is free of Zn. After drying at $100^\circ C$, the product is analytically pure.

PROPERTIES:

Formula weight 242.75. The colorless crystals are identical with the mineral tarbutite. The water of hydration is given off above $450^\circ C$. Crystal structure: triclinic.

REFERENCE:

E. Thilo and I. Schulz. *Z. anorg. allg. Chem.* **265**, 201 (1951).

Zinc Arsenides

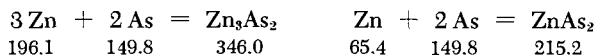
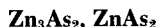

I. A Vycor tube containing a porcelain boat with pure zinc is heated to 700°C in an electrical furnace; the atmosphere in the tube consists of dry, pure N₂ or H₂. The As, in a second porcelain boat, is placed at the end of the tube which projects out of the furnace and is heated with a gas flame. The As vapor thus produced is carried over the metal by the stream of N₂ or H₂. Since the metal has already an appreciable vapor pressure at 700°C, crystals of Zn₃As₂ form on the boat rim and on the tube wall, while the unevaporated metal in the boat is converted to a gray-black mass of arsenide.

II. Heating stoichiometric quantities of Zn and As in an evacuated, sealed Vycor bomb at 780°C yields Zn₃As₂. The same conditions will produce ZnAs₂, provided an excess of As is used, since the vapor pressure of As in ZnAs₂, which results in decomposition of the latter, is quite high at the above temperature.

PROPERTIES:

Zn₃As₂: Gray. Gives off AsH₃ with acids. M.p. 1015°C; d (x-ray) 5.62. Sublimes at the m.p. to give needles or lamellae. Possesses metal-type conductivity. Hardness 3. Crystal structure: type D5₉ (Zn₃P₂ type).

ZnAs₂: Gray black. Orthorhombic crystals. M.p. 771°C. Sublimes at the m.p. Hardness 3. d (x-ray) 5.08.

REFERENCES:

M. von Stackelberg and R. Paulus. *Z. phys. Chem. (B)* **28**, 427 (1935); W. Heike. *Z. anorg. allg. Chem.* **118**, 264 (1921).

Zinc Thioantimonate

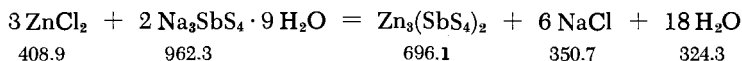
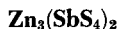

A solution of 25 g. of Schlippe's salt (see p. 619) in 75 ml. of H₂O is treated with a solution of 10.6 g. of ZnCl₂ (or 22.5 g. of

ZnSO₄ · 7H₂O) in 50 ml. of H₂O. The chrome yellow precipitate is washed several times by centrifugation with hot water. It is dried at 80°C, then at 100°C; the orange product is ground. It contains about 6% free S, which is extracted in a Soxhlet apparatus with CS₂.

PROPERTIES:

Orange powder. Decomposed by HCl. Discolors at 160°C; loses S at 200°C, forming Sb₂S₃. The corresponding Cd salt is orange-red, the mercury (II) salt ochre yellow. *d* (pycn.) 3.76.

REFERENCE:

F. Kirchhof. Z. anorg. allg. Chem. 112, 67 (1920).

Diethylzinc

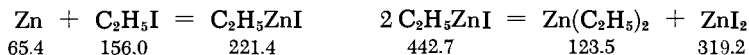

I. The 500-ml. flask *a* of Fig. 282 is charged with 200 g. of dry C₂H₅I (prepared by heating C₂H₅I with Na chips, and siphoning off and distilling the liquid) and 200 g. of zinc dust, previously cleaned with acid and dried at 160-180°C in a

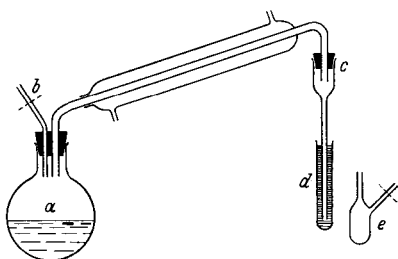

Fig. 282. Preparation of diethylzinc. *d* mercury seal; *e* ampoule for product storage.

stream of CO₂. Dry zinc turnings are then added until the pile of metal projects above the surface of the liquid. A stream of dry, air-free CO₂ or N₂ is introduced through *b*, expelling the air in the system. When the apparatus is filled with inert gas, the tip of tube *c* is dipped slightly into the mercury in cylinder *d* and capillary *b* is rapidly flame-sealed. The flask is then heated in an 80°C water bath. The temperature of the

bath is gradually raised to 96°C, while the tip of *c* is lowered into the mercury until it reaches about 20 cm. below the level of the metal. If all necessary precautions to exclude moisture have been taken, the reaction starts after about 1-1.5 hours of refluxing.

The reaction is complete after an additional 1.5-2 hours, when no further droplets of C_2H_5I condense in the flask (solid C_2H_5ZnI). The sealed capillary b is cut open, d is removed and replaced by vessel e , and a slow stream of the inert gas is passed through the system. The flask is then tilted so that the condenser points downward, and the $Zn(C_2H_5)_2$ is distilled on an oil bath (about $200^\circ C$) into e , which is then sealed in the usual way. Yield about 92%.

II. In Dennis's procedure, the starting material is a zinc-copper compound prepared by reducing a mixture of 200 g. of Zn dust and 25 g. of finely powdered CuO for 20 minutes at $400^\circ C$ in a stream of H_2 ; the product must be used immediately. Sufficient contact area between the metal and the C_2H_5I is achieved by mixing the finely ground metal with an equal amount of dry sand.

III. Larger quantities of $Zn(C_2H_5)_2$ may be prepared starting from a zinc alloy containing 5-8% Cu, which is prepared by fusing Zn with brass, casting into rods and cutting into chips. When this alloy is used, one half the necessary quantity of the quite expensive C_2H_5I may be replaced by C_2H_5Br . The reaction is then less vigorous.

The product $Zn(C_2H_5)_2$ is freed of ethane and C_2H_5I by low-pressure fractional distillation. It is stored in sealed ampoules or in a flask provided with a well-greased stopcock.

The same procedure may be used for the preparation of: di-n-propylzinc, b.p. (9 mm.) $40^\circ C$; di-n-butylzinc, b.p. (9 mm.), $81^\circ C$; and diisopentylzinc, b.p. (12 mm.) $100-103^\circ C$.

PROPERTIES:

Colorless liquid. M.p. $-30^\circ C$, b.p. (760 mm.) $117.6^\circ C$, (30 mm.) $27^\circ C$, (4 mm.) $0^\circ C$; d ($20^\circ C$) 1.207, ($8^\circ C$) 1.245. Resistant to CO_2 ; ignites in air. Decomposes extremely violently in H_2O , forming $Zn(OH)_2$ and C_2H_6 . Soluble in ether.

REFERENCES:

- I. E. Krause and A. von Grosse. *Chemie d. metallorgan. Verbindungen* [Chemistry of Organometallic Compounds], Berlin, 1937 [preparative directions cited from Simonovich. *Zh. Russ. Fiz.-Khim. Obsch.* 31, 38 (1899)].
- II. L. M. Dennis. *Z. anorg. allg. Chem.* 174, 133 (1928).
- III. *Organic Syntheses*. Coll. Vol. 2, New York and London 1943/50, p. 184; H. Grubitsch. *Anorgan.-präp. Chemie* [Preparative Inorganic Chemistry], Springer, Vienna, 1950, p. 458; A. W. Laubengayer and R. H. Fleckenstein. *Z. anorg. allg. Chem.* 191, 283 (1930).

Zinc Carbonate

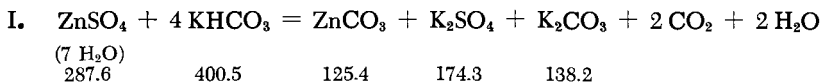

Neutral ZnCO₃ is obtained when zinc carbonate, precipitated at as low a temperature as possible, is allowed to age for a long time at low, gradually increasing temperature in a CO₂-free atmosphere.

A 1N KHCO₃ solution (300 ml.), cooled to 3°C and saturated with CO₂, is added with stirring to 700 ml. of a 0.1M ZnSO₄ solution at the same temperature. The temperature is maintained below 10°C during the first 3-4 days; it is then raised to 20°C and maintained there for an additional 2-3 days until the initial flaky precipitate has been transformed into a finely crystalline deposit. The product is washed several times by decantation with water, taking care to remove the flocculent material floating in the supernatant liquor, and washed free of sulfate on a filter. It is dried in a desiccator at room temperature, or by heating at 130°C.

The x-ray powder pattern of the product heated at 130°C corresponds to that of natural smithsonite (ZnCO₃), but contains seven additional lines. The yield is satisfactory.

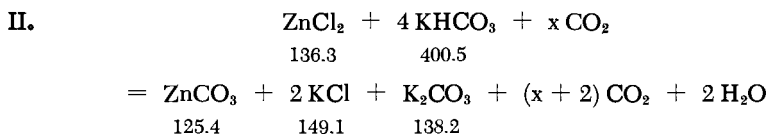

Preparation by rapid aging at moderate temperature under CO₂ pressure: 10 ml. of a conc. solution of ZnCl₂ is frozen with Dry Ice in a freezing tube. A fourfold excess of solid KHCO₃ and 10 ml. of H₂O are added. A few pieces of Dry Ice are added on top and the tube is melt-sealed while still cold. It is kept at room temperature until the contents melt. The tube is then held at 130°C for two hours.

Departures from the above two procedures result in basic products.

PROPERTIES:

Colorless. Converts to the basic salt on boiling with water. Thermal decomposition begins at 140°C; at 295.5°C the pressure of CO₂ is 700 mm. Solubility $5.7 \cdot 10^{-5}$ g./100 ml. H₂O. Readily

soluble in acids. d (pncn.) 4.4; d (x-ray) 4.51. Hardness 5 (natural zincspar). Crystal structure: rhombohedral, type $G0_1$ (calcite type).

REFERENCE:

G. F. Hüttig, A. Zörner and O. Hnevkovsky. *Monatsh. Chem.* **72**, 31 (1939).

Zinc Acetate

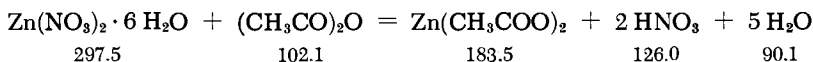

A mixture of 10.2 g. of $\text{Zn}(\text{NO}_3)_2 \cdot 6\text{H}_2\text{O}$ and 40 ml. of acetic anhydride is heated. When the vigorous reaction ceases, the mixture is stored in the cold for some time; the crystal slurry is then suction-filtered, washed with some acetic anhydride and ether, and dried in vacuum over KOH and H_2SO_4 . Yield 95%.

PROPERTIES:

Colorless, hexagonal, prismatic crystals. M.p. 242°C . Sublimes in vacuum without decomposition at lower temperatures; decomposes at temperatures higher than the m.p. d 1.84. Sparingly soluble in cold water, dissolves slowly in warm water. The dihydrate crystallizes from dilute acetic acid, the monohydrate from water and absolute alcohol.

REFERENCE:

E. Späth. *Monatsh. Chem.* **33**, 240 (1912).

Zinc Cyanide

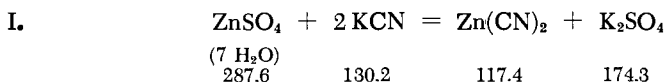

A solution of 10 g. of $\text{ZnSO}_4 \cdot 7\text{H}_2\text{O}$ in 100 ml. of H_2O is mixed (constant stirring) with a KCN solution until no further precipitate is formed (about 5 g. of KCN in 50 ml. of H_2O is needed). The

precipitate, which settles well on prolonged boiling, is washed repeatedly with hot H₂O and dried either with alcohol and ether or at 70°C. Yield about 4 g.

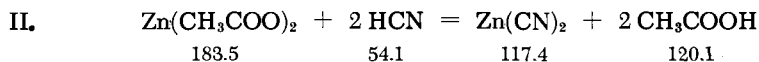

The Zn(CN)₂ is precipitated with hydrocyanic acid from a solution of Zn(OH)₂ in CH₃COOH. After washing, the product is dried at 110°C.

PROPERTIES:

White, amorphous powder or shiny, rhombic prisms. Insoluble in H₂O and alcohol. Soluble in alkali cyanides and aqueous ammonia; soluble in dilute acids (evolution of HCN). Decomposes at 800°C; d 1.852. Crystal structure: type C3 (Cu₂O type).

REFERENCES:

- I. Ullmann. Enzyklopädie d. techn. Chem. [Encyclopedia of Ind. Chem.], 2nd ed., 10, 718; Loebe. Thesis, Berlin, 1902.
- II. W. Biltz. Z. anorg. allg. Chem. 170, 161 (1928).

Potassium Tetracyanozincate

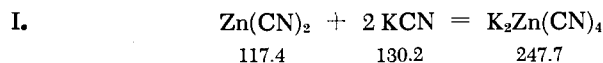

Zinc cyanide is dissolved in the equivalent amount of KCN solution. About 10 min. is required at room temperature; the process may be accelerated by heating. The salt precipitates from the solution on concentrating.

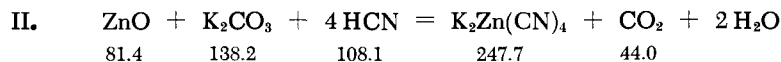

Zinc oxide is suspended in an aqueous solution of the equivalent quantity of K₂CO₃ and treated for several days with gaseous HCN until completely dissolved. Small crystals of the salt complex precipitate from the concentrated filtrate. They are dried at 105°C.

SYNONYM:

Potassium zinc cyanide, zinc potassium cyanide.

PROPERTIES:

Transparent octahedra. M.p. 538 °C; d 1.647. Solubility (20 °C) 11 g./100 ml. H₂O, 1 g./210 g. of 88% v./v. alcohol. Readily soluble in liquid NH₃. Crystal structure: type B1 (spinel).

REFERENCES:

- I. F. Spitzer. Z. Elektrochem. 11, 347 (1905).
 II. W. Biltz. Z. anorg. allg. Chem. 170, 161 (1928).

Zinc Silicate

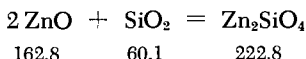

I. Two moles of ZnO and one mole of SiO₂ are intimately mixed. The reaction is facilitated by using finely divided starting materials and compressing the mixed powder into 5-g. tablets. The mixture is placed in a platinum boat inside a ceramic protective tube and heated above the melting point of Zn₂SiO₄ (> 1512 °C) in a Tammann furnace. The protective tube is closed at one end, which helps to exclude the reducing furnace gases to some extent. The reaction may be observed through a port made of cobalt glass. The melting point is reached when the upright raw material tablet collapses. To prevent evaporation of the ZnO, the heating must be rapid.

II. Tablets made of a mixture of two moles of ZnO and one mole of amorphous SiO₂ are heated for four days between 900 and 1000 °C. The x-ray powder pattern of the resultant product indicates a homogeneous material.

III. Pneumatolytic-hydrothermal synthesis from ZnO and SiO₂ in an autoclave at 365 °C.

SYNONYM:

Zinc orthosilicate.

PROPERTIES:

Colorless. Soluble in 20% HF, decomposed by HCl. M.p. 1512 °C; d 4.103. Hardness 5.5; crystal structure: type S1₃ (Be₂SiO₄ type). At 1432 °C, forms a eutectic containing one mole of SiO₂. Phosphoresces on activation with manganese.

REFERENCES:

- I. W. Biltz and A. Lemke. *Z. anorg. allg. Chem.* **203**, 330 (1932).
- II. A. Pabst. *Z. phys. Chem. (A)* **142**, 227 (1929).
- III. C. J. van Nieuwenburg and H. B. Blumendahl. *Rec. Trav. Chim. Pays-Bas* **50**, 129 (1931).

Zinc Fluorosilicate

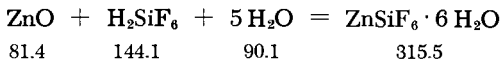
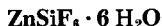

Somewhat less than the stoichiometric quantity of ZnO is dissolved in aqueous H_2SiF_6 . Complete saturation is avoided because it produces hydrolysis with formation of colloidal silicic acid. The mixture is evaporated on a steam bath in a platinum or lead dish until a film forms on the surface; the film is redissolved with some water and the product is allowed to crystallize over H_2SO_4 in a desiccator.

SYNONYM:

Zinc fluosilicate.

PROPERTIES:

Colorless, rhombohedral prisms, stable in air. Solubility (0°C) 50.3 g. of the anhydrous salt, (10°C) 52.8 g./100 ml. of saturated solution. A saturated solution at 20°C has $d \sim 1.4$. d (pyn.) 2.139, d (x-ray) 2.15. Crystal structure: trigonal.

REFERENCES:

- W. Stortenbecker. *Z. phys. Chem. (A)* **67**, 621 (1909); O. Ruff, C. Friedrich and E. Ascher. *Angew. Chem.* **43**, 1081 (1930).

Zinc Ferrate (III)

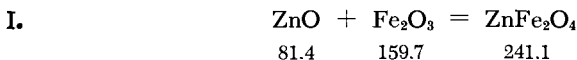

I. Zinc oxide, precipitated from ZnCl_2 solution and dried in vacuum over P_2O_5 , is mixed with α - or γ - FeOOH in a ratio of

1ZnO:1Fe₂O₃, taking into account the water content. The mixture is then screened and weighed out. The powder is mixed for four hours in a Pyrex bottle on a mechanical shaker. Following this, 4-g. portions of the mixture are placed in an open platinum crucible, which is then set in an electric furnace. The reaction may be carried out either at 800°C in a stream of dry air or at 1000°C in the absence of such an air flow. In either case, one hour is required for the reaction.

When ZnO (prepared by heating ZnCO₃ for two hours at 1000°C) and Fe₂O₃ are used instead of the above-specified raw materials, the mixture must be calcined for six hours at 800°C to obtain a ZnFe₂O₄ with a pure spinel lattice.

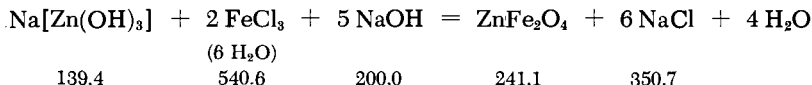
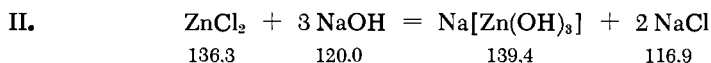

A solution of 2.4 moles of NaOH in 300 ml. of H₂O is allowed to react with a solution of 0.15 mole of ZnCl₂ in 100 ml. of H₂O. The resultant Na[Zn(OH)₃] solution is treated with a solution of 0.3 mole of FeCl₃ · 6H₂O and 1.2 moles of HCl in 5000 ml. of H₂O (vigorous stirring) and, after stirring two hours, heated for 0.5 hour at 60°C. The mixture is allowed to settle and is then allowed to react with 2N NaOH to a permanent red phenolphthalein color. The product is washed by repeated decantation with 2500-ml. portions of H₂O until the supernatant is free of Cl⁻ (about 15 washings are required), filtered through a sintered glass filter, washed until the solid is free of Cl⁻, and dried in a vacuum desiccator over P₂O₅ and solid KOH. The product then consists of almost black, highly lustrous, brittle pieces. These are crushed, sieved through a 0.15-mm. screen, and redried in the desiccator.

After annealing for one hour at 60°C, two spinel interferences are barely recognizable in the x-ray powder pattern. The spinel pattern becomes fully developed after heating to 500°C.

PROPERTIES:

Dry, brown ZnFe₂O₄ is paramagnetic when prepared by either the dry or the wet method. It absorbs more than its equivalent of Fe₂O₃ while maintaining its crystal lattice and becomes ferromagnetic. The magnetizability of these products is maximum at about 70 mole% Fe₂O₃. d (x-ray) 5.395. Crystal structure: type H1₁ (spinel type).

REFERENCES:

- R. Fricke and W. Dürr. *Z. Elektrochem.* 45, 254 (1939); G. F. Hüttig, M. Ehrenberg and H. Kittel. *Z. anorg. allg. Chem.* 228, 112 (1936).

Rinmann's Green

A mixture of the carbonates or oxalates of Zn and Co with an equal amount of KCl (e.g., 15 g. of ZnCO_3 , 3.5 g. of CoCO_3 , and 18.5 g. of KCl) is heated several hours at high temperature ($> 1000^\circ\text{C}$) in a Pt crucible. (The KCl serves as a flux and mineralizer.) The material should then be cooled under a CO_2 blanket. The reaction is brought to completion by repeating the procedure several times followed by washing. The KCl must be replenished between heatings.

At higher temperatures and on vacuum calcination, the color becomes lighter; it is malachite green in the presence of an excess of Zn, brownish pink with an excess of Co. Products calcined below 1000°C contain green-black ZnCo_2O_4 .

Rinmann's green consists of mixed ZnO-CoO crystals; the green, Co-deficient products (up to about 30% Co) consist of a solid solution of CoO in ZnO (wurtzite lattice). The pink, Co-rich preparations (above 70% CoO) are solutions of ZnO in CoO (NaCl lattice). The intermediate region is heterogeneous.

SYNONYMS:

Cobalt green, turquoise green, cinnabar green.

PROPERTIES:

Soluble in weak acids and solutions of $(\text{NH}_4)_2\text{CO}_3$. $d \sim 5.5$.

REFERENCES:

- J. A. Hedvall. *Z. anorg. allg. Chem.* 86, 201 (1914); C. Natta and L. Passerini. *Gazz. Chim. Ital.* 59, 620 (1929).

Cadmium

(needles)

Cd

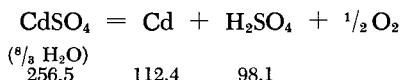

Two platinum disk electrodes (diameter 4.5 cm.) are placed one above the other (distance of about 5 cm.) in a vertical glass

cylinder (I.D. 7 cm.). The lower electrode serves as the cathode, the upper as the anode. The electrolyte is a conc. CdSO_4 solution slightly acidified with H_2SO_4 . The Cd is deposited as a fine crystalline powder on the cathode at a current density of 0.1–0.3 amp./cm.² The electrolysis vessel fills up quite rapidly with the silvery crystal powder. From time to time the loose powder is compressed with a glass rod to prevent establishment of a short circuit with the anode.

When the Cd in the electrolyte is depleted to such an extent that H_2 begins to evolve at the cathode, the solution must be replenished with CdSO_4 to avoid formation of a spongy deposit (the latter also appears at excessive current densities).

The compound is used as filler in the Jones reductor.

PROPERTIES:

Silvery-white crystal powder. M.p. 321°C, b.p. 765°C; d 8.642. Bulk density 80%. Solubility (18°C) 5.17 g./100 g. Hg. Soluble in mineral acids. Hardness 2. Electrochemical equivalent 2.097 g. (amp.-hr.)⁻¹. Crystal structure: type A3 (Mg type).

REFERENCES:

F. P. Treadwell. *Helv. Chim. Acta* **4**, 551 (1921); F. P. Treadwell. *Lehrbuch d. analyt. Chemie* [Analytical Chemistry], Vol. 2, Vienna, 1949, p. 542.

Cadmium Chloride

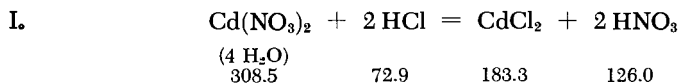

Repeated evaporation with very pure conc. hydrochloric acid converts $\text{Cd}(\text{NO}_3)_2 \cdot 4\text{H}_2\text{O}$ to the chloride. The product is recrystallized twice. Partial dehydration is achieved by storing for a prolonged time in a vacuum desiccator containing fused KOH (which is frequently replaced). Final dehydration is achieved by careful heating of the product in a stream of HCl, distilling twice in the same stream, and finally fusing the distillate under pure N_2 .

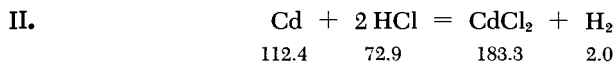

The reaction between Cd and HCl at 450°C is smooth and uniform. The chloride is distilled twice in a stream of HCl and melted under N_2 .

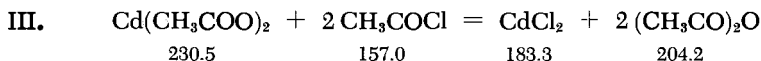

A warm solution of about 4 g. of cadmium acetate (dry) in anhydrous acetic acid (or a mixture of the latter with acetic anhydride) is treated with a slight excess of acetyl chloride or with gaseous HCl. The white precipitate which appears immediately is centrifuged off, washed once or twice with dry benzene, and dried at 100-120°C.

Cadmium bromide may be prepared by the same procedure from cadmium acetate and acetyl bromide (or HBr gas).

PROPERTIES:

Colorless rhombohedral leaflets. M.p. 568°C, b.p. 967°C. Solubility (0°C) 90.1 g. (2.5-hydrate), (20°C) 111.4 g. (2.5-hydrate), (100°C) 150 g. (1-hydrate)/100 ml. H₂O. Crystallizes as the monohydrate above 34°C. Solubility (15.5°C) 1.7 g. of anhydrous CdCl₂ per 100 g. of ethanol or methanol. *d* 4.047. Crystal structure: type C 19 (CdCl₂ type). Method III yields a white, microcrystalline powder which in the cold tends to form gelatinous inclusion products with various solvents (e.g., benzene).

REFERENCES:

- O. Hönigschmid and R. Schlee. *Z. anorg. allg. Chem.* 227, 184 (1936); H. D. Hardt. Private communication; A. R. Pray. *Inorg. Syn.* 5, 153 (1957); E. R. Epperson et al. *Ibid.* 7, 163 (1963).

Cadmium Hydroxychloride



Of the five basic cadmium chlorides, Cd(OH)Cl has the highest chloride content; it is the stable end product of the hydrolysis of not too dilute solutions of CdCl₂.

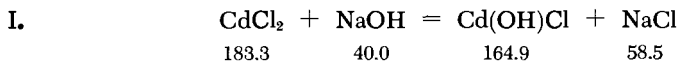

A 0.1-1M solution of CdCl₂ is treated with 30% of the stoichiometric quantity of aqueous NaOH. The resultant solution should have a pH of 6.6. The precipitate is a labile basic chloride which is converted in stages over a period of a few days to the stable Cd(OH)Cl, provided it is in contact with the mother liquor. The theoretical composition is obtained when a 1M solution of CdCl₂ is used as the starting material.

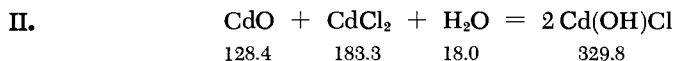

Cadmium oxide is heated for several days at 210°C with a solution of CdCl₂ in a sealed tube.

SYNONYM:

Cadmium chloride hydroxide.

PROPERTIES:

Colorless, elongated, hexagonal prisms. *d* 4.57. Layer lattice, type E0₃ [Cd(OH)Cl type].

REFERENCES:

- I. W. Feitknecht and W. Gerber. *Helv. Chim. Acta* 20, 1344 (1937); *Z. Kristallogr. (A)* 98, 168 (1937).
- II. I. L. Hoard and O. D. Grenko. *Z. Kristallogr. (A)* 87, 110 (1934).

Potassium Cadmium Chloride

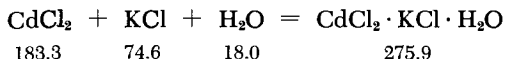

This double salt crystallizes below 36.5°C from an aqueous solution of equimolar quantities of the components. The anhydrous salt crystallizes at higher temperature.

The compound is used in the Lipscomb-Hulett standard cell (704 mv.).

PROPERTIES:

Fine silky needles. The saturated solution contains the following amounts of the anhydrous salt: (2.6°C) 21.87 g., (19.3°C) 27.50 g., (41.5°C) 35.66 g., (105.1°C) 51.67 g./100 g.

REFERENCE:

- H. Hering. *Comptes Rendus Hebd. Séances Acad. Sci.* 194, 1157 (1932).

Cadmium Bromide

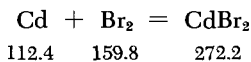

Cadmium is brominated at 450°C in a quartz boat placed inside a Vycor tube initially filled with dry N₂. Nitrogen is then passed through a washing bottle filled with Br₂ and introduced into the tube. The complete bromination of 3 g. of Cd requires about two hours at 450°C. Raising the temperature to increase the reaction rate is not recommended, since this may cause appreciable quantities of the metal to distill with the product. The molten CdBr₂ is deep red as long as unreacted metal is present and becomes increasingly lighter as the metal is consumed, so that the end of the reaction may be readily recognized by the final permanent light color. The product CdBr₂ is distilled twice in a stream of Br₂ by raising the temperature; it is freed of excess Br₂ by remelting under pure CO₂. The entire procedure may be carried out in the apparatus described by O. Hönigschmid and F. Wittner [Z. anorg. allg. Chem. 226, 297 (1936)] for the preparation of pure uranium halides; it is also described under UBr₄ (p. 1440).

Alternate method: See under zinc chloride (p. 1070) and cadmium chloride (p. 1093).

PROPERTIES:

Colorless, hexagonal, pearly flakes; highly hygroscopic. M.p. 566°C, b.p. 963°C; d 5.192. Solubility (18°C) 95 g., (100°C) 160 g. per 100 ml. H₂O. Crystallizes as the monohydrate below 36°C, as the tetrahydrate above this temperature. Solubility (15°C) 26.4 g. of anhydrous CdBr₂/100 g. alcohol. Crystal structure: type C 19 (CdCl₂ type).

REFERENCE:

O. Hönigschmid and R. Schlee. Z. anorg. allg. Chem. 227, 184 (1936).

Cadmium Iodide



Cadmium shavings (or Cd slurry obtained from CdSO₄ solution + Zn) are shaken in distilled H₂O with the equivalent quantity

of resublimed iodine. The shaking may be dispensed with if the mixture is refluxed for two hours. After the color of the liquid disappears, it is filtered and concentrated on a steam bath. The crystals are vacuum-dried for 24 hours over P_2O_5 at 100-150°C.

Carefully dried CdI_2 may be sublimed in a stream of oxygen-free CO_2 . The CdI_2 vapor is condensed in a long glass tube closed off with canvas. This yields "CdI₂ flowers."

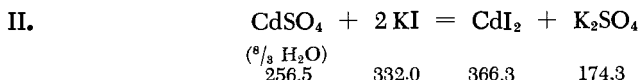

An aqueous solution of three parts of $CdSO_4 \cdot \frac{8}{3} H_2O$ and four parts of KI is evaporated to dryness and extracted with warm absolute alcohol. The CdI_2 crystallizes in colorless lamellae upon cooling of the solution.

Alternate method: See under zinc chloride, p. 1070.

PROPERTIES:

Colorless, lustrous, hexagonal leaflets; stable in air. M.p. 387°C, b.p. 787°C; d 5.67. Solubility (18°C) 85 g., (100°C) 128 g./100 ml. H_2O ; (20°C) 176 g./100 ml. methanol; ~90 g./100 ml. of ethanol. Soluble in ether. Crystal structure: type C 6 (CdI_2) and C27 (second CdI_2 type). d (x-ray) of both structures is identical.

REFERENCES:

- I. W. Biltz and C. Mau. Z. anorg. allg. Chem. 148, 170 (1925); E. Cohen and A. L. Th. Moesveld. Z. phys. Chem. 94, 471 (1920).
- II. Jahresber. Fortschr. d. Chem. 1864, 242.

Cadmium Hydroxide



I. COARSE CRYSTALS

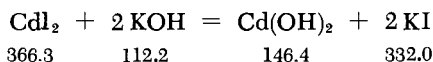

A solution of 10 g. of CdI_2 in 200 ml. of water is mixed with 320 g. of carbonate-free KOH. The mixture is heated until the first precipitate of $Cd(OH)_2$ redissolves at about 135°C. The heating must be accompanied by continuous stirring to prevent

the lower layers of the liquid from reaching a temperature high enough to cause partial conversion of the $\text{Cd}(\text{OH})_2$ to black, sparingly soluble CdO . The major part of the $\text{Cd}(\text{OH})_2$ crystallizes when the solution is slowly cooled. However, a part of the hydrate remains in solution even after complete cooling and may precipitate as amorphous $\text{Cd}(\text{OH})_2$ if the product is immediately treated with water. Therefore, the mixture is allowed to stand for 12 hours before attempting to separate the $\text{Cd}(\text{OH})_2$ with water.

II. Very homogenous $\text{Cd}(\text{OH})_2$ is obtained from cadmium acetate and 85% KOH following precipitation of crystalline CdO by the same procedure.

III. FINE CRYSTALS

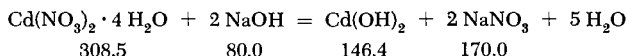

A finely crystalline product is obtained by dropwise addition (stirring or shaking) of a boiling solution of $\text{Cd}(\text{NO}_3)_2$ to boiling, carbonate-free 0.82N NaOH (stoichiometric quantities). The precipitate is repeatedly washed with hot water and vacuum-dried over P_2O_5 at 60°C. (For details, see in the original.)

PROPERTIES:

Nacreous, hexagonal leaflets soluble in acids and NH_4Cl solution. Solubility (25°C) 0.26 mg./100 ml. H_2O ; 0.13 g./100 ml. 5N NaOH. Dehydration starts at 130°C, is complete at 200°C. d 4.79. Crystal structure: type C6 (CdI_2 type).

REFERENCES:

- I. A. de Schulten. Comptes Rendus Hebd. Séances Acad. Sci. 101, 72 (1885).
- II. R. Scholder and E. Staufienbiel. Z. anorg. allg. Chem. 247, 271 (1941).
- III. R. Fricke and F. Blaschke. Z. Elektrochem. 46, 46 (1940).

Cadmium Sulfide

CdS

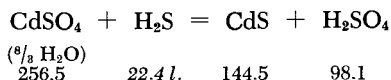

Finely divided cubic CdS is obtained by precipitation with H_2S of a hot, H_2SO_4 -acidified aqueous solution of CdSO_4 . The hexagonal

modification (more or less free of cubic CdS) is obtained from cadmium halide solutions; however, the resultant sulfide is contaminated with strongly adhering halide which cannot be washed out.

Depending on the particle size and the state of the surface, the color of the precipitates varies from lemon yellow to orange. Lemon yellow "cadmium yellow" is prepared by precipitating, with constant stirring, a very diluted neutral solution of CdSO_4 with an excess of Na_2S solution. The precipitate is then washed free of sulfate.

Dark CdS is obtained by calcining a mixture of two parts of CdCO_3 and one part of sulfur powder in a crucible. The product is pulverized after cooling.

Pure CdS, free of the anions of the precipitating medium, is prepared by bubbling H_2S through a solution of $\text{Cd}(\text{ClO}_4)_2$ in 0.1-0.3N perchloric acid. Lower acid concentrations yield precipitates which are difficult to filter; the precipitation is incomplete at higher concentrations.

Crystals a few millimeters in size are obtained from H_2S and Cd vapor at about 800°C (see Frerichs' method in the literature below).

PROPERTIES:

Lemon-yellow to orange powder. Solubility (18°C) 0.13 mg./100 ml. H_2O . Soluble in conc. or warm dilute mineral acids. Sublimes at 980°C . d 4.82. Hardness 3. Crystal structure: cubic type B3 (zincblende type) and hexagonal type B4 (wurtzite type). The cubic modification is converted to the hexagonal by heating at $700\text{-}800^\circ\text{C}$ in sulfur vapor.

REFERENCES:

- W. O. Milligan. *J. Phys. Chem.* **38**, 797 (1934); H. B. Weiser and E. J. Durham. *Ibid.* **32**, 1061 (1928); W. J. Müller and G. Löffler. *Angew. Chem.* **46**, 538 (1933); E. Dönges. Unpublished; G. Denk and F. Denk. *Z. analyt. Chem.* **130**, 383 (1949/50); R. Frerichs. *Naturwiss.* **33**, 2181 (1946).

CADMIUM SELENIDE CdSe

The preparation is analogous to that of ZnSe (method I, see p. 1078).

PROPERTIES:

Formula weight 191.37. Dark-red powder. d (x-ray) 5.767. Crystal structure: type B3 (zincblende type) and B4 (wurtzite type).

Cadmium Nitride

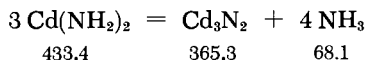

Cadmium amide, $\text{Cd}(\text{NH}_2)_2$, is thermally decomposed in a vapor pressure eudiometer (see Part I, p. 102) at 180°C while repeatedly removing measured amounts of NH_3 . The evolution of NH_3 ceases after about 36 hours. The Cd_3N_2 product decomposes if the temperature is raised higher.

PROPERTIES:

Black; forms oxide in air. d (x-ray) 7.67. Crystal structure: type D5_3 (Mn_2O_3).

REFERENCE:

H. Hahn and R. Juza. *Z. anorg. allg. Chem.* **244**, 111 (1940).

Cadmium Amide

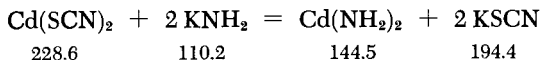

Cadmium thiocyanate (7 g.) is placed on filter disk *b* of vessel *a* (Fig. 283). About 15 ml. of carefully purified NH_3 is condensed

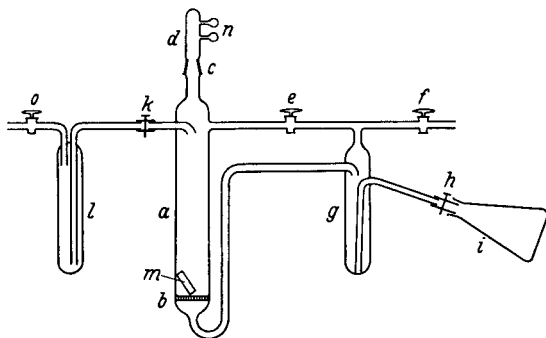

Fig. 283. Preparation of cadmium amide. *h* and *k* pinch clamps; *l* storage vessel for ammonia; *m* glass slug; *n* glass bulbs.

onto the salt, which then dissolves in the ammonia. A solution of KNH_2 in liquid NH_3 is added to the above mixture through the ground joint *c*, and the vessel is closed off with ground cap *d*. A fluffy, white precipitate of $\text{Cd}(\text{NH}_2)_2$ is formed. The amount of KNH_2 used must be somewhat less than stoichiometric as $\text{Cd}(\text{NH}_2)_2$ dissolves in excess KNH_2 . In addition, no air must be allowed to be present during the reaction; a stream of N_2 is therefore passed through the apparatus when it is opened for any reason.

After thorough mixing of the two solutions, the supernatant liquid containing KSCN and excess $\text{Cd}(\text{SCN})_2$ in liquid NH_3 is filtered by suction through disk *b*. This operation is performed by closing stopcock *e* and carefully evacuating the apparatus through *f*; this results in transfer of the liquid from *a* to *g*, which is cooled with Dry Ice-alcohol. The liquid is then removed from the system and into flask *i* by application of slight pressure, achieved by closing *f*, raising the temperature in *g* temporarily (remove the cooling bath), and opening the screw pinchcock *h*. After closing *h*, the product is washed by producing a slight vacuum in the system and transferring fresh liquid ammonia from storage vessel *l* through screw pinchcock *k* onto the product in *a*. Washing is complete when the NH_3 evaporates without leaving a residue. When this point is reached, all the NH_3 is removed (by suction) from the product. The latter is then knocked off the walls by means of the glass slug *m* and transferred to bulbs *n*. The preparation is carried out at (or near) the boiling point of NH_3 (-33.5°C). Very pure N_2 , introduced through stopcocks *o* or *f*, is used as the blanketing gas.

PROPERTIES:

Slightly yellowish, amorphous; rapidly discolors to brown in air. *d* 3.05.

REFERENCE:

R. Juza, K. Fasold and W. Kuhn. *Z. anorg. allg. Chem.* **234**, 86 (1937).

Cadmium Phosphides



The procedure for the preparation Cd_3P_2 is similar to that for Zn_3P_2 (method I, see p. 1080); that is, it is produced in an

evacuated quartz tube from Cd metal and red P. The temperature along the tube varies from 400 to 600°C. The mixture is allowed to react for about nine hours, and the entire tube is then heated for 12 hours at 680°C. The resultant Cd_3P_2 is resublimed several times over an open flame, and finally sublimed at 680°C into a slightly colder part of the quartz tube.



A mixture of CdP_2 with Cd_3P_2 is formed by using the procedure given (see p. 1083) for Zn_3As_2 (method I).



A mixture of 0.6 g. of white phosphorus and 20 g. of a Pb-Cd alloy containing 5% Cd is sealed under a CO_2 blanket in a Vycor ampoule. The ampoule is heated in an electric furnace to 565-575°C (the heatup time is a few hours) and maintained at this temperature for 2.5-5 days. If large crystals are desired, the temperature gradient in the furnace should be small and the cooling slow. The CdP_4 is purified by boiling with glacial acetic acid and H_2O_2 and subsequent treatment with 20% hydrochloric acid.

The starting Pb-Cd alloy is prepared by fusing the two metals under KCN in a porcelain crucible and cutting the product into strips. Commercial phosphorus is purified by melting under dilute chromosulfuric acid and dried under CO_2 .

PROPERTIES:

Cd_3P_2 : Gray, lustrous needles or leaflets. M.p. 700°C; d (x-ray) 5.60. Soluble in hydrochloric acid with evolution of PH_3 , explosive reaction with conc. nitric acid. Crystal structure: tetragonal, type $D5_9$ (Zn_3P_2).

CdP_2 : Orange to red [appears occasionally in an indigo blue modification: B. Renault, Comptes Rendus Hebd. Séances Acad. Sci. 76, 283 (1873)]. Tetragonal needles. d (x-ray) 4.19.

CdP_4 : Black, highly reflecting crystals. Very unreactive, dissolves in boiling aqua regia. Decomposes into the elements on heating in vacuum. d (pync.) 3.90. Crystal structure: monoclinic, space group C_{2h}^5 .

REFERENCES:

- I. R. Juza and K. Bär. Z. anorg. allg. Chem. 283, 230 (1956).
- II. M. von Stackelberg and R. Paulus. Z. phys. Chem. (B) 28, 427 (1935).
- III. H. Krebs, K. H. Müller and G. Zürm. Z. anorg. allg. Chem. 285, 15 (1956).

Cadmium Arsenides

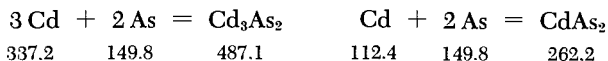
 Cd_3As_2 , CdAs_2 

The preparation of Cd_3As_2 is similar to that of Zn_3As_2 (method I): heating the metal in a stream of hydrogen that carries arsenic vapor (see p. 1083).

The phase diagram indicates the existence of CdAs_2 , which may be prepared by fusing the components.

PROPERTIES:

Cd_3As_2 : Gray. M.p. 721°C . Hardness < 3.5 . d (x-ray) 6.35, d (pycn.) 6.211. Crystal structure: tetragonal, type $D5_9$ (Zn_3P_2).
 CdAs_2 : Gray-black. M.p. 621°C . Hardness 3.5-4.

REFERENCES:

M. von Stackelberg and R. Paulus. *Z. phys. Chem* (B) **28**, 427 (1935); A. Granger. *Comptes Rendus Hebd. Séances Acad. Sci.* **138**, 574 (1904); Zemczuny. *Z. Metallographie* **4**, 228 (1913).

Diethylcadmium

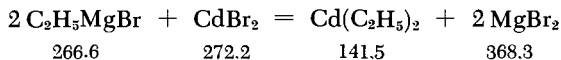
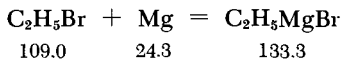
 $\text{Cd}(\text{C}_2\text{H}_5)_2$ 

Anhydrous, finely ground CdBr_2 (136 g., 0.5 mole) is added in small portions (vigorous shaking and no cooling) to a solution of $\text{C}_2\text{H}_5\text{MgBr}$ in 350 ml. of absolute ether. The latter reagent is prepared from 29 g. (1.2 moles) of Mg and 131 g. (1.2 moles) of $\text{C}_2\text{H}_5\text{Br}$, the amount required to dissolve the metal. The major portion of the ether is distilled off in a stream of N_2 on a water bath whose temperature does not exceed 80°C . The solid, porous, gray mass left in the flask is then distilled at 1 mm. into a liquid-nitrogen-cooled trap, while the temperature of the oil bath is raised from 20 to 120°C over the one-hour distillation period.

The clear, completely colorless distillate is carefully freed of ether by distilling the latter in a nitrogen stream; the residue is distilled in N_2 at 19.5 mm. All the $Cd(C_2H_5)_2$ goes over at $64.0^\circ C$; it is analytically pure. Yield 90%.

PROPERTIES:

Colorless oil with an unpleasant odor. M.p. $-21^\circ C$, b.p. (19.5 mm.) $64^\circ C$, (760 mm.) $164.7^\circ C$. Decomposes at $150^\circ C$, explosively at $180^\circ C$. May be stored without decomposition in a sealed tube filled with N_2 . Fumes explosively in air, at first forming white and then (rapidly) brown clouds accompanied by violent detonation. Decomposed by H_2O with a characteristic crackling sound continuing for hours on end. d ($21.7^\circ C$) 1.653.

REFERENCE:

E. Krause. Ber. dtsh. chem. Ges. 50, 1813 (1918).

Cadmium Carbonate

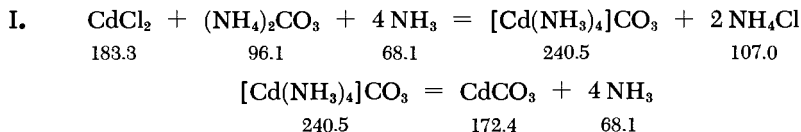

A solution of $(NH_4)_2CO_3$ is added all at once to a solution of $CdCl_2$, followed by the quantity of ammonia necessary to dissolve the resultant precipitate. The liquid is then heated in an open vessel on a water bath. The $CdCO_3$ separates as shiny crystals.

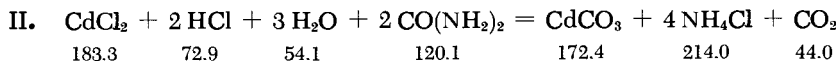

A vertical bomb (wall thickness 3 mm., diameter 25 mm., height about 50 cm.) contains a solution of 10 mmoles of $CdCl_2$ in 30 ml. of H_2O , 0.3 ml. of conc. hydrochloric acid, and a small glass beaker filled with 20 mmoles of urea. A long stem from the bottom of the bomb supports the beaker above the liquid surface. The bomb is melt-sealed and heated at $200^\circ C$ for 18-24 hours. The yield is almost quantitative.

PROPERTIES:

White powder or rhombohedral leaflets. Sparingly soluble in H_2O , soluble in acid. Vapor pressure at decomposition ($321^\circ C$) 77 mm., ($357^\circ C$) 760 mm. d 4.258. Crystal structure: type GO_1 (calcite).

REFERENCES:

- I. A. de Schulten. Bull. Soc. Chim. France [3] 19, 34 (1898).
 II. W. Biltz. Z. anorg. allg. Chem. 220, 312 (1934).

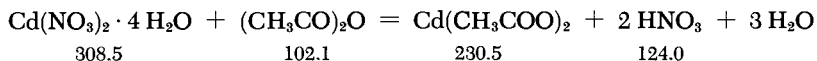
Cadmium Acetate

A mixture of 5 g. of $\text{Cd}(\text{NO}_3)_2 \cdot 4\text{H}_2\text{O}$ and 25 ml. of acetic anhydride is heated; when the vigorous reaction has ceased, the mixture is refluxed 15 minutes. After cooling and suction-filtering, the white, crystalline precipitate is washed with some acetic anhydride and ether, and vacuum-dried over KOH and H_2SO_4 . Yield 3.6 g. (97%).

PROPERTIES:

Colorless crystals. M.p. 254-256°C; d 2.341.

REFERENCE:

- E. Späth. Monatsh. Chem. 33, 241 (1912).

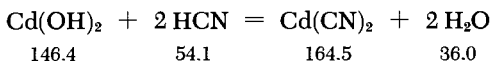
Cadmium Cyanide

Evaporation of a solution of $\text{Cd}(\text{OH})_2$ in aqueous HCN precipitates $\text{Cd}(\text{CN})_2$ in the form of crystals. These are dried at 110°C.

PROPERTIES:

Air-stable crystals; turn brown on heating in air. Solubility (15°C) 1.7 g./100 ml. H_2O . Soluble in KCN solution. d 2.226. Crystal structure: type C 3 (Cu_2O type).

REFERENCE:

- W. Biltz. Z. anorg. allg. Chem. 170, 161 (1928).

Potassium Tetracyanocadmiate

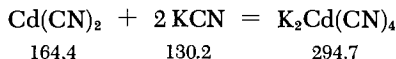

Cadmium cyanide, obtained by precipitation of a CdSO_4 solution with KCN and filtering, is dissolved (shaking) in an aqueous solution of the stoichiometric quantity of KCN. The filtrate is crystallized by evaporation. The product is dried at 105°C .

SYNONYMS:

Potassium cadmium cyanide, cadmium potassium cyanide.

PROPERTIES:

Octahedral, very refractive, air-stable crystals. Solubility (cold) 33.3 g., (b.p.) 100 g./100 ml. H_2O ; (20°C) 2 g./100 g. of 88% v./v. alcohol. M.p. about 450°C ; d 1.846. Crystal structure: type Hl_1 (spinel type).

REFERENCE:

W. Biltz. Z. anorg. allg. Chem. 170, 161 (1928).

Cadmium Thiocyanate

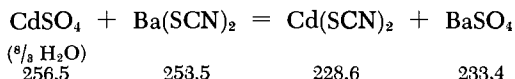

To a boiling solution of 12.68 g. of $\text{Ba}(\text{SCN})_2$ is added, in drops, 12.83 g. of $\text{CdSO}_4 \cdot \frac{8}{3} \text{H}_2\text{O}$ in 100 ml. of boiling H_2O , taking care to keep the liquid boiling. After cooling, the precipitate is allowed to settle and the mixture is filtered after standing for some time. The filtrate is evaporated to 80 ml., filtered again, and evaporated to dryness on a water bath.

The required starting solution of $\text{Ba}(\text{SCN})_2$ is prepared by dissolving 15.78 g. of $\text{Ba}(\text{OH})_2 \cdot 8 \text{H}_2\text{O}$ in 500 ml. of H_2O and allowing it to react with a solution of 7.62 g. of NH_4SCN in 100 ml. of H_2O , according to the equation

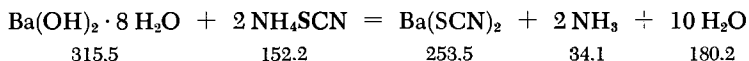

The mixture is brought to a boil and heated until NH_3 ceases to evolve.

SYNONYMS:

Cadmium rhodanide.

PROPERTIES:

Colorless crystal crusts. Soluble in H_2O , alcohol and liquid NH_3 .

REFERENCE:

H. Grossmann. Ber. dtsch. chem. Ges. 35, 2666 (1902).

Cadmium Silicate

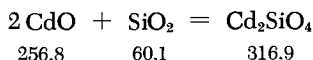

Like Zn_2SiO_4 , Cd_2SiO_4 is prepared from the oxides by fusion or by hydrothermal synthesis (see p. 1089).

SYNONYM:

Cadmium orthosilicate.

PROPERTIES:

M.p. 1246°C ; d 5.833. Phosphorescent after activation with manganese.

REFERENCE:

W. Biltz and A. Lemke. Z. anorg. allg. Chem. 203, 330 (1932);
C. J. van Nieuwenburg and H. B. Blumendahl. Rec. Trav. Chim. Pays-Bas 50, 989 (1931).

Cadmium Ferrate (III)

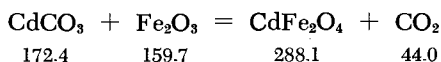

Finely screened CdCO_3 [or $\text{Cd}(\text{OH})_2$] and $\gamma\text{-FeOOH}$ (p. 1500) in a Cd:Fe ratio of 1:2 are mixed for five hours on a mechanical

shaker in an atmosphere free of CO_2 and H_2O . The loose powder is divided into 5-g. portions, which are heated for one hour in a platinum crucible at 800°C [mixtures with $\text{Cd}(\text{OH})_2$ at 1000°C] and then allowed to cool to room temperature in a desiccator. The compound cannot be prepared by precipitation.

PROPERTIES:

Dark brown, hygroscopic powder; stable at room temperature. Crystal structure: type Hl_1 (spinel type).

REFERENCE:

R. Fricke and F. Blaschke. Z. anorg. allg. Chem. 251, 396 (1943).

Mercury (II) Oxychloride

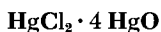

I. To prepare brown $\text{HgCl}_2 \cdot 4 \text{HgO}$, a solution of 15.0 g. of borax in 1.5 liters of water is added to a solution of 10.0 g. of mercuric chloride in 2.0 liters of water (both solutions are at $50\text{--}55^\circ\text{C}$). The desired compound separates on cooling in the form of thin, flexible flakes 0.1-0.8 mm. long. Depending on the thickness of these flakes, the color of the precipitate varies from golden yellow to black-brown. The yield is about 85%, based on the HgCl_2 used.

II. Black $\text{HgCl}_2 \cdot 4 \text{HgO}$ is obtained when 5.0 g. of finely crystalline brown $\text{HgCl}_2 \cdot 4 \text{HgO}$ is heated for 72 hours in a sealed tube with 10 ml. of 0.1N HNO_3 at 180°C . The product separates in the form of rhombic needles several millimeters long, which are readily isolated from the basic nitrate present in the mixture.

SYNONYM:

Mercuric oxychloride.

PROPERTIES:

I. Depending on the thickness, golden yellow to dark brown flakes; elongated brown crystals from concentrated solutions. Soluble in hot water (partial decomposition). The powder pattern distinguishes it from the black form (appearance of lattice defects). Brown $\text{HgCl}_2 \cdot 4 \text{HgO}$ has a remarkably wide phase range, from 3.82 to 4.00 HgO .

II. Black, needle-shaped crystals, sparingly soluble in water. d (pync.) 9.01. Crystal structure: orthorhombic, space group D_{2h}^{26} .

REFERENCES:

- I. A. Weiss, G. Nagorsen and A. Weiss. Z. Naturforsch. 9b, 81 (1954).
- II. A. Weiss. Private communication.

Mercury (II) Bromide

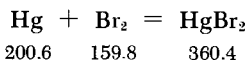

Five parts of Hg are covered with 60 parts of H_2O and allowed to react at 50°C (vigorous stirring) with four parts of Br_2 , which is added dropwise as long as no permanent color is formed. The solution is then brought to a boil, filtered hot, and placed in an ice bath to induce crystallization. The salt is dried at as low a temperature as possible. Purification is by careful double or triple sublimation from a porcelain dish heated on a sand bath and covered with a Petri dish. When very high purity is required (e.g., for conductivity measurements), it may be necessary to repeat the sublimation several times more.

PROPERTIES:

Colorless, lustrous crystal flakes (sublimate and from H_2O), rhombic prisms or needles (from alcohol). Light yellow liquid between m.p. 238°C and b.p. 320.3°C . d^{20} 5.73; $d^{24.2}$ (liq.) 5.11. Vapor pressure (200°C) 24.1 mm., (280°C) 334.2 mm.; sublimes without decomposition. Solubility (25°C) 0.62 g., (100°C) 22 g. per 100 g. H_2O ; (25°C) 30.0 g./100 g. ethanol; (25°C) 69.4 g./100 g. methanol. Specific electrical conductivity (242°C) $1.45 \cdot 10^{-4}$ ohm $^{-1}$. Its melt is a solvent for a large number of inorganic and organic substances, which impart considerable conductivity to the melt. Cryoscopic constant 36.7 deg. per mole in 1000 g. of HgBr_2 . Rhombic layered lattice, space group C_{2v}^{12} .

REFERENCES:

- W. Reinders. Z. phys. Chem. (A) 32, 514 (1900); G. Jander and K. Brodersen. Z. anorg. Chem. 261, 264 (1950).

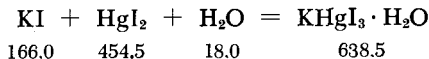
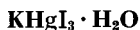
Potassium Triiodomercurate (II)

First, 41 g. of KI and 59 g. of HgI_2 are dissolved in 14 (!) ml. of hot H_2O . The beaker should be tared precisely so that evaporating H_2O may be replenished. The salt crystallizes in yellow needles from the cooling solution. The above instructions result from a study of the three-component system HgI_2 -KI- H_2O showing that in this system only $\text{KHgI}_3 \cdot \text{H}_2\text{O}$ can precipitate. Yield 9 g.

The salt K_2HgI_4 (without water of crystallization) is obtained from acetone containing exactly 2% H_2O (between 34 and 56°C).

Use: A solution treated with KI is known as Thoulet's solution (see Part I, p. 99); it is also a reagent for alkaloids. Alkaline K_2HgI_4 solution is Nessler's reagent.

SYNONYMS:

Mercury potassium iodide, potassium mercuriiodide, potassium iodohydrargyrate.

PROPERTIES:

Light yellow crystal needles; becomes orange-red in a vacuum desiccator over H_2SO_4 (reversible loss of H_2O). Decomposes in H_2O with loss of HgI_2 . Soluble in KI solution. Sublimes off HgI_2 on heating.

REFERENCES:

M. Pernot. *Comptes Rendus Hebd. Séances Acad. Sci.* **182**, 1154 (1926); **185**, 950 (1927); *Ann. Chim.* [10] **15**, 5 (1931).

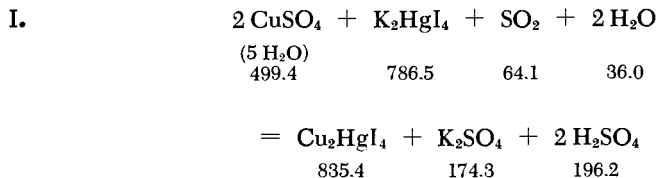
Copper (II) Tetraiodomercurate (II)

A solution of 4.5 g. of HgI_2 and 3.3 g. of KI in 25 ml. of H_2O is filtered and treated with a solution of 5 g. of $\text{CuSO}_4 \cdot 5 \text{H}_2\text{O}$ in 15 ml. of H_2O ; SO_2 is then introduced. The resultant bright-red

precipitate is suction-filtered, washed with H₂O, and dried at 100°C. The compound may be recrystallized from hot hydrochloric acid.

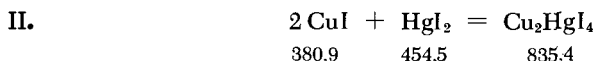

The components are mixed in stoichiometric proportions and fused over an open flame in an evacuated Pyrex glass bomb, which should be as small as possible. Pure Cu₂HgI₄ is obtained.

An analogous procedure yields Ag₂HgI₄.

PROPERTIES:

Red crystalline powder or small, tabular crystals. *d* 6.094. Crystal structure: tetragonal. Space group D_{2d}¹¹; on heating to 70°C, the color changes to chocolate brown with simultaneous enantiotropic structure transformation to cubic type B3 (zincblende) in which the cation distribution is random.

REFERENCES:

- I. Cabentou and Willm. Bull. Soc. Chem. France [2] 13, 194 (1870); J. A. A. Ketelaar. Z. Kristallogr. 80, 190 (1931).
- II. H. Hahn, G. Frank and W. Klingler. Z. anorg. allg. Chem. 279, 271 (1955).

Mercury (II) Sulfide

HgS

BLACK MODIFICATION

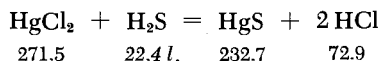

Hydrogen sulfide is introduced into a mercury (II) solution in 1-2N HCl, absolutely free of oxidizing agents. The transient white to brownish precipitate reacts with additional H₂S to yield black HgS, e.g.,

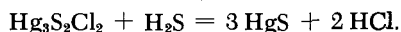

SYNONYMS:

Ethiop's mineral; mercuric sulfide, black.

RED MODIFICATION

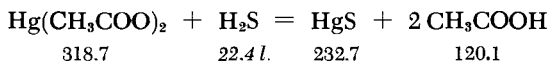

A solution of 35 g. of $\text{Hg}(\text{CH}_3\text{COO})_2$ and 25 g. of NH_4SCN in 100 ml. of hot glacial acetic acid is prepared. A moderately fast stream of H_2S is then introduced until precipitation is complete. The acetic acid is then slowly evaporated (caution, HCN!), and the black precipitate transforms to the red form. The glacial acetic acid must be present until conversion is complete; over-heating must be avoided. During the last stage the paste must be constantly stirred. If this is neglected, the product is dull red or brown. When the acid has been completely removed and the product cooled, 200 ml. of H_2O is added and the mixture is filtered through a Büchner funnel. The product is washed and dried between two layers of thick filter paper. Yield 25 g.

If HgCl_2 is used instead of the acetate, a larger amount of glacial acetic acid is necessary and the boiling must be longer. The final color, however, is never as magnificent as that of the product prepared from the acetate.

Alternate methods: a) A conc. solution of HgCl_2 (20 ml.) is poured into 12 ml. of aqueous ammonia (1:2). The resultant precipitate is treated with a somewhat larger quantity of conc. $\text{Na}_2\text{S}_2\text{O}_3$ solution than is necessary for complete solution. The mixture is heated in a dish and evaporated until pasty; the paste is filtered and washed with hot H_2O .

b) A dry method for the preparation of cinnabar consists in subliming black HgS , grinding the sublimate under H_2O , freeing it from excess sulfur by boiling with a solution of K_2CO_3 , washing and drying at 70°C .

SYNONYMS:

Cinnabar, vermilion, Chinese red, cinnabarite.

PROPERTIES:

Black modification: Velvety black amorphous powder (tetrahedral crystals). Soluble in aqua regia and in conc. solutions of alkali sulfides, forming thio salts. Unstable. d (x-ray) 7.69. The mineral metacinnabarite crystallizes as type B3 (zincblende).

Red modification: Scarlet powder, darkens in air. Soluble in aqua regia, less readily soluble than the unstable modification in alkali sulfide solutions. Sublimes at 580°C ; d 8.09. Hardness 2-2.5. Hexagonal, deformed NaCl lattice, type B9 (cinnabarite type).

REFERENCES:

- L. C. Newell, R. N. Maxson and M. H. Filson in: H. S. Booth. Inorg. Syntheses, Vol. I, New York-London, 1939, p. 19; O. Hausmann. Ber. dtsch. chem. Ges. 7, 1747 (1874).

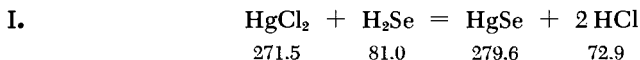
Mercury (II) Selenide**HgSe**

A dilute solution of HgCl_2 is added in drops (stirring) to a saturated aqueous solution of H_2Se , so that HgCl_2 is never present in excess. Air is carefully excluded. If a conc. solution of HgCl_2 is used, the precipitate formed consists of yellow $\text{HgCl}_2 \cdot 2\text{HgSe}$.

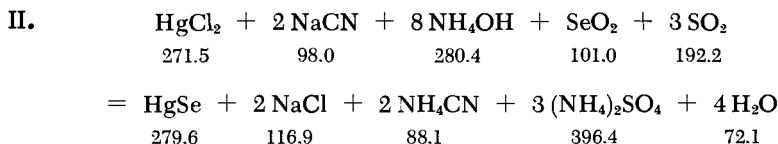

Mercury (II) chloride is added to an equivalent amount of NaCN solution; the mixture is made strongly alkaline with conc. ammonia and an equivalent amount of SeO_2 is added. The mixture is filtered and SO_2 is introduced. The liquid must be maintained alkaline to prevent precipitation of red selenium. The end of the neutralization may be spotted by the reduced rate of absorption of SO_2 . The black HgSe is suction-filtered, washed with a dilute ammoniacal NaCN solution followed by H_2O , and dried in a desiccator over P_2O_5 .



Stoichiometric quantities of Hg and Se are heated to 550–600°C in a sealed bomb.

The product may be purified by sublimation at 600–650°C in a stream of very pure N_2 .

SYNONYM:

Mercuric selenide.

PROPERTIES:

Gray-black (the sublimed material is violet-black) regular crystals with a metallic luster. Sublimes without decomposition

at about 600°C in N₂, CO₂ or vacuum. Soluble in NH₄HSe, giving a red solution. *d* 8.266. Hardness (of tiemannite) 2.5. Crystal structure: type B3 (zincblende type).

REFERENCES:

- I. L. Moser and K. Atynski. *Monatsh. Chem.* 45, 235 (1925).
- II. H. Hahn and G. Störger. Unpublished data.
- III. G. Pellini and R. Sacerdoti. *Gazz. Chim. Ital.* 40, II, 42 (1910); *Chem. Zentralbl.* 1910, II, 1741.

Mercury (II) Amide Chloride

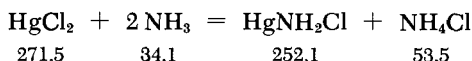

A solution of 20 g. of HgCl₂ in 400 ml. of H₂O is mixed with 31 ml. of 6N (10%) ammonia. The resultant precipitate is allowed to settle and is then suction-filtered and washed with 180 ml. of cold water. This amount of wash water must be adhered to precisely, since it affects the composition of the product: with larger quantities of H₂O the product assumes a yellow color due to partial formation of NHHg₂Cl · H₂O. The product is dried at 30°C (exclusion of light); when it appears to be dry, it is ground and dried further at 30°C. Yield 18.5 g.

SYNONYMS:

White mercuric precipitate (infusible); ammoniated mercuric chloride.

PROPERTIES:

White, light-sensitive powder. Insoluble in H₂O; decomposes in H₂O and alcohol. Completely soluble in CH₃COOH. Does not melt on heating, but volatilizes with decomposition. *d* 5.38.

REFERENCES:

- E. Mannerheim. *Pharmazeutische Chemie* [Pharmaceutical Chemistry], IV, Exercise Compounds, Collection, 682, p. 63 (1921); *J. Sen. Z. anorg. allg. Chem.* 33, 197 (1903).

Diamminomercury (II) Dichloride

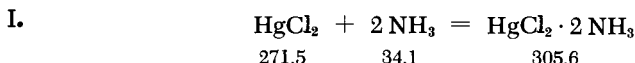
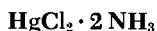

A solution of 5 g. of HgCl₂ and 3 g. of NH₄Cl in 100 ml. of H₂O is allowed to react with 20 ml. of 4.5N (8%) ammonia. The

mixture is left to stand six days (frequent shaking). The resultant precipitate consists of small, colorless crystals. It is washed with alcohol and dried in the dark over KOH.

II. In the absence of moisture, the product of theoretical composition is formed in 1.5 days via addition of NH_3 to HgCl_2 at room temperature in a vapor pressure eudiometer (cf. Part I, p. 102). The other known ammines are $\text{HgCl}_2 \cdot 8\text{NH}_3$ and $\text{HgCl}_2 \cdot 9.5\text{NH}_3$.

SYNONYM:

White mercuric precipitate (fusible).

PROPERTIES:

Fine rhombic dodecahedra comprise the crystalline, air-stable, white powder. Melting range 247 to 253°C under NH_3 at atmospheric pressure. Soluble in CH_3COOH . Stable as a precipitate in a solution containing more than 1.7 g. of $\text{NH}_2\text{Cl}/100$ ml. of H_2O . Melts with decomposition on heating. *d* 3.77. Crystal structure: cubic with random distribution of Hg.

REFERENCES:

- I. D. Strömholm. *Z. anorg. allg. Chem.* **57**, 86 (1908).
- II. W. Biltz and C. Mau. *Ibid.* **148**, 170 (1925).

Mercury (II) Iminobromide

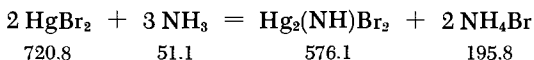

I. A solution of 2.16 g. of HgBr_2 in 80 ml. of boiling water is mixed with a solution of 0.2 g. of NH_4Br in 100 ml. of 0.1N ammonia. A yellow precipitate forms immediately; it is suction-filtered while still hot, washed with 250 ml. of cold water, and dried over NaOH. Yield 1.4 g. (81%).

II. A concentrated solution of 1.44 g. of HgBr_2 and 0.9 g. of NH_4Br (total volume about 30 ml.) is added to 2.6 g. of freshly precipitated HgO. The mixture is shaken for about six hours; it clarifies after 2.5 hours. The precipitate is worked up as in method I.

SYNONYM:

Mercuric iminobromide.

PROPERTIES:

Yellow, light-sensitive powder. Soluble in KCN and KI solutions, insoluble in organic solvents. Shaking with cold, aqueous ammonia yields the bromide of Millon's base (see below).

REFERENCES:

- I. W. Rüdorff and K. Brodersen. *Z. anorg. allg. Chem.* **270**, 145 (1952).
- II. A. Meuwesen and G. Weiss. *Ibid.* **289**, 5 (1957).

Millon's Base

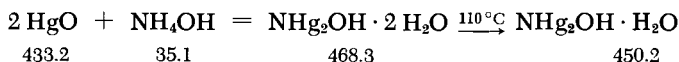
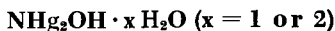

Freshly precipitated HgO (see below) is taken up in carbonate-free, approximately 12N ammonia, and shaken in the dark for 14 days. The resultant light-yellow microcrystalline precipitate is filtered and washed with some water. It is dried over silica gel in a desiccator.

This dihydrate of Millon's base may be converted to the brown monohydrate by brief drying (10 minutes at 110°C). This compound is stable in vacuum over silica gel.

The starting HgO is precipitated at 70°C by addition of a solution of 7.5 g. of NaOH in 20 ml. of H₂O to a solution containing 25 g. of HgCl₂ in 200 ml. of H₂O.

The starting ammonia solution is prepared by passing 51 g. of CO₂-free NH₃ through 250 ml. of boiled distilled water.

PROPERTIES:

a) Dihydrate: Very fine, yellow, hexagonal crystals, light-sensitive, insoluble in alcohol and ether. Converted to the monohydrate above 110°C. *d* (x-ray) 7.33. Crystal structure: hexagonal.

b) Monohydrate: Brown, light-sensitive powder. In moist air, the color changes to yellow, with formation of the dihydrate. *d* (x-ray) 7.05. Crystal structure: hexagonal.

REFERENCE:

- W. Rüdorff and K. Brodersen. *Z. anorg. allg. Chem.* **274**, 338 (1953).

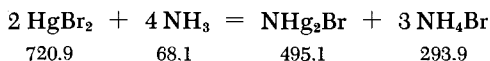
Bromide of Millon's Base

Ammonia (5 ml., 24%) is diluted with 400 ml. of water. A solution of HgBr_2 in 200 ml. of water, saturated at 20°C , is added with stirring. The resultant yellow precipitate is filtered and washed with water until the filtrate is free of bromide ion. The light yellow product is dried at 110°C and stored in vacuum over silica gel.

The iodide and the nitrate of Millon's base are also readily prepared (see reference below).

PROPERTIES:

Light yellow, finely grained powder. d (pyn.) 7.64, d (x-ray) 7.66. Crystal structure: hexagonal (space group D_{5h}^4).

REFERENCE:

W. Rüdorff and K. Brodersen. Z. anorg. allg. Chem. 274, 338 (1953).

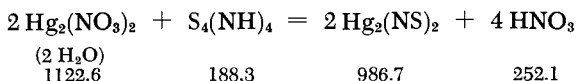
Mercury (II) Thionitrosylate

A solution of 2.3 g. of $\text{Hg}_2(\text{NO}_3)_2$ (carefully predried over P_2O_5) in about 60 ml. of dimethylformamide is prepared. Any basic nitrate which may precipitate is filtered off. The solution is cooled in a -70°C bath and 400 mg. of $\text{S}_4(\text{NH})_4$, dissolved in a few milliliters of dimethylformamide, is added. The resultant yellow solution is slowly brought to room temperature. A yellow precipitate begins to separate at about 0°C . The mixture is allowed to stand 10 minutes and is filtered on a coarse fritted glass filter. The precipitate is washed with dimethylformamide, followed by acetone. The product is dried in high vacuum, first at room temperature, then for a short time at 100°C . Yield 1-1.5 g.

SYNONYM:

Mercurous thionitrosylate.

PROPERTIES:

Solid yellow substance. Insoluble in all common solvents. Stable at room temperature; detonates when held in a flame. Hydrolyzed by bases, evolving NH_3 ; reacts with strong acids, forming basic Hg salts, SO_2 and ammonium salts.

REFERENCE:

M. Goehring and G. Zirker. *Z. anorg. allg. Chem.* **285**, 70 (1956).

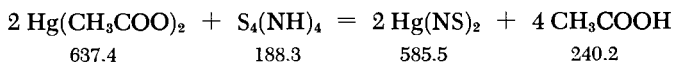
Mercury (II) Thionitrosylate

A solution of 27 g. of $\text{Hg}(\text{CH}_3\text{COO})_2$ in absolutely dry pyridine is prepared. Then 1 g. of $\text{S}_4(\text{NH})_4$ in 20 ml. of pyridine is added, resulting in the appearance of a blood-red color, followed soon by separation of a fine-grained yellow precipitate. The mixture is mechanically shaken until the supernatant becomes pure yellow: this requires about two hours. During this operation, the temperature should be maintained at 20-25°C; the reaction is inhibited at lower temperatures. After the shaking, the deposit is washed several times with pyridine (total 80 ml.) and the solvent is decanted. The remaining pyridine is removed by ether extraction. The product is vacuum-dried over conc. H_2SO_4 . Yield 2 g. (65%).

PROPERTIES:

Finely divided yellow powder. Insoluble in all common solvents. In water, decomposes with blackening. Stable at room temperature, decomposes at about 140°C.

SYNONYM:

Mercuric thionitrosylate.

REFERENCE:

A. Meuwesen and M. Lösch. *Z. anorg. allg. Chem.* **271**, 217 (1953).

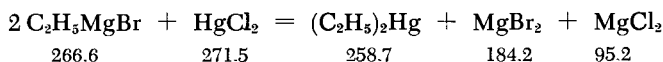
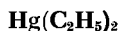
Diethylmercury

Magnesium turnings (25 g.) are covered with 500 ml. of dry ether in a two-liter three-neck flask provided with a dropping

funnel and reflux condenser. Ethyl bromide (125 g.) is gradually added in drops from a funnel. The rate of the reaction, which starts after a few minutes, is regulated by the rate of addition. It may be slowed by cooling with water. When the reaction ceases, the solution is boiled for about 30 minutes, cooled and filtered through glass wool.

The ethereal C_2H_5MgBr solution is treated portionwise (stirring) with 97 g. of $HgCl_2$ in a second three-neck two-liter flask, equipped with a stirrer and a reflux condenser. The addition is spread out over 45 minutes to avoid a too violent reaction. The solution is then boiled for about 10 hours, after which 250 ml. of water is slowly added through the condenser to hydrolyze the excess C_2H_5MgBr . The ether layer is separated and dried over $CaCl_2$. After removal of the ether by distillation, the residue is distilled under reduced pressure. The $Hg(C_2H_5)_2$ goes over between 97 and 99°C at 100 mm. Yield 55 g. (~60%).

Dimethylmercury may be obtained in a similar manner according to

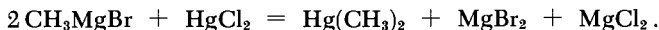

Storage ampoules are first filled with N_2 or CO_2 to avoid explosions during melt-sealing. To avoid the unpleasant results of shattering of the ampoules on explosion (flying glass, etc.), the ampoules should be stored in cotton wool inside well-stoppered powder jars.

PROPERTIES:

Almost odorless, heavy liquid. B.p. (760 mm.) 159°C. Stable to H_2O and air. Gradually decomposes when stored in light (Hg drops appear). Almost insoluble in H_2O , sparingly soluble in alcohol, soluble in ether. d (20°C) 2.466. Very toxic.

The danger of poisoning is especially great when the compound is spilled on a porous surface, such as a laboratory bench or wooden floor. The material is inactivated by hot hydrochloric acid or hot mercuric chloride solution (formation of C_2H_5HgCl).

REFERENCES:

- C. S. Marvel and V. L. Gould. *J. Amer. Chem. Soc.* 44, 153 (1922);
E. Krause and A. von Grosse. *Chemie der metallorgan. Verbindungen* [Chemistry of Organometallic Compounds], Berlin, 1937.

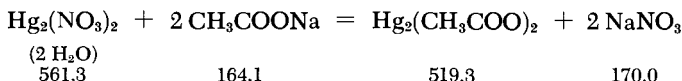
Mercury (I) Acetate

A solution of 20 g. of $\text{Hg}_2(\text{NO}_3)_2$ in 120 ml. of water plus 3.5 ml. of 25% HNO_3 is treated with a solution of 15 g. of sodium acetate in 50 ml. of H_2O . The resultant precipitate is washed with cold water and dried in a desiccator over CaCl_2 . Yield 13 g.

SYNONYM:

Mercurous acetate.

PROPERTIES:

White, light-sensitive crystal flakes (tinged with gray). Solubility (15°C) 0.75 g./100 ml. H_2O . On boiling and in light the compound in solution disproportionates to Hg and Hg (II) acetate; the mercuric salt then hydrolyzes to a yellow, insoluble basic salt. Readily soluble in dilute acetic acid, insoluble in alcohol and ether. Decomposes on heating, forming a residue of black flakes.

REFERENCE:

Ullmann. Enzyklopädie d. techn. Chemie [Encyclopedia of Ind. Chemistry], 2nd ed., IV, 679.

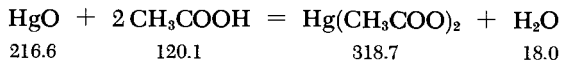
Mercury (II) Acetate

A solution of 20 g. of yellow HgO in 30 ml. of 50% CH_3COOH is prepared on a water bath. It is filtered through a jacketed filter heated with hot water, and the filtrate is cooled with ice. The crystals are suction-dried and washed with ethyl acetate. The product is recrystallized from hot ethyl acetate or from hot water slightly acidified with acetic acid. The salt is dried in a vacuum desiccator over CaCl_2 .

Use: As a mercurizing and oxidizing agent and for the absorption of ethylene.

SYNONYM:

Mercuric acetate.

PROPERTIES:

Nacreous, light-sensitive crystalline flakes. On storage acquires a yellow tinge and an odor of CH_3COOH (formation of a basic salt). M.p. $178\text{--}180^\circ\text{C}$, decomposes at higher temperatures. Solubility (0°C) 25 g., (19°C) 36.4 g./100 ml. H_2O (and about 100 g. at 100°C with partial dec.). The compound in 0.2N aqueous solution is approximately 30% hydrolyzed; the yellow basic salt precipitates on diluting or heating; Soluble in ethyl acetate. $d^{23} 3.286$.

REFERENCE:

Gmelin-Kraut. Hdb. anorg. Chem. [Handbook of Inorg. Chem.], 7th ed., V2, 826, Heidelberg, 1914, modified.

Mercury (II) Cyanide

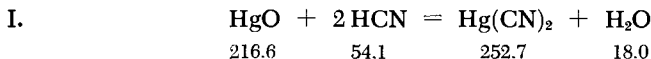
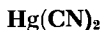

The crystalline material is obtained by evaporation of a solution of HgO in aqueous HCN . The product is recrystallized, dried at 50°C , ground and redried.

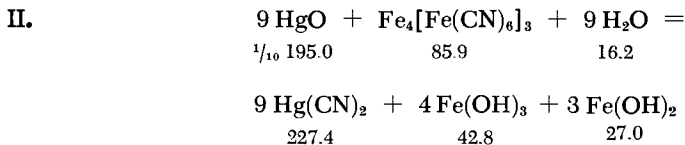

One part of HgO is digested for a few hours on a water bath with one part of Prussian blue and 10 parts of H_2O . The crystals separate on evaporation of the solution.

SYNONYM:

Mercuric cyanide.

PROPERTIES:

Colorless, prismatic, tetragonal crystals. Decomposes into Hg and $(\text{CN})_2$ at 320°C . Solubility (0°C) 8 g., (100°C) 53.9 g./100 ml.

H₂O; (19.5°C) 10.1 g./100 g. ethanol; (19.5°C) 44.1 g./100 g. methanol. *d* 3.996. Crystal structure: type F1₁ [Hg(CN)₂ type].

REFERENCES:

- I. W. Biltz. *Z. anorg. allg. Chem.* 170, 161 (1928).
- II. Gmelin-Kraut. *Hdb. anorg. Chem.* [Handbook of Inorg. Chem.], 7th ed. V2, 832, Heidelberg, 1914.

Potassium Tetracyanomercurate (II)

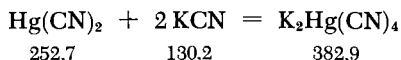
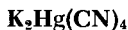

I. A solution of stoichiometric quantities of Hg(CN)₂ and KCN is evaporated to induce crystallization. The product is recrystallized and dried at 80°C.

II. Treatment of a suspension of Hg(CN)₂ in liquid HCN with the stoichiometric quantity of KCN produces K₂Hg(CN)₄, in addition to K₂Hg(CN)₄.

SYNONYM:

Potassium mercuricyanide.

PROPERTIES:

Colorless, octahedral crystals. Solubility (20°C) 1 g./35 g. of 88% v./v. alcohol. *d* 2.420. Crystal structure: type H1₁ (spinel type).

REFERENCES:

- I. W. Biltz. *Z. anorg. allg. Chem.* 170, 161 (1928).
- II. G. Jander and B. Grüttner. *Ber. dtsch. chem. Ges.* 81, 118 (1948).

Mercury (I) Thiocyanate

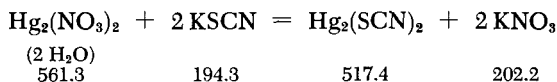

A slightly acid solution of Hg₂(NO₃)₂, freed of mercuric ions by means of metallic Hg, is treated with somewhat less than the

stoichiometric amount (~75%) of KSCN solution. A dark-gray salt precipitates at first; after standing for several days (repeated stirring), it becomes completely white. It is washed several times with boiling H₂O.

SYNONYMS:

Mercurous thiocyanate; mercury (I) rhodanide.

PROPERTIES:

Colorless, light-sensitive powder. Insoluble in H₂O, soluble in KSCN solution, precipitating Hg. Decomposes on heating, forming a foamy mass. d 5.318.

REFERENCE:

K. Huttner and S. Knappe. Z. anorg. allg. Chem. 190, 27 (1930).

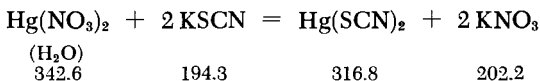
Mercury (II) Thiocyanate

A Hg(NO₃)₂ solution, acidified with a few drops of HNO₃, is treated with the stoichiometric amount of KSCN solution. The resultant crystalline precipitate is suction-filtered and washed with H₂O. The product may be recrystallized from hot H₂O or alcohol. Yield 80%.

SYNONYMS:

Mercuric thiocyanate, mercuric sulfocyanate.

PROPERTIES:

Colorless, fibrous needles or nacreous flakes. Solubility (25°C) 0.069 g./100 ml. H₂O. The solubility in alcohol and boiling H₂O and in KSCN solution is higher, in ether lower. Decomposes with swelling on heating to 165°C.

REFERENCE:

W. Peters. Z. anorg. allg. Chem. 77, 157 (1912).

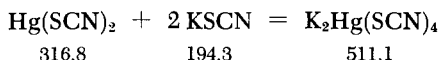
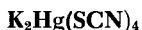
Potassium Tetrathiocyanomercurate (II)

A boiling solution of 20 g. of KSCN in 100 ml. of H₂O is mixed with 31.7 g. of Hg(SCN)₂. The HgS precipitating on cooling is filtered off. The filtrate is concentrated on a water bath until crystallization. The solution then solidifies on further cooling to a white, fibrous crystalline mass. It is suction-filtered and dried over P₂O₅.

SYNONYM:

Potassium mercurithiocyanate.

PROPERTIES:

Brilliant white crystal needles. Readily soluble in cold water, soluble in alcohol, insoluble in absolute ether.

REFERENCE:

A. Rosenheim and R. Cohn. Z. anorg. allg. Chem. 27, 285 (1901).

*Scandium, Yttrium, Rare Earths**

K. WETZEL

Pure Scandium Compounds

Scandium may be freed of accompanying elements by extraction of its thiocyanate with ether.

A) PURIFICATION OF SMALL QUANTITIES

One gram of the oxide (which should contain as little Ti, Zr and Hf as possible) is dissolved in dilute hydrochloric acid. The solution is evaporated on a water bath until a moist crystal paste is obtained (see note, p. 1126). This is taken up in 60 ml. of 0.5N HCl. Then 53 g. of NH_4SCN is added (the final volume should be about 100 ml.) and the mixture is shaken with 100 ml. of ether. If a separatory funnel is used, complete phase separation is often difficult to achieve since the stopcock may become plugged with solid decomposition products of HSCN during the removal of the bottom phase. It is therefore advisable to use a flask such as that in Fig. 284, which has a ground glass stopper at the top, and to use a vacuum in order to transfer the top (or ether) phase into flask *c* via tube *b*. Dilute HCl (5-10 ml.) is added to the separated top phase, the ether is evaporated, and the dry residue is treated on a water bath with conc. nitric acid, added in drops (caution! violent reaction). The mixture is then boiled with some additional conc. nitric acid until the orange red HSCN decomposition products disappear. The solution

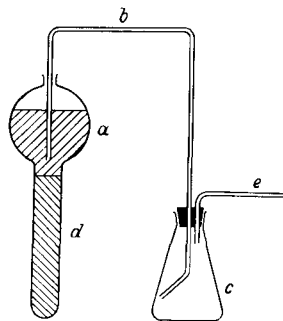

Fig. 284. Ether extraction of scandium thiocyanate. *a* ether solution, *b* siphon, *c* storage flask, *d* aqueous solution, *e* vacuum connection.

*In the following text, the rare earths are designated by the general symbol Ln.

is diluted with water and pure scandium is precipitated with dilute ammonia.

This procedure almost completely removes Mg, Ca, Y, the lanthanides, Th and Mn; it also frees the scandium, to a large extent, of Ti, Zr, Hf, U and Fe. However, the product is still contaminated with varying amounts of Be, Al, In, Mo, Re, Fe and Co.

NOTE:

Very impure raw material samples often yield a noncrystallizing sirup on evaporation of the HCl solution; this sirup should not be heated too long because there is a danger of extensive hydrolysis. A small excess of HCl does not interfere at this stage.

B) PURIFICATION OF LARGE QUANTITIES

The crude oxide (60 g.) is dissolved in hydrochloric acid and evaporated carefully on a water bath until a moist crystalline mass is formed.

(If the mass should become sirupy instead of crystalline, the evaporation is discontinued and the mixture is diluted in 400-500 ml. of water. Then dilute ammonia is carefully added until the yellow end-point of tropeolin 00, 30 ml. of 2N HCl is added, and the volume is made up to 600 ml. with water. The purification procedure is then continued as described below.)

The paste is dissolved in 600 ml. of 0.1N HCl. If Ti or considerable quantities of Zr and Hf are initially present, hydrolysis products of these elements may still remain; they are filtered off before the next step. The solution is then allowed to react with 500-550 g. of NH_4SCN and shaken with one liter of ether in a three-liter flask (not a separatory funnel). Just as in method (A), as much of the ether layer as possible is transferred to a second flask containing 100 ml. of a saturated aqueous solution of NH_4SCN . The acid content of the ether layer, which reaches 0.06N (in HSCN) in the first flask, is largely neutralized by slow addition of 27 ml. of 2N ammonia (the flask is vigorously shaken during this addition). The ether is then shaken in a third and fourth flask each time with 100 ml. of 45% NH_4SCN solution. The Sc is obtained from this purified ether phase by extraction, in a separatory funnel, with pure water (portions of 250-500 ml.). The extraction is continued until the aqueous layer ceases to yield a precipitate on addition of dilute ammonia (any iron in the starting material will concentration in the first 250-500 ml. of aqueous extract). About 2-3 liters of water is necessary to extract 40-50 g. of Sc_2O_3 from one liter of ether. The aqueous phase remaining in the first flask is now acidified with 30 ml. of 2N HCl and the operation with one liter of ether is repeated (reuse the aqueous solutions in flasks 2 to 4.) A second repetition of the extraction procedure yields the last traces of Sc.

Such a purification of an oxide initially containing 75-80% Sc_2O_3 , 8-9% ZrO_2 , 0.8-0.9% HfO_2 , 1-2% Y_2O_3 , 0.5% Dy_2O_3 , 1% Er_2O_3 , 0.5% Tm_2O_3 , 6-8% Yb_2O_3 , and 1% Lu_2O_3 gave a 90% yield of Sc_2O_3 . Spectroscopic analysis (x-ray) revealed no other rare earth impurities nor Zr and Hf in this product (limit of detection: 0.1%); the remaining 10% of the scandium oxide present in the raw material was also obtained in greatly concentrated form. After conversion to the oxide, the residue left in the first flask contained less than 0.5% Sc_2O_3 .

Alternate methods: a) Fractional condensation of the chlorides.

b) Fractional sublimation of the acetylacetonates.

c) According to Vickery, pure Sc compounds may be obtained by ion exchange.

REFERENCES:

- W. Fischer and R. Brock. *Z. anorg. allg. Chem.* **249**, 168 (1942); this paper also reexamines several other procedures for extraction of scandium; R. C. Vickery. *J. Chem. Soc. (London)* **1955**, 245.

Treatment of Monazite Sand

Monazite is the orthophosphate of the cerium group of rare earths; it contains oxides of the cerium group (50-70%), oxides of the Y group (1-4%) ThO_2 (1-20%), varying quantities of ThSiO_4 , and small amounts of SiO_2 , Fe_2O_3 and Al_2O_3 .

A) EXTRACTION WITH SULFURIC ACID

The monazite sand is ground in a ball mill (final product approx. U.S. 30 mesh). Conc. H_2SO_4 (3.25 kg.) is heated to 200°C in a six-liter porcelain dish, and 3.5 kg. of ground sand is gradually added in small portions (efficient stirring is necessary). Heating and stirring are continued for 30 minutes after completion of the addition, until a dark gray, quite firm paste is obtained.

The paste is slowly poured (stirring) into 25 liters of cold water, and stirring is continued for one hour. If the solution is still warm after this time, ice is added until the temperature drops below 25°C, since the rare earth sulfates are more soluble in cold than hot water. The residue is allowed to settle, the clear supernatant is decanted, and the solid is suction-filtered and washed several times with cold water. The residue consists of SiO_2 , TiO_2 , ZrO_2 and unreacted monazite. The residues of several extractions may be combined and subjected to a second H_2SO_4 treatment.

B) PRECIPITATION OF Th IN THE FORM OF ThP_2O_7

The filtrate, which contains H_2SO_4 , H_3PO_4 , Th and the rare earths, is diluted to 168 liters and stirred for one hour in an earthenware or wooden vessel. The nascent, slightly blue-gray, heavy, gelatinous precipitate is allowed to settle for 8-12 hours. It consists of ThP_2O_7 contaminated with phosphates of cerium and of other rare earths. The precipitation is complete when no additional solid separates on further dilution. The ThP_2O_7 is filtered off and washed with water.

C) PRECIPITATION OF THE RARE EARTHS IN THE FORM OF $\text{Na}_2\text{SO}_4 \cdot \text{Ln}_2(\text{SO}_4)_3 \cdot 2\text{H}_2\text{O}$ OR $\text{Ln}_2(\text{C}_2\text{O}_4)_3 \cdot 5\text{H}_2\text{O}$

The rare earths are isolated from the filtrate by agitation in the presence of finely ground Na_2SO_4 until the absorption bands of Nd are no longer observable through a 5-cm. layer of the clear supernatant. The precipitate is filtered off, washed and dried at 110°C [if the starting material contains large amounts of yttria earths (i.e., xenotime, YPO_4) it is best to precipitate with solid oxalic acid, since the double sodium yttria sulfates have appreciable solubilities in water].

A first crude separation of the ceria earths from the yttria earths is achieved by adding solid oxalic acid to the filtrate from the double sulfate precipitation. Use of a saturated solution of oxalic acid yields a precipitate which is difficult to filter and necessitates further dilution of the solution.

D) CONVERSION OF THE SULFATES OR OXALATES TO THE OXIDES

The double sulfates or oxalates are mixed with water and stirred to a thick paste, which is allowed to react with slightly more than the stoichiometric quantity of solid NaOH, which is added in small portions with constant stirring at high heat. As the reaction proceeds, the paste becomes increasingly liquid and stirring is easier. The reaction is brought to completion by further heating and stirring for one hour. The hydroxides are transferred to a 30- to 40-liter earthenware container and stirred with 20-30 liters of water. The precipitate is allowed to settle, the supernatant is siphoned off, and the washing is repeated until the liquid gives only a weak alkaline reaction. The hydroxides are dissolved in conc. nitric acid (add 3% H_2O_2 if large amounts of Ce are present). This nitrate solution serves as starting material for further workup.

Further separation of the resultant mixture of rare earths and isolation of individual components are described in later procedures in this section; in particular, see the preparation of pure La, Pr

and Nd compounds from ceria earths by ionexchange and the preparation of pure Ce, Sm, Eu and Yb compounds.

REFERENCES:

- D. W. Pearce, R. A. Hanson, J. C. Butler, W. C. Johnson and W. O. Haas in: W. C. Fernelius, *Inorg. Syntheses*, Vol. II, New York-London, 1946, p. 38; S. J. Levy. *The Rare Earths*, London, 1924, pp. 18, 71, 79.

Treatment of Gadolinite

Gadolinite is an yttria earth-beryllium-iron (II) silicate; its approximate composition is $Y_2Be_2FeSi_2O_{10}$, and it contains up to 50% rare earth oxides and about 10% BeO.

A) EXTRACTION, SEPARATION OF SILICIC ACID

The gadolinite is pulverized in a ball mill to a size passing through a U.S. 140-mesh sieve. Two kilograms of this material are mixed with seven liters of conc. HCl and evaporated (stirring) in a shallow porcelain dish placed on a sand bath; the evaporation is continued until a stiff paste is obtained (1.5 days required). The residue while still hot is taken up in 2-3 liters of hot water, suction-filtered and pressed dry.

To complete the extraction, the residue is again treated as above with 0.5 liter of conc. hydrochloric acid, taken up in one liter of water, suction-filtered, and washed with 0.5 liter of hot, dilute hydrochloric acid. The residue (SiO_2 and impurities not attached by hydrochloric acid) is discarded; it contains only about 0.5% of the rare earths present in the starting material.

B) PRECIPITATION WITH OXALIC ACID

The combined filtrates from (A) are diluted with water to twice their volume and heated to 60°C; a thin stream of a hot solution of 1400-1500 g. of oxalic acid dihydrate in two liters of water is then added with stirring. The mixture is kept warm overnight in a covered container; the precipitate is suction-filtered while still warm and washed with warm water. This yields about 95% of the rare earths initially present. Large quantities of rare earth oxalates are best converted to other compounds by calcining in a stream of air at 600-700°C. The material is spread in a thin layer in a large crucible furnace and heated until the transient gray color disappears again. The oxides can then be readily dissolved in acids. They contain no more than about 0.1% Fe_2O_3 and 0.15% SiO_2 .

C) PRECIPITATION WITH NH_3

The iron concentrates in the filtrate of the oxalate precipitation so that it constitutes more than 50% of the total metals present. To separate the Be and the rare earths, the latter are precipitated with NH_3 as the hydroxides (after transient reduction of the iron to the divalent state). The filtrate of operation (B) (two liters) is diluted with six liters of water in a 10-liter flask. The flask is provided with a dropping funnel, as well as gas inlet and outlet tubes; the gas inlet tube reaches to the bottom of the flask and the outlet terminates at the neck. The solution is heated to 60°C and the necessary amount of KMnO_4 [determined by testing a very dilute sample of the solution with Mn (II)] is added with efficient mixing to oxidize the oxalic acid. The highest possible concentration of KMnO_4 should be used. Then 500-700 g. of solid NH_4Cl is added and the mixture is brought to a boil while SO_2 is passed through. The solution is maintained at the boiling point for an additional 30 minutes, a slow stream of SO_2 being bubbled through all the time. The flame is then removed, the SO_2 is replaced by a stream of H_2 , and conc. carbonate-free ammonia is added until no further precipitation occurs. The precipitate should be pure white. A brownish color indicates incomplete reduction of the Fe; a greenish tinge [impure $\text{Fe}(\text{OH})_2$] indicates that the amount of NH_4Cl added was insufficient. In either case, the addition of ammonia is discontinued, the precipitate already formed is redissolved in hydrochloric acid, and the procedural fault is corrected. If the precipitate assumes a greenish color only toward the end of the operation, this is an indication that $\text{Fe}(\text{OH})_2$ has begun to deposit because an excess of NH_3 is present in solution.

After completion of the precipitation the mixture is allowed to cool to 45°C , and a freshly prepared solution of 70 g. of $\text{Na}_2\text{S}_2\text{O}_4$ in 500 ml. of water and 20 ml. of dilute ammonia is added with efficient mixing. The passage of H_2 is discontinued and the precipitate is suction-filtered and washed with a warm (maximum 45°C) solution of 10 g. of $\text{Na}_2\text{S}_2\text{O}_4$ and 20 g. of NH_4Cl in one liter of water, followed by one liter of pure water. The filtrate and wash water are discarded. The rare earths which have remained in solution after the oxalate precipitation, as well as the Be, are thus quantitatively precipitated. A solution in which the weight ratio $\text{BeO}:\text{Ln}_2\text{O}_3:\text{Fe}_2\text{O}_3 = 1:0.2:1.6$ yields a precipitate in which this ratio is 1:0.2:0.05-0.03.

D) SEPARATION AND RECOVERY OF THE Be

The moist hydroxide precipitate is dissolved in the minimum amount of warm glacial acetic acid and evaporated to complete dryness on a sand bath. Basic beryllium acetate $\text{Be}_4\text{O}(\text{CH}_3\text{COO})_8$

is distilled from the residue at atmospheric pressure (m.p. 284°C; b.p. 330°C; cf. the procedure for the preparation of basic beryllium acetate, p. 901). The residue from this Be separation may be purified by another gadolinite extraction.

REFERENCE:

W., Fischer. *Z. anorg. allg. Chem.* 250, 72 (1942).

Pure La, Pr and Nd Compounds from Cerium Earths by Ion Exchange

Rare earth mixtures are efficiently separated by elution of complexes. Among the complexing agents which are usable as eluents, these which act as chelating agents possess significant advantages. A two-column process is usually employed: the first column is charged with the rare earth mixture and the second column with a suitable auxiliary cation. If the chelating agent used is readily soluble in water (for example, ethanolamine diacetic acid) the material in the second (or bottom) column may be in the H form.

The following process is suitable for rapid laboratory-scale separation of cerium earths: the cerium is removed from the mixture by precipitation with KMnO_4 and Na_2CO_3 (see below, preparation of pure Ce compounds). The remaining compounds are adsorbed on 250 ml. of a cation exchange resin (Dowex 50 or Wofatit KPS-200; particle size 0.2-0.4 mm.). The resin is then placed in an ion-exchange column (I.D. 4 cm.) which is partly filled with water. A second column of the same I.D. is filled in the same manner with 350 ml. of the resin in the Zn form.

The eluent flows successively through the two columns; it contains 2% of nitrilotriacetic acid and is buffered with NH_3 to a pH of 7.0. If the eluate flow rate is not less than 0.5 ml. per minute, there is no danger of formation of precipitates inside the columns. The eluate is collected in fractions; the lanthanides appear in the order of increasing ionic radius. The La, which remains in the columns after elution of the heavier earths, may itself be rapidly eluted with a solution containing 4% nitrilotriacetic acid and 2.4% NH_4Cl (pH 9).

The eluate fractions are brought to a boil and the rare earths precipitated with oxalic acid. The mixtures are allowed to stand for 20 minutes at 80°C and filtered hot, and the solids are calcined to the oxides. The first fractions, which may contain minute quantities of Zn, are reprecipitated. More than 70% of the nitrilotriacetic acid used in the process can be recovered from the eluate by precipitation with HCl.

Starting from 63 g. of the mixed oxide (14.7% La_2O_3 , 23.5% Pr_6O_{11} , 54% Nd_2O_3 , 5.4% Sm_2O_3 , 2.4% heavier earths), this method gave 8.3 g. of La_2O_3 (yield 90%, purity > 99.5%), 10.3 g. of Pr_6O_{11} (yield 70%, purity > 99%) and 30 g. of Nd_2O_3 (yield 88.5%, purity > 99%) in 50 hours of elution.

The method is also applicable to the yttrium earths, although in this case it requires more preliminary effort and takes longer.

REFERENCES:

- L. Wolf and J. Massonne. *Chem. Techn.* **10**, 290 (1958); L. Wolf and J. Massonne, *J. prakt. Chem.* (4) 275, 178 (1956); L. Holleck and L. Hartinger. *Angew. Chem.* **66**, 586 (1954); **68**, 411 (1956); F. H. Spedding and J. E. Powell in: F. C. Nachod and J. Schuber, *Ion Exchange Technology*, New York, 1956, p. 365; J. Loriers and J. Quesney. *Comptes Rendus Hebd. Séances Acad. Sci.* 239, 1643 (1954); J. Loriers. *Ibid.* 240, 1537 (1955).

Pure Cerium Compounds

I. PRECIPITATION WITH Na_2CO_3 AND KMnO_4

A nitric acid solution of 250 g. of cerium earths, which should consist only of nitrates, is diluted to one liter and brought to a boil, and the pH is adjusted to 2-3 with aqueous Na_2CO_3 . This already precipitates some of the cerium in the form of Ce (IV) hydroxide. A solution of KMnO_4 is then added until the red color persists, the mixture is reheated to the boiling point, and the cerium is precipitated by adding (with constant stirring) a solution of KMnO_4 and Na_2CO_3 (mole ratio 1:4). The pH gradually reaches 4 and the red color becomes more intense; stirring at the boiling point is then continued for an additional 10 minutes and the precipitate is suction-filtered and washed with hot water. The filtrate contains minute amounts of cerium, in addition to the other rare earths. If it is desired to isolate the last traces of Ce, the pH of the boiling filtrate is adjusted to 5-6 with aqueous Na_2CO_3 . The resultant precipitate consists of carbonates containing all the Ce present.

The cerium is isolated from the residues [which consist of Ce (IV) and Mn (IV) hydroxides] by solution of the residues in conc. hydrochloric acid and precipitation in the form of the oxalate. The precipitate is calcined to CeO_2 (96% yield, 99.5% pure).

II. PRECIPITATION WITH CaCO_3 AND KBrO_3

The following procedure is suitable for a raw material mixture containing 40-50% CeO_2 : a nitric acid solution containing about 4100 g. of the rare earth oxides (total of 12 liters) is divided in

three equal portions. The solutions are heated in procelain dishes and adjusted to pH 2.7 by adding CaCO_3 (mechanical stirring). Then 100 g. of KBrO_3 is added and the solutions are concentrated to one liter (see note below). This procedure is repeated several times to achieve complete oxidation and hydrolysis. If bromine vapor escapes during the evaporation, the pH is readjusted to 2.7 by adding further CaCO_3 . The mixtures are then diluted to five liters, heated almost to the boiling point, and allowed to settle overnight.

The supernatant liquors are decanted, combined and, after addition of 60 g. of KBrO_3 , evaporated to 2-3 liters. The mixture is then diluted to eight liters, brought to a boil, and again decanted.

The combined precipitates are boiled in six liters of water, the supernatant liquor is decanted, and the precipitate is suction-filtered through a Büchner funnel. The mother liquor is combined with the solution containing the other rare earths.

Other cerium compounds, for example, the basic nitrates, may be purified and converted to the oxides by boiling 50 g. of the moist starting material with 200 ml. of 3N Na_2CO_3 solution. The basic carbonate is filtered off and washed with 50 ml. of water. The product is dissolved in 16 N HNO_3 containing 3% H_2O_2 .

This method gives 99.8% pure CeO_2 in 97.6% yield.

NOTE:

The Ce (III) seems to oxidize during the evaporation in the hot conc. solution, while the hydrolysis of the resultant Ce (IV) takes place in the hot dilute solution.

III. ETHER EXTRACTION OF Ce (IV) NITRATE

Very pure CeO_2 may be prepared from the commercial raw material by the following combined procedure: ten parts of crude oxide and seven parts of hydroquinone (reducing agent) are dissolved in boiling conc. hydrochloric acid. The hydroquinone oxidation products are destroyed by oxidative degradation with H_2O_2 in ammoniacal solution, followed by evaporation with conc. nitric acid. Since it is accompanied by foaming, this operation must be carried out in a large vessel. If necessary the cerium may also be freed of organic contaminants by precipitation with oxalic acid, followed by solution of the precipitate in conc. nitric acid.

If the starting material also contains thorium, the oxalate is boiled with a concentrated, neutral to slightly ammoniacal, solution of ammonium oxalate; the precipitate is suction-filtered and thoroughly washed. Repetition of this operation yields a solution of $(\text{NH}_4)_4\text{Th}(\text{C}_2\text{O}_4)_4$ which contains all the thorium initially present.

The nitric acid solution of nitrates, which is obtained in either case, is evaporated to dryness; it is then treated with NH_4NO_3

(same weight as the initial CeO_2) and evaporated several times with conc. HNO_3 until orange-red $(NH_4)_2Ce(NO_3)_6$ begins to precipitate from the deep red solution. The precipitate is filtered off on a fritted glass filter (additional double nitrate may be recovered from the filtrate by further evaporation). The product is recrystallized from conc. nitric acid, dissolved in 6N nitric acid (free of nitric oxide), and extracted with peroxide-free ether (nitric oxides and peroxides reduce Ce^{4+}). The residual material in the aqueous solutions should be reoxidized by evaporation with conc. nitric acid and extracted with ether, since the solutions still contain appreciable quantities of Ce^{3+} .

The combined ether extracts are distilled, water being added during distillation. The cerium nitrate may be reprecipitated with water containing a hydrazine salt, which serves as a reducing agent.

The resultant cerium nitrate solution, which is about 2N in HNO_3 , is filtered and slowly added in drops to a hot, concentrated solution of oxalic acid. The finely crystalline precipitate of cerium oxalate is suction-filtered, washed with a large quantity of water, dried and calcined to the oxide.

The oxide may also be obtained by evaporation of the nitrate solution, followed by thermal decomposition of the cerium nitrate.

Preparation of cerium compounds of especially high purity (for neutron bombardment): Peppard et al. recommend extraction of the Ce (IV) from a 10M HNO_3 solution with a 0.75M or 0.30M solution of bis(2-ethyl)hexyl orthophosphate in n-heptane [D. F. Peppard, G. W. Mason and S. W. Moline, *J. Inorg. Nuclear Chem.* 5, 141 (1957)].

PROPERTIES:

Cerium (IV) oxide is white with a slight yellow tinge; the color is a function of particle size. Even slight contamination with Pr or Tb (0.005%) produces a distinct pink color; higher amounts cause a red-brown color. The calcined material is soluble in acids only in the presence of reducing agents. $d(x\text{-ray})$ 7.172. Crystal structure: type C1 (CaF_2 type).

REFERENCES:

- I. E. J. Roberts. *Z. anorg. allg. Chem.* 71, 305 (1911); J. Mas-sonne. Private communication.
- II. D. W. Pearce, J. C. Butler, W. C. Johnson and W. O. Hass in: W. C. Fernelius, *Inorg. Syntheses*, Vol. II, New York-London, 1946, p. 48; R. Bock. *Angew. Chem.* 62, 375 (1950).
- III. R. J. Meyer and O. Hauser. *Die Analyse der seltenen Erden and Erdsäuren* [Analysis of Rare Earths and Their Acids], Stuttgart, 1912, pp. 75-76; R. Bock. *Angew. Chem.* 62, 375

(1950); R. Bock and E. Bock. *Z. anorg. Chem.* 263, 146 (1950); U. Holtschmidt. Thesis, Freiburg i. Br., 1952; B. D. Blaustein and J. W. Gryder. *J. Amer. Chem. Soc.* 79, 540 (1967).

Pure Samarium Compounds

I. REDUCTION WITH CALCIUM AMALGAM

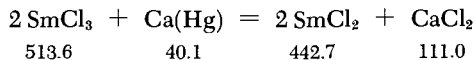

A solution of 180-240 g. of anhydrous rare earth chlorides in 600-700 ml. of absolute ethanol is placed in a thick-wall, rubber-stoppered separatory funnel. After addition of 7-10 g. of Ca in the form of a 1% amalgam (see p. 1804 for preparation), the separatory funnel is stoppered and vigorously shaken. Since this reduction to Sm (II) is accompanied by formation of calcium ethoxide and consequent evolution of H₂, the flask must be frequently vented by opening the stopcock (without, however, allowing air to enter). The initially yellow solution soon becomes dark; after a few minutes the color becomes dark brown-red and precipitation of SmCl₂ begins. The Ca becomes exhausted after 20 minutes. The funnel is inverted so that it rests on the rubber stopper, a Bunsen valve is attached to the outlet tube, and the stopcock is opened. After 10 minutes, the CaO present in the mixture is neutralized by adding (through the funnel stem) 2-3 ml. of HCl-saturated anhydrous ethanol, and the funnel is vigorously shaken. The precipitate should turn bright red. After 30 minutes the Hg is separated and the finely crystalline precipitate of SmCl₂ is centrifuged in the absence of air. The mother liquor is decanted and the precipitate is freed of the adhering solution by shaking with air-free absolute ethanol, followed by centrifugation.

Further purification is achieved by taking up the precipitate in water, in which it is oxidized to Sm (III) and forms the basic chloride. Dilute hydrochloric acid is added and the mixture is heated on a water bath until the mercury left in the SmCl₂ has agglomerated and can be filtered off. The yellow solution is concentrated until crystallization just starts, and then saturated with HCl while cooling in ice. The precipitated hexahydrate is dehydrated and again reduced. The SmCl₂ obtained after this last purification procedure contains only a few percent of Eu.

The Eu may be removed by electrolysis of an alkaline acetate solution of the Sm-Eu mixture in the presence of lithium nitrate; a mercury cathode is used. Onstott, starting from a precipitate containing 1.6% Eu₂O₃, was able to obtain a preparation entirely free of Eu in one electrolysis run.

II. REDUCTION WITH Mg + HCl

Another process suitable for the separation of Sm from rare earth mixtures consists in reducing the samarium, in the form of hydrated chlorides in ethanol or ethanol-dioxane, by means of Mg + HCl. A mixture containing 3% Sm can be concentrated to 55% Sm in a simple run.

REFERENCES:

- I. A. Brukl. *Angew. Chem.* 52, 151 (1939); E. J. Onstott. *J. Amer. Chem. Soc.* 77, 2199 (1955).
- II. A. F. Clifford and H. C. Beachell. *J. Amer. Chem. Soc.* 70, 2730 (1948).

Pure Europium Compounds

I. $\text{EuCl}_2 \cdot 2\text{H}_2\text{O}$

A conc. solution (d 1.35, 100 ml.) of rare earth chlorides containing about 70% Eu (balance Nd, Sm and Gd) is placed together with a few milliliters of conc. hydrochloric acid in a one-liter wide-neck flask. Zinc amalgam granules (100 g., U. S. standard mesh 80) are added, and the flask is stoppered and vigorously shaken by hand. From time to time it is held in front of the slit of a spectrometer to observe the absorption bands. The initially almost colorless solution turns yellowish; after about 30-40 minutes the Eu 5253 Å band disappears, indicating complete reduction to Eu (II). The solution is decanted from the remaining Zn while protected by a CO_2 blanket and poured into a second one-liter flask; the flask is closed with a two-hole stopper carrying a 250-ml. dropping funnel and a gas outlet capillary. Crystallization of $\text{EuCl}_2 \cdot 2\text{H}_2\text{O}$ starts after addition of the first 200 ml. of conc. hydrochloric acid; it reaches a maximum rate after 500 ml. has been added. This procedure precipitates 90% of the Eu present. After 2-3 hours of standing, the well-cooled mixture consists of almost equal volumes of pure white crystals with a faintly blue fluorescence and an essentially colorless mother liquor.

The air-sensitive crystals are filtered under CO_2 through a cotton wool filter and suction-dried as far as possible. If oxidation does occur, the filter cake becomes hot and evolves HCl gas. The Eu may be further purified by redissolving the product chloride under CO_2 . The operation should be repeated five times. Finally the product is filtered through a fritted glass filter (under a CO_2 blanket) and washed with 10% methanolic HCl. The alcohol and the HCl can then be removed by slight heating in a fast CO_2 stream.

Another method for removal of traces of other earths present in crude europium consists in reduction of the europium with Zn amalgam in HCl solution. Then the trivalent earths are precipitated with carbonate-free ammonia. The Eu (II) remains in solution.

II. EuSO_4

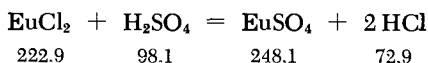
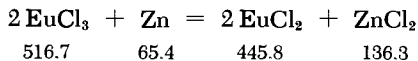

A solution of 3.5 g of Eu_2O_3 in 5.4 ml of 6N HCl is diluted to about 200 ml. A Jones reductor (height 40 cm., diameter 2 cm.) is filled with 1% Zn amalgam granules (0.5-1 mm.), which are then washed with 200 ml. of 0.1N HCl. When the wash liquor just covers the zinc, the outlet of the reductor is dipped in 50 ml. of 8M H_2SO_4 in a 600-ml. beaker covered with a round piece of paper. Carbon dioxide is then introduced into the beaker to expel the air. The EuCl_3 is passed slowly (2 ml./min.) through the reductor, followed by 150 ml. of 0.1N HCl. Very light, white, hairlike crystals of α - EuSO_4 are the first product. This mixture is heated to 80°C in a CO_2 atmosphere, resulting in conversion of the α -form to the stable β -form, which is less soluble in dilute H_2SO_4 and settles as a dense crystalline mass. The mixture is cooled to room temperature, and the white EuSO_4 is filtered and washed with dilute hydrochloric acid, followed by a few milliliters of HCl-acidified methanol. The CO_2 blanket is not necessary during the filtration. The product may be dried in air at 75°C. The yield is 90% of 99.7% EuSO_4 .

PROPERTIES:

White, microcrystalline. Sparingly soluble in water; d (25°C) 4.98. Isomorphous with SrSO_4 and BaSO_4 .

III. EuCO_3

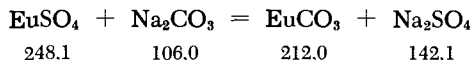

First, 5 g. of EuSO_4 is gradually added to 300 ml. of a vigorously boiling, oxygen-free solution which is 1N in Na_2CO_3 and 0.4N in NaOH (12.6 g. of NaHCO_3 and 10.8 g. of NaOH). After a short time, the solution turns dark; the color disappears on further boiling, and a dense, lemon yellow, crystalline precipitate of EuCO_3 is

formed. This precipitate is filtered and dried in air at 75°C. An almost 100% pure product is obtained in 90% yield.

When larger quantities of EuCO_3 are needed, the first fraction of the sulfate ions liberated in this reaction is removed by decantation and further Na_2CO_3 - NaOH solution is added to the residue.

REFERENCES:

- I. H. N. McCoy. *J. Amer. Chem. Soc.* **57**, 1756 (1935); **59**, 1131 (1937); **63**, 3422 (1941); J. K. Marsh. *J. Chem. Soc. (London)* **1943**, 531; G. Wilkinson and H. G. Hicks. *Phys. Rev.* **75**, 1370 (1949).
- II. R. A. Cooley, D. M. Yost and H. W. Stone in: W. C. Fernelius, *Inorg. Syntheses*, Vol. II, New York-London; 1946, p. 70; H. N. McCoy. *J. Amer. Chem. Soc.* **57**, 1756 (1935).
- III. R. A. Cooley, D. M. Yost and H. W. Stone in: W. C. Fernelius, *Inorg. Syntheses*, Vol. II, New York-London, 1946, p. 71.

Pure Ytterbium Compounds

I. ISOLATION OF YTTERBIUM FROM YTTERBIUM EARTHS IN THE FORM OF YbSO_4

Reduction of $\text{Yb}_2(\text{SO}_4)_3$ on a mercury cathode yields YbSO_4 . The method is particularly suitable for the preparation of pure Yb from ytterbium earth mixtures.

The crude oxide, which must be free of foreign metals [which decrease the overvoltage necessary for the reduction of Yb (III) because they tend to form amalgams], is converted to the sulfate by evaporation with H_2SO_4 . The electrolyte should contain 120 g. of sulfate and 50 g. of conc. H_2SO_4 per liter. The electrolysis is carried out in a thick-wall beaker *b* (Fig. 285) with its bottom covered with a 1-cm. layer of very pure mercury. A nickel bus bar *k* connects the mercury pool to the negative side of the power supply. A carbon rod *a*, partially immersed in a clay cell *c* filled with dilute H_2SO_4 , serves as the anode. A stirrer *r*, which agitates both the mercury surface and the electrolyte, prevents the formation of a dense precipitate on the cathode and thus makes possible the preparation of larger quantities of YbSO_4 . The electrolyte temperature is maintained at 20°C by external cooling with running water.

The electrolysis is carried out at 72 volts and a current density of 0.05 amp./ cm^2 (about 4-4.5 amp. if the beaker is 10 cm. in diameter). At higher current densities the formation of crystals of YbSO_4 is so rapid that they occlude considerable quantities of impurity ions (Tm, Lu, etc.) After a few minutes the

solution turns green. When the cathode becomes covered with a loose layer of YbSO_4 2-3 cm. thick, the current efficiency becomes very low and the electrolysis is stopped. Under the conditions described, the process requires 2-3 hours.

The precipitate is collected on a Büchner funnel and washed with water, and the residual water is rapidly removed by suction. Speed is necessary because the oxidation of YbSO_4 is accompanied by a marked temperature increase, which could cause decomposition of the product YbSO_4 [or $\text{Yb}_2(\text{SO}_4)_3$].

The precipitate is dissolved in dilute nitric acid, neutralized with ammonia, and reprecipitated with oxalic acid. The oxide obtained upon calcination of the oxalate still contains traces of the sulfate.

Additional quantities of YbSO_4 may be recovered from the spent electrolyte by inclusion in the isomorphous SrSO_4 . If this is desired, then the electrolyte should contain only 0.5% H_2SO_4 . The SrSO_4 solution is prepared by very rapid neutralization of 3 g. of SrCO_3 with the stoichiometric quantity of dilute H_2SO_4 . This solution is added one hour after the start of the electrolysis. The added solution contains slowly crystallizing SrSO_4 . The addition is repeated twice at intervals of one hour. After 4-5 hours the precipitate, which contains SrSO_4 and YbSO_4 in a ratio of about 10:1, is filtered off and washed. The YbSO_4 is protected against oxidation to Yb(III) by inclusion in the SrSO_4 lattice. On calcination in air, YbSO_4 is converted to Yb_2O_3 and may be separated from the SrSO_4 by digestion with conc. hydrochloric acid on a water bath. Some additional SrSO_4 may be precipitated from this HCl solution by adding dilute sulfuric acid and allowing the solution to stand 12 hours. After removal of the SrSO_4 , the Yb is precipitated with oxalic acid in the usual manner.

The electrolytic separation of Yb is accompanied by concentration of Tm and Lu in the residual solution.

Europium and samarium may be separated (as EuSO_4 and SmSO_4) from the other rare earth metals by the same method.

PROPERTIES:

Formula weight 269.11. Green Yb^{3+} ions are oxidized by water to Yb^{3+} (evolution of H_2). Solubility in dilute sulfuric acid:

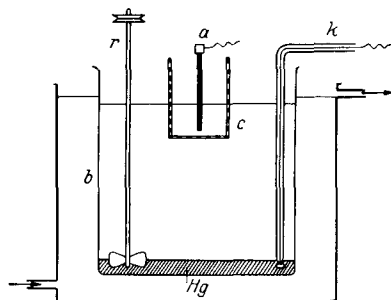
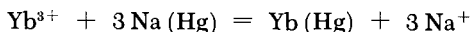

Fig. 285. Electrolytic preparation of ytterbium (II) sulfate. *a* carbon rod, *b* beaker, *c* clay cell.

4 g. YbSO_4 /liter of 1% H_2SO_4 (0.2N); 8 g. YbSO_4 /liter of 5% H_2SO_4 (1N); 20 g. YbSO_4 /liter of 12.5% H_2SO_4 (2.5N). Isomorphous with SrSO_4 .

II. PURIFICATION OF Yb (Sm, Eu) VIA AN AMALGAM PROCESS



The procedure is suited both for efficient purification of a concentrated ytterbium solution (method *a* below) and for isolation of Yb from a mixture of neighboring rare earths, as well as freeing the latter from Yb (method *b*).

a) A product containing about 97% Yb_2O_3 (balance is ytterbium earths), which may be prepared via YbSO_4 by the method described under I, is dissolved in acetic acid on a water bath and evaporated until crystallization. A solution of 107 g. of ytterbium acetate in 133 ml. of boiling water is prepared in a one-liter flask. The hot solution is vigorously shaken for two minutes with 250 ml. of 0.5% sodium amalgam (125% of the theoretical Na). During the reaction 3 ml. of acetic acid is added to prevent the formation of hydroxide (formation of NaOH by partial decomposition of the sodium amalgam). It is best not to shake the mixture until the Na is fully spent, since shaking may cause the Yb to partially redissolve in the form of Yb (II) ions (green color of the aqueous layer). In addition, the Yb content of the amalgam should not exceed 1% to avoid solidification. The amalgam is separated from the solution and water-washed twice to remove the acetate. It is then treated with sufficient dilute hydrochloric acid to neutralize the residual Na. Small quantities of Yb which go into solution during this step are precipitated with NaOH. The amalgam is then shaken with excess hydrochloric acid until calomel starts to form. The Yb(OH)_3 precipitate is added to the HCl solution and the mixture is evaporated to a sirup. The precipitating NaCl is filtered off. The filtrate is calcined. Spectroscopically pure Yb_2O_3 is obtained in a yield exceeding 90%.

The acetate solution remaining from the first extraction may be allowed to react, after addition of 3 ml. of acetic acid, with an additional 83 ml. of sodium amalgam. The resultant ytterbium amalgam is worked up as above. The mother liquor is converted to the hydroxide and may be reextracted after dissolving in acetic acid.

b) If complete extraction of Yb from a mixture of ytterbium earths is desired, the solution must be shaken up to 20 times with sodium amalgam and the aqueous layer repeatedly freed of the sodium acetate formed, since high concentrations of the latter interfere with the reaction. Using this method, Marsh was able to reduce the Yb content of a Lu preparation to 0.0033%.

Pure compounds of Sm and Eu may be prepared by a basically similar method. The preferential formation of Sm, Eu and Yb amalgams is due to the fact that metallic Eu and Yb always form divalent ions, while Sm does so partially.

REFERENCES:

- I. A. Brukl. *Angew. Chem.* **50**, 25 (1937); **49**, 159 (1936); W. Kapfenberger. *Z. anal. Chem.* **105**, 199 (1936); J. K. Marsh. *J. Chem. Soc. (London)* **1937**, 1367.
- II. J. K. Marsh. *J. Chem. Soc. (London)* **1942**, 398, 523; **1943**, 8, 531; T. Moeller and H. E. Kremers. *Ind. Eng. Chem., Anal. Edit.* **17**, 798 (1945).

Metallic Rare Earths

I. REDUCTION OF THE CHLORIDES WITH METALS

LANTHANUM METAL, POWDER

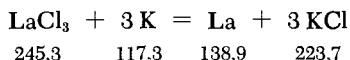

The Vycor (or similar glass) apparatus shown in Fig. 286 is dried by fanning with a flame under high vacuum. A vacuum pump is connected at *d*; *c* and *i* are closed off with rubber stoppers. The apparatus is filled with pure, dry nitrogen or argon, and a small tube containing distilled potassium is placed in tube *b*; the neck of the potassium ampoule is broken immediately prior to use. Anhydrous rare earth chloride is introduced into *a* through tube *c* (air must be excluded during this operation) and tube *c* is immediately closed off again. The apparatus is melt-sealed at *c* and *i*, and evacuated through *d* to a high vacuum. Capillary *f* is heated and bent downward (to position *b'*) and the potassium is slowly distilled from *b'* into *g*. This second distillation removes the possibility of traces of potassium oxide coming into contact with the chloride. The apparatus is then melt-sealed at *f* and *e*, a small portion of the potassium is distilled into constriction *h*, and the tube (*a-g*) is heated to 220-350°C in an electric furnace. Part of the rare earth chloride is reduced after a short time; an additional fraction of the potassium is then distilled into *h*, and the tube is reheated in the furnace. This stepwise reduction is continued until most of the rare earth chloride has been converted to the metal. Only then is the remaining potassium distilled by turning the tube upside down and placing almost the entire apparatus (*f-a*) in the furnace. The potassium is then immediately distilled off

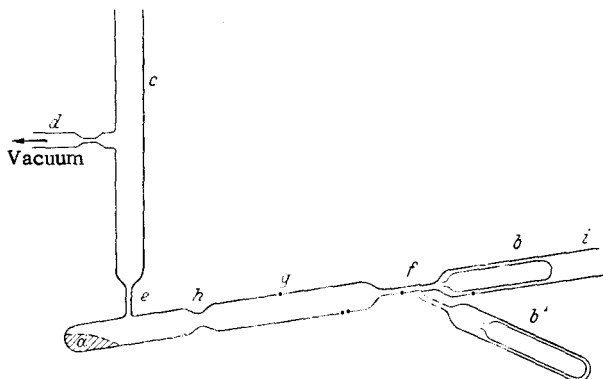

Fig. 286. Preparation of metallic rare earths by reduction of the chloride with metallic potassium; *a* rare earth chloride; *b*, *b'* metallic potassium; *c* filling tube for the rare earth chloride; *d* connection to vacuum pump.

again, and the process is repeated several times. This stepwise reduction prevents the reactants from fusing together, and thus ensures completion of the reaction. Finally the tube is gradually pulled out of the furnace, until a potassium mirror no longer forms at the unoccupied spots on the tube between *g* and *h*. The product consists of a loose black powder which does not adhere to the glass walls of the tube.

After cooling, tip *f* is connected via a dry rubber tube to the vacuum- N_2 (or Ar) system and broken off under N_2 or Ar. The alkali metal at *g* serves as a barrier and traps any traces of water vapor which may be introduced. The tube can now be broken at *h* without endangering the product, and the mixture of rare earth metal + 3 alkali chloride at *a* may be poured into a transfer apparatus through which protective gas is flowing (for transfer apparatus see Part I, p. 75 ff., especially Fig. 54).

All the rare earth metals, in the form of powders mixed with alkali chloride, may be prepared by this method. In preparing Sm, Eu or Yb metals (these elements form divalent compounds), a temperature of $250^\circ C$ must not be exceeded, since at higher temperatures, the direction of the reaction is reversed and $SmCl_2$, $EuCl_2$ and $YbCl_2$ are formed.

CERIUM METAL, SOLID

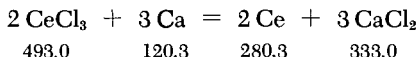

A crucible of sintered CaO or dolomite is placed in an iron tube provided with a welded-on bottom and a screw lid, and the space

between the crucible and the tube is filled with CaO powder. This precaution prevents contact between the reaction mixture and the iron wall if the crucible should break. Since the heat of the reaction between Ca and CeCl_3 is not sufficient for clean separation between the metal ingot and the slag, it is necessary to add a third component which produces a highly exothermic reaction with Ca, e.g., I_2 , S, KClO_3 or ZnCl_2 .

For a tube 20 cm. high and 2.5 cm. in diameter, suitable quantities of reactants are 200 g. of CeCl_3 , 103 g. of I_2 (mole ratio $\text{I}:\text{CeCl}_3 = 0.625:1.0$) and a 15% excess of very pure Ca powder (particles 0.3–2 mm.). The reactants are mixed under anhydrous condition and placed in the crucible; the iron cap is filled with CaO and screwed on. The tube is placed in a furnace heated to 650–750°C. The reaction starts suddenly when the temperature inside the tube reaches 400°C. The yield of Ce metal is 93%. The reaction may be carried out on a larger scale, but due to smaller relative heat losses, only 0.5 mole of I_2 per mole of CeCl_3 and a 10% excess of Ca are needed. The use of sulfur or KClO_3 lowers the yield. The resultant Ce metal contains 1–5% Ca and 0.1–1% Mg.

When smaller quantities of raw materials are used, the reaction temperature must be increased. This is done by replacing the iodine with ZnCl_2 (3–6% Zn, based on the amount of Ce). The product is freed of zinc by evaporating it in vacuum. The yield is 90% of Ce containing only 0.002% Zn.

Any Ca, Mg or Zn which may be dissolved in the Ce is removed by placing the product in a crucible made of MgO, CaO, BeO or Ta, which in turn is placed in a second crucible made of graphite. This assembly is placed in a quartz tube with one end closed and the other connected to a high-vacuum pump via a water-cooled brass coupling. The coupling is provided with a glass window to facilitate optical temperature measurement. The well-insulated quartz tube is placed for 30 minutes in an induction furnace heated to 1250°C. The melt is held at this temperature for 10–15 minutes, until cessation of bubbling.

This entire sequence of procedures can be used to prepare La, Ce, Pr and Nd in 99.9% purity. The reaction with Ca converts SmCl_3 , EuCl_3 and YbCl_3 to the dichlorides. The preparation of Y fails due to the high melting point of this metal.

II. REDUCTION OF THE OXIDES WITH METALS

SAMARIUM METAL, SOLID

A tantalum crucible (height 20 cm., diameter 2.5 cm.) containing a mixture of 20 g. of Sm_2O_3 and 20 g. of freshly prepared La turnings is heated for 30 minutes at 1450°C in an electric furnace at a pressure of 0.001 mm. The upper part of the crucible projects

from the furnace and is closed off with a lid carrying a connection to a high-vacuum pump. The Sm is deposited on the cooler parts of the crucible. The method results in a highly pure metal free of La; the yield is 80%.

Pure Yb metal may be prepared by the same method. In a similar preparation the La may be replaced by Ca or Al.

PROPERTIES:

Atomic weight 150.35. Silvery, air-stable metal. More volatile than La metal.

REFERENCE:

A. Jandelli. *Atti Reale Accad. Naz. Lincei, Rend.* VIII 18, 644 (1955).

III. ELECTROLYSIS OF FUSED CHLORIDES

LANTHANUM METAL, SOLID

The apparatus for melt electrolysis is shown in Fig. 287. The anode is a graphite crucible (inside diameter 40 mm., inside height 80 mm., wall thickness 5 mm., bottom thickness 10 mm.) containing the melt. The current is supplied through a sleeve surrounding the bottom of the crucible; the sleeve is connected to the power supply through an iron rod. The cathode is a Mo rod (diameter 10 mm., length about 100 mm.) friction-fitted into an iron pipe and covered near the top with a tube of sintered corundum cemented in with a talc-waterglass mixture. The rotating cathode should be able to agitate the melt; the current is supplied via a carbon friction contact. To collect the La metal which is thrown off by the spinning cathode and protect it against contact with graphite and the Cl_2 formed at the anode, a sintered alumina crucible (upper diameter 40 mm., height 30 mm.) is fitted exactly into the graphite crucible.

The furnace is heated to 1000°C and the crucible is charged with a salt mixture of the following composition: 27.4% LaCl_3 , 68.0% KCl , 4.6% CaF_2 (3.75 g. of KCl and 0.25 g. of CaF_2 per gram of La_2O_3). It is advisable to add initially only a small portion of the fluxing material. The mixture is allowed to melt and any NH_4Cl present is allowed to escape; the remainder of the flux is then added during the first minutes of the actual electrolysis. The electrolysis is run at 6-8 volts and 40 amp. The highest current efficiencies and product yields are obtained at about 7 amp. per cm^2 and 25 amp.-hr. The cathode should rotate at a rate of 1-2 r.p.s. At the end of the reaction, the current is shut off and stirring (rotation of the cathode) is continued for a few minutes. The crucible is then removed, allowed to cool and broken

to pieces. The resultant ingot contains more than 99% lanthanum.

With some of the other rare earth metals (Sc, Gd), it is necessary to work below the melting point of the metal. In such cases the metal is deposited on a cathode of molten Zn or Cd, in which the metal dissolves. The Zn or Cd is vacuum-distilled from the product alloy.

PROPERTIES:

Atomic weight 138.92. Iron gray, with a vivid metallic luster when polished; ductile, malleable. Tarnishes rapidly in moist air. M.p. 885°C ; d^{20} 6.18. Crystal structure: α -La, type A3 (Mg type); β -La, type A1 (Cu type).

CERIUM METAL, SOLID

Metallic cerium is obtained via electrolysis of a fused mixture of anhydrous CeCl_3 and KCl-NaCl .

The reaction is carried out in a roughly cylindrical copper vessel, with a wall thickness of 1 mm. (see Fig. 260, p. 957). The inside diameter is about 2.5 cm. At the top, the tube widens to an inverted truncated cone with a base diameter of about 8 cm. The cathode is a carbon rod (diameter 9 mm., length 16 cm.) inserted from below; up to about 1.5 cm. from the upper end of the cylindrical section of the tube, the cathode is wrapped with asbestos cord; this asbestos cord, in conjunction with the unmelted portion of the chloride mixture which rests on it, serves as the bottom of the melting pot. The anode is a somewhat thicker carbon rod inserted from above. The position of the anode may be adjusted by a height-regulating device attached to the side of this crucible. The electrode gap is located approximately at the midheight of the conical melting space.

For small-scale preparations, a thin carbon rod about 3 mm. in diameter and 20 mm. long is clamped between the two cathodes. The crucible is filled with 200 g. of CeCl_3 and 15-20 g. of KCl-NaCl (equimolar mixture) and the crucible contents are melted as rapidly

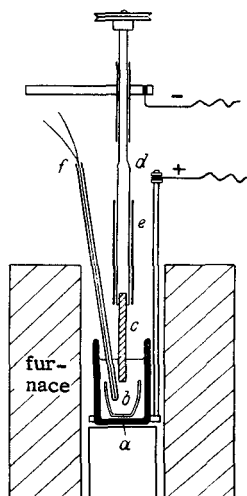

Fig. 287. Preparation of lanthanum metal. *a* graphite crucible; *b* corundum crucible; *c* molybdenum electrode; *d* iron rod; *e* corundum protective tube; *f* thermocouple.

as possible with a current of 30-40 amp. at 12-15 volts. As soon as the melt thins in consistency, the anode is raised somewhat, the thin carbon rod is removed, and electrolysis is carried out for several hours at 700-750°C. After solidification the metallic ingot is removed and remelted under KCl-NaCl in a silicon carbide crucible.

PROPERTIES:

Atomic weight 140.13. Iron gray, with a vivid metallic luster when polished; may be cut with a knife; somewhat harder than lead; ductile, malleable. M.p. 635°C; d^{25} 6.92. Tarnishes rapidly in moist air; burns at 160-180°C in a stream of O₂. Attacked by water (evolution of H₂). Crystal structure: α -Ce, type A3 (Mg type); β -Ce, type A1 (Cu type).

IV. ELECTROLYSIS OF ALCOHOLIC CHLORIDE SOLUTIONS

The electrolysis of an alcoholic solution of a rare earth chloride on a mercury cathode (20 volts, current density 0.02 amp./cm²) yields an amalgam with a rare earth metal concentration of up to 3%. The mercury is removed by vacuum distillation, leaving behind the pure rare earth metal.

REFERENCES:

- I. W. Klemm and H. Bommer. *Z. anorg. allg. Chem.* 231, 141 (1937); H. Bommer and E. Hohmann. *Ibid.* 248, 359 (1941); F. H. Spedding et al. *Ind. Eng. Chem.* 44, 553 (1952); F. H. Spedding and A. H. Daane. *J. Amer. Chem. Soc.* 74, 2783 (1952); E. J. Onstott. *Ibid.* 75, 5128 (1953).
- II. A. H. Daane, D. H. Dennison and F. H. Spedding. *J. Amer. Chem. Soc.* 75, 2272 (1953); E. J. Onstott. *Ibid.* 77, 812 (1955).
- III. F. Weibke and J. Sieber. *Z. Elektrochem.* 45, 518 (1939); F. Trombe. *Bull. Soc. Chim. France* (5) 2, 660 (1935); W. Fischer, K. Brünger and H. Grieneisen. *Z. anorg. allg. Chem.* 231, 54 (1937); W. Muthmann et al. *Liebigs Ann.* 320, 242 (1901); see also *Ind. Eng. Chem.* 3, 880 (1911).
- IV. V. B. S. Hopkins et al. *J. Amer. Chem. Soc.* 57, 2185 (1935); 56, 303 (1934); 53, 1805 (1931); *Z. anorg. allg. Chem.* 211, 237 (1933).

Rare Earth Trichlorides

L_nCl_3 (anhydrous)

I. REACTION OF THE OXIDES WITH Cl₂ AND S₂Cl₂

The rare earth oxide (1-2 g.) is placed in a porcelain boat and chlorinated for about five hours in a stream of Cl₂-S₂Cl₂ (prepared

by bubbling Cl_2 through a wash bottle filled with S_2Cl_2 and standing in a 30-40°C water bath). The temperature is slowly raised during the process from an initial 400°C to about 20° below the melting point of the chloride. The chlorides deposit on the bottom as loose powders ready for use in further reactions.

The chlorides of Sm, Eu, Gd, Tb, Dy and Y, which melt below 700°C, are best prepared by dehydration of the hydrated chlorides in a stream of HCl.

II. DEHYDRATION OF THE HYDRATED CHLORIDES IN A STREAM OF HCl

The hydrate of the rare earth chloride (3-5 g.) is dried in a vacuum desiccator and then heated by stages in the region of the individual hydrate transition temperature while a stream of oxygen-free N_2 -HCl mixture is passed over it. The boat, which may be of porcelain, quartz, gold or platinum, is placed in a tube of Pyrex, Vycor or quartz. The temperature may be raised beyond the transition region only when no further hydrochloric acid condenses on those sections of the tube which project from the furnace; if this precaution is not observed the chloride melts in the water of crystallization and the product then contains oxychlorides. Dehydration is complete after 30-60 hours. Heating at 300-400°C in a stream of pure HCl is continued for one hour, and the product is allowed to cool in a stream of N_2 . The stopcocks and ground joints which come into contact with the hydrogen halides are greased with a mixture of paraffin and paraffin oil.

The product must yield a clear solution in water. Contamination with traces of oxychloride may be recognized by turbidity of the aqueous solutions.

III. HEATING OF THE HYDRATED CHLORIDES WITH NH_4Cl

Dehydration of the hydrated chlorides may also be achieved by heating with an excess (1-1.5 times) of NH_4Cl . The products, however, always contain small quantities of NH_4Cl .

IV. HEATING OF THE OXIDES WITH NH_4Cl

A 250-ml. quartz Erlenmeyer flask equipped with an adapter that can be closed off with a small glass cap and can also be connected to a quartz tube (length 25 cm., diameter 3 cm.) is filled with a mixture of 60 g. of the rare earth oxide and 120 g. of NH_4Cl .

The flask, tilted about 30° from the horizontal, is slowly rotated around its axis and heated to 220-250°C on an air bath. Evolution of NH_3 ceases after 6-8 hours. After a short cooling

period, the flask is closed with the glass cap while still warm and then allowed to cool completely. The cap is then replaced with the quartz tube. The other end of the tube is connected (via two gas traps) to an oil vacuum pump. The flask is evacuated and surrounded with an electric furnace extending a few centimeters beyond the quartz joint. The mixture is slowly heated to 300-350°C, resulting in evolution of a small quantity of water vapor and NH₃. The excess NH₄Cl sublimes into the quartz tube. To prevent cracking of the glass connection, it is sometimes necessary to cool the other end of the tube with a water-cooled lead or tin coil. After 4-5 hours, the mixture is allowed to cool, the quartz tube is cleaned, and the sublimation is repeated. Complete removal of the last traces of NH₄Cl is attained only at 400°C.

The method is particularly suited to the preparation of large quantities of product. The oil pump may be replaced by a jet ejector if an adequate trap filled with a drying agent is inserted in the line.

The above methods are suitable for the preparation of all the anhydrous rare earth chlorides, including that of yttrium. For the preparation of ScCl₃, see W. Fischer, R. Gewehr and H. Wingchen, *Z. anorg. allg. Chem.* 242, 170 (1939).

PROPERTIES:

Hygroscopic powders which give clear solutions in water and alcohol. The melting points drop from LaCl₃ (~860°C) to TbCl₃ (~600°C) and rise again to LuCl₃ (~900°C).

REFERENCES:

- I. W. Klemm, K. Meisel and H. U. von Vogel. *Z. anorg. allg. Chem.* 190, 123 (1930).
- II. O. Hönigschmid and H. Holch. *Z. anorg. allg. Chem.* 165, 294 (1927); 177, 94 (1928); L. Holleck. *Angew. Chem.* 51, 243 (1938).
- III. F. Weibke and J. Sieber. *Z. Elektrochem.* 45, 518 (1939).
- IV. A. Brukl. *Angew. Chem.* 52, 152 (1939); J. B. Reed. *J. Amer. Chem. Soc.* 57, 1159 (1935); D. H. West and B. S. Hopkins. *Ibid.* 57, 2185 (1935).

Rare Earth Tribromides

LnBr₃ (anhydrous)

I. DEHYDRATION OF HYDRATED BROMIDE-NH₄Br MIXTURES IN A STREAM OF HBr

A hydrobromic acid solution containing six moles of NH₄Br per mole of the rare earth bromide is carefully evaporated to dryness

on an air bath, with constant stirring toward the end of the operation. The evaporation should be carried out in a stream of CO_2 . The crumbly salt mixture is dehydrated in a stream of HBr at slowly increasing temperatures. The product must not be allowed to melt under any circumstances! The sublimation of NH_4Br starts at 250°C ; its last traces are removed at 600°C .

Very pure tribromides are obtained by dehydration and removal of NH_4Br from the $\text{LnBr}_3 \cdot 6 \text{H}_2\text{O} - \text{NH}_4\text{Br}$ mixture on heating in high vacuum. For the preparation of ScBr_3 , see W. Fischer, R. Gewehr and H. Wingchen, *Z. anorg. allg. Chem.* 242, 170 (1939).

II. TREATMENT OF THE ANHYDROUS CHLORIDES WITH HBr

The anhydrous rare earth chloride (1-2 g.) is heated in a stream of HBr for about seven hours. The temperature is slowly raised from 400°C to slightly below the melting point of the bromide.

PROPERTIES:

Hygroscopic powders. The melting points rise with atomic weight from SmBr_3 ($\sim 628^\circ\text{C}$) to ErBr_3 ($\sim 950^\circ\text{C}$).

REFERENCES:

- I. G. Jantsch et al. *Z. anorg. allg. Chem.* 207, 361 (1932); G. Jantsch and N. Skalla. *Ibid.* 201, 213 (1931).
- II. W. Klemm and J. Rockstroh. *Z. anorg. allg. Chem.* 176, 189 (1928).

Rare Earth Triiodides

LnI_3 (anhydrous)

I. DEHYDRATION OF HYDRATED IODIDE- NH_4I MIXTURES IN A STREAM OF $\text{HI} - \text{H}_2$

A mixture of one mole of $\text{LnI}_3 \cdot 6 \text{H}_2\text{O}$ and six moles of NH_4I is heated in a stream of $\text{HI} + \text{H}_2$ mixture with a moderate HI concentration. Under no circumstances should the temperature be raised at a rate fast enough to melt or sinter the product during the dehydration. Because the product is extremely sensitive to O_2 and moisture, great care must be exercised in purifying the gases. Since the last traces of NH_4I sublime only at high temperatures, the mixture is heated to 600°C during the last stage. When the dehydration is complete, the HI is flushed out with N_2 . The iodides are stored under N_2 .

This method is suitable for the iodides of La, Pr and Nd. However, SmI_3 is usually contaminated with some SmI_2 , which is

converted to SmI_3 after elimination of the NH_4I . This is done by heating the product to 500°C and treating it with iodine vapor. Again, under the conditions of this method, EuI_3 decomposes to EuI_2 and iodine. Because of their tendency to hydrolyze, the iodides of the rare earth metals which are less electropositive than Eu can be prepared only from the anhydrous chlorides. The same applies to CeI_3 .

II. REACTION OF THE ANHYDROUS CHLORIDES WITH MIXTURES OF $\text{HI} + \text{H}_2$

The anhydrous rare earth chloride is heated for 4-6 hours until 600°C is reached; it is then held at this temperature for 30-40 hours in a stream of $\text{HI}-\text{H}_2$ containing as much HI as possible. The iodides are cooled and stored under N_2 .

Special care must be exercised with the lower-melting chlorides, since the chlorides no longer react with the HI when enveloped in iodide.

PROPERTIES:

Hygroscopic powders. The melting points drop from LaI_3 ($\sim 761^\circ\text{C}$) to PrI_3 ($\sim 733^\circ\text{C}$) and rise again to LuI_3 ($\sim 1045^\circ\text{C}$).

REFERENCES:

- I. G. Jantsch et al. Z. anorg. allg. Chem. 185, 56 (1930); E. Hohmann and H. Bommer. Ibid. 248, 384 (1941).
- II. G. Jantsch et al. Z. anorg. allg. Chem. 201, 207 (1932); 207, 353 (1932); 212, 65 (1933); E. Hohmann and H. Bommer. Ibid. 284, 383 (1941).

Rare Earth Dihalides

LnX_2 (anhydrous)

The trihalides of Sm, Eu and Yb are converted to the dihalides by heating in a stream of carefully purified H_2 . The temperature should not be raised as high as the melting point of the trihalide, since the molten compounds react either slowly or not at all with H_2 .

All the dichlorides, dibromides and diiodides of Sm, Eu and Yb can be prepared by this method. Note that EuI_2 is formed under the conditions given for the preparation of the triiodides (method II). Thermal degradation of YbI_3 in high vacuum is the preferable method for obtaining YbI_2 .

REFERENCES:

- W. Prandtl and H. Kögl. Z. anorg. allg. Chem. 172, 265 (1928); G. Jantsch, H. Rüpzig and W. Runge. Ibid. 161, 210 (1927); W. Kapfenberger. Ibid. 238, 281 (1938); G. Jantsch, N. Skalla and H. Jawurek. Ibid. 201, 218 (1931).

Cerium (III) Oxide



Reduction of CeO_2 in a stream of H_2 is the best method. It is carried out in a silicon carbide boat. The H_2 must be carefully purified (free of oxygen) and dried. Very pure CeO_2 (3 g.), prepared as described on p. 1133, requires about 80 hours at 1000°C (or 45 hours at 1100°C) for complete reduction. Traces of La and Nd moderately increase the rate of reduction, while Pr and Tb do so markedly. The reduction is complete when the blue-black color of the partially reduced intermediates changes to the pure golden yellow of Ce_2O_3 .

PROPERTIES:

Golden yellow (greenish yellow products are incompletely reduced); converts slowly in air to CeO_2 ; rapid conversion, accompanied by a glow, on slight heating. Readily soluble in acids. d (x-ray) 6.856. Crystal structure: type $D5_2$ (A-sesquioxide type).

REFERENCES:

- E. Friederich and L. Sittig. Z. anorg. allg. Chem. 134, 316 (1925); 145, 127 (1925); W. Zachariasen. Z. phys. Chem. 123, 134 (1926); G. Brauer and U. Holtschmidt. Z. anorg. allg. Chem. 265, 105 (1951); U. Holtschmidt. Thesis, Freiburg i. Br., 1952; G. Brauer and U. Holtschmidt. Z. anorg. allg. Chem. 279, 129 (1955); D. J. M. Bevan. J. Inorg. Nuclear Chem. 1, 49 (1955).

Praseodymium (IV) Oxide



At 400°C , praseodymium oxide preparations achieve a composition corresponding to PrO_2 only under an O_2 pressure of 282 atm. However, at 300°C , only 50 atm. of O_2 suffices. The oxidation of

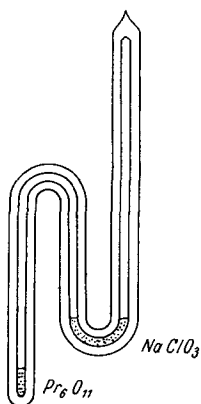

Fig. 288. Quartz tube for oxidation of praseodymium oxide.

Pr_6O_{11} is carried out in the quartz tube shown in Fig. 288. The O_2 is generated by the decomposition of a weighed amount of NaClO_3 in the sealed tube. The amount of chlorate used is calculated beforehand to yield an O_2 pressure of 50 atm. in the sealed tube. After the NaClO_3 is decomposed by local heating, the entire tube is heated to 300°C for 48 hours.

PROPERTIES:

Dark brown powder, easily reduced by H_2 to Pr_2O_3 . Crystal structure: type C1 (CaF_2 type). Measurements of the dissociation pressure of O_2 indicate that the Pr-O system contains additional stable phases with compositions of $\text{PrO}_{1.715}$, $\text{PrO}_{1.802}$ and $\text{PrO}_{1.833}$.

REFERENCES:

- J. D. McCullough. *J. Amer. Chem. Soc.* **72**, 1386 (1950); W. Simon and L. Eyring. *Ibid.* **76**, 5872 (1954); R. E. Ferguson, E. D. Guth and L. Eyring. *Ibid.* **76**, 3890 (1954).

Rare Earth Hydroxides

$\text{Ln}(\text{OH})_3$ (crystalline)

Crystalline trihydroxides $\text{Ln}(\text{OH})_3$ of the lanthanides (at least those ranging from La to Er) and of Y are prepared by heating the hydroxides under conc. (7N) NaOH: A solution of 2 g. of the nitrate in 2 ml. of water is added to a silver crucible containing a solution of 7 g. of NaOH in 7 ml. of water. The crucible, covered with a silver lid, fits precisely into a pressure tube closed off with a screwed-on cap. The tube is heated for 25 hours at 200°C . The mixture is cooled, the clear supernatant is siphoned off, and the product is washed several times (by decantation) with CO_2 -free water; it is then washed on a filter crucible in the absence of CO_2 and dried by suction. Final drying is achieved by storing the product for 24 hours over conc. H_2SO_4 in a vacuum desiccator.

PROPERTIES:

Transparent, hexagonal prisms. Solubility in conc. NaOH increases with the atomic number. The dehydration passes through

an intermediate stage, MO(OH), in which the compounds have the PbFCl structure. La(OH)₃ has UCl₃ structure.

REFERENCES:

- R. Fricke and A. Seitz. Z. anorg. allg. Chem. 254, 107 (1947); R. Roy and H. A. McKinstry. Acta Crystallogr. (Copenhagen) 6, 365 (1953).

Lanthanum Sulfide

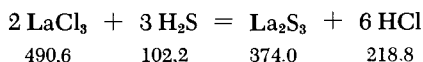

Anhydrous LaCl₃ is heated in a stream of pure H₂S. The temperature is maintained at 500-600°C for several hours, followed by heating at 600-700°C overnight. Prior to use, the H₂S is dried over CaCl₂ and P₂O₅, liquefied at -78°C (see p. 344 ff.) and evaporated from the liquid [A. Simon, Ber. dtsch. chem. Ges. 60, 568 (1927) and this Handbook, Part I, p. 46 ff.] at a flow rate of one bubble per second. The intermediate product is then heated to 800-1000°C for several hours and allowed to cool in a stream of H₂S.

This method is suitable for all the rare earth sulfides, including those of Sc and Y.

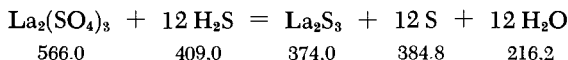

The recrystallized sulfate hydrates may also serve as starting materials. Except for the fact that the decomposition temperatures of the dehydrated sulfates (given by Brill; see references below) are different, the procedure is similar to that given above for the chlorides. In this case, however, the products are usually contaminated with variable amounts of Ln₂O₂S.

Under these conditions Y₂(SO₄)₃ and Er₂(SO₄)₃ form Ln₂O₂S exclusively. It is also possible to prepare La₂O₂S by reduction of La₂(SO₄)₃ with H₂ at 800°C.

If the treatment with H₂S is carried out at a lower temperature (580-600°C), the sulfates of La, Ce and Pr form polysulfides Ln₂S₄, which decompose above 600°C to Ln₂S₃ and S.

The anhydrous rare earth sulfates start to decompose above 600°C, yielding the basic sulfates Ln₂O₃ · SO₃, whose decomposition temperatures decrease from La (1150°C) to Yb (900°C).

PROPERTIES:

Light yellow to light orange, opaque, hexagonal prisms. d^{25} 4.86.

REFERENCES:

- I. W. Klemm, K. Meisel and H. U. von Vogel. Z. anorg. allg. Chem. 190, 123 (1930).
- II. O. Brill. Z. anorg. allg. Chem. 47, 464 (1905); W. Biltz. Ibid. 71, 424 (1911); Ber. dtsch. chem. Ges. 41, 3341 (1908).

Lanthanum Selenides

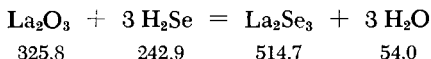
 La_2Se_3 , La_2Se_4 

I. Both La_2Se_3 and La_2Se_4 are prepared by high-temperature reaction of the oxide or chloride with H_2Se .

A boat with La_2O_3 is placed inside a quartz tube surrounded by an electric furnace. Several boats containing Se are placed ahead of the oxide and heated with Bunsen burners to a temperature at which the Se slowly evaporates. A stream of carefully purified H_2 is passed through the quartz tube. After treatment for about five hours, during which the temperature of the La_2O_3 is slowly raised from 600 to 1000°C, La_2Se_4 is obtained in quantitative yield.

Heating the polyselenide for 30-60 minutes in high vacuum at 600-800°C yields La_2Se_3 . This operation must be carried out in a porcelain or corundum boat, since quartz reacts to form the rare earth oxide and SiSe_2 .

The same procedure is used for Ce_2Se_4 and Pr_2Se_4 . However, Nd yields only $\text{Nd}_2\text{Se}_{3.5}$. The other rare earths do not form polyselenides. The sesquiselenides of these elements are best prepared by treating the rare earth chlorides with H_2Se :

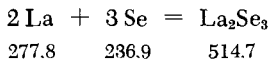

II. Synthesis from the elements by heating a stoichiometric mixture in a silicon carbide crucible held in an evacuated, sealed quartz tube.

PROPERTIES:

La_2Se_3 : Brick red. Insoluble in both cold and boiling water; violently evolves H_2Se in dilute acids; decomposes slightly after several days in moist air. d^{20} 6.19.

REFERENCES:

I and II: W. Klemm and A. Koczy. *Z. anorg. allg. Chem.* **233**, 86 (1937); A. Koczy. Thesis, Danzig, 1936.

La, Ce, Pr and Nd Monochalcogenides

LnS, LnSe, LnTe

These compounds are prepared by synthesis from the elements. The rare earth metal powder, as pure as possible, is placed in one of the arms of an L-shaped glass tube. The other arm contains the stoichiometric quantity of S, Se or Te (1:1 ratio). The tube is melt-sealed in vacuum and heated in an electric furnace until the non-metal is completely consumed. The temperature should reach 400-450°C by the end of 2-3 days. Powder pattern analysis of the products indicates the formation of nonhomogeneous materials containing Ln_2X_3 and Ln_2X_4 , but not LnX , which starts to form at 1000-1100°C.

For this reason, the samples obtained at the lower temperature are compressed (10 tons/cm.²) to cylindrical tablets in an atmosphere of CO_2 and sealed (under vacuum) in quartz tubes. The material is then slowly heated to 1000°C in an electric furnace (to 1100°C in the case of the tellurides). The products are 99.2-99.5% pure.

In addition, CeS may be prepared by heating Ce_2S_3 to 2200°C with a small excess of CeH_3 ; an evacuated molybdenum container is used.

PROPERTIES:

The monosulfides of La, Ce, Pr and Nd are greenish yellow, the monoselenides reddish yellow, the monotellurides blue violet. The sulfides decompose in moist air to form H_2S . Crystal structure: type B1 (NaCl type).

REFERENCES:

A. Jandelli. *Gazz. Chim. Ital.* **85**, 881 (1955); E. O. Eastman, L. Brewer, L. A. Bromley, P. W. Gilles and L. N. Lofgren. *J. Amer. Chem. Soc.* **72**, 2249 (1950).

Europium (III) Chalcogenides

EuS, EuSe, EuTe

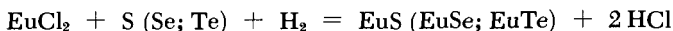

222.8 32.1 (79.0; 127.6) 2.0 184.0 (230.9; 279.5) 72.9

A mixture of EuCl_2 with a severalfold excess of S, Se or Te is heated for several hours to 600°C in a fast stream of purified H_2 .

This produces the desired chalcogenides. The S, Se or Te in excess of the desired composition is removed by heating for a few hours more at 820°C in the stream of H₂.

Europium also forms an oxide, EuO, which may be prepared by heating Eu₂O₃ with La or C.

PROPERTIES:

EuO: dark red or blue depending on the conditions of preparation; d 7.7. EuS: blue black; d 5.7. EuSe: brown black; d 6.4. EuTe: black, metallic appearance. All the Eu (II) chalcogenides crystallize in type B1.

REFERENCES:

W. Klemm and H. Senff. Z. anorg. allg. Chem. 241, 259 (1939); H. A. Eick, N. C. Baenziger and L. Eyring, J. Amer. Chem. Soc. 78, 5147 (1956); M. Guittard and A. Benacerraf. Comptes Rendus Hebd. Séances Acad. Sci. 248, 2589 (1959); L. Domange, J. Flahaut and M. Guittard. Ibid. 249, 697 (1959); J. C. Achard. Ibid. 250, 3025 (1960).

Rare Earth Sulfates

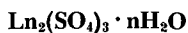

The oxide (0.3 g.) is dissolved in 20 ml. of hot 6N H₂SO₄. The solution is filtered and allowed to crystallize over conc. H₂SO₄ in a vacuum desiccator. The product is filtered through fritted porcelain, washed twice with 10 ml. of water and once with 10 ml. of ethanol, and dried in air for four hours.

The product obtained from La by this procedure is La₂(SO₄)₃ · 9 H₂O and from Yb it is Yb₂(SO₄)₃ · 11 H₂O. The remaining rare earths and yttrium yield octahydrates.

Cerium sulfate, Ce₂(SO₄)₃ · 5H₂O, is prepared by heating 3 g. of the chloride with 5 ml. of conc. H₂SO₄ until all the hydrogen chloride has been removed. Then 20 ml. of water is added and the product is allowed to crystallize in a desiccator.

Alternate method: A neutral or slightly acid solution of the sulfate is treated with about 3/4 of its volume of ethanol. The sulfates may thus be isolated rapidly and quantitatively, without the evaporation stage.

Anhydrous rare earth sulfates may be prepared by dehydration of the hydrates at 400-600°C. The same procedure can also be used with the acid sulfates obtained by evaporating the chlorides with conc. H₂SO₄.

PROPERTIES:

The rare earth sulfates usually crystallize as octahydrates. The anhydrous sulfates are formed in the range of 155 to 295°C; if the dehydration is carried out carefully, it is sometimes possible to detect intermediate stages, such as pentahydrates (Pr, Nd, Er) and dihydrates (La, Ce, Nd, Yb).

REFERENCES:

- W. W. Wendlandt. *J. Inorg. Nuclear Chem.* 7, 51 (1958); W. Biltz. *Z. anorg. Chem.* 17, 427 (1911); O. Brill. *Z. anal. Chem.* 47, 464 (1905).

Rare Earth Nitrides

LnN

Rare earth nitrides may be prepared by heating the metal in a stream of N_2 or NH_3 , or by reaction of the chloride with NH_3 . The preparation of LaN by the first method is given as an example.

LANTHANUM NITRIDE, LaN

Lanthanum filings (several hundred milligrams), prepared from the metal in a stream of N_2 , are freed of iron with a magnet and heated in a molybdenum boat placed in a stream of purified N_2 . The azotization requires 2-4 hours at 750°C, 1-2 hours at 900°C.

The nitrides of Ce, Pr, Nd, Sm, Eu and Yb may be prepared by a basically similar method.

PROPERTIES:

Black powder; evolves NH_3 in moist air. Crystal structure: type B1 (NaCl type).

REFERENCES:

- B. Neumann, C. Kröger and H. Haebler. *Z. anorg. allg. Chem.* 207, 148 (1932); W. Muthmann and H. Kraft. *Liebigs Ann.* 325, 274 (1902); A. Jandelli and E. Botti. *Atti R. Acad. Naz. Lincei, Rend.* [6] 25, 129 (1937); R. A. Young and W. T. Ziegler. *J. Amer. Chem. Soc.* 74, 5251 (1952); H. A. Eick, N. C. Baenziger and L. Eyring. *Ibid.* 78, 5987 (1956); B. M. Ormont and E. V. Balabanovich. Russian Patent 51,424, *Chem. Zentr.* 1938, II, 573; W. Klemm and G. Winkelmann. *Z. anorg. allg. Chem.* 288, 87 (1956).

Rare Earth Nitrates

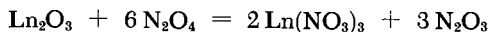
 $\text{Ln}(\text{NO}_3)_3$ (anhydrous)

Anhydrous nitrates of the rare earths may be obtained from the oxides by heating with NH_4NO_3 or, better, by treatment with liquid N_2O_4 . However, $\text{Nd}(\text{NO}_3)_3$ can be prepared only from Nd_2O_3 and N_2O_4 ; heating Nd_2O_3 with NH_4NO_3 yields $\text{Nd}(\text{NO}_3)_3 \cdot \text{NH}_4\text{NO}_3$.

The apparatus for the preparation from the oxides and N_2O_4 is shown in Fig. 289. Drying tower *a*, filled with P_2O_5 , is connected to storage bottle *e* through a vacuum-type stopcock *b*. A mercury manometer, which serves as a safety valve, is attached at *f*, and a McLeod gage is connected to *g* via a cold trap. The 150-ml. steel bomb *h* is equipped with a needle valve at the top and a square thread screw at the bottom; the latter is for the introduction of the dry oxide (about 2 g.) and removal of the reaction product. The bottom neck of the bomb and the corresponding surface of the screw head have machined seats for a lead O-ring. Lead packing may also be used at the junction of the bomb and the needle valve. The metal and glass tubes are connected at *i* by means of a cement seal (for example, Glyptal). Two stopcocks, *c* and *d*, and a cold trap *k* complete the system.

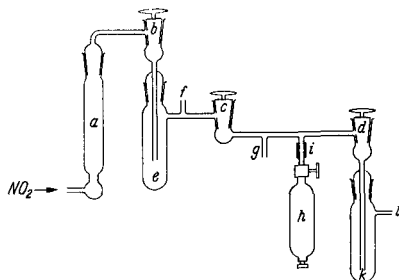

Fig. 289. Preparation of anhydrous rare earth nitrates. *a* drying tower; *b*, *c*, *d* vacuum-type stopcocks; *f*, *g* connections to manometers; *h* steel bomb; *k* cold trap.

The apparatus is evacuated through *l* to about 0.02 mm. Stopcock *c* is closed and about 30 ml. of liquid N_2O_4 is condensed in *e* by cooling with liquid N_2 . Then *c* is opened, *b* and *d* are closed, and the N_2O_4 is distilled into the steel bomb *h* (40°C water bath at *e*, cooling with liquid N_2 at *h*). The needle valve is closed and

the bomb disconnected at *i*. A steel jacket is screwed on and the bomb is heated for 24 hours at 150°C. After cooling, the N_2O_4 is removed (vacuum) via a system of drying towers filled with $Mg(ClO_4)_2$ and collected in a trap cooled with Dry Ice-acetone.

The last traces of N_2O_4 are removed by heating the product in a drying pistol at 137°C (boiling xylene). Very pure nitrates are obtained in 100% yield.

Up to now, this method has been used for the preparation of the nitrates of Y, La, Pr, Nd, Sm and Gd. For the preparation of $(NH_4)_2Ce(NO_3)_6$, see G. F. Smith, V. R. Sullivan and G. Frank, *Ind. Eng. Chem., Anal. Edit.* 8, 449 (1936), as well as p. 1133 f. of this Handbook.

PROPERTIES:

Loose powders; form clear solutions with water and ethanol (very exothermic process). The nitrate colors differ only slightly from those of the corresponding anhydrous chlorides.

REFERENCE:

- T. Moeller and V. D. Aftandilian. *J. Amer. Chem. Soc.* 76, 5249 (1954); T. Moeller, V. D. Aftandilian and G. W. Cullen in: W. C. Fernelius, *Inorg. Syntheses*, Vol. V, New York-London, 1957, pp. 37-42; L. F. Audrieth, E. E. Jukkola, R. E. Meints and B. S. Hopkins. *J. Amer. Chem. Soc.* 53, 1807 (1931).

Rare Earth Cyclopentadienides

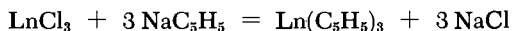

The anhydrous rare earth chloride, in tetrahydrofuran solution, is treated (stirring) with the stoichiometric quantity of cyclopentadienylsodium. The solvent is then removed by distillation and the product is sublimed at 200-250°C in vacuum (10^{-4} mm.).

Up to now, only the tricyclopentadienides of Sc, Y, La, Ce, Pr, Nd, Sm and Gd have been prepared.

PROPERTIES:

Crystalline compounds; begin to decompose above 400°C. Insoluble in hydrocarbons, soluble in tetrahydrofuran and

1,2-dimethoxyethane. Decompose in water to cyclopentadiene and the hydroxide. Quite stable in air, with the exception of $\text{Cd}(\text{C}_5\text{H}_5)_3$.

REFERENCE:

G. Wilkinson and J. M. Birmingham. J. Amer. Chem. Soc. 76, 6210 (1954).

Titanium, Zirconium, Hafnium, Thorium

P. EHRLICH

Titanium

Ti

Due to its great affinity for a large number of elements, the preparation of titanium poses considerable difficulties. In particular, N, C and O dissolve to an appreciable extent in the metallic phase, and cause cold-shortness even when present in minute quantities. They cannot be removed either chemically or by sintering or melting in high vacuum. Consequently, the relatively easy conversion of TiO_2 with Ca (method I below) yields only 98% pure metal, even under conditions where the highest purity of apparatus and raw materials is maintained.

Pure metal that is ductile while cold can therefore be prepared only by methods which use halides as the starting materials. However, these procedures, which are based on the reactions K_2TiF_6 (or Na_2TiF_6) + Na (method II) or TiCl_4 + Na (method III below), suffer from the drawback that the deposited metal is usually porous or flaky, which leads to reoxidation during the removal of the alkali halide by-product; it is therefore used only as a crude starting material for the purification process. Nevertheless, careful adherence to a number of precautionary measures permits the preparation, even by these methods, of pure metal which can be cold-worked. The Kroll magnesium process (method IV), which utilizes the reaction between TiCl_4 and Mg, is used at present both in the laboratory and in industry.

The highest purity (0.03% C and $\sim 0.006\%$ N) is attained via the elegant recovery process of van Arkel and de Boer (method V below). This is based on the thermal decomposition of titanium iodide at 1100-1500°C.

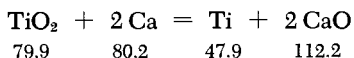
I. PREPARATION OF CRUDE METAL
FROM THE OXIDE AND CALCIUM

When only crude starting metal for the refining process is desired, the preparation may be simplified and carried out in

a bomb made of two steel sections welded together. Section 1 (the one of larger diameter) consists of a tube of type 304L stainless or low-carbon steel with a welded-on bottom. A wall thickness of 1 mm. is sufficient if the tube diameter does not exceed 25 mm. This section is annealed at 1000°C in moist H₂ (for more efficient removal of the P and C present). A second, crucible-like section, 40-60 mm. long, of exactly the same shape and precisely fitting into the first section (in such a way that the two sections telescoped together make up a vessel closed on all sides), is charged with the starting materials and forced as far as possible into the first section in order to reduce the air space inside to the minimum and to give the tightest possible seal between the two walls. If this is done, then the rims of the two tubes may be welded together without a welding rod; the lower section of the tube, that is, the section encompassing the charge, is cooled in water during the welding operation. One can avoid, to a large extent, the penetration of the welding gases into the bomb either by extending the sealing surface between the two tubes (that is, by using longer tubes for an identical charge), or by crimping the upper rim of the outer crucible around the inner one. As an explosion protection, and to provide a backup to strengthen the bomb walls, a closely fitting external tube or jacket, made of the same material and open at both ends, should surround the bomb. Scaling of the bomb may be prevented by preheating the latter inside a porcelain tube in a stream of H₂; if the heating must be carried out in air, a coat of aluminum-bronze paint will prevent too rapid oxidation of the tube.

Following the reaction (see description below) the bomb is allowed to cool completely before being sawed open. The sawing should not introduce any iron filings into the product (avoid tilting the bomb during sawing or cutting at an angle). The reaction product can usually be loosened by gentle tapping with a hammer while the tube is clamped in a vise. Alternatively, the crucible may be sawed open along its length and the steel jacket is just peeled off.

Only Si-free, well-dried TiO₂ starting material should be used, to avoid formation of silicon or silicides. If this precaution is not taken, these impurities are carried over in the subsequent refining process and are incorporated into the titanium ingot. Furthermore, the reduction should be carried out only with distilled Ca; addition of distilled Na is advantageous. Thus, the reduction of 25 g. of TiO₂ with a mixture of 40 g. of Ca and 20 g. of Na yields about 13 g. of crude Ti (with a metal content of about 90%). Heating for 20 minutes at 1000°C suffices for complete reduction. After cooling and opening the tube, the contents are ground to pea size and leached with alcohol, water and increasingly concentrated portions of hydrochloric acid. The residue

is washed free of chloride, the water is removed with alcohol, and the product is dried at 110°C.

The preparation of titanium that is malleable when hot (>200°C) by this process is described by Kroll. Pure TiO₂ (770 g.), turnings of distilled Ca (770 g.), and fused and pulverized CaCl₂/BaCl₂ (750 g./250 g.) are mixed and pressed into briquets, which are allowed to react under 99.2% Ar in an electric furnace at > 700°C. The addition of the salts is necessary to moderate the reaction and, above all, to prevent the formation of CaTiO₃, a product which does not react with Ca even on repeated reduction. The use of CaH₂ in the second reduction has proved useful, since the powdery hydride mixes very readily with the other reactants while the nascent H₂ it evolves is a powerful reducing agent. Thus, 348 g. of Ti (from the first reduction stage) + 400 g. of CaCl₂/BaCl₂ (3:1) + 50 g. of Ca + 50 g. of CaH₂ gave a yield of 337 g. of metal after heating for one hour at 1000°C under 99.6% Ar. The very well-sintered product is crushed and washed with water and concentrated hydrochloric acid, yielding fairly homogeneous granules.

The original reference covers the constructional details of the furnace.

With sufficiently small inputs (20-30 g. of TiO₂) the second reduction may also be carried out in the welded bomb and without the addition of CaH₂; the temperature should then be 1000°C (see also the procedure for Th, method II).

As in the preparation of the rare earth metals [F. H. Spedding et al., *Ind. Eng. Chem.* **44**, 553 (1952)] the addition of free iodine to the reduction mixture is recommended, since the large heat of formation of CaI₂ facilitates fusion of the metal.

II. PREPARATION OF CRUDE METAL FROM FLUORIDES AND SODIUM

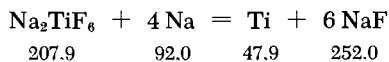

or

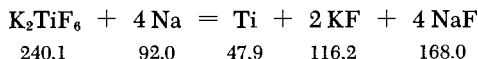

The fluorotitanates are prepared by dissolving pure TiO₂ in an excess of warm 20-40% hydrofluoric acid, treating the mixture with a stoichiometric quantity of NaOH or KOH, evaporating the solution without overheating (at 40-60°C) until saturation, and allowing the product to crystallize. In the case of the potassium salt, the product is the monohydrate; it is readily recrystallized from water. Heating of the air-dried product for two days at 35°C readily yields the anhydride, which in air at 500°C decomposes

to the oxyfluoride. The Na_2TiF_6 crystallizes already as the anhydrous salt and may be obtained in 99.9% purity by repeated precipitation with alcohol from aqueous solution. The small amount of water remaining in the product after drying in air is difficult to remove by heating without causing partial hydrolytic decomposition [H. Ginsberg and G. Holder, *Z. anorg. allg. Chem.* 190, 407 (1930); 196, 188 (1931); 201, 198 (1931); 204, 225 (1932)].

The Na_2TiF_6 , in portions of up to 1 kg., may be readily reduced with a 10% excess of Na in a bomb. The sodium is cut into small cubes and mixed with the hexafluorotitanate. After filling, the bomb is welded as in method I and heated to 1000°C. It is imperative that the fluoride be absolutely dry, otherwise an explosion may occur.

When K_2TiF_6 is used in the same process, a Na excess of only 1% is used, to prevent the formation of too much K, which may cause ignition of the mixture upon opening of the tube.

The one great disadvantage of this process is the fact that removal of the fluorine from the product requires very long boiling with large quantities of water. Direct washing of the fluorine-containing reaction mass with hydrochloric acid is not feasible, since the alkali fluorides react with the acid to form hydrofluoric acid, which dissolves the titanium metal. On the other hand, boiling with water results in considerable oxidation: the Ti thus produced may contain more than 20% of the oxide. After the treatment with water, the metal is boiled a few times with aqueous sodium hydroxide and is then treated with cold, dilute hydrochloric acid (too much Ti goes into solution with warm acid).

III. PREPARATION OF CRUDE METAL FROM CHLORIDE AND SODIUM

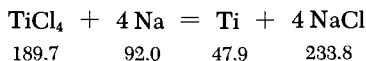

If the reagent quantities are small, the welded steel bomb described in method I can be used. The temperatures must be very high (to start the reaction, the bomb must be red-hot) and thus the TiCl_4 vapor pressure is very high. Larger quantities (500 g. of TiCl_4 + 245 g. of Na) must therefore be heated in a thick-wall steel bomb, the lid of which is sealed on with a copper gasket and secured with a heavy screwed-on cap.

The TiCl_4 pressure in the bomb can be kept low by one of two methods: *a*) the starting temperature of the reaction may be lowered by the addition of a tablet of $\text{KClO}_3\text{-Na}$; the small amount of oxygen introduced is not detrimental provided only crude metal is desired; *b*) the reaction tube may be constructed in such a way that there exists a temperature gradient and only the sodium is heated to 700-800°C.

If the amount of starting material is not too small, the heat of reaction developed in the process is sufficient to cause sintering of the metal; the heat may even be sufficient for partial melting of the charge. The product titanium is first washed with alcohol to remove the excess sodium, then with water to remove salts, and finally with dilute hydrochloric acid. After repeated washing with water, alcohol and ether, the metal is dried in a vacuum desiccator. Assuming the above-mentioned charge of 500 g. of TiCl_4 , the product consists of about 31.5 g. of half-fused metal and 4.5 g. of fine powder, as well as 71 g. of lumps and grains whose Ti content ranges between 96 and 99.5%. The powder fraction oxidizes quite readily.

This metal is much better suited as crude Ti for the refining process than the product obtained from the hexafluorotitanate.

In the industrial Degussa process, 46 kg. of Na is heated to 700-800°C. Then, 85 kg. of TiCl_4 is piped onto a layer of molten KCl/NaCl (15/15 kg.) situated below the Na. The resultant metal consists of 98% Ti and 2% Fe.

IV. KROLL MAGNESIUM PROCESS

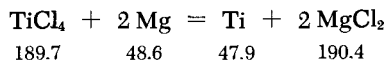

A) PREPARATION OF THE METAL

Magnesium works just as well in the reduction of TiCl_4 as sodium; in addition, commercial magnesium is already very pure and may be handled in air without special precautions. Thus, magnesium is the preferred reducing agent.

The reduction apparatus is shown in Fig. 290.

Since titanium attacks iron at high temperatures, the entire reaction zone of the crucible must be lined with a 1.5-mm.-thick sheet of molybdenum. Although molten Ti also adheres to molybdenum, the two metals can later be separated on a lathe. The TiCl_4 itself does not react at high temperatures with either Fe or Mo; the only precaution necessary is to keep all iron parts inside the furnace oxide-free.

The reaction crucible *b*, lined with molybdenum sheet *c*, is charged with 360 g. of very pure Mg blocks (the Mg metal surfaces are precleaned with a file). The adapter cover *e*, which carries the dropping funnel *m* and the Ca electrodes, is put in place and the entire system is evacuated to 0.1 mm. Very pure Ar is introduced, and an electric arc is struck and maintained for 10 min. between the two Ca electrodes *o*; the resultant Ca vapor serves as a scavenger for moisture and impurity gases. Final drying of the Ar is achieved by dropwise addition of a small quantity of TiCl_4 from the small dropping funnel *m*.

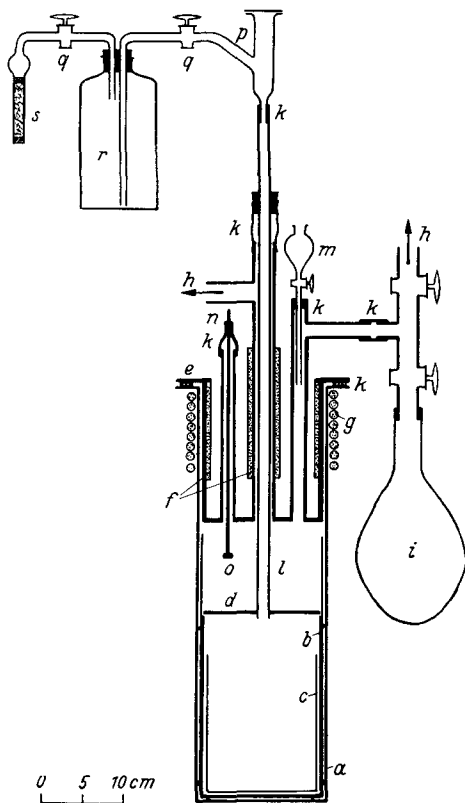

Fig. 290. Preparation of titanium metal from titanium (IV) chloride and magnesium. *a*) chrome-nickel alloy outer container (Inconel, Nichrome, or other similar alloys may be used); *b*) iron crucible; *c*) molybdenum lining; *d*) iron-plate lid; *e*) adapter cover; *f*) cooling chambers; *g*) cooling coils (lead); *h*) vacuum line; *i*) rubber balloon for Ar; *k*) rubber connections and seals; *l*) iron inlet tube for TiCl_4 ; *m*) dropping funnel with TiCl_4 ; *n*) electrodes; *o*) calcium rods; *p*) glass adapter for a sight glass; *q*) stopcocks; *r*) storage bottle with TiCl_4 ; *s*) CaCl_2 tube.

When the alloy container *g* reaches a temperature of about 700°C , 500 ml. of TiCl_4 is slowly added to the reaction chamber from the storage bottle *r*. The addition rate is such that it takes 1.5 hours to add all of the TiCl_4 . The temperature, which rises to about 1050°C , should be precisely controlled during the entire addition. The remaining 150 ml. of TiCl_4 is then added very slowly over a period of 0.5 hour, the temperature being gradually raised above the boiling point of Mg (to a maximum of 1180°C).

The molten Mg creeps over the surface of the nascent clumps of Ti, thus constantly contacting fresh TiCl_4 . In the process small quantities of Mg and MgCl_2 are occluded in the Ti; the final heating of the iron crucible to above the boiling point of Mg is intended to counteract this phenomenon.

The progress of the reaction may be observed through the quartz window set in adapter *p*. If the rate of addition of TiCl_4 is not precisely controlled, the inlet tube *l* may become plugged with Ti sponge.

After cooling in argon, the crucible is full of large clumps of light Ti metal embedded in white $MgCl_2$ crystals. The metal contains extremely finely divided Mg and $MgCl_2$; however, no Mg-Ti alloy is formed. This mass is removed from the crucible with the help of a lathe, cutting as far as the molybdenum lining; the pieces of Ti are held so firmly in the surrounding $MgCl_2$ that metal turnings can be produced without any difficulty. These are first very carefully leached with water, and are then treated with an excess of dilute HCl. Decantation yields about 1% of the product in colloidal form. The smaller turnings are wet-ground in a ball mill and worked up separately. They are unsuitable for the production of ductile Ti. The coarser pieces are crushed to 10-12 U. S. mesh size, and this coarse metal powder is rewashed, separated from the fines, and etched with hot hydrochloric acid (1:3) until the acid becomes deep violet. The acid treatment is necessary because the crushing operation oxidizes the surface of the metal particles (in contrast to the zirconium oxides, the titanium oxides can be removed by acid leaching). After another washing procedure, first in cold 5% hydrochloric acid and then in water, followed by drying, the powder is freed of Fe with a magnet, rescreened, washed with alcohol and dried at 120°C. The yield of Ti metal is 284 g. (95.9%).

Worner, as well as Wartmen et al., has modified the above procedure in several respects. They carry out the reaction in vacuum; however, this necessitates the use of a double-walled container. The addition of $TiCl_4$ is carried out much more rapidly (80% at 30-40 ml./min., the remainder at 10 ml./min.), so that 1500°C temperatures occur locally, and external heating may be stopped as early as five minutes after the start of the $TiCl_4$ addition. When the reaction is complete, heating at 900°C is continued for 45 minutes. The reaction product is not leached; $MgCl_2$ and unreacted Mg are partly removed by evaporation and partly by fusing and draining.

B) REMELTING OR RESINTERING OF THE METAL

The Ti sponge may be converted to solid metal by fusion in an arc furnace, in which either high vacuum or a pure argon (99.92%) atmosphere is employed; the other acceptable procedure is sintering with alternating pressing and heating in high vacuum (10^{-4} mm.) at 1000°C. The Ti powder may also be hot-rolled in air while contained in a welded steel container. In the last case, contamination with Fe is slight and the iron is easily removed by etching the ingot after unwinding the steel sheet. For further details, see the original references.

Assuming that the proper conditions are observed, the product metal is about 99.8% pure, and contains 0.06% Fe, 0.1% O, 0.02% N and 0.02% $MgCl_2$.

V. THE REFINING PROCESS OF VAN ARKEL AND DE BOER



555.6	47.9	507.7
-------	------	-------

a) The iodides are used for the preparation of small quantities (~20-30 g.) of metal; these highly hygroscopic compounds are not introduced directly as raw materials, but are produced as intermediates during the process in which they form from crude metal and iodine. The most suitable crude titanium for this process is that prepared from TiCl_4 and Na. Titanium oxide, nitride or carbide are attacked by the iodine; thus, the corresponding nonmetals are left unchanged and do not incorporate into the growing metal ingot. The weak point of this refining process is that a considerable number of other metals (e.g., Zr, Hf, Th, V, B, Si, as well as Al and Fe if the filament temperature is low) are codeposited with the desired titanium; therefore, these impurities should be removed during the preparation of the crude metal, that is, prior to refining.

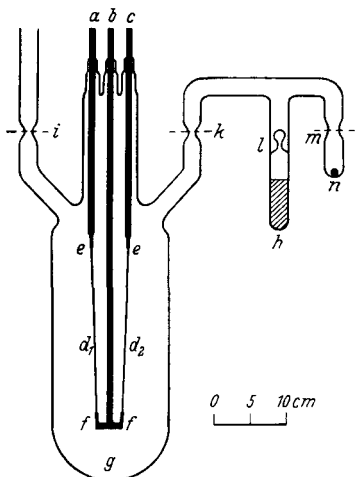

Fig. 291. Preparation of titanium metal by the process of van Arkel and de Boer. g) pyrex bulb; a, b, c) triangular arrangement of tungsten bus bars; d_1, d_2) tungsten wires; h) iodine storage flask; l) shatter valve; n) steel ball.

deposits on drawn tungsten core wires (d_1 and d_2), each 0.04 mm. thick and 400 mm. long.

These wires cannot just simply be stretched directly between the electrodes, as would appear from the drawing. If this were done, the rapid rate of heat conduction through the tungsten rods could cause excessive cooling of the wire ends and consequently prevent the titanium from depositing at the cold spots. This would result in nonuniform deposition, that is, preferential accumulation of the metal on the glowing sections, which would thus become heavier and unbalance the entire wire. Consequently, after a certain time has elapsed, the slightest mechanical shock would be sufficient to break the thin wires and interrupt electrical

contact. The critical spots *e* and *f* should therefore be strengthened by insertion of reducer pieces made of progressively thinner tungsten wires. The simplest arrangement consists of a 1-mm.-thick wire ring fixed in a slit in the bus bar; this ring, in turn, is fitted with a drilled 0.2-mm. ring to which the glowing wire is attached.

Crude Ti (40 g.) is placed in *g* and 12 g. of I_2 in evacuated space *h*. The flask is evacuated to $<10^{-3}$ mm. and the metal is degassed by heating to about 500°C . At the same time, the entire glass part of the apparatus (except for the iodine tube) is dried and degassed by fanning with a flame while the reduced pressure is maintained. As soon as a sufficiently high vacuum has been restored, a predetermined starting current (about 0.25 amp.) is applied to the tungsten wires to bring them to a "black body temperature" of 1400°C , as measured by an optical pyrometer. The system is cooled and sealed at *i*, the thin glass partition *l* is broken by means of an electromagnet and steel ball *n*, and the I_2 from *h* is allowed to flow into *g*. A temperature of 200°C is sufficient for a rapid reaction of the iodine with a portion of the Ti, a reaction sometimes even accompanied by the appearance of a flame. Following this the apparatus is melt-sealed at *k* and heated to 550°C in a furnace; the tungsten wire *d*₁ is then brought to a glow at the same current as above. The apparent temperature read on the pyrometer is now lower because of the colored vapors rising from the material. This temperature must be held constant during the entire subsequent procedure (by increasing the current as the thickness of the deposited Ti layer increases).

The equilibria prevailing in the system are highly temperature-dependent. Furnace temperatures below 250°C produce TiI_4 , which then decomposes on the hot wire in accordance with the above equation. At higher temperatures, TiI_4 reacts with the crude Ti to form TiI_2 , which has a considerably lower vapor pressure. Only at temperatures above 500°C does this pressure become large enough to again produce titanium deposition on the glowing wire. The Ti metal formed at higher temperatures is so free of iron that the latter cannot even be detected.

Gases which may still be present in the flask during the refining of the Ti are bound by the metal (thus, a small amount of nitride is often formed). For this reason, the current to the first wire is shut off after a certain time and that to the second wire, *d*₂, is turned on; the Ti metal which then deposits on *d*₂ is completely pure. Because of the gradual build-up of titanium, the current must be raised up to 200 amp. when the ingot reaches a thickness of about 5 mm. This requires about 24 hours; if the starting material is the crude Ti obtained from the hexafluorotitanate, the build-up rate is lower.

The current to the furnace can be gradually reduced to zero in the course of the run, since the growing Ti rod begins to radiate

enough heat to maintain the required temperature throughout the system (toward the end of the run, it may even be necessary to cool the furnace space with air).

If the crude metal used in the refining process is prepared from pure starting materials, the resultant smooth Ti rod is almost completely pure, since the tungsten wire substratum constitutes only about 0.01% of the rod. The metal has about the same ductility as Cu, and may therefore be cold-worked and rolled.

The following method is well suited for the conversion of a piece of ductile titanium (it applies also to Zr or Hf) to powder: Ti is treated at 600°C in a stream of H₂. The gas must be extremely pure (see p. 111 ff.). The resultant hydride is brittle and easily ground to a powder. The H₂ may then be removed by heating in high vacuum at 1000°C.

b) This method has recently been used in the U.S. to prepare 700-g. quantities of Ti. The operation is carried out in Pyrex containers 900 mm. long and 200 mm. in diameter, but metal tubes have also been used with great success. For a given size of tube, the metal tubes are much easier to handle and simpler to cool. They contribute to the safety of the operation since an oil bath can then be used. The crude Ti is not placed at the bottom of the tubular vessel but is held in a layer 10-15 mm. thick at the walls by means of a cylinder of perforated Mo sheet. With this arrangement, it is also possible to dispense with the additional furnace heating. The glowing wires, in the form of hairpins, are hung from three tungsten rods; if one wire burns out, two more are still available. Titanium prepared in this manner contains 0.03% C, 0.003% N, 0.002% O, 0.04% Si, 0.04% Fe, 0.05% Al and 0.002% S.

VI. PREPARATION BY ELECTROLYSIS OF MELTS

Because of its high melting point, the Ti formed by electrolysis deposits on the cathode in the form of a solid cluster impregnated with the melt. The presence of even minute traces of moisture or oxygen causes the deposition of a finely crystalline material with a high salt content; suitable operating techniques, however, make it possible to obtain large crystals of pure metal.

a) Crude titanium may be obtained by electrolysis of a solution of TiO or mixed TiO-TiC crystals in a CaCl₂ melt at 700-850°C.

b) The electrolytic decomposition of K₂TiF₆ in a bath of NaCl, on the other hand, yields a very pure, coarsely crystalline metal. In this process the melt becomes enriched in NaF, according to the overall equation



while chlorine is evolved on the anode.

c) Another process uses an electrolysis cell in which the cathode chamber is separated from the anode by a diaphragm of sintered alumina; TiCl_4 vapor is introduced into a melt of alkali metal chloride or alkaline earth chloride in the cathode chamber. The resultant dissolved lower chlorotitanates decompose to the metal at a later stage of the electrolysis.

d) Metal of very high purity may be recovered from crude titanium or titanium waste by anodic solution of the starting material in a melt of alkali metal chloride containing a small amount of lower titanium chlorides, and reprecipitation of the Ti at the cathode.

VII. REDUCTION OF TiO_2 WITH CaH_2

A mixture of TiO_2 and CaH_2 (in 40% excess) is heated for one hour in hydrogen at atmospheric pressure (electric furnace, 950-1075°C); the product is treated with dilute hydrochloric acid. A fine powder, with a metal content of 96%, is obtained; the remainder is mainly H_2 (3%). This process is also suitable for preparation of V, Nb and Ta from their oxides.

PROPERTIES:

Silvery white, ductile metal. M.p. 1730°C; d 4.45. Crystal type A3. Hexagonal α -Ti converts at 885°C to the body-centered cubic form (β -Ti). Electrical resistivity $\rho = 42 \cdot 10^{-6} \Omega \cdot \text{cm}$.

Scarcely or not at all attacked by acids and bases; dissolves readily in hydrofluoric acid.

REFERENCES:

- General: A. E. van Arkel. *Reine Metalle [Pure Metals]*, Berlin, 1939, p. 181; see also H. Funk. *Die Darstellung der Metalle im Laboratorium [Preparation of Metals in the Laboratory]*, Stuttgart, 1938, p. 40; H. Grubitsch. *Anorganisch-präparative Chemie [Preparative Inorganic Chemistry]*, Vienna, 1950, p. 411.
- I. E. Wedekind. *Liebigs Ann.* **395**, 149 (1913); O. Ruff and H. Brintzinger. *Z. anorg. allg. Chem.* **129**, 267 (1923); W. Kroll. *Z. anorg. allg. Chem.* **234**, 42 (1937); P. Ehrlich. Unpublished experiments.
- II. L. Weiss and H. Kaiser. *Z. anorg. Chem.* **65**, 345 (1910); J. D. Fast. *Z. anorg. allg. Chem.* **241**, 42 (1939).
- III. L. F. Nilson and O. Pettersson. *Z. phys. Chem.* **1**, 27 (1887); M. A. Hunter. *J. Amer. Chem. Soc.* **32**, 330 (1910); D. Lely and L. Hamburger. *Z. anorg. Chem.* **87**, 209 (1914); E. Podszus. *Z. anorg. allg. Chem.* **99**, 123 (1917); A. Sieverts

- et al. *Z. phys. Chem.* 145, 227 (1929); *Z. anorg. allg. Chem.* 199, 384 (1931); W. Kroll. *Metallwirtschaft* 9, 1043 (1930); J. D. Fast. *Z. anorg. allg. Chem.* 241, 42 (1939).
- IVa. W. Kroll. *Trans. Electrochem. Soc.* 78, 161 (1940); H. W. Worner. *Metallurgia* 40, 69 (1949); F. S. Wartman. *Metal Progress* 55, 188 (1949).
- IVb. W. Kroll. *Trans. Electrochem. Soc.* 78, 161 (1940); R. S. Dean, J. R. Long, F. S. Wartman and E. T. Hayes. *Amer. Inst. Min. Met. Eng. Techn. Publ. No.* 1965 (1946); O. W. Simmons, C. T. Greenidge and L. W. Eastwood. *Metal Progress* 55, 197 (1949); H. W. Worner. *Metallurgia* 40, 69 (1949); J. R. Long. *Metal Progress* 55, 191 (1949).
- Va. A. E. van Arkel and J. H. de Boer. *Z. anorg. allg. Chem.* 148, 345 (1925); J. D. Fast. *Z. anorg. allg. Chem.* 241, 42 (1939).
- Vb. J. E. Campbell, R. I. Jaffee, J. M. Blocher, J. Gurland and B. W. Gonser. *Trans. Electrochem. Soc.* 93, 271 (1948); B. W. Gonser. *Metal Progress* 55, 193 (1949); F. B. Litton and B. W. Gonser. *Metal Progress* 55, 346 (1949).
- VIa. M. A. Steinberg, M. E. Sibert, Q. H. McKenna and E. Wainer. *J. Electrochem. Soc.* 102, 252 (1955).
- VIb. M. E. Sibert and M. A. Steinberg. *J. Electrochem. Soc.* 102, 641 (1955); J. G. Wurm, L. Gravel and R. J. A. Potvin. *J. Electrochem. Soc.* 104, 301 (1957).
- VIc. M. B. Alpert, F. J. Schultz and W. F. Sullivan. *J. Electrochem. Soc.* 104, 555 (1957).
- VI d. R. S. Dean. *Metal Industry* 90, 143 (1957); H. Kühnl, P. Ehrlich and R. D. Uihlein. *Z. anorg. allg. Chem.* 306, 246 (1960).
- VII. G. A. Meyerson, G. A. Kats and A. V. Khokhlova. *Zh. Prikl. Khim.* 13, 1770 (1940); see also P. P. Alexander. *Metals and Alloys* 9, 45 (1938).

Zirconium, Hafnium

Zr, Hf

The general remarks concerning titanium apply equally well to zirconium and hafnium. These elements are thus prepared via the same methods and generally in the same equipment as described in detail in the section on titanium. In the following, we shall discuss only those details that differ from the above. Where Hf is not discussed separately, the conditions specified for Zr apply.

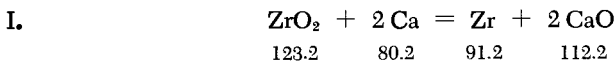

Crude starting Zr for the refining process is prepared via the sealed bomb method, with corresponding changes in the amounts of materials used, chiefly the addition of Na, which is

highly recommended for the reduction of ZrO_2 (e.g., 20 g. of ZrO_2 + 20 g. of Ca + 10 g. of Na); heating to $1300^\circ C$ produces a metal still containing oxygen. Although this causes cold-shortness, the metal becomes malleable somewhat above $200^\circ C$.

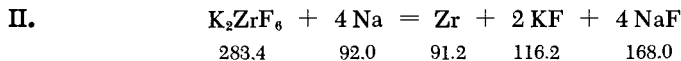

Crystalline K_2ZrF_6 (60 g.), prepared by cooling a heated solution of the hydroxide in KHF_2 , is heated with 27.5 g. of Na in a sealed bomb at 1200 - $1300^\circ C$. The resultant 18 g. of crude metal is a suitable material for the refining process.

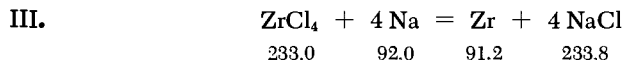

Up to 1 kg. of sublimed $ZrCl_4$, crushed to lumps, and 450 g. of distilled Na may be reacted in one run in a sealed steel tube at $850^\circ C$. The bottom of the tube is charged with a layer of Na; this is followed by the reaction mixture ($ZrCl_4$ + Na), topped with a layer of Na. Since the vapor pressure of $ZrCl_4$ is considerably lower than that of $TiCl_4$, the processing of larger quantities is simpler. The heat evolved in the reaction is so large that partial sintering of the metal occurs.

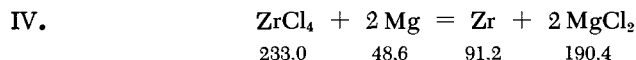

As in the magnesium process for Ti, Zr may be prepared by reduction of $ZrCl_4$ vapor with Mg in a helium atmosphere (see references below for further details).



The glowing wire temperatures during refining should be $\sim 1400^\circ C$ in the case of Zr and $\sim 1600^\circ C$ in the case of Hf. The Pyrex vessel must be kept at $600^\circ C$. The crude metal obtained from the chloride is the most suitable raw material. Recently Zr has been prepared in large glass vessels in the form of rods weighing up to 200 g.

PROPERTIES:

Silvery white, ductile metals.

	Formula weight	M.p.	d	α (close-packed hexag.) $\rightarrow \beta$ (bcc.)	Resistivity
Zr	91.22	$1860^\circ C$	6.50	$870^\circ C$	$41 \cdot 10^{-6} \Omega \cdot \text{cm.}$
Hf	178.6	$2230^\circ C$	13.3	$\sim 1500^\circ C$	$30 \cdot 10^{-6} \Omega \cdot \text{cm.}$

Scarcely or not at all attacked by acids and bases; dissolve readily in hydrofluoric acid. For the pulverization of solid metals via hydrogenation and dehydrogenation (hydrides), see pp. 1170 and 1184.

REFERENCES:

- General: A. E. van Arkel. *Reine Metalle* [Pure Metals], Berlin, 1939, p. 191 (Zr) and p. 207 (Hf); see also H. Funk. *Die Darstellung der Metalle im Laboratorium* [Preparation of Metals in the Laboratory], Stuttgart, 1938, p. 43; H. Grubitsch. *Anorganisch-präparative Chemie* [Preparative Inorganic Chemistry], Vienna, 1950, p. 411.
- I. E. Wedekind. *Liebigs Ann.* 395, 149 (1913); J. W. Marden and M. N. Rich. *Ind. Eng. Chem.* 12, 653 (1920); O. Ruff and H. Brintzinger. *Z. anorg. allg. Chem.* 129, 267 (1923); H. J. de Boer and J. D. Fast. *Z. anorg. allg. Chem.* 187, 177 (1930); W. Kroll. *Z. anorg. allg. Chem.* 234, 42 (1937).
- II. L. Weiss and E. Neumann. *Z. anorg. Chem.* 65, 248 (1910); E. Wedekind and S. J. Lewis. *Liebigs Ann.* 395, 181, 193 (1913); J. H. de Boer and J. D. Fast. *Z. anorg. allg. Chem.* 187, 177 (1930).
- III. (Zr) D. Lely and L. Hamburger. *Z. anorg. Chem.* 87, 209 (1914); J. H. de Boer and J. D. Fast. *Z. anorg. allg. Chem.* 187, 177 (1930).
(Hf) J. H. de Boer and J. D. Fast. *Z. anorg. allg. Chem.* 187, 193 (1930).
- IV. H. van Zeppelin. *Metall u. Erz* 40, 252 (1943); W. J. Kroll, A. W. Schlechten and L. A. Yerkes. *Trans. Electrochem. Soc.* 89, 263 (1946); W. J. Kroll et al. *Trans. Electrochem. Soc.* 92, 187 (1947); W. J. Kroll et al. *Trans. Electrochem. Soc.* 94, 1 (1948).
- V. (Zr) A. E. van Arkel and J. H. de Boer. *Z. anorg. allg. Chem.* 148, 345 (1925); J. H. de Boer and J. D. Fast. *Z. anorg. allg. Chem.* 153, 1 (1926); J. H. de Boer and J. D. Fast. *Z. anorg. allg. Chem.* 187, 177 (1930); J. D. Fast. *Z. anorg. allg. Chem.* 239, 145 (1938); J. D. Fast. *Osterr. Chemiker-Ztg.* 43, 27, 48 (1940).
(Hf) J. H. de Boer and J. D. Fast. *Z. anorg. allg. Chem.* 187, 193 (1930); see also A. E. van Arkel. *Metallwirtschaft* 13, 405, 511 (1934).

Thorium

Th

Despite the close resemblance in chemical behavior of the metals and their compounds, thorium differs from titanium, zirconium and hafnium in one respect, and that makes the preparation of

the metal much easier. Thus, although the affinity of thorium metal for O, N and C is large, its cubic face-centered lattice cannot accommodate these nonmetals in solid solutions. The result is that, even on incomplete purification, these nonmetals are present only in the form of compounds and in small quantities; they have thus little effect on, for example, the mechanical properties of the metal. For this reason Th may be obtained in a cold-workable form by pressing and sintering the powder.

In contrast to titanium and zirconium, the preparation of thorium metal via reduction of the oxide with calcium (method II) acquires increased importance and rivals the reduction of the tetrachloride with sodium (method I). Melt electrolysis (method III) is another possibility. Neglecting the small oxide content (up to 1%), which in any case has never been determined precisely, the metal obtained by any of the three methods is already quite pure and contains only 0.1-0.2% of other impurities. The Th prepared by the refining process (method IV), is definitely oxygen-free and should in any case yield the purest product.

I. REDUCTION OF THE TETRACHLORIDE WITH SODIUM

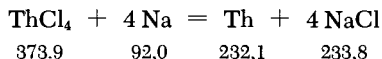

Up to 300 g. of oxychloride-free sublimed ThCl_4 may be reacted at 500°C with vacuum-distilled Na (25% excess) in a welded iron bomb (see method I, section on titanium). The iron crucible should be filled with the reaction mixture in the same way as in the reaction between ZrCl_4 and Na, that is, layer by layer. Following the reaction, the bomb is completely cooled, opened and the reaction product treated, first with alcohol (to remove the excess Na), then with water (always maintaining the solution on the alkaline side). After complete removal of the chlorine, the residue is treated with 2N HNO_3 to dissolve any $\text{Th}(\text{OH})_4$ which may be present, filtered with suction, thoroughly washed with water, alcohol and ether, and dried in vacuum at 300°C . The metal yield is 55%, in the form of lead-gray platelets and pellets. The coarsest particles are also the purest and contain 0.1% O (1% ThO_2).

II. REDUCTION OF THE OXIDE WITH CALCIUM

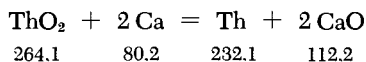

A) PREPARATIVE PROCESS

The process is based on the reduction of very pure ThO_2 with distilled Ca in the presence of anhydrous CaCl_2 heated to 450°C .

The CaCl_2 melts at the temperature of the reaction, affording a liquid reaction medium. The heavy Th product settles to the bottom and is thus protected by a layer of melt. The apparatus is either a steel bomb capped with a threaded conical lid (cf. the paper of Marden and Rentschler) or the simpler welded steel tube described under method I for the preparation of Ti. The charge, which is made up of four parts of ThO_2 , four parts of CaCl_2 and three parts of ground Ca, is vigorously shaken in a closed bottle to achieve the most complete mixing possible. The bomb is filled rapidly, sealed and heated for one hour at 950°C . The tube is then cooled and opened; the resultant pea-sized reaction product is gradually added to water (about two liters per 40 g. of starting ThO_2) with vigorous stirring to prevent a local temperature rise. After the calcium has completely reacted with the water and the evolution of gas ceases, stirring is stopped, the supernatant liquid is decanted, and the solid is washed four times with two-liter portions of water, vigorously shaking each time for 5-10 minutes. The decanted supernatants are low-concentration suspensions of dark, fine Th. Finally, 200 ml. of water is added to the remaining heavy residue, followed by 25 ml. of conc. nitric acid (vigorous stirring). The odor of acetylene is noticeable, and if the ThO_2 used in the preparation was made from thorium nitrate which contained some sulfate, the odor of H_2S will also be present. After 10 minutes, the solution is diluted tenfold, the product is allowed to settle, the supernatant is decanted, and the acid treatment is repeated once or twice. After thorough washing with water (twice, two liters each time), the product is suction-filtered, treated with alcohol and ether, and dried in vacuum at 300°C . Under favorable conditions, the relatively coarse, dark gray powder is obtained in 90% yield.

Kroll uses the same process with a suitable salt melt. However, instead of working in a sealed bomb, he uses an iron crucible placed in an argon atmosphere.

B) MELTING OF Th POWDER

Small, relatively compact cylinders are formed from thorium powder under a pressure of 6-7 tons/cm². Crucibles of sintered thoria are suitable melt containers. The cylinder, wrapped in a tungsten wire spiral, is placed inside such a crucible which is set up in a quartz container connected to a high-vacuum pump. The material is heated with a high-frequency induction coil.

The apparatus is evacuated and the sample carefully degassed by slow heating while the vacuum is maintained. With coarse metal powder, this operation requires about half an hour, and longer with fine powders; the reaction is essentially complete when the powder reaches red heat. The temperature is then rapidly

increased to melt the metal. Oxidation is prevented if air is excluded from the system until after complete cooling.

Thorium powder with a completely clean surface is noteworthy for its sensitivity to air after high-vacuum degassing at 400°C. This sensitivity is so pronounced that the metal catches fire on coming in contact with air. The material also reacts so vigorously with H₂ that it becomes red hot.

III. ELECTROLYSIS

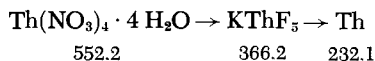

The electrolysis of a solution of KThF₅ in a NaCl-KCl melt yields very pure metal, containing only 0.02% C, 0.05% Si, 0.005% Fe and a negligible amount of other impurities.

The KThF₅ is prepared by dissolving 400 g. of Th(NO₃)₄ · 4 H₂O in two liters of water and adding, with constant stirring, a solution of 250 g. of KF in 400 ml. of water. The KThF₅ precipitate is allowed to settle, washed by decantation until the washings are free of nitrate, suction-filtered and dried for several hours at 125°C.

A cylindrical graphite crucible serves both as the electrolysis vessel and as anode. The inside diameter is 6 cm. and the height 15 cm., with a wall thickness of 1-2 cm. Current is supplied through a strip of Ni sheet wrapped around the upper part of the outside wall. The cathode is a strip of Mo sheet 0.05 mm. thick and 1 cm. wide, which reaches 2.5 cm. from the bottom. The graphite cell stands in a suitable refractory container wound with the heating filament. The entire apparatus is placed inside a sheet-metal vessel filled with thermal insulation (see also the similar arrangement described for the electrolysis of uranium).

A mixture of 250 g. each of KCl and NaCl is melted, and 30 g. of KThF₅ is added. When the melt is homogeneous, electrolysis proceeds, with the above Mo cathode, at a temperature of 775°C. A current of 18-20 amp. is required if the submerged cathode surface area is about 20 cm². After 20 minutes the cathode is carefully removed from the liquid and replaced with a new piece of Mo, 30 g. of KThF₅ is added, and the electrolysis is continued for 20 minutes more. This procedure may be repeated several times.

For preparations on a somewhat larger scale, a larger crucible, capable of containing about 1 kg. of the melt, and a molybdenum cathode 2.5 cm. wide are used. The procedure is the same, except that the KThF₅ additions are increased to 60 g., the current to 45 amp., and the cathode area to 50 cm². Eightfold repetition of the operation in this larger equipment permits the preparation of about 130-140 g. of Th (58% yield).

The material adhering to the cathode strip is a mixture of metallic Th and solidified melt. After complete cooling, the salt and the finely powdered, readily oxidized metal fraction are removed by treatment with water. The residual coarse-grained Th is treated three times with nitric acid (1:10) and washed with water. This metal powder is then suction-filtered, washed with alcohol and ether, and dried in vacuum at 300°C.

IV. REFINING PROCESS

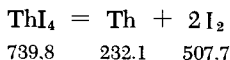

The thorium metal prepared by the above process is very pure and absolutely free of oxygen. The procedure is essentially the same as that described for Ti, except that the temperature of the glowing wire is higher (1700°C). The starting material may be any kind of crude thorium, provided it is free of metals which will also deposit on the glowing wire; the product derived from the chloride is very suitable.

PROPERTIES:

Gray powder, solid similar to platinum. Relatively soft and ductile; these properties are unaffected by the presence of small quantities of oxide. M.p. 1830°C; d 11.7. Crystal structure: type A1.

Hardly or not at all attacked by dilute acids (including hydrofluoric); dissolves readily in fuming hydrochloric acid and especially in aqua regia. Resistant to strong bases.

Thorium powder may be prepared from the solid via the hydride. The procedure is identical to that described on p. 1170 for Ti and Zr; the hydride should be decomposed above 700°C.

REFERENCES:

General: H. Funk. *Die Darstellung der Metalle im Laboratorium* [Preparation of Metals in the Laboratory], Stuttgart, 1938, p. 48; A. E. van Arkel. *Reine Metalle* [Pure Metals], Berlin, 1939, p. 212; P. Chiotti and B. A. Rogers. *Metal Progress* 60, 60 (1951).

- I. D. Lely and L. Hamburger. *Z. anorg. Chem.* 87, 209 (1914); see also references III for Ti and Zr.
- II. J. W. Marden and H. C. Rentschler. *Ind. Eng. Chem.* 19, 97 (1927); W. Kroll. *Z. Metallkunde* 28, 30 (1936); see also O. Ruff and H. Brintzinger. *Z. anorg. allg. Chem.* 129, 267 (1923).
- III. F. H. Driggs and W. C. Lilliendahl. *Ind. Eng. Chem.* 22, 1302 (1930).

- IV. A. E. van Arkel and J. H. de Boer. *Z. anorg. allg. Chem.* 148, 345 (1925); N. D. Veigel, E. M. Sherwood and I. E. Campbell. *J. Electrochem. Soc.* 102, 687 (1955).

Separation of Zirconium and Hafnium

Hafnium does not occur as a separate mineral, but appears in nature as the always present companion of Zr; the Hf/Zr weight ratio is usually in the range of 0.01-0.025. The preparation of Hf or the purification of Zr thus always involves the isolation of Hf from the crude chlorination product or from commercial Zr compounds. The following fractionation processes are of practical importance:

- | | |
|--------------------|-----------------------------------|
| I. Crystallization | IV. Ion exchange and adsorption |
| II. Precipitation | V. Partition between two solvents |
| III. Distillation | |

I. CRYSTALLIZATION

This method, which is unwieldy and applicable only to the separation of very small quantities of material, has been abandoned for all practical purposes.

II. PRECIPITATION

Good separation is obtained by precipitation of the phosphates; the hafnium concentrates in the less soluble fractions. A detailed description of the recovery of Hf from cyrtolite, a silicate of very high Hf content (5.5% HfO₂), is given in E. M. Larsen, W. C. Fernelius and L. L. Quill in: L. F. Audrieth, *Inorg. Syntheses*, Vol. III, New York-Toronto-London, 1950, p. 67.

III. DISTILLATION

Since the vapor pressures of ZrCl₄ and HfCl₄ are virtually the same, the process makes use of their adducts with PCl₅ or POCl₃. When a 50-plate glass column is used, the more volatile Hf compound concentrates in the first distillation fraction (5% of the total; 2.5% to 16% HfO₂); the residue remaining after distillation of 40% of the total feed contains only 0.2% HfO₂.

This process seems to have recently assumed a greater industrial importance.

IV. ION EXCHANGE AND ADSORPTION

This process, which was introduced in 1948 by Street and Seaborg for the separation of milligram quantities of Hf and Zr,

becomes important in preparative work only when the small Hf fraction, and not the predominant Zr, may be retained on the column. This is achieved by selective elution of the Zr with 1N H_2SO_4 (which involves the formation of an anionic complex) from a column of synthetic cation exchange resin (method *a*) or by selective adsorption of Hf on silica gel from an anhydrous methanolic solution of the tetrachlorides (method *b*). Although the latter process permits larger throughputs and shorter residence times, work with anhydrous methanol involves difficulties, and the further treatment of the eluate is more troublesome. Method *b* becomes applicable chiefly in those cases when one is forced to deal with tetrachlorides, for example, when the latter are precipitated by chlorination of minerals.

a) Dowex 50 or Zeocarb 225 (350 g., with a particle size of 0.5 mm.) is treated with water for several days and then placed in a tube 120 cm. long and 2.5 cm. in diameter. A solution of 20 g. of $\text{ZrO}(\text{NO}_3)_2 \cdot 2\text{H}_2\text{O}$ in one liter of 2N HNO_3 is passed very slowly through the column. (If the nitrate is not available, 24 g. of $\text{ZrOCl}_2 \cdot 8\text{H}_2\text{O}$ is precipitated as the hydroxide, washed thoroughly, and dissolved in one liter of 2N HNO_3 .) The material adsorbed on the column is eluted with 1N H_2SO_4 (flow rate of 100 ml./hr.). The Hf concentrate begins to appear when 95-98% of the Zr has been recovered (passage of about nine liters of the acid); the HfO_2 content in the Zr salt eluted prior to this point is less than 0.01%.

[For faster throughput rates, one can use the "breakthrough method," in which the initial adsorption on the resin is omitted; the resultant separation is, however, poorer. One proceeds as follows: a solution of 2.5 g. of $\text{ZrO}(\text{NO}_3)_2 \cdot 2\text{H}_2\text{O}$ per liter of 1N H_2SO_4 is passed through the above column at a rate of about 200 ml./hr. Before the "breakthrough point" is reached (after the passage of about nine liters), the solution leaving the column contains mainly Zr and a small amount of Hf, whose concentration in the Zr slowly increases to 0.1%. If only seven liters is collected, the product recovered from the solution consists, for example, of 8.2 g. of oxide containing 0.047% of HfO_2 .]

After removal of the Zr, the Hf adsorbed on the column is eluted with stronger sulfuric acid (>1.2N); a solution of 0.05 moles of oxalic acid in one liter of 2N H_2SO_4 is an especially good eluent. Thus 63 mg. of Zr-free HfO_2 may be obtained in a 30-g. column, starting from 70 mg. of HfO_2 containing 8% ZrO_2 ; the material is passed through the ion-exchange column in the form of a solution of $\text{HfOCl}_2 \cdot 8\text{H}_2\text{O}$ in 675 ml. of 1N H_2SO_4 .

b) Silica gel (1000 g.) with a specific area of 720 m.²/g. is purified by treatment with nitric acid (1:1) and washing with water, activated by heating for four hours at 300°C, and suspended in dry methanol; this suspension is placed in a tube 120 cm. long

and 5.0 cm. in diameter. The column then contains about 700 ml. of methanol.

Zirconium tetrachloride (400 g., equivalent to 210 g. of ZrO_2), with a Hf/Zr weight ratio of approximately 0.02, is dissolved in two liters of anhydrous methanol; the solution is allowed to stand for three hours and is then filtered. The filtrate advances through the column at an average rate of 20 cm./hr. (400 ml./hr.).

[The highest separation is achieved during the initial stages, as the following data illustrate:

Cumulative throughput, in g. ZrO_2 /g. silica gel	0.05	0.1	0.2	0.25
% Hf in Zr leaving the column	0.05	0.1	0.35	0.6

Thus, one can collect an eluate containing 140 g. of ZrO_2 (equivalent to 265 g. of $ZrCl_4$) with a total Hf concentration of less than 0.1%.

Oddly, much better results are obtained when the operation is conducted on a larger scale. Thus a column 10 cm. in diameter and 150 cm. long charged with 8 kg. of silica gel yields, at correspondingly higher throughputs but otherwise unchanged operating conditions, 1.6 kg. of Hf-free $ZrCl_4$.]

At the point when only about 200 g. of $ZrCl_4$ (equivalent to 100 g. of total oxide) remains in the column, the HfO_2 concentration in this residue becomes 10%. Further concentration is attained by elution of the column with a solution of 2.5 moles of HCl/liter of methanol (preferential desorption of the $ZrCl_4$). Depending on the duration of this treatment, the final elution with 7N H_2SO_4 yields, for example, 60% of the absorbed Hf as a 30% product, or 20% of the metal as a 60% product. These concentrates constitute a very suitable starting material for the extraction process described below.

The silica gel may be reused after reactivation.

V. PARTITION BETWEEN TWO SOLVENTS

The process is based on the preferential ether extraction of Hf from aqueous thiocyanate-containing solutions of Zr and Hf. Addition of acids or salts alters the equilibrium. Thus the presence of ether-insoluble sulfate ions shifts the distribution of Zr and Hf in favor of the aqueous phase, while the addition of acid or NH_4SCN achieves the opposite effect. Since no separation can be achieved by a single-stage extraction, a multistage process must be used. The process is designed to achieve maximum separation by combining the above factors, i.e., by varying the additives in the initial and final stages. Hydrolytic reactions have also been used to advantage in this separation. The following procedure has proven effective for the processing of a raw material containing ~20% HfO_2 .

The ether phase, which is 1N in HSCN, is prepared by shaking one liter of ether with an acidified solution of NH_4SCN (90 g. of NH_4SCN + 1/2 mole of H_2SO_4); the sulfuric acid is added in small portions during the shaking. A mixed oxide $\text{Zr}(\text{Hf})\text{O}_2$, calcined at not too high a temperature, yields on evaporation with conc. H_2SO_4 a product of the approximate composition 1 ZrO_2 :2 SO_3 . This product, in a concentration of 40-50 g. of oxide/liter of H_2O , is used as the starting material.

One liter of this freshly prepared solution (do not heat to dissolve) is treated with 600 g. of NH_4SCN and vigorously shaken for one minute with one liter of the above ether preparation. After standing for five minutes, the ether layer is siphoned off and transferred to the next stages of the process, where it is treated with solutions of the following composition:

Stage No.	2	3	4	...
$(\text{NH}_4)_2\text{SO}_4$ (g.)	80	80	80	...
$(\text{NH}_4)\text{SCN}$ (g.)	50	25	0	...
H_2O (ml.)	500	500	500	...

The initial extraction is repeated ten times, each time with a new batch of the ether-HSCN phase. Each of the resultant ether extracts (fractions 2-10) is then passed through all the successive stages of the process. The aqueous solutions in each stage are, of course, used over and over again; that is, the new ether fraction is treated with the thiocyanate solution remaining in that stage from the extraction of the previous ether fraction. However, it is recommended that the NH_4SCN concentration in the aqueous solutions of stages 2 and 3 be gradually increased (always retaining the thiocyanate gradient shown in the table) and that thiocyanate be gradually added to the succeeding stages. The solution of the last stage must, however, always consist of 80 g. of $(\text{NH}_4)_2\text{SO}_4$ in 500 ml. of water, so that the ether leaving the system is always washed free of Zr and Hf. Thus, new last stages must be continually added to the series. When the thiocyanate concentration in the aqueous solution of stage 2 reaches twice the level shown in the table, this solution is "retired"; the solution from stage 3 becomes that of stage 2, the solution from stage 4 is shifted to stage 3, and so on down the line. A new thiocyanate-free aqueous stage is then added at the end of the series.

The Hf + Zr concentration and the Hf/Zr ratio must constantly be checked in each stage, since the separation depends on a large number of interdependent factors. Thus, the temperature greatly affects the partition coefficients, an effect which can be compensated for by changes in the volumetric ratios between the phases or by addition of salts.

Some hydrolysis may occur in stage 1; it is recognizable by the appearance of heavy turbidity or precipitation in the aqueous layer, and may necessitate an intermediate treatment (precipitation with ammonia, followed by solution of the precipitate with H_2SO_4).

As has been emphasized before, the process is particularly effective with partially concentrated hafnium products, as shown by the following data. Starting from 40 g. of a product with a HfO_2 concentration of 18%, the aqueous layers of the various stages, after shaking with 10 liters of ether, contained the following proportions of HfO_2 :

	1	2	3	4	5	6
Oxide (g.)	28	~4	~5	2	0.6	0.2
HfO_2 (%)	~7	~20	>45	>40	>50	>70

The corresponding figures obtained from a starting material containing 50% HfO_2 were:

HfO_2 (%)	25	~50	~80	~99	>99
-------------	----	-----	-----	-----	-----

Alternate methods: a) U.S. authors have used processes involving fractional extraction of the aqueous phase with benzene solutions of diketones [thenoyl trifluoroacetone: E. H. Huffman and L. J. Beaufait, *J. Amer. Chem. Soc.* **71**, 3179 (1949); trifluoroacetylacetone: B. G. Schultz and E. M. Larsen, *J. Amer. Chem. Soc.* **72**, 3610 (1950)]. One disadvantage of the thenoyl trifluoroacetone process may be that the Zr, which is usually the major component, is preferentially extracted into the benzene phase.

b) A process in which aqueous solutions of the chlorides are countercurrently extracted with methyl isobutyl ketone in the presence of thiocyanates and thiocyanic acid has attained industrial importance [W. Fischer, H. Heitsch and G. Otto, German Patent 1,010,061, Oct. 18, 1955; *Nuclear Sci. Abstr.* **10**, 371 (1956)].

c) The nitrates of Zr and Hf can be selectively partitioned between aqueous nitric acid and organic solvents, particularly tributyl phosphate and ketones, the Zr being preferentially extracted into the organic phase [R. P. Cox, H. C. Peterson and G. H. Beyer, *Ind. Eng. Chem.* **50**, 141 (1958); *Chemie f. Labor und Betrieb*, August 1958, 340; W. Fischer and H. Heitsch, German Patent 1,007,306, Nov. 16, 1954; F. Hudswell and J. M. Hutcheon, *Proc. Internat. Confer. Peaceful Uses of Atomic Energy*, Vol. 8, 563, New York, 1956; J. Huré and R. Saint-James, *ibid.*, 551.]

d) British authors recommend chromatographic separation on Al_2O_3 or cellulose, using an organic solvent [T. V. Arden et al., *Brit. Pat.* 654,695, April 22, 1948, granted June 27, 1951; *Chem. Zentr.* **52**, 4840].

REFERENCES:

- II. E. M. Larson, W. C. Fernelius and L. Quill in: L. F. Audrieth, *Inorg. Syntheses*, Vol. III, New York-Toronto-London, 1950, p. 67.
- III. A. E. van Arkel and J. H. de Boer. *Z. anorg. allg. Chem.* 141, 289 (1924); D. M. Gruen and J. J. Katz. *J. Amer. Chem. Soc.* 71, 3843 (1939).
- IVa. B. A. Lister, *J. Chem. Soc. (London)* 1951, 3123; B. A. Lister and J. M. Hutcheon. *Research* 5, 291 (1952).
- IVb. R. S. Hansen and K. Gunnar. *J. Amer. Chem. Soc.* 71, 4158 (1949); R. S. Hansen, K. Gunnar, A. Jacobs and C. R. Simmons. *J. Amer. Chem. Soc.* 72, 5043 (1950).
- V. W. Fischer, W. Chalybaeus and M. Zumbusch. *Z. anorg. Chem.* 255, 79, 277 (1947/48); W. Fischer and H. Heitsch. Unpublished experiments.

Titanium, Zirconium and Thorium Hydrides

Ti/H

Hydrogen dissolves in the Ti metal lattice until a composition $TiH_{0.5}$ is reached; this produces a hydride with a considerable homogeneity in the range of $TiH-TiH_2$. The upper hydrogen concentration is attainable only with Ti and H_2 of the highest purity, while operating under conditions of extreme cleanliness.

The metal form best suited for the hydrogenation is Ti sponge. Titanium sheet starts to absorb H_2 at $300^\circ C$ and does so rapidly beginning at $400^\circ C$. Partially hydrogenated Ti reacts with carefully purified H_2 even at $20^\circ C$. Hydrogen is released from highly hydrogenated products by reheating to above $400^\circ C$ in high vacuum; complete desorption is achieved at $1000^\circ C$.

When it is required to absorb only a predetermined quantity of H_2 , the following procedure may be employed. The metal is weighed into a boat of sintered clay (or, better, of stainless steel, provided traces of Fe in the product are not detrimental) placed in a quartz tube connected to the system with a ground joint. The apparatus consists of a glass burette with 0.1-ml. divisions provided with a leveling tube and Hg reservoir and connected to an electrolytic H_2 generator; this apparatus is attached to a high-vacuum system. The quartz tube volume is measured, and the metal is degassed by heating to $550^\circ C$. Hydrides with the desired H_2 content are obtained by varying the absorption temperature and the quantity of hydrogen introduced.

Zr/H, Th/H

The preparation of Zr and Th hydrides is similar to the above procedure. Zirconium reacts very rapidly beginning at 700°C and at atmospheric pressure is capable of dissolving 1.95 atoms of H per atom of Zr. Thorium starts to absorb H₂ at 400°C; the maximum H₂ concentration corresponds to a hydride composition of ThH_{3.24}.

PROPERTIES:

Gray powder of somewhat lighter color and lower density than the parent metal powder. In contrast to the Ti and Zr hydrides, Th hydrides of high hydrogen content are labile and ignite spontaneously in air.

REFERENCES:

A. Sieverts et al. Z. phys. Chem. 145, 227 (1929); Z. anorg. allg. Chem. 153, 289 (1926); 172, 1 (1928); 187, 155 (1930); 199, 384 (1931); G. Hägg. Z. phys. Chem. (B) 11, 433 (1931); T. R. P. Gibb and H. W. Kruschwitz. J. Amer. Chem. Soc. 72, 5365 (1950); R. E. Rundle, C. G. Shull and E. D. Wollan. Acta Crystallogr. (Copenhagen) 5, 22 (1952).

Titanium (III) Chloride, Bromide and Iodide

A weighed quantity (2-3 g.) of TiCl₄ is placed with the appropriate precautions in a thick-wall quartz tube, and the stoichiometric quantity of Ti filings is added. The tube is cooled in a Dry Ice-alcohol bath, thoroughly evacuated by means of an oil pump, and melt-sealed in such a way that its total length is 12-15 cm. It is then placed in a very slightly inclined position in a tubular electric furnace so that the Ti metal is located at the higher end and the chloride at the lower. The Ti is in the hottest part of the oven (at 800-900°C), while the section containing the TiCl₄ is in a cooler zone (at about 200°C). An explosion shield is recommended. If one uses a mixture such as Ti + 2 TiCl₃ the procedure is less dangerous but more involved.

A mixture of black and purple substances (TiCl₂ and TiCl₃) is observed after 24 hours. As soon as all unreacted TiCl₄ disappears, the reactor tube is pushed deeper into the furnace, which results in a gradual disappearance of the reddish component. To achieve complete homogeneity, the mixture is heated for an

additional 4-5 days at 600-700°C. The product is black and may be dislodged from the wall by gentle tapping (the reaction with the quartz wall proceeds to only a very slight extent). The quartz tube is sawed open; the black powder is dropped into a transfer apparatus (Fig. 54, p. 75) and reheated in vacuum for 15-30 minutes at 200°C to remove the moisture absorbed during the transfer. The product is then ready for further processing.

Ib. To prepare larger quantities of $TiCl_2$ by the same method, it is advisable to use a vertical reactor tube, in which the molten dichloride is formed on passage of $TiCl_4$ vapor over titanium filings heated to a high temperature. A layer of Ti filings about 30 cm. high is placed on a perforated carbon plate in a fused quartz tube 110 cm. long and 4.5 cm. wide. Just underneath the carbon plate there is a graphite crucible supported by a piston-like arrangement; this crucible collects the droplets of the product. The entire arrangement is placed in a tubular furnace; the temperature at the metal level is 1050°C, while that at the level of the collecting crucible is 900°C. After thorough flushing with Ar, gaseous $TiCl_4$ is introduced from above in a slow stream of Ar. At the end of the reaction the graphite crucible is removed from the furnace in an atmosphere of a protective gas, and the solid block of $TiCl_2$ is removed by gentle tapping.

$TiBr_2$, TiI_2

These compounds are synthesized in a similar manner, except that the halogens, rather than the tetrahalides, are used as starting materials.

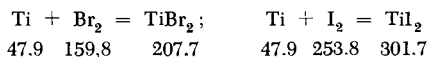

After weighing and before addition of the Ti filings, the Br_2 must be cooled to $-78^\circ C$, since liquid Br_2 and Ti react with ignition even at room temperature. This phenomenon also occurs in the sealed tube as soon as the Br_2 starts to melt. The tubes, however, are capable of withstanding the pressure. With I_2 , on the other hand, the conversion to tetraiodide starts only after slight heating. In both cases, further treatment is similar to that of the chloride. The quartz tube wall is attacked even less by the bromide than with the chloride, while the iodide does not react with quartz at all.

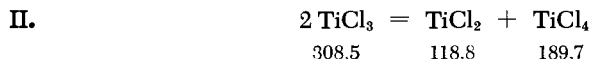

A high vacuum is created in a quartz tube, one end of which is filled with $TiCl_3$ and heated to 475°C, while the other is maintained

at -78°C . The TiCl_4 formed via the disproportionation condenses at the cold end. Complete decomposition of 1 g. of TiCl_3 requires about 12 hours. When the reaction is over, the tube end containing the TiCl_4 is sealed off from the remainder. Since the decomposition reaction $2 \text{TiCl}_3 \rightarrow \text{TiCl}_4 + \text{Ti}$ sets in below 475°C , pure TiCl_3 cannot be obtained by this method; the product always contains 2-3% of free titanium.

On the other hand, this method may be very successfully used for the preparation of TiBr_2 . At temperatures slightly above 400°C , half a gram of TiBr_3 will decompose completely in 18 hours according to the equation $2 \text{TiBr}_3 = \text{TiBr}_2 + \text{TiBr}_4$. However, the disproportionation $2 \text{TiBr}_2 \rightarrow \text{TiBr}_4 + \text{Ti}$ sets in above 500°C , so again free titanium may be present in the product.

III. Very pure and finely divided TiCl_2 may be obtained by reduction of TiCl_4 with H_2 in an electrical discharge produced without electrodes.

PROPERTIES:

TiCl_2 : Black crystals; ignites in moist air; soluble in H_2O , evolving H_2 (the same properties apply to TiBr_2 and TiI_2). d (TiCl_2) 3.13, (TiBr_2) 4.31, (TiI_2) 4.99.

REFERENCES:

- I. W. Klemm and L. Grimm. *Z. anorg. allg. Chem.* **249**, 198 (1942); P. Ehrlich, H. J. Hein and H. Kühnl. *Z. anorg. allg. Chem.* **292**, 139 (1957); for TiI_2 , see also J. D. Fast. *Recueil Trav. Chim. Pays-Bas* **58**, 174 (1939); for TiCl_2 , see especially D. G. Clifton and G. E. McWood. *J. Phys. Chem.* **60** 311 (1956).
- II. R. C. Young and W. C. Schumb. *J. Amer. Chem. Soc.* **52**, 4233 (1930); W. C. Schumb and R. F. Sundström. *J. Amer. Chem.* **55**, 596 (1933); see also W. Klemm. *Angew. Chem.* **69**, 683 (1957).
- III. V. Gutman, H. Nowotny and G. Ofner. *Z. anorg. allg. Chem.* **278**, 80 (1955).

Titanium (III) Chloride, Bromide and Iodide



TiCl_3

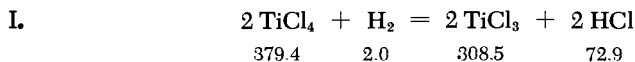

a) The procedure developed by Schumb et al. was modified by Klemm and Krose as follows.

The apparatus is shown in Fig. 292. Parts *a*, *c*, and *d* are made of fused quartz, while the container *f* is Pyrex. Before the start of the reaction the entire system is thoroughly dried with a stream of H_2 . About 25 g. of $TiCl_4$ is then added through *b*, the furnace is rapidly heated to $800^\circ C$, and the cooling water for the finger *d* is turned on (Schumb et al. use a system made of high-melting glass and heat to $650^\circ C$ only). The $TiCl_4$ in *a* is heated almost to the boiling point while a stream of H_2 is passed through the flask; the product is free of $TiCl_2$ only if an excess of $TiCl_4$ is present in the reaction chamber. The unreacted $TiCl_4$ is collected in container *f*, which is cooled with Dry Ice. After all the $TiCl_4$ has been distilled out of flask *a*, the current to the furnace is shut off; it should cool rapidly, since the insulation consists only of a thin asbestos layer. When the temperature drops to $120^\circ C$, the water flow to the cold finger is stopped, the finger is dried with an air stream, and the furnace is kept at $120^\circ C$ for several hours in order to free the product deposited on the tip of the finger of $TiCl_4$. The $TiCl_4$ left in the remaining section of the apparatus is distilled off by fanning with a flame. The system is then allowed to cool in a stream of H_2 , followed by a fast stream of CO_2 . The container *f* is then disconnected at *e* and replaced with a transfer device (Fig. 54, p. 75); the cork stopper carrying the cold finger is pulled out from the reactor to a distance sufficient for insertion of a scraper; the $TiCl_3$ is scraped off the finger and dropped by tapping into the transfer container. The yield of the pure product is 2-3 g.

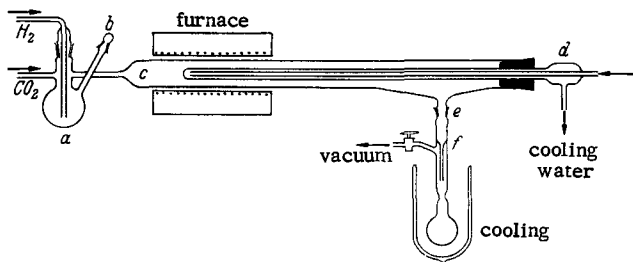

Fig. 292. Preparation of titanium (III) chloride according to Klemm and Krose. *a*) flask, *b*) charging adapter for $TiCl_4$, *c*) reaction tube, *d*) cold finger, *f*) container

b) Larger quantities (150-200 g.) of less pure product (98%) can be prepared in one day in the apparatus of Fig. 293 via reduction of $TiCl_4$ with H_2 on the surface of a glowing tungsten wire.

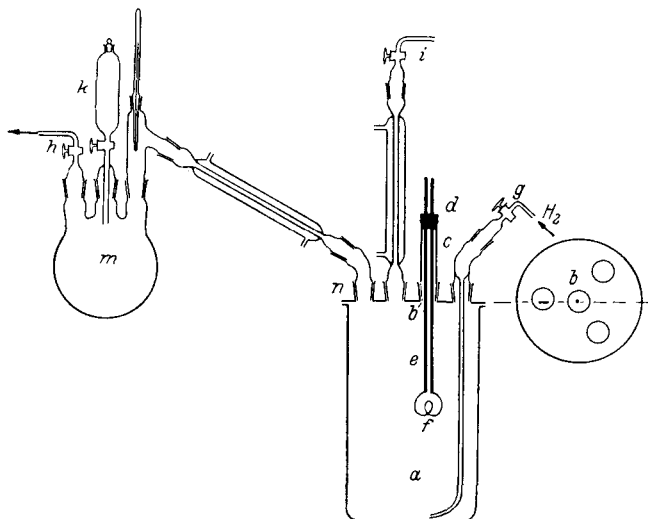

Fig. 293. Preparation of titanium (III) chloride according to Sherfey. *a*) Pyrex reactor; *e*) tungsten rods, about 6 mm. in diameter; *f*) tungsten wire coil; *m*) flask for distillation of TiCl_4 .

The four-liter Pyrex reaction vessel *a* is provided with a flat-ground lid with four openings, one in the middle and the other three arranged symmetrically around it. The central 34/45 ground joint *b* carries a tubular adapter *c* closed off with a two-hole rubber stopper *d* through which two tungsten rods *e* (6 mm. in diameter) are inserted. The rods are interconnected by a tungsten wire, the thickness and length of which are determined by the available power supply. Thus, heating a wire 1 mm. in diameter and 30 cm. long to the required temperature of 1000–1100°C requires a current of 36 amp. and 8.6 v. Thinner wires should not be used, if at all possible, since they may burn out during the run; longer wires increase the process rate.

The apparatus is thoroughly flushed with pure, dry H_2 , which is introduced at *g* and which leaves at *h*. When all the moisture has been removed, stopcock *h* is closed and *i* is opened, without interrupting the stream of H_2 . Then TiCl_4 (one liter = 1700 g.) is introduced from dropping funnel *k* into distilling flask *m* and, except for a small residue, redistilled into the reaction vessel *a*. The distillation apparatus is then removed and the opening at *n* is rapidly closed off.

Only the lower third of reaction vessel *a* is heated with a heating mantle. The boiling TiCl_4 then condenses on the lid and the

side walls—cooled with a fan if necessary—and, while flowing down, washes off the nascent TiCl_3 . If the TiCl_4 boils too violently, the solid TiCl_3 particles may come in contact with the hydrogen stream, be entrained by it and plug the reflux condenser (the condenser serves only as a safety vent).

When the boiling of the TiCl_4 (in the fast hydrogen stream) has reached a steady state, the tungsten wire is heated to red heat. The reduction starts immediately and is accompanied by the appearance of violet vapors of TiCl_3 , which condense on the walls and are largely flushed down to the bottom of the TiCl_4 -containing flask. Since there is a possibility that air may enter the system whenever there is a sudden cooling and resultant temporary vacuum, the H_2 flow rate must be carefully maintained (the air is undesirable since it may oxidize the glowing wire to the point of burnout and may also cause hydrolysis). When the TiCl_4 ceases to flow unhindered along the walls of the vessel, the reaction is stopped by turning off the current to the glow wire, and the flask is allowed to cool in a stream of H_2 . The TiCl_4 may be distilled directly from the reaction beaker by replacing the lid used in the reaction with a one-hole cover. However, it is simpler to transfer the reaction mixture to a side-neck distilling flask and heat to 150°C on an oil bath. The last traces of adsorbed TiCl_4 are removed by heating in vacuum to 200°C ; other volatile contaminants are removed at the same time. About 150 g. of TiCl_3 , corresponding to a yield of 10% (or 90% based on the amount of TiCl_4 actually consumed in the reaction), is obtained. Because it contains a small quantity of TiCl_2 , the product has a reducing value of 101.5%. It usually ignites even in moist air, and even more rapidly when it is still warm; transfer must therefore be carried out carefully, in an inert atmosphere.

The difficulties involved in welding on the tungsten coil may be circumvented by means of the following arrangement. Two copper tubes (diameter 6 mm., length about 30 cm.) are electrically insulated from each other and cemented in the adapter *c*; just above *c* they are provided with side fittings for connection to cooling water. The cement may be an epoxy resin such as Araldite 121 R with hardener 951.* The upper ends of the copper tubes, which serve as bus bars, are interconnected by means of a short piece of rubber tubing; the lower ends are closed off. A strip of molybdenum sheet (0.2 mm. thick, 6 cm. long) is soldered on at the lower end of each of the two copper tubes to support the tungsten wire. A firm electrical contact between the wire (which is wound into five or six coils) and the molybdenum strips is

*Both manufactured by the Ciba Co; see also p. 32.

achieved by threading the wire ends through a series of small holes in the strips, followed by bending the ends over and crimping to the strips.

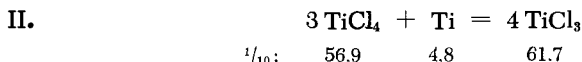

If pure Ti metal is available, the TiCl_3 may be prepared in a thick-wall pressure tube made of fused quartz or Vycor in accordance with the above equation. The procedure is essentially the same as that described for the preparation of TiCl_2 . A large amount of TiCl_2 forms initially; this stage may be recognized by the black color and moist appearance of the product, due to unreacted TiCl_4 . After the initial reaction the reactor tube is gradually (over several hours) pushed completely into the furnace, which is maintained at 600°C . Should a temperature gradient exist in the system, the TiCl_3 will sublime, in the form of violet, leaflike crystals, into the center of the pressure tube. The tip of the tube is then broken off under a blanket of protective gas; the other end, which may contain some residual unreacted Ti, is also broken off, and the TiCl_3 is dropped into a transfer device (cf. Part I, p. 75), in which it is heated for an additional few minutes in vacuum to $100\text{--}150^\circ\text{C}$ by fanning the vessel with a flame; the small amount of TiCl_4 which evolves shows that the reaction did not go to completion. The reactor walls are attacked only at the spot where the Ti metal was placed, and then only very slightly.

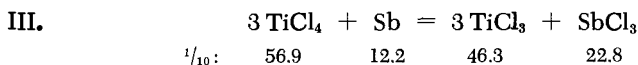

The reduction of TiCl_4 to TiCl_3 with Sb does not require a complicated apparatus and may be carried out as follows:

A solution of SbCl_3 (d 1.265) is reduced with Zn dust. The resultant Sb is washed several times with 0.1N HCl until free of Zn, then treated with alcohol and ether, and finally dried in a stream of CO_2 . Antimony prepared by other methods does not reduce TiCl_4 as efficiently.

Freshly distilled TiCl_4 (28 g.) is placed in a bomb tube and the Sb (6 g.) is added; the reactor tube is melt-sealed and heated for five hours at 340°C . After cooling, both tube ends are broken off and the moist mass, in a stream of CO_2 , is transferred to a three-neck flask via an adapter at neck a. Then CCl_4 is added from a dropping funnel attached to neck b while the mixture is agitated with a stirrer inserted through the center neck; this dissolves out the unreacted TiCl_4 . The mixture is allowed to

settle, an adjustable siphon tube is inserted at *a*, and the supernatant liquid is forced out by CO₂ pressure applied through *b*. The operation is repeated until the product is free of TiCl₄. The SbCl₃ formed in the reaction is removed in the same manner by exhaustive extraction with ether, the last traces of which are evaporated by heating on a water bath in a stream of CO₂. The TiCl₃, in the form of a violet powder, is transferred to storage under a blanket of CO₂. The yield is quantitative.

IV. *Alternate method*: Finely divided, very pure TiCl₃ may be prepared by reduction of TiCl₄ with H₂ in an electric arc.

TiBr₃

I. The preparation of TiBr₃ by method *Ia* is similar in its essentials to that used for TiCl₃, except that the removal of TiBr₄ after completion of the reaction must be carried out at a higher temperature (250°C).

The preparation by method *Ib* uses the same apparatus as that for TiCl₃. Since TiBr₄ is a solid at room temperature, the reflux condenser must be cooled with hot water or steam. The TiBr₄ is poured hot into the distillation flask and allowed to solidify before the apparatus is flushed with H₂.

II. Sublimed TiBr₃ crystals are synthesized from the elements under the same conditions as those given for TiCl₃.

TiI₃

II. Direct synthesis from stoichiometric quantities of the elements by heating in a sealed tube is similar to the preparation of TiCl₃ or TiCl₂ from Ti + TiCl₄. As long as the tetraiodide still accompanies the diiodide and the triiodide, the product is a solid cake which is difficult to break up by tapping. Toward the end of the reaction, after heating for several hours at 700°C, the product can be pulverized by vigorous shaking. The reaction may be completed at 180°C (reduce the temperature over a period of several days). The reaction is tested for completion by pulling out the tip of the tube from the furnace (maintained at this temperature) and cooling it with a piece of moist filter paper. The reaction is complete if after several hours only a very slight film of TiI₄ is observed (the film quantity is negligible compared to the total material in the reactor).

PROPERTIES:

TiCl₃: Formula weight 154.27. Violet-red to black crystals; sublimes in vacuum at 425-440°C; decomposes to TiCl₂ + TiCl₄

above 450°C. Readily soluble in H₂O. *d* 2.66. Crystal structure: type D 0₅.

TiBr₃: Formula weight 287.65. Bluish-black crystals; decomposes to TiBr₂ + TiBr₄ at 400°C. Less soluble in H₂O than TiCl₃.

TiI₃: Formula weight 428.66. Violet-black needle-shaped crystals; stable up to 300°C on heating in high vacuum; decomposes to TiI₂ + TiI₄ above 350°C. Dissolves slowly in H₂O without evolving H₂.

REFERENCES:

- Ia. C. Young and W. C. Schumb. *J. Amer. Chem. Soc.* **52**, 4233 (1930); W. C. Schumb and R. F. Sundström. *J. Amer. Chem. Soc.* **55**, 596 (1933); W. Klemm and E. Krose. *Z. anorg. Chem.* **253**, 209 (1947); H. Hartmann, H. L. Schläfer and K. H. Hansen. *Z. anorg. allg. Chem.* **284**, 153 (1956); for TiBr₃ see also: R. C. Young and W. M. Leaders in: W. C. Fernelius, *Inorg. Syntheses*, Vol. II, New York-London, 1946, p. 116.
- Ib. J. M. Sherfey. *J. Research Nat. Bur. Standards* **46**, 299 (1951); *Inorg. Syntheses*, Vol. VI, New York-London, 1960, p. 57; P. Ehrlich, G. Kaupa and K. Blankenstein. *Z. anorg. allg. Chem.* **299**, 213 (1959).
- II. W. Klemm and E. Krose. *Z. anorg. Chem.* **253**, 209 (1947); P. Ehrlich and G. Pietzka. Unpublished experiments; for TiI₃, see also J. D. Fast. *Recueil Trav. Chim. Pays-Bas* **58**, 174 (1939).
- III. M. Billy and P. Basseur. *Comptes Rendus Hebd. Séances Acad. Sci.* **200**, 1765 (1935).
- IV. T. R. Ingraham, K. W. Downes and P. Marier. *Canadian J. Chem.* **35**, 850 (1957); *Inorg. Syntheses*, Vol. VI, New York-London, 1960, p. 52.

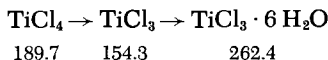
TiCl₃ · 6 H₂O

Titanium (III) chloride may be prepared by cathodic reduction of TiCl₄ in a hydrochloric acid solution; if the concentration of TiCl₃ in the solution is sufficiently high, the hexahydrate precipitates on saturation with HCl. The crystallization is apparently inhibited by the presence of tetravalent titanium, and total reduction of the solution is therefore necessary.

The procedure, according to W. Fischer, is as follows.

A thick-wall cylindrical battery jar (diameter 7 cm., height 9 cm.) serves as the electrolytic cell. The center of the cell is occupied by a clay cylinder (diameter 4.5 cm., height 12 cm.). The cylinder is held in place by a cork ring with three additional holes, two for carbon anodes (placed opposite each other on the diameter) and the third for an outlet tube for the Cl_2 evolved during the electrolysis. The clay cylinder is closed with a three-hole rubber stopper, which contains an inlet tube reaching almost to the bottom of the cylinder, a short outlet tube, and a lead wire to the Pt cathode. Also recommended is the insertion of an additional glass tube, used for occasional sampling of the solution as a check on the degree of reduction.

To start with, TiCl_4 (19 g.) is added in drops with efficient cooling and vigorous stirring to 27 ml. of 25% HCl solution. The insoluble hydrolysis products which may be formed are filtered off through fritted glass. The clear solution is placed in the clay cylinder, and the anode chamber is filled to the same level with 25% hydrochloric acid. At 12 v. and a current density of 2.5 amp./10 cm.² of the Pt cathode, the electrolysis should require about four hours. The jar is meanwhile cooled with ice (or, if necessary, with ice-salt). Toward the end of the run, HCl is added to the solution until saturation. The hexahydrate $\text{TiCl}_3 \cdot 6\text{H}_2\text{O}$ crystallizes best when the solution is not agitated; therefore, the introduction of HCl should be interrupted for 10 minutes every half hour. If the reduction is complete, the product crystallizes within one hour, forming a solid crystalline mass. It is placed on a coarse fritted-glass filter under CO_2 and the mother liquor is removed by suction. The precipitate is washed with some saturated HCl solution, followed by ether, and the crystals are dried in a vacuum desiccator over soda lime. The $\text{TiCl}_3 \cdot 6\text{H}_2\text{O}$ then consists of small crystals.

PROPERTIES:

Pale-violet, hygroscopic crystals, readily soluble in water. Decolorizes slowly by oxidation in dry air, rapidly in moist air, with formation of white TiO_2 hydrate.

If a saturated solution of TiCl_3 is covered with ether and saturated with HCl, a green, very unstable isomeric hexahydrate is formed [A. Stähler and H. Wirthwein, Ber. dtsch. chem. Ges. 38, 2619 (1905)].

REFERENCE:

Private communication from W. Fischer, Hannover.

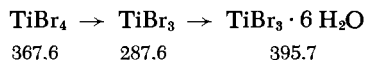
TiBr₃ · 6 H₂O

Titanium (III) bromide $\text{TiBr}_3 \cdot 6\text{H}_2\text{O}$ is prepared in exactly the same way as $\text{TiCl}_3 \cdot 6\text{H}_2\text{O}$. A solution of 37 g. of TiBr_4 in 25 ml of 34% hydrobromic acid is poured into the clay cylinder and reduced for three hours at a current intensity of 2.5 amp.

PROPERTIES:

Reddish-violet crystals. M.p. 115°C. Soluble in H_2O , methanol, absolute alcohol and acetone; insoluble in CCl_4 and benzene. Decomposes in absolute ether.

REFERENCES:

The same as for $\text{TiCl}_3 \cdot 6\text{H}_2\text{O}$; see also J. C. Olsen and E. P. Ryan, J. Amer. Chem. Soc. 54, 2215 (1932).

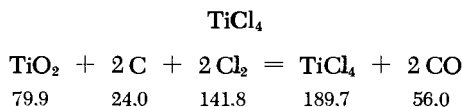
Titanium (IV) Chloride

PREPARATION

a) An intimate mixture of 30 g. of commercial TiO_2 (sold under the trade name "synthetic rutile"; if natural rutile is used, it must be preground for 24 hours in a ball mill until a very fine powder is obtained), 15 g. of charcoal or carbon black, and 0.05 g. of manganese dioxide catalyst is stirred to a paste with water and 0.3 g. of soluble starch. The mixture is heated in a drying chamber with occasional stirring until a material consisting of agglomerated particles is produced; this is placed in a clay crucible, covered with a layer of carbon black, and thoroughly calcined by means of a blast burner.

The chlorination is carried out in a quartz tube (20 mm. I.D.) to which an 8-mm. quartz tube is sealed at a 45° angle. The narrower tube is inserted into a 150-ml. distilling flask, which serves as the receiver.

The larger tube is charged with the $\text{TiO}_2 + \text{C}$ mixture and the entire apparatus is dried by fanning with a flame, while a stream

of CO_2 is flowing through. The receiver is immersed in an ice-salt mixture, and the reactants are slowly heated to 450°C in a stream of Cl_2 . In the absence of a catalyst, or if the TiO_2 is insufficiently ground, heating to 1000°C is necessary. From time to time, particularly toward the end of the run, the tube section between the furnace and the receiver is fanned with a flame to distill off any condensed TiCl_4 and to prevent plugging with FeCl_3 . At a flow rate of three liters of Cl_2 per hour, the reaction requires 4-5 hours for completion. The receiver is removed and the product TiCl_4 is freed of dissolved Cl_2 (and COCl_2 , if present) by drawing a stream of dry air through the tube. The yield is about 40 g.

b) A simple laboratory apparatus, which can be used for the preparation of most anhydrous chlorides (solid, liquid and gaseous), has been described by Kroll (see Fig. 294). It is made of fused quartz, which is better than porcelain since it is attacked at much higher temperature and even then produces only a single contaminant (SiCl_4). The apparatus consists of a single tube in two sections, one wide and one narrow, and containing a cold finger in the large-diameter section; the latter section serves as a condensing chamber for the distillate or sublimate. The heating arrangement is divided into two parts. The heating section for the narrower tube reaches well into the wide-tube section, to prevent the chlorides from condensing in the transition section. The large-diameter section may be heated slightly if the need arises; it is only partially covered by the heating element and its exposed part may be cooled by placing it in a wooden box filled with Dry Ice; this may be necessary in the preparation of chlorides which are difficult to condense (e.g., BCl_3). Chlorides which are liquid at room temperature (e.g., TiCl_4) condense on the cold finger and flow into the receiver, the reactor in this case being slightly inclined. Nonvolatile chlorides deposit as solids on the finger.

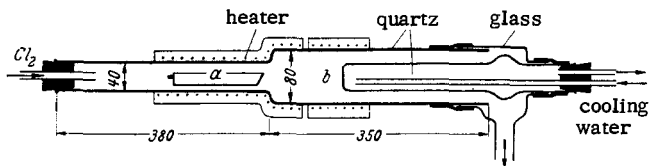

Fig. 294. Preparation of anhydrous chlorides according to Kroll. The main tube and the cold finger are made of fused quartz. a) reaction chamber; b) condensing chamber. Dimensions in mm.

If the raw materials for TiCl_4 are very pure TiO_2 and sugar charcoal calcined in a stream of Cl_2 , then the purification

described below becomes unnecessary. The solid charcoal may be dispensed with if the chlorine stream also contains CCl_4 or S_2Cl_2 .

See also the preparation of ZrCl_4 .

PREPURIFICATION

The crude product is decolorized and contaminants such as FeCl_3 , VOCl_3 , etc., are removed by adding 1 g. of Cu powder (Na amalgam or Hg may also be used) and heating the liquid to 90–100°C for 15 minutes with occasional shaking.

[If Cu *turnings* are used, the amount specified above must be increased tenfold. Oleic acid and its salts and other organic compounds, in quantities of less than 1%, are also efficient decolorizing agents [C. K. Stoddard and E. Pietz, U. S. Bur. Mines Rep. Invest. 4153, 40 (1947)].

According to British Patent 588,657 the following purification procedure is particularly well suited for the removal of traces of vanadium. The product containing 0.072% V is mixed with 0.1% of Fe stearate and treated with H_2S , causing precipitation of a black-brown sulfide; the latter is filtered off. The TiCl_4 then contains only 0.002% V.]

After heating with copper, the TiCl_4 is cooled and suction-filtered through a very dry filter funnel, and the filtrate is transferred for further purification (removal of SiCl_4 and dissolved nonvolatile hydrates) to the distillation apparatus described below (Fig. 295).

A) ATMOSPHERIC PRESSURE DISTILLATION

The neck of distilling flask *a* is closed off with a ground stopper provided with a small hook, from which a thermometer is suspended on a Pt wire. The side arm passes through a condenser jacket; a small bulb *b* (the receiver for the forerun) and an outlet tube *c* filled with P_2O_5 are sealed on as shown. In the initial stage of the run, the system ends in a second distilling flask *e* equipped with a break-seal valve *f* (see Part I, p. 63), via which the flask is later connected to additional pieces of glassware. The apparatus is set up to point *i* and flasks *a* and *e* are dried by fanning with a flame while a stream of air is passed through. Then TiCl_4 is placed in flask *a* and the latter is heated on an oil bath. The forerun is collected in *b*, which is then sealed off, while the main fraction of the material is distilled into *e*, which is then sealed off at *d*. This operation is followed by an additional distillation at atmospheric pressure: flask *e* is melt-sealed at *i* to the system shown on the right side of Fig. 295A; this part of the apparatus is very thoroughly dried by alternately evacuating the system and allowing dry air to enter. The thin-wall break-seal

valve is then shattered at the prescratched point *g* by moving the hammer *h* by means of a magnet. The forerun from this distillation is collected in *k* and the main fraction of the distillate in receiver *m*, which is then melt-sealed at point *l*.

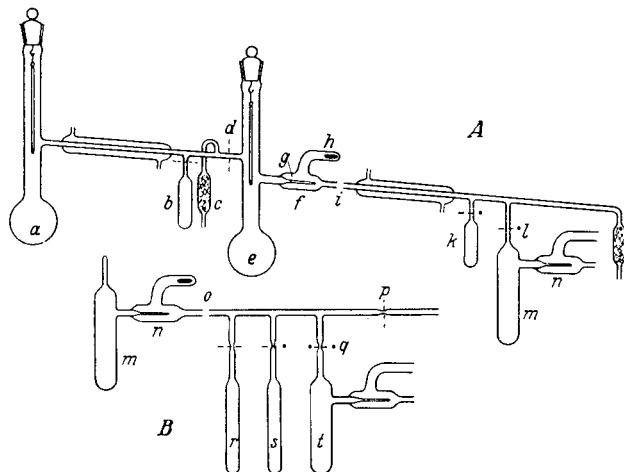

Fig. 295. Purification of titanium (IV) chloride by distillation: A) at atmospheric pressure; B) in vacuum.

B) VACUUM DISTILLATION

Vessel *m* is melt-sealed at *o* to the rest of the apparatus shown in Fig. 295B, and the entire system is dried by fanning with a flame while a high vacuum is maintained. The TiCl_4 is then introduced into *m* and frozen with liquid nitrogen, the break-seal valve *n* is broken by the method described above, the system is evacuated to 10^{-4} mm. and sealed at *p*. A forerun is collected in *r* by cooling this trap and gradually heating flask *m*; the connection to *r* is then sealed off. The main fraction of the product may now be distilled in one batch, that is, by collecting in cooled receiver *t*, sealing off at *q*, and repeating the vacuum distillation; or the TiCl_4 may be distributed into several batches and collected in traps s_1, s_2, s_3 , etc.

PROPERTIES:

Colorless, acrid liquid; fumes strongly in moist air. M.p. -24.8°C , b.p. 136°C ; *d* 1.73.

Hydrolyzes almost completely on solution in water; if the hydrolysis is depressed by addition of acid or if only small

quantities of water are used, oxychlorides may form as intermediates. Readily forms adducts with ammonia, pyridine, non-metal chlorides, etc.

REFERENCES:

- Preparation: a) Private communication from W. Fischer, Hannover. b) W. Kroll. *Metall u. Erz* **36**, 101, 125 (1939); see also A. Köster. *Angew. Chem.* **69**, 563 (1957).
 Repurification: A. V. Pamfilov, A. S. Chudyakov and E. G. Standel. *Zh. Prikl. Khimii* **142**, 232 (1935), and other papers of A. V. Pamfilov published in that period.
 Distillation: K. Arii. *Sci. Rep. Tohoku Imp. Univ.* **22**, 959 (1933); the apparatus described may be used for the distillation of other highly corrosive liquids, such as POCl_3 , SOCl_2 , etc. Purification of TiCl_4 for atomic weight determinations is described by G. P. Baxter, *J. Amer. Chem. Soc.* **45**, 1228 (1923); **48**, 3117 (1926); E. H. Archibald, *The Preparation of Pure Inorganic Substances*, New York, 1932, p. 184.

Ammonium Hexachlorotitanate

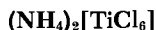

This is a good, easily measured starting material for preparing hydrochloric acid solutions of titanium, since it forms concentrated, stable solutions in water or dilute hydrochloric acid.

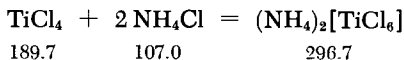

The preparation comprises precipitation of $(\text{NH}_4)_2[\text{TiCl}_6]$ from an HCl-saturated solution, using a special apparatus which may also be employed in many other syntheses.

A 200-ml. wide-neck Erlenmeyer flask is used to hold 100 ml. of solution. The flask is closed off with a closely fitting three-hole rubber cap ("fermentation cap"). A glass stirrer, preferably of the twist drill type, is inserted in the center hole; a drop of glycerol is used for lubrication and gas seal. The use of a ground joint sealed to a mercury-seal agitator is also recommended. Laborious centering of the stirrer is avoided and easy assembly and dismantling of the apparatus promoted by coupling the stirrer to the motor shaft (or the speed reducer shaft) by means of a piece of strong, rigid rubber vacuum hose. The direction of rotation of the stirrer is such that the center of

the liquid is pushed down; higher agitation rates can be reached with this arrangement without danger of splashing, and the stirring is also more efficient.

The flask is supported at the neck by a clamp which holds it in a cooling bath at a depth so that it is covered with coolant to just below the clamp level while still leaving enough coolant underneath the flask to provide cooling of the bottom.

The gas inlet tube need not dip into the solution, since the rate of absorption of HCl in the vigorously stirred liquid is so rapid that it is almost controlled by the input rate alone; possible plugging of the inlet tube is also avoided by not letting the tube dip into solution. The HCl addition rate is controlled to avoid the formation of a mist above the stirred mixture, a point at which evaporation losses just begin. The greater the stirring rate, the higher the rate at which the HCl may be introduced, and the sooner the end of the run. Complete saturation of 100 ml. of precipitation solution requires less than one hour.

The HCl flow rate is sharply reduced toward the end of the run. The progress and termination of the HCl absorption can be followed by means of bubble counters inserted ahead of and behind the precipitation flask.

The HCl generator must be capable of yielding a continuous stream of gas and must also allow a wide range of adjustment in the flow rate; in addition, it should be easy to start, give an air-free gas stream as soon as possible after the start, and stop generating gas shortly after being turned off. The generator described on p. 280 fulfills these conditions less well than the apparatus developed by W. Seidel [Chem. Fabrik 11, 408 (1938)], in which conc. hydrochloric and conc. sulfuric acids react to give a good yield of HCl; this is accomplished by dropping the acids separately onto a packing of glass beads.

If only small quantities of HCl are required, the most convenient generator is still the Kipp, which utilizes the reaction of conc. sulfuric acid with lumps of NH_4Cl , particularly since the gas does not have to be dried. However, foaming is quite pronounced at larger HCl flows.

Returning now to the precipitation of $(\text{NH}_4)_2[\text{TiCl}_6]$, gaseous HCl is introduced at 0°C into a solution of 6 g. of TiCl_4 in 100 ml. of aqueous (7:1) hydrochloric acid containing about 4 g. of NH_4Cl . The HCl gas is added until saturation. Then the HCl flow is stopped, but stirring is continued until complete precipitation. If the precipitation rate is low, the yellow $(\text{NH}_4)_2[\text{TiCl}_6]$ is obtained in the form of coarse crystals averaging 0.1 mm.

The precipitate is separated from most of the mother liquor by a short suction filtration through coarse fritted glass (without allowing air to be drawn through the compound), and the crystals are then pressed between two pieces of filter paper. If an asbestos

filter is used, the compound must be repeatedly boiled with conc. hydrochloric acid and then very thoroughly washed.

PROPERTIES:

Yellow octahedra, probably of the $K_2[PtCl_6]$ structure. May be stored for an indefinite period if moistened with hydrochloric acid and kept in a closed container; on washing with anhydrous ether and drying over conc. H_2SO_4 in a vacuum desiccator, decomposes with pronounced evolution of HCl. In moist air, forms a white hydrolysis product, which is unusual in still being soluble in water.

REFERENCES:

- A. Rosenheim and O. Schütte. *Z. anorg. Chem.* **26**, 239 (1901); W. Fischer and W. Seidel. *Z. anorg. allg. Chem.* **247**, 333 (1941); W. Seidel and W. Fischer. *Z. anorg. allg. Chem.* **247**, 367 (1941).

Titanium (IV) Bromide

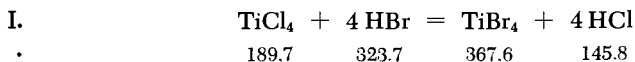

Due to the long time required (30 hours), the original method described by Thorpe in 1856 (bubbling of HBr through warm $TiCl_4$ until the boiling point of the solution equals that of $TiBr_4$) has been modified as follows.

Receiver *b* of the apparatus shown in Fig. 296 is cooled with liquid nitrogen or Dry Ice, and pure, dried HBr is condensed in until enough liquid is present. The section above *d* is then broken off, $TiCl_4$ is added to *a*, and the apparatus is resealed at *e*. Stopcock *f* is closed, *i* is opened, and $TiCl_4$ is slowly distilled into container *b*, which is cooled with Dry Ice; the initial reaction is quite violent. By periodically removing the coolant, it is possible to bring the reaction to completion. The gas mixture evolved (essentially HCl) is vented through stopcock *i*, while the HBr is condensed in *c* by proper cooling. The mixture is allowed to warm up to room temperature in order to accelerate the reaction, and the condensation of fresh HBr into the flask is repeated several times. Finally, vessel *b*, which contains an already very pure crude product, is sealed off at *g*; if desired, flask *c* may be sealed at point *h* to a distillation apparatus (such as the one described

in the preparation of TiI_4) and the $TiBr_4$ further purified by vacuum distillation.

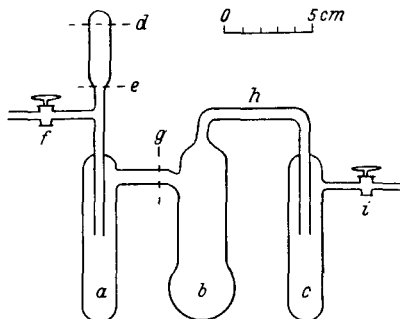
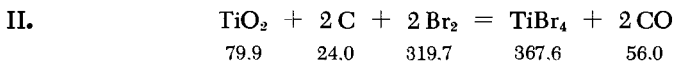

Fig. 296. Preparation of titanium (IV) bromide.



The already-described method of preparation of $TiCl_4$ is modified only to the extent that the stream of Cl_2 is replaced by dry CO_2 which passes through a $60^\circ C$ wash bottle containing 135 g. of Br_2 ; the bromine-saturated CO_2 then passes over the reaction mixture (30 g. of TiO_2 + 15 g. of wood charcoal), which is heated to about $600^\circ C$. A mixture of $TiBr_4$, CBR_4 and free Br_2 collects in the receiver. The last two products are distilled off in a stream of pure CO_2 bubbled through the melt, leaving the $TiBr_4$ as the residue. Cooling to room temperature produces a solid mass, which may be purified by multiple distillation. The yield is 80%.



If metallic Ti is available, the compound may be easily synthesized from the elements (see the procedure for the preparation of titanium dihalides). A weighed amount (5-6 g.) of freshly distilled Br_2 is placed in a thick-wall quartz tube cooled with Dry Ice, crude Ti is added (somewhat more than the stoichiometric quantity), and the tube is sealed under high vacuum. The Br_2 begins to melt on removal of the coolant; the reaction starts immediately and flames appear. After completion of the reaction the tube is opened and the $TiBr_4$ is distilled off; it may be purified by multiple distillation (see TiI_4).

PROPERTIES:

Amber yellow, octahedral crystals. M.p. 40°C, b.p. 230°C; d 3.25. Extremely hygroscopic, absorbs moisture with hydrolytic decomposition. Very readily soluble in alcohol, moderately in ether; soluble in 34% hydrobromic acid and in conc. hydrochloric acid. Crystal structure: type D1₁.

REFERENCES:

- I. W. Biltz and E. Keunecke. *Z. anorg. allg. Chem.* **147**, 171 (1925); W. Klemm, W. Tilk and S. von Müllenheim. *Z. anorg. Chem.* **176**, 1 (1928).
 - II. See also J. C. Olsen and E. P. Ryan. *J. Amer. Chem. Soc.* **54**, 2215 (1932), as well as R. C. Young in: W. C. Fernelius, *Inorg. Syntheses*, Vol. II, New York-London, 1946, p. 114.
 - III. See also J. M. Blocher Jr., R. F. Rolsten and I. E. Campbell. *J. Electrochem. Soc.* **104**, 553 (1957).
- Purification of TiBr₄ for atomic weight determination is described by G. P. Baxter and A. Q. Butler, *J. Amer. Chem. Soc.* **50**, 408 (1928); E. H. Archibald, *The Preparation of Pure Inorganic Substances*, New York, 1932, p. 185.

Zirconium (IV), Hafnium (IV) and Thorium (IV) Chlorides and Bromides

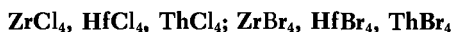
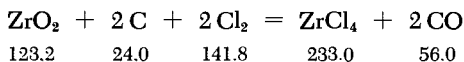
ZrCl₄

An intimate mixture of one part of pure ZrO₂ and two parts of calcined carbon black or sugar charcoal is placed in a porcelain boat and heated at 500°C in a stream of Cl₂; or, preferably, ZrO₂ with no admixtures is chlorinated in a Cl₂-CCl₄ gas mixture produced by passing Cl₂ through a wash bottle (70°C) filled with CCl₄. The initial chlorination temperature is 350°C, but is gradually raised to 700°C.

The equipment is similar to that described on p. 889 for the preparation of BeCl₂, except that, when working with Cl₂-CCl₄, a trap for the unreacted CCl₄ must be inserted in line after tube A. Since ZrCl₄, which sublimes at 331°C, is difficult to recondense, it is advisable to use a long tube (600 mm.), preferably of Vycor. The additional resublimation at 300-350°C is carried out in a stream of H₂, a treatment which more effectively removes the oxide and FeCl₃ present.

Alternate method: The industrial chlorination of ZrC prepared from ZrSiO_4 is described by W. J. Kroll et al. [Trans. Electrochem. Soc. 89, 263 (1946); 92, 187 (1947); J. Electrochem. Soc. 94, 1 (1948)].

PROPERTIES:

White crystalline powder. Sublimation point 331°C , m.p. (under pressure) 438°C ; d 2.80. Yields a mist of hydrochloric acid in moist air; violently decomposed by H_2O , forming the oxychloride. Soluble in alcohol and ether. Crystal structure: type D 1_1 .

HfCl_4 , ThCl_4

The same general method is used for HfCl_4 and ThCl_4 ; in the case of ThCl_4 , the $\text{Cl}_2\text{-CCl}_4$ mixture should be replaced with $\text{Cl}_2\text{-SCl}_2$, since this allows reducing the temperature to 700°C instead of 900°C .

ZrBr_4 , HfBr_4 , ThBr_4

The preparation of the bromides in a Br_2 -saturated nitrogen stream requires high temperatures if practical reaction rates are to be achieved. The oxide-carbon mixture must usually be heated to about 1100°C ; this temperature is easily attained with a gas-air blast burner provided the quartz reactor is embedded in porous, refractory gravel ("Diatomite" gravel).

The preparation of HfBr_4 and the lower bromides HfBr_3 and HfBr_2 is described in W. C. Schumb and C. K. Morehouse, J. Amer. Chem. Soc. 69, 2696 (1947).

REFERENCES:

- D. Lely and L. Hamburger. Z. anorg. Chem. 87, 209 (1914); A. Voigt and W. Biltz. Z. anorg. allg. Chem. 133, 277 (1924); O. Hönigschmid, E. Zintl and F. González. Z. anorg. allg. Chem. 139, 293 (1924); J. H. deBoer and J. D. Fast. Z. anorg. allg. Chem. 187, 177 (1930); W. Fischer, R. Gewehr and H. Wingchen. Z. anorg. allg. Chem. 242, 161 (1939); J. P. Coughlin and E. G. King. J. Amer. Chem. Soc. 72, 2262 (1950); for the bromides, see also R. C. Young and H. G. Fletcher in: H. S. Booth, Inorg. Syntheses, Vol. I, New York-London, 1939, pp. 49, 51.

Thorium Chloride

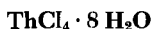

A solution of thorium hydroxide in excess hydrochloric acid is evaporated until sirupy and is then allowed to cool and crystallize.

Further purification, in particular, removal of Fe and SiO_2 , is best achieved by shaking with an ether-aqueous hydrochloric acid mixture. The experimental arrangement is the same as described for the preparation of $(\text{NH}_4)_2[\text{TiCl}_6]$, p. 1199.

The crystals are dissolved in the minimum quantity of 6N HCl, filtered through asbestos, and shaken twice with ether to remove the iron. Silicic acid precipitates during the evaporation and is also filtered off. The filtrate is cooled to 0°C , and HCl gas is passed through until saturation. An equal volume of ether is added and the mixture is treated with additional HCl until homogeneous. Pure white crystals of $\text{ThCl}_4 \cdot 8\text{H}_2\text{O}$ crystallize; these are filtered, washed with ether, and dried.

PROPERTIES:

Formula weight 518.08. Deliquescent in moist air, readily soluble in water and alcohol. Soluble in ethylenediamine.

REFERENCES:

C. B. Kremer. J. Amer. Chem. Soc. 64, 1009 (1942); T. Muniyappan. Master's Dissertation, University of Illinois, 1955.

Titanium (IV), Zirconium (IV) and Thorium (IV) Iodides

TiI_4 (ZrI_4 , ThI_4)

Syntheses I and II (described below) start from crude Ti (prepared from TiCl_4 and Na), which is allowed to react with I_2 vapor, while in method III a commercial fine Ti-Al alloy powder (Altam 70%, i.e., containing 70% Ti) is boiled in a solution of I_2 in CS_2 . Upon removal of the solvent, the AlI_3 is bound in a non-volatile complex KAlI_4 , while the TiI_4 is distilled off. This method is recommended for larger-scale preparations.

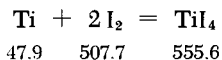

I. Crude Ti (20 g.) is treated with dilute hydrofluoric acid, washed with distilled water and alcohol, and dried. It is then placed in the center bulb *e* of the apparatus shown in Fig. 297, which is sealed off at *f* as close to the bulb as possible. The apparatus is made of high-melting glass, preferably fused quartz ware if highest purity is to be obtained. Filling tube *a* is closed off with a rubber stopper; the system is evacuated and dried by fanning with a flame while vacuum is maintained. The stopper at *a*

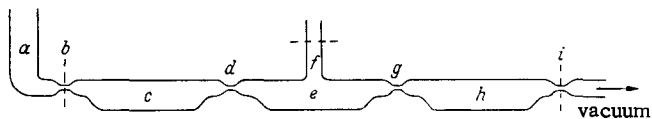

Fig. 297. Preparation of titanium (IV) iodide according to the method of Blocher and Campbell.

is removed for a while, and doubly sublimed, carefully dried I_2 (100 g.) is added via tube *a*. The I_2 is melted and transferred as a melt into bulb *c*, which is then sealed off at *b*. Bulb *c* is cooled with Dry Ice; the system is evacuated to 10^{-3} mm. and sealed at *i*. The center bulb is heated to $525^\circ C$, and the two side bulbs are alternately heated and cooled with air, to produce a slow stream of I_2 vapor which flows back and forth over the heated metal. The reaction is complete after three passes. The conversion is quantitative, based on the metal content of the Ti. Nonmetallic impurities are left as a residue in *e*. If the compound is to be resublimed or subdivided into portions, additional bulbs are fused onto *h* as described in the preparation of $BeCl_2$ (p. 889).

II. If a particularly pure product is desired, one may proceed as follows: 2 g. of Ti powder is placed in section *a* of the Pyrex apparatus shown in Fig. 298 and heated for one hour at $500^\circ C$ in high vacuum (provided by a pump attached at *o*). The material is then cooled to room temperature, and thin glass partition *d* is broken by means of a magnet and steel ball *g* (which is then removed from the system by sealing off at *h*); bulb *b*, which contains 10 g. of I_2 , is thus connected to the rest of the apparatus. The latter is now sealed off at *i* and the pump is turned off. The I_2 vapor reacts immediately (sometimes slight heating is necessary) with the Ti to give a quantitative yield of TiI_4 (in the preparation of ZrI_4 , it is necessary to heat the apparatus for several hours in an electric furnace at $200^\circ C$). When the reaction is complete, the apparatus is sealed off at *m*. After breaking partition *f*, the gases liberated during the reaction are removed by means of a high-vacuum pump connected at *q*. The system is resealed at *k*, the TiI_4 is sublimed from *a* into *c* by heating the former, and constriction *n* is sealed off. The pump may now be connected at *p*, *e* broken, and any gas

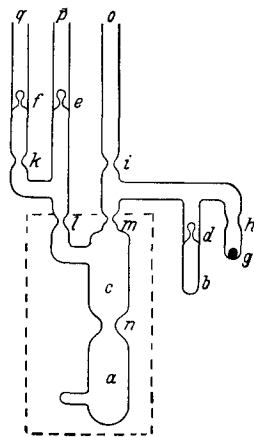

Fig. 298. Preparation of titanium (IV) iodide according to Fast: *d*, *e* and *f* are break-seal valves; *g* is a steel ball.

evolved during the sublimation removed. The compound may then be removed, as desired, through *p*. If the TiI_4 is to be stored, the system is sealed off at *l*.

The preparation of ZrI_4 or ThI_4 is similar.

III. In the method of Blumenthal and Smith, the apparatus (Fig. 299) consists of a two-liter, long-neck, round-bottom flask *a*, two smaller round-bottom flasks *b* and *c* (500 ml., 250 ml. respectively), a condenser and a receiving flask *d* (250 ml.). The multihole rubber stopper in the large flask carries the following: 1) an annular heating device consisting of a glass tube *g* which terminates at the bottom in a closed sphere; steam is introduced via a thin inner rubber tube which reaches down to the sphere; 2) a dropping funnel; 3) a reflux condenser; and 4) a glass tube with a larger-diameter filter section (the latter is in flask *a* and is filled with glass wool). All openings to the atmosphere are protected with drying tubes filled with silica gel. Before the start of the preparation, 10 g. of KI is placed in flask *b*. The apparatus is assembled and dried by fanning with a flame while a stream of air is drawn through. The rubber stopper is raised rapidly and 127 g. of I_2 , dissolved in 600 ml. of CS_2 , and 50 g. of finely powdered Altam 70% alloy (equivalent to 1/2 mole of free Ti, the remainder being the oxide) is added to flask *a*. The solution is brought to a boil by passing steam through the heating device. The heating is

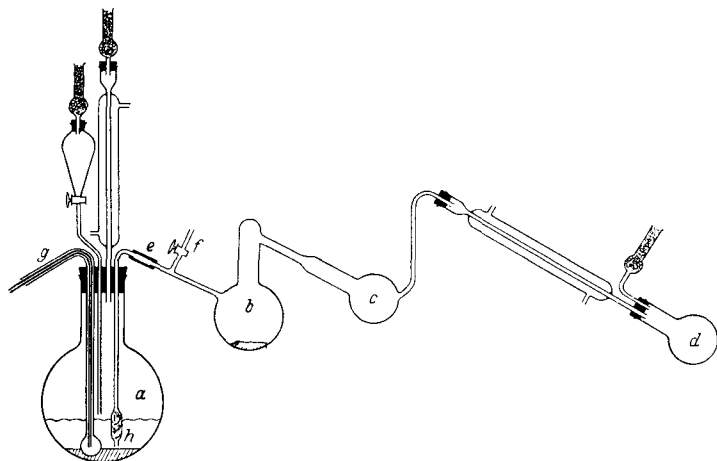

Fig. 299. Preparation of titanium (IV) iodide according to Blumenthal and Smith: *e* rubber connection with pinchcock; *g* steam heater consisting of an outer glass tube with a sphere and an inner rubber tube; *h* filter with glass wool packing.

continued for one hour with occasional shaking, resulting in quantitative formation of the iodides (TiI_4 and AlI_3). These are soluble in CS_2 .

The mixture is cooled to room temperature and compressed dry air is introduced via the reflux condenser, forcing the solution through the glass wool filter and into flask *b*. This transfer is carried out in stages, since the iodide solution in flask *b* must be concentrated from time to time by distilling excess CS_2 into flask *d*. Finally, three 100-ml. portions of CS_2 are added to rinse out the last traces of product in *a*; these are also transferred to *b*.

The rubber connection *e* is closed off with a clamp and flask *a* is removed from the system. Flasks *b* and *c* are heated in a water bath to $80^\circ C$ until all the CS_2 distills into *d*. A slow stream of dry N_2 is introduced through stopcock *f*, and flask *b* is strongly heated with a burner while flask *c* is cooled with cold water; this causes the AlI_3 to react quantitatively with the KI to form nonvolatile $KAlI_4$; the TiI_4 meanwhile distills into *c*. The distillation is ended when colored vapors can no longer be observed.

The crude product (90% yield) contains 95.1% TiI_4 , 4.6% free I_2 and 0.3% iodides of other metals. Since 98% of the CS_2 is recycled, and since KI and I_2 may be recovered from the $KAlI_4$ melt by air oxidation:

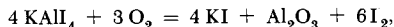

the process is suited for the preparation of large quantities of TiI_4 .

IV. *Alternate method:* If metallic Ti is not available, TiI_4 may be prepared by the method of Hautefeuille (1867). The procedure is similar to method I for the preparation of $TiBr_4$.

The tetraiodides of Ti, Zr and Th may be produced from the oxides with the aid of AlI_3 .

PROPERTIES:

Red-brown octahedra crystallizing in type D 1₁, but transformed on prolonged storage to a modification with a lower degree of symmetry. M.p. $150^\circ C$, b.p. $377^\circ C$; d 4.40. Fumes strongly in air; dissolves rapidly in water with hydrolytic decomposition.

REFERENCES:

- I. J. M. Blocher and I. E. Campbell. *J. Amer. Chem. Soc.* **69**, 2100 (1947); V. Gutmann and H. Tannenberger. *Monatsh. Chem.* **87**, 423 (1956).
- II. J. D. Fast. *Z. anorg. allg. Chem.* **239**, 146 (1938).
- III. W. B. Blumenthal and H. Smith. *Ind. Eng. Chem.* **42**, 248 (1950).
- IV. W. Biltz and E. Keunecke. *Z. anorg. allg. Chem.* **147**, 171

(1925); W. Klemm, W. Tilk and S. von Müllenheim. *Z. anorg. allg. Chem.* 176, 1 (1928); M. Chaigneau. *Comptes Rendus Hebd. Séances Acad. Sci.* 242, 263 (1956); S. Ramamurthy. *J. Sci. Industr. Res.* 14B, No. 8, 414.

Titanium (III) Oxychloride

TiOCl

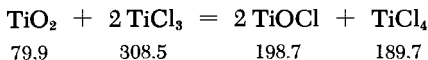

A quartz tube is thoroughly baked while under high vacuum. It is then charged (under a nitrogen blanket) with TiCl_3 (50% excess) and TiO_2 . The tube is evacuated (10^{-5} mm.), sealed off and placed in a furnace with a temperature gradient so that one third of the tube, containing the TiO_2 - TiCl_3 mixture, is at 650°C while the remainder is at 550°C . The reaction ends in about 12 hours; the excess TiCl_3 and a small amount of yellowish-brown crystals of TiOCl pass into the cold zone. The hot zone contains a brown, finely crystalline cake of TiOCl . If heating in the temperature gradient is continued for several days all of the TiOCl migrates to the colder zone and deposits as beautiful long crystals. The TiOCl is isolated by distilling the TiCl_4 into the empty half of the tube, freezing it there, and cutting the tube in two. The mixed crystals of TiOCl and TiCl_3 are then treated with dimethylformamide, in which TiCl_3 dissolves readily, forming a blue solution. The TiOCl residue is repeatedly washed with dimethylformamide, followed by alcohol and ether, and dried in vacuum.

The compound may also be prepared by a similar procedure via the reaction of TiCl_3 with Fe_2O_3 , SiO_2 , H_2O or O_2 .

PROPERTIES:

Golden-yellow to red-brown crystals; decomposes slowly in air. Decomposes to TiO_2 and TiCl_4 on heating in an open annealing tube.

REFERENCE:

H. Schäfer, F. Wartenpfehl and W. Weise, *Z. anorg. allg. Chem.* 295, 268 (1958).

Titanium (IV) Oxychloride

TiOCl₂

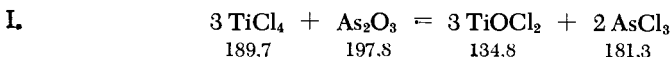

An excess of TiCl_4 is treated with As_2O_3 , resulting in a highly exothermic reaction which goes to completion if caking of the

solid product is avoided. The yellowish substance obtained is freed of AsCl_3 and excess TiCl_4 by suction filtration in the absence of air and thorough washing with absolute pentane or CCl_4 . Residual solvent is removed by vacuum distillation at room temperature. The product contains traces of arsenic.

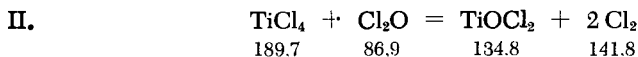

A stream of Cl_2O diluted with dry O_2 is introduced through a large-diameter inlet tube into a two-neck 250-ml. flask containing about 100 ml. of TiCl_4 (the TiCl_4 is distilled into the flask under conditions of complete exclusion of moisture). The gas is prepared by passing a stream of $\text{O}_2\text{-Cl}_2$, predried with P_2O_5 , over HgO . The latter is contained in a glass tube provided with a cooling jacket and able to rotate (Liebig condenser).

Plugging of the inlet tube with solid TiOCl_2 is prevented by sealing a glass spatula to the bottom of the flask in such a way that it projects a few centimeters into the tube. Occasional rotation of the flask around the inlet tube then keeps the latter free.

The $\text{O}_2\text{-Cl}_2\text{O}$ mixture is bubbled in until the formation of a crystalline paste makes this impossible. The mixture is allowed to stand overnight, whereupon any small quantity of hypochlorite still present decomposes to Cl_2 and additional TiOCl_2 . The product is filtered in the absence of moisture and washed several times with high-purity CCl_4 which has been distilled over P_2O_5 ; the product is freed of the CCl_4 by evaporating the latter in a stream of a dry gas, and is then kept in vacuum for a short time.

The yield is practically quantitative, based on Cl_2O ; based on TiCl_4 actually used, it is about 50%.

PROPERTIES:

Pale yellow, hygroscopic, crystalline powder. Sparingly soluble in CCl_4 , benzene and similar solvents, moderately soluble in ethyl acetate, readily soluble in ethereal hydrochloric acid (decomposition). Hydrolyzes in moist air, giving a white color. Dissociation to TiCl_4 and TiO_2 begins at 180°C . d 2,45.

REFERENCES:

- I. P. Ehrlich and W. Engel. *Z. anorg. allg. Chem.* **322**, 217 (1963).
- II. K. Dehnicke. *Angew. Chem.* **75**, 417 (1963); *Angew. Chem.* (International Ed. in English) **9**, 325 (1963).

Zirconium Oxychloride



The anhydrous compound is unknown. Of the existing hydrates, with 2, 3, 5, 6 and 8 moles of H_2O , the last is the most important,

since it crystallizes as a sparingly soluble compound from aqueous solutions containing HCl. In a solution containing about 1.2 g. of $ZrOCl_2 \cdot 8H_2O$ per 100 ml. of H_2O , the flat minimum section of the solubility curve corresponds to a concentration of 7-8 moles of HCl/liter at $0^\circ C$. The octahydrate is readily recrystallized and can therefore be prepared in very pure form.

PREPARATION

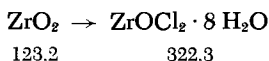

I. Since zircon $ZrSiO_4$, a mineral found in nature, is more difficult to work with, it is better to start from zirconia ZrO_2 (baddeleyite), which is calcined, finely ground (the coarser particles are screened off with silk gauze), and converted to the sulfate by evaporation or treatment for several days with an excess of warm conc. H_2SO_4 . The solid residue, which consists of $Zr(SO_4)_2$ and unreacted ZrO_2 , is taken up in water (the solid is added in small portions to prevent heating of the solution). The sulfate dissolves slowly, and its solution may be aided by acidifying the water with some hydrochloric acid. The resultant milky suspension, which contains solid undissolved ZrO_2 and SiO_2 (or $ZrSiO_4$), is allowed to stand for several hours and filtered.

The weakly acidic sulfuric acid solution is precipitated with ammonia and the hydroxide is filtered off. If the precipitate still exhibits a high Si content, it is dissolved in conc. hydrochloric acid and the solution is evaporated to dryness; this procedure is repeated several times. On redissolving in water, SiO_2 and some basic zirconium chloride become the insoluble residue. If no Si is evident in the hydroxide, the fresh gel is dissolved in cold hydrochloric acid and the oxychloride is allowed to crystallize by adding conc. hydrochloric acid or saturating with HCl. The crystals are filtered and washed with 8N HCl.

II. When the starting material is high in SiO_2 and, in general, if a platinum dish is available, the ZrO_2 may be evaporated with a mixture of conc. H_2SO_4 and 40% hydrofluoric acid instead of with pure H_2SO_4 . The temperature required for this procedure is lower than in the preceding method. The subsequent steps are as described in method I.

III. The octahydrate $ZrOCl_2 \cdot 8H_2O$ may also be prepared as follows. A suspension of freshly precipitated zirconium hydroxide in H_2O is dissolved in cold dilute hydrochloric acid; after filtering, the $ZrOCl_2 \cdot 8H_2O$ is crystallized by evaporation (if necessary, by

adding conc. hydrochloric acid). The starting zirconium hydroxide is prepared by precipitating a solution of K_2ZrF_6 with ammonia; the precipitate, which contains a basic fluoride, must be treated for a short time with conc. H_2SO_4 (to remove the HF) and re-dissolved in H_2SO_4 . The pure hydroxide is precipitated with ammonia.

IV. $ZrCl_4$ is dissolved in water (do not heat to dissolve—if necessary, add some hydrochloric acid); the solution is filtered and the oxychloride is precipitated by making the solution 7-8N in HCl.

The crude chlorination products of those zirconium-containing minerals that are difficult to breakdown must be rechlorinated with Cl_2 at $1000^\circ C$, yielding crude chlorides, which can then be purified via method IV.

PREPARATION BY RECRYSTALLIZATION OF THE OXYCHLORIDE

V. The fact that $ZrOCl_2 \cdot 8H_2O$ dissolves readily in water and is insoluble in 7-8N (25-30%) hydrochloric acid allows this compound to be used as an intermediate in the purification of Zr salts. Although complete isolation of zirconium cannot be achieved, this method eliminates not only Al, Fe, Nb, Ta, the rare earths and many other elements, but also Ti, the removal of which otherwise involves great difficulties. Thus, for example, the Al content may be reduced from 0.035% to 0.0015% by only one recrystallization; the decrease in Fe content is of the same order of magnitude. Reprecipitation of the oxychloride is thus more effective than that of the sulfate, described on p. 1232.

Since the molar solubility of $HfOCl_2 \cdot 8H_2O$ is identical to that of the Zr salt, the Hf/Zr ratio remains unchanged.

The strongly acidic HCl solution of $ZrOCl_2 \cdot 8H_2O$ is evaporated on a water bath until crystallization is incipient and is then treated with an equal volume of conc. hydrochloric acid; the mixture is heated (do not allow too much HCl to escape) and, if necessary, 25% hydrochloric acid is added to the warm mixture until solution is complete and the mixture contains, at most, 39 g. of oxychloride, i.e., 15 g. of ZrO_2 per 100 ml. The solution is mechanically stirred and its temperature is allowed to drop to a point where it still feels warm to the hand; it is then cooled with ice. After stirring for 30 minutes at $0^\circ C$, the product is filtered through a medium-porosity fritted glass and washed with 25% hydrochloric acid pre-cooled to $0^\circ C$.

The filtrate still contains about 1.5 g. of the oxychloride (or 0.6 g. of ZrO_2) per 100 ml.

VI. A simpler method gives a less complete precipitation. One proceeds as follows.

First 25 g. of $ZrOCl_2 \cdot 8H_2O$ is dissolved in a mixture of 6 ml. of conc. hydrochloric acid and 100 ml. of H_2O . The solution is heated to $70^\circ C$ and filtered. The filtrate is concentrated to 75 ml. and allowed to cool without stirring. The crystallizing salt is suction-filtered on a fritted glass and washed with a cold 1:1 alcohol-conc. hydrochloric acid mixture, in which the oxychloride is very sparingly soluble. The yield is 10 g. of purified material; an additional 7 g. may be recovered from the mother liquor by further evaporation and crystallization.

SYNONYM:

Zirconyl chloride.

PROPERTIES:

Tetragonal prisms or needles. Deliquescent in moist air, evolves HCl and becomes dull in dry air. Soluble in H_2O (slight hydrolysis) and alcohol. Lower hydrates are formed on heating in a stream of HCl. Liberates HCl on heating in air and the solubility in water is gradually lost; reverts to the oxide on calcination.

Precipitation of an alcoholic solution with ether or acetone yields dizirconyl chloride $Zr_2O_3Cl_2 \cdot 5H_2O$, which is sparingly soluble in water. The same compound deposits when a dilute aqueous solution of zirconyl chloride is allowed to stand for a month.

Hafnium Oxychloride

The preparation and properties of $HfOCl_2 \cdot 8H_2O$ are virtually identical to those of the Zr compound.

REFERENCES:

- I. M. Falinski. *Ann. Chimie* [11] 16, 237 (1941).
- II. L. Moser and R. Lessing. *Monatsh. Chem.* 45, 327 (1924); B. A. Lister. *J. Chem. Soc. (London)* 1951, 3123.
- III. F. P. Venable and J. M. Bell. *J. Amer. Chem. Soc.* 39, 1599 (1917); M. M. Smith and C. James. *J. Amer. Chem. Soc.* 42, 1765 (1920); O. Hönigschmid, E. Zintl and F. González. *Z. anorg. allg. Chem.* 139, 293 (1924).
- IV. See also H. von Siemens and H. Zander. *Wissenschaftl. Veröffentl. Siemens* 2, 484 (1922); W. B. Blumenthal. *J. Chem. Education* 39, 607 (1962).
- V. W. Fischer and M. Zumbusch. *Z. anorg. allg. Chem.* 252, 249 (1944); see also O. Hönigschmid, E. Zintl and F. González. *Z. anorg. allg. Chem.* 139, 293 (1924) or E. H. Archibald. *The Preparation of Pure Inorganic Substances*, New York, 1932, p. 187.

VI. W. C. Schumb and E. Pittman in: W. C. Fernelius, *Inorg. Syntheses*, Vol. II, New York-London, 1946, p. 121.

Lower Titanium Oxides

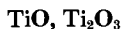

I. The surest preparation of defined lower Ti oxides involves sintering with metallic Ti.

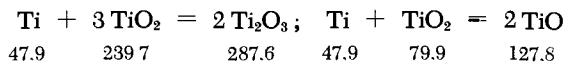

Filings are prepared from a Ti sheet and ground to pinhead size; a magnet is used to free them from the Fe picked up during the machining operation. The filings are etched with dilute hydrofluoric acid, rinsed with acetone, and rapidly dried. They are mixed with TiO_2 in proper amounts and the mixture is pressed into tablets or rods; these are heated in high vacuum to 1600°C in the arrangement illustrated in Fig. 300.

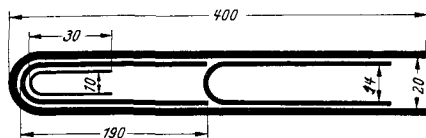

Fig. 300. Synthesis of lower titanium oxides (dimensions in mm.).

Two Tammann crucibles (10 mm. and 14 mm. I.D.), made of sintered clay, are placed one inside the other, and the assembly is placed in a tube (20 mm. I.D. and 400 mm. long) made of the same material and closed at one end. The 14-mm. crucible is loosely covered by the closed end of an identical crucible, as shown. The outer (20 mm. I.D.) tube is connected to a high-vacuum system via a ground joint cemented on with picein. This arrangement of three concentric tubes is needed because the outer corundum tube is not vacuum-tight at the reaction temperature of 1600°C . The gas used for flushing the annular space between the surrounding graphite heater and the inner corundum tube is hydrogen, which diffuses inside. Thus, in new tubes, the inside pressure rises from a satisfactory high vacuum to 1 mm. within 10 minutes at 1600°C ; the pressure rises even more rapidly in older tubes. The pump must therefore be left on during the entire heating period. The above arrangement of crucibles prevents the hydrogen from diffusing to the reactants before it can be removed by the vacuum pump.

The mixture is heated at 1600°C for 15 minutes in a Tammann furnace; this is obviously insufficient to bring about complete reaction. The Ti is not completely consumed, but it becomes so brittle that it is readily pulverized in an agate mortar. This fine powder is reheated and the product is then homogeneous.

If Ti powder is used as the starting material, a single but longer heating run is sufficient (1/2 hour at 1600°C).

Materials with a low oxygen content are best subjected to a preliminary homogenization treatment, either by high-frequency heating in high vacuum, or by so-called button-melting in an electric arc, which is familiar in titanium metallurgy.

The above procedure is generally applicable and may be used for the preparation of lower oxides of other elements closely related to titanium, e.g., Zr, Hf, V, Nb, etc.

In many cases it has proved more convenient not to start each run from the metal; in those cases, a larger quantity of the low-oxygen compound is prepared and then used as a stock raw material.

II. Reduction of TiO_2 in a stream of H_2 at 1250°C yields a product of composition $\text{TiO}_{1.6}$, at 1430°C and longer reaction times up to $\text{TiO}_{1.46}$. At 1000°C, the reduction of TiO_2 in a TiCl_4 -saturated stream of H_2 also yields a small amount of violet-colored Ti_2O_3 , besides the other products.

III. When TiO_2 is reduced with carbon, the formation of mixed TiO-TiC crystals cannot be entirely prevented. According to Shomate, heating in vacuum at 1400°C for 20 hours yields Ti_2O_3 via the reaction $2 \text{TiO}_2 + \text{C} = 2 \text{Ti}_2\text{O}_3 + \text{CO}$, in agreement with the observations of Junker, who found that significant amounts of carbide are formed only above 1600°C.

PROPERTIES:

TiO: Formula weight 127.80. Golden yellow powder. M.p. 1750°C; d 4.89. Crystal structure: type B1 (NaCl type). The rock salt phase is homogeneous over a wide range of compositions ($\text{TiO}_{1.3}$ - $\text{TiO}_{0.8}$). TiO dissolves in dilute hydrochloric and sulfuric acids with partial oxidation: $\text{Ti}^{2+} + \text{H}^+ = \text{Ti}^{3+} + \frac{1}{2} \text{H}_2$.

Ti_2O_3 : Formula weight 143.80. Dark violet powder. M.p. ~1900°C; d 4.49. Crystal structure: type D5₁.

REFERENCES:

- I. P. Ehrlich, Z. Elektrochem. 45, 362 (1939); see also S. Andersson, B. Collén, U. Kuylenstierna and A. Magnéli, Acta Chem. Scand. 11, 1641 (1957).

- II. E. Friederich and L. Sittig. *Z. anorg. allg. Chem.* **146**, 127 (1925); Y. Belyakova, A. Komar and V. Mikhailov. *Metallurg* **14**, 23 (1939); G. Lunde. *Z. anorg. allg. Chem.* **164**, 341 (1927); G. Brauer and W. Littke. *J. Inorg. Nuclear Chem.* **16**, 67 (1960).
- III. C. H. Shomate. *J. Amer. Chem. Soc.* **68**, 310 (1946); E. Junker. *Z. anorg. allg. Chem.* **228**, 97 (1936).

Titanium (IV) Oxide

TiO₂

Titanium (IV) oxide crystallizes in three modifications of decreasing stability: rutile, anatase and brookite. Whether the synthesis of brookite has been achieved is still in doubt. Anatase is formed via the hydrolysis of Ti halides at not too high a temperature (600°C) or via low-temperature calcining (~700°C) of precipitated titanic acid. The lattice is stabilized by adsorbed anions, among which the most effective are sulfate and phosphate. Pure TiO₂ calcined at high temperature always yields the rutile lattice.



Very pure TiO₂ is readily prepared by hydrolysis of pre-purified and repeatedly distilled TiCl₄. The chloride is hydrolyzed in Pyrex vessels cooled in ice and the residual titanic acid is precipitated by addition of ammonia. The mixture is boiled for one hour, filtered and thoroughly washed until free of chloride (if necessary, the precipitate is redissolved in hydrochloric acid before washing, and precipitated with ammonia). The precipitate is dried at 107°C and calcined for one hour at 800°C. The product should be ground to a fine powder, rewashed until free of chloride, and calcined at 1000°C. After calcination, the TiO₂ so prepared is white or light gray. A yellow tinge indicates traces of iron.

Alternate methods:

II. A more readily filtered precipitate is obtained when the precipitation is carried out in the presence of (NH₄)₂SO₄. Commercial TiCl₄ (900 g.) is slowly added to one liter of distilled water, and the solution is purified by boiling for 10 minutes and removing SiO₂ and any insoluble impurities by filtration. A solution of 1300 g. of (NH₄)₂SO₄ in two liters of distilled water acidified with 25 ml. of conc. hydrochloric acid is treated in a similar manner. The two solutions are cooled, combined with stirring, and brought to a boil. The pH is adjusted to 1.0 by addition of

ammonia. At $\text{pH} < 1$, the yield is lower, while at $\text{pH} > 1$ the Fe content of the product may exceed 0.003%. Further treatment is the same as in (I). The yield is almost quantitative, and a rutile powder with a TiO_2 content exceeding 99.8% is obtained.



A solution of K_2TiF_6 (which has been recrystallized several times) in hot water is prepared, and ammonia is added to precipitate the snow-white $\text{TiO}_2 \cdot \text{aq}$. The precipitate is thoroughly washed, dried and calcined.



This may be achieved by hydrolysis of titanium sulfate solutions on prolonged boiling. However, this procedure is not recommended since it requires a long time (eight hours) and the resultant precipitates are difficult to filter; precipitation with ammonia at the boiling point is preferred.



The following procedure for the preparation of rutile differs fundamentally from the previous methods. Absolutely dry O_2 and TiCl_4 vapor are passed for 20 hours through a 20-mm.-I.D. porcelain tube heated to 650-750°C. Colorless to light-yellow, lustrous crystals of rutile are deposited on the white reactor walls. Unreacted TiCl_4 is collected in a receiver cooled with ice-salt. Toward the end of the preparation, pure O_2 is passed through the tube, and this stream is continued while the mixture is cooling.

SYNONYM:

Titanium dioxide.

PROPERTIES:

Rutile: type C4, d 4.22; anatase: type C5, d 4.06; brookite: type C21, d 4.13. M.p. 1870°C; thermal dissociation above 1800°C is evident from the appearance of a bluish tinge and a lower melting point.

Amorphous TiO_2 is also insoluble in water and dilute acids. It dissolves slowly in hot conc. H_2SO_4 , better in alkali hydrogen

sulfates. The solubility is strongly dependent on the prior thermal treatment.

REFERENCES:

- I. A. V. Pamfilov, Y. G. Ivancheva and K. F. Trekhletov. Zh. Obschey Khimii 13, 1310 (1940); C. H. Shomate. J. Amer. Chem. Soc. 69, 218 (1947).
- II. W. B. Blumenthal. Ceramic Age 51, 320 (1948).
- IV. Tscheng Da Tschang. Bull. Soc. Chim. France [5] 3, 271 (1936); A. W. Czanderna, A. F. Clifford and J. M. Honig. J. Amer. Chem. Soc. 79, 5407 (1957).
- V. H. Rheinboldt and W. Wisfeld. Ber. dtsch. chem. Ges. 67, 375 (1934).

Titanium (IV) Oxide Hydrate

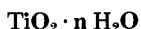

I. Compounds belonging to the system $\text{TiO}_2\text{-H}_2\text{O}$ prepared in the usual way (e.g., by precipitation with ammonia from an aqueous solution of K_2TiF_6) may be regarded as composed of TiO_2 and labile H_2O . Part of the water, however, is bound and localized; its amount depends on the method of preparation. Precipitated, hydrated TiO_2 either exhibits an amorphous x-ray pattern or consists of anatase containing adsorbed water; similar lattices are formed by the products of hydrolysis of $\text{Ti}(\text{SO}_4)_2$ solutions (refluxing for four hours), while hydrolysis of TiCl_4 and $\text{Ti}(\text{NO}_3)_4$ solutions under identical conditions yields rutile.

II. "Orthotitanic acid" H_4TiO_4 or $\text{TiO}_2 \cdot 2 \text{H}_2\text{O}$ seems to form only under certain definite conditions; using the Willstätter acetone method at low temperature (0°C), it was possible to prepare a compound of composition $\text{TiO}_2 \cdot 2.16\text{H}_2\text{O}$.

REFERENCES:

- For general references, see R. Fricke, Das System $\text{TiO}_2/\text{H}_2\text{O}$ in R. Fricke and G. F. Hüttig, Hydroxyde und Oxyhydrate [Hydroxides and Oxide Hydrates], Leipzig, 1937, p. 211.
- I. H. B. Weiser and O. W. Milligan. J. Phys. Chem. 38, 513 (1934); O. Glemser. Z. Elektrochem. 45, 820 (1939); W. Biltz, G. A. Lehrer and O. Rahlfs. Z. anorg. allg. Chem. 244, 281 (1940).
 - II. R. Schwarz and H. Richter. Ber. dtsch. chem. Ges. 62, 31 (1929); R. Willstätter. Ibid. 57, 1082 (1924).

Peroxotitanic Acid

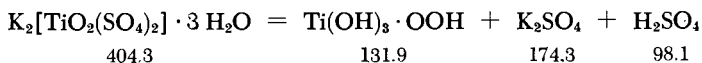
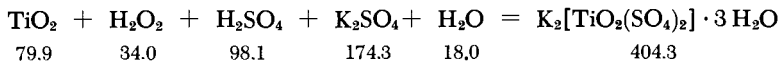

According to Schwarz and coworkers, 5 g. of titanic acid hydrate (Merck) is dissolved in 10 ml. of warm conc. H_2SO_4 ; the solution is diluted to three times its volume with water, cooled to -10°C , placed in a dropping funnel, and added to a solution of 8.6 g. of K_2SO_4 in 15 ml. of 30% H_2O_2 . The mixture is cooled to 0°C and allowed to stand in the cold for 1/2 hour; it is then precipitated by addition of about one liter of ice-cold acetone pretreated with H_2O_2 until the appearance of the color of titanium sulfate (alcohol may cause partial reduction of the solution, yielding a product deficient in active oxygen). The precipitate is filtered with suction and washed with ice-cold absolute ether until the filtrate gives a negative reaction with permanganate. The product is dried for several hours in high vacuum at the lowest possible temperature, yielding yellow-red potassium peroxytitanyl sulfate corresponding to the formula $\text{K}_2[\text{TiO}_2(\text{SO}_4)_2] \cdot 3\text{H}_2\text{O}$.

According to K. F. Jahr (see FIAT-Review, Anorganische Chemie, Part III, p. 173) the color is due not to the complex anion, but to the peroxytitanyl cation itself. See also E. Gastinger, Z. anorg. allg. Chem. 275, 331 (1954).

In the preparation of the corresponding zirconium and hafnium salts, which are white but have an analogous structure, the indicated concentrations of the reactants must be very strictly adhered to.

If the complex salt is to be used immediately, purification by thorough washing suffices. The precipitate is dissolved on the filter in ice water and the solution is poured into 10 liters of ice-cold water. Gradual deposition of the pure white precipitate sets in after some time and the precipitation is complete after about 24 hours. The product is purified by filtering, washing with ice water followed by acetone; any adsorbed water is removed by agitating in a shaker flask (three times with 100 ml. of acetone, once with 100 ml. of absolute ether, three times with petroleum ether—all washing operations at 0°C). The remaining petroleum ether is removed by suction and the product is left for about 0.5 hour in a vacuum desiccator which does not contain a drying agent.

The peroxide hydrates of Zr, Hf and Th are prepared by treating a solution of the sulfate (5-10%, based on the oxide content) with an excess of 30% H_2O_2 , cooling to -20°C , and precipitating with ammonia below 0°C . The slimy precipitate is removed by

suction from the cooled container with the aid of a filter candle and washed with ice water. The only suitable drying method is the ammonia extraction process described by W. Blitz [Z. Elektrochem. 33, 491 (1927)].

PROPERTIES:

Ti(OH)₃ · OOH: Slightly hygroscopic, lemon-yellow powder. Gradually loses its active oxygen at room temperature, with resultant decoloration. Readily soluble without decomposition in dilute H₂SO₄; loses oxygen gradually in water.

REFERENCES:

- R. Schwarz and W. Sexauer. Ber. dtsch. chem. Ges. 60, 500 (1927); R. Schwarz and H. Giese. Z. anorg. allg. Chem. 176, 209 (1928); see also R. Schwarz and F. Heinrich. Z. anorg. allg. Chem. 233, 387 (1935).

Zirconium (IV) Oxide

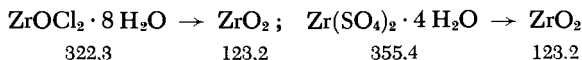

Zirconium (IV) oxide is formed when zirconium oxide hydrates or zirconium salts of volatile, oxygen-containing acids (nitrates, oxalates, acetates, etc.) are dehydrated and then calcined.

Usually the oxychloride or sulfate is thermally decomposed between 600 and 1000°C. Either salt must be prepurified by repeated recrystallization. In the case of the sulfate, the thermal decomposition removes the last traces of SO₃ with some difficulty.

The amorphous ZrO₂, which is the first product obtained on heating the oxychloride (300°C), converts at 500°C to the tetragonal modification, which then contains only traces of Cl. Above 600°C the material is monoclinic.

Alternate methods: a) For the almost complete decomposition of ZrOCl₂ · 8H₂O with superheated steam (accompanied by evolution of HCl and formation of ZrO₂) see Akhrap-Simonova.

b) The preparation of ZrO₂ by removal of silicon from ZrSiO₄ with SiO is described by Zintl et al.

PROPERTIES:

White powder. M.p. 2680°C, b.p. 4300°C; d 5.73. Exists in several modifications. Crystal structure: tetragonal and monoclinic.

The chemical behavior is strongly affected by the nature of the prior thermal treatment. If the compound has been heated to moderate temperatures, it dissolves quite readily in mineral

acids; after heating to high temperatures, it is soluble only in hydrofluoric acid and conc. H_2SO_4 ; after melting, it is attacked only by hydrofluoric acid. Decomposes readily in alkali hydroxide or carbonate melts, in which it forms acid-soluble zirconates.

REFERENCES:

- O. Ruff et al. *Z. anorg. allg. Chem.* **133**, 193 (1924); **180**, 19 (1929); W. M. Cohn and S. Tolksdorf. *Z. phys. Chem. (B)* **8**, 331 (1930); G. L. Clark and D. H. Reynolds. *Ind. Eng. Chem.* **29**, 711 (1937); L. K. Akhrap-Simonova. *Zh. Prikl. Khimii* **11**, 941 (1938); E. Zintl, W. Bräuning, H. L. Grube, W. Krings and W. Morawietz. *Z. anorg. allg. Chem.* **245**, 1 (1940); A. W. Henderson and K. B. Higbie. *J. Amer. Chem. Soc.* **76**, 5878 (1954).

See also R. Fricke, *Das System $\text{ZrO}_2/\text{H}_2\text{O}$* in R. Fricke and G. F. Hüttig, *Hydroxyde und Oxyhydrate [Hydroxides and Oxide Hydrates]*, Leipzig, 1937, p. 219, especially for the formation of oxide hydrates.

Hafnium (IV) Oxide



Hafnium (IV) oxide is prepared by calcination of the hydroxide, oxalate, oxychloride or sulfate at 600-1000°C. The crystallization of the oxide starts at 400°C.

PROPERTIES:

White powder. M.p. 2780°C; d 9.68. Essentially identical with ZrO_2 in chemical behavior. It probably forms the same types of crystal lattice.

REFERENCE:

- G. von Hevesy and V. Berglund. *J. Chem. Soc. (London)* **125**, 2373 (1924).

Thorium (IV) Oxide



- I. $\text{Th}(\text{NO}_3)_4 \cdot 4 \text{H}_2\text{O}$ or $\text{Th}(\text{NO}_3)_4 \cdot 5 \text{H}_2\text{O}$ or $\text{Th}(\text{C}_2\text{O}_4)_2 \cdot 6 \text{H}_2\text{O} \rightarrow \text{ThO}_2$
 552.2 570.2 516.3 264.1

Thorium (IV) oxide is obtained by thermal decomposition of thorium oxide hydrate (which is precipitated with ammonia) or salts of oxygen-containing acids. The nitrate and oxalate are especially suitable as starting materials, while the sulfates give off the last traces of SO_3 only with difficulty.

Pure nitrate is placed in a large evaporation dish and is very carefully heated in an electric furnace. The nitrate swells

considerably at 300-400°C and forms a spongy mass, which subsequently collapses and becomes more compact. To prevent the uptake of SiO₂ during calcination of the oxide, the powder obtained on decomposition of the nitrate is placed in a Pt crucible and is then heated for 1-2 hours at 800-850°C.

The oxalate Th(C₂O₄)₂·6H₂O gives off its water of crystallization at 300°C and is almost entirely decomposed to the oxide (the weight of the final products is <1% greater than the theoretical) at 450°C.

II. According to Brintzinger and Möllers, active oxide is obtained when thorium chloride, nitrate or sulfate is decomposed with steam at 800°C.

III. For the preparation of oxide hydrates and hydroxides, see the references indicated.

PROPERTIES:

White powder, compact or loose depending on the method of preparation. M.p. 3050°C, b.p. 4400°C; d 9.87. Crystal structure: type C1 (fluorite type). Almost insoluble in acids when calcined at high temperatures, although readily decomposed in bisulfate melts or by evaporation with conc. H₂SO₄. In contrast to TiO₂ and ZrO₂, does not form salts with basic oxides and is therefore insoluble in molten NaOH or Na₂CO₃. The oxide prepared by calcination of the oxalate at 500°C may be dissolved by peptization with dilute hydrochloric acid.

REFERENCES:

- I. J. W. Marden and H. C. Rentschler. *Ind. Eng. Chem.* **19**, 97 (1927); H. J. Born. *Z. phys. Chem. (A)* **179**, 256 (1937).
- II. H. Brintzinger and A. Möllers. *Z. anorg. Chem.* **254**, 343 (1947).
- III. R. Fricke. *Das System ThO₂/H₂O in:* R. Fricke and G. F. Hüttig, *Hydroxyde and Oxyhydrate [Hydroxides and Oxide Hydrates]*, Leipzig, 1937, p. 228; W. Biltz. *Z. anorg. allg. Chem.* **244**, 281 (1940); M. Dominé-Bergès. *Ann. Chimie [12]* **5**, 106 (1950).

Titanium, Zirconium and Thorium Sulfides

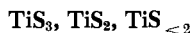

TiS₃, TiS₂

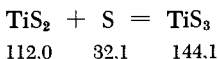
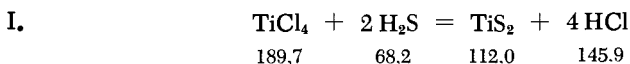

Titanium (IV) sulfide TiS₂ is usually prepared by the reaction of a gaseous mixture of TiCl₄ and H₂S in a red-hot tube. A

chlorine-free product cannot be obtained without an aftertreatment with S in a pressure tube at 600°C. The yield is also unsatisfactory (30-40%, based on the TiCl_4); however, the yield may be increased by repeated passage of the unreacted TiCl_4 from the receivers.

The reaction is carried out in the apparatus shown in Fig. 301; it consists of a Pyrex combustion tube fused at both ends to 100-ml. round-bottom flasks. Flask *a* is filled with 50 g. of freshly distilled TiCl_4 and is then sealed off at *c*; *b* is a receiver for unreacted TiCl_4 , and is cooled with ice-salt. A Stock receiver cooled with Dry Ice and containing about 25 ml. of liquid H_2S is connected to the system at *d* via a small wash bottle filled with glycerol (this is the bubble counter) and two CaCl_2 drying tubes. A fast stream of H_2S , generated by gradual removal of the coolant, is passed through the apparatus while the combustion tube is heated to 480-540°C. The TiCl_4 in *a* is then heated almost to the boiling point and held at this temperature with a small flame. The TiCl_4 - H_2S gas mixture reacts in the tube to form HCl and TiS_2 ; the latter settles on the tube wall. After all the TiCl_4 is distilled from *a*, the system is flushed for a short time with H_2 or CO_2 , the H_2S line is reconnected at *e*, and the unreacted TiCl_4 condensed in *b* is passed again through the tube, this time into *a*. After the TiCl_4 has been used up (3-5 hours), the TiS_2 produced is treated for two hours at the same temperature in a slow stream of H_2S to remove most of the chloride still adhering to the product. The material is allowed to cool in a stream of H_2 or CO_2 , the tube is broken at both ends, and the dark brass-yellow TiS_2 , which crystallizes as leaflets of mosaic gold color, is collected. The yield is about 10 g.

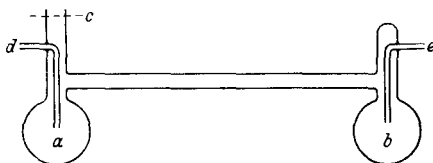
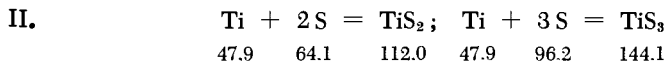

Fig. 301. Preparation of titanium disulfide.

Complete removal of the chloride can be effected only by repeated heating of the product with excess S in a pressure tube. Thus, 4 g. of crude TiS_2 and 3 g. of S are placed in a bomb tube of Vycor or similar glass. The sulfur should be completely free of carbon compounds [von Wartenberg method: Z. anorg. allg. Chem. 251, 166 (1943); this consists of vacuum distillation, followed by 48-hour heating at 200°C in vacuum or under N_2 , followed by another vacuum distillation]. The bomb

tube with the TiS_2 and S is sealed in high vacuum and heated for three days at $600^\circ C$. The tube is opened and the volatile components are removed in a heated vacuum desiccator (drying pistol) at $100-150^\circ C$. The product, which still contains some chloride, is again heated with additional S to about $600^\circ C$ for two days, and the volatile components are again removed in vacuum. The intermediate product then consists of graphitelike trisulfide and unreacted S. The free sulfur may be removed by vacuum distillation at $400^\circ C$; the residual TiS_3 undergoes thermal decomposition at temperatures above $500^\circ C$, yielding pure TiS_2 .



Sulfides of any desired composition may be obtained by synthesis from the elements, which is a generally applicable method. This is also the simplest way to prepare chlorine-free products. The starting material consists either of Ti filings made by grinding Ti strips (for the preparation of the strips, see the directions for the lower titanium oxides, p. 1214) or simply Ti powder (which, however, usually has a lower metal content). First 1.5 g. of Ti and 4 g. of S, in a thick-wall Vycor tube, are carefully degassed in high vacuum. The tube is then sealed and heated at $650^\circ C$ for four days. Metal particles still present in the product are ground separately, added to the sulfide product (total about 3 g.) together with 1.7 g. of S, and again heated in a pressure tube for two days at $600^\circ C$. The free sulfur is distilled off at $400^\circ C$; the higher sulfides are, if desired, decomposed thermally above $500^\circ C$, yielding TiS_2 and TiS_3 , as in method I.

PROPERTIES:

TiS_2 : Formula weight 112.02. Brass-yellow flakes with a metallic luster. d 3.22. Crystal structure: type C6.

Stable in air at normal temperatures; forms TiO_2 on heating. Decomposes in nitric acid and hot conc. H_2SO_4 , releasing S; dissolves in boiling aqueous sodium and potassium hydroxides, forming alkali titanates and alkali sulfides.

TiS_3 : Formula weight 144.08. Graphitelike substance. d 3.22. Except for its insolubility in boiling NaOH, it is similar to TiS_2 in all chemical properties.

$TiS_{<2}$

Lower Ti sulfides may be prepared by synthesis from the elements, by treatment of Ti metal with TiS_2 , or by reduction of TiS_2 with H_2 .

SYNTHESES STARTING FROM TITANIUM METAL

The procedure is identical to that of method II; in the first stage the S is bound to the Ti, and the resultant product is subsequently homogenized at high temperature. As long as the presence of sulfur is still a possibility, the temperature is raised very slowly, so that it may require as long as two days to reach 800°C in the case of S-rich compounds and 1000°C for S-poor compounds. The above temperatures are then maintained for 2-3 additional days, after which the product is tested for homogeneity by x-ray analysis.

The reaction is carried out in a quartz tube, which undergoes only slight devitrification but no further changes. Titanium metal itself begins to react with quartz at about 850°C. To exclude entirely the possibility of reaction of the titanium with the quartz in the case of the subsulfides ($\text{TiS}_{<1}$), the reaction mixture is placed in small ceramic or sintered clay crucibles (8-mm. diameter, 30 mm. long) which are then inserted in suitable quartz tubes and the tubes sealed off. This complication usually results in the necessity of using tubes of lesser wall thickness; hence, greater care must be exercised during heating.

As in other cases where tubes are to be heated to temperatures as high as 800°C, protection against explosion is recommended; this is provided by wrapping the tube in asbestos paper and inserting it into a small cage made of several layers of Ni or Cu wire mesh.

When quartz tubes are cut open with an emery wheel (1 mm. thick), it is not always possible to prevent quartz splinters from getting into the product. If the material is not a mass with a solid, glossy surface affording easy visual separation, the embedded quartz particles should always be removed by shaking with bromoform followed by centrifugation.

REDUCTION OF TiS_2 WITH H_2

This method permits carrying the reduction as far as the mono-sulfide stage, provided high temperatures are used. Since all small amounts of Cl present are removed during the reduction, the crude TiS_2 produced by method I can be used as such without further purification. The reaction is carried out in an unglazed porcelain tube, with the boat containing the material placed in the center; a stream of carefully dried H_2 (freed of O_2 by contact with Pd) is passed over the boat. Two to three hours suffice for the reduction; the duration of the run depends on the quantity of material and the hydrogen flow rate. The temperature to which the tube is heated is a deciding factor for the degree of reduction ($500^\circ\text{C} \rightarrow \text{TiS}_{1.50}$, $900^\circ\text{C} \rightarrow \text{TiS}_{1.25}$, $1200^\circ\text{C} \rightarrow \text{TiS}_{1.1}$).

PROPERTIES:

Air stable, colored substances ($\text{TiS}_{1.5}$: black; $\text{TiS}_{1.13}$: violet; $\text{TiS}_{1.0}$: brown; $\text{TiS}_{0.5}$: gray). With decreasing sulfur content, the susceptibility to hydrochloric acid attack increases and that by acidic oxidation agents decreases. In contrast to TiS_2 , the lower sulfides are unaffected by sodium hydroxide. The sesquisulfide phase has a wide range of compositions ($\text{TiS}_{1.59}$ - $\text{TiS}_{1.13}$).

REFERENCES:

W. Biltz and P. Ehrlich. *Z. anorg. allg. Chem.* **234**, 97 (1937); see also H. Hahn and B. Harder. *Ibid.* **288**, 241 (1956) (also contains information on growing of single crystals).

Zirconium Sulfides

Zirconium sulfides can be prepared by exactly parallel methods, i.e., reaction of ZrCl_4 with H_2S or synthesis from the elements. Orange-red ZrS_3 may be thermally decomposed to brown ZrS_2 at 800°C . The lower zirconium sulfides include, in addition to the sesquisulfide and subsulfide phases, an additional compound $\text{ZrS}_{0.75}$.

REFERENCE:

E. F. Strotzer and W. Biltz. *Z. anorg. allg. Chem.* **242**, 249 (1939).

Thorium Sulfides

Synthesis from the elements under pressure yields a deep red polysulfide Th_3S_4 , lilac brown ThS_2 , a sesquisulfide, and a subsulfide $\text{ThS}_{0.75}$.

REFERENCE:

E. F. Strotzer. *Z. anorg. allg. Chem.* **247**, 415 (1941).

Titanium (III) Sulfate

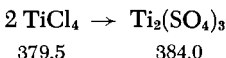
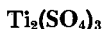

379.5

384.0

Titanium tetrachloride (100 g.) is carefully decomposed with approximately four times its volume of H_2O . The solution is cooled

and treated with dilute ammonia to precipitate $\text{TiO}_2 \cdot \text{aq.}$, which is suction-filtered, thoroughly washed with water, and dissolved (vigorous shaking) in 70 ml. of conc. H_2SO_4 . The solution is diluted with water to one liter, the precipitation with ammonia is repeated, and the resultant deposit is reprecipitated two additional times. The $\text{TiO}_2 \cdot \text{aq.}$ obtained (about 480 g.) is carefully dissolved in 100 ml. of conc. H_2SO_4 , yielding a total liquid volume of about 500 ml.; this is suction-filtered through glass and treated with 300 ml. of conc. H_2SO_2 , yielding about 400 ml. of a solution of Ti (IV) sulfate. This solution is reduced to Ti (III) sulfate by the following electrolytic method.

A low vertical cylinder closed off with a rubber stopper serves as the electrolysis vessel and contains the sulfate solution. The anode is a piece of Pt sheet immersed in a clay cell filled with 20% H_2SO_4 . The cell is partially immersed in the Ti (IV) sulfate solution and is surrounded by four amalgamated lead strips, also immersed in the solution. The stopper on the outer electrolysis vessel has holes for the clay cell and for the inlet and outlet gas tubes. The electrolysis is carried out in a constant stream of CO_2 and with efficient water cooling. The current density is 0.06 amp./cm.² at 24 v. for the first six hours, then 0.33 amp./cm.² at the same voltage for an additional six hours. This reduces all the Ti (IV) sulfate to Ti (III) sulfate; the latter precipitates as an H_2SO_4 -containing hydrate (fine, pale light violet crystals).

To obtain the anhydrous Ti (III) sulfate, the product is suction-filtered in a stream of CO_2 , washed with 50% H_2SO_4 , and placed (in the absence of air) in a round-bottom flask fitted with a ground joint and filled with CO_2 . Then 300 ml. of dilute sulfuric acid (20% v./v. H_2SO_4) is added; the flask is stoppered with a ground stopper fitted with inlet and outlet gas tubes and an opening for the insertion of a thermometer; it is heated in a stream of CO_2 until the precipitate dissolves. Using gas pressure, the liquid is forced into a filtration apparatus (see Part I, p. 74) and filtered under CO_2 through a tubular fritted glass filter fitted with appropriate ground joints. The receiver with the filtrate is in turn closed off with a stopper fitted with a thermometer and gas tubes; CO_2 is passed through, and the temperature is slowly raised by means of an oil bath. This concentrates the liquid to about half its volume. At this point a violet precipitate begins to form; on further heating, this turns to blue and finally, at 190-200°C, to green. The temperature is maintained at 190°C for three hours and is then raised to 210-220°C for 10 minutes. Heating to higher temperatures results in evolution of SO_2 and oxidation of the Ti (III) sulfate. The material is allowed to cool in a stream of CO_2 ; it should remain green. If it assumes a blue color, the heating procedure must be repeated. The green precipitate is filtered under CO_2 , using the filtration apparatus; the contaminating Ti (IV) sulfate

is removed by washing with conc. H_2SO_4 , followed by glacial acetic acid, anhydrous methanol and ether. The tubular fritted glass filter is removed from the filtration system, covered with a ground cap fitted with a stopcock, and placed horizontally in a short tubular electric furnace; the material is then dried for four hours at 140°C in a constant stream of pure N_2 .

PROPERTIES:

Green crystalline powder. Insoluble in water, alcohol and conc. H_2SO_4 ; soluble in dilute H_2SO_4 and in hydrochloric acid, yielding a violet solution.

REFERENCES:

- O. Schmitz-Dumont, P. Simons and G. Broja, *Z. anorg. Chem.* **258**, 307 (1949); W. J. de Haas and B. H. Schultz, *Physica* [2] **6**, 481 (1939); A. Stähler and H. Wirthwein, *Ber. dtsch. chem. Ges.* **38**, 2619 (1905).

Titanoxy Sulfate

TiOSO_4

This compound is produced on evaporation of TiO_2 or $\text{TiO}_2 \cdot \text{aq.}$ with conc. H_2SO_4 ; the dihydrate is obtained under the same conditions but with 70% H_2SO_4 . The material, which is extremely hygroscopic and readily splits off SO_3 , can also be prepared as a white precipitate by dropwise addition of a solution of SO_3 in SO_2Cl_2 to a solution of TiCl_4 in SO_2Cl_2 , followed by refluxing [E. Hayek and W. Engelbrecht, *Monatsh. Chemie* **80**, 640 (1949)].

Iron-free titanoxysulfate is usually not available commercially. When available, it is not completely water soluble. The following procedures are therefore recommended for the preparation of the pure compound.

I. TiOSO_4

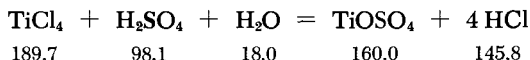

Pure, multiple-distilled TiCl_4 is added in drops (vigorous stirring) to the stoichiometric quantity of 50% H_2SO_4 . The precipitate formed after each addition should dissolve completely before the next portion of TiCl_4 is added. After the addition of about 3/4 of the TiCl_4 , the liquid turns into a viscous, yellowish solution. It

is diluted with 1/5 its volume of water, and the dropwise addition of TiCl_4 is completed.

The resultant solution, which is still highly concentrated in HCl, is evaporated to dryness on a water bath. The residue is pulverized, dried and freed of HCl by heating for several days at 80-100°C in a drying pistol at a pressure of a few mm.

The sulfate obtained in this manner ($\text{TiO}_2:\text{SO}_3 = 1:1.07$) is colorless and free of HCl. It is hygroscopic and soluble in water, yielding a clear solution.

Gelatinous or resinous precipitates may appear during the evaporation of the HCl-containing, highly viscous and slightly yellow solutions; the same phenomenon may occur during the vacuum concentration operation. Addition of alcohol or acetone to the concentrated solutions leads to the formation of fibrous precipitates.

II. $\text{TiOSO}_4 \cdot 2\text{H}_2\text{O}$

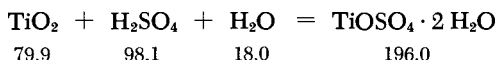
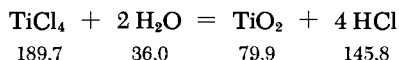

A solution of 40 ml. (63 g.) of freshly distilled TiCl_4 (b.p. 134-138°C) in 130 ml. of water is prepared. Most of this solution is then reduced to a slight extent by means of Zn rods or, better, by electrolysis (light-brown color), while 10 ml. kept separately is reduced to the trivalent titanium ion (deep violet color). The reduction is intended to ensure that all the iron is present in the form of Fe^{2+} , to avoid hydrolysis and coprecipitation of Fe^{3+} with the Ti. The reaction is carried out in dilute oxalic acid.

The violet chloride solution is slowly added in drops to a boiling solution of 1 g. of oxalic acid in one liter of water; then the brown chloride solution is added in the same way. The mixture should be maintained at the boiling point for a total of four hours, the volume being kept constant by occasional addition of water. The conditions of precipitation must be closely adhered to, to prevent coprecipitation of unfilterable metatitanic acid. The precipitate is filtered through a large Büchner funnel, washed free of Cl with boiling water and dried by suction. It is then treated with 35 ml. of conc. H_2SO_4 in a beaker. The mixture is gently boiled until precipitation begins. After cooling and addition of 120 ml. of water, the mixture is allowed to stand (with occasional stirring) for several days and, if necessary, is filtered. It is then evaporated, precipitating crystals of $\text{TiOSO}_4 \cdot \text{H}_2\text{O}$.

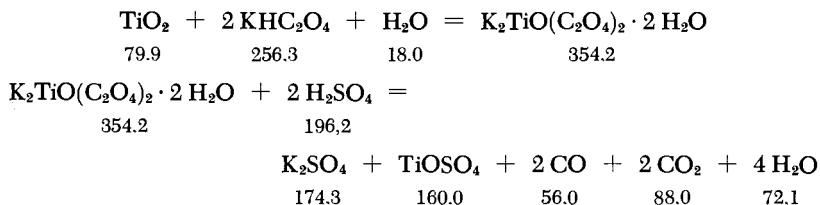
III. TiOSO_4 solutions

Iron-free titanium sulfate solutions, used as analytical standards, are readily prepared by repeated recrystallization of $\text{K}_2\text{TiO}(\text{C}_2\text{O}_4)_2 \cdot 2\text{H}_2\text{O}$ followed by treatment with conc. H_2SO_4 .

A concentrated solution of KHC_2O_4 is saturated at the boiling point with freshly precipitated $\text{TiO}_2 \cdot \text{aq.}$; the mixture is concentrated, whereupon white needles precipitate out. The double salt is dissolved with heating in an approximately equal weight of water. The solution is filtered and the salt is recrystallized in about 80-90% yield by cooling with ice and stirring. The iron content is reduced in the process from 0.061% to 0.004%, and no further iron can be detected after another repetition of the crystallization. The analytically pure salt has a composition corresponding to $\text{K}_2\text{TiO}(\text{C}_2\text{O}_4)_2 \cdot 2\text{H}_2\text{O}$.

To prepare one liter of an approximately 0.1N Ti sulfate solution, 38 g. of the double oxalate is thoroughly mixed with 32 g. of pure $(\text{NH}_4)_2\text{SO}_4$ (iron-free!) and placed in a 750-ml. Kjeldahl flask. The addition of $(\text{NH}_4)_2\text{SO}_4$ facilitates the reaction. Then 80 ml. of pure conc. H_2SO_4 is added. The flask is heated carefully with a small flame until cessation of foaming, and the solution is then boiled on a strong flame to decompose the oxalate. The solution is cooled, whereupon it becomes sirupy; it is carefully added, with vigorous stirring, to 500 ml. of distilled water and is then diluted to one liter. If precipitation occurs after standing overnight, the solution is filtered. The solution should give a negative test for oxalate upon addition of 1 drop of 0.1N KMnO_4 to 50 ml. of the liquid.

IV. *Alternate method:* Pure $\text{TiOSO}_4 \cdot 2\text{H}_2\text{O}$ precipitates in the form of long crystal needles from a solution of $\text{TiO}_2 \cdot \text{aq.}$ in 60-70% H_2SO_4 in which the ratio $\text{TiO}_2 : \text{H}_2\text{SO}_4 = 1 : 3$ to $1 : 7$. At higher concentrations of acid, the precipitate is powdery and contains less H_2O .

SYNONYM:

Titanyl sulfate.

PROPERTIES:

Anhydrous: highly hygroscopic; dissolves slowly in water to give a clear solution. Dihydrate: readily soluble. Decomposes in hot H_2O with precipitation of $TiO_2 \cdot aq$.

REFERENCES:

- I. Private communication from K. F. Jahr, Berlin.
- II. A. W. Hixson and W. W. Plechner. *Ind. Eng. Chem.* **25**, 262 (1933).
- III. R. Rosemann and W. M. Thornton. *J. Amer. Chem. Soc.* **57**, 328 (1935); see also C. Péchard. *Comptes Rendus Hebd. Séances Acad. Sci.* **116**, 1513 (1893); A. Rosenheim and O. Schütte. *Z. anorg. Chem.* **26**, 239 (1901).
- IV. A. V. Pamfilov and T. A. Chudyakova. *Zh. Obschey Khimii* **19**, 1443 (1949).

Zirconium Sulfates

 $Zr(SO_4)_2 \cdot 4H_2O$

Hauser and more recently Falinski have made a thorough study of the system $ZrO_2/SO_3/H_2O$ as a function of the SO_3 concentration. It was found that the tetrahydrate is formed on addition of $ZrOCl_2 \cdot 8H_2O$ to a sulfuric acid containing less than 64% SO_3 (d 1.714). The tetrahydrate solubility is then 2%. The minimum solubility (0.3%) corresponds to 50% SO_3 in the acid (d 1.517).

If the SO_3 content exceeds 64%, acid sulfates precipitate: $Zr(SO_4)_2 \cdot H_2SO_4 \cdot 2H_2O$ at an SO_3 concentration of 64-72%, and $Zr(SO_4)_2 \cdot H_2SO_4 \cdot H_2O$ at 72-79% SO_3 .

PROPERTIES:

Formula weight 355.41. Orthorhombic crystals. The basic salt precipitates slowly from neutral, saturated solution, rapidly from dilute solution or above 40°C.

In sulfuric acid solution, the Zr migrates to the anode instead of to the cathode; therefore, the tetrahydrate may actually be present in the form of a disulfatoxozirconic acid ($H_2[OZr(SO_4)_2] \cdot 3H_2O$).

 $Zr(SO_4)_2$

The anhydrous salt is obtained by evaporation of the tetrahydrate or Zr oxychloride with conc. H_2SO_4 .

Thus, 100 g. of $ZrOCl_2 \cdot 8H_2O$ is mixed with 50 g. of conc. H_2SO_4 and, after termination of the gas evolution, carefully evaporated with stirring on a sand bath. The dihydrate of the sulfate crystallizes out as an intermediate in the process, but decomposes on further heating, giving off additional H_2O . The excess H_2SO_4 is completely evaporated by heating to 350–380°C. The product is allowed to cool in a desiccator.

PROPERTIES:

Formula weight 283.35. Microcrystalline powder. Very hygroscopic; in air, forms an unstable solution from which the normal tetrahydrate crystallizes after some time. The anhydride dissolves more rapidly in a small than in a large amount of water, since the temperature rise produced by the heat of hydration sharply accelerates the solution process.

REFERENCES:

- O. Hauser. *Z. anorg. allg. Chem.* **106**, 1 (1919); M. Falinski. *Ann. Chimie* **16**, 237 (1941).

Purification of Zr salts via the tetrahydrate

One volume of conc. H_2SO_4 is added to two volumes of a moderately conc. aqueous solution of Zr sulfate or chloride; the thick, white, crystalline precipitate of $Zr(SO_4)_2 \cdot 4H_2O$ is readily filtered with suction on fritted glass of medium porosity. Since 1 g. of the salt dissolves in 1 ml. of H_2O , the Zr sulfate is easily dissolved; it is reprecipitated by addition of conc. H_2SO_4 . The iron is efficiently removed during the recrystallization provided the solution contains about 10% HCl. After each precipitation, the solid is washed several times with a solution made up of 15 parts by volume of H_2O , eight parts of conc. H_2SO_4 and one part of conc. hydrochloric acid, followed by three washings with acetone. Alcohol should not be used for washing, since it forms complexes during the further precipitations.

Thus, 1135 g. of commercial $ZrCl_4$ [equivalent to 1731 g. of $Zr(SO_4)_2 \cdot 4H_2O$] was dissolved in 1800 ml. of H_2O and 250 ml. of conc. HCl; then 100 ml. of conc. H_2SO_4 was added, precipitating 1640 g. (94%) of $Zr(SO_4)_2 \cdot 4H_2O$; five additional crystallizations of this product (under identical conditions) finally give 1212 g. of pure tetrahydrate. The following table shows the degree of purification achieved:

Starting material	→ 0.1%	← 0.1%	← 0.01%	← 0.001%	← 0.0001%	← 0.00001%
Fe	—	—	—	Ca, Cu, Mn	—	—
6 × recrystallized	—	—	—	Ca, Mg, Na, Si	Ag	Fe, Cu

A residual Fe content up to 0.01% may be removed by mere recrystallization, without the addition of HCl. The Hf content of 2.7% remains unchanged.

REFERENCE:

W. S. Clabaugh and R. Gilchrist. *J. Amer. Chem. Soc.* **74**, 2104 (1952).

Titanium, Zirconium and Hafnium Nitrides

TiN, ZrN, HfN

Titanium Nitride

A number of procedures are available. The simplest is the industrial process starting from $\text{TiO}_2 + \text{C} + \text{N}_2$ described in method I. If metallic Ti is available, synthesis from the elements (method II) is recommended. Very pure nitride in rod or wire form, especially well suited for physical measurements, is obtained by vapor deposition (method III). An additional method of lesser importance consists of the reaction between TiCl_4 and NH_3 (method IV).

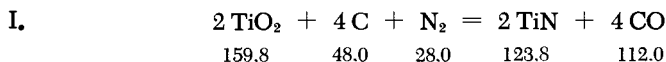

The industrial process does not yield a pure product. Acetylene-derived carbon black is degassed at 1200°C, mixed with TiO_2 (mole ratio 1:2), and the mixture placed in a silicon carbide or molybdenum boat; it is calcined for three hours at 1250°C in a stream of N_2 . The product contains 98% nitride; the remainder is lower Ti oxides.



In the first stage of this preparation, the ductile metal absorbs small quantities of N_2 and thus becomes brittle; it can then be pulverized for further treatment with nitrogen.

TREATMENT WITH NITROGEN

Titanium filings ground to pinhead size and treated as described in the directions for the preparation of TiO (p. 1214) are placed in a silicon carbide or molybdenum boat and heated to 1200°C

for 2-3 hours. The operation is carried out in a hard porcelain tube in a stream of pure, dry N_2 . The product has the approximate composition $TiN_{0.95}$; it is finely ground and subjected to a second nitrogenation. The desired composition is attained in two to three repetitions of the procedure. The quality of the product is adversely and decisively affected by the presence of the slightest traces of O_2 or H_2O during heating.

PRESINTERING

The products prepared in the above manner are ground as finely as possible and compressed under 2000 kg./cm^2 into rods 3×40 or 5×40 mm. Successful molding usually requires the addition of 2-5% of metal powder. The rods are embedded in nitride powder (to prevent formation of an oxide coating) and presintered in a small tubular tungsten furnace (cf. Part I, p. 40) at about 2300°C in a stream of N_2 ; the small amount of free metal is converted to nitride in the process. Since the reaction is usually accompanied by considerable shrinkage of the rods and concomitant appearance of porosity, the material must be repulverized, remolded and resintered. This procedure is repeated two to four times, until the presintered rods exhibit some constancy of density.

HIGH-TEMPERATURE SINTERING

When the rods have attained sufficient strength and density in the presintering process, they are fastened with clamps in preparation for direct electrical heating. The operation is carried out in technical-grade Ar containing 12-15% N_2 ; the equipment used has been described by C. Agte and H. Alterthum, *Z. techn. Phys.* 11, 182 (1930).

The nitrides are heated to just below their melting points. At these extreme temperatures, all impurities (except some oxides and the carbides) possess higher vapor pressures than the nitrides and therefore evaporate. However, the oxides, even though their melting points are lower, are difficult to remove. The carbides, with higher melting points than the nitrides, remain unchanged.

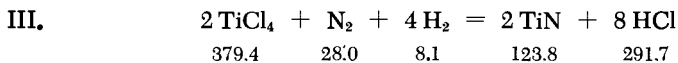

The technique used in the vapor deposition process is the same as that described for the preparation of the metals (Ti, Zr and Hf) from the gas phase, except that the gas used here is a $TiCl_4$ -saturated mixture of $H_2 + N_2$ (the reaction at the glowing wire is less successful with N_2 alone).

A gasometer is filled with a mixture of equal volumes of H_2 and N_2 . The gas bubbles through a 36°C wash bottle filled with

TiCl_4 (p of $\text{TiCl}_4 = 17$ mm.). The gas flow rate is of no importance, except that it must be low enough to achieve saturation. The optimum reaction pressure is about 30–40 mm., measured with a manometer whose mercury surface is protected by a thin film of butyl phthalate.

The reactor is a round-bottom Pyrex flask with inlet and outlet tubes for the gas fused on the sides. The arc-shaped glow wire (about 8–10 cm. long) is welded to two thick tungsten electrodes; these are sealed into a ground joint inserted through the bottom of the flask. The 0.2-mm. glow wire may be either W or Ta. Wires of Ta can be directly welded to the W rods, whereas the W wires have to be connected via a short Ni bridge-piece.

In the course of the reaction, the glow wire is heated to about 1450°C ; since the deposited TiN is itself a good electrical conductor, the current must be raised from 10 to about 22 amp. within the first 40 minutes. One serious disadvantage of the process is the fact that the temperature cannot be measured with an optical pyrometer because TiCl_3 , one of the products of the fast decomposition of TiCl_4 , soon coats the flask walls. One must resort, therefore, to indirect estimation of the temperature by measuring it in a blank run with gases containing no TiCl_4 . The nitride deposits as a fine crystalline coating of copper to gold luster.

Alternate methods:

IV.

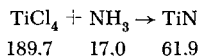

As we have indicated before, this process is less desirable. Chlorine-containing TiN is formed (in poor yield) on the walls of a porcelain tube in which a gaseous mixture of TiCl_4 and NH_3 is thermally decomposed at 800°C . The same result is obtained when the solid compound $\text{TiCl}_4 \cdot 4\text{NH}_3$ is placed at the front end of the tube, evaporated in a stream of NH_3 , and allowed to react at 800°C .

The TiCl_4 ammoniate is prepared by distilling the TiCl_4 into a bomb tube and covering the liquid with excess NH_3 at -60°C ; the pale yellow compound is formed after shaking the sealed tube for 12 hours at room temperature.

The "crude nitride" formed at 800°C is heated in a hard porcelain tube at 1500°C for six hours in a stream of NH_3 to obtain a Cl-free product of the composition TiN.

PROPERTIES:

Bronze-colored powder. M.p. 2950°C ; d 5.21. Somewhat dissociated at the melting point. Crystal structure: type B1 (NaCl type). This structure holds for a wide range of compositions ($\text{TiN}_{1.0}$ – $\text{TiN}_{0.4}$). Very good electrical conductor.

Insoluble in HCl, HNO₃ and H₂SO₄, even on boiling; dissolves rapidly in hot aqua regia. Evolves NH₃ on boiling in potassium hydroxide and on heating in soda lime.

Zirconium Nitride, Hafnium Nitride

These compounds are prepared by the same methods as above.

I. The experimental arrangement is the same as for TiN, except that the reaction temperature is higher (about 1300°C). Since Mo begins to form a carbide at this temperature, the equipment must be made of tungsten. The products are only about 90% pure; the remainder is mainly the oxide.

II. Yellowish-brown ZrN (m.p. 2980°C) is synthesized from the elements by heating the latter for two hours at 1200°C. The corresponding temperature for HfN is 1400-1500°C.

III. The vapor deposition method: If H₂ (or H₂ + N₂, or NH₃) is the carrier gas for ZrCl₄ (or HfCl₄) the required wire temperatures are 2000-2400°C. With pure N₂, the temperature must be 2900°C and the rate of deposition is considerably slower.

Nitridation of Zr wire by heating in pure N₂ produces ZrN at very low rates and in a very loose and brittle form, even if the temperature is almost at the melting point of the metal (1860°C).

REFERENCES:

- General: C. Agte and K. Moers. *Z. anorg. allg. Chem.* **198**, 233 (1931).
- I. E. Friederich and L. Sittig. *Z. anorg. allg. Chem.* **143**, 293 (1925).
- II. P. Ehrlich, *Z. anorg. Chem.* **259**, 1 (1949); G. L. Humphrey. *J. Amer. Chem. Soc.* **75**, 2806 (1953).
- III. A. E. van Arkel and J. H. deBoer. *Z. anorg. allg. Chem.* **148**, 345 (1925); F. H. Pollard and P. Woodward. *J. Chem. Soc. (London)* **1948**, 1709; *Trans. Faraday Soc.* **46**, 190 (1950); F. H. Pollard and G. W. A. Fowles. *J. Chem. Soc. (London)* **1952**, 2444.
- IV. A. Brager. *Acta Physiochim. URSS* **11**, 617 (1939); see also O. Ruff and F. Eisner. *Ber. dtsh. chem. Ges.* **41**, 2250 (1908); **42**, 900 (1909).

Thorium Nitride

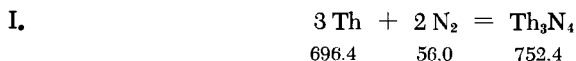

Thorium nitride is usually prepared by heating Th filings in a stream of dry, pure N₂. The reaction is complete in three

hours at 800°C. The presence of oxide in the metal is detrimental (products lower in N are formed).

II. Alternate methods:

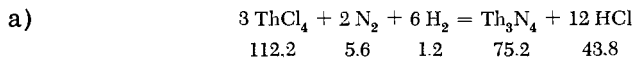

Since Th_3N_4 is not an electrical conductor, the method of vapor deposition (used in the preparation of pure TiN and ZrN) gives poorer results. Thus, solid ThCl_4 is made to react with $\text{N}_2 + \text{H}_2$ in a flask maintained at 800°C. The tungstenglow wire is at < 1000°C. The yield is poor.

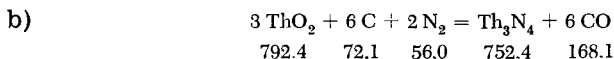

A sintered tungsten rod containing $\text{ThO}_2 +$ graphite is calcined above 2000°C in a N_2 -containing atmosphere; black Th_3N_4 crystals and lighter, oxide-containing products are formed.

PROPERTIES:

Dark-brown, almost black powder. Stable in dry air; readily soluble in acids.

REFERENCES:

- I. B. Neumann, C. Kröger and H. Haebler. Z. anorg. allg. Chem. 207, 145 (1932).
- II. W. Düsing and M. Hüniger. Techn. Wissenschaftl. Abhdlg. Osram 2, 357 (1931).

Titanium Tetranitrate

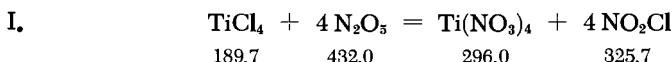

A solution of 3 ml. (5.1 g.) of TiCl_4 in 10 ml. of CCl_4 is cooled with Dry Ice in a two-neck flask provided with a dropping funnel and a reflux condenser which is protected with a P_2O_5 tube. A solution of 11.6 g. of N_2O_5 in 25 ml. of CCl_4 is then added dropwise. A yellow, flocculent precipitate forms as soon as the CCl_4 melts (-23°C), that is, after removal of the coolant. As the temperature

rises from -23°C to room temperature, the precipitate dissolves with evolution of a gas. If too violent, the bubbling may be slowed down by cooling. Solution of the last fraction of the precipitate is accelerated by mild heating. The volatile components (NO_2Cl and CCl_4) are removed by vacuum distillation, leaving a residue of the white $\text{Ti}(\text{NO}_3)_4$, which may be purified by sublimation in high vacuum at 50°C . Part of the product decomposes in the process into N_2O_5 and nonvolatile $\text{TiO}(\text{NO}_3)_2$.

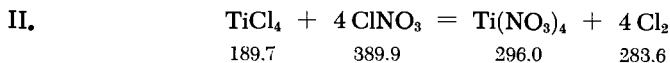

A large excess of ClNO_3 is condensed at liquid nitrogen temperature onto the surface of 2-3 ml. of TiCl_4 , frozen in a cold trap at high vacuum. The trap is connected to a surge vessel and the temperature is raised to -80°C . The reaction, which is accompanied by evolution of chlorine, is complete after a few hours. The volatile components (Cl_2 and excess ClNO_3) are then distilled off in vacuum at room temperature. The $\text{Ti}(\text{NO}_3)_4$ residue, in the form of a crystal cake, may be further purified by sublimation at 50°C .

PROPERTIES:

After sublimation slightly above the melting point, white needles. M.p. 58.5°C . Decomposes at about 100°C .

REFERENCES:

- I. M. Schmeisser. *Angew. Chem.* **67**, 493 (1955); D. Lützow, Thesis, Univ. of Munich, 1955.
- II. W. Fink. Thesis, Univ. of Munich, 1956.

Thorium Nitrate

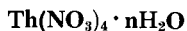

RECOVERY OF THORIUM SALTS FROM MONAZITE

The mechanical ore-dressing process yields a monazite sand concentrate consisting of a mixture of Th silicate, rare earth phosphates, SiO_2 and usually 4-5% ThO_2 . The material is calcined, finely ground and dissolved by prolonged digestion with conc. H_2SO_4 at 210°C . After cooling, the pasty mass is dissolved in ice water and the undissolved material is filtered off. Further treatment may proceed via the following methods.

I. In this method, Th is quantitatively precipitated as the phosphate, together with a small amount of rare earth phosphates; this is accomplished by neutralization and dilution of the solution. The phosphates are dissolved in conc. hydrochloric acid and precipitated with oxalic acid, and the thoroughly washed precipitate is extracted with warm aqueous Na_2CO_3 . Most of the rare earths stay in the residue, while the thorium dissolves in the form of a carbonate complex, $\text{Na}_6\text{Th}(\text{CO}_3)_5$. The material is freed of the remaining traces of rare earths by repeated crystallization in the form of the sulfate $\text{Th}(\text{SO}_4)_2 \cdot 8\text{H}_2\text{O}$. The procedure consists of precipitation of the hydroxide with ammonia and solution of the latter in sulfuric acid to re-form the sulfate. The precipitate from the last purification stage is dissolved in nitric acid to yield the nitrate.

[In an older process, the Th and the rare earths are coprecipitated as oxalates from the initial acidic solution. The Th is extracted as the carbonatothorate by treatment with aqueous Na_2CO_3 solution.]

II. A good yield of ThO_2 may be obtained in another process used primarily for production of the rare earths. The filtered sulfate extract is treated with Na_2SO_4 to precipitate the cerium earths (as double sulfates); the corresponding Th salt $\text{Na}_2\text{SO}_4 \cdot \text{Th}(\text{SO}_4)_2 \cdot 6\text{H}_2\text{O}$ remains in solution. The mixture is filtered and the filtrate is heated to 90°C ; it is treated with oxalic acid, yielding a precipitate consisting chiefly of Th oxalate.

Further treatment is the same as in method I.

III. PURIFICATION OF THORIUM NITRATE

Very pure NH_4NO_3 is added to a solution of the crude nitrate; the result is the double nitrate $\text{Th}(\text{NO}_3)_4 \cdot \text{NH}_4\text{NO}_3 \cdot 8\text{H}_2\text{O}$. The product is further purified by dissolving in triple-distilled water, adding redistilled nitric acid, and concentrating in a Pt dish on an electrically heated water bath until crystallization begins. The solution is then cooled with ice and constantly stirred; the resultant crystals are centrifuged off and redissolved. The procedure is repeated five times, yielding about 50% of the initial Th as the double nitrate.

The product is dissolved in very pure water, filtered and precipitated as the oxalate by addition of a nitric acid solution of purified oxalic acid; the precipitate is suction-filtered, washed with alcohol, and dried. The resultant Th oxalate may be calcined immediately to the oxide, or it may be reconverted to the nitrate by dissolving in conc. nitric acid.

IV. PREPARATION OF THE HYDRATES

Depending on the conditions of preparation, $\text{Th}(\text{NO}_3)_4$ crystallizes from solutions of thorium hydroxide (or from HNO_3 solutions of moderately calcined oxide) with varying contents of water of crystallization. When a not too acid solution is concentrated by evaporation, $\text{Th}(\text{NO}_3)_4$ crystallizes in the cold with 12 moles of H_2O . A solution evaporated at 15°C yields the pentahydrate, which is stable to 80°C if heated in an atmosphere free of CO_2 . At higher temperatures, it converts to the trihydrate, and between 125 and 150°C , to the hemihydrate. Above 150°C the remaining water is split off, together with nitrogen oxides.

V. PREPARATION OF THE ANHYDRIDE

Anhydrous $\text{Th}(\text{NO}_3)_4$ is prepared by treatment of the lower hydrates of Th with N_2O_5 condensed at -78°C .

PROPERTIES:

Formula weights: $\text{Th}(\text{NO}_3)_4$ 480.15; $\text{Th}(\text{NO}_3)_4 \cdot 5\text{H}_2\text{O}$ 570.23. Very readily soluble in H_2O and alcohol. Due to hydrolysis, the aqueous solution becomes acid and slowly precipitates a basic salt. The commercial product usually contains about four moles of H_2O ; it usually also contains some sulfate. Combines very readily with alkali and alkaline earth nitrates to yield double nitrates (very beautiful crystals). The alkali salts corresponding to the formula $\text{Alk}_2[\text{Th}(\text{NO}_3)_6]$ crystallize in anhydrous form, and the corresponding alkaline earth compounds with eight moles of H_2O . Water-containing alkali thorates $\text{Alk}[\text{Th}(\text{NO}_3)_6]$ have also been described.

REFERENCES:

- I. D. W. Pearce, R. A. Hansen and J. C. Butler in: W. C. Fernelius, *Inorg. Syntheses*, Vol. II, New York-London, 1946, p. 38; see also H. and W. Biltz, *Übungsbeispiele aus der unorganischen Experimentalchemie* [Laboratory Problems in Experimental Inorganic Chemistry], Leipzig, 1920, p. 226; and L. Vanino, *Handbuch der Präparativen Chemie* [Handbook of Preparative Chemistry], Vol. I (Inorg. Part), Stuttgart, 1925, p. 759.
- II. E. S. Pilkington and A. W. Wylie. *J. Soc. Chem. Ind.* **66**, 387 (1947); this article also lists additional references on the subject.
- III. O. Hönigschmid and S. Horovitz. *Sitz.-Ber. Akad. Wissensch. Wien IIa*, 12b, No. 3 (1916); see also E. H. Archibald. *The Preparation of Pure Inorganic Substances*, New York, 1932, p. 193.

- IV. E. Chauvenet and Souteyrand-Franck. *Bull. Soc. Chim. France* [4] 47, 1128 (1930).
 V. P. Miscialetti. *Gazz. Chim. Ital.* 60, 882 (1930); see also J. R. Ferraro, L. J. Katzin and G. Gibson. *J. Amer. Chem. Soc.* 77, 327 (1955).

Titanium Oxonitrate, Zirconium Oxonitrate

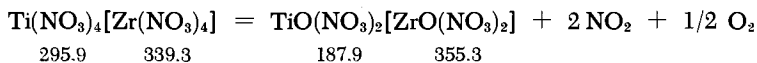
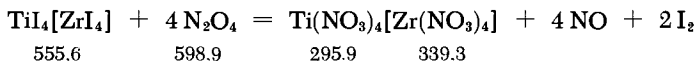
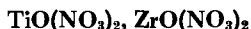

A suspension of TiI_4 or ZrI_4 in anhydrous CCl_4 is placed in a three-neck flask and agitated with a magnetic stirrer. Dry dinitrogen tetroxide is then bubbled through; the excess gas and the NO formed in the reaction are allowed to escape through a P_2O_5 tube. On contact with the gas, the liquid assumes a deep violet color due to liberation of iodine. After about one hour, the product is suction-filtered through a sintered glass plate; this operation is carried out in a dry box in flowing nitrogen (see Part 1, p. 71). The product is then washed with anhydrous CCl_4 and the solvent removed in vacuum.

PROPERTIES:

The almost white, powdery oxonitrates are hygroscopic; on heating, they are converted to the dioxides without melting. Soluble in alcohol, insoluble in benzene and CCl_4 .

REFERENCE:

- V. Gutmann and H. Tannenberger. *Monatsh. Chem.* 87, 424 (1956).

Titanium Phosphide, Zirconium Phosphides, Thorium Phosphide



Titanium Phosphide

I. The process recommended for the preparation of titanium phosphides is the pressure synthesis from the elements in the "Faraday"

apparatus (see Part I, p. 76).

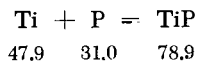

Biltz et al. give the following procedure: 2 g. of Ti filings ground to pinhead size (for their preparation see the directions given for the lower titanium oxides, p. 1214) and 4 g. of red P are weighed into a small ceramic or sintered clay cylindrical crucible. The materials are degassed by fanning with a flame in high vacuum and are then sealed (in vacuum) into a quartz pressure tube. The colder half of the tube is heated to 450°C, while the Ti side is maintained at 950°C. Two three-day periods are needed for the reaction. After the first period, the tube is slowly cooled for 3-4 hours, and the unreacted P is thus distilled into the cooler section. The product is readily ground in an agate mortar, an indication that the ductile Ti metal has reacted. The grinding is carried out under CS₂, which is then removed with alcohol and by drying in vacuum over NaOH at 120-140°C. Microscopic examination of the dark-gray metallic product should show no red phosphorus. The phosphorus quantity used for the second reaction stage should again correspond to an atomic ratio of 3 P:1 Ti. The product treatment after the second three-day heating period is the same as that after the first. The resultant phosphide does not correspond completely to the formula TiP (maximum composition is TiP_{0.92}).

II.

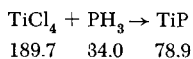

The method of Gewecke starts from phosphine generated from yellow P and KOH; the gas is washed with conc. hydrochloric acid to remove spontaneously igniting phosphorus hydrides, followed by NaOH. It is dried in two U tubes filled with CaCl₂ pieces (broken up from a solidified melt of the salt) and two P₂O₅ tubes. The gas enters the reaction apparatus proper through a trap (-250°C) designed in such a way that any gaseous TiCl₄ backing up during the reaction will condense out. The PH₃ train is connected to the reactor via a ground joint, with a two-way stopcock (for venting) inserted in the line.

The reactor consists of a spherical TiCl₄ vessel followed by a heating tube 40 cm. long. Both the vessel and the tube are Vycor. The gases then flow into an ordinary glass receiving flask for TiCl₄ and absorption tubes for PH₃ (one contains aqueous CuSO₄ and the other copper wire mesh).

The system is first filled with H₂. The reaction tube is heated to 750°C and the PH₃ generator is started (this requires 3-4 hours). The TiCl₄, which is kept cold up to this time, is now heated.

The chloride vapor reacts with the phosphine in the hot reaction tube (reaction time: about three hours). As in the preparation of TiS_2 from $TiCl_4$ and H_2S , the $TiCl_4$ may be cycled back and forth through the tube. The titanium phosphide product is a light-gray, high-polish mirror deposited on the tube walls. However, the product is not free of the chloride even after treatment at $350^\circ C$ in high vacuum. Preparations with maximum phosphorus content correspond to $TiP_{0.93}$; the yield is modest.

PROPERTIES:

Black-gray powder with a metallic appearance; attacked only slightly by acids even when heated; thermally very stable; it is assumed that a subphosphide exists. d 3.94.

REFERENCES:

W. Biltz, A. Rink and F. Wiechmann. *Z. anorg. allg. Chem.* **238**, 395 (1938); I. Gewecke. *Liebigs Ann.* **361**, 70 (1908); for data on the system $TiCl_4/PH_3$, see R. Höltje, *Z. anorg. allg. Chem.* **190**, 246 (1930).

Zirconium Phosphides

The pressure synthesis used for TiP is also employed in the preparation of compounds of the Zr/P system. First stage: treatment in a Faraday tube for 50 hours at a $1000/500^\circ C$ gradient; atomic ratio 1 Zr:4 P. Second stage: aftertreatment in a quartz pressure tube (wall thickness 4 mm., I.D. 12 mm.) for 50 hours at $800^\circ C$. The product is black-gray ZrP_2 ; this may be degraded to ZrP in high vacuum at $820^\circ C$. If the desired composition does not exceed $ZrP_{\leq 1}$, the second stage merely increases the homogeneity of the product. Since vapor pressure then ceases to be a factor, ordinary quartz tubes may be used.

The diphosphide ZrP_2 may also be prepared via method II for TiP .

REFERENCE:

E. F. Strotzer and W. Biltz. *Z. anorg. allg. Chem.* **239**, 216 (1938).

Thorium Phosphide

One heating cycle in the Faraday apparatus suffices to prepare Th_3P_4 (a subphosphide $ThP_{0.8}$ also exists). The reactants are heated for 60 hours in a furnace with a $940/450^\circ C$ gradient

(atomic ratio of Th:P = 1:3). The absorptivity of Th for x-rays is very high, and therefore minute quantities of surface oxide interfere in the x-ray pattern analysis. Therefore, for precision work (particularly when the product is a lower phosphide) an empty cylindrical crucible is first heated for one hour (under high vacuum) in the rear section of the tubular quartz reactor, while the small quartz flask with the raw material at the front end of the reactor remains cold. After cooling of the rear section (in high vacuum), the raw material is transferred to the crucible and the reactor tube is sealed off.

REFERENCE:

E. F. Strotzer and W. Biltz. *Z. anorg. allg. Chem.* **238**, 69 (1938).

Zirconium and Hafnium Phosphates

No unequivocal characterization exists for the phosphates precipitated from Zr salt solutions. The orthophosphate is formulated as either $\text{Zr}(\text{HPO}_4)_2$ or $\text{ZrO}(\text{H}_2\text{PO}_4)_2$; on prolonged heating above 700°C , it converts to ZrP_2O_7 .

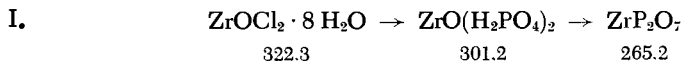

First, $\text{ZrOCl}_2 \cdot 8\text{H}_2\text{O}$ (2 g.) is dissolved in 1.5 liters of 6N HCl, and then a solution of 2 g. of Na_2HPO_4 in 1.5 liters of 6N HCl is added in drops. The finely divided precipitate is washed by repeated decantation with 6N HCl, filtered and dried at 80°C . The product corresponds to $\text{ZrO}(\text{H}_2\text{PO}_4)_2$.

The hafnium analogue, $\text{HfO}(\text{H}_2\text{PO}_4)_2$, is prepared in exactly the same manner; it is less soluble than the Zr salt.

II. *Alternate method:* Solutions of Zr sulfate (2-5% ZrO_2) and 2.5% H_3PO_4 in 2N sulfuric acid are added simultaneously in drops to 2N H_2SO_4 at $70-75^\circ\text{C}$.

PROPERTIES:

Sparingly soluble in conc. mineral acids, except hydrofluoric acid; when freshly precipitated, soluble (with formation of a complex) in a mixture of H_3PO_4 , oxalic acid and conc. H_2SO_4 . An acid-soluble, white peroxy compound is formed when a cold suspension of the phosphate is reacted with an $\text{NaOH}-\text{Na}_2\text{O}_2$ solution and then digested at 70°C . ZrP_2O_7 crystallizes in the cubic $\text{K} 6_1$ lattice.

REFERENCES:

- I. G. Hevesy and K. Kimura. *Angew. Chem.* **38**, 775 (1925); *J. Amer. Chem. Soc.* **47**, 2540 (1925); see also J. H. de Boer, *Z. anorg. allg. Chem.* **144**, 193 (1925).
- II. E. M. Larsen, W. C. Fernelius and L. L. Quill. *Analyt. Chem.* **15**, 512 (1943).

Titanium, Zirconium and Hafnium Carbides

TiC, ZrC, HfC

Titanium Carbide

Methods I to III, given in detail for the preparation of TiN, are also useful for synthesis of carbides. These are: I) the industrial process $\text{TiO}_2 + \text{C}$; II) synthesis from the elements; and III) vapor deposition. The last process may be modified by first depositing the metal from a vapor and then converting the deposit (on a glow wire) to the carbide by heating in a hydrocarbon atmosphere (method IV), or by using a glowing carbon wire in an atmosphere of TiCl_4 vapor (method V).

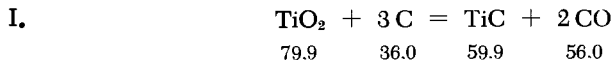

In the method of Agte and Moers, a mixture of pure TiO_2 and acetylene-derived carbon black (the latter degassed at 2000°C) is placed in a graphite boat and heated for half an hour in a tubular graphite furnace to $1700\text{--}1800^\circ\text{C}$. Very pure and dry H_2 is used to flush the apparatus. Since the hydrogen reacts with the hot graphite tube to form hydrocarbons, the carbon content of the raw material mixture should be 15–25% less than the stoichiometric ratio. The products usually still contain some oxygen.

If the $\text{TiO}_2 + 3\text{C}$ mixture is heated very rapidly (within 20 minutes) to 1900°C in a stream of H_2 or CO , a product containing 19.5% C may be obtained (as demonstrated by Meyerson); further heating reduces the carbon content to 17%, because of decarbonization.

PRESINTERING

The carbide rods, made of powder compressed at 2000 kg./cm^2 , are heated in a graphite boat inside a tubular graphite furnace to temperatures between 2500 and 3000°C and maintained at these temperatures for about 15 minutes. The material is protected against surface absorption of additional carbon by embedding the rods in carbide powder.

Due to considerable shrinkage of the rods, the processes of repulverization, recompression and resintering must be repeated 2-4 times.

HIGH-TEMPERATURE SINTERING

Since the carbides decompose in vacuum, the high-temperature sintering must be carried out in an atmosphere of technical-grade argon. The rods are heated to extremely high temperatures—just short of the melting point (for a description of this procedure, see TiN, p. 1234). Most of the impurities evaporate at these temperatures, leaving a relatively pure product.



Titanium filings are mixed in the stoichiometric ratio with acetylene-derived carbon black (very thoroughly degassed at 2000°C), and the reaction is started by heating to 1800°C in a BeO boat placed inside a high-vacuum furnace (see Part I, p. 40 for description). The beryllium oxide boats are set up inside the heating element, which consists of tungsten boats (40 mm. long, 10 mm. wide, 8 mm. high) subjected to high-intensity (200 amp.) low-voltage current. The final sintering of the finely powdered crude product requires 10 minutes at 2400°C.

III. In this process a tungsten wire, which serves only as a substratum for the deposit, is heated to glowing in an atmosphere consisting of a volatile halide of the metal, a carbon compound and H₂. Moers recommends the use of hydrocarbons such as toluene, instead of CO; the deposition of free carbon with the carbide is avoided if the partial pressure of the hydrocarbon in the system is low. The hydrogen atmosphere facilitates considerably the reaction at the glow wire by reducing the decomposition temperatures of the halides to a much greater extent than does reduced pressure or even vacuum.

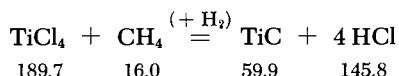

A pure hydrogen stream (which must be free of N₂ and O₂ and is therefore most conveniently generated by electrolysis) is divided into two fractions, one of which is passed through a 25°C wash bottle filled with TiCl₄, the other through a similar bottle containing toluene at -15°C; the streams are then recombined and introduced into the reactor. The glow wire is maintained at a temperature of 1600°C, which is kept constant during the experiment by gradually increasing the current. Further details are given by K. Moers.

Alternate methods:

IV. A modification of the method just described consists in heating the metal wire prepared by the vapor deposition process in a hydrocarbon atmosphere. This modification is not, however, very convenient in the case of the lower-melting metals (Ti, Zr) since the wire temperatures must be relatively low and thus very long glow times are required. It may be used successfully with W, Ta and Hf.

V. Another method of avoiding introduction of the tungsten wire (which is used as a substratum in all previously described vapor deposition processes) into the product reverses the above procedure; i.e., a carbon wire is heated to incandescence in the vapor of a volatile halide of the metal (in the presence or in the absence of H_2).

The method suffers from one disadvantage: the dissociation of the chlorides at the glow wire does not cease when all the carbon originally present in the wire has been consumed. As a result, the products contain varying amounts of the free metal dissolved in the carbide. Carbides of stoichiometric composition are obtained either by calcining the above products in high vacuum (to evaporate the dissolved metal) or in a hydrocarbon atmosphere (to convert the excess metal to carbide). Further details are given in the reference cited below.

PROPERTIES:

Gray powder. Insoluble in hydrochloric acid, soluble in nitric acid. M.p. 3410°C ; d 4.92. Very good electrical conductor with a positive temperature coefficient. Crystal structure: type B1 (NaCl type), with a considerable range of phase compositions ($\text{TiC}_{1.0} - \text{Ti}_{0.3}$).

Zirconium Carbide and Hafnium Carbide

These compounds are prepared by the same procedures as titanium carbide. The reaction mixture consists of either ZrO_2 (or HfO_2) + 3 C, or Zr (or Hf) + C; the reaction temperatures lie above 2000°C . Since both ZrC and HfC are very sensitive to N_2 , the high-temperature sintering stage must be carried out in 99% Ar.

Just like TiC, both ZrC and HfC dissolve carbon when molten. This phenomenon is most detrimental in the case of ZrC, whose melting point is lowered from 3500°C to about 2450°C by the absorption of carbon; the carbon is released on cooling.

The procedures employed for the preparation of TiC by the vapor deposition process must be modified somewhat in the case of ZrC and HfC, since both ZrCl_4 and HfCl_4 are solids. The

reactor is filled with a sufficient quantity of the chloride and its lower section is heated with a small furnace to a temperature at which the vapor pressure is about 10-20 mm. (that is, to about 300°C). The same applies in method V.

The industrial preparation of ZrC from ZrSiO₄ and carbon in a graphite crucible using an arc furnace is described by W. Kroll et al. [Trans. Electrochem. Soc. 89, 263, 317 (1946); 92, 187 (1947); J. Electrochem. Soc. 94, 1 (1948)].

REFERENCES:

- General: C. Agte and K. Moers. Z. anorg. allg. Chem. 198, 233 (1933).
- I. G. A. Meyerson and Y. M. Lipkes. Zh. Prikl. Khimii 18, 24, 251 (1945); see also E. Friederich and L. Sittig. Z. anorg. allg. Chem. 144, 169 (1925).
- II. P. Ehrlich. Z. anorg. Chem. 259, 1 (1949).
- III and IV. A. E. van Arkel and J. H. de Boer. Z. anorg. allg. Chem. 148, 345 (1925).
- V. W. G. Burgers and J. C. Basart. Z. anorg. allg. Chem. 216, 209 (1934).

Thorium Carbides

ThC, ThC₂

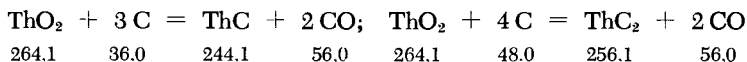

Thorium carbides are prepared in an electric arc furnace. The arc is produced in a graphite crucible containing the reaction mixture. About 200 amp. at 110 v. is required to melt the mixture.

A mixture of ThO₂ and calcined carbon black (0.24% ash) or graphite powder (0.33% ash), in quantities corresponding to the above equations, is made into a paste with a small amount of water and starch, and evaporated with stirring (graphite is preferred to carbon black because of its smaller volume). The lumps of dried material are placed in a crucible by means of a porcelain spatula; their large size prevents them from being carried out of the crucible by the CO gas evolved in the process.

PROPERTIES:

ThC₂: Opaque, dark-yellow pseudotetragonal crystals with a metallic luster. M.p. 2650°C; d 8.96. Completely miscible with

ThC at high temperature, practically immiscible at room temperature. Forms a eutectic with graphite (empirical formula $\text{ThC}_{2.8}$, m.p. 2500°C). Decomposes slowly in water, rapidly in dilute acids, evolving a mixture of hydrocarbons (chiefly acetylene) and H_2 .

ThC: M.p. 2620°C . Crystal structure: NaCl type. For material of empirical formula $\text{ThC}_{0.39}$, the miscibility gap begins at a temperature of 1980°C ; the gap widens at room temperature to $\text{ThC}_{0.05}$ - $\text{ThC}_{0.76}$.

REFERENCES:

- M. von Stackelberg. Z. phys. Chem. (B) 9, 437 (1930); H. A. Wilhelm and P. Chiotti. Trans. Amer. Soc. Metals 42, 1295 (1950).

Titanium, Zirconium and Thorium Silicides



I. PREPARATION FROM THE ELEMENTS

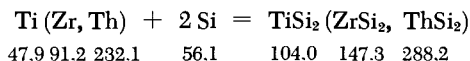

The silicides are prepared by fusing or sintering intimate stoichiometric mixtures of the elements (in powder form). The reaction is carried out in sintered clay or ceramic crucibles, placed in a Tammann furnace under a blanket of Ar. In all three cases the reaction takes place at a relatively low temperature and is highly exothermic; therefore, one should work with gram quantities only.

In the method of Alexander, some advantage is gained by replacing the pure metals with hydride powders. Initial heating takes place in vacuum, which at 400 - 500°C is replaced by an atmosphere of H_2 evolved by the reaction itself. This gives a sintered silicide at temperatures as low as 900°C .

Brauer and Mitius modified a method developed by Hönigschmid and prepare ThSi_2 by the following procedure. Intimate mixtures of Al, Th and Silumin (13% Si, 87% Al) powders are compressed into tablets 10 mm. long and 5 mm. thick, placed in alumina crucibles and fused at 1100°C in high vacuum. Slow cooling (from 1100°C to 800°C in four hours) produces good crystals of the product within the aluminum ingot. These are freed of excess Al by alternate treatments with dilute hydrochloric acid and potassium hydroxide (moderate heating), followed by washing with water and alcohol. Since most of the silicide particles form cohesive

granules with the Si and SiO_2 contaminants, the crystallites are pulverized in an agate mortar and separated from foreign matter (particularly SiO_2 , which cannot be removed by chemical means) by flotation with bromoform (d 2.9). The bromoform must be continuously renewed. Evaporation with hydrofluoric acid is not practical, since it destroys the silicide.

Alternate methods:

II. ALUMINOTHERMIC METHOD

Ignition of a mixture of, for example, 200 g. of Al powder, 250 g. of S, 180 g. of SiO_2 and 15 g. of TiO_2 (or 40 g. of K_2TiF_6), covered with a thin layer of Mg, yields an ingot containing, in addition to Si and Al, small, iron-gray tetragonal pyramids of TiSi_2 .

III. ELECTROLYTIC PREPARATION

The pure, crystalline silicides are obtained by melt electrolysis of a mixture of, for example, $10 \text{K}_2\text{SiF}_6 + \text{TiO}_2$ at about 900°C , using an iron cathode; alternately, electrolysis of TiO_2 dissolved in a melt of silicate may be used.

IV. REACTION OF THE METAL WITH SILICON TETRACHLORIDE

The silicides are obtained in the form of a coating on the reactor walls when the metals are heated to $1100\text{--}1500^\circ\text{C}$ in a hydrogen stream saturated with SiCl_4 .

PROPERTIES:

Grayish-white crystals with a metallic luster and good thermal and electrical conductivity. d (TiSi_2) 4.02; (ZrSi_2) 4.88; (ThSi_2) 7.63. TiSi_2 and ZrSi_2 are insoluble in mineral acids (except hydrofluoric acid); ZrSi_2 is also insoluble in 10% KOH. TiSi_2 dissolves slowly in 10% KOH. ThSi_2 is unaffected by alkali, but dissolves in dilute and conc. hydrogen halides (slowly in the cold and rapidly when heated). Attacked by Cl_2 at temperatures as low as 500°C . TiSi_2 is stable at red heat in air, while ZrSi_2 and ThSi_2 burn.

REFERENCES:

- I. O. Hönigschmid. *Monatsh. Chemie* **28**, 1017 (1907); P. P. Alexander. *Metals and Alloys* **9**, 179 (1938); F. Laves and H. J. Wallbaum. *Z. Kristallogr.* **101**, 78 (1939); G. Brauer and A. Mitius. *Z. anorg. allg. Chem.* **249**, 325 (1942); E. L. Jacobson, R. D. Freeman, A. G. Tharp and A. E. Searcy. *J. Amer. Chem. Soc.* **78**, 4850 (1956); see also H. J. Wallbaum. *Z. Metallkunde* **33**, 378 (1941).

- II. O. Hönigschmid. Comptes Rendus Hebd. Séances Acad. Sci. 142, 157, 280 (1906); Monatsh. Chem. 27, 205, 1069 (1906).
- III. M. Dodero. Comptes Rendus Hebd. Séances Acad. Sci. 208, 799 (1939); J. L. Andrieux. Congr. Chim. Industr. Nancy 18 I, 124 (1938); Rev. Métallurgie 45, 49 (1948).

Vanadium, Niobium, Tantalum

G. BRAUER

Vanadium

V

The preparation of high-purity V metal is difficult because it tends to form very stable occluded phases with nonmetals, particularly with O, N and C. These elements must be removed in advance, because their elimination from the metal phase at a later stage is difficult. Hence only a few of the many proposed methods afford a ductile metal or V powder of a high degree of purity.

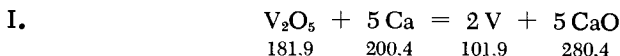

In the method of Marden and Rich, 175 g. of V_2O_5 is mixed with 300 g. of ground Ca and 300 g. of CaCl_2 (dehydrated by preheating at 450°C), and the mixture placed in a small sealable iron bomb. The addition of CaCl_2 as fluxing agent is essential. A small piece of Na or K is also added (to act later as a scavenger for residual O_2 and H_2O), or the bomb is evacuated and then filled with Ar. The bomb is tightly sealed either by screwing down the lid or by welding, heated one hour at $900\text{--}950^\circ\text{C}$, cooled to *room temperature* and then reopened. The product is chipped out with a chisel, and the chunks are added, slowly and with agitation, to about 20 liters of cold water (avoid local overheating). The product disintegrates and is allowed to settle for about 2 min. The supernatant is decanted; the solid is washed (by decantation) several times with H_2O , then several times with approximately 2 N HCl. The product is ductile, granular V metal.

According to McKechnie and Seybolt, the reaction between V_2O_5 and Ca is coupled to advantage with the strongly exothermic reaction $\text{Ca} + \text{I}_2 = \text{CaI}_2$. In this case, CaI_2 has the desirable effect of reducing the melting point of the mixture, thus replacing the CaCl_2 used in the previous method.

For example, a mixture of 300 g. of specially purified V_2O_5 (see below), 552 g. of metallic Ca (i.e., about 60% excess) and 150 g. of

I_2 is placed in a sintered magnesia crucible, which is in turn placed in a 1.5-liter steel bomb; the bomb is then hermetically sealed. With the above quantities, the steel bomb should have a diameter of 100 mm., a height of 280 mm. and a 10-mm.-thick wall; the lid should be a steel plate held between bolted-down flanges. The magnesia crucible can be closed with a cover of the same material (the cover is formed by pressure-shaping granular magnesia with a steel cover). The bomb is evacuated, filled with Ar, closed and heated to about 425°C to start the reaction. Immediately after ignition, spontaneous heating to a much higher temperature takes place, accompanied by an unusual noise. Granular and powdered V is isolated from the reaction product in 74% yield.

The V_2O_5 , which is normally prepared from NH_4VO_3 , must be freed before use of small amounts of N and H still adhering to it. One method of accomplishing this is heating the oxide for 18 hours in a stream of moist O_2 at 400°C.

II. The following reduction affords V as a fine powder:

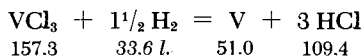

A stream of H_2 , thoroughly freed of traces of O_2 , N_2 or H_2O (see p. 112 ff., N_2 removal as for Ar, p. 82 ff.), is passed over a platinum boat located in a Pt tube and containing about 7 g. of VCl_3 . The Pt tube forms an insert for a porcelain tube and protects the latter from attack by the subliming VCl_3 and by the V formed from such a sublimate; it also ensures the protection of the boat contents from contamination by Si compounds from the porcelain tube. The V formed during the reaction is further protected against contamination by placing a porcelain boat containing powdered V ahead of the Pt boat. This protective vanadium (which may be less pure) serves to remove the last traces of N_2 and O_2 from the gas stream. The reactor tube is connected to a large, empty U tube which allows observation of the exit gas and is, in turn, connected to a KOH-filled trap.

The porcelain tube is slowly heated to, and then held at, a temperature of 900°C until HCl evolution (which follows the initial formation of a small quantity of brown fumes) is complete. After cooling to room temperature (and not before), the product is removed from the reactor in a stream of H_2 . At this point, it consists of vanadium hydride (approximate composition $VH_{1.7}$), which is converted to pure V by heating in high vacuum. It should be borne in mind that finely subdivided vanadium and vanadium hydride are sensitive to atmospheric O_2 even at room temperature.

The Pt sheet absorbs some V during the reaction and turns darker, brittle and fragile. The vanadium can be removed from

the Pt in the form of V_2O_5 by heating to red heat in air or, via a more drastic method, by treatment with a molten mixture of 1 part of KNO_3 and 15 parts of $NaKCO_3$. The Pt is thus completely regenerated. It should be possible to replace the porcelain tube, with no loss of efficiency, by an alumina tube.

Alternate methods: a) Very pure V can be obtained by deposition from the gas phase in the apparatus shown in Fig. 291, p. 1168. In this case the apparatus is made of fused quartz and is heated to 900-1000°C during the reaction. A suitable crude metal starting product is obtained, for example, by reacting a mixture of VCl_3 and Na in a heated iron bomb. Since the transport to the incandescent wire is accomplished via VI_2 , whose volatility is relatively low, this process is not as advantageous in the case of V as with metals of Group IV [A. E. van Arkel, *Metallwirtsch.* 13, 405 (1934); J. W. Nash, H. R. Ogden, R. E. Durtschi and I. E. Campbell, *J. Electrochem. Soc.* 100, 272 (1953); H. W. Rathmann and H. R. Grady, *Vancoram Rev.* 10, 6, 17 (1955)].

b) With Ar as the carrier phase, the reduction of VCl_4 with H_2 (affording pure V powder) can be accomplished at 620°C [G. Jantsch and F. Zenek, *Monatsh. Chem.* 84, 1119 (1953)].

c) According to another proposed method, a stream of dry, high-purity H_2 saturated with VCl_4 vapor is passed over Mg turnings (in a MgO boat) and gradually heated to 700°C over a period of 2.5 hours. After cooling, the product mixture of V, VCl_2 and VCl_3 is thoroughly extracted with H_2O to dissolve out any chlorides present. The residue of V powder (99.3% V) is then vacuum-dried.

d) A mixture of 2 parts of VCl_2 and 1 part of Mg is pressed into pellets and these are heated for 1-2.5 hours at 700°C in a MgO boat inserted in a quartz tube (H_2 or Ar atmosphere). The product metal contains up to 99.5% V [A. Morette, *Comptes Rendus Hebd. Séances Acad. Sci.* 200, 1110 (1935)].

Solid V metal is comminuted and reduced to a fine powder via the vanadium hydride stage. Thus, vanadium is heated to about 500°C in a stream of high-purity H_2 and is then cooled in the same gas. The hydride is very brittle and can be readily comminuted by pounding or grinding in a volatile organic liquid such as benzene, which protects it against local heating and oxidation. The comminuted material is then dehydrogenated to pure V metal by heating in high vacuum (W. D. Schnell, Thesis, Univ. of Freiburg i. Br., 1960).

The purity of high-grade V can be further increased (to about 99.997%) by long heating (e.g., for 20 hours) in a high vacuum (10^{-5} mm.) at 1650°C (W. D. Schnell, Thesis, Univ. of Freiburg i. Br., 1960).

For information concerning melting V metal in crucibles made of various materials, see T. W. Merrill, *Vancoram Rev.* 11, 11, 16 (1956).

PROPERTIES:

Atomic weight 50.95. Light-gray metal, ductile when pure. M.p. 1900°C; d 6.11. Insoluble in hydrochloric and sulfuric acids, soluble in nitric and hydrofluoric acids. High affinity for O, N, C and H. Surface reaction with atmospheric O₂ starts already at 20°C; this can lead, particularly in the case of a fine powder, to considerable contamination. Crystal structure: type A₂.

REFERENCES

- General: E. A. van Arkel. *Reine Metalle* [Pure Metals], Berlin, 1939; H. Funk. *Darstellung der Metalle im Laboratorium* [Laboratory Preparation of Metals], Stuttgart, 1938; C. A. Hampel. *Rare Metals Handbook*, New York, 1964.
- I. J. W. Marden and H. C. Rentschler. *Ind. Eng. Chem.* 19, 97 (1927); E. D. Gregory, W. C. Lilliendahl and D. M. Wroughton. *J. Electrochem. Soc.* 98, 395 (1951); A. P. Beard and D. D. Crooks. *J. Electrochem. Soc.* 101, 597 (1954); R. K. McKechnie and A. U. Seybolt. *J. Electrochem. Soc.* 97, 311 (1950); J. R. Long. *Iowa State Coll. J. Sci.* 27, 213 (1953).
- II. Th. Döring and J. Geller. *Z. anorg. allg. Chem.* 221, 56 (1934).

Vanadium (II) Chloride

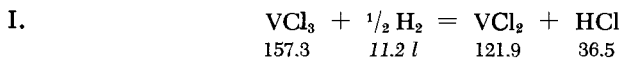

The reactor is a Pyrex, Vycor or fused quartz tube, and the VCl₃ is placed either directly in the tube or in a porcelain boat (the transfer to the reactor requires great care, because VCl₃ is very hygroscopic). A stream of dry, completely deoxygenated hydrogen is then passed through the tube (the end of the tube is protected against moisture by a CaCl₂ tube), and the system is heated to about 400°C. While HCl is evolved, the temperature is gradually increased to 675°C. Care should be taken not to exceed 700°C (according to Klemm and Hoschek, not even 500°C), otherwise reduction to V metal will occur. The reaction time depends on the quantity of material used; it is about 1 hour for 0.5 g., and about 40 hours for 30 g. At the end of the reaction, the H₂ stream is replaced by a stream of P₂O₅-dried N₂ or CO₂, and the VCl₂ produced is discharged from the reactor under anhydrous conditions. A high yield (~90%) is obtained.

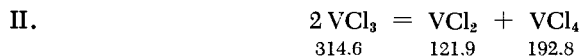

Rapid disproportionation of VCl₃ according to the above equation can be achieved at 800°C in a stream of high-purity N₂. The VCl₄

is carried away by the N_2 stream (4 bubbles/sec.), while the VCl_3 remains in the reactor tube. The temperature should not exceed $850^\circ C$, to avoid loss of VCl_3 by sublimation. The reaction is fairly fast; for example, the reaction of 20 g. of VCl_3 takes 2 hours.

PROPERTIES:

Light-green leaflets; m.p. about $1350^\circ C$; d. 3.09. Less hygroscopic than VCl_3 and VCl_4 ; insoluble in alcohol or ether. Crystal structure: CdI_2 type.

REFERENCES:

- I. F. Ephraim and E. Ammann. *Helv. Chim. Acta* **16**, 1273 (1933); W. Klemm and E. Hoschek. *Z. anorg. allg. Chem.* **226**, 359 (1936); R. C. Young and M. E. Smith in: J. C. Bailar, *Inorg. Syntheses*, Vol. IV, New York-London-Toronto, 1953, p. 126; H. Funk and W. Weiss. *Z. anorg. allg. Chem.* **295**, 327 (1958).
- II. O. Rugg and H. Lickfett. *Ber. dtsch. chem. Ges.* **44**, 506 (1911); P. Ehrlich and H. J. Seifert. *Z. anorg. allg. Chem.* **301**, 282 (1959).

Vanadium (III) Chloride



VCl_3

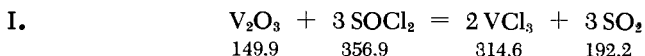

Vanadium trioxide powder (2.1 g.) and 8.5 ml. of pure $SOCl_2$ are placed in a bomb tube about 1.5 cm. in diameter, and the sealed tube is heated for 24 hours at $200^\circ C$. The tube is cooled to below $0^\circ C$ (in order to lower the SO_2 vapor pressure) and is then opened to allow SO_2 to escape. Then the tube contents are flushed out, under anhydrous conditions, into a small flask, using some $SOCl_2$ for this purpose (the $SOCl_2$ is then removed by vacuum distillation). The VCl_3 residue is washed several times with very pure CS_2 to remove traces of S_2Cl_2 , and then thoroughly vacuum-dried at $80^\circ C$. Fine crystals of dark-violet VCl_3 are obtained in nearly quantitative yield.

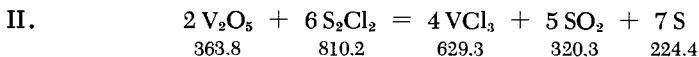

Fine, pure V_2O_5 powder (18 g.) and 40 ml. of S_2Cl_2 are refluxed under anhydrous conditions for 8 hours (constant stirring). The

excess S_2Cl_2 , containing dissolved S, is decanted and the VCl_3 formed is washed with dry CS_2 . Adhering volatiles are removed by heating the material at 120-150°C under vacuum or by extracting it for several hours with CS_2 in a Soxhlet apparatus. After thorough purification, the residual sulfur content of the resulting fine crystals of VCl_3 is about 0.2%. The yield is about 30 g.

Coarse (and hence less hygroscopic) crystals of VCl_3 are obtained by heating the fine crystalline product with a small amount of fresh S_2Cl_2 in a sealed tube at 240°C. Since no gas is evolved in this operation, large amounts can be treated at one time.

The same reaction can also be carried out in a sealed tube at 300°C; however, smaller quantities must be used in this case (6-7 g. of V_2O_5 and 20 ml. of S_2Cl_2).

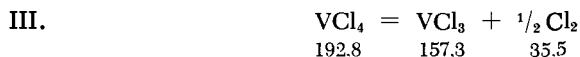

A flask containing VCl_4 is connected to a reflux condenser via a ground joint and kept at 160-170°C for 2 days while passing a thoroughly dried and deoxygenated stream of CO_2 or H_2 through the system (to remove the Cl_2 formed in the thermal dissociation). The flask is then arranged for distillation; unreacted VCl_4 and the traces of the $VOCl_3$ formed are distilled off at 200°C in a H_2 stream. Reduction does not take place under these conditions. The by-products can also be removed by vacuum distillation. All operations are carried out under anhydrous conditions.

Alternate methods: IV. Reaction of VCl_4 with S, removal of the S_2Cl_2 by distillation, then heating of the product at a temperature somewhat below 300°C in a stream of CO_2 .

V. If V metal is available as a very fine powder, it can be reacted with excess ICl , according to the equation:

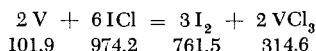

The mixture is heated under anhydrous conditions in a glass flask equipped with a reflux condenser. The flask is carefully heated with a direct flame until the initially vigorous reaction, which affords iodine vapor, subsides and vapors of the boiling ICl become visible. After cooling, the mixture is extracted with CCl_4 (distilled from P_2O_5), filtered in a N_2 stream through a sintered glass disk, washed with CCl_4 and dried in a vacuum desiccator. The product is very pure provided all of the vanadium has reacted.

PROPERTIES:

Formula weight 157.3. Violet, quite crystalline. Very hygroscopic. Soluble in acidified water. In the absence of air, can be

obtained from solutions as $VCl_3 \cdot 6H_2O$. Soluble in alcohol, insoluble in ethyl ether. d 3.0. Crystal structure: DO_5 ($FeCl_3$) type.

REFERENCES:

- I. H. Hecht, G. Jander and H. Schlapmann. *Z. anorg. Chem.* **254**, 255 (1947); experiments carried out at the University Laboratory, Freiburg i. Br., 1951.
- II. H. Funk and C. Müller. *Z. anorg. allg. Chem.* **244**, 94 (1940); experiments carried out at the University Laboratory, Freiburg i. Br., 1951; H. Hartmann and H. L. Schläfer. *Z. Naturforsch.* **6a**, 754 (1951); H. Funk and W. Weiss. *Z. anorg. allg. Chem.* **295**, 327 (1958).
- III. J. Meyer and R. Backa. *Z. anorg. allg. Chem.* **135**, 177 (1924); F. Ephraim and E. Ammann. *Helv. Chim. Acta* **16**, 1273 (1933); R. C. Young and M. E. Smith in: J. C. Bailar, *Inorg. Syntheses*, Vol. IV, New York-Toronto-London, 1953, p. 128.
- IV. O. Ruff and H. Lickfett. *Ber. dtsh. chem. Ges.* **44**, 506 (1911); F. Ephraim and E. Ammann. *Helv. Chim. Acta* **16**, 1273 (1933).
- V. V. Gutmann. *Monatsh. Chem.* **81**, 1155 (1950).

 $VCl_3 \cdot 6H_2O$

The hexahydrate can be obtained from aqueous, acidic VCl_3 solution by cooling and saturating with HCl. The starting solution is obtained by electrolytic reduction of a solution of V_2O_5 in hydrochloric acid or, more conveniently, by dissolving V_2O_3 in hydrochloric acid.

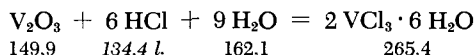
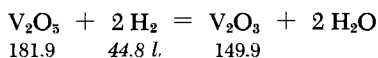

For example, 7.5 g. of V_2O_3 (obtained by reduction of V_2O_5 with H_2 as described on p. 1267) is dissolved in 200 ml. of conc. HCl by allowing the mixture to boil several hours. This solution is concentrated to 50 ml., cooled to -10 to $-20^\circ C$, and saturated with HCl gas. The precipitate of green $VCl_3 \cdot 6H_2O$ is suction-filtered on glass frit, dissolved in some H_2O , and reprecipitated with HCl while cooling (see also the preparation of $TiCl_3 \cdot 6H_2O$, p. 1193 f.).

PROPERTIES:

Formula weight 265.4. Green, hygroscopic crystals.

REFERENCES:

- A. Piccini and M. Brizzi. *Z. anorg. Chem.* **19**, 394 (1899); P. Ehrlich and H. J. Seifert. *Z. anorg. allg. Chem.* **301**, 282 (1959).

Vanadium (IV) Chloride

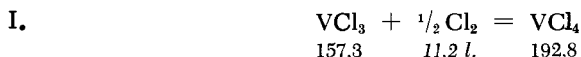

In the method of Funk and Weiss VCl_3 , which is readily obtained from V_2O_5 and S_2Cl_2 (see p. 1256), is loosely packed in a slightly inclined reactor tube made of high-melting glass. The tube is connected by a ground joint to a receiver, which is protected against moisture. A glass-wool wad is placed at the end of the reactor tube to prevent solid VCl_3 particles from reaching the receiver. Dry Cl_2 is passed through the apparatus to displace the air; the VCl_3 is then heated, starting from the end closest to the receiver. The reaction rate can be controlled by regulating the Cl_2 flow. The crude VCl_4 is collected in the receiver, which is kept at 0°C ; it is then distilled from this receiver in a slow stream of Cl_2 (anhydrous conditions), discarding the forerun. Approximately 35 g. of pure VCl_4 is obtained from 30 g. of VCl_3 .

II. A process similar to that described in method I may be used to prepare VCl_4 from ferrovanadium and Cl_2 . A very long reactor tube is used, and the reaction rate is regulated so as to allow most of the by-product FeCl_3 to settle out. The VCl_4 must be redistilled from the receiver.

Alternate method: Disproportionation of VCl_3 to VCl_2 and VCl_4 by heating in a N_2 stream at 900°C in a porcelain tube [O. Ruff and H. Lickfett, Ber. dtsh. chem. Ges. 44, 506 (1911)].

PROPERTIES:

Dark red-brown liquid. M.p. -109°C , b.p. 148.5°C ; d 1.87. Fumes in air, and even at normal temperature shows a marked Cl_2 vapor pressure (decomposition). Sealed ampoules containing VCl_4 should be stored in the dark (occasionally they shatter because of high internal pressure). Decomposed by water. Soluble in conc. hydrochloric acid, ethanol and ethyl ether.

REFERENCES:

- I. H. Funk and W. Weiss. Z. anorg. allg. Chem. 295, 327 (1958).
- II. A. T. Mertes, J. Amer. Chem. Soc. 35, 671 (1913); F. Ephraim and E. Ammann. Helv. Chim. Acta 16, 1273 (1933); J. H. Simons and M. G. Powell. J. Amer. Chem. Soc. 67, 75 (1945).

Vanadium (II) Bromide

VBr₂

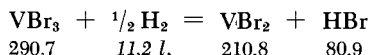

The starting material is VBr₃, which is best left in the tube used for its preparation (see below). In this case, the reactor tube is considerably longer than that used merely to prepare VBr₃.

The zones containing VBr₃ are heated, one after another, to dark-red heat while a H₂ stream is passed through. The heating is best accomplished in a tubular electric furnace, in which heating is more uniform than with open flames; with such a furnace, pronounced local overheating and reaction rate differentials are prevented and the total reduction time is short. The reduction of 2 g. of VBr₃ takes 1-1.5 hours.

PROPERTIES:

Light-brown to reddish; light pink-red when heated. Feltlike to flaky crystal aggregates. More hygroscopic than VCl₂, but not as sensitive as VBr₃. Gives a violet solution with H₂O; this soon turns brown, evolving H₂. d 4.58. Crystal structure: C6 (CdI₂) type.

REFERENCES:

- F. Ephraim and E. Ammann. *Helv. Chim. Acta* **16**, 1273 (1933);
W. Klemm and E. Hoschek. *Z. anorg. allg. Chem.* **226**, 359 (1936).

Vanadium (III) Bromide

VBr₃

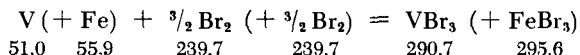

A high-melting glass tube, 10-12 mm. I.D. and 80 cm. long, is charged with 5 g. of very finely powdered high-grade ferrovanadium (no boat is used). A stream of thoroughly dried CO₂ is passed through a small round-bottom flask in which absolutely dry Br₂, slowly introduced from a dropping funnel, is vaporized by slight heating. The CO₂ and Br₂ vapors then pass through the reactor tube. The other end of the reactor carries (preferably sealed on) containers for the subsequent collection of VBr₃ (e.g., tubes which can be melt-sealed), which are protected from the atmosphere by a P₂O₅

tube. Air and moisture must be rigorously excluded. After filling the reactor with $\text{CO}_2 + \text{Br}_2$, the Fe-V is heated to red heat. The first product is a small amount of VOBr_3 , which is quickly and readily displaced by heating the entire tube length to prevent the deposition of vanadium oxide (the latter cannot be removed). The conversion to VBr_3 and FeBr_3 is then carried out over a period of about 4 hours. Most of the FeBr_3 remains at the exit end of the tube, while the Br_3 sublimes out. It is freed of FeBr_3 by repeated sublimation. Rather low sublimation temperatures and long sublimation tubes are required in this procedure. Finally the system is flushed with pure, Br_2 -free CO_2 .

PROPERTIES:

Black with greenish reflections, crystalline; the vapor is violet. Extremely hygroscopic. d 4.52.

REFERENCES:

- J. Meyer and R. Backa. *Z. anorg. allg. Chem.* **135**, 177 (1924);
 F. Ephraim and E. Amman. *Helv. Chim. Acta* **16**, 1273 (1933);
 W. Klemm and E. Hoschek. *Z. anorg. allg. Chem.* **226**, 359 (1936).

Vanadium (II) Iodide

VI_2

This compound is prepared by synthesis from the elements.

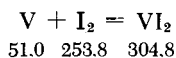

I. In the method of Morette, VI_3 is first prepared from V and I_2 (see the following preparation) and then decomposed by heating at 400°C in high vacuum while removing the I_2 split off. The decomposition is virtually complete in 24 hours.

II. In the method of Klemm and Grimm, a stoichiometric mixture of V turnings and I_2 is sealed under vacuum into a short quartz tube, with occasional cooling to reduce the I_2 vapor pressure. The entire tube is then uniformly heated at $160\text{-}170^\circ\text{C}$.

PROPERTIES:

Dark-violet, hexagonal leaflets. Not readily wetted by H_2O ; slowly forms a violet solution. Insoluble in absolute ethanol, benzene, CCl_4 , CS_2 . Partly oxidized in air, turning brown. d 5.44. Crystal structure: C6 (CdI_2) type.

REFERENCES:

- A. Morette. Comptes Rendus Hebd. Séances Acad. Sci. 207, 1218 (1938); W. Klemm and L. Grimm, Z. anorg. allg. Chem. 249, 198 (1942).

Vanadium (III) Iodide



Formed when metallic V and I_2 are heated at 300°C under the vapor pressure generated by the latter.

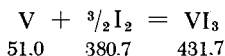

Vanadium metal (turnings or powder) and excess I_2 are placed in a hard glass or fused quartz tube, closed at one end; the tube contents are cooled to -80°C ; the tube is thoroughly evacuated and then melt-sealed to a short total length. A vigorous reaction sets in on heating. The entire tube is heated for a while at temperatures up to 300°C in order to achieve product uniformity. The excess I_2 is then allowed to distill off into a somewhat cooler zone, and the tube is quickly cooled and opened.

PROPERTIES:

Brown-black, crystalline powder. Very hygroscopic. Readily soluble in water giving a brown solution which turns gradually green in air. Also soluble in absolute ethanol; insoluble in benzene, CCl_4 , CS_2 . d 4.2.

REFERENCE:

- A. Morette. Comptes Rendus Hebd. Séances Acad. Sci. 207, 1218 (1938).

Vanadium Oxychloride

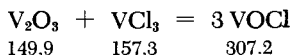

A quartz tube, about 180 mm. long and 15 mm. in diameter, is charged with 1 g. of V_2O_3 and 2 g. of VCl_3 under anhydrous

conditions. The tube is thoroughly evacuated, melt-sealed and placed horizontally in a furnace providing a temperature gradient such that the raw material is kept at 720°C and the empty half of the tube at 620°C (see Part I, p. 76 f. and preparation of TiOCl, p. 1209). After 1-2 days, VOCl forms as a crystalline deposit in the center of the tube and a dense mass on the 720°C side. In addition, small amounts of VCl₂, VCl₃, VCl₄ and VOCl₃ are also present. The tube is opened in dry N₂, and the VCl₄ and VOCl₃ are vaporized in vacuum. The tube contents are then slurried in dimethylformamide, and the VCl₂ and VCl₃ are removed from the VOCl by repeated slurrying and decantation with this solvent. The VOCl, obtained as the residue, is washed with ethanol and ethyl ether and vacuum-dried.

Alternate methods: Vanadium oxychloride can also be obtained

a) by heating VCl₃ and CO₂ [O. Ruff and H. Lickfett, Ber. dtsch. chem. Ges. 44, 506 (1911); E. Wedekind and C. Horst, Ber. dtsch. chem. Ges. 45, 262 (1912)];

b) by heating VCl₃ in an O₂-containing N₂ stream;

c) by heating VOCl₂ in a pure N₂ stream [P. Ehrlich and H. J. Seifert, Z. anorg. allg. Chem. 301, 282 (1959)].

PROPERTIES:

Formula weight 102.41. Brown crystals, the particle size depending on method of preparation. Decomposes at about 600°C into VCl₃ and the oxide; not attacked by H₂O, hydrochloric acid or alkalis; dissolves in warm conc. HNO₃ and conc. H₂SO₄. d 3.44. Rhombic crystals, isotypical with FeOCl.

REFERENCES:

H. Schäfer and F. Wartenpfehl. J. Less-Common Metals 3, 29 (1961); P. Ehrlich and H. J. Seifert. Z. anorg. allg. Chem. 301, 282 (1959).

Vanadium Oxydichloride

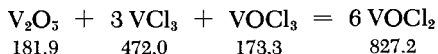

A thoroughly ground mixture of 3.6 g. of dry V₂O₅ and 9.4 g. of VCl₃ is placed at the closed end of a 1-m.-long tube, and 0.9 ml. of VOCl₃ is then added. The upper part of the tube must be free of traces of these substances. The tube, filled with air, is melt-sealed, and is covered along its entire length with a sheet-metal jacket; its

lower third, in a slightly inclined position, is then heated to about 600°C with a tubular electric furnace. The sheet-metal jacket provides a temperature gradient along which the product VOCl_2 sublimes out of the hot reaction zone. This procedure requires at least 4-5 days. However, the yield can be increased by longer heating time. Green needlelike crystals of VOCl_2 are deposited in the cold part of the tube. The tube is opened at a suitable spot; the product is suspended in petroleum ether, ethyl ether or CCl_4 to dissolve some adhering VOCl_3 , and then suction-filtered on a coarse fritted-glass filter. The relatively coarse filter separates the VOCl_2 crystals from traces of finely divided hydrolysis products. The VOCl_2 is freed of adhering solvent and stored under anhydrous conditions.

Alternate method: The older method of reducing VOCl_3 with Zn powder in a sealed tube is less efficient (Gmelin-Kraut, Handb. d. anorg. Chem. [Handbook of Inorg. Chem.], 7th Ed., Heidelberg, 1908, Vol. III/2, p. 120).

SYNONYM:

Vanadyl dichloride.

PROPERTIES:

Formula weight 137.86. Shiny green crystals; hygroscopic. d 2.88. Solutions of VOCl_2 in aqueous hydrochloric acid are obtained by adding VCl_4 to H_2O or by heating V_2O_5 with excess conc. HCl and evaporating most of the excess HCl . The evolution of Cl_2 brought about in this manner can be greatly facilitated by addition of weak reducing agents such as ethanol or H_2S .

REFERENCE:

H. Funk and W. Weiss. Z. anorg. allg. Chem. 295, 327 (1958).

Vanadium Oxytrichloride

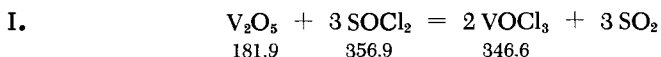

A flask connected to a reflux condenser via a ground joint is charged with 20 g. of V_2O_5 and 24 ml. of SOCl_2 (equivalent quantities) and heated for 6-8 hours on a water bath under rigorously anhydrous conditions. After rearranging the apparatus for forward distillation, the reaction product is distilled directly from the flask. This method yields pure VOCl_3 provided no excess of SOCl_2 is used.

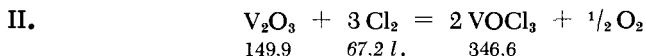

Pellets, obtained by compressing a mixture of V_2O_3 and coal powder, are heated at 500–600°C in a Cl_2 stream. The red-brown reaction product, containing VOCl_3 as well as considerable amounts of VCl_4 and Cl_2 , is repeatedly redistilled over Na metal until it is yellow. The product should not be distilled to dryness because it is likely to ignite. Rigorously anhydrous conditions are required.

Alternate method: The VCl_3 is heated in a stream of O_2 , using the apparatus described for the preparation of VCl_4 from VCl_3 and Cl_2 , p. 1259 [H. Funk and W. Weiss, Z. anorg. allg. Chem. 295, 327 (1958)].

SYNONYM:

Vanadyl trichloride.

PROPERTIES:

Formula weight 173.32. Light-yellow liquid. M.p. -79.5°C , b.p. 127°C ; vapor pressure (0°C) 4.4 mm., (80°C) 175 mm.; d (0°C) 1.85, (32°C) 1.81. Instantly hydrolyzed by H_2O ; quickly attacked even by atmospheric moisture; violent reaction with Na above 180°C . Soluble in ethanol, ethyl ether and glacial acetic acid.

REFERENCES:

- I. H. Hecht, G. Jander and H. Schlapmann. Z. anorg. Chem. 254, 255 (1947).
- II. W. Prandtl and B. Bleyer. Z. anorg. Chem. 65, 153 (1909); L. Vanino. Handb. d. präp. Chemie, Anorg. Teil [Handbook of Preparative Chemistry, Inorganic Section], 3rd Ed., Stuttgart, 1925, p. 675; F. E. Brown and F. A. Griffiths in: H. S. Booth, Inorg. Syntheses, Vol. I, New York-London, 1939, p. 106 and J. C. Bailar, Inorg. Syntheses, Vol. IV, New York-London-Toronto, 1953, p. 80; A. Morette. Comptes Rendus Hebd. Séances Acad. Sci. 202, 1846 (1936).

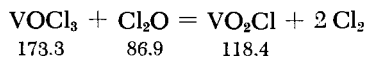
Vanadium Dioxychloride

A 250-ml., two-neck flask equipped with a large-diameter inlet tube, with all joints and stopcocks made gas-tight with Hostafion

(Farbwerke Hoechst) or Teflon grease, is purged with dry N_2 . Then pure $VOCl_3$ (100 ml.) is distilled in, and Cl_2O gas diluted with O_2 is introduced at room temperature. The Cl_2O gas mixture is obtained by passing O_2 and Cl_2 (both dried over P_2O_5) over HgO . It is advantageous to keep the HgO in a rotatable glass tube surrounded by a cooling jacket (Liebig condenser).

After a while an orange-colored, microcrystalline mass is formed, while the temperature of the reaction mixture increases slightly. The O_2 - Cl_2O feed is continued until the quantity of the crystals formed makes further feeding impossible. The material is filtered under rigorously anhydrous conditions and then vacuum-dried. The product must not be washed with CCl_4 , because this solvent slowly reacts with VO_2Cl even at room temperature, affording phosgene.

The yield, based on Cl_2O , is nearly quantitative; based on $VOCl_3$, it is not higher than 60%.

PROPERTIES:

Orange-red, microcrystalline, very hygroscopic powder. At $150^\circ C$, disproportionates into V_2O_5 and $VOCl_3$. Sparingly soluble in nonpolar solvents, moderately soluble in ethyl ether, soluble in H_2O with decomposition. d 2.29.

REFERENCE:

K. Dehnicke. Personal communications, 1960.

Lower Vanadium Oxides

V_6O_{13}

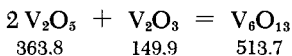

a) A stoichiometric mixture of V_2O_5 and V_2O_3 is heated for 48 hours at not less than $600^\circ C$, preferably at 750 - $800^\circ C$, in an evacuated, sealed quartz tube.

b) Or, the V_2O_5 surface is reduced in an SO_2 stream at a temperature somewhat higher than $700^\circ C$, and the unreacted V_2O_5 is extracted from the reaction product with conc. ammonia.

PROPERTIES:

Blue-black, crystalline powder. Readily soluble in conc. HNO_3 , sparingly soluble in conc. ammonia and 2 N $NaOH$. The independent

phase with a monoclinic crystal structure is stable only below about 700°C.

VO₂

Since the direct reduction of V₂O₅ does not give a well-defined product, this compound is best prepared by synthesis from V₂O₅ and V₂O₃, suggested a long time ago by Berzelius:

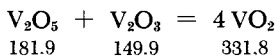

An intimate mixture of V₂O₅ and V₂O₃, in the exact proportion required by the equation, is heated for 40-60 hours at 750-800°C in a small evacuated, sealed quartz tube.

Alternate methods: The V₂O₅ is fused with an excess of crystalline oxalic acid until a greenish-blue, completely water-soluble mass of vanadyl oxalate is obtained. This mass is then calcined to complete decomposition in the absence of air. The VO₂ is obtained as the residue.

PROPERTIES:

Blue-black powder. M.p. 1650°C; d 4.34. Deformed C 4 (rutile) type crystal structure.

V_nO_{2n-1}

According to G. Anderson, several lower vanadium oxides have very similar compositions which are intermediate between those of VO₂ and of V₂O₃ and correspond to the formula V_nO_{2n-1} (where n = 3, 4, 5, 6, 7 or 8). These oxides have very narrow regions of homogeneity and are obtained by vacuum heating corresponding mixtures of V₂O₅, V₂O₃ and V for 2-20 days at 650-1000°C.

V₂O₃

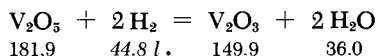

The V₂O₅ is reduced in a stream of very pure H₂ in two steps: first, for 2 hours at 600°C (the 658°C m.p. of V₂O₅ should not be exceeded), then for 6 additional hours at 900-1000°C.

For information on the formation of V₂O₃ single crystals, see H. Hahn and C. de Laurent, *Angew. Chem.* **68**, 523 (1956).

PROPERTIES:

Dull, black powder. M.p. 1970°C; d 4.87. Crystal structure: alumina type.

VO

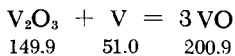

Synthesized from V_2O_3 and V metal powder under vacuum or Ar. The reactants are kept in Al_2O_3 crucibles which, in turn, are inserted into small, evacuated quartz tubes. Or, the apparatus described by Ehrlich for the preparation of TiO (p. 1214) may be used. The optimum reaction temperatures lie between 1200 and 1600°C. A product of greater uniformity is obtained by occasionally interrupting the heating and repulverizing the material. A reaction time of the order of 24 hours at 1200-1300°C is needed, whereas 1 hour is sufficient at 1600°C.

Alternate method: Electrolysis of phosphate melts containing dissolved V_2O_5 [H. Hartmann and W. Mässing, Z. anorg. allg. Chem. 266, 98 (1951)].

PROPERTIES:

Gray powder. The region of homogeneity is $\text{VO}_{0.75}\text{-VO}_{1.20}$. Crystal structure: B 1 (NaCl) type.

REFERENCES:

- H. Fendius. Thesis, Univ. of Hannover, 1930; W. Klemm and L. Grimm. Z. anorg. allg. Chem. 226, 359 (1936); W. Klemm and E. Hoschek. Z. anorg. allg. Chem. 242, 63 (1939); W. Klemm and L. Grimm. Z. anorg. allg. Chem. 250, 42 (1942); W. Klemm and P. Pirscher. Optik 3, 75 (1948); F. Aebi, Helv. Chim. Acta 31, 8 (1948); S. S. Todd and K. R. Bonnickson. J. Amer. Chem. Soc. 73, 3894 (1951); M. Frandsen. J. Amer. Chem. Soc. 74, 5046 (1952); N. Schönberg. Acta Chem. Scand. 8, 221 (1954); G. Anderson. Acta Chem. Scand. 8, 1509 (1954).

Vanadium (III) Hydroxide



A neutral Na_3VO_4 solution is reduced electrolytically at a mercury cathode.

A) PREPARATION OF THE VANADATE SOLUTION

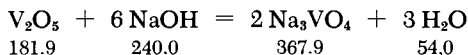

Concentrated NaOH is prepared from equal weights of NaOH and H₂O, and the solution is filtered in the absence of CO₂ to remove the Na₂CO₃ contaminant. The strength of the solution is then determined by analysis. The amount of V₂O₅ required by the above equation is then dissolved in this solution, and 1 M Na₃VO₄ is prepared by dilution with water.

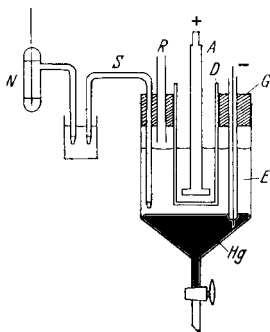

Fig. 302. Preparation of vanadium (III) hydroxide. A) carbon anode; D) clay diaphragm; E) electrolyte solution; C) rubber stopper; N) standard cell; R) N₂ inlet tube; S) electrolyte bridge.

B) ELECTROLYSIS

An electrolysis cell of the type shown in Fig. 302 is filled with very pure Hg and the Na₃VO₄ solution. The cell is closed off with rubber stopper C, and the anode space within the clay diaphragm D is filled with 1 M Na₂SO₄ solution. Very pure N₂ is bubbled (via inlet tube R) through the electrolyte solution for the first 15 minutes, and is passed over the liquid surface for the remainder of the electrolysis. Electrolysis is carried out with a current of 0.1 amp. at a cathode potential of -1.70 v. (checked by means of the standard cell N). Brown-green V(OH)₃ precipitates, and the electrolyte assumes a brown-red color. The electrolysis is discontinued after 5-10 hours, and V(OH)₃ isolated in the absence of air. This is accomplished by first draining the Hg through the stopcock, then suction-filtering the V(OH)₃ suspension under a N₂ atmosphere and thoroughly washing the precipitate with deaerated H₂O. Finally the V(OH)₃ is dried in high vacuum.

PROPERTIES:

Formula weight 101.97. Brass-colored, crystalline; readily oxidized by O₂.

REFERENCE:

N. Konopik and A. Neckel. *Monatsh. Chem.* **88**, 917 (1957).

Vanadium (V) Oxide



Highest grade V_2O_5 is obtained by calcining NH_4VO_3 at 500-550°C. Traces of N usually contaminating the product thus obtained can be virtually eliminated by heating for 18 hours at 530-570°C in a moist O_2 stream.

PROPERTIES:

Formula weight 181.9. Red to orange-yellow powder. M.p. 674°C. Slightly soluble in water: 0.07 g./100 g. H_2O ; d 3.36. Readily soluble in alkali hydroxide solutions, acids and ethanol. Crystal structure: orthorhombic.

Supported V_2O_5 (V_2O_5 catalysts)

I. ON ASBESTOS

A solution of 5 g. of NH_4VO_3 in 100 ml. of boiling H_2O is reduced with NH_4HSO_3 and treated with sulfuric acid until the solution turns a pure blue-violet. Asbestos (20 g.) is added; the mixture is allowed to boil for 10-15 minutes and is then cooled to 40-50°C; it is then rendered strongly alkaline by addition of conc. NH_3 , whereby the $\text{V}(\text{OH})_3$ precipitates onto the asbestos. The latter is dried and again treated with unreduced NH_4VO_3 , whereupon the asbestos and the flask wall become violet-blue. The asbestos mass is then pulled apart into small clumps, dried and calcined at 500-600°C; its V_2O_5 content may be as high as 50%.

II. ON CERAMIC MATERIALS

To produce a homogeneous deposit of V_2O_5 on ceramic materials (e.g., firebrick), 2-3 equivalents of a mineral acid is added to a NH_4VO_3 solution. The resulting dark-yellow solution, which contains colloidal $\text{V}_2\text{O}_5 \cdot \text{aq.}$, is boiled in the presence of the ceramic material (heating on the water bath is insufficient), thereby causing precipitation onto the carrier of a yellow-red, strongly adhering layer of V_2O_5 . Glass (not porcelain) reaction vessels should be used in this process.

REFERENCES:

N. Yefremov and A. Rozenberg. *Khim. Prom.* **4**, 129; *Chem. Zentr.* **1927**, II, 1994; I. Adadurov and G. Boreskov. *Khim. Prom.* **6**, 732; *Chem. Zentr.* **1929**, II, 2926.

Colloidal V_2O_5

I. METHOD OF BILTZ

a) A mortar is used to grind 1 g. of NH_4VO_3 with some H_2O , and 10 ml. of 2 N HCl is added while stirring with the pestle. The red precipitate formed and the supernatant are transferred onto a filter, the liquid is filtered off, and the solid is washed with H_2O . After a while, the initially clear filtrate becomes reddish and turbid. The precipitate is then transferred from the filter to an Erlenmeyer flask (using water from a wash bottle), and the volume is adjusted to 100 ml. The quantities of material used may be increased up to 200-fold, provided the proportions are kept the same. After a few hours the conversion of the precipitate to a clear orange-red V_2O_5 sol is complete. Fibrillar birefringence becomes evident only after prolonged standing.

b) In the modification of Humphry, 0.5 g. of NH_4VO_3 and 2 ml. of nitric acid (1 vol. of conc. HNO_3 + 10 vol. of H_2O) are ground together and then an additional 2 ml. of HNO_3 is added. The mixture is filtered, and the V_2O_5 formed is washed until it starts passing through the filter; it is then shaken with 200 ml. of H_2O and allowed to stand for 14 days.

PROPERTIES:

Because of the fibrillar structure of the particles, the sol exhibits strong streaming birefringence and on aging shows an increase in fibril length. Part of the V_2O_5 is always molecularly dissolved, in an amount increasing symbatically with the total concentration. The sol absorbs electrolytes strongly, and always contains some vanadium (IV).

II. METHOD OF PRANDTL AND HESS: SAPONIFICATION OF TERT-BUTYL ORTHOVANADATE

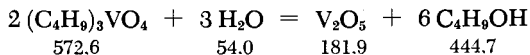

a) *tert*-Butyl alcohol and V_2O_5 are refluxed for several hours, affording a light-yellow solution of *tert*-butyl orthovanadate containing 5.3 g. of V_2O_5 per 100 g. The solution is filtered and subjected to fractional vacuum distillation in an Anshütz flask. This ester is sometimes repurified by a second vacuum distillation. Ester properties: b.p. 117°C (15 mm.), 132°C (32 mm.); m.p. 45-47°C.

b) H_2O is added to the ester; this produces a very loose (swollen) orange-colored precipitate. On boiling with a large quantity of H_2O , a clear, colloidal V_2O_5 solution is obtained. The alcohol (b.p. 82°C) is completely eliminated by the boiling.

PROPERTIES:

Electrolyte-free, virtually monodisperse sol; does not age appreciably.

Alternate methods: a) Pouring molten V_2O_5 into H_2O gives a fairly polydisperse sol, which is electrolyte-free and undergoes little or no aging [E. Müller, *Kolloid-Z.* **8**, 302 (1911)].

b) Dissolving V_2O_5 in dilute H_2O_2 and boiling the solution affords a strongly polydisperse sol, which is electrolyte-free and does not age appreciably [W. Ostermann, *Jahrb. d. philos. Fak. Göttingen II*, 265 (1921)].

REFERENCES:

General: H. Gessner. *Kolloid-Beih.* **19**, 213 (1924).

- I. W. Biltz, *Ber. dtsch. chem. Ges.* **37**, 1095 (1904); E. Sauer. *Kolloidchem. Praktikum [Lab. Manual of Colloid Chemistry]*, Berlin, 1935; R. H. Humphry. *Proc. Phys. Soc. (London)* **35**, 217 (1923).
- II. W. Prandtl and L. Hess. *Z. anorg. allg. Chem.* **82**, 102 (1913).

Ammonium Metavanadate

Ammonium metavanadate is a common commercial product, but its purity usually leaves something to be desired. Since it is easily prepared from V_2O_5 (see method II) and in turn readily yields V_2O_5 on calcination, it plays an important role in the preparation and purification of vanadium compounds. Only the purification of NH_4VO_3 is treated here.

I. A saturated NH_4VO_3 solution is prepared in boiling, weakly ammoniacal H_2O . About 500 ml. of H_2O is required for 25 g. of NH_4VO_3 but, to avoid excessive hydrolysis, it is better to use more water than to prolong the boiling. The solution is filtered hot through a fine-pore fritted glass filter, 10% of its weight of solid NH_4Cl is added to the filtrate, and the mixture is cooled to $0^\circ C$. The precipitating NH_4VO_3 is allowed to stand at $0^\circ C$ (1 hour); it is then suction-filtered and washed with a small amount of ice-cold, ammoniacal H_2O and finally with some ice-cold pure water.

If necessary, this recrystallization may be repeated several times. Complete removal of alkali ions and traces of $V_2O_5 \cdot xH_2O$ (formed on slight hydrolysis) is extremely difficult.

II. If a smaller volume of liquid is desired, V_2O_5 is dissolved in Na_2CO_3 as $NaVO_3$, and NH_4VO_3 is precipitated from this solution by addition of NH_4Cl .

Thus 25 g. of V_2O_5 is added, in small portions and with stirring, to a boiling solution of 17.5 g. of anhydrous Na_2CO_3 in 125 ml. of H_2O . After the CO_2 evolution has subsided, saturated $KMnO_4$

solution is added to the reaction mixture in an amount just sufficient to discharge the green-blue color stemming from partial reduction of the vanadium. Undissolved V_2O_5 and MnO_2 are carefully suction-filtered on a fine-pore fritted glass filter until the filtrate is completely clear. The residue is washed with H_2O until H_2O_2 no longer gives a positive reaction for vanadium. The filtrate, which amounts to about 125-150 ml., is heated to $60^\circ C$ and then poured all at once into a hot solution of 75 g. of NH_4Cl in 125 ml. of H_2O . Precipitation of NH_4VO_3 starts immediately and is complete after a few hours. Some of the salt adheres fairly tenaciously to the glass walls. The salt is suction-filtered and washed with small portions of H_2O until the washings are free of chloride ion. It is then dried in air at a temperature below $40^\circ C$. An almost pure-white salt, still containing some Na (about 0.3% NaCl) is obtained in 80% yield.

The NH_4VO_3 can be recrystallized under similar conditions. For example, 25 g. of the salt is dissolved in a solution of 16 g. of Na_2CO_3 in 125 ml. of H_2O with mild heating (to $30-40^\circ C$). The mixture is then carefully filtered and precipitated at once with NH_4Cl as described above.

PROPERTIES:

White, crystalline salt, often yellowish due to slight traces of V_2O_5 . Solubility: ($15^\circ C$) 0.52 g., ($32^\circ C$) 1.0 g., ($50^\circ C$) 1.6 g. per 100 g. of H_2O . d 2.33. Liberates NH_3 above $50^\circ C$. Readily converted to V_2O_5 when heated dry.

REFERENCES:

- I. L. Vanino. Handb. d. präp. Chem., Anorg. Teil [Handbook of Preparative Chemistry, Inorg. Part], 3rd Ed., Stuttgart, 1925, p. 672; M. Lachartre. Bull. Soc. Chim. France [4] 35, 321 (1924).
- II. R. H. Baker, H. Zimmermann and R. N. Maxson in: L. F. Audrieth, Inorg. Syntheses, Vol. III, New York-Toronto-London, 1950, p. 117; experimental data and personal communications from several laboratories.

Alkali Vanadates

Among the alkali vanadates, only $NaVO_3$ is commercially available. However, the number of existing defined alkali vanadates is rather large. Only the system $K_2O-V_2O_5$ has been subjected to a systematic preparative study. It may be assumed that the other systems have similar structures.

A stoichiometric mixture of K_2CO_3 and V_2O_5 (for example, a total of 5-6 g.) is heated in an open crucible. The crucible material

is Pt or, if the mixtures are rich in alkali, an 80% Au-20% Pd alloy. The temperature should not be increased at a rate faster than 10°C/min., in order to prevent a too vigorous reaction which would result in loss by spattering. At low alkali contents, the maximum required temperature is about 500°C, while 1000°C is needed when the alkali content is high. Several hours (8-24) of heating are required at these temperatures. The product is cooled to below 350°C in a desiccator to prevent moisture absorption. The preparation must be modified somewhat, depending on raw material composition (see the original literature).

The phase diagram of the $K_2O-V_2O_5$ system shows the existence of the following potassium vanadates: $K_2O \cdot 4 V_2O_5$ (m.p. 520°C, incongruent); $K_2O \cdot V_2O_5$ (m.p. 520°C); $16 K_2O \cdot 9 V_2O_5$ (m.p. 696°C, incongruent); $2 K_2O \cdot V_2O_5$ (m.p. 910°C); $3 K_2O \cdot V_2O_5$ (m.p. ~ 1300°C).

REFERENCE:

F. Holtzberg, A. Reisman, M. Berry and M. Berkenblit. J. Amer. Chem. Soc. 78, 1536 (1956).

Vanadium Sulfides

All vanadium sulfides can be synthesized from the elements. An intimate mixture of the finely pulverized components, in the proper proportions, is placed in sintered clay tubular crucibles; these are inserted in quartz tubes, which are then evacuated and melt-sealed. The tubes are then slowly heated and finally maintained for a long time at a maximum temperature of 1000-1300°C. Contact between the vanadium metal and the quartz must definitely be avoided.

This procedure yields V_3S , VS and V_2S_3 .

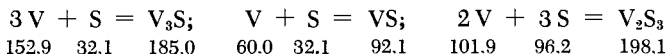

All the sulfides, as phases of the V-S system, have more or less wide regions of homogeneity.

Other preparative methods can also be used to obtain particular sulfide phases.

VS

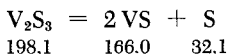

Thermal decomposition of V_2S_3 at 1000°C in a H_2 stream yields a product of composition $VS_{1.02}$ in 20 hours.

Pure VS can also be prepared by prolonged calcination of V_2O_5 in a stream of H_2S .

PROPERTIES:

VS exists, as a phase of the V-S system, between $VS_{1.00}$ and $VS_{1.16}$ and 4.51. It has a B8 (NiAs) type crystal structure with voids.

V_2S_3

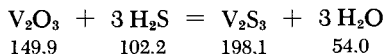

A thin layer of about 0.5 g. of V_2O_3 is spread in a porcelain boat, which is then inserted into a suitable tube and heated for 10 hours at $750^\circ C$ in a moderately fast H_2S stream, predried over silica gel. At the end of this heating period, the tube is cooled in an H_2S stream and the V_2S_3 removed from the boat. A uniform and thin layer of V_2O_3 is essential to achieve a reasonable reaction time. Under the same conditions, 2-3 g. of V_2O_3 requires 2 days for complete conversion to the sulfide. Increasing the temperature to $850^\circ C$ reduces the reaction time to a few hours, but the end product contains somewhat less S than required by the formula V_2S_3 (e.g., $VS_{1.47}$).

In addition, V_2O_5 can also be used as the starting material, by heating it at $700^\circ C$ in a stream of CS_2 vapor. For data concerning the formation of V_2S_3 single crystals, see H. Hahn and C. de Laurent, *Angew. Chem.* **68**, 523 (1956).

PROPERTIES:

Homogeneous between $VS_{1.17}$ and $V_{1.53}$. Dark-gray powder. Quite resistant to dil. acids; in contrast to VS_4 , insoluble in dilute sodium hydroxide. d 3.7.

VS_4

A mixture of V_2S_3 and excess S, corresponding to the approximate formula $VS_{2.0}$, is heated for 15 hours at $400^\circ C$ in a sealed tube, followed by a 12-hour annealing period at $90^\circ C$ (to convert the excess S into the soluble α -form). The reaction product is then exhaustively extracted in a Soxhlet apparatus, with the VS_4 remaining as the residue. Extending the heating period (to several months) affords larger crystals.

PROPERTIES:

Formula weight 179.19. Black powder. Composition sometimes does not correspond exactly to the formula. Unstable above 500°C, decomposing into V_2S_3 and S. Quite resistant to dilute acids; readily and completely soluble in sodium hydroxide, yielding a red solution. $VS_{3.65}$: d 2.8.

REFERENCES (all sulfides):

- W. Biltz and A. Köcher. Z. anorg. allg. Chem. 241, 324 (1939); E. Hoschek and W. Klemm. Z. anorg. allg. Chem. 242, 49 (1939); W. Klemm and E. Hoschek. Z. anorg. allg. Chem. 226, 362 (1936); B. Pedersen and F. Grønvold. Acta Crystallogr. 12, 1022 (1959); B. Pedersen. Acta Chem. Scand. 13, 1050 (1959); G. M. Loginov. Zh. Neorg. Khimii 5, 221 (1960).

Vanadium Selenides

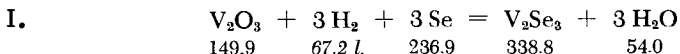

About 0.5 g. of V_2O_3 , which during its preparation has been heated not higher than 500–600°C so that is an active product capable of fast reaction, is placed in a small porcelain boat, which is inserted into a quartz tube. A larger boat containing Se is placed ahead of the one containing V_2O_3 , and a stream of very pure H_2 is passed through the tube. The V_2O_3 zone is first heated to 600°C, and then gradually to 900°C, using a small tubular electric furnace; simultaneously, the Se is vaporized by heating with a gas burner. The section of the quartz tube extending beyond the furnace is cooled with a cooling coil. After passing over the reaction product, most of the Se condenses in this section. After the reaction, the tube is allowed to cool and the product is repulverized; the selenation is repeated twice.

The composition of the products thus obtained varies markedly: when prepared at 800°C, the end product is $\sim VSe_{1.9}$, at 1000°C $\sim VSe_{1.4}$.

II. Heating the above products with a suitable excess of Se in a short sealed quartz tube at a temperature which, depending on the Se content, should be between 600 and 800°C affords products with a higher Se content.

III. Thermal degradation of the products of the first selenation, by heating in a high vacuum at 1000–1100°C for several days, affords $VSe_{1.0}$.

PROPERTIES:

The V-Se system has 3 stable phases with very broad homogeneity regions.

α -Phase (VSe), from $VSe_{1.0}$ to $VSe_{1.25}$. Dull-gray powder. d 5.94. B8 (NiAs) type crystal structure, with voids.

β -Phase (V_2Se_3), from $VSe_{1.25}$ to $VSe_{1.60}$. Gray powder with metallic luster. d 5.87.

γ -Phase (VSe_2), from $VSe_{1.62}$ to $VSe_{1.97}$. Gray, small, leaf-like crystals with metallic luster. d 5.79. Crystal structure: C6 (CdI₂) type.

REFERENCE:

E. Hoschek and W. Klemm. Z. anorg. allg. Chem. 242, 49 (1939).

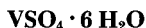
Vanadium (II) Sulfate

Produced by electrolytic reduction of $VOSO_4$, followed by ethanol precipitation of $VOSO_4 \cdot 6 H_2O$ from the resulting vanadium (II) solution.

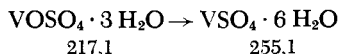

A) ELECTROLYTIC REDUCTION

The electrolysis vessel consists of a glass cylinder, 5 cm. in diameter and 10 cm. high, such as, for example, a small Pyrex pressure vessel. This vessel is closed with a five-hole rubber stopper to accommodate the cathode stem, thermometer, diaphragm, and N_2 inlet and outlet tubes. A suitable outlet tube is a small fermentation tube, which serves as protection against air and should, if possible, be drawn out into an outward-pointing capillary.

The cathode is made by bending a lead strip ($3 \times 25 \times 80$ mm.) into a cylinder so that it encloses the diaphragm. A hole is then drilled near one end of the Pb strip, and a lead rod (serving as a bus bar) is attached to it by hammering in place. The anode also consists of a lead rod, which can be prepared by pouring molten Pb into a glass tube, while cautiously fanning the latter with a flame, and then cooling and breaking the tube. Prior to electrolytic reduction, the cathode is pretreated, according to the method of Tafel, by using the cathode as an anode in $2N H_2SO_4$ until it is uniformly coated with brown PbO_2 . The diaphragm consists of a glass tube, about 16 cm. long and 2 cm. I.D., with a fine fritted-glass disk sealed to its lower end.

A 2M VOSO_4 solution, which is also 2N in H_2SO_4 , is prepared by dissolving 66 g. of $\text{VOSO}_4 \cdot 3 \text{H}_2\text{O}$ (for preparation, see p. 1285) in H_2O , adding 8.5 ml. (15 g.) of conc. H_2SO_4 , and diluting to 150 ml. with H_2O .

The diaphragm is filled with 6N H_2SO_4 to the level of the VOSO_4 solution in the cathode space. This is best done by pouring both solutions in at the same time. Electrolysis is started at 0.3 amp. and about 5 v. Cooling is unnecessary, since the temperature does not exceed 30°C . If the current should exceed 0.3 amp. during the first few hours, it must be readjusted to this value. During the intermediate reduction period, the current drops to 0.2 amp., while the voltage increases. The current should, however, not be raised to 0.3 amp. During reduction, the dark-blue VOSO_4 solution first turns dark blue-green, then later dark and opaque. In the final reduction period the current again rises while the voltage drops. Reduction is complete when the solution is red-violet. Reduction time: 55-60 hours. During electrolysis, a slow stream of O_2 -free N_2 or CO_2 is passed through the electrolyte at the cathode.

If only the reduced vanadium (II) solution is needed and precipitation of crystalline VSO_4 is not desired, the electrolyte solution can be protected from atmospheric O_2 in a simpler fashion, by covering it with a xylene layer about 2 cm. deep.

If desired, the electrolysis may be continued at 0.01-0.02 amp. and 3 v. for several months; a completely reduced VSO_4 solution is thus always available for use. To remove solution as needed, the gas outlet tube is pulled out of the rubber stopper and a pipette inserted in its place. Virtually no oxidation takes place if the VSO_4 solution aspirated into the pipette is immediately allowed to run out into another vessel under an inert gas blanket.

A low current density is necessary in order to obtain a relatively concentrated VSO_4 solution with a minimum H_2SO_4 content, as required for the precipitation with ethanol described below.

B) PRECIPITATION WITH ABSOLUTE ETHANOL

The glass apparatus shown in Fig. 303 is suitable for the isolation of crystalline VSO_4 . Its main section is adapter *k*, bent at an angle of about 100° . The ends of *k* are connected via standard taper joints to the other parts of the apparatus. The joints are lightly lubricated with stopcock grease. The entire apparatus is fastened to a cross-shaped supporting rack of iron bars by means of two common clamps (not shown in the drawing), one holding the neck of the round-bottom flask *p* and the other the receiver *m*. The rack can be rotated, with moderate resistance, about its axis (which is perpendicular to the plane of the drawing).

The gas inlet tube *e* is connected via a pressure hose to a two-way stopcock which connects the system either to an oil-type

vacuum pump or to a source of pure, P_2O_5 -dried N_2 . The N_2 must be very pure; it is pressurized to 0.2 atm. gauge by means of a Hg or H_2O leveling device (2-m. water column), and then introduced into the apparatus. A two-liter flask, serving as a N_2 surge vessel, is inserted between the N_2 purifier and the P_2O_5 drying train.

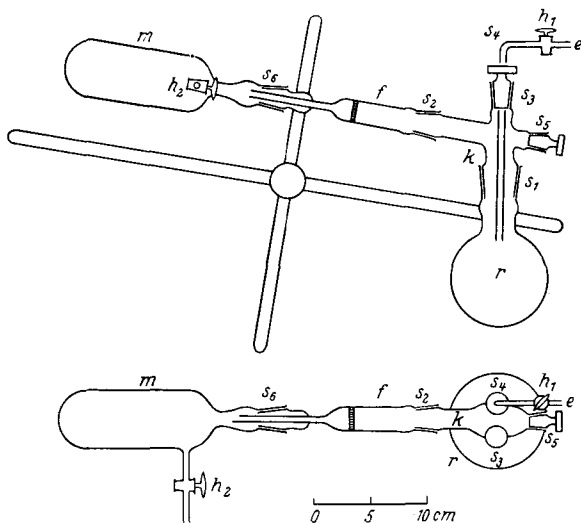

Fig. 303. Preparation of vanadium (II) sulfate. *k*) bent adapter; s_1) 29/26 joint; s_2) 24/25 joint; s_3 and s_4) 12/18 joints; *e*) gas inlet tube with stopcock h_1 ; *r*) 250-ml. round-bottom flask; *f*) tubular adapter with fritted-glass disk; *m*) receiver; h_1 and h_2) stopcocks.

The apparatus is completely purged of air by alternate evacuation and flushing with nitrogen. Then 20 ml. of 2 M VSO_4 solution is removed from the electrolysis vessel with a pipette, the stopper s_3 is removed, the pipette is immediately inserted through this opening until it almost touches the bottom of flask *r*, and the solution is allowed to flow out. With stopcock h_1 open, the filling operation is carried out in a countercurrent nitrogen stream.

In the same manner 40 ml. of absolute ethanol, previously deaerated by boiling while passing through pure dry nitrogen, is added to flask *r*. Stopper s_3 is immediately closed, and the entire apparatus vigorously shaken for 5 minutes by a back-and-forth movement of the cross arm. Solid, granular $VSO_4 \cdot 6 H_2O$ begins to precipitate within a few seconds. Stopcock h_2 is now connected

via a rubber hose to a wash bottle containing some water and also serving as a bubble counter and liquid seal. With stopcocks h_1 and h_2 open, the pale-purple mother liquor is decanted by carefully tilting the cross arm. The salt precipitate in r is washed by vigorous shaking with the liquid quantities indicated below and decanting the used liquid before each new addition. The wash liquid is introduced, as indicated above in the case of the VSO_4 solution, in a countercurrent N_2 stream by means of a pipette inserted through s_3 . The wash liquids are introduced in the following order: 2×15 ml. of deaerated absolute ethanol; 25 ml. of the same ethanol plus 10 ml. of absolute ether; 10 ml. of ethanol plus 25 ml. of ether; 5 ml. of ethanol plus 15 ml. of ether; 3 ml. of ethanol plus 25 ml. of ether. Finally the salt is transferred onto the fritted-glass filter f with an additional 25 ml. of absolute ethyl ether. The ether adhering to the substance is removed by continuing the N_2 purge stream (about one hour). Flask m is replaced with the N_2 -filled drying vessel t shown in Fig. 304 while continuing the N_2 stream via h_3 . Vessel t is charged to one third of its capacity with a P_2O_5 -pumice drying mixture, and any oxygen present in the latter is removed by alternate evacuation and purging with N_2 . Then the drying vessel and the tube f are detached from adapter k at joint s_2 , f is immediately closed off with a ground stopper, and the system is connected to the oil vacuum pump by way of h_3 (resetting the two-way stopcock). After evacuation, stopcock h_3 is closed and the drying vessel with the product is allowed to stand for 5 days at 25°C (drying can also be accomplished, without the P_2O_5 -pumice mixture, by immersing the evacuated drying vessel in liquid nitrogen). The light red-violet product is stored in container n , shown in Fig. 304, which provides protection from oxygen and enables one to remove the product when desired. To transfer the product to n , the latter is evacuated, then filled with N_2 ; the drying vessel is also filled with N_2 through h_3 , the glass stopper is removed from f , and the storage container n (which carries a male joint), from which the two-joint adapter and bent tube p have just been removed, is inserted in its place. During this operation, the N_2 stream is introduced via stopcock h_4 of the storage container, as well as via h_3 . The substance is transferred to n from the fritted-glass tube f by turning the tube upside down. The storage container is then detached from the tube and closed off with the two-joint adapter and bent tube p . To remove any O_2 entrained during the transfer, container n is immediately evacuated and filled with N_2 ; these two operations are then repeated twice. Approximately 10 g. of $\text{VSO}_4 \cdot 6 \text{H}_2\text{O}$ is obtained (90% yield, based on the 20 ml. of 2 M VSO_4 solution used).

Short exposure of the product to air does not affect its storage stability provided the last traces of O_2 are removed by repeated

purging of the system with N_2 . The product is stable for several months, even if frequently sampled.

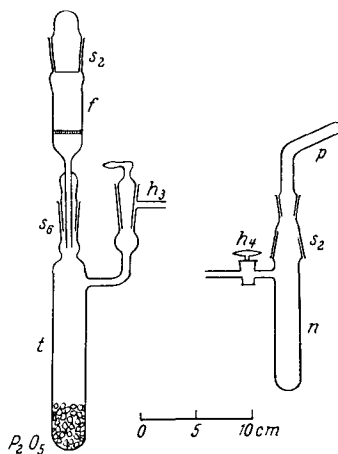

Fig. 304. Drying tube and storage container for vanadium (II) sulfate. *f*) fritted-glass tube as in Fig. 303; *t*) drying tube containing the P_2O_5 -pumice mixture; *n*) storage tube *p*) bent tube for filling operations involving small amounts of substance; s_2 and s_6) standard taper joints, as in Fig. 303.

To remove some product from the storage container, the estimated amount is transferred to the bent tube *p* by inclining and tapping *n* (Fig. 304). Nitrogen is introduced via h_4 , and tube *p* containing the product is quickly replaced by an identical empty tube. The closed-off storage container is then evacuated twice and filled with N_2 ; at the same time, the open, previously tared bent tube *p* containing the $VSO_4 \cdot 6 H_2O$ is quickly weighed (to ascertain the weight of sample in it), and is then quickly connected to the N_2 -filled apparatus (Fig. 303) by inserting its male joint into joint s_3 . By quickly turning the cross arm, the salt is poured from the bent tube *p* into the flask *r*, whereupon the system (of Fig. 303) is reevacuated via h_1 and refilled with N_2 . The $VSO_4 \cdot 6 H_2O$ can then again be dissolved in O_2 -free H_2O , added from a pipette in a countercurrent stream of N_2 . In this manner, an H_2SO_4 -free solution of VSO_4 is obtained; this can be used to prepare other vanadium (II) compounds in the same apparatus while retaining the certainty that air is completely absent.

Alternate method: A solution of VO in H_2SO_4 is prepared in the absence of air, and is then evaporated in vacuum [C. M. French and J. P. Howard, Trans. Faraday Soc. 52, 712 (1956)].

PROPERTIES:

Light red-violet, fine crystalline powder, oxidized to brown even in dry air. Readily soluble in deaerated H_2O , yielding a red-violet solution.

A heptahydrate $VSO_4 \cdot 7 H_2O$ may also be formed under other conditions.

REFERENCES:

- J. Dehnert. Thesis, Univ. of Jena, 1952 S. Herzog. Z. anorg. allg. Chem. 294, 155 (1958); L. Malatesta. Gazz. Chim. Ital. 71, 615 (1941); J. Meyer and M. Aulich. Z. anorg. allg. Chem. 194, 278 (1930); A. Piccini and L. Marino. Z. anorg. Chem. 50, 49 (1906).

Hydrogen Disulfatovanadate (III)

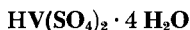

A paste obtained by stirring 10 g. of V_2O_5 and 36 g. of conc. H_2SO_4 is heated for a while on a water bath and allowed to stand until the next day. The mixture is then treated with 80 ml. of H_2O and reduced on the water bath by bubbling through it a stream of SO_2 . Reduction to $VOSO_4$ is complete in a few minutes. Excess SO_2 is boiled off and the product electrolytically reduced to the trivalent state, using the apparatus described for ammonium vanadium (III) alum (p. 1284). The resulting green solution is filtered on a fine-pore fritted-glass disk and allowed to stand in a vacuum desiccator over H_2SO_4 . After a few days, a green crystalline powder separates out; it is stirred with a large quantity of ethanol, suction-filtered and then thoroughly washed with ethanol. The product is dried over H_2SO_4 in a CO_2 -filled desiccator.

SYNONYM:

Disulfatovanadic (III) acid.

PROPERTIES:

Formula weight 316.14. Green crystalline powder; can be stored for extended periods of time in closed bottles even in the presence of air.

Other compounds: The above procedure yields $NH_4V(SO_4)_2 \cdot 4 H_2O$ when 12 g. of NH_4VO_3 is used in place of 10 g. of V_2O_5 .

The hexahydrate, $HV(SO_4)_2 \cdot 6 H_2O$, is formed if 150 g. of H_2SO_4 is used; the salt $NH_4V(SO_4)_2 \cdot 6 H_2O$ results when NH_4VO_3 is reacted with the stoichiometric amount of H_2SO_4 .

Sulfates of trivalent vanadium can be obtained using hydrazine as the reducing agent and glacial acetic acid as the reaction medium. An intermediate, $V(\text{CH}_3\text{COO})_3$, is formed under these conditions. Hydrates of $V_2(\text{SO}_4)_3$, for example, $V_2(\text{SO}_4)_3 \cdot 9 \text{H}_2\text{O}$, can be prepared in this manner.

The anhydrous compounds $\text{HV}(\text{SO}_4)_2$ and $V_2(\text{SO}_4)_3$ can be prepared by using conc. H_2SO_4 , or by thermal dehydration. See Meyer and Markowicz.

REFERENCES:

- J. Meyer and E. Markowicz. *Z. anorg. allg. Chem.* **157**, 211 (1926); J. T. Brierley. *J. Chem. Soc.* **49**, 823 (1886); A. Stähler and H. Wirthwein. *Ber. dtsh. chem. Ges.* **38**, 3970 (1905); J. Dehnert. Personal communication, 1951.

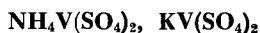
Ammonium and Potassium Disulfatovanadate (III) **$\text{NH}_4\text{V}(\text{SO}_4)_2$**

A paste prepared by stirring 12 g. of NH_4VO_3 with some H_2O is slowly added to 300 ml. of 2 N H_2SO_4 . The resulting pure yellow solution is mixed with 200 ml. of saturated SO_2 solution and 40 g. of $(\text{NH}_4)_2\text{SO}_4$. The blue solution obtained is evaporated, first on a water bath, then over an open flame, until a blue salt begins to precipitate. Concentrated H_2SO_4 (30-50 ml.) is added and the heating, during which fumes are evolved, continued for a while. The mixture is allowed to cool overnight and is then taken up in H_2O . The residue is suction-filtered, triturated with H_2O , reboiled with H_2O , thoroughly washed, and then dried over H_2SO_4 in a vacuum desiccator. Yield: 4.7 g. of $\text{NH}_4\text{V}(\text{SO}_4)_2$.

 $\text{KV}(\text{SO}_4)_2$

The K salt is prepared similarly, by evaporating a mixture of 200 ml. of 2 N H_2SO_4 , 10 g. of vanadyl sulfate, 21.1 g. of K_2SO_4 and 10 ml. of sulfurous acid on a water bath, then adding 10 ml. of conc. H_2SO_4 and heating for a while, while fumes are evolved. After cooling, 400 ml. of H_2O is added and the mixture boiled for a short time. The green product is washed with H_2O , suction-filtered and vacuum-dried over H_2SO_4 .

PROPERTIES:

Green, crystalline powder. Insoluble in H_2O and acids; attacked and decomposed by alkali.

REFERENCES:

- A. Sievers and E. L. Müller. *Z. anorg. allg. Chem.* 173, 313 (1928); A. Rosenheim and H. Y. Mong. *Z. anorg. allg. Chem.* 148, 25 (1925); V. Auger. *Comptes Rendus Hebd. Séances Acad. Sci.* 173, 306 (1921).

 $\text{NH}_4\text{V}(\text{SO}_4)_2 \cdot 12\text{H}_2\text{O}$ (Alum)

A mixture of 25 g. of NH_4VO_3 , 180 ml. of H_2O and a g. of conc. H_2SO_4 (see below) is prepared with stirring. The hot mixture is treated with SO_2 until a clear, dark-blue VOSO_4 solution is formed. Excess SO_2 is boiled off; the mixture is evaporated to 120 ml. and filtered. A porous clay cylinder 5 cm. in diameter and 10 cm. high, serving as diaphragm, is placed in a Pt cup (12 cm. in diameter and 6 cm. high). The vanadium salt solution is poured into the annular space; then, 25 ml. of 10% H_2SO_4 and a Pt coil serving as anode are placed in the inner space, and the mixture is subjected to electrolysis for 45-50 min. at 3-4 v. and 6-7 amp. The electrolysis is continued until a pure green solution is obtained. The end-point of the reduction can be determined accurately by comparison with the color of a known vanadium (III) solution or by a control titration with KMnO_4 . The reduced solution is allowed to stand in a closed vessel. Crystallization of the alum is complete within 2-3 days the yield is 30-50%.

The H_2SO_4 quantity a used initially determines whether the red or the blue alum form will be obtained. When $a = 20$ g., pure red crystals result, whereas when $a = 40$ g., the crystals are pure blue.

PROPERTIES:

Red or blue crystals; effloresce slowly in air with loss of water and oxidation. At 40-50°C, the alum melts in its water of crystallization, affording a green mass. Solubility (20°C): 40 g./100 g. H_2O . d 1.687.

K, Rb AND Cs VANADIUM (III) ALUMS

The preparation of these compounds is similar to that of the NH_4 alum. The starting material is either V_2O_5 , which is converted to a VOSO_4 solution by treatment with H_2SO_4 and SO_2 , or a VOSO_4 compound. The stoichiometric quantity of K_2SO_4 , Rb_2SO_4 or Cs_2SO_4 is added and the mixture is then electrolytically reduced. The ease and completeness of precipitation of these alums from their green solutions increase (and their solubility decreases) in the order $\text{K} \rightarrow \text{Rb} \rightarrow \text{Cs}$.

REFERENCES:

- A. Piccini. Z. anorg. Chem. 11, 106 (1896); 13, 441 (1897); A. Bültemann. Z. Elektrochem. 10, 141 (1904); J. Meyer and E. Markowicz. Z. anorg. allg. Chem. 157, 211 (1926); H. Hartmann and H. L. Schäfer. Z. Naturforsch. 6a, 754 (1951).

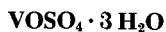
Vanadium (IV) Oxysulfate**(Vanadyl Sulfate)**

A solution of V_2O_5 in pure sulfuric acid is reduced, preferably with SO_2 (which is easier to work with than oxalic acid and ethanol because its excess may be readily removed).

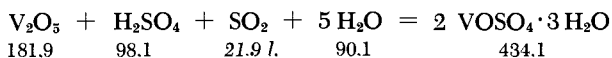

Thus a stiff paste is prepared by stirring 190 g. of mildly calcined V_2O_5 with 110 ml. of conc. H_2SO_4 and 50 ml. of H_2O ; considerable heat is evolved during this operation. On the next day, 100 ml. of H_2O is added and SO_2 introduced while heating the mixture on a water bath, until nearly all of the V_2O_5 is dissolved. The dark-blue filtered solution is concentrated on a slowly boiling water (or steam) bath until a thick crystal mass is formed; the crystals are then suction-filtered and washed acid-free with 96% ethanol. The undesirable formation of a thick, blue sirup or a hard crystal cake, mentioned in the literature, seems to be due to impurities or to reaction conditions which differ from those given here; no such inconveniences are encountered when V_2O_5 , prepared from thrice-recrystallized NH_4VO_3 , and SO_2 as the reducing agent are used according to the above procedure. The bright, light-blue crystalline powder is dried over P_2O_5 in a vacuum desiccator. Yield: 235 g. of $\text{VOSO}_4 \cdot 3\text{H}_2\text{O}$. Evaporation of the mother liquor affords another crop of less pure vanadyl sulfate.

PROPERTIES:

Sky-blue crystalline powder. Readily soluble in H_2O , sparingly in ethanol. Hygroscopic; indefinitely stable in a closed bottle provided oxygen is absent.

REFERENCES

- L. Vanino. Handb. d. präp. Chemie, Anorg. Teil [Handbook of Preparative Chemistry, Inorg. Part], 3rd ed., Stuttgart, 1925, p. 677; J. Dehnert. Thesis, Univ. of Jena, 1952, and a personal communication.

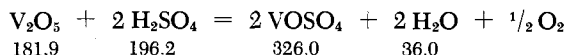
VOSO₄, anhydrous

Analytical grade conc. H₂SO₄ (100 ml.) and 3 g. of V₂O₅ are boiled for several hours in a long-neck, round-bottom flask. The product is cooled (first in air, then in ice), and poured into 500-700 ml. of H₂O. The solid is suction-filtered until dry and washed with a large quantity of water. Since the product is still heterogeneous (yellow-brown particles, in addition to green ones), it is again subjected to the same treatment and, after suction-filtration, dried with ethanol and ether, or over H₂SO₄ in a desiccator.

PROPERTIES:

Green, loose, granular to finely crystalline powder; virtually insoluble in H₂O.

REFERENCES:

- A. Sieverts and E. L. Müller. Z. anorg. allg. Chem. 173, 313 (1928); V. Auger. Comptes Rendus Hebd. Séances Acad. Sci. 173, 306 (1921).

Vanadium Nitrides

VN

I. If pure V metal is available, it is best to proceed via the syntheses:

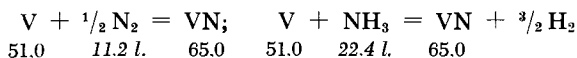

which give the purest products. Depending on the metal particle size, a reaction temperature between 900 and 1300°C is required. The starting material is placed in a boat (or crucible) made of Al₂O₃ or Mo metal (see also the preparation of TiN, p. 1233, and of NbN, p. 1328). When other preparative methods are used, particularly those employing oxygenated starting materials (as in the

method described below), the nitride product inevitably contains some oxygen.

Alternate methods:

- II. Very pure NH_4VO_3 is heated for several hours at 900-1000°C in a very dry NH_3 stream.
- III. VOCl_3 or V_2O_3 is heated in an NH_3 stream.
- IV. $\text{V}_2\text{O}_3 + 3\text{C} + \text{N}_2 = 2\text{VN} + 3\text{CO}$.
- V. Deposition from gas phase on an incandescent wire; the gas contains VCl_4 , H_2 and N_2 . (see also TiN, p. 1233).

V_2N

I. Vanadium nitride, VN, is intimately mixed with the stoichiometric quantity of V metal powder; either the loose or the compacted mixture is then heated at 1100-1400°C in an Al_2O_3 or Mo crucible under Ar.

PROPERTIES:

Dark, submetallic materials.

VN: M.p. 2050°C; d 6.04. Homogeneity region: $\text{VN}_{1.00-0.71}$. Crystal structure: B1 (NaCl) type.

V_2N : Homogeneity region: $\text{VN}_{0.50-0.37}$. Crystal structure: L 3 type.

REFERENCES:

- I, II. H. Hahn. Z. anorg. Chem. 258, 58 (1949); V. E. Epelbaum and A. Brager. Acta Physicochim. URSS 13, 595 (1940); W. D. Schnell. Thesis, Univ. of Freiburg i. Br., 1960.
- III. H. W. Roscoe. Ann. Pharm. Suppl. 6, 114 (1868); 7, 191 (1870); N. W. Whitehouse. J. Soc. Chem. Ind. 27, 738 (1907).
- IV. E. Friederich and L. Sittig. Z. anorg. allg. Chem. 143, 293 (1925).
- V. A. E. van Arkel and J. H. de Boer. Z. anorg. allg. Chem. 148, 345 (1925); K. Moers. Z. anorg. allg. Chem. 198, 243 (1931).

Vanadium Phosphides

VP_2 , VP, $\text{VP}_{<1}$

Vanadium phosphides are synthesized from the purest V metal available and P.

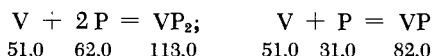

Phosphorus and vanadium, the latter contained in an Al_2O_3 crucible, are placed in a quartz tube of the type used for the "Faraday synthesis" (see p. 76 f.). The tube is thoroughly evacuated, melt-sealed and then heated for 24-48 hours in such a

way that the average temperature of the metal is 700–1000°C and that of the P is 480–550°C. To achieve homogeneous products and high P contents, the reaction must be carried out in stages, with intermediate grinding of the materials. Atmospheric oxygen must be carefully excluded during the grinding, to avoid appreciable absorption by the products.

The V-P system contains the phases VP_2 and VP, as well as several phases in which the P content is low.

In the preparation of VP_2 , an excess of P must be used from the very start because VP, once formed, reacts extremely slowly with additional phosphorus.

The vanadium phosphide VP can be obtained not only via the above synthesis, but also by thermal degradation of VP_2 at 700–900°C (vacuum).

Lower phosphides (including V_3P) are obtained by synthesis from the elements or from VP and V.

Alternate method: Electrolysis of V_2O_5 -containing phosphate melts, with cathodic reduction to vanadium phosphides [M. Chène, Comptes Rendus Hebd. Séances Acad. Sci. 208, 1144 (1939); Ann. chimie [11], 15, 272 (1941)].

PROPERTIES:

Dark-gray substances; the lower phosphides have a submetallic luster. Not attacked by dilute H_2SO_4 . Attacked by conc. H_2SO_4 the more readily, the lower the phosphorus content. Incompletely soluble in nitric acid and aqua regia. Can be analyzed after decomposition by fusion with sodium carbonate-sodium nitrate.

VP: d 4.7; $VP_{0.35}$: d 5.4.

REFERENCE:

M. Zumbusch and W. Biltz. Z. anorg. allg. Chem. 249, 1 (1942).

Vanadium Carbides

VC, V_2C

I. It is probable that pure products can be obtained only by synthesis from the elements:

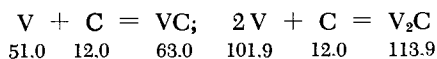

The reactants, preferably in finely subdivided form, are intimately mixed and, if needed, also compressed into pellets. The reaction is then carried out in a high vacuum. At a temperature of 1300°C, approximately 24 hours, or at 2000°C about 15 minutes, are required for homogenization of the product. The reaction is best carried out in a graphite crucible.

Alternate methods: a) The elements are combined by heating in a carbon arc [A. Morette and M. G. Urbain, *Comptes Rendus Hebd. Séances Acad. Sci.* 202, 572 (1936)].

b) Vanadium oxides are mixed with carbon and heated in a H_2 stream or in high vacuum. Carbides of an increased degree of purity are obtained if the final temperatures are allowed to reach 1700-2100°C (see the corresponding preparation of TiC, p. 1245 ff.) [C. Agte and K. Moers, *Z. anorg. allg. Chem.* 198, 233 (1931); E. Friederich and L. Sittig, *Z. anorg. allg. Chem.* 144, 169 (1925); A. Morette, *Bull. Soc. Chim. France* [5], 5, 1063 (1938); W. Dawihl and W. Rix, *Z. anorg. Chem.* 244, 191 (1940)].

c) Vapor deposition method (see TiC, p. 1246). An H_2 stream containing VCl_4 and toluene vapors is passed over an incandescent W wire [K. Moers, *Z. anorg. allg. Chem.* 198, 243 (1931)].

PROPERTIES:

Dark, very hard, chemically resistant submetallic substances. The V-C system has two phases:

VC: Homogeneity region $VC_{0.92}$ - $VC_{0.74}$; m.p. 2800°C. Crystal structure: B 1 (NaCl) type.

V_2C : Homogeneity region $VC_{0.4}$ - $VC_{0.5}$. Crystal structure: L 3 type.

REFERENCES:

- A. Osawa and M. Oya. *Sci. Rep. Tohoku Imp. Univ.* 19, 95 (1930); *Chem. Zentr.* 1930, II, 298; W. Rostoker and A. Yamamoto. *Trans. Amer. Soc. Metals* 46, 1136 (1954); N. Schönberg. *Acta Chem. Scand.* 8, 624 (1954); M. A. Gurevich and B. F. Ormont. *Zh. Neorg. Khimii* 2, 1566 (1957); W. D. Schnell. Thesis, Univ. of Freiburg i. Br., 1960.

Dibenzenevanadium (0)

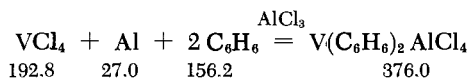

The reactor is a 250-ml., three-neck flask equipped with an agitator, a reflux condenser and a mercury safety valve. A mixture

of 10 g. (0.37 moles) of dry Al powder and 4 g. (0.03 moles) of finely subdivided AlCl_3 and 150 ml. of absolute benzene (an excess) is added. The system is purged by introducing N_2 via the reflux condenser. The flask is equipped with a pressure-equalizing dropping funnel containing a solution of 9 g. (5 ml., 0.047 moles) of freshly distilled VCl_4 in 50 ml. of benzene. The flask contents are heated to a boil while stirring under a blanket of N_2 . The VCl_4 solution is then added dropwise (slowly) over a period of one hour, and the mixture is agitated and boiled for an additional 20 hours. It assumes a golden yellow color. It is allowed to cool, and the dropping funnel, the agitator and the reflux condenser are replaced (under a N_2 stream) with stoppers and a vacuum adapter. The benzene is then removed in vacuum, with heating toward the end of the distillation. The dry residue is reduced to small pieces (in the same flask and under N_2). While protecting it from air, a part of the residue is then transferred to a 500-ml. separatory funnel kept under N_2 (which is introduced through a side tube), and covered with 200 ml. of N_2 -saturated petroleum ether. This is followed by repeated additions, with vigorous shaking, of 100-ml. portions of N_2 -saturated 1 N NaOH. After complete hydrolysis, the mixture is allowed to stand, the aqueous layer is separated, and the brown-red petroleum ether solution is washed three times (in the absence of air) with 20-ml. portions of N_2 -saturated H_2O . Hydrolysis of the remainder of the solid reaction product is carried out similarly, in 2-3 operations. The combined petroleum ether extracts are dried for 15 minutes over solid KOH and the solvent is evaporated in vacuum. The residue is sublimed at 120-150°C in high vacuum, placed in a V-shaped washing tube, washed three times with 5-10 ml. of air-free, absolute petroleum ether to remove organic impurities, and finally resublimed. Yield: 1.3-2.5 g. (13-25%, based on VCl_4).

PROPERTIES:

Formula weight 207.18. Brown-red to black crystalline substance. M.p. (in N_2) 277°C. Sublimes in high vacuum at 120-150°C, decomposes above 300°C. Instantly oxidized by air (decomposition). Soluble in benzene, ether, pyridine, petroleum ether and acetone; the solutions are brown-red and stable in the absence of air. Insoluble or only sparingly soluble in CCl_4 and methanol. Not dissolved or attacked by H_2O in the absence of O_2 , but decomposed in the presence of air.

REFERENCE:

E. O. Fischer and H. P. Kögler. Chem. Ber. 90, 250 (1957).

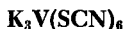
Potassium Hexathiocyanatovanadate (III)

A vanadium (III) solution is obtained from V_2O_5 by reduction of the latter with SO_2 , followed by electrolysis. This solution is then reacted with KSCN:

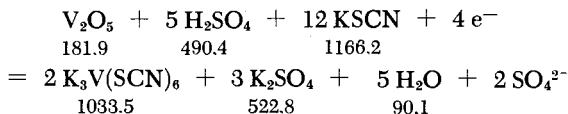

Fine V_2O_5 powder (91 g., 0.5 moles) is stirred with 250 ml. of 4 N H_2SO_4 , the suspension heated, and SO_2 introduced until a clear, pure blue solution is obtained. The mixture is heated to a boil to remove the excess SO_2 and is then concentrated to 2/3 of its previous volume.

This solution is subjected to electrolytic reduction in a cell containing a clay cylinder diaphragm; the current is 2-3 amp. at 10 v. (the procedures are those described on pp. 1277 and 1284). The electrolysis is continued until the electrolyte at the cathode shows the pure green color of vanadium (III). The best electrodes are those made of platinum sheet.

The theoretical quantity of KSCN used depends on the volume of the cathode electrolyte and is calculated on the assumption that 6 moles (or 583 g. of KSCN) corresponds to 1 g.-atom of vanadium. This quantity of KSCN, in the form of a concentrated aqueous solution, is then added to the above electrolyte. The resulting red liquid is concentrated on a water bath; the residue is dissolved in the minimum amount of ethanol and treated with ether until K_2SO_4 no longer precipitates. The K_2SO_4 is filtered off, the filtrate is evaporated on a water bath, and the precipitation operation is repeated. The residue thus obtained (it is completely free of K_2SO_4) is recrystallized from a small amount of H_2O . Well-formed crystals of the dihydrate, $\text{K}_3\text{V}(\text{SCN})_6 \cdot 2 \text{H}_2\text{O}$, are obtained.

The anhydrous salt is obtained by drying the dihydrate over H_2SO_4 in a vacuum desiccator, finely pulverizing it, and then completely dehydrating it under vacuum (drying pistol) at 95°C until constant weight is reached.

PROPERTIES:

$\text{K}_3\text{V}(\text{SCN})_6 \cdot 2 \text{H}_2\text{O}$: Formula weight 552.79. Brown-red, leaf-like crystals.

$\text{K}_3\text{V}(\text{SCN})_6$: Formula weight 516.76. Very hygroscopic.

REFERENCE:

O. Schmitz-Dumont and G. Broja. *Z. anorg. Chem.* **255**, 299 (1948).

Niobium Metal, Tantalum Metal

Because of the tendency of Nb and Ta metal to form very stable oxides, nitrides and carbides, the difficulties in the preparation of these metals are similar to those encountered in the preparation of Ti and Zr (see pp. 1161 and 1172).

Three methods are available for industrial preparation of the pure metals. The first involves electrolysis of fluoride melts containing K_2NbOF_5 (or K_2TaF_7), as well as a certain amount of the corresponding oxides, Nb_2O_5 or Ta_2O_5 . An iron fusion pot serves as the cathode and graphite rods as the anodes. The resulting metal is a fine powder which may be separated from the admixed salt melt by a variety of processes. In the second method an oxide and a carbide, for instance $Nb_2O_5 + 5 NbC$, are mixed, compressed into pellets and heated in high vacuum to temperatures exceeding $1600^\circ C$. In the third method, a double fluoride is reduced either with liquid sodium or sodium vapor. In each case, the material is processed further via powder-metallurgical methods, by subjecting it to repeated and alternating procedures which increase density and hot degassing treatments.

I. REDUCTION WITH SODIUM OR CALCIUM

The laboratory preparation of the metal powder proceeds via reduction of the halides with sodium, calcium or CaH_2 .

Thus, for example, 50 g. of high-purity, dry K_2TaF_7 and 18 g. of Na (precut into small pieces under benzene) are placed in a heavy-wall steel vessel, tightly closed off with a well-fitting conical lid, which is fastened on with screws. The system is heated for one hour at red heat, allowed to cool completely, and reopened; the reaction mixture, which still contains some free Na, is carefully introduced, in small portions and with agitation, into 500 ml. of H_2O . The lumps disintegrate, and the resulting metal powder is treated several times with H_2O , then hot nitric acid (d 1.2), strong hydrochloric acid (1:1) and, finally, again and thoroughly with water. It is then dried.

According to Kroll, the oxides can be reduced with calcium metal in the presence of $CaCl_2$ as the fluxing agent

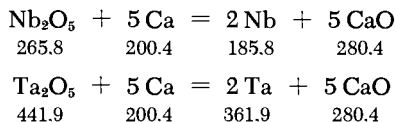

Redistilled Ca turnings of the best grade are used in approximately 30% excess. The presence of $CaCl_2$ is essential. For example, in a preparation of a small amount of metal, 8 g. of Nb_2O_5 (or 13 g. of Ta_2O_5), 8 g. of Ca and 15 g. of $CaCl_2$ are placed in a heavy-wall tubular iron crucible (25 mm. in diameter,

80 mm. long) which is filled with Ar and made gas-tight by closing it off with a welded-on (oxygen-acetylene flame) iron plug. This crucible is then heated for half and hour at about 1000-1100°C, allowed to cool completely, and sawed open. The contents are treated with water and acids, as described above. The metal powder contains some very fine particles which are best separated by decantation and discarded.

The above two methods are equally applicable to Nb and to Ta. Various modifications of these methods are possible; in particular, the reduction with Ca may be replaced by one with CaH_2 [see the corresponding procedures for Ti, methods I and II, pp. 1161-1165, as well as G. Tourné, *Ann. Chim.* [13], 4, 949 (1959)].

The metal powders thus obtained are not particularly pure and often contain not more than 97% of the metal, which is accompanied by hydrogen, some oxygen, and sometimes also small amounts of nitrogen, carbon and iron. The purity can be increased by repeating the treatment with the reducing metal or with CaH_2 and, also, by increasing the batch size. At any rate, it is of advantage to purify these powders further by heating them at a high temperature under vacuum, for example, via procedure II. However, the further conversion of Nb or Ta powder to the corresponding halides is not affected by the impurities, provided they are not metallic.

II. PURIFICATION BY CALCINATION

Low-purity Nb or Ta can be freed of most of its contaminants by heating to red heat in a vacuum. Both Nb and Ta have very high melting points, and thus the contaminants can simply be evaporated. In this procedure, the metal powder, pressed into oblong rods and clamped between water-cooled molybdenum jaws, is resistance-heated with a high current, or the loose or compressed metal powder is heated to red heat on a support of ThO_2 , W or Ta sheet, placed in a tungsten electrical heating element. The best type of heater is the furnace shown in Part I, p. 40 f., wherein a tungsten tube or a tungsten trough is used as the heat conductor. High-frequency induction heating can also be used. In each case, a very high vacuum of at least 10^{-5} mm. is of controlling importance, if the purification is to be efficient. The material is first degassed by preheating it for about 1 hour at 1200°C. The temperature is then slowly increased and then maintained at 2000-2200°C for some time (one to several hours). If this temperature is reached too quickly or if the vacuum is not good, no purification will be achieved; in addition, in the case of Nb, there will also be undesirable melting, among other things (formation of a eutectic between metal and impurities).

III. CRYSTAL-GROWING (OR VAPOR-DEPOSITION) PROCESS

High-purity Nb or Ta can be obtained by deposition on an incandescent wire from gaseous NbCl_5 and TaCl_5 , either in the presence or the absence of hydrogen. This crystal-growing process corresponds closely to that described for titanium on p. 1168 ff., particularly as far as the apparatus is concerned. Since tungsten and Nb or Ta readily form brittle alloys, a tungsten nucleating (substratum) wire cannot be used in this case; instead, one uses an approximately 0.1-mm. ϕ wire of the metal to be deposited. In addition, Ni (and not W) terminals are used, and the system is degassed by heating to red heat in vacuum before the start of the run. The chloride (NbCl_5 or TaCl_5) is introduced into the side tube and vacuum-sublimed in situ; the entire reactor system is heated and thoroughly degassed prior to sublimation, because the absence of gas is essential to the quality of the deposited metals. The reactor remains connected to the vacuum pump throughout the entire process. Vapor deposition takes place by heating the chloride and the entire vessel to about 100°C ; the substratum wire is heated to 1800°C in the case of Nb, and to 2000°C in the case of Ta. The deposited metals are of very high purity.

The thickness of the incandescent wire changes continuously during the reaction, so that careful supervision of the process and good electrical control are imperative. This disadvantage is circumvented in Rolsten's modification of the process, whereby the volatile iodide of the metal is decomposed at $750\text{--}1100^\circ\text{C}$ in an indirectly heated fused quartz (or Vycor) tube.

Alternate methods: a) Reaction of the chlorides with Mg [J. Prieto, A. J. Shaler and J. Wulff, *Metals Technol.* 14, No. 6 (1947)].

b) Reduction of the oxides with Si while volatilizing the nascent SiO [E. Zintl et al., *Z. anorg. allg. Chem.* 245, 1 (1940)].

IV. COMMINATION OF THE SOLID METAL

Commercially available solid Nb and Ta (sheet, wire, etc.) are usually far purer than the powdered material. When metal powder of very highest purity is required for the preparation of a Nb or Ta compound, solid waste pieces may be used to advantage. They are pulverized by hydrogenation at $500\text{--}600^\circ\text{C}$ (see hydrides) and cooling under H_2 . The resulting hydrides are very brittle and are readily pulverized to the desired size. The powder thus obtained is then dehydrogenated at 1000°C in an extremely high vacuum. The decrease in purity occurring during these operations is negligibly small provided very pure H_2 is used, the pulverization of the hydrides is carried out in an inert gas atmosphere, and the

heating and degassing of the material is always carried out so slowly that no appreciable loss of vacuum occurs in the system (which is permanently connected to a vacuum pump).

PROPERTIES:

Nb: Atomic weight 92.91. M.p. 2468°C; d 8.58.

Te: Atomic weight 180.95. M.p. 3030°C; d 16.6.

These two metals are not attacked by mineral acids (with the exception of hydrofluoric); they are readily soluble in a mixture of concentrated hydrofluoric and nitric acids. Crystal structure: A 2 (W) type.

REFERENCES:

- General: A. E. van Arkel. *Reine Metalle* [Pure Metals], Berlin, 1939; H. Funk. *Die Darstellung der Metalle in Laboratorium* [Laboratory Preparation of Metals], Stuttgart, 1938; Ullmans *Enzyklopädie d. tech. Chemie* [Ullman's Encyclopedia of Industrial Chemistry], 12, Munich-Berlin, 1960, Niobium, p. 736 ff.; G. L. Miller. *Tantalum and Niobium*, London, 1959.
- I. K. R. Krishnaswami. *J. Chem. Soc. (London)* 1930, 1277; W. Kroll. *Z. anorg. allg. Chem.* 234, 42 (1937); J. W. Marden and M. N. Rich. U. S. Patent 1,728,941 (1927/29); G. Brauer. Unpublished experiments, Darmstadt, 1942; W. E. Dennis and A. F. Adamson. U.K.A.E.A. Techn. Note No. 92 (1954); E. F. Block. U.S. Bureau of Mines, paper given at the Achema meeting, Frankfurt, 1958.
- II. H. Bückle. *Z. Metallkunde* 37 (*Metallforsch.* 1), 53 (1946); R. H. Myers. *Metallurgia (Manchester)* 38, 307 (1948); Symposium on the Metallurgy of Niobium, *J. Inst. Metals* 85 (1956-57); B. W. Gonser and E. M. Sherwood. *The Technology of Columbium*, New York-London, 1958.
- III. W. G. Burgers and J. C. M. Basart. *Z. anorg. allg. Chem.* 216, 223 (1934); see also the literature cited in section on Ti, method V; R. F. Rolsten. *Trans. A.I.M.E.* 215, 472 (1959); *J. Electrochem. Soc.* 106, 975 (1959); *Z. anorg. allg. Chem.* 305, 25 (1960).

Vanadium, Niobium and Tantalum Hydrides

After thorough degassing at red heat in vacuum, the metals are heated in an atmosphere of extremely pure H₂. The rate of hydrogen absorption depends strongly on the particle size of the metals, the metal purity and the pretreatment method. Above 400°C, even solid Nb and Ta (sheet, wire, etc.) react fairly rapidly. The rate of the reaction increases with the metal purity and is particularly

high if the metal history includes a previous hydrogenation and dehydrogenation. In that case, hydrogen is sometimes absorbed even at room temperature. Both the NbH and the TaH systems may exist in two stable phases; the transitions from one to another, however, are not clearly reflected in the isotherms and isobars of the H₂ equilibrium pressure. Hence, depending on the temperature and equilibrium H₂ pressure, the hydrogenated material may contain hydrogen in all ratios up to the limiting composition, which is approximately NbH_{0.93} and TaH_{0.9} (corresponding to 112 ml. of H₂/g. of Nb and 56 ml. of H₂/g. of Ta. One gram of V absorbs a maximum of 205 ml. of H₂, corresponding to the limiting formula VH_{0.94}).

The deuterides of Nb and Ta are analogous to the hydrides prepared under the same conditions.

PROPERTIES:

Lustrous metallic or metallic gray appearance, much like that of the free metals. The lower hydrides (up to approximately MH_{0.1}) are quite hard but are still ductile, increasing in brittleness with increasing H content and becoming extremely brittle at high hydrogen ratios. The hydrogen can be removed in a high vacuum at temperatures exceeding 400°C, and rapidly between 800 and 1000°C.

REFERENCES:

- General: D. P. Smith. *Hydrogen in Metals*, Chicago, 1948.
 V-H: L. Kirschfeld and A. Sieverts. *Z. Elektrochem.* **36**, 123 (1930); H. Huber, L. Kirschfeld and A. Sieverts. *Ber. dtsh. chem. Ges.* **59**, 2891 (1926); M. J. Trzeciak, D. F. Dilthey and M. W. Mallett. *Batelle Mem. Inst. Rep.* 1112 (1956).
 Nb-H: A. Sieverts and H. Moritz. *Z. anorg. allg. Chem.* **247**, 124 (1941); W. M. Albrecht, M. W. Mallett and W. D. Goode. *J. Electrochem. Soc.* **105**, 219 (1958); **106**, 981 (1959); S. Komjathy. *J. Less Common Metals* **2**, 466 (1960).
 Ta-H: A. Sieverts and H. Brüning. *Z. phys. Chem. (A)* **174**, 365 (1935); A. Sieverts and E. Bergner. *Ber. dtsh. chem. Ges.* **44**, 2394 (1911).

Niobium (II) Chloride

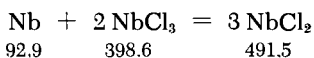

Stoichiometric quantities of Nb metal powder and NbCl₃ are weighed under anhydrous conditions, triturated and placed in a quartz tube which is closed at one end. Constrictions *b* and *d* (Fig. 305) are then made in the end of the tube and it is connected to a high-vacuum source. (It should be remembered in calculating

the amount of NbCl_3 that this compound exhibits a considerable phase width and can, therefore, be of varying composition. The use of $\text{NbCl}_{2.87}$ is particularly convenient.)

To degas the contents, the reactor is heated for 12 hours in high vacuum at 200°C and is then melt-sealed at constriction *d*. The reaction is completed by heating the entire tube at 800°C for two to three days. The tube is then chilled in water and the fairly volatile by-products (NbCl_5 , NbOCl_3) are distilled forward into tube section *c* by establishing a $200/20^\circ\text{C}$ temperature gradient. The NbCl_2 remains in *a*.

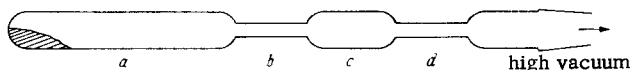

Fig. 305. Preparation of niobium (II) chloride. The quartz reactor is 8 mm. I.D. Length: *a* = 50 mm., *c* = 20 mm.

PROPERTIES:

Formula weight 163.82. Black-brown crystals. Stable in air, insoluble in H_2O and organic solvents. When heated in an evacuated tube, the NbCl_2 decomposes at a temperature gradient of $800/550^\circ\text{C}$ via the equilibrium reaction: $4 \text{NbCl}_2 = \text{Nb} + 3 \text{NbCl}_{2.87}$; at a temperature gradient greater than $800/20^\circ\text{C}$, the reaction is: $2 \text{NbCl}_2 = \text{Nb} + \text{NbCl}_4$. Heating in air produces NbOCl_3 and Nb_2O_5 .

REFERENCES:

- H. Schäfer and K. D. Dohmann. *Z. anorg. allg. Chem.* **300**, 1 (1959);
 H. Schäfer and F. Kahlenberg. *Z. anorg. allg. Chem.* **305**, 291 (1960).

Niobium (III) Chloride

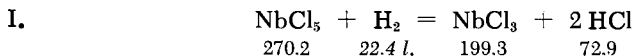

High purity, oxygen-free hydrogen is passed through a vessel containing NbCl_5 heated to $150\text{--}190^\circ\text{C}$. The gas stream then passes through a Pyrex or Vycor tube heated to $400\text{--}530^\circ\text{C}$ and solid precipitate of green-black NbCl_3 deposits on the walls. Complete conversion of NbCl_5 to NbCl_3 may be achieved, provided the gas rate is low. The lower partial pressures of NbCl_5 (at a saturation temperature of 150°C) and the higher temperature of the reaction zone (that is, 530°C) lead to a limiting composition which is low in chlorine ($\text{NbCl}_{2.87}$).

Brubaker and Young prepared NbCl_5 from Nb metal and Cl_2 in the apparatus shown in Fig. 310; they then allowed it to sublime in an H_2 stream through constriction *c* into the right-hand tube, which was heated to 500°C and equipped with a cold finger. The NbCl_3 separated both as a dark crust on the tube wall and as a cone-shaped deposit on the cold finger. The product may be pyrophoric when prepared by this procedure; it should, therefore, be handled only under a protective N_2 blanket.

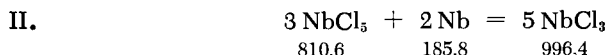

High-surface Nb metal (e.g., foil) and a slight excess of NbCl_5 are placed in an evacuated reactor tube which is then sealed. (The NbCl_5 can be prepared in the reactor itself before introducing the Nb metal; this can be accomplished by reacting weighed amounts of Nb_2O_5 and CCl_4 —see preparation of NbCl_5 , method III.) The sealed horizontal reactor is heated for three days in a temperature gradient such that the end of the tube containing Nb is at 390°C , while the remainder of the tube is at 355°C . The contents are thus converted to NbCl_3 , which, as a result of the reversible equilibrium NbCl_3 (solid) + NbCl_5 (gas) = 2NbCl_4 (gas), is transported into the 355°C zone where it deposits as crystals. It can then be resublimed by reversing the temperature gradient. At the end of the procedure, only the part of the tube containing the NbCl_3 is heated for a few minutes to 390°C while keeping the other end at 20°C , thus driving the NbCl_5 to the cold end. The tube is allowed to cool and is then opened under anhydrous conditions.

The partial pressure of NbCl_5 and, hence, the composition of the NbCl_3 phase can be varied in this synthesis by varying the ratio of the NbCl_5 to the volume of the sealed tube (saturation pressure of NbCl_5 at 355°C is 8 atm.).

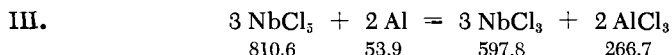

Sublimed NbCl_5 is heated with a less than stoichiometric quantity of Al powder in an evacuated, sealed tubular reactor. For example, 1.2 g. of NbCl_5 and 0.08 g. of Al may be used. The entire length of the tube is heated to 275°C for about 40 hours. It is then placed in a temperature gradient, with the main section encased in an aluminum block at 300°C and the protruding end at room temperature. The partially formed NbCl_4 decomposes into NbCl_3 and NbCl_5 , the excess NbCl_5 and AlCl_3 sublime into the tube end, while the green-black NbCl_3 remains in the main (lower) section of the tube. It is recovered by opening the tube; no special precautions against air are needed. The product of this process usually contains a small amount of Al_2O_3 (about 0.7%) which is introduced with the Al powder.

Alternate methods: a) Reduction of NbCl_5 with activated (excitation) H_2 at 200°C [V. Gutmann and H. Tannenberger, *Monatsh. Chem.* **87**, 769 (1956)].

b) Preparation from Nb metal in an HCl stream at 300°C . A mixture of NbCl_3 and NbCl_5 is obtained [V. Y. Spitsyn and N. A. Preobrazhenskiy, *Zh. Obshch. Khimii* **10**, 785 (1940); C. H. Brubaker and R. C. Young (1951)].

PROPERTIES:

Green-black; crystallizes in crusts, rods, or plates. Under sufficiently high NbCl_5 pressure and in the absence of air, NbCl_3 is stable at 800°C . It disproportionates to NbCl_5 and Nb in a temperature gradient. Only slightly air-sensitive at room temperature. Insoluble in H_2O , dilute acids and dilute alkali. Attacked by oxidizing agents at varying rates depending on the concentration and the temperature. Insoluble in organic solvents, even in ethanol.

Exhibits a rather wide homogeneity region (between $\text{NbCl}_{3.13}$ and $\text{NbCl}_{2.87}$). d 3.75.

REFERENCES:

- I. P. Süe. *Bull. Soc. Chim. France* [5] **6**, 830 (1939); H. Schäfer and C. Pietruck. *Z. anorg. allg. Chem.* **266**, 151 (1951); C. H. Brubaker and R. C. Young. *J. Amer. Chem. Soc.* **73**, 4179 (1951); H. Schäfer and K. D. Dohmann (1959).
- II. H. Schäfer and K. D. Dohmann. *Z. anorg. allg. Chem.* **300**, 1 (1959).
- III. H. Schäfer, G. Göser and L. Bayer. *Z. anorg. allg. Chem.* **265**, 258 (1951).

Niobium (IV) Chloride



Prepared by reduction of NbCl_5 .

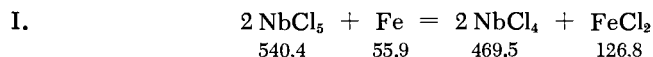

The reaction is carried out in a sealed tube divided into two sections by a constriction, as shown in Fig. 306. The NbCl_5 (3 g.) is introduced into the closed tube end *a* by connecting the tube via its still open end *b* to the apparatus used for isolation of NbCl_5 (Fig. 309). Pure iron (0.24 g., e.g., Armco iron turnings or reduced iron) is placed in section *b*, the tube is drawn out to a

point, high vacuum is applied, and the tube is sealed at the point. The horizontal sealed tube is encased in two closely spaced aluminum blocks which are electrically heated to two different temperatures. The section containing NbCl_5 is heated to 195°C , and that with Fe to 400°C . The reaction time is at least 40 hours. The gaseous NbCl_5 is reduced and NbCl_4 separates as well-formed crystals in a transition region between the two temperature zones. The FeCl_2 (which at 400°C is still not very volatile) and unreacted NbCl_5 are found in the other sections of the tube.

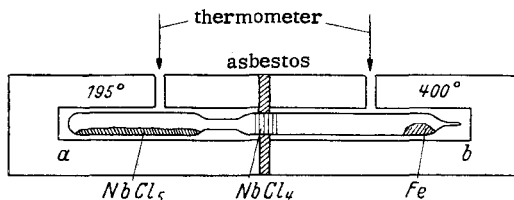
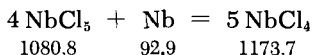

Fig. 306. Preparation of niobium (IV) chloride.

To prevent scattering of the reaction products by a rapid influx of gas (dry air, CO_2 or N_2) while opening the evacuated tube, the tip of the tube should be scratched, placed in a slightly larger vacuum hose, and broken off under vacuum. The tube may then be gradually filled with gas through the vacuum hose. To isolate the NbCl_4 , the tube is then broken at an appropriate spot.

II. The NbCl_5 can also be reduced with Nb metal.



Thus, NbCl_5 and an excess of Nb metal are sealed into a tube described in method I and heated in the same temperature gradient; the reaction is complete in about 16 hours.

Alternate methods: a) Reduction of NbCl_5 with Al metal; requires a subsequent distillation of excess NbCl_5 and AlCl_3 .

b) Reduction of NbCl_5 with H_2 at 2 atm. (generated when the tube is filled at STP, sealed and then heated). The reaction does not go to completion and NbCl_5 and NbCl_4 must be separated by sublimation.

c) Reaction of NbCl_5 and NbCl_3 ; as in most methods, an excess of NbCl_5 is usually required to depress the decomposition of NbCl_4 .

PROPERTIES:

Brown-black crystal needles; pure brown in transmitted light. Sublimable at about 275°C , provided decomposition into NbCl_5 and

NbCl_3 is prevented by a sufficiently high NbCl_5 pressure. Decomposes on exposure to air and moisture (color change first to black, then to white). Dissolves in a small amount of H_2O and in dilute hydrochloric acid, giving a dark-blue solution.

REFERENCES:

- H. Schäfer, C. Göser and L. Bayer. *Z. anorg. allg. Chem.* **265**, 258 (1951); data from the Chemical Laboratory of the University, Freiburg i. Br., 1952; H. Schäfer, L. Bayer and H. Lehmann. *Z. anorg. allg. Chem.* **268**, 268 (1952).

Tantalum (IV) Chloride

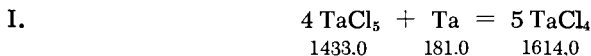

A quartz reactor tube with a narrow hooked constriction, shown in Fig. 307 (I), is thoroughly degassed by heating in a high vacuum; then, 4 g. of Ta metal (preferably foil) and 10-15 g. of TaCl_5 are introduced into the tube on opposite sides of the constriction, and the tube is sealed under high vacuum. It is then heated in a slanted position in a temperature gradient so that the liquid TaCl_5 (in the higher end of the tube) is at 280°C and the Ta at 630°C . The nascent

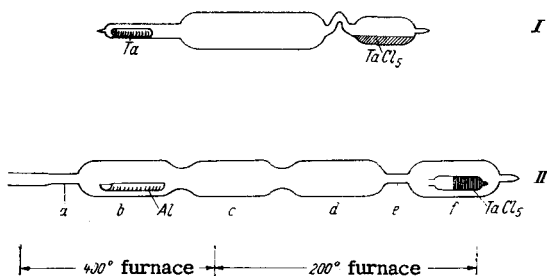
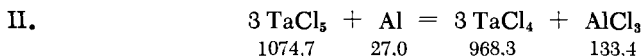
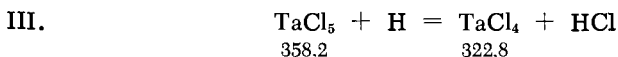

Fig. 307. Preparation of tantalum (IV) chloride. *b*) aluminum foil; *f*) TaCl_5 .

TaCl_4 deposits in the 280° zone (large crystals) but is separate from the TaCl_5 . A six-day run yields 8-10 g.; there is also a residue of unreacted starting materials. Before opening the tube, the reactor is cooled, and the section containing TaCl_4 is reheated to 200°C to separate any admixed TaCl_5 by sublimation. The opening of the tube and handling of TaCl_4 should be carried out in the absence of moisture.



The reaction is carried out in a sealed reactor tube (Fig. 307, II) in a high vacuum. Aluminum foil (for example, 50 mg.) is introduced at *b*, while TaCl₅ (4-5 g.) in an ampoule is at *f*; both are introduced under anhydrous conditions. The TaCl₅ is made to sublime (in high vacuum) toward tube section *d*, and the tube is sealed off at constrictions *a* and *e*. The sealed tube is heated for 70 hours in a temperature gradient (see Fig. 306) such that *b* is at 400°C and the remainder of the tube at 200°C. The TaCl₄ deposits at *c* as large crystals. The tube is allowed to cool and only section *c* is reheated to 200°C to remove any TaCl₅ present in it.



Whereas TaCl₅ reacts with molecular H₂ only at temperatures exceeding 500°C (to form Ta metal), the reduction of TaCl₄ with H₂ activated by a high-frequency electrical discharge can be carried out at 200°C. The apparatus is the same as that for the preparation of TaBr₄ (Fig. 311) and the process is the same in all its details. A two-hour run completely reduces 1 g. of TaCl₅.

PROPERTIES:

Brown-black crystals. Moisture-sensitive; decomposes with oxidation on exposure to air. On heating in vacuum, disproportionates to TaCl₅ and a lower chloride; on heating in air forms Ta₂O₅ and volatile TaCl₅. Partly soluble in H₂O and dilute acids, yielding coffee-brown solutions; an insoluble dark material is also formed.

REFERENCES:

- I. H. Schäfer and F. Kahlenberg. *Z. anorg. allg. Chem.* **305**, 178 (1960).
- II. H. Schäfer and L. Grau. *Z. anorg. allg. Chem.* **275**, 198 (1954).
- III. V. Gutmann and H. Tannenberger. *Monatsh. Chem.* **87**, 769 (1957).

Niobium (V) and Tantalum (V) Chlorides

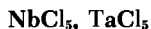

NbCl₅

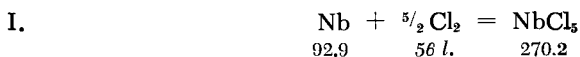

Niobium metal, either as a powder or as a solid, can be readily chlorinated in a Cl₂ stream. The reaction is best carried out in a

tube similar to that shown in Fig. 312 (preparation of NbBr_5); however, the saturation tube is replaced by a T connector through which the sealed tube can be evacuated or dry N_2 or Cl_2 introduced. The end arrangement of the apparatus varies depending on the expected amount of NbCl_5 . Air must be carefully displaced by evacuation or purging with N_2 . The reaction with Cl_2 starts at 125–240°C; at 240°C, it takes only a few hours regardless of the Nb particle size. The absorption of Cl_2 is usually quite rapid. The NbCl_5 product is taken out under anhydrous conditions and resublimed in an appropriate manner (the apparatus of Fig. 308 can be used).

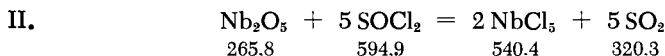

A common, carefully dried bomb tube is charged with 2.7 g. of Nb_2O_5 and 10 ml. of SOCl_2 . Care should be taken in the preparation of Nb_2O_5 (from precipitated hydrated oxide) not to exceed 400°C, since excessively calcined oxide is inactive and reacts incompletely.

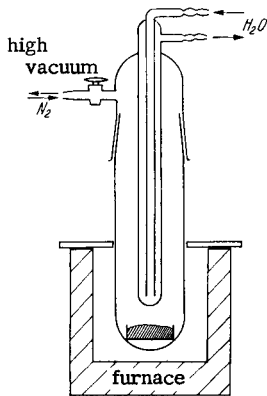

Fig. 308. Resublimation of niobium and tantalum pentahalides under anhydrous conditions.

Thus, if the oxide is excessively calcined, it is fused with KHSO_4 , the melt hydrolyzed, the hydrated oxide precipitated with ammonia and then dried for a long time at about 400°C. Before use, the SOCl_2 is purified by first refluxing it for 4 hours in the presence of S and then fractionally distilling it in a column [D. L. Cottlet, J. Amer. Chem. Soc. 68, 1380 (1946)].

The filled and sealed tube is heated for 3 hours at 200°C. On slow cooling, NbCl_5 crystallizes in needles. The tube is cooled to -10°C, opened, and the SO_2 discharged by heating to room temperature; the excess SOCl_2 is removed by further slight heating in vacuum. To achieve this, as well as for the further handling of NbCl_5 , the apparatus shown in Fig. 309 is attached to the open bomb. Because of the high sensitivity to moisture exhibited by NbCl_5 , it is absolutely necessary to equip the apparatus with devices which permit handling of the product in such a way that even traces of moisture will be excluded. The NbCl_5 remaining at *a* is first moved to *b* by subliming it under vacuum; it is then transferred to *g* (under nitrogen) for further handling. This is achieved by removing the ground cap *c*, stretching a thin perforated rubber

cap over the tube and introducing through this cap a small spatula with a long handle. Tube *g* of Fig. 309 is used for storing the product; it is closed at *f* with a ground glass stopper and permits partial removal of the chloride. Protection from moisture is provided by N_2 , which is introduced through *h*. Naturally, other types of containers can be used instead of *g*, for example, a simple ampoule which is sealed off.

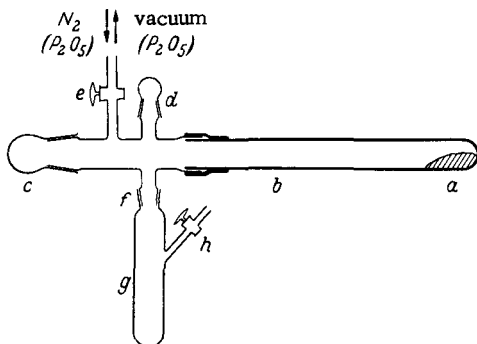
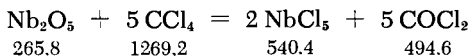

Fig. 309. Purification by sublimation and filling of a vessel with niobium (V) chloride. *a, b*) bomb tube; *c, d*) openings for introducing spatulas and long-handle hooks; *g*) storage vessel.

III. The oxide can also be chlorinated with CCl_4 in a similar fashion:



In this method (which was originally developed for analytical purposes) 1 g. of oxide and 4 ml. of CCl_4 are heated for 5-10 hours at 270-300°C in a sealed tube. It is not absolutely necessary to remove the air from the tube before the reaction. After opening the tube, which should be done with the usual precautions, the reactants are distilled off. The $NbCl_5$ is resublimed under vacuum and isolated as described in method II. Because of the high pressures developed in the sealed tube, this method is limited to small quantities of reactants [E. R. Epperson et al., *Inorg. Syntheses* 7, 163 (1963)].

Alternate methods:

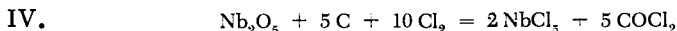

In this very old method, the oxide is mixed with purified sugar charcoal in a 1:4 molar ratio. The granular mixture is placed (without a boat) in a tube of high-melting (Pyrex or Vycor) glass.

Beyond the mixture (in the direction of gas flow) there is a fairly long bed of pure charcoal. Before starting the chlorination, both layers are dehydrated by heating to 500°C in a stream of very pure N₂. Very pure, O₂-free Cl₂ is then passed through while heating the mixture to 280-350°C and the adjacent charcoal layer to 750°C. The NbCl₅ receiver is sealed directly onto the reactor via a constriction. During the reaction (3 hours for 8 g. of Nb₂O₅ and 32 g. of C) the constriction must be checked to make sure that it does not become plugged with NbCl₅. The formation of the by-product NbOCl₃, which is usually difficult to avoid in this reaction, is almost completely prevented under these conditions. In spite of this, separation of the NbCl₅ from the NbOCl₃ by careful fractional sublimation is recommended. [P. Süe, Bull. Soc. Chim. France [5] 6, 830 (1939); R. F. Rolsten, J. Amer. Chem. Soc. 80, 2952 (1958)].

V.

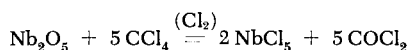

A chlorine stream containing CCl₄ vapor (the stream is saturated by bubbling through a CCl₄-containing wash bottle) is reacted with the oxide held in a boat which is inserted into a tube of high-melting glass or, better, a quartz tube. The reaction temperature is 300-400°C. Quite often, NbOCl₃ is also formed as a by-product [Gmelin-Kraut, Handbuch anorg. Chem. [Handbook of Inorganic Chemistry], 7th ed., Vol. IV/1, Heidelberg, 1928, p. 236].

VI.

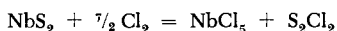

[O. Hönigschmid and K. Wintersberger, Z. anorg. allg. Chem. 219, 161 (1934).]

PROPERTIES:

Yellow, granular to needle-shaped crystals; dark-red when contaminated with 1 mole % of WCl₆. M.p. 204.5°C, b.p. 254°C; d 2.75. The melt is orange.

Extremely sensitive to moisture, which rapidly converts it to the white NbOCl₃ and then to Nb₂O₅ · xH₂O; hence it cannot be handled in air without marked decomposition. Reacts vigorously with water (dec.); dissolves without decomposition in ethanol, ether and, by an unknown mechanism, also in very concentrated hydrochloric and oxalic acid solutions.

TaCl₅

I.

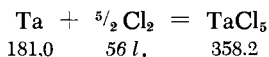

The preparation from the elements is exactly the same as in method I for NbCl₅. When Ta powder is used, the reaction starts at 170°C and is complete in a few hours at 250°C.

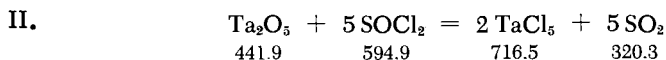

A mixture of 2.6 g. of Ta_2O_5 and 5.5 ml. of SOCl_2 (threefold excess) is heated for 6 hours in a bomb tube at 230-240°C. The preparation of the starting materials and the procedure are exactly the same as for NbCl_5 , method II. The reaction yields a liquid solution of TaCl_5 in SOCl_2 from which SOCl_2 is removed by distillation in the apparatus shown in Fig. 309, while the TaCl_5 is resublimed.

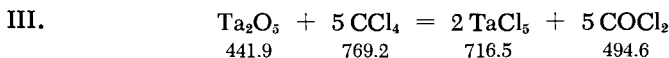

The reaction is carried out exactly as for NbCl_5 , method III, the mixture being heated to 300-320°C.

Alternate methods: a) Methods IV and V for the preparation of NbCl_5 can be applied to TaCl_5 in exactly the same manner. Since (in contrast to NbOCl_3) no tantalum oxychloride is formed, the products are fairly pure.

b) From Ta and HCl at about 400°C [R. C. Young and C. H. Brubaker, J. Amer. Chem. Soc. 74, 4967 (1952)].

c) According to Chaigneau, the reaction between Ta_2O_5 and AlCl_3 reported by Ruff and Thomas is nearly quantitative when the reactants are used in the following proportions:

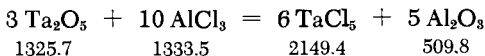

Before use, the AlCl_3 should be purified by vacuum sublimation. The reactants are sealed under vacuum into a tube of high-melting glass. After heating for 48 hours at 400°C, the TaCl_5 product can be separated from the Al_2O_3 by vacuum sublimation at 200°C. According to Schäfer, Göser and Bayer, reaction mixtures with a different composition ($2\text{Ta}_2\text{O}_5 + 5\text{AlCl}_3$) yield AlOCl as the residue. Mixtures of Nb_2O_5 and AlCl_3 usually yield only mixtures of NbCl_5 and NbOCl_3 [O. Ruff and F. Thomas, Z. anorg. allg. Chem. 148, 1 (1925); H. Schäfer, C. Göser and L. Bayer, Z. anorg. allg. Chem. 263, 87 (1950); M. Chaigneau, Comptes Rendus Hebd. Séances Acad. Sci. 243, 957 (1956)].

PROPERTIES:

Colorless crystalline needles; yellow when contaminated by NbCl_5 (even 1% NbCl_5 imparts a definite yellow color) or tungsten chlorides. M.p. 216.2°C, b.p. 239°C; d 3.68. Very sensitive to moisture; decomposed by H_2O and even by concentrated HCl, separating tantalic acid. Soluble in absolute ethanol.

REFERENCE:

- I. K. R. Krishnaswami. *J. Chem. Soc. (London)* 1930, 1277; K. M. Alexander and F. Fairbrother. *J. Chem. Soc. (London)* 1949, 223; W. Littke. Thesis, Univ. of Freiburg i. Br., 1961.
- II. H. Hecht, G. Jander and H. Schlapmann. *Z. anorg. Chem.* 254, 255 (1947); J. Wernet. *Z. anorg. allg. Chem.* 267, 213 (1952); experiments carried out in the Chemical Laboratory of the University, Freiburg i. Br., 1951.
- III. O. Ruff and F. Thomas. *Z. anorg. allg. Chem.* 156, 213 (1926); H. Schäfer. *Z. Naturforsch.* 3b, 376 (1948); H. Schäfer and C. Pietruck. *Z. anorg. allg. Chem.* 264, 1 (1951); 267, 174 (1951).

Niobium Oxytrichloride

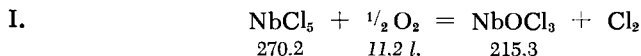

About 2 g. of NbCl_5 is allowed to sublime from a side arm into a reactor tube which is approximately 20 mm. I.D. To promote good distribution of the NbCl_5 , the tube contains a small amount of washed and dried glass wool. A slow stream of dry O_2 (1-2 liters/hour) is passed through while the tube which is heated to 150°C by means of a tubular electric furnace. About 80% of the NbCl_5 reacts in 2 hours. The remainder sublimes unchanged into the cold section of the tube, from which it is driven back (vacuum) and then again treated with O_2 . In this manner, nearly complete conversion is achieved; the nascent NbOCl_3 is sublimed in an O_2 stream at 200°C to that section of the tube which is kept at 100°C . It deposits there as a dense crystal rosette. The material is discharged from the tube and handled under completely anhydrous conditions.

II. Prepared in a sealed tube according to the reaction:

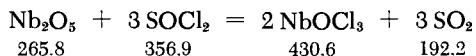

The reaction proceeds exactly according to the stoichiometry shown by the equation. The method used for preparing the reactants is the same as that described for the preparation of NbCl_5 (p. 1303). A recommended charge for a normal bomb consists of 13.3 g. of Nb_2O_5 (1/20 mole) and 10.9 ml. of SOCl_2 , prestirred into a paste.

It is important that the reactants be intimately mixed before they are heated, because otherwise the SOCl_2 will react preferentially with the outer part of the oxide mass to form NbCl_5 , while a large portion of the oxides will remain unreacted. The mixture is heated for about 6 hours at 200°C . After cooling, well-formed crystals of NbOCl_3 (fine needles) are found in the lower part of the tube. Purification (by sublimation) and isolation of the NbOCl_3 must be done carefully: temperatures should be held below 350°C to prevent decomposition into Nb_2O_5 and NbCl_5 . This operation is best carried out in the apparatus of Fig. 309.

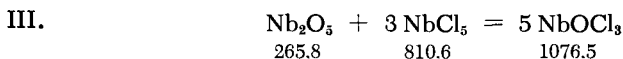

A glass tube is filled under vacuum with 0.3 g. of Nb_2O_5 and 3 g. of NbCl_5 (a very large excess), with the two compounds placed at opposite ends of the tube. The inclined tube is then heated in a temperature gradient (Nb_2O_5 350°C /liquid NbCl_5 210°C). After 12 hours, white crystalline needles of NbOCl_3 deposit in the center of the tube. Unreacted NbCl_5 is then removed by heating the tube in a $200/20^\circ\text{C}$ temperature gradient. The NbOCl_3 is isolated under a blanket of dry, inert gas.

Alternate methods: a) The NbOCl_3 is often a by-product of preparative reactions for NbCl_5 [e.g., $\text{Nb}_2\text{O}_5 + \text{CCl}_4$, D. E. Sands, A. Zalkin and R. F. Elson, *Acta Crystallogr.* **12**, 21 (1959)]. The separation from NbCl_5 can be achieved by repeated fractional sublimation under vacuum or in an O_2 stream at temperatures below 350°C .

b) The product can also be prepared by thermal decomposition of NbCl_5 etherate at 90°C . [F. Fairbrother, A. H. Cowley and N. Scott (1959)].

PROPERTIES:

Colorless, often crystallizes in very fine needles. Vapor pressure: 10 mm. (234°C); 760 mm. (335°C). Disproportionates into Nb_2O_5 (or $\text{Nb}_3\text{O}_7\text{Cl}$) and NbCl_5 above 350°C . Best purified by vacuum sublimation at 200°C . Very sensitive to moisture; decomposed by H_2O . Tetragonal crystals.

REFERENCE:

- I. P. Süe. *Bull. Soc. Chim. France* [5] **6**, 830 (1939); F. Fairbrother, A. H. Cowley and N. Scott. *J. Less-Common Metals* **1**, 206 (1959).
- II. H. Hecht, G. Jander and H. Schlapmann. *Z. anorg. Chem.* **254**, 260 (1947); J. Wernet. *Z. anorg. allg. Chem.* **276**, 213 (1952).
- III. H. Schäfer and F. Kahlenberg. *Z. anorg. allg. Chem.* **305**, 327 (1960).

Niobium (III) Bromide

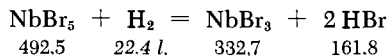

The apparatus of Fig. 310, containing boat *s* with the niobium metal, is dried in a stream of very pure N_2 at 200°C . Furnace o_1 is then heated to 450°C and dry Br_2 vapor is introduced in an N_2 stream. The nascent NbBr_5 condenses at *a*.

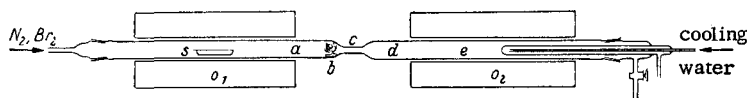

Fig. 310. Preparation of niobium (III) bromide. *s*) boat containing niobium metal; *b*) asbestos wool; o_1, o_2) electric furnaces.

After complete bromination, the bromide is sublimed in a pure N_2 stream at 270°C , passing through glass wool plug *b* and the constriction *c* into section *d*. Then, a stream of high-purity H_2 is introduced and NbBr_5 is allowed to sublime slowly into tube section *e*, kept at 500° by means of furnace o_2 . It deposits on the tube wall as a shiny black crust and as a black cone on the cold finger. The tube is opened and the product is removed under a protective N_2 blanket. The outer crusts are not air-sensitive and are insoluble in H_2O . On the other hand, the cones deposited in the inner part of the apparatus decompose rapidly in the presence of moist air.

PROPERTIES:

Black, with varying air sensitivity, depending on preparative conditions. Almost completely resistant to H_2O and dilute acids. Decomposed by concentrated H_2SO_4 and HNO_3 . Insoluble in organic solvents. Can be sublimed in a high vacuum (10^{-4} mm.) at about 400°C . Thermal decomposition into NbBr_5 and Nb begins at 900°C .

The TaBr_3 and the TaBr_2 can be obtained in the same manner as NbBr_3 , starting from TaBr_5 and H_2 at 700°C ; however, the purity and the yield are lower [R. C. Young and T. J. Hastings, *J. Amer. Chem. Soc.* **64**, 1740 (1942)].

The NbBr_2 can be prepared from NbBr_5 and activated H_2 at 200°C ; see preparation of TaBr_4 , p. 1310 [V. Gutmann and H. Tannenberger, *Monatsh. Chem.* **87**, 769 (1956)].

REFERENCE:

G. H. Brubaker and R. C. Young. *J. Amer. Chem. Soc.* **73**, 4179 (1951).

Tantalum (IV) Bromide

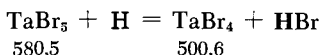

The horizontal reaction tube of high-melting glass (about 3 cm. I.D. and 50 cm. long) shown in Fig. 311 is heated in vacuum, and a boat containing TaBr_5 is introduced under anhydrous conditions. High-purity, dry H_2 is passed through the tube at a rate of about one liter per hour.

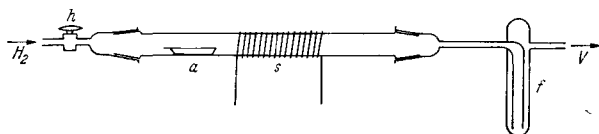

Fig. 311. Preparation of tantalum (IV) bromide. *a*) boat containing TaBr_5 ; *f*) cold trap; *h*) grooved stopcock for fine flow regulation; *s*) induction coil; *v*) vacuum.

A pressure of 4-6 mm. is maintained in the tube by means of the grooved stopcock *h*, which regulates the vacuum *v*. A glow discharge is produced by coil *s*, which consists of 16 turns of copper wire (2 mm. O.D.) on the outside of the tube; a high-frequency current of 4000 kilocycles/second is applied to the coil, which consumes about 20 watts. The glass wall temperature at the coil is about 180-200°C. The tube section containing TaBr_5 is heated; the TaBr_5 is slowly vaporized and reacts with the H_2 activated in the glow discharge zone. The nascent TaBr_4 is deposited on the tube wall in this zone. Unreacted TaBr_5 , which condenses on the cooler portions of the tube, can be driven back into the reaction zone and reduced by moving the induction coil to another spot. The reaction of 0.8 g. of TaBr_5 is complete within 3 hours. The tube is allowed to cool and the product is scraped off the tube wall under anhydrous conditions.

PROPERTIES:

Black powder with steel-blue tinge. Slightly hygroscopic. Disproportionates to TaBr_5 and TaBr_3 at 300°C under vacuum. Yields a brown solution and an insoluble residue with H_2O .

REFERENCE:

V. Gutmann and H. Tannenberger. *Monatsh. Chem.* **87**, 769 (1956).

Niobium (V) and Tantalum (V) Bromides

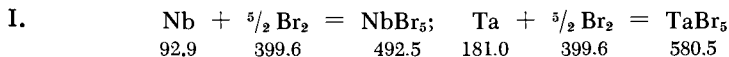
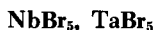

Pure, dry N_2 is saturated with Br_2 in a washing bottle or a saturation tube *s* (Fig. 312); the gas mixture is then passed over Nb or Ta metal contained in the horizontal reactor tube *r* made of quartz or high-melting glass. The metal may be either powder or solid.

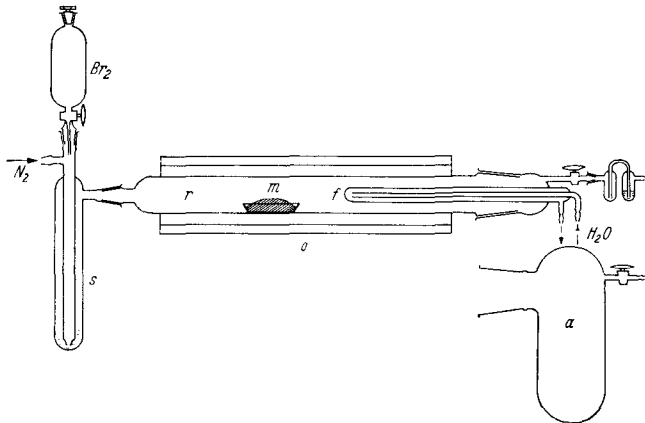
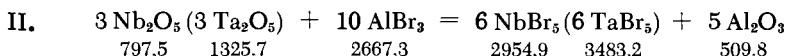

Fig. 312. Preparation of niobium (V) and tantalum (V) bromides. *a*) receiver; *f*) cold finger; *m*) boat containing the metal; *o*) tubular electric furnace; *r*) reactor tube; *s*) saturation tube.

First, the air is completely removed from the reactor. Then, the section of the tube containing the metal is heated by a coil

wound directly on the reactor, or by a tubular electric furnace *o*. If Nb powder is used, then bromide formation begins at 90°C; with solid Nb, it starts at 195°C and with Ta powder at 155°C; it is complete in a few hours at 230-250°C. The nascent bromide sublimes onto cold finger *f*. When larger quantities are desired, large-diameter receiver *a* is attached to the end of the reactor. The extremely hygroscopic bromide should be removed from the apparatus while the latter is in a dry box (Part I, p. 71).



In the method of Chaigneau, the mixture of pentoxide and AlBr_3 , in proportions indicated by the above equation, is sealed under vacuum into a Pyrex glass tube (before use, the AlBr_3 is purified by vacuum sublimation). The tube is heated for 24 hours at 200°C, and allowed to cool; the small amounts of Br_2 formed in the process and residual AlBr_3 are vacuum-sublimed at 140°C. The pure pentahalide is then separated from the Al_2O_3 by vacuum sublimation at 240°C, yielding large crystals.

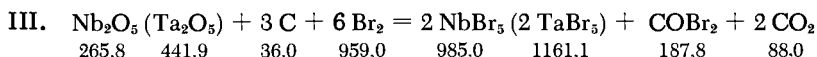

The bromides are prepared by a method similar to that presented for NbCl_5 (or TaCl_5) (method IV). An intimate mixture of the pentoxide with very pure charcoal (preferably sugar charcoal) is heated in a stream of inert gas (CO_2 , N_2) carefully prepurified to remove traces of O_2 and H_2O and saturated with dry Br_2 in a wash bottle. There is a possibility of a side reaction leading to the oxybromide in the case of Nb_2O_5 ; however, this does not happen with Ta_2O_5 . Wiseman and Gregory report a reaction temperature of 700-860°C in the case of Ta_2O_5 . The final product is resublimed under an inert gas or, better, in a high vacuum (190-200°C); because of its high sensitivity to moisture, it should be handled only under anhydrous conditions.

Alternate methods: a) Reaction of the pentoxide with CBr_4 (analogous to that with CCl_4 , see p. 1306) in a sealed tube yields pure TaBr_5 (in the case of Ta_2O_5) according to the equation: $\text{Ta}_2\text{O}_5 + 5 \text{ CBr}_4 = 2 \text{ TaBr}_5 + 5 \text{ CO} + 5 \text{ Br}_2$. The reactant mixture is heated for 7 days at 200°C, the gases formed are allowed to escape and TaBr_5 is vacuum-sublimed at 300°C. The yield is only about 70%. The corresponding reaction with Nb_2O_5 does not yield pure NbBr_5 ; instead, mixtures are formed [M. Chaigneau, *Comptes Rendus Hebd. Séances Acad. Sci.* **248**, 3173 (1959)].

b) The TaBr_5 can also be obtained from Ta and HBr at 375°C [R. C. Young and C. H. Brubaker, *J. Amer. Chem. Soc.* **74**, 4967 (1952)].

PROPERTIES:

NbBr_5 : red crystals; m.p. 265.2°C, b.p. 361.6°C.

TaBr_5 : yellow crystals; m.p. 265.8°C, b.p. 348.8°C. d 5.0.

Both compounds are very sensitive to hydrolysis, very soluble in ethanol (with a chemical reaction), and somewhat soluble in CCl_4 .

REFERENCES:

- I. M. Alexander and F. Fairbrother. J. Chem. Soc. (London) 1949, 223; D. H. Nowicky and I. E. Campbell in: H. S. Booth, *Inorg. Syntheses*, Vol. IV, New York-London-Toronto, 1953, p. 130; R. F. Rolsten. J. Phys. Chem. 62, 126 (1958); K. R. Krishnaswami. J. Chem. Soc. (London) 1930, 1277; C. H. Brubaker and R. C. Young. J. Amer. Chem. Soc. 73, 4179 (1951); W. Littke. Thesis, Univ. of Freiburg i. Br., 1961.
- II. M. Chaigneau. Comptes Rendus Hebd. Séances Acad. Sci. 243, 957 (1956).
- III. W. K. van Haagen. J. Amer. Chem. Soc. 32, 729 (1910); W. H. Chapin and E. F. Smith. J. Amer. Chem. Soc. 33, 1499 (1911); E. L. Wiseman and N. W. Gregory. J. Amer. Chem. Soc. 71, 2344 (1949).

Niobium Oxytribromide

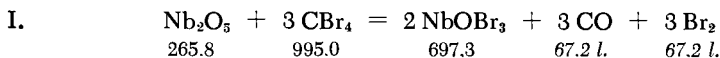

A stoichiometric mixture of Nb_2O_5 and CBr_4 is heated for 24 hours at 200°C in an evacuated, sealed tube. The tube is opened at its thin, drawn-out end, and the gases present are allowed to escape. The NbOBr_3 is then purified by vacuum-sublimation at 300°C. The yield is nearly quantitative.

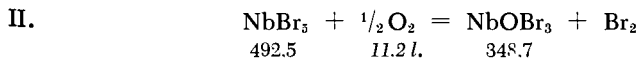

The apparatus is similar to that used for preparation of NbOCl_3 (method I); the NbBr_5 is heated in an O_2 stream at 150°C. About 1 hour is necessary for 1 g. of NbBr_5 . The NbOBr_3 product is then vacuum-sublimed at 180°C into another section of the reactor and kept there at 90°C. A dense crystal deposit is obtained. The final NbOBr_3 must be isolated and handled under completely anhydrous conditions.

Alternate methods: a) Reaction of Nb_2O_5 with C and Br_2 at 540°C .

b) Decomposition of NbBr_5 etherate at 112°C [F. Fairbrother, A. H. Cowley and N. Scott (1959)].

TaOBr_3 can be prepared from TaBr_5 and O_2 at 200°C via method II, but cannot be sublimed without decomposition.

PROPERTIES:

Yellow-brown; moisture sensitive, fumes in moist air. Thermal decomposition into Nb_2O_5 and NbBr_5 begins above 320°C .

REFERENCES:

- I. M. Chaigneau. *Comptes Rendus Hebd. Séances Acad. Sci.* **248**, 3173 (1959).
- II. F. Fairbrother, A. H. Cowley and N. Scott. *J. Less-Common Metals* **1**, 206 (1959).

Nobium (IV), Nobium (III) and Nobium (II) Iodides

NbI_4 , NbI_3 , NbI_2

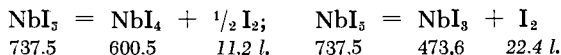

NbI_4

A tube, dried by fanning with a flame and prepared for evacuation and melt-sealing, is charged with a small amount of NbI_5 under completely anhydrous conditions.

The tube is then sealed in a high vacuum and the end containing NbI_5 is heated to 270°C while the reactor is in a horizontal position. The liberated iodine collects at the other end, which is kept at a temperature of about 35°C ($p[\text{I}_2] = 0.8 \text{ mm.}$). The reaction time is about 48 hours. A residue of NbI_4 remains on the spot where the starting NbI_5 was placed; it can be sublimed at about 300°C under the above-indicated I_2 pressure.

NbI_3

Either NbI_5 or NbI_4 is heated under vacuum in a horizontal sealed tube, as described in the preparation of NbI_4 . The higher iodide is heated to $425\text{--}430^\circ\text{C}$ and the tube end in which the liberated I_2 collects is kept at 40°C . Reaction time is 48 hours. The NbI_3 formed can be resublimed in the tube at $450\text{--}500^\circ\text{C}$ (partial decomposition).

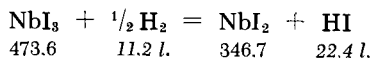
NbI₂

A boat containing NbI₃ is heated in a stream of pure H₂. The reaction begins at 300°C and is complete in a few hours at 400°C. Higher temperatures should be avoided to prevent reduction to Nb metal or Nb hydride (these reactions start above 400°C).

PROPERTIES:

NbI₄: dark-gray crystalline oblong leaflets or thin needles; metallic luster. Soluble in H₂O and dilute hydrochloric acid.

NbI₃: insoluble in H₂O or conc. HCl.

NbI₂: gray-black. Insoluble in organic solvents; slowly hydrolyzed by H₂O. d 5.18.

REFERENCE:

- M. Chaigneau. Comptes Rendus Hebd. Séances Acad. Sci. 242, 263 (1956); 245, 1805 (1957); J. D. Corbett and P. X. Seabaugh. J. Inorg. Nuclear Chem. 6, 207 (1958).

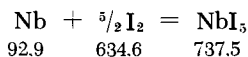
Niobium (V) Iodide**NbI₅**

A vertical tube of Vycor or Pyrex glass (I.D. approximately 23 mm., wall thickness 2.5 mm.) is charged with 4-12 g. of Nb metal (either solid or powder). A dense glass wool plug is placed over the charge and approximately 20 cm. from the closed tube end, followed by a 20% excess of pure, resublimed I₂ powder. The tube and its contents are thoroughly degassed in a high vacuum and melt-sealed under vacuum. Then the reactor is placed in a slightly inclined position (with the Nb metal at the higher and the I₂ at the lower end) and heated by means of two separate tubular electric furnaces (these meet at the center of the tube). The niobium is heated to 300°C and the I₂ first to 180°C and then to 250°C. The reaction is nearly quantitative after 10-15 hours and NbI₅ crystals collect in the transition zone between the two temperature regions. The yields are lower with Nb powder than with solid Nb. The reactor is broken at the center, the NbI₅ is

removed under anhydrous conditions (e.g., in a dry box, see Part I, p. 71), and repeatedly rinsed with dry petroleum ether (under N_2) until the adhering I_2 is removed and the petroleum ether stays colorless. The traces of petroleum ether are evaporated in vacuum.

According to Corbett and Seabaugh, this synthesis can also be carried out in a V-shaped, closed reactor tube.

The method of reacting a pentoxide with AlI_3 , used successfully for the preparation of TaI_5 , yields only impure NbI_5 when Nb_2O_5 is the starting material [M. Chaigneau, *Comptes Rendus Hebd. Séances Acad. Sci.* **242**, 263 (1956)].

Alternate method: Repeated distillation of $NbBr_5$ in an HI stream (a pure product is not readily obtained, however) [W. M. Barr, *J. Amer. Chem. Soc.* **30**, 1568 (1908); W. K. van Haagen, *J. Amer. Chem. Soc.* **32**, 729 (1910)].

PROPERTIES:

Yellow leaflets or needle-shaped crystals with a brass luster. Sublimes without decomposition only under considerable I_2 pressure. Very sensitive to moisture; decomposed by H_2O , forming HI.

REFERENCE:

- F. Körösy. *J. Amer. Chem. Soc.* **61**, 838 (1939); K. M. Alexander and F. Fairbrother. *J. Chem. Soc. (London)* **1949**, 2472; R. F. Rolsten. *J. Amer. Chem. Soc.* **79**, 5409 (1957); J. D. Corbett and P. X. Seabaugh. *J. Inorg. Nuclear Chem.* **6**, 207 (1958); W. Littke. Thesis, Univ. of Freiburg i. Br., 1961.

Tantalum (V) Iodide



The procedure corresponds exactly to that described for NbI_5 . The tube end containing the Ta metal is heated to $300^\circ C$ and that containing the I_2 first to 180, then to $250^\circ C$. The reaction is complete in 10-15 hours.

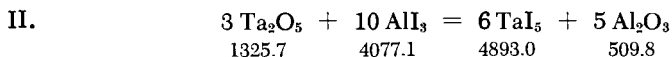

In this method of Chaigneau, a stoichiometric mixture of Ta_2O_5 and AlI_3 , in a Pyrex glass tube, is heated in vacuum for 24 hours

at 230°C. The tube section containing the reaction mixture (which by then is black) is heated further to 350°C and finally to 520°C. The TaI_5 sublimes (nearly theoretical yield) into the colder end of the tube, where it deposits as crystals.

PROPERTIES:

Shiny black rhombic crystals, subliming at 543°C. Vapor pressure: 7.6 mm. (320°C); 96 mm. (420°C); 421 mm. (500°C). d 5.80. Very sensitive to moisture.

REFERENCE:

- I. F. Körösy. J. Amer. Chem. Soc. 61, 838 (1939); K. M. Alexander and F. Fairbrother. J. Chem. Soc. (London) 1949, 2472; R. F. Rolsten. J. Amer. Chem. Soc. 80, 2952 (1958); W. Littke. Thesis, Univ. of Freiburg i. Br., 1961.
- II. M. Chaigneau. Comptes Rendus Hebd. Séances Acad. Sci. 242, 263 (1956).

Niobium (II) Oxide

NbO



A mixture of NbO_2 and Nb metal is pulverized to as small a size as possible and then compressed into small pellets which are heated for 10-20 minutes at 1600-1700°C in an atmosphere of very pure Ar or in a high vacuum. The best support for these pellets is Nb sheet; however, the pellets should touch this sheet only at a very few points.

II. NbO can also be prepared via a prolonged reduction of higher niobium oxides with H_2 . An especially thorough prepurification and predrying of the hydrogen is essential. The reaction is carried out at 1300-1750°C. The reduction of 0.5 g. of NbO_2 to NbO takes about 60 hours at 1350° and about 15 hours at 1700°C. It is important to follow the progress of the reduction via a periodic check on the weight of the reactants; this is because the reaction also readily yields Nb metal in addition to NbO. The metal may start to accumulate after the run is in progress for some time and, in the presence of the unavoidable trace impurities in H_2 , may be converted into Nb_2N and Nb_2C .

PROPERTIES:

Formula weight 108.91. Gray, submetallic. d 7.30. Crystal structure: special type similar to B 1 (NaCl) type.

REFERENCE:

- G. Grube, O. Kubaschewski and K. Zwiauer. Z. Elektrochem. 45, 885 (1939); O. Kubaschewski. Z. Elektrochem. 46, 284 (1940); G. Brauer. Z. anorg. allg. Chem. 248, 1 (1941).

Niobium (IV) Oxide

In this procedure, pure Nb_2O_5 is reduced in an H_2 stream at 1000-1200°C.

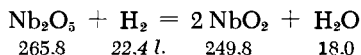

The reduction time for 1 g. of oxide (contained in a boat) is 1-2 hours. Weight control is necessary, since prolonged heating at high temperatures produces some further reduction to NbO.

PROPERTIES:

Formula weight 124.91. Black powder. d 5.9. Crystal structure: C 4 (rutile) type.

REFERENCE:

- P. Klinger. Techn. Mitteil. Krupp, Forschungsber. 1939, p. 171; G. Grube, O. Kubaschewski and K. Zwiauer. Z. Elektrochem. 45, 885 (1939); G. Brauer. Z. anorg. allg. Chem. 248, 1 (1941).

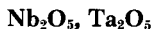
Niobium (V) and Tantalum (V) Oxides

Commercial Nb_2O_5 and Ta_2O_5 are usually low-purity products; in particular, Nb_2O_5 often contains Ta_2O_5 . They are frequently contaminated with Fe, Ti and Sn since these elements accompany Nb and Ta in the original minerals. The following methods for purifying the pentoxides are based on the assumption that the content of these impurities does not exceed a few percent.

I. PURIFICATION VIA THE CHLORIDE

a) The tantalum and the tin can be removed from commercial Nb_2O_5 (or Ta_2O_5) by converting the oxide into a chloride, followed by extraction or distillation. This method is limited to small quantities of reactants.

As we have shown in the preparation of NbCl_5 (or TaCl_5) (p. 1304) 1 g. of the oxide and 4 ml. of CCl_4 are placed in a common tubular bomb (which need not be evacuated), and chlorination is carried out while heating to 250-300°C. The sealed tube is then opened, and the solid pentachloride product is extracted five times by shaking with 5-ml. portions of CCl_4 , followed by phase separation. This may be done in air provided the operation is carried out quickly. The TiCl_4 and SnCl_4 are very readily soluble in CCl_4 , whereas the pentachlorides dissolve less readily and less rapidly (less than 10 mg. of chloride/1 ml. of CCl_4) and therefore remain as residues. The residues are then converted to the oxides with H_2O . Assuming complete chlorination prior to the extraction, the Ti and Sn content of the product oxides should be $\geq 0.05\%$.

b) Instead of leaching the TiCl_4 and SnCl_4 out of the chlorination product, the latter can be removed by vacuum sublimation at 0.1 mm. and 200°C (after the sealed tube is opened). In this procedure the subliming pentachlorides travel only a short distance within the tube before depositing in a cooler zone; however, the TiCl_4 and SnCl_4 are volatilized so completely that the pentoxides obtained by this procedure contain less than 0.05% of TiO_2 and SnO_2 .

c) The following method, which can be used to purify Nb_2O_5 (but not Ta_2O_5), has the advantage over the previously described one that it can be used with larger quantities of reactants.

The following preliminary treatments may be used:

a) Nb_2O_5 is fused with KHSO_4 ; the melt is allowed to cool and, after the grinding, is treated with dilute H_2SO_4 and H_2O_2 . The hydrated oxide is precipitated from the peroxide solution with SO_2 at the boiling point, the mixture is decanted, the supernatant is discarded and the aqueous slurry of the precipitate is used in further reactions.

b) Freshly precipitated hydrated oxide (or the Nb_2O_5 - KHSO_4 melt) is directly dissolved in ammonium oxalate or tartaric acid and the resulting solution of the complex is used in further reactions.

c) A hydrochloric acid solution or suspension of the chlorination products (NbCl_5 , NbOCl_3) may be the starting material.

Next, the solution (or suspension) is adjusted to a volume corresponding to a maximum concentration of 4 g. (or, even better, 2-3 g.) of Nb_2O_5 /100 ml. and the solution is saturated, while ice-cooling and agitating, with HCl gas as described in detail in the preparation of $(\text{NH}_4)_2\text{TiCl}_6$, p. 1199 ff. The suspension, as well as

the hydrated oxide precipitated during the treatment with HCl, eventually becomes clear when the solution is saturated with HCl; sometimes, however, the HCl treatment and the agitation must be quite long. Approximately three hours are required per 100 ml. Then 4 g. of solid NH_4Cl per 100 ml. is added and the mixture is agitated for approximately half an hour. The $(\text{NH}_4)_2\text{TiCl}_6$ and $(\text{NH}_4)_2\text{SnCl}_6$ precipitate up to their respective solubility limits (0.5 mg. of Ti and 0.4 mg. of Sn/100 ml.). The mixture is filtered through a small-pore fritted-glass filter (it is best to cool the filter externally with ice); the filtrate is diluted with four to five times its volume of H_2O and then hydrolyzed at the boiling point. The readily filtered hydrated oxide is then calcined to the oxide. A 70-80% yield of purified Nb_2O_5 , containing less than 0.1% of TiO_2 or SnO_2 , is obtained. The losses are due to the isomorphous occlusion of $(\text{NH}_4)_2\text{NbOCl}_5$ by the precipitated $(\text{NH}_4)_2\text{TiCl}_6$.

II. SEPARATION VIA THE OXALATE

Very pure niobium oxide can be obtained either from crude niobium oxide or from concentrated niobium oxide mixtures, provided the $\text{Ta}_2\text{O}_5:\text{Nb}_2\text{O}_5$ ratio is not greater than 1:4. The following method is used: Precipitated, moist hydrated oxide (equivalent to about 20 g. of anhydrous oxide) is repeatedly treated with fresh 200-ml. portions of a solution which is 2N in HCl and 5% in oxalic acid dihydrate. Each treatment involves heating the mixture for several hours on a bath at 60-70°C with stirring, followed by decantation. Most of the Ta remains in the insoluble residue, which also becomes concentrated in Ti and W; the nearly pure Nb goes into solution, always accompanied by Sn. The combined solutions are evaporated to dryness, and the residue calcined to decompose the oxalic acid. The calcination residue is rather pure Nb_2O_5 , containing only about 1% Ta_2O_5 plus some alkali stemming from the starting material.

This fairly pure Nb_2O_5 , in the form of precipitated hydrated oxide, may again be subjected to the same leaching operation, which gives a virtually Ta-free oxide.

III. SEPARATION BY EXTRACTION

The extraction of aqueous hydrofluoric solutions of the pentoxides with immiscible ketones can be used with very impure starting materials. In this case there is no restriction on the permissible Nb:Ta ratio. In this extraction, the aqueous phase contains HF and either HCl, HNO_3 or H_2SO_4 ; the best purification efficiency is obtained with HNO_3 and H_2SO_4 . The coefficients for partition of Nb and Ta between the two phases depend to a large

extent on the acid concentration. The extracting agents may be methyl isobutyl ketone (MIBK) or cyclohexanone. All equipment must be made of an HF-resistant material (polyethylene or polyvinyl chloride).

The pentoxide (or a mixture of pentoxides) is dissolved in strong hydrofluoric acid and the resulting solution adjusted, by addition of H_2SO_4 , to a concentration of 100 g. of pentoxide/liter, 5.6 N HF and 9 N H_2SO_4 . This solution is extracted twice with half its volume of MIBK. The combined ketone extracts contain virtually all of the Nb and Ta originally present and are free of other metals. The organic phase is then extracted with aqueous acid as follows.

a) When the starting material is either Nb_2O_5 or an Nb-rich mixture, the organic phase is shaken with the same volume of an aqueous solution that is 3 N in H_2SO_4 and 1 N in HF. This aqueous phase then contains 90% of the Nb, but less than 0.1% of Ta. A second extraction of the ketone phase with fresh acid solution gives a second, smaller Nb fraction of lower purity. A small amount of high-purity Ta remains in the organic phase.

b) When the starting material is Ta_2O_5 or a Ta-rich mixture, the organic phase stemming from the first extraction is shaken with the same volume of an aqueous acid solution which is 4.5 N in H_2SO_4 and 2.8 N in HF, thus removing all of the Nb together with a small amount of Ta. The remaining ketone solution contains most of the Ta (99.9% purity).

Pure Nb or Ta is obtained from the ketone solutions by extraction with pure H_2O . The pentoxide, dissolved in the aqueous (more or less acidic) final solutions, is then precipitated with ammonia.

In special cases or when the starting materials contain a moderate Nb:Ta ratio the procedure can be modified. These modifications are summarized in the following table.

Extraction of Nb and Ta with Methyl Isobutyl Ketone (MIBK)

Extraction system	Optimum extraction for Ta alone (from the aqueous phase)	Optimum extraction for Nb or Nb + Ta (from the aqueous phase)
(HF + HNO_3)/MIBK	0.5 N HF + 1 N HNO_3	7 N HF + 5 N HNO_3
(HF + H_2SO_4)/MIBK	1 N HF + 3 N H_2SO_4	5.6 N HF + 9 N H_2SO_4
(HF + HCl)/MIBK	3 N HF + 3 N HCl or 3 N HF	6.5 N HF + 7.2 N HCl

Alternate methods:

IV. FLUORIDE SEPARATION BY THE METHOD OF MARIGNAC

Fractional crystallization of K_2TaF_7 is accomplished by adding KF to hydrofluoric solutions of Nb and Ta, while K_2NbOF_5 accumulates in the mother liquor. This procedure is more suitable for a large-scale process than the laboratory [O. Hönigschmid and K. Wintersberger, *Z. anorg. allg. Chem.* 219, 161 (1934); C. W. Balke, *Trans. Electrochem. Soc.* 85, 89 (1944); G. S. Savchenko and Ya. V. Tananayev, *Zh. Prikl. Khimii* 19, 1093 (1946); 20, 385 (1947)].

V. TANNIN PRECIPITATION

Small amounts (about 1 g.) of very pure Nb_2O_5 and Ta_2O_5 can be obtained from the corresponding crude oxides via a simple fractional precipitation of oxalate complex solutions with tannin. The procedure is based on the analytical method of Schoeller (1937).

VI. SEPARATION WITH ION EXCHANGERS

The separation of Nb and Ta on an ion exchange column is promising but not yet sufficiently developed. The Nb and Ta products can be obtained in 99% purity from solutions which are 9 M in HCl and 0.05 M in HF [K. A. Kraus and G. D. Moore, *J. Amer. Chem. Soc.* 71, 3855 (1949); E. H. Huffman, G. M. Iddings and R. C. Lilly, *J. Amer. Chem. Soc.* 73, 4474 (1951); J. L. Hague, E. D. Brown and H. A. Bright, *J. Res. Nat. Bur. Standards* 53/4, 261 (1954); P. Münchow, *Chem. Ztg.* 84, 490, 527 (1960)].

PROPERTIES:

Nb_2O_5 : White powder turning yellow on heating; insoluble in aqueous acids other than hydrofluoric. M.p. 1495°C. Crystallizes in various modifications; does not form well-defined hydrates.

Ta_2O_5 : White powder; insoluble in aqueous acids other than hydrofluoric. M.p. 1872°C. Crystallizes in various modifications; forms no defined hydrates.

REFERENCES:

- General: W. R. Schoeller. *The Analytical Chemistry of Tantalum and Niobium*, London, 1937; H. Schäfer. *Angew. Chem.* 71, 153 (1959); G. L. Miller. *Tantalum and Niobium*, London, 1959.
- I. R. F. Weinland and L. Storz. *Z. anorg. allg. Chem.* 54, 223 (1907); H. Schäfer and C. Pietruck. *Z. anorg. allg. Chem.* 264, 106 (1951).

- II. H. Schäfer, L. Bayer and C. Pietruck, *Z. anorg. allg. Chem.* 266, 140 (1951); J. Wernet, *Z. anorg. allg. Chem.* 267, 213 (1952).
- III. K. B. Higbie and J. R. Werning, U. S. Bur. Min. Rep. Invest. No. 5239 (1956); E. L. Koerner, M. Smuts and H. A. Wilhelm, Meeting of Extractive Metallurgy Section of the A.I.Ch.E., Chicago, 1957; G. H. Faye and W. R. Inman, *Canad. Dept. Min. Techn. Surv. Res. Rep. No. MD 210* (1957); J. L. Tews and S. L. May, U. S. Bur. Min. Rep. No. USBM-U-252 (1957); C. W. Carlson and R. H. Nielsen, *J. Metals* 12, 472 (1960).

Alkali Niobates and Tantalates

Either Nb_2O_5 or Ta_2O_5 is heated with an alkali hydroxide or alkali carbonate. Salts of differing composition are obtained, depending on the reactant ratios, the temperature, and workup of the reaction product. Systematic investigation has shown that the system alkali oxide-pentoxide contains a wide range of compounds.

The thoroughly dried starting Nb_2O_5 (or Ta_2O_5) and Li_2CO_3 , Na_2CO_3 or K_2CO_3 are mixed in ratios calculated to give the desired final composition; the mixtures are heated in a crucible at a slowly increasing temperature (e.g., $100^\circ\text{C}/\text{hour}$) to insure a smooth reaction without loss of reactants. The best crucible material is Pt or (particularly for mixtures with high alkali concentrations) an 80% Au, 20% Pd alloy. The temperature is increased to just below the melting point of the mixture and kept at this point several hours; the mixture is then cooled and pulverized. The heating and pulverization are repeated an additional two times. An oxygen atmosphere is maintained over the crucible during the heating to prevent the product from splitting off oxygen.

In the preparation of the meta salts

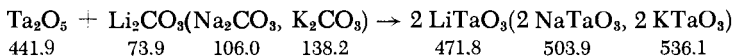
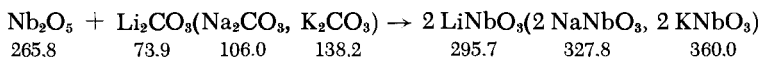

the amount of alkali carbonate may be somewhat greater than that indicated by the 1:1 molar ratio (however, a 2:1 ratio should not be exceeded) and the reaction mixture may be extracted with warm H_2O . The meta salts remain as residues which dissolve only with difficulty. Larger single crystals of the meta salts can be obtained from a KF or KCl melt.

For information concerning polyniobates and polytantalates, see Part III, Section 3.

PROPERTIES:

Colorless, crystalline compounds.

The following phases are known:

 $\text{Li}_2\text{O} - \text{Nb}_2\text{O}_5$:

$3 \text{Li}_2\text{O} \cdot \text{Nb}_2\text{O}_5$ (m.p. 1408°C); $\text{Li}_2\text{O} \cdot \text{Nb}_2\text{O}_5$ (m.p. 1253°C); $\text{Li}_2\text{O} \cdot 4 \text{Nb}_2\text{O}_5$ (m.p. 1231°C , incongruent); $\text{Li}_2\text{O} \cdot 14 \text{Nb}_2\text{O}_5$ (m.p. 1268°C , incongruent).

 $\text{Na}_2\text{O} - \text{Nb}_2\text{O}_5$:

$3 \text{Na}_2\text{O} \cdot \text{Nb}_2\text{O}_5$ (m.p. 997°C); $\text{Na}_2\text{O} \cdot \text{Nb}_2\text{O}_5$ (m.p. 1422°C , polymorphous); $\text{Na}_2\text{O} \cdot 4 \text{Nb}_2\text{O}_5$ (m.p. 1277°C , incongruent); $\text{Na}_2\text{O} \cdot 14 \text{Nb}_2\text{O}_5$ (m.p. 1309°C , incongruent).

 $\text{K}_2\text{O} - \text{Nb}_2\text{O}_5$:

$3 \text{K}_2\text{O} \cdot \text{Nb}_2\text{O}_5$ (m.p. 950°C); $\text{K}_2\text{O} \cdot \text{Nb}_2\text{O}_5$ (m.p. 1039°C , incongruent); $2 \text{K}_2\text{O} \cdot 3 \text{Nb}_2\text{O}_5$ (m.p. 1163°C); $\text{K}_2\text{O} \cdot 3 \text{Nb}_2\text{O}_5$ (m.p. 1234°C , incongruent); $3 \text{K}_2\text{O} \cdot 22 \text{Nb}_2\text{O}_5$ (m.p. 1279°C , incongruent); $6 \text{K}_2\text{O} \cdot 7 \text{Nb}_2\text{O}_5$ and $7 \text{K}_2\text{O} \cdot 6 \text{Nb}_2\text{O}_5$ (metastable, obtainable only by quenching).

 $\text{K}_2\text{O} - \text{Ta}_2\text{O}_5$:

$3 \text{K}_2\text{O} \cdot \text{Ta}_2\text{O}_5$ (m.p. 1330°C); $\text{K}_2\text{O} \cdot \text{Ta}_2\text{O}_5$ (m.p. 1370°C , incongruent); $\text{K}_2\text{O} \cdot 2 \text{Ta}_2\text{O}_5$ (m.p. 1520°C , incongruent); $\text{K}_2\text{O} \cdot 5 \text{Ta}_2\text{O}_5$ (m.p. 1645°C , incongruent).

REFERENCES:

- L. L. Quill. Z. anorg. allg. Chem. 208, 257 (1932); P. Süe. Comptes Rendus Hebd. Séances Acad. Sci. 198, 1696 (1934); P. Süe. Ann. Chimie [11] 7, 493 (1937); F. Windmaisser. Österr. Chemiker-Ztg. 45, 201 (1942); B. T. Matthias and J. P. Remelka. Phys. Rev. (2) 82, 727 (1951); E. A. Wood, Acta Crystallogr. 4, 353 (1951); A. Reisman, F. Holtzberg, M. Berkenblit, M. Berry and E. Banks. J. Amer. Chem. Soc. 77, 2115 (1955); 78, 719, 4514 (1956); 80, 37, 6503 (1958); 81, 1292 (1959).

Peroxyxyniobic and Peroxytantalic Acids

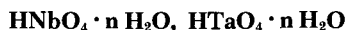
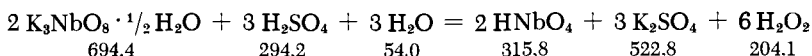
 $\text{HNbO}_4 \cdot n \text{H}_2\text{O}$ 

Sulfuric acid (2 N, 10 ml.) is gradually added to a solution of 2 g. of potassium peroxyxyniobate in 50 ml. of H_2O . The precipitate

formed (caution: this precipitate redissolves readily if there is an excess of sulfuric acid) is filtered off and washed three to four times with H₂O, ethanol and ether. The yield is poor (about 1 g. of peroxyntaibic acid, in the form of a light yellow powder).

HTaO₄ · n H₂O

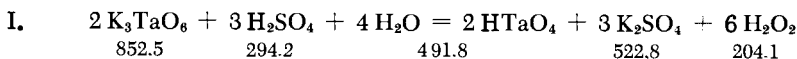

A solution of 2 g. of K₃TaO₈ in 150 ml. of H₂O is prepared and an approximately equivalent quantity of dilute H₂SO₄ added all at once. The nascent precipitate is first centrifuged; it can then be filtered and washed with some H₂O, then with ethanol and ether.

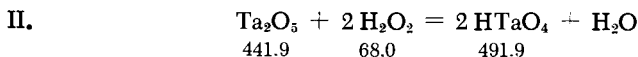

Tantallic acid, freshly precipitated with ammonia from a solution containing 10 g. of K₂TaF₇, is treated with 50 ml. of H₂O and 50 ml. of 30% H₂O₂. The tantallic acid dissolves completely within a few hours, affording a transparent, opalescent liquid. The latter is treated with equal amounts of ethanol and saturated NaCl solution. The mixture, which at first stays clear, slowly deposits out a precipitate of peroxytantallic acid, which is filtered off the next day and dried with ethanol and ether.

PROPERTIES:

White substance. Gelatinous when wet, fine powder when dry. Ta: peroxy oxygen ratio = 1:1.

REFERENCES:

- A. Sieverts and E. L. Müller. *Z. anorg. allg. Chem.* **173**, 297 (1928); P. Melikow and L. Pissarjewsky. *Z. anorg. Chem.* **20**, 344 (1899).

Potassium Peroxyniobate, Potassium Peroxytantalate

K₃NbO₈, K₃TaO₈

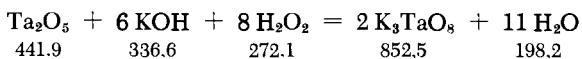
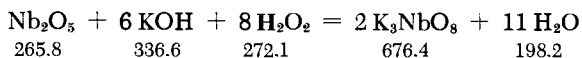

K₃NbO₈ · 1/2 H₂O

I. A mixture of Nb₂O₅ (1 part) and KOH (8 parts) is fused in a silver crucible. The fused mass is dissolved in a minimum of

H_2O , a small amount of H_2O_2 is added and the mixture heated for a short while on the water bath. The solution is filtered to remove the black Ag particles, 9-10 moles of H_2O_2 /mole of Nb_2O_5 is added, and the mixture is precipitated with an equal volume of ethanol. The precipitate is air-dried and washed with ethanol and ether; it is then redissolved in a mixture of three to four moles of H_2O_2 and 0.5 moles of KOH/mole of the Nb_2O_5 reactant and precipitated with 1-1.5 times its volume of ethanol. The precipitate is again dried with ethanol and ether.

II. The fusion step can be avoided by using freshly precipitated niobic acid or potassium niobate instead of Nb_2O_5 . These compounds are dissolved in potassium hydroxide and the workup procedure is the same as that described in method I.

K_3TaO_8

Tantalalic acid $Ta_2O_5 \cdot aq.$ is precipitated with ammonia from a tantalum solution (e.g., that of K_2TaF_7). The precipitate is suction-filtered and washed with a large quantity of H_2O . The gelatinous intermediate, which should not be allowed to age, is added to a solution of 20 g. of very pure KOH in 250 ml. of 3% H_2O_2 (made from "Perhydrol," Merck) until the solution is saturated. Cooling to $0^\circ C$ causes separation of granular peroxytantalate crystals, which are suction-filtered and dried with ethanol and ether or in a vacuum desiccator over H_2SO_4 .

The pure white crystals have a composition corresponding to K_3TaO_8 ; the yield is poor.

$K_3TaO_8 \cdot \frac{1}{2} H_2O$

A mixture of Ta_2O_5 (5 g.) with three times the stoichiometric quantity of KOH is fused in a silver crucible. The product is allowed to cool and is then dissolved in 3% H_2O_2 ; any separated silver is filtered off. The solution is treated first with 20 times the stoichiometric quantity of H_2O_2 and then with an equal volume of ethanol. The precipitated, fine powder of the salt is suction-filtered and dried with ethanol and ether. Yield: 6 g. of pure white $K_3TaO_8 \cdot \frac{1}{2} H_2O$.

REFERENCES:

- A. Sieverts and E. L. Müller. *Z. anorg. allg. Chem.* 173, 297 (1928); C. W. Balke. *J. Amer. Chem. Soc.* 27, 1140 (1905); C. W. Balke and E. F. Smith. *J. Amer. Chem. Soc.* 30, 1637 (1908); P. Melikow and L. Pissarjewsky. *Z. anorg. Chem.* 20, 344 (1899).

Niobium and Tantalum Sulfides

I. FROM THE METALS

In general, the synthesis from the elements gives products of any desired composition. If the reactant ratios correspond exactly to the region in which a phase is homogeneous, the product is pure; otherwise, it is a mixture of phases.

A mixture of about 1-3 g. of solid Nb metal (or, better, Nb filings or powder) and that quantity of vacuum-distilled sulfur which will give the desired product composition is placed in a quartz tube, which is then evacuated. The mixture is heated slowly and then kept at 700-1000°C for two days. Under these conditions, depending on the temperature used, either the high- or the low-temperature modification of a phase is obtained. Special conditions are required for some compounds (e.g., hexagonal NbS_2 : $850^\circ\text{C} < T < 1050^\circ\text{C}$, with the niobium placed in the hottest zone of the ampoule; rhombohedral $\text{Nb}_{1+x}\text{S}_2$: $T > 800^\circ\text{C}$, niobium in the coldest zone of the ampoule).

In no case is the sulfur quantity absorbed greater than that corresponding to the formula NbS_2 . No preparative methods are known as yet for NbS_3 . Traces of this compound are formed during the preparation of other niobium sulfides. The heating of mixtures low in sulfur should be occasionally interrupted, the intermediate product repulverized and remixed, then replaced in the evacuated tube, and the heating continued.

The lower sulfides may also be obtained by homogenization of the corresponding mixtures of niobium sulfide + Nb. In addition, partial degradation of the higher sulfides by distilling off the sulfur in a high vacuum also yields lower sulfides. Another preparative method is based on the reaction of Nb with H_2S at temperatures between 550 and 900°C.

The tantalum sulfides are prepared by procedures based on the same principles. Since the phase relationships are less complicated, one has greater latitude in selecting the preparative conditions. The tantalum sulfide with the highest known S concentration is TaS_3 , which can be obtained at 600°C.

II. FROM THE PENTOXIDES

Either Nb_2O_5 or Ta_2O_5 (2-10 g.) is placed in a loose layer in a porcelain reactor tube and exposed for three to six hours at 960-1300°C to a CS_2 -saturated stream of H_2S ; prior to entering the tube, the latter passes through a purification and drying train, as well as through a wash bottle containing CS_2 at 25-35°C. The reactor must be thoroughly purged of air prior to the run and air leaks must be avoided during the reaction. In particular, the

H_2S must be air-free. The crude sulfides are then extracted with CS_2 to remove traces of precipitated S. The Nb product has the composition $NbS_{1.74}$, the Ta product $TaS_{2.0}$. It appears that no other compositions can be obtained by this method.

PROPERTIES:

The hexagonal NbS_2 and the rhombohedral $Nb_{1+x}S_2$ are blue-black, shiny crystalline compounds: NbS_2 single crystals 0.5 mm. in size can be obtained. The remaining niobium sulfides are dark-gray to black or dark-brown powders devoid of luster.

The TaS_2 consists of microscopically small leaflets, not appreciably volatile in vacuum up to $1100^\circ C$, whereas TaS_3 consists of a mass of loose, feltlike crystalline fibers which are always obtained when other modifications are heated for 14 days at $600^\circ C$. At $650^\circ C$, TaS_3 decomposes rapidly into TaS_2 and sulfur, which dissolves in the TaS_2 . The sulfides are unaffected by hydrochloric acid and sodium hydroxide, but vigorously oxidized by hot concentrated H_2SO_4 or HNO_3 .

Seven phases are known in the Nb-S system: "H-NbS" (temporary general designation, probably comprising two or more phases), hexagonal $Nb_{2-y}S_2$ ($0 < y < 0.3$) and the closely related hexagonal $Nb_1 S_2$ ($0.3 < x < 0.43$), rhombohedral $Nb_{1+x}S_2$ ($0.12 < x < 0.5$), hexagonal NbS_2 , rhombohedral NbS_3 and monoclinic NbS_3 .

REFERENCES:

- Nb-S: W. Biltz and A. Köcher. *Z. anorg. allg. Chem.* 237, 369 (1938); O. Hönigschmid and K. Wintersberger. *Ibid.* 219, 161 (1934); H. Biltz and W. Gonder. *Ber. dtsch. chem. Ges.* 40, 4963 (1907); G. Hägg and N. Schönberg. *Ark. Kemi.* 7, 371 (1954); Hörst Müller. Thesis, Univ. of Freiburg i Br., 1938; F. Jellinek, G. Brauer and H. Müller. *Nature* 185, 376 (1960).
- Ta-S: W. Biltz and A. Köcher. *Z. anorg. allg. Chem.* 238, 81 (1938); H. Biltz and C. Kircher. *Ber. dtsch. chem. Ges.* 43, 1636 (1910); G. Hägg and N. Schönberg. *Ark. Kemi* 7, 371 (1954).

Niobium and Tantalum Nitrides

I. The pure Nb and Ta nitrides are prepared by synthesis from the elements. The reactant metals should be fine powders and should be degassed by heating in high vacuum. The N_2 must be completely free of O_2 and H_2O . With fine metal powders, the reaction temperature should be $1200^\circ C$; with filings or solid metal, it must be 1300 to $1500^\circ C$. Temperatures higher than these naturally increase the nitridation rate; however, because of

equipment limitations, they are employed only in the case in which the metal, in the form of wire, is clamped onto terminals and heated electrically in an N_2 atmosphere.

Hydrides of Nb and Ta can be used instead of the metal. The hydrides lose their hydrogen during the first stages of the reaction, affording an especially reactive, fine metal powder; this, in turn, permits lower reaction temperatures. In addition, very pure NH_3 may be used instead of N_2 . The reaction of the metal with ammonia occurs at a temperature which is usually 300-400°C lower than that required for N_2 .

a) Nitridation of thin metal wire can be achieved at temperatures between 1350 and 2800°C. This procedure, which uses nitrogen under pressure, always yields products with an N content corresponding to the upper limit, NbN. The rates of reaction are high but the amount of obtainable product is obviously small. Products with a low N content can be obtained by shortening the heating period and lowering the N_2 pressure; product homogeneity cannot be guaranteed, however.

b) To obtain nitrides from metal powder, the latter is placed in a sintered alumina boat inserted into a ceramic reactor tube. Because the nitrides are so extremely sensitive to oxygen, completely oxygen-free products can be obtained only if penetration of foreign gases is reduced by using the best, least porous ceramic reactor materials. Even these exhibit some porosity, however. The best method is to insert the reactor tube into another protective tube and fill the annular space between them with very pure N_2 . The products vary in N content depending on the temperature and duration of nitridation, and can range up to NbN or TaN. To achieve high homogeneity and nitrogen contents, the mixture of reactants must be cooled from time to time, removed from the apparatus, reground to a fine powder, and nitridized again.

The best method for obtaining products of a given desired N content is synthesis starting from a homogeneous mixture of highly nitridized materials and metal powder. Such mixtures are homogenized by prolonged calcination at at least 1400°C (high vacuum or Ar atmosphere) with occasional cooling and regrinding of the calcined intermediate product.

II. Less pure niobium nitrides can be obtained from the oxide, carbon and nitrogen:

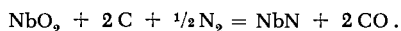

An intimate mixture of NbO_2 and the stoichiometric quantity of ash-free carbon is calcined in a stream of very pure N_2 or NH_3 at 1250°C. The products probably still contain some O and C.

This method is completely unsuitable for the preparation of Ta nitrides because in this case the product contains considerable quantities of O and C.

The nitrides can also be obtained from the oxides and NH_3 , provided the reaction time is sufficiently long.

PROPERTIES:

Dark products with submetallic appearance. Products with a high N content are yellowish-gray or brown, those with a low N content are dark gray. M.p.: NbN about 2000°C , TaN about 2800°C . The N_2 decomposition pressures become appreciable at temperatures exceeding 1400°C . Not attacked by acids. Readily and quantitatively converted to the pentoxides by moderate calcination in the presence of air (this is an analytical method).

The independent phases which exist in the Nb-N system correspond to the compositions $\text{NbN}_{1.00-0.87}$, $\text{NbN}_{0.79-0.75}$ and $\text{NbN}_{0.50-0.40}$; density of these ranges from 8.3 to 8.4.

The independent phases in the Ta-N system correspond to the compositions $\text{TaN}_{1.00}$ (d 13.8) and $\text{TaN}_{0.50-0.40}$ (d 15.4).

REFERENCE:

- I a. K. Becker and F. Ebert. Z. Physik 31, 269 (1925); K. Moers. Z. anorg. allg. Chem. 198, 243 (1931); H. Rögner. Z. Physik 132, 446 (1952).
- I b. C. Agte and K. Moers. Z. anorg. allg. Chem. 198, 233 (1931); G. Brauer. Z. Elektrochem. 46, 397 (1940); F. H. Horn and W. T. Ziegler. J. Amer. Chem. Soc. 69, 2762 (1947); G. Brauer and J. Jander. Z. anorg. allg. Chem. 270, 160 (1952); G. Brauer and K. H. Zapp. Z. anorg. allg. Chem. 277, 129 (1957); R. P. Elliot and S. Komjathy. Columbium Metallurgy Symposium, New York, 1960; G. Brauer and R. Esselborn. Z. anorg. allg. Chem. 309, 151 (1961).
- II. E. Friederich and L. Sittig. Z. anorg. allg. Chem. 143, 308 (1925).

Niobium and Tantalum Phosphides

NbP_2 , TaP_2 , NbP, TaP

These phosphides are prepared by synthesis from the elements, either in a "Faraday apparatus" (see Part I, p. 76) or by

heating a mixture of metal powder and P in an Al_2O_3 crucible. In either case the reactor is a sealed, evacuated quartz tube.

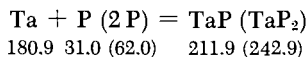
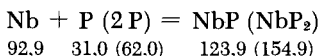

In the "Faraday method," that end of the tube which contains the P is heated to 450-530°C, while that containing the metal is heated first to 750°C and then to 950 to 1100°C.

In the method which uses a mixture, a fast onset of the reaction sometimes leads to explosion of the sealed tube, particularly if the P content of the reactant mixture is high.

The lower phosphides can also be obtained by degradation of products higher in phosphorus. This is done in high vacuum at 650-800°C.

PROPERTIES:

Black to dark-gray substances; fairly resistant to common reagents, vigorous reaction only with conc. H_2SO_4 ; in the case of products high in phosphorus, also with conc. HNO_3 . Completely decomposed by fusion with alkaline oxidizing agents. d: TaP_2 8.4; TaP 10.85.

REFERENCE:

- M. Zumbusch and W. Biltz. *Z. anorg. allg. Chem.* 246, 35 (1941);
A. Reinecke, F. Wiechmann, M. Zumbusch and W. Biltz. *Z. anorg. allg. Chem.* 249, 1 (1942).

Niobium and Tantalum Carbides

- I. a) Pure products must be synthesized from the elements.

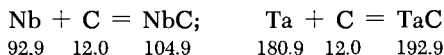

Intimate mixtures of Nb or Ta metal powders (or Nb or Ta hydrides with carbon (as ash-free as possible) are placed in graphite boats or graphite crucibles and heated in a vacuum or in an H_2 atmosphere. Reaction temperatures vary between 1400 and 2100°C. When a tubular carbon furnace is used as the heat source and an H_2 stream as the protective gas, the carbon content of the mixtures should be 15-20% lower than stoichiometric; this is

because the heating causes the H_2 to react with the carbon of the furnace and the boat, and the resultant hydrocarbons supply the additional carbon needed to achieve the desired composition.

An additional purification of the carbide powder can be obtained by sintering (see TiN, p. 1233 f.). For purposes of presintering, the carbide powder is pressed into pellets which are embedded in loose carbide powder to protect them from chemical agents. These pellets are then presintered at a temperature of 2500-3000°C for about 15 minutes. The subsequent high-temperature sintering in argon at above 3000°C produces "self-purification" because of volatilization of impurities.

b) For small quantities of carbides, Nb (or Ta) wire is heated at temperatures exceeding 2500°C in an H_2 atmosphere which contains small amounts of hydrocarbon vapors. The presence of N_2 makes so little difference that up to 80% of the H_2 may be replaced by N_2 . Suitable hydrocarbons are toluene, methane and acetylene. The nascent carbides formed may lose carbon at the high temperatures if the CH_4 content of the gas is less than about $1/4\%$, or that of C_2H_2 is less than about $1/8\%$.

II. The carbides can also be obtained by reacting the oxide with carbon.

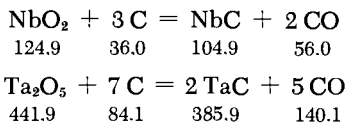

The respective powder mixtures, in Mo or carbon boats, are reacted at 1250-2300°C in an H_2 stream. At 2300°C, a one-hour heating is recommended. When carbon tubes or boats are used as in method Ia, the mixture may be less than stoichiometric with respect to carbon. The products may be further purified via the above-cited sintering.

Alternate methods: Crystal growing procedures.

a) A carbon fiber is resistance-heated to above 2000°C with current. The fiber is in a "reaction lamp," which also holds thoroughly degassed $TaCl_5$ (this process cannot be used with Nb). The quantity of $TaCl_5$ needed is difficult to measure out (also, with excess chloride, free metal or lower carbides are formed on the incandescent fiber). At any rate, this process may be followed by carbidization in the presence of H_2 and a hydrocarbon vapor [W. G. Burgers and J. C. M. Basart, *Z. anorg. allg. Chem.* 216, 207 (1934)].

b) Carbide may also be deposited on a tungsten wire exposed at 1900-2300°C and 0.1 mm. Hg to an H_2 carrier gas containing small amounts of $TaCl_5$ ($NbCl_5$) and toluene vapor. However, this

carbide product will contain a large amount of free metal and must be subjected to a postcarbiding treatment [K. Becker and H. Ewest, *Z. techn. Physik* 11, 148 (1930); K. Moers, *Z. anorg. allg. Chem.* 198, 243 (1931)].

c) According to a patent [D. Gardner, U.S. Patent 2,532,295 (1946/50)], the pentachlorides can be reacted with H_2 and carbon derivatives such as CCl_4 or CaC_2 even at 600 to 700°C.

LOWER CARBIDES

Most preparative methods describe the synthesis of carbides of the limiting composition NbC and TaC. However, method I (or, if properly executed, also the above-described crystal growing procedure) also gives products with a low C content, e.g., products corresponding to the lower carbides Nb_2C (and Ta_2C).

PROPERTIES:

Iron-gray to dark-gray powders; the sintered solid exhibits a bright metallic luster; tarnishing frequently changes the surface color to brown to yellow. Does not lose carbon at high temperatures in the presence of hydrogen, provided a small amount of hydrocarbons is present in the gas (see method Ib). Stable to N_2 up to about 3300°C. Quite sensitive to O_2 and H_2O on heating, undergoing rapid oxidation above 800°C in air. Not very volatile in high vacuum up to 3000°C.

NbC: m.p. 3500°C; d 7.6.

TaC: m.p. 3900°C; d 13.9.

REFERENCE:

- Ia. C. Agte and K. Moers. *Z. anorg. allg. Chem.* 198, 233 (1931); G. Brauer, H. Renner and J. Wernet. *Z. anorg. allg. Chem.* 277, 249 (1954); G. Brauer and R. Lesser. *Z. Metallkunde* 49, 622 (1958); 50, 8 (1959); E. K. Storms and N. H. Krikorian. *J. Phys. Chem.* 63, 1747 (1959); R. P. Elliott. A.S.M. Preprint No. 179 (1960).
- Ia, b. K. Becker and H. Dwes. *Z. techn. Physik* 11, 148 (1930).
- II. E. Friederich and L. Sittig. *Z. anorg. allg. Chem.* 144, 169 (1925); C. Agte and K. Moers. *Z. anorg. allg. Chem.* 198, 233 (1931); A. Y. Kovalskiy and Y. S. Umanskiy. *Zh. Fizich. Khimii* 20, 769 (1946); *Chem. Zentr.* 47, II, 1546.

Chromium, Molybdenum, Tungsten, Uranium

F. HEIN and S. HERZOG

Chromium

Cr

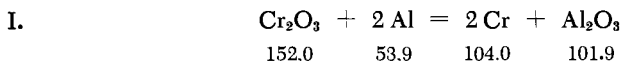

An intimate mixture of 70 g. of pure ignited Cr_2O_3 , 33 g. of Al granules (or Al powder), and 25 g. of fused and powdered $\text{K}_2\text{Cr}_2\text{O}_7$ is placed in a clay crucible whose bottom is covered with 10 g. of CaF_2 . The mixture is caused to react by means of ignition mixture and a strip of Mg.* After cooling, the contents of the crucible are broken up, and the spheres of metal are mechanically extracted. This gives about 99% pure chromium metal in 50-75% yield (the larger the quantity of reactants, the better the yield).

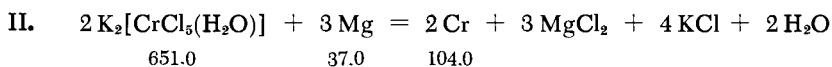

The $\text{K}_2[\text{CrCl}_5(\text{H}_2\text{O})]$ is obtained by dissolving 100 g. of $\text{K}_2\text{Cr}_2\text{O}_7$ in the minimum quantity of water, treating the solution with 400 ml. of HCl (d 1.124), and gradually adding 100 ml. of 80% alcohol. The reaction is accompanied by vigorous evolution of heat. Then, 170 g. of KCl is added and completely dissolved, the mixture filtered, and the filtrate evaporated to dryness. The mass is then completely dehydrated by further heating. The resulting violet solid is then

*The ignition mixture, called "Zündgemisch" or "Zündkirsche" (igniting cherry), consists of an intimate mixture of 15 parts by weight of barium peroxide and 2 parts of powdered magnesium metal held together with collodion. The whole is wrapped in magnesium ribbon, which acts as fuse (H. Blücher, *Auskunftsbuch für die chemische Industrie* [Data Book for the Chemical Industry], 18th ed., de Gruyter, Berlin, 1954, p. 1314).

ground, and any green portions are removed as completely as possible. The potassium chromium (III) chloride thus obtained is mixed with 50 g. of Mg filings. The mixture is placed in a covered Hessian crucible, brought to red heat and held at this temperature for one half hour. However, not all of the KCl must be allowed to volatilize, otherwise a fraction of the Cr will be converted to the oxide and will contaminate the product. After this calcination, the crucible is cooled and broken. The shards and the particles of green chromium oxide, which appear on the surface of the gray-black melt, are removed. The mechanically cleaned mass is then placed in water, where it crumbles to a powder. The soluble salts are removed by decantation. The residue is boiled with dilute nitric acid to remove the excess Mg (and the MgO which has formed from it).

Any $\text{Mg}(\text{NO}_3)_2$ and excess acid present are separated by further decantation; filtration is not recommended because of the fine particle size of the metal. The Cr residue is dried on a steam bath. Yield about 27 g. of light-gray, microcrystalline powder whose Cr content is 99.6%.

III. ELECTROLYSIS

The electrolytic cell consists of a beaker with a copper cathode rod suspended in the center. A lead sheet or a coil of lead tubing placed along the wall of the cell serves as the anode; if the latter arrangement is used, cold water is circulated through the tubing. The electrolyte consists of a solution of 240 g. of CrO_3 , 3 g. of $\text{Cr}_2(\text{SO}_4)_3 \cdot 12 \text{H}_2\text{O}$, and 8.8 g. of $\text{Cr}(\text{OH})_3 \cdot 3 \text{H}_2\text{O}$ in one liter of water. A current density of 0.10 amp./cm.² and a potential of 3.2 volts are used. It is essential that the electrolyte remain undisturbed (no stirring) during electrolysis. The thick layer of Cr which forms on the cathode in a few days is readily stripped off. If it should prove necessary to remove the H_2 which accumulates in the metal voids during deposition of the Cr, the product should be heated to 600°C in high vacuum.

IV. Ductile Cr is obtained from CrCl_3 and Ca in a steel bomb under argon. For details of the method, see section on Titanium, p. 1161.

PROPERTIES:

Atomic weight 52.01. Solid Cr has a silvery luster; very hard and brittle, but very pure Cr is ductile. M.p. about 1920°C (in vacuum), b.p. about 2200°C; d^{25} 7.138. Body-centered cubic crystals; hexagonal form also exists.

REFERENCES:

- I. G. Jander, Lehrbuch für das anorg. chem. Praktikum [Text-book of Inorg. Chem. Practice], 5th ed., 1944, p. 188.
- II. H. Funk. Darst. der Metalle im Laboratorium [Preparation of Metals in the Laboratory], Stuttgart, 1938, p. 66.
- III. Private communication from Prof. G. Grube. See H. Haraldsen and E. Kowalsky. Z. anorg. allg. Chem. 224, 330 (1935).
- IV. W. Kroll. Z. anorg. allg. Chem. 226, 23 (1935).

Chromium (II) Chloride

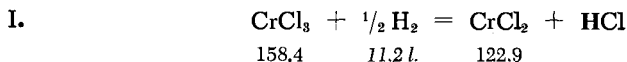

The special vessel (2.5 × 50 cm., Fig. 313) used for the reduction is made of high-melting glass. For reasons of safety it is first baked in vacuum at 500°C while empty. It is provided with a two-hole rubber stopper, through which the outlet tube *a* and the longer inlet tube *b* (8-mm. diameter) are inserted. The reactor is charged with CrCl₃ (prepurified by sublimation in a stream of Cl₂). The tube is heated to 500°C in a thermostatically controlled electric

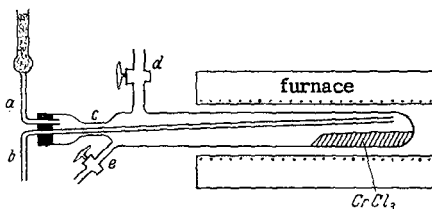
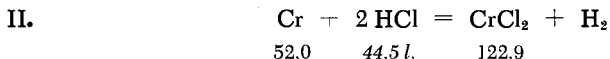

Fig. 313. Preparation of chromium (II) chloride. *b* inlet tube for hydrogen, H₂-HCl mixture, or nitrogen; *d* stopcock with 10-mm. bore for withdrawal of reaction product.

furnace, while a mixture of H₂ and HCl (the latter serving to hinder any further reduction to Cr) is admitted through *b* (the dry, O₂-free, 50 ml./min. gas streams are mixed in a tee prior to introduction into the apparatus). The outlet tube *a* is connected to a drying tube filled with CaCl₂. To test for completeness of reduction, the furnace is removed briefly from time to time (pure CrCl₂ is white). When

the reaction is complete, the furnace is cooled, the H₂-HCl mixture displaced with dry N₂ or CO₂, and the inlet tube pulled back until its tip is at the rubber stopper. The reactor tube is then melt-sealed at constriction *c*. Any required quantity of CrCl₂ can be shaken out of the tube through the 10-mm.-bore stopcock *d*; in this operation, the CrCl₂ must always be under dry, O₂-free inert gas, which is admitted through stopcock *e*. (For special apparatus for storage under inert gas, see also Part I, pp. 71 and 75.)



A small porcelain boat is charged with pea-sized pieces (or, better, powder) of metallic Cr and inserted in a quartz reactor tube. Dry, O₂-free HCl is passed through the tube, which is heated to as high a temperature as possible (1150 to 1200°C). On cooling in the HCl stream, an asbestoslike mass of white (or, if impure, gray) crystalline needles of CrCl₂ is obtained. Because of its toughness, the mass is very difficult to remove from the boat. The preparation must be sealed as rapidly as possible into a sample tube filled with N₂ or CO₂; if this is not done, the anhydrous CrCl₂ is rapidly hydrated by atmospheric moisture, after which oxidation also occurs at once. Because of its high melting point, some metal may be trapped within the chloride and thus remain unreacted.

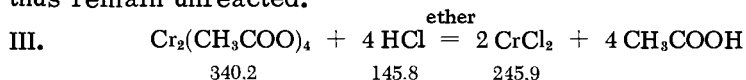

Ten grams of fine chromium (II) acetate hydrate Cr₂(CH₃COO)₄ · 2 H₂O crystals is dehydrated in a three-neck flash at 110 to 120°C (aspirator vacuum); the color changes from brick-red to brown. Then, 60 ml. of air-free ether is added and dry HCl is passed through the vessel with the suspension (the vessel is in an ice bath and is protected against atmospheric moisture by a P₂O₅ tube). After several minutes, a violet color is observed in the solution, and the chromium acetate powder is transformed (with an increase in bulk) into chromium (II) chloride which still contains some acetic acid. The flask is swirled during this operation to prevent clogging of the inlet tube. The white crystals are filtered in the absence of air, washed with absolute, air-free ether, and dried at 110 to 120°C. The acetic acid is thus eliminated, and pure white, analytically pure CrCl₂ is obtained as a residue. Yield 4-5 g.

PROPERTIES:

White crystals or fused, fibrous mass. M.p. 824°C; d_4^{14} 2.751. Very hygroscopic. Can be sublimed in vacuum. Dissolves readily in water, giving a sky-blue solution.

REFERENCES:

- I. J. Reschke. Thesis, Univ. of Leipzig, 1925, p. 43; F. Hein. Z. anorg. allg. Chem. **201**, 314 (1931); F. Ephraim. Helv. Chim. Acta **17**, 291 (1934); A. B. Burg in: L. F. Audrieth. Inorg. Syntheses, Vol. III, New York-Toronto-London, 1950, p. 150.
- II. J. Koppel. Z. anorg. Chem. **45**, 361 (1905); W. Biltz and E. Birk. Z. anorg. allg. Chem. **134**, 134 (1924); W. Fischer. Z. anorg. allg. Chem. **222**, 309 (1935); H. Hecht. Präparative Anorganische Chemie [Preparative Inorganic Chemistry], Berlin-Göttingen-Heidelberg, 1951, p. 80.
- III. Private communication from F. Hein, E. Kurras and W. Kleinwächter (unpublished).

Chromium (III) Chloride

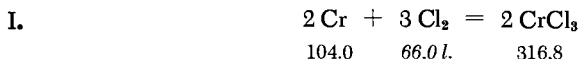

Coarse Cr metal powder (10-20 g.) is placed in a 50-cm.-long and 3-cm.-I.D. horizontal porcelain reactor tube, which is heated in a blast lamp flame. It is essential that all residual air be displaced by a fast stream of completely dry Cl_2 (for at least half an hour prior to introduction of the Cr). The temperature is then raised as high as possible; the tube is allowed to cool, and the Cl_2 is displaced with dry CO_2 . Violet leaflets of CrCl_3 form, with a large increase in volume (to avoid plugging the tube as a result of this volume increase, the Cr reactant should be distributed over a long stretch of the tube).

The CrCl_3 is purified by sublimation in the stream of Cl_2 , then repeatedly boiled with conc. HCl , washed with distilled water until disappearance of chloride reaction, and dried at 200 to 250°C.

The high sublimation temperature of over 1200°C is a disadvantage of this method. Under certain conditions the porcelain tube can be markedly corroded in this operation and, in addition, it may be plugged as a result of the large volume increase occurring during the formation of the chromium (III) chloride. The following method, in which green chromium (III) chloride hydrate is dehydrated in a stream of CCl_4 at 600°C, avoids these difficulties.

II. OVERALL EQUATION :



SIDE AND INTERMEDIATE REACTIONS:

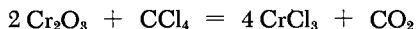
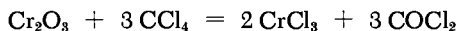
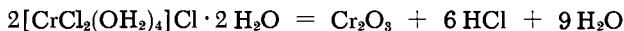

Thus, one by-product is phosgene, which must be carefully vented (use a hood!). Simple absorption in water is not adequate, since the hydrolysis is not instantaneous.

The apparatus is shown in Fig. 314. Forty grams of green chromic chloride is placed in quartz flask *c*, which is placed in an electric furnace capable of delivering 650°C. The apparatus for generating and superheating CCl₄ vapor is then attached. This apparatus consists of the 250-ml. distilling flask *a* with its superposed dropping funnel and a U tube immersed in a silicone oil bath at 150°C.

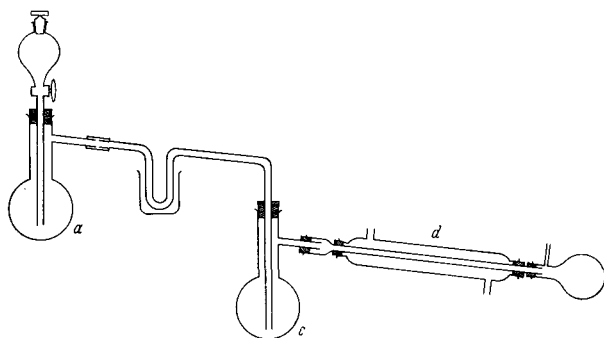

Fig. 314. Dehydration of chromium (III) chloride hydrate with carbon tetrachloride.

After brief heating of the furnace (flask temperature of 100-150°C), one drop of CCl₄ per second is admitted from the dropping funnel into flask *a*, which is heated with a Bunsen burner in such a manner that each drop vaporizes at once. After some time (furnace temperature of about 300°C), a mixture of water, CCl₄, etc., distills over. It condenses in *d*; the noncondensing gases (including phosgene) are vented through the hood. After some two hours of reaction, when the furnace temperature has reached 650°C, the gas stream is interrupted and the apparatus allowed to cool. The anhydrous CrCl₃ remains in the flask in about 90% yield (some of it sublimes). The lustrous violet crystalline leaflets are extracted with boiling dilute HCl and dried. About 20 g. of chromium (III) chloride is obtained.

PROPERTIES:

Formula weight 158.38. Red-violet crystalline scales with metallic luster. M.p. $\sim 1150^\circ\text{C}$. May be sublimed in Cl_2 stream; rate of solution in water, acids and organic solvents immeasurably slow. Addition of a very small amount of CrCl_2 aids in rapid solution of CrCl_3 in water or alcohol.

REFERENCES:

- I. Private communication from H. Hecht, Greifswald; F. Hein. Z. anorg. allg. Chem. 201, 314 (1931).
- II. G. B. Heisig, B. Fawkes and R. Hedin in: W. C. Fernelius, Inorg. Syntheses, Vol. II, New York-London, 1946, p. 193; A. Vavoulis et al. *Ibid.*, Vol. VI, New York-London, 1960, p. 129.

Chromium (II) Bromide

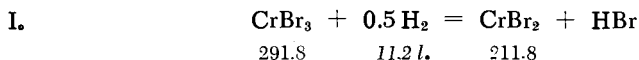

A weighed quantity of CrBr_3 is reduced to constant weight in a U tube at $350\text{--}400^\circ\text{C}$ for 6-10 hours. The most painstaking purification of the H_2 is essential for success. For uniform heating, the U tube is surrounded with an asbestos box.

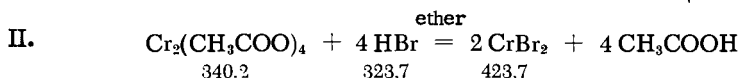

The procedure is the same as for chromium (II) chloride (method III), but hydrogen bromide is used instead of hydrogen chloride.

PROPERTIES:

White crystalline powder; d_4^{25} 4.356. Soluble in air-free water, yielding a blue color. Rapidly oxidized in air.

REFERENCES:

- I. W. Biltz and E. Birk. Z. anorg. allg. Chem. 134, 134 (1924); W. Fischer and R. Gewehr. *Ibid.* 222, 309 (1935).
- II. Private communication from F. Hein, E. Kurras and W. Kleinwächter (unpublished).

Chromium (III) Bromide

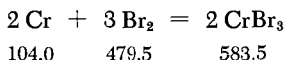

Electrolytic Cr powder is spread in a thin layer in a quartz reactor tube and bromine vapor, predried over P_2O_5 , is passed over the Cr in a stream of O_2 -free, dry N_2 or Ar. The quartz tube is heated to about 1000°C , whereupon the two elements combine with incandescence at the beginning of the reaction. The unconverted Br_2 is condensed in a receiver cooled in ice-salt mixture. After 45-60 minutes, the material is allowed to cool while maintaining the gas stream. The lustrous black, leafy crystals of CrBr_3 are purified by several extractions with absolute ether and decantations with ice water (to remove traces of adhering CrBr_2). This is followed by washing with absolute alcohol and ether; the product is dried in a vacuum desiccator over P_2O_5 .

PROPERTIES:

Formula weight 291.76. Black lustrous crystals, green in transmitted and reddish in reflected light. Soluble in water only upon addition of Cr (II) salts.

REFERENCES:

J. Reschke. Thesis, Univ. of Leipzig, 1925; F. Hein and I. Wintner-Hölder. Z. anorg. allg. Chem. 201, 319 (1931).

Chromium (II) Iodide

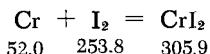

The starting materials are electrolytic Cr reduced to the size of millet seed and I_2 resublimed over KI (see p. 277). The apparatus is shown in Fig. 315. The quartz reactor tube *a* has an overall length of about 56 cm. and an I.D. of 2 cm. (2.5 cm. at the bulged-out section). The tube ends (on the right side of the drawing) in a quartz capillary spiral which is somewhat constricted at *q*; on the opposite side, it can be closed off by a large-diameter ground joint connected to stopcock h_1 . The cooling trap *k* is

connected via stopcock h_2 to a tee adapter; thus, it can be in line either with the high-vacuum system (via stopcock h_3) or with the two-way stopcock z , which in turn leads either to the N_2 source or to a vacuum oil pump.

The movable tubular resistance furnace o serves to heat the quartz reactor at any desired spot.

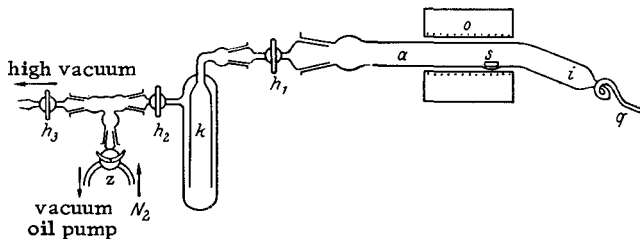

Fig. 315. Preparation of chromium (II) iodide.
 a quartz reactor tube; s boat with Cr; o electric furnace; k cold trap.

First, a trace of very fine Cr powder is placed in the tip of the capillary spiral, and then I_2 (10% excess over the stoichiometric quantity) is placed in the slightly inclined tube section i . A small porcelain boat with the Cr is placed in the bulge s . Trap k is now cooled to $-80^\circ C$ and the apparatus is evacuated (with stopcock z closed) to < 0.001 mm.

The vacuum is then broken with N_2 and the evacuation repeated (this procedure is repeated 3 or 4 times). Stopcock h_1 is closed and the Cr powder at the tip of the spiral is heated with a torch to a bright red glow to bind the last traces of O_2 . Then the tube furnace is set in place over spot s and the Cr heated at 700 to $850^\circ C$; to minimize undesirable heat losses, asbestos paper (not shown in the figure) is placed in both furnace openings. As the I_2 now diffuses slowly toward the Cr, the nascent CrI_2 solidifies as a crystalline mass at both sides of the tube protruding from the furnace. This slow procedure yields very beautiful leaf- or needle-shaped red-brown to iodine-colored crystals. At the beginning of the iodination, a deep-black coating always forms on the colder portions of the tube; this material is more volatile than CrI_2 and converts to CrI_2 at higher temperatures, evolving iodine. Even though the CrI_2 itself is not particularly volatile, the crystal deposit extends on both sides for up to 2 cm. beyond the hot zone. By gradually shifting the furnace, the crystalline deposit is shifted away from the spot where the Cr is situated; in this way, one prevents it from becoming too dense and provides a surface for fresh deposition. By following this procedure, almost all the I_2 is introduced little by little, with the long heating producing a type of resublimation

and yielding beautiful single crystals. Such a run takes 8-14 days; some unreacted metal is still invariably found after this time at the bottom of the boat, because the sublimation of CrI_2 from the (protective) melt is very slow. When the iodination has proceeded as far as possible, the excess I_2 must be displaced before the CrI_2 itself can be removed. Thus, the reactor is connected to the high vacuum (via h_3), with the cold trap at -80°C . The I_2 is driven off by careful fanning with a flame ($250\text{--}300^\circ\text{C}$) and continuous evacuation. Evacuation is continued after complete removal of the I_2 until the quartz tube is cool; the apparatus is then closed off at h_1 .

Transfer of the CrI_2 from the reactor requires great care, since the compound is extremely sensitive to air and moisture. Further, the solid material possesses a relatively large surface. The following procedure is the safest: The vacuum is broken with compressed N_2 via h_1 , and pressure above atmospheric is created in the apparatus. The quartz capillary is then broken off at q and this opening is attached to another N_2 connection. The

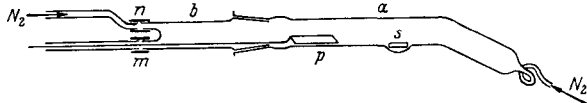

Fig. 316. Transfer of chromium (II) iodide following its preparation. *a* reaction tube of Fig. 315; *p* porcelain boat with front wall broken off (scoop).

joint with h_1 is then removed and the adapter tube *b* is inserted in its place, as shown in Fig. 316 (an N_2 stream also passes through *b*). The adapter carries at one end the same standard taper joint as h_1 , and at the other end two short connectors *m* and *n*. An N_2 stream enters at *n*; a long glass rod, the forward end of which is bent into a small hook, is introduced through *m*. This hook supports a fairly large porcelain boat *p*, whose front wall is broken off at a sharp angle. The boat is of such a size that it is still able to move in the quartz reactor. Now, with the fast N_2 stream always maintained, this "dredge" is pushed forward through the loose crystal aggregate, whereupon most of the latter drops into boat *s*. This operation is aided by gentle tilting and tapping of the reactor. The filled boat *s* is now pulled back into the adapter *b*; the adapter is quickly detached from the reactor and closed off with a ground cap. Finally the boat with the CrI_2 is transferred for storage into a tube provided with a ground joint (see Part I, p. 75); as a precaution, this tube is evacuated several times and then filled with N_2 (slight gage pressure). All of these operations must be carried out in sequence and without undue delay.

PROPERTIES:

Brown-red leaflets; thin leaflets are somewhat transparent, thick crusts often have an iodinelike color. Very sensitive to air and moisture, easily soluble, with bright blue color, in air-free water. M.p. 790–795 °C; d_{20}^{20} 5.02₃.

REFERENCE:

F. Hein and G. Bähr. Z. anorg. allg. Chem. 251, 241 (1943).

Chromium (III) Iodide

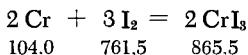

The apparatus (Fig. 317) is made of high-melting glass. The diameter of the tube at *e*, *f* and *h* is 25–30 mm. Three grams of fine chromium metal powder (electrolytic chromium is best) is introduced into *e*, and an excess (30 g.) of iodine into *h*. Then *k* is sealed off and the apparatus is evacuated to appr. 10^{-5} mm. (with occasional gentle heating). The iodine is now sublimed into *f* by cooling the latter section (Dry Ice) and heating *h* (during this operation stopcock *b* is turned off and on). Following this, *g* is sealed off in high vacuum, and then *d* is sealed off as well.

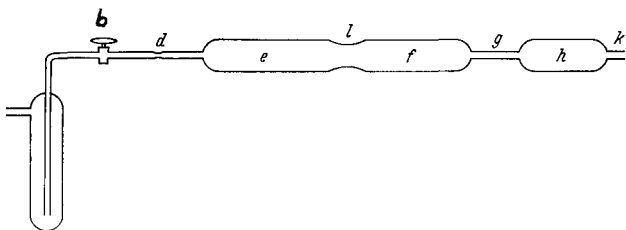

Fig. 317. Apparatus for synthesis of chromium (III) iodide.

Now sections *e* and *f* are enclosed in separate tubular furnaces; *e* is heated for 24 hours at 475 °C, and *f* for the same period at 225 °C. (The vapor pressure of iodine at this temperature is approximately 3 atm.) The apparatus is then allowed to cool, and the unreacted iodine is sublimed out from *e* (which is held at 100 °C) into *f* (held at room temperature). The tube is then broken, in dry

air, at constriction *l* (careful!). The material is transferred to a suitable storage vessel, which is then evacuated for some time to remove the last traces of iodine. The yield is almost quantitative.

If necessary, further purification may be achieved by heating for several hours at 500°C in an evacuated quartz tube. This operation yields chromium (II) iodide; the iodide can be sublimed in vacuum at 700°C and finally reiodinated as described above.

PROPERTIES:

Black crystals; dissolve rapidly in water upon addition of some Cr (II) iodide. Stable at room temperature; thermally dissociated at higher temperatures according to: $2 \text{CrI}_3 = 2 \text{CrI}_2 + \text{I}_2$. The iodine pressure reaches 1 atm. at about 670°C.

REFERENCES:

- L. L. Handy and N. W. Gregory. *J. Amer. Chem. Soc.* **72**, 5049 (1950); N. W. Gregory and L. L. Handy in: T. Moeller, *Inorg. Syntheses*, Vol. V, New York-Toronto-London, 1957, p. 128.

Chromium (III) Hydroxide

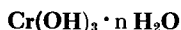

I. A-HYDROXIDE $\text{Cr}(\text{OH})_3 \cdot 3 \text{H}_2\text{O}$

A solution of 12 g. of gray-blue $[\text{Cr}(\text{H}_2\text{O})_6]\text{Cl}_3$ (for preparation, see p. 1348 f.) in 500 ml. of water is treated with 100 ml. of 2 N ammonia. After settling of the precipitate (centrifuge if necessary), the mother liquor is decanted; the suspension is filtered through a leaf filter, thoroughly washed until free of NH_4Cl , and dried in air.

PROPERTIES:

Bright blue-green powder; gives blue salts of the $[\text{Cr}(\text{H}_2\text{O})_6]\text{X}_3$ type with dilute acids.

B-HYDROXIDE $\text{Cr}(\text{OH})_3 \cdot 3 \text{H}_2\text{O}$

The procedure for the preparation of the A-hydroxide is followed, but one starts with 12 g. green of $[\text{CrCl}_2(\text{H}_2\text{O})_4]\text{Cl} \cdot 2 \text{H}_2\text{O}$.

PROPERTIES:

Dark blue-green powder; gives green salts of the $[\text{Cr}(\text{H}_2\text{O})_4\text{X}_2]\text{X} \cdot 2 \text{H}_2\text{O}$ type with dilute acids. In contrast to the A-type, the B-hydroxide is insoluble in acetic acid.

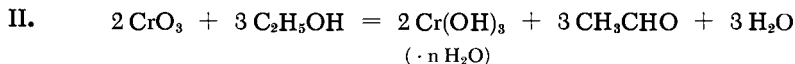

This is a convenient method for preparation of larger quantities of Cr(OH)₃. A solution of 160 g. of CrO₃ in 2 liters of water is prepared and alcohol (8 portions of 10 ml. at 5-minute intervals) is added with vigorous stirring (caution: a hood is needed!). After 4 hours of standing, an additional 80 ml. of alcohol is added in the same manner. The mixture is then refluxed for 16 hours (stirring is required to avoid bumping). The finely divided, dark brown precipitate is filtered through a 24-cm.-diameter Büchner funnel and dried at 110°C without washing. Yield: 145 to 150 g. Additional quantities (30-35 g.) can be recovered from the filtrate by concentration of the latter. Alternately, the Cr-containing liquid may be used as solvent (instead of water) in the next run.

PROPERTIES:

This method affords a black product with a pitchlike luster, probably because of a small admixture of higher oxides. This material has a higher catalytic activity than that obtained by precipitation.

REFERENCES:

- I. A. Hantzsch and E. Torke. *Z. anorg. allg. Chem.* **209**, 73 (1932).
- II. R. F. Ruthruff in: W. C. Fernelius, *Inorg. Syntheses*, Vol. II, New York-London, 1946, p. 190.

Chromium Sulfides



I.

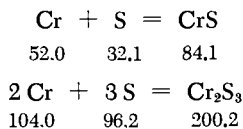

The sulfides are prepared by heating exact stoichiometric mixtures of electrolytic Cr (for preparation, see p. 1335) and pure S for 24 hours in small, evacuated, sealed quartz tubes placed in an electric furnace at 1000°C. All of the S does not react even if heated for 3-4 days and slowly cooled. The product is freed of unreacted sulfur by fanning with a Bunsen flame while simultaneously cooling the empty seal-off point of the tube. The

quantity of S which condenses in that section is determined by reweighing, and the composition of the sulfide is calculated by using this value.

Cracking of the quartz tube during cooling of preparations which are high in S can be avoided by sealing the reaction vessel proper in a second, similarly evacuated quartz tube.

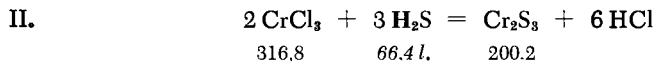

Exactly stoichiometric Cr_2S_3 may be obtained by heating CrCl_3 in a stream of H_2S at 600-650°C.

PROPERTIES:

The chromium sulfide preparations obtained via method I have a metallic appearance and become fused at the temperature of preparation. The CrS possesses a hexagonal superstructure of the B 8 type, while at 59.7 atom % of S, a B 8 structure with the axial ratio $c/a = 1.625$ has been shown to exist. The Cr_2S_3 obtained by method II consists of hexagonal black leaflets, resistant to non-oxidizing acids, easily soluble in HNO_3 .

REFERENCES:

- I. H. Haraldsen and E. Kowalsky. *Z. anorg. allg. Chem.* 224, 331 (1935); H. Haraldsen and A. Neuber. *Ibid.* 234, 338 (1937).
- II. W. Rüdorff and E. Stegemann. *Z. anorg. allg. Chem.* 251, 390 (1943).

Chromium Nitride

CrN



Electrolytic chromium powder is heated for 2 hours at 800-900°C in a quartz or porcelain tube while a dry, O_2 -free stream of N_2 is passed through. After cooling, the product is ground in an agate mortar and calcined again for 2 hours in a stream of N_2 . The final product is treated with HCl until nothing further dissolves (the HCl liquid remains colorless). The black residue is thoroughly washed and dried.

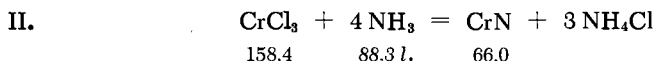

A tube of high-melting glass (25-30 cm. long) is used and 5-10 g. of anhydrous CrCl_3 is calcined, first gently and then vigorously, in a stream of NH_3 . The heat source is a series of burners. The NH_3 is obtained either from a bomb or by heating about 300 ml. of conc. ammonia; it is dried by passage through a lime tower and a large U tube filled with CaO . The reactor tube carries no outlet tube, since the latter would be plugged by sublimed NH_4Cl (use a hood!). Strong heating is continued until no further NH_4Cl vapor is evolved; then (after cooling) the product is ground and recalced in a stream of NH_3 . The yield is almost quantitative.

If it is desired to remove traces of CrCl_3 , the product is extracted in the cold with some dilute HCl (add some Sn), then washed with water, filtered and dried at 100-120°C.

PROPERTIES:

Black, magnetic powder; insoluble in acids and alkalis; d 5.9. Crystal structure: NaCl type.

REFERENCES:

- I. F. Briegleb and A. Geuther. *Liebigs Ann.* **123**, 239 (1862); R. Blix. *Z. phys. Chem. B* **3**, 236 (1929).
- II. H. Biltz and W. Biltz. *Übungsbeispiele aus der unorg. Experimentalchemie* [Exercises in Experimental Inorganic Chemistry], 3rd and 4th eds., 1920, p. 20.

Hexaquo chromium (III) Chloride

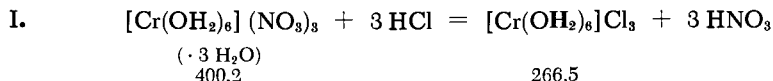

A solution of 100 g. of chromium (III) nitrate $\text{Cr(NO}_3\text{)}_3 \cdot 9 \text{H}_2\text{O}$ in 100 ml. of H_2O and 100 ml. of 38% HCl is prepared. Hydrogen chloride gas, predried in H_2SO_4 , is introduced with ice cooling, until the precipitation of $\text{[Cr(H}_2\text{O)}_6\text{]Cl}_3$ is complete.

The crystal slurry is rapidly filtered on a large glass suction funnel and washed with some fuming HCl . It is dissolved in 100 ml. of water and 100 ml. of fuming HCl , and reprecipitated with HCl gas while cooling in ice. After precipitation is complete, the

greenish supernatant solution is decanted and the gray-blue chloride is freed of most of the adhering HCl and the green chloride by stirring three times with acetone. The remaining impurities are completely extracted by treating the product with small quantities of acetone on a fritted-glass funnel (the filtrate must become colorless in the end). The acetone is removed by rinsing with absolute ether. The salt is freed of ether and traces of moisture by drying in a desiccator over H_2SO_4 . The yield is about 72%.

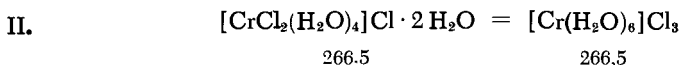

A solution of 50 g. of green chromium chloride hydrate in 50 g. of water is refluxed for one half hour, during which time almost no color change is observed. The flask is then cooled by immersion in an ice-salt mixture and HCl gas is introduced with periodic shaking of the flask. The temperature inside the flask must always be held below 0°C ; this is achieved by frequent renewal of the freezing mixture. After saturation with HCl, the fine powder which separates is allowed to settle to the bottom and the supernatant blue-green liquid is decanted. The powder itself is rinsed out of the flask onto a fritted glass funnel with cold saturated HCl, dried as much as possible by suction, then stirred with acetone and washed until the acetone is no longer green. As soon as the acetone traces have evaporated, the crude product is dissolved in 20 ml. of water; it is filtered if necessary, and HCl gas is introduced into the blue solution (while cooling the flask with cold water) until saturation. At this point the gas flow is interrupted and the flask is placed in finely crushed ice. The solution becomes almost colorless after some time while the chloride separates in granular, blue-gray crystals. After filtering through a fritted-glass funnel, the product is washed with acetone and dried over H_2SO_4 . Yield: 12 g.



Chrome alum (250 g.) is dissolved in a chilled mixture of 1 liter of conc. hydrochloric acid and 250 ml. of water. The solution is filtered and saturated with hydrogen chloride gas at 10 to 15°C . It becomes almost colorless during this step, and the crude product separates in crystalline form. The crystals are filtered and purified by dissolving in 175 ml. of water, reprecipitating at 10°C as described above, filtering again, washing with dry acetone, and drying over sulfuric acid. Yield: about 90 g.

PROPERTIES:

Blue-gray crystals, very deliquescent in air, soluble in water with a blue-violet color, readily soluble in alcohol, insoluble in acetone.

REFERENCES:

- I. A. Hantzsch and E. Torke. *Z. anorg. allg. Chem.* 209, 72 (1932).
- II. A. Werner and A. Gubser. *Ber. dtsh. chem. Ges.* 34, 1591 (1901).
- III. G. O. Higley. *J. Amer. Chem. Soc.* 26, 620 (1904).

Chloropentaaquochromium (III) Chloride

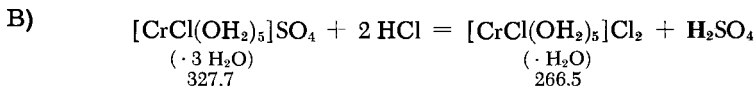
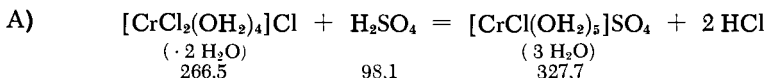
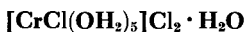
A) PREPARATION OF $[\text{CrCl}(\text{OH}_2)_5]\text{SO}_4 \cdot 3 \text{H}_2\text{O}$

A solution of 26.8 g. of green chromium chloride hydrate $[\text{CrCl}_2(\text{H}_2\text{O})_4]\text{Cl} \cdot 2 \text{H}_2\text{O}$ in an equal amount of water is allowed to stand for 24 hours at room temperature, and a mixture of 10 g. of conc. H_2SO_4 and 4 g. of water is then added. The sulfate soon separates in bright green tablets.

B) PREPARATION OF $[\text{CrCl}(\text{OH}_2)_5]\text{Cl}_2 \cdot \text{H}_2\text{O}$

A conc. aqueous solution of the sulfate, cooled to 0°C , is allowed to flow into ether at 0° while a stream of dry HCl is introduced. The yield is greater than 87%.

PROPERTIES:

Bright green, microcrystalline, very hygroscopic powder; readily soluble in water, alcohol and acetone. Differentiated from its isomers by its solubility in a mixture of equal volumes of ether and fuming hydrochloric acid. Insoluble in HCl -saturated ether.

REFERENCES:

- I. R. F. Weinland and Th. Schumann. *Ber. dtsh. chem. Ges.* 40, 3094 (1907).
- II. M. Gutiérrez de Celis. *An. Soc. Españ. Física Quim.* 34, 553 (1936), abstract in *Chem. Zentr.* 1936, II, 1874.

Hexaamminechromium (III) Chloride and Nitrate

I. PREPARATION BY AUTOOXIDATION OF AN NH_4Cl -CONTAINING AMMONIACAL SOLUTION OF A Cr(II) SALT

A solution of chromium (II) salt is prepared as indicated in the preparation of rhodochromium chloride (see p. 1359). This solution is forced under pressure (in the absence of air) into a flask containing a mixture of 525 g. of NH_4Cl and 540 g. of ammonia (d 0.91). The vessel should be almost full at this point. The flask is stoppered at once with a cork which carries a gas outlet tube; the tube terminates under water. The flask is placed in cold water until H_2 evolution ceases (about 18-24 hours). The $[\text{Cr}(\text{NH}_3)_6]\text{Cl}_3$ that deposits on the undissolved NH_4Cl and that dissolved in the liquid are worked up separately.

The red solution is decanted and treated with an equal volume of 95% alcohol. The chloride, which settles after several hours, is washed by decantation with alcohol, filtered, rewashed with alcohol, and dried in air. It is then dissolved in lukewarm water and the solution passed through a filter into well-cooled nitric acid (d 1.39), whereupon the $[\text{Cr}(\text{NH}_3)_6](\text{NO}_3)_3$ separates in long, yellow needles. The precipitate is washed several times by decantation with nitric acid, then with a mixture of 1 volume of nitric acid and 2 volumes of water, filtered, washed with alcohol until free of the acid, and dried in the air.

The product-containing NH_4Cl is treated several times with 150-ml. portions of water at room temperature, but only as long as the extracts are still yellow. They are treated with an equal volume of nitric acid (d 1.39; good cooling is essential). Yellow needles appear, either at once or after several hours; they are worked up as above. Total yield: 35-40 g.

The salt is purified by dissolving in a minimum quantity of cold water. The solution is passed through a filter into dilute nitric acid (1 vol. of nitric acid, d 1.4, and 2 vol. of water); the crystals are washed with alcohol and dried in air.

II.

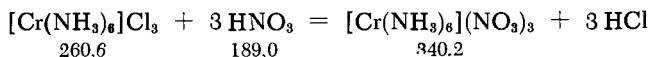
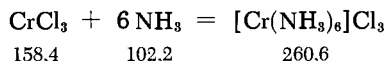

The presence of NaNH_2 catalyst prevents the coproduction of $[\text{CrCl}(\text{NH}_3)_5]\text{Cl}_2$.

A hood with a good draft is needed; a one-liter Dewar flask is placed under this hood, charged with about 800 ml. of liquid NH_3 , and 0.5 g. of pure Na metal and 0.2 g. of $\text{Fe}(\text{NH}_4)_2(\text{SO}_4)_2 \cdot 6 \text{H}_2\text{O}$ are added. (Instead of the Dewar flask, a one-liter beaker inserted in a second, 1.5-liter beaker may also be used.) After disappearance of the blue color of the NH_3 solution, 50 g. (nearly 0.3 mole) of CrCl_3 is added with constant stirring (2-g. portions over a period of 1-2 hours). The brown precipitate is allowed to settle and the clear supernatant liquid is decanted or siphoned off.

The residue is transferred to a large dish and allowed to stand (with occasional stirring) until the odor of NH_3 disappears and a lustrous yellow, free-flowing powder remains. The yield of crude $[\text{Cr}(\text{NH}_3)_5]\text{Cl}_3$ is almost quantitative (about 80 g.).

The crude product is purified by dissolving rapidly in a mixture of 10 ml. of conc. HCl and 150 ml. of water at 40°C . After filtration, the solution is treated at once with 50 ml. of conc. nitric acid to precipitate pure $[\text{Cr}(\text{NH}_3)_5](\text{NO}_3)_3$. The liquid is allowed to cool to room temperature, the yellow crystalline salt is filtered on a Büchner funnel and washed with distilled water containing some HNO_3 , then with alcohol, and finally with ether. The product is dried in a vacuum desiccator in the absence of light and stored in a brown bottle. Yield: 80 g. (75%).

SYNONYM:

Luteochromic chloride or nitrate.

PROPERTIES:

The chloride (as well as the nitrate) forms orange-yellow crystals, only moderately soluble in water at room temperature (the nitrate in the ratio 1:40). Solubility is still further decreased by addition of nitric acid. All $[\text{Cr}(\text{NH}_3)_5]^{3+}$ salts are sensitive to light even when dry. Decomposes slowly in solution, more rapidly on boiling, depositing chromium hydroxide. Heating with conc. HCl produces $[\text{CrCl}(\text{NH}_3)_5]\text{Cl}_2$.

REFERENCES:

- I. S. M. Jørgensen. *J. prakt. Chem.* **30**, 2 (1884).
- II. A. L. Oppegard and J. C. Bailar, Jr. in: L. F. Audrieth, *Inorg. Syntheses*, Vol. III, New York-Toronto-London, 1950, p. 153.

Chloropentaamminechromium (III) Chloride



I. BY REACTION OF LIQUID NH_3 WITH CrCl_3

Dry CrCl_3 (8 g.) is added to liquid NH_3 . The reaction starts at the boiling point of the NH_3 , and the CrCl_3 is transformed into a red

product. After evaporation of excess NH_3 , the residue is triturated with 30 ml. of ice-cold water, filtered, then washed with some cold water until the filtrate is reddish. Concentrated nitric acid is added to the filtrate and $[\text{Cr}(\text{NH}_3)_5](\text{NO}_3)_3$ is obtained (see p. 1351). Yield: about 7 g.

The red residue, consisting of $[\text{CrCl}(\text{NH}_3)_5]\text{Cl}_2$, is boiled with conc. HCl , cooled, mixed with water, filtered and washed with some cold water. It is then dissolved as rapidly as possible at 50°C in 400–500 ml. of water which is acidified with a few drops of H_2SO_4 . The solution is immediately filtered through a large fluted filter paper and treated with an equal volume of conc. HCl . The salt precipitates in beautiful red crystals; after one hour, these are filtered, washed with 1:1 HCl , then with alcohol, and dried in a desiccator. Yield: about 5 g.

II. FROM THE RHODOCHLORIDE BY BOILING WITH HYDROCHLORIC ACID

The procedure for the preparation of rhodochromium chloride (see p. 1359) is followed, except that after the introduction of O_2 the entire mixture is boiled for a few minutes with 2.5 times its volume of conc. HCl , whereupon the $[\text{CrCl}(\text{NH}_3)_5]\text{Cl}_2$ precipitates.

After cooling, the supernatant liquid is decanted. In 24 hours, additional purpureochromic chloride separates from the supernatant; it is, however, contaminated with NH_4Cl . The NH_4Cl is removed with dilute HCl ; the residue is washed with alcohol and dried in a desiccator.

Yield: about 45 g. (from 60 g. of $\text{K}_2\text{Cr}_2\text{O}_7$).

Purification is the same as in method I (solution in water containing some H_2SO_4 and addition of HCl).

SYNONYM:

Purpureochromic chloride.

PROPERTIES:

Formula weight 243.54. Carmine-red crystals; $d_4^{15.5}$ 1.687. Solubility (16°C) 0.65 g./100 g. H_2O . In aqueous solution, even on moderate heating, adds a water molecule to give $[\text{Cr}(\text{H}_2\text{O})(\text{NH}_3)_5]\text{Cl}_3$. Space group V_h^{15} .

REFERENCES:

- I. O. T. Christensen. *Z. anorg. Chem.* 4, 229 (1893); H. Biltz and W. Biltz. *Übungsbeispiele a. d. unorg. Exp. chemie [Exercises in Inorg. Experimental Chemistry]*, 3rd and 4th eds., 1920, p. 176.
- II. O. T. Christensen. *J. prakt. Chem.* 23, 57 (1881).

**Triethylenediaminechromium (III) Sulfate,
Chloride and Thiocyanate**
 $[\text{Cr en}_3]_2(\text{SO}_4)_3$, $[\text{Cr en}_3]\text{Cl}_3 \cdot 3.5 \text{ H}_2\text{O}$, $[\text{Cr en}_3](\text{SCN})_3 \cdot \text{H}_2\text{O}$

A) ANHYDROUS CHROMIUM (III) SULFATE

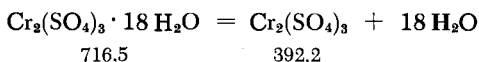

Heating of $\text{Cr}_2(\text{SO}_4)_3 \cdot 18 \text{ H}_2\text{O}$ for 2-3 days at 100-110°C gives a lumpy product; this is ground and dried further. Complete dehydration is indicated by the fact that the powder is no longer soluble in water.

B) ANHYDROUS ETHYLENEDIAMINE

Since anhydrous ethylenediamine attacks cork and rubber stoppers, ground glass equipment must be used. Five hundred grams of NaOH and 875 ml. of commercial ethylenediamine hydrate are heated overnight on a steam bath. Two layers form; the upper layer is decanted, treated with additional 150 g. of NaOH for several hours; the supernatant is decanted again and distilled. B.p. 116-117°C at 760 mm. Yield: almost quantitative. (Propylenediamine can be dehydrated in the same manner.)

The ethylenediamine thus obtained still contains some water. Absolutely dry ethylenediamine reacts only very slowly with the $\text{Cr}_2(\text{SO}_4)_3$.

C) TRIETHYLENEDIAMINECHROMIUM (III) SULFATE

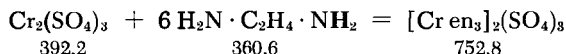

A 300-ml. Erlenmeyer flask, to which an air-cooled condenser is attached by a ground joint, is used to reflux 49 g. of $\text{Cr}_2(\text{SO}_4)_3$ and 50 ml. of anhydrous ethylenediamine on a steam bath. Within one hour (and often much less), the sulfate begins to lose its bright green color and its powdery nature. If this should not occur after two hours, the reaction is induced by addition of a drop of water. From this time on, the flask must be shaken to and fro, to bring unreacted $\text{Cr}_2(\text{SO}_4)_3$ into contact with the amine; the shaking is discontinued when a brown, solid mass forms; this is allowed to remain on the steam bath overnight. The solid, which is orange-yellow after cooling, is then broken up with a spatula, ground, washed with alcohol, and dried in air. Yield: 89 g. [95%, based on $\text{Cr}_2(\text{SO}_4)_3$].

D) TRIETHYLENEDIAMINECHROMIUM (III) CHLORIDE HYDRATE

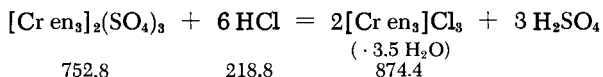

A solution of 32 g. of $[\text{Cr en}_3]_2(\text{SO}_4)_3$ in dilute HCl (5 ml. of conc. HCl and 30 ml. of water) is prepared at 60–65°C and rapidly filtered through a Büchner funnel. The filtrate is stirred and cooled in ice while 27 ml. of conc. HCl is added; the chloride $[\text{Cr en}_3]\text{Cl}_3 \cdot 3.5 \text{ H}_2\text{O}$ separates at once. Filtration yields 20 g. or 60% based on the sulfate used.

This chloride is still contaminated with sulfate. It may be purified by recrystallization from water. Thus 20 g. of the crude product is dissolved in 20 ml. of water at 65°C. On cooling, 12 g. of pure chloride is obtained.

E) TRIETHYLENEDIAMINECHROMIUM (III) THIOCYANATE

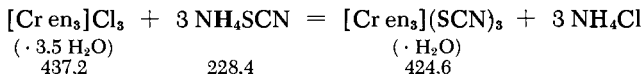

A solution of 30 g. of $[\text{Cr en}_3]\text{Cl}_3 \cdot 3.5 \text{ H}_2\text{O}$ in 100 ml. of warm water is mixed, while ice-cooled and rapidly stirred, with a conc. aqueous solution of 36 g. of NH_4SCN . The sparingly soluble $[\text{Cr en}_3](\text{SCN})_3 \cdot \text{H}_2\text{O}$ separates at once. Filtration yields 30 g. of the crude product, or 94% based on the chloride charged.

For purification, the product is recrystallized from 100 ml. of water at 65°C, cooled, filtered, washed with alcohol and ether, and dried in air. Yield 23 g., or 77% based on the crude.

The bromide and the iodide can be obtained in exactly analogous fashion, that is, by addition of the corresponding ammonium salt.

Alternate methods: From violet chromium (III) chloride or dehydrated chrome alum, with ethylenediamine hydrate or ethylenediamine, respectively.

PROPERTIES:

The $[\text{Cr en}_3]^{3+}$ salts are distinctly crystalline, orange-yellow substances, which are slightly sensitive to light even when dry. Their aqueous solutions have poor stability, particularly when heated or placed in sunlight: then the initial red color is followed shortly by complete decomposition. While the sulfate is extremely soluble in water and the chloride is also very soluble, the thiocyanate, the bromide and the iodide are relatively sparingly soluble. The chloride and the thiocyanate are readily converted by

heating to the corresponding $[\text{CrX}_2 \text{en}_2]^+$ salts (see the two preparations which follow).

REFERENCES:

- C. L. Rollinson and J. C. Bailar, Jr. in: W. C. Fernelius, *Inorg. Syntheses*, Vol. II, New York-London, 1946, p. 196. P. Pfeiffer. *Ber. dtsch. chem. Ges.* **37**, 4277 (1904); Reschke. Thesis, Univ. of Leipzig, 1925; M. Linhard and M. Weigel. *Z. anorg. allg. Chem.* **271**, 115 (1952).

cis-Dichlorodiethylenediaminechromium (III) Chloride

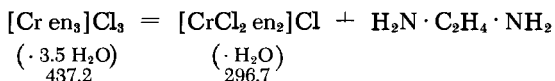

The $[\text{Cr en}_3]\text{Cl}_3 \cdot 3.5 \text{H}_2\text{O}$, which serves as the starting material, is recrystallized from a 1% aqueous NH_4Cl solution; this imparts a small NH_4Cl content to the chloride complex, and the NH_4Cl catalyzes the thermal decomposition. If the $[\text{Cr en}_3]\text{Cl}_3 \cdot 3.5 \text{H}_2\text{O}$ is prepared specifically as a starting material for this reaction, the NH_4Cl may be added already during the recrystallization of the impure $[\text{Cr en}_3]\text{Cl}_3 \cdot 3.5 \text{H}_2\text{O}$.

The recrystallized salt is dried and is then spread in a thin layer on a large watch glass, which is heated to 210°C . Careful control of the temperature is essential, since the rate of decomposition is too high above 215°C , while below 200°C the reaction is very slow. The evolution of ethylenediamine starts after a few minutes; the salt gradually becomes darker and after 1-2 hours turns red-violet. The course of the reaction is checked by the weight loss, which should approach the theoretical value of 30.6%.

A crude product, in satisfactory purity for many purposes, is obtained by washing with ice-cold conc. HCl . For further purification, it may be recrystallized as follows: The salt is dissolved rapidly in water at 70°C , using 4 ml. of water per gram of salt, and the filtered solution is cooled in a cooling mixture. Then 1 ml. of ice-cold conc. HCl is added for each gram of the salt, whereupon small red-violet needles separate. These are filtered and washed with alcohol and ether. Yield: 0.45 g. (60%) per gram of starting compound.

Alternate method: From $\text{K}_3[\text{Cr}(\text{C}_2\text{O}_4)_3]$ via two intermediate steps [A. Werner, *Ber. dtsch. chem. Ges.* **44**, 3135 (1911)].

PROPERTIES:

Small red-violet needles, readily soluble in water with a violet color. The solution becomes orange after a few hours, more rapidly when warmed.

REFERENCES:

- C. L. Rollinson and J. C. Bailar, Jr. in: W. C. Fernelius, *Inorg. Syntheses*, Vol. II, New York-London, 1946, p. 201; P. Pfeiffer. *Ber. dtsch. chem. Ges.* **37**, 4277 (1904); M. Linhard and M. Weigel. *Z. anorg. allg. Chem.* **271**, 119 (1952).

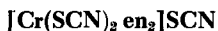
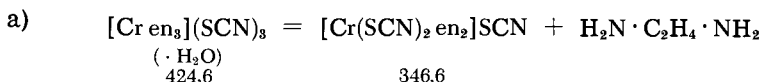
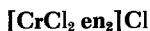
trans-Dithiocyanatodi(ethylenediamine)chromium (III)**Thiocyanate****trans-Dichlorodi(ethylenediamine)chromium (III)****Chloride**

The crude $[\text{Cr en}_3](\text{SCN})_3 \cdot \text{H}_2\text{O}$ used as starting material is prepared according to the directions given on p. 1355 and recrystallized from a 1% NH_4SCN solution as in the preparation of $\text{cis-}[\text{CrCl}_2 \text{en}_2] \text{Cl} \cdot \text{H}_2\text{O}$. As in the latter case, the product is prepared by thermal decomposition, but at a temperature of 130°C (maximum 134°C). The theoretical weight loss is 18.40%. The product, which is a uniform yellow-red, is recrystallized several times from hot water, the solution concentration being such that the thiocyanate starts to crystallize slowly only after the solution is completely cold. This procedure yields 2 g. of pure $[\text{Cr}(\text{SCN})_2 \text{en}_2] \text{SCN}$ per 3 g. of crude; the material still contains 1-2 moles of water of hydration; this is removed in a desiccator.

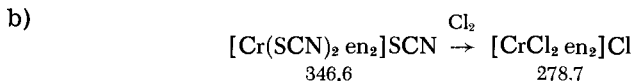

A fast stream of Cl_2 is passed through an aqueous slurry of the thiocyanate obtained in (a); good cooling is necessary. The green crystalline powder which separates from the violet solution is essentially *trans*-dichlorosulfate and -chloride. About 0.6 g. of this

crude dichloro salt is obtained from 2 g. of thiocyanate. A concentrated solution of the crude salt in conc. HCl is placed in an H_2SO_4 desiccator, which also contains a small dish with conc. HCl. The blue-green acid chloride $[\text{CrCl}_2\text{en}_2]\text{Cl} \cdot \text{HCl} \cdot 2\text{H}_2\text{O}$ (0.3 g.) separates in one day. On heating to 100°C , this is transformed into $[\text{CrCl}_2\text{en}_2]\text{Cl}$.

PROPERTIES:

Trans- $[\text{CrCl}_2\text{en}_2]\text{Cl}$ consists of green crystals. A very thin layer of a conc. aqueous solution appears green, while thicker layers have a brown-red color.

REFERENCES:

- I. C. L. Rollinson and J. C. Bailar, Jr. in: W. C. Fernelius, *Inorg. Syntheses*, Vol. II, New York-London, 1946, p. 202; P. Pfeiffer. *Z. anorg. Chem.* **29**, 113 (1902).
- II. P. Pfeiffer. *Ber. dtsch. chem. Ges.* **37**, 4282 (1904).

Dichloroaquotriamminechromium (III) Chloride

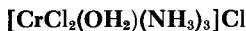

There are three position isomers: a, b, and c. The preparation starts from $(\text{NH}_3)_3\text{CrO}_4$ and hydrochloric acid.

a) One gram of $(\text{NH}_3)_3\text{CrO}_4$ (for preparation, see p. 1392) is carefully dissolved in 6 ml. of dilute HCl (the flask must be cooled with ice). It is added to the acid slowly in small portions, as soon as the vigorous reaction from the preceding portion has subsided. On addition of 10 ml. of conc. HCl and long standing in the cold, the red solution deposits red-violet snowflakelike crystals. These are recrystallized from the conc. aqueous solution by addition of conc. HCl. After washing with alcohol and ether, the crystals are dried over H_2SO_4 . Yield: about 1.1 g.

b) About 2 g. of the chloride prepared in (a) is heated in HCl solution at about 60°C until the blue color of the solution is completely changed to green. By suction-filtration in a desiccator, dark green, needle-shaped crystals can be isolated from this solution; these are dried over H_2SO_4 . This salt cannot be recrystallized; it is always contaminated with impurities.

c) If 8 ml. of conc. HCl is used to dissolve one gram of $(\text{NH}_3)_3\text{CrO}_4$ under the same conditions as in (a), one obtains a bright green solution, from which gray, needle-shaped crystals soon separate. These are washed with alcohol and ether and dried over H_2SO_4 . Yield: about 1 g.

PROPERTIES:

Formula weight 227.50. a) Red-violet dichroic crystals, soluble in water, giving a blue color. b) Dark green, needle-shaped crystals, soluble in water, giving a green color. c) Gray, needle-shaped crystals, insoluble in cold water, soluble in warm H_2O , giving a red color.

REFERENCE:

E. H. Riesenfeld and F. Seemann. Ber. dtsch. chem. Ges. 42, 422 (1909).

Hexaureachromium (III) Chloride

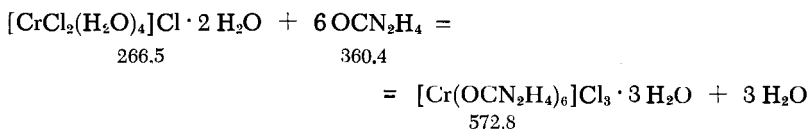
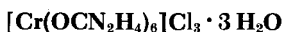

Green, crystalline chromium chloride hydrate $[CrCl_2(H_2O)_4]Cl \cdot 2H_2O$ and somewhat more than the stoichiometric quantity of urea are dissolved in some water and treated with a few drops of HCl. The solution is concentrated in a drying oven at $75^\circ C$ (or on the steam bath) until a crystalline crust forms. The crystal slurry thus obtained is dissolved in the minimum quantity of water at $50-60^\circ C$ and rapidly filtered. The salt complex separates as green needles.

PROPERTIES:

Green needles, readily soluble in water, insoluble in absolute alcohol.

REFERENCE:

E. Wilke-Dörfurt and K. Niederer, Z. anorg. allg. Chem. 184, 150 (1929).

Rhodochromium Chloride



The preparation involves oxidation of an ammoniacal, NH_4Cl -containing solution of Cr (II) salt.

Sixty grams of $K_2Cr_2O_7$ powder is placed in a 2.5-liter beaker and covered with 200 ml. of conc. HCl and 75 ml. of alcohol (stirring). The resulting green solution of chromium (III) salt is reduced with zinc while still warm (but below $50^\circ C$) in the absence of air. The blue solution is poured into a mixture of 500 g. of NH_4Cl and 750 ml. of conc. ammonia, the necessary good cooling being achieved by adding pieces of ice (or by immersion in ice). After decanting from undissolved NH_4Cl , O_2 is passed through the liquid, which is shaken vigorously to achieve rapid oxidation. The liquid becomes red and rhodochloride deposits out abundantly. The salt is filtered, washed first with a mixture of 2 vol. of water and 1 vol. of conc. HCl, and then once with cold water. It is dissolved in cold water and the solution allowed to flow into a chilled mixture of 2 vol. of conc. HCl and 1 vol. of water, whereupon the rhodochloride reprecipitates almost completely. It is washed with 1:1 HCl, then with alcohol until free of acid, and dried in air in the dark. Yield: about 25 g.

PROPERTIES:

Formula weight 468.64. Pale crimson-red crystalline powder; contains 1 mole of H_2O when air-dried; this is slowly lost over conc. H_2SO_4 .

REFERENCES:

S. M. Jørgensen. *J. prakt. Chem.* 25, 328 (1882); for composition, see K. A. Jensen. *Z. anorg. allg. Chem.* 232, 257 (1937), as well as W. K. Wilmarth, H. Graff and S. T. Gustin. *J. Amer. Chem. Soc.* 78, 2683 (1956).

Erythrochromium Chloride

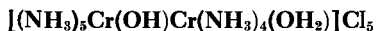

Seven grams of rhodochromium chloride (preparation as above) is dissolved in 50 ml. of 2 N ammonia. This blue solution becomes pure crimson red in about 15 minutes; it is then cooled in ice and treated with 100 ml. of ice-cold, conc. HCl. The erythrochloride which precipitates is filtered, washed with some dilute HCl, then with alcohol and ether, and dried over H_2SO_4 . Yield: 95%.

PROPERTIES:

Light-sensitive, crimson-red crystalline powder; more readily soluble in water than the rhodochloride.

REFERENCES:

- K. A. Jensen. *Z. anorg. allg. Chem.* 232, 264 (1937). W. K. Wilmarth, H. Graff and S. T. Gustin. *J. Amer. Chem. Soc.* 78, 2683 (1956).

Tris(2,2'-dipyridyl)chromium (II) Perchlorate

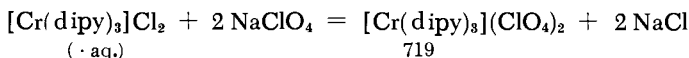
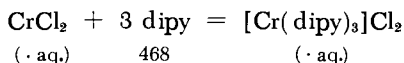
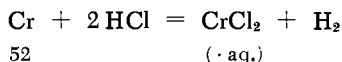
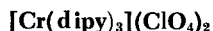

All operations are carried out under pure N_2 and with deaerated liquids.

A solution of 0.26 g. of electrolytic Cr (preparation on p. 1335) in 2.5 ml. of 1:1 HCl is prepared. After the H_2 evolution ceases, the solution is diluted with 20 ml. of water, and 2.35 g. of 2,2'-dipyridyl, dissolved in some methanol, is added. The solution, now a deep wine-red, is filtered through a fine fritted-glass filter. The filtrate is treated with a solution of 1 g. of NaClO_4 and 0.5 ml. of 70% HClO_4 in 50 ml. of water. A slurry of black-violet crystals is formed at once. This is filtered on fine fritted glass, washed with water, alcohol and ether, and dried in vacuum over P_2O_5 . Yield: 3 g. (83% of theory).

PREPARATION OF 2,2'-DIPYRIDYL

a) From FeCl_3 and pyridine in an autoclave [F. Hein and H. Schwedler, *Ber. dtsh. chem. Ges.* 68, 681 (1935)]; b) refluxing of Raney nickel and pyridine [G. M. Badger and W. H. F. Sasse, *J. Chem. Soc. (London)* 1956, 616].

The corresponding complexes with 1,10-phenanthroline $[\text{Cr}(\text{phen}_3)_n \text{X}_n]$ (where $\text{X} = \text{I}$ or ClO_4 and $n = 1, 2, 3$) can be prepared in a similar manner [S. Herzog, *Chem. Techn.* 8, 544 (1956)].

PROPERTIES:

Small black crystals; completely stable in air when dry, but oxidized when damp (acquires a yellow color). Sparingly soluble in water or methanol, giving an intense wine-red color.

Insoluble in ether and benzene. In weak perchloric acid solution oxidized by air, forming yellow *tris*(2,2'-dipyridyl)chromium (III) perchlorate, which can be crystallized by concentrating the solution in the cold over H₂SO₄.

REFERENCES:

- S. Herzog. Thesis, Univ. of Jena, 1952; F. Hein and S. Herzog. *Z. anorg. allg. Chem.* 267, 337 (1952); G. A. Barbieri and A. Teitamanzi. *Atti R. Accad. Lincei (Rome), Rend.* [6] 15, 877 (1932).

Tris(2,2'-dipyridyl)chromium (II) Perchlorate

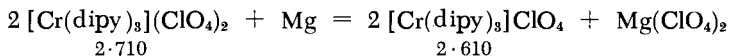

All operations are carried out under pure N₂ and with air-free liquids.

Tris(2,2'-dipyridyl)chromium (II) perchlorate (1.0 g.; preparation as above) is covered with 250 ml. water, giving an opaque wine-red solution. This is treated with 60 mg. of Mg powder (about 3 times the stoichiometric quantity) and machine-shaken in a well-closed container. The solution becomes colorless after a maximum of 3 hours, and a fine, indigo-colored powder separates out. The powder, because of its fine particle size, imparts an apparent black-violet color to the solution on superficial examination. Now 3 g. of NH₄ClO₄ is added and the mixture is shaken for an additional hour to dissolve the remaining Mg. After standing overnight, the dark-blue product is filtered through a fine fritted-glass filter, washed three times with 5-ml. portions of water, and dried in vacuum over P₂O₅. After a few hours, the preparation is dust-dry. Yield: about 0.65 g. (about 80% of theory).

PROPERTIES:

Indigo-blue powder; soluble in methanol, ethanol, acetone and pyriding, giving a deep, inky blue color; insoluble in water, benzene and ether. The solution is oxidized almost instantly in air, becoming lighter in color. The dry product reacts spontaneously with atmospheric O₂ with considerable evolution of heat and loss of the 2,2'-dipyridyl.

REFERENCES:

- S. Herzog. Thesis, Univ. of Jena, 1952. F. Hein and S. Herzog. *Z. anorg. allg. Chem.* 267, 337 (1952).

Tris(2,2'-dipyridyl)chromium (0)

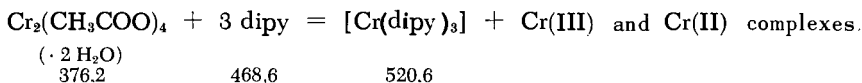

Two grams of chromium (II) acetate hydrate is mixed (in the absence of air) with 2.49 g. of 2,2'-dipyridyl (equivalent to 1.5 moles of dipyridyl per g.-atom of Cr). Now, 40 ml. of deaerated water is added and the resulting suspension is machine-shaken for three hours. The black precipitate is filtered off from the deep-red mother liquor (through a very fine fritted-glass filter), washed with water and alcohol, and dried over air-free P_2O_5 . Yield: about 1 g.

Alternate methods: Reduction of tris(2,2'-dipyridyl)chromium (II) salt in tetrahydrofuran with sodium.

PROPERTIES:

Small black crystals; soluble in benzene, tetrahydrofuran, pyridine or dimethylformamide with a red color. Ignites in air with oxidation to Cr_2O_3 .

REFERENCE:

S. Herzog, K. Chr. Renner and W. Schön. Z. Naturforsch. 12b, 809 (1957).

Hexaphenylisonitrilochromium (0)

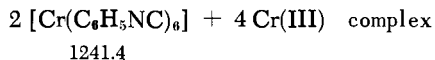
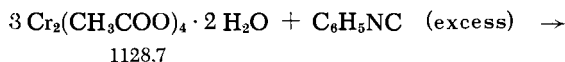

The reaction is carried out under N_2 ; a large excess of phenyl isonitrile is desirable. Six grams of chromium (II) acetate $\text{Cr}_2(\text{CH}_3\text{COO})_4 \cdot 2 \text{H}_2\text{O}$ is suspended in 40 ml. of methanol, and a solution of 20 g. of isonitrile in 10 ml. of methanol is added. After about one hour, well-formed garnet-red crystals separate from the deep black-red solution. The precipitate is filtered, washed with some methanol, and dried.

The yield is 5-6 g., which is almost quantitative, based on the disproportionation shown above.

PROPERTIES:

Garnet-red crystals with metallic, yellowish-green reflectance, stable in air, diamagnetic. M.p. 178.5°C (undergoes deformation at 151°C). Soluble in chloroform and benzene in the cold, readily soluble in the hot solvents. Can be recrystallized by reprecipitation with alcohol from a chloroform solution. Can be obtained from methylene chloride; in this case, large crystals, similar in appearance to pyrites, are obtained.

REFERENCE:

L. Malatesta, A. Sacco and S. Ghielmi. *Gazz. Chim. Ital.* **82**, 516 (1952).

If a Cr (II) halide is used instead of the Cr (II) acetate, the reaction is completely different: a crystalline precipitate of $[\text{Cr}(\text{RNC})_4\text{Cl}_2]$ (orange-red) or $[\text{Cr}(\text{RNC})_4\text{Br}_2]$ (olive brown), depending on the starting halide used, forms instantly. These compounds show a paramagnetism of 2.84 Bohr magnetons, corresponding to Cr^{2+} . They are again completely stable in air and can even be heated in water without decomposition; insoluble in ether, alcohol, benzene and carbon tetrachloride, but soluble in chloroform and methylene dichloride.

REFERENCE:

F. Hein and W. Kleinwächter. Private communication, unpublished.

Chromium Orthophosphate

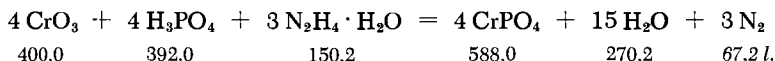

A mixture of 11.6 g. of 85% H_3PO_4 (d 1.69), 12.5 g. of CrO_3 (125% of the stoichiometric quantity) and 200 ml. of H_2O is prepared, and 5.4 g. of 80% hydrazine hydrate (115% of the stoichiometric amount) in 100 ml. of H_2O is added in drops and with stirring. After stirring for 15 minutes at 50°C, the precipitate is washed, suction-dried, and then dried for 2 hours at 100°C. Yield: 19 g. of amorphous

3.5-hydrate. Heating for 2 hours in vacuum at 800°C yields 13 g. of CrPO_4 , which gives a crystalline x-ray diffraction pattern.

PROPERTIES:

Hydrate: Turquoise green powder. d 2.15. Following the above directions gives a particle size of 0.1μ , while a tenfold dilution of the reactants gives $1\text{-}\mu$ particles.

Anhydrous: Gray-brown; insoluble in H_2O and CH_3COOH . d 3.05.

REFERENCES:

F. Wagenknecht. German Patents 1,046,597 (1957) and 1,056,104 (1957).

Chromium (II) Sulfate

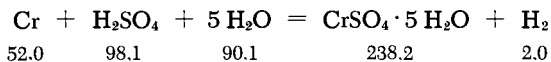
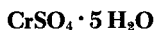

Twenty grams of coarse, very pure electrolytic chromium (>99.99% Cr) is placed in 150 ml. of H_2O , and 46 g. of conc. H_2SO_4 is then added with agitation. The Cr is completely dissolved and massive crystals of $\text{CrSO}_4 \cdot 5 \text{H}_2\text{O}$ precipitated from the deep blue, highly supersaturated solution. Concentration of the liquid in vacuum gives an almost theoretical yield of the product. The salt is filtered, washed with some ice-cold water, and dried in vacuum or in a stream of N_2 ; any water present can be removed by thorough washing with acetone.

PROPERTIES:

Blue, massive crystals. Completely stable in air when dry. Solutions are instantly oxidized on contact with atmospheric O_2 . Solubility (0°C): 21 g./100 g. H_2O . Isotypic with $\text{CuSO}_4 \cdot 5 \text{H}_2\text{O}$.

REFERENCE:

H. Lux and G. Illmann. Chem. Ber. 91, 2143 (1958).

Chromium (II) Salt Solutions

I. PREPARATION BY ELECTROLYTIC REDUCTION

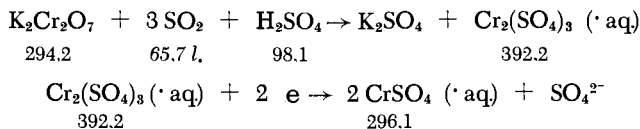

The electrolysis apparatus (see Fig. 318) comprises a 1.5-liter jar *p* and a cylindrical porous clay cell *q* of about 500-ml. capacity (height 17 cm., diameter 6.5 cm.); the cell is closed off with a rubber stopper which carries a glass stirrer *u* with a mercury seal, a sampling tube *s*, a gas outlet tube *t*, and a lead cathode *v* having 230 cm.² of surface. The cell is surrounded by the Pb anode *w*.

The Pb cathode should be prepared according to directions given by Tafel (see the references below). It is suspended in 20% sulfuric acid and surrounded coaxially by a second cylindrical Pb electrode. The current (0.13 amp./in.²) is turned on, and the working electrode is operated first as an anode, then as a cathode (5 min.), and finally again as an anode (15 min.). After this, it is brown. It is washed with boiling water and dried.

The chromium (III) sulfate solution required for the electrolytic reduction is prepared as follows: SO₂ is bubbled through a solution of 80 g. of K₂Cr₂O₇, 30 g. of conc. H₂SO₄ and 450 g. of water until reduction is complete. Good cooling is necessary to prevent the transformation of violet to green chromium (III) sulfate [the latter is not as readily reduced to chromium (II) sulfate]. The excess SO₂ is driven off with a fast stream of air. The last traces of SO₂ must be removed by brief boiling. The solution, whose volume is now about 50 ml., is transferred to the clay cell. The anodic electrolyte is 2 N H₂SO₄. Electrolysis proceeds at a current density of 0.13 amp./in.², that is, at a current of 4.6 amp. The reduction takes 12 hours, but up to 24 hours may be required if a great deal of green chromium (III) sulfate is present. The course of the reduction can be followed by

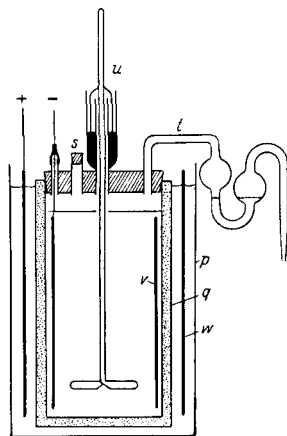

Fig. 318. Preparation of chromium (II) sulfate by electrolytic reduction. *p* jar; *q* porous clay cell; *s* sampling tube; *t* gas outlet tube; *u* stirrer with Hg seal; *v* lead cathode; *w* lead anode.

removing samples and titrating with excess 0.1 N KMnO_4 , adding KI, and back-titrating with 0.1 N $\text{Na}_2\text{S}_2\text{O}_3$.

II. PREPARATION BY REDUCTION WITH ZINC

It is best to use a zinc reductor. This consists of a vertical glass tube, 45 cm. long and 2 cm. I.D., with a glass stopcock at the lower end. It is two-thirds filled with zinc granules. Before use the contents of the column are amalgamated for 10 minutes with a 0.1 M HgCl_2 solution in 1 M HCl, then washed with a large quantity of water and finally with some 1 N H_2SO_4 ; during this operation the liquid level should always be above the zinc. The reduction proper is carried out by adding a solution of 90 g. of green chromium (III) chloride hydrate in 120 ml. of water and 30 ml. of 2 N H_2SO_4 to the reductor tube; the rate of discharge from the reductor is so adjusted that only a pure, light blue chromium (II) salt solution drops into the directly attached storage or reaction vessel.

This solution obviously contains zinc salts. Solutions completely free of foreign salts are obtained either by dissolving chromium (III) acetate or, better, by dissolving electrolytic chromium in dilute HCl, as described, for example, in the procedure for *tris*(2,2'-dipyridyl)chromium (II) perchlorate.

APPLICATIONS

Useful for removing O_2 from gases, for reductometric titration, and as a reductant in organic chemistry.

PROPERTIES:

Blue solution, very sensitive to air; storage stability is highly dependent on the purity of the starting materials.

REFERENCES:

- I. Ch. W. Hofmann. Thesis, Univ. of Bern, 1947; R. Flatt and F. Sommer. *Helv. Chim. Acta* 25, 684 (1942); A. Asmanow. *Z. anorg. allg. Chem.* 160, 210 (1927); W. Traube and A. Goodson. *Ber. dtsch. chem. Ges.* 49, 1679 (1916); J. Tafel. *Z. phys. Chem.* 34, 187 (1900).
- II. E. Zintl and G. Rienäcker. *Z. anorg. allg. Chem.* 161, 378 (1927); M. R. Hatfield in: L. F. Audrieth, *Inorg. Syntheses*, Vol III, New York-Toronto-London, 1950, p. 149.

Chromium (II) Acetate



I.

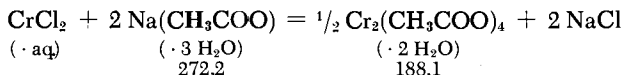
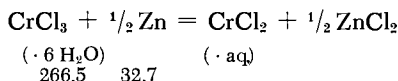

Pure chromium (II) acetate may be prepared only if oxygen is completely excluded. This condition is approached in the apparatus of Fig. 319.

Fig. 319. Preparation of chromium (II) acetate. *a* zinc reductor; *b* glass wool plug; *c* pinchcock or glass stopcock with 10-mm. bore; *d* reaction vessel; *e* fritted-glass funnel; *f* glass stirrer; *g* rubber cap to seal stirrer against outside air; *h* dropping funnel; *i* suction flask; *k* dropping funnel for washing liquids; *l* bubble trap for outgoing inert gas; *m* rubber sleeve for sealing large stopper.

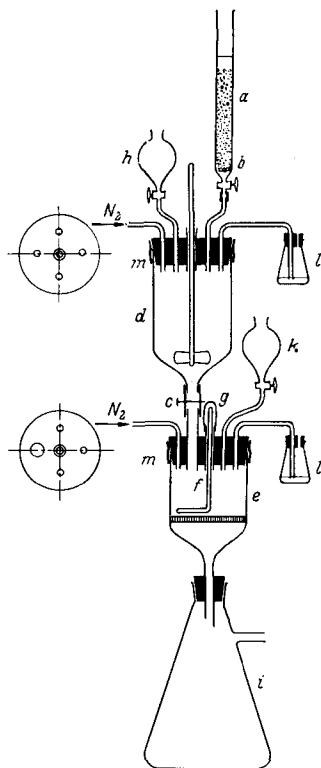

The chromium (II) salt solution is obtained in a Zn reductor (see previous preparation). This consists of a glass tube *a* (45 cm. long and 2 cm. I.D.) in which a glass wool plug is inserted at *b*. The Zn granules filling the tube are amalgamated before use

(10 minutes with a 0.1 M HgCl_2 solution in 1 M HCl), then washed with large quantities of water and finally with some 1 N H_2SO_4 ; during this procedure the liquid level should always be above the zinc. A pinchcock or a glass stopcock with a 10-mm. bore is located at *c*. Reaction vessel *d* is attached with a rubber tube to the moderately coarse fritted-glass funnel *e* (diameter about 10 cm.). Glass stirrer *f* should provide thorough stirring of the precipitate during the washing and drying steps; it is held in place and turned by means of the rubber cap *g* which serves as a seal. Nitrogen or carbon dioxide (O_2 -free) is passed through the reaction vessel during the precipitation, and over the precipitate during the filtration. The gage pressure in the apparatus (governed by the liquid height in the trap *l*) should be as small as possible.

A solution of 90 g. of green chromium (III) chloride hydrate in 120 ml. of water and 30 ml. of 2 N H_2SO_4 is poured into the reductor tube and its outflow rate so adjusted that only a pure light blue chromium (II) salt solution drops into the reaction vessel *d*. A filtered solution of 252 g. of Na acetate in 325 ml. of water is charged beforehand into the reaction vessel (via *h*). During the precipitation the vessel contents are stirred briefly by hand, using the stirrer provided.

After completion of the precipitation, N_2 or CO_2 is admitted into filter *e* and stopcock *c* is opened. In this operation the filtering flask *i* can be carefully put under a slight vacuum, provided a sufficient flow of N_2 (or CO_2) is maintained and the chromium (II) acetate is always surrounded only by the protective gas. The precipitate is washed on the filter with air-free distilled water, then several times with alcohol, and finally with peroxide-free ether, after which N_2 or CO_2 (H_2O -free) is passed through for 24 hours. The chromium (II) acetate must be completely dry before it can be exposed to air, since it oxidizes at an appreciably faster rate when moist. Yield: 55 g.

The preparation can also be carried out with smaller quantities, e.g., one third of those given above. In this case, the dimensions are reduced to 7 cm. I.D. for the precipitating vessel *d* and the funnel *e*. The reductor need be only 35 cm. high (filled to 25 cm.). The drawing of Fig. 318 is based on dimensions appropriate to this case.



52.0

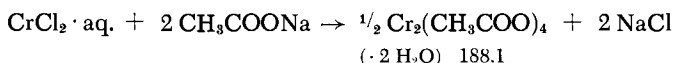

Two grams of electrolytic chromium is covered with a mixture of 6.2 ml. of conc. HCl and an equal volume of water (air should be

excluded). After the start of the H_2 evolution, about 10 additional ml. of water is added and the vessel is heated on a steam bath. When the evolution of H_2 ceases, the sky-blue solution of chromium (II) chloride is slowly filtered through a fine fritted-glass funnel into a solution of 28 g. of sodium acetate in 40 ml. of deaerated water. The solution immediately turns red, and after a few seconds small glittering red crystals begin to precipitate. After overnight standing, these are filtered through fine fritted glass, washed five times with 10-ml. portions of water, dried with air-free $CaCl_2$, and stored under N_2 . Yield: about 6 g.

Other means of obtaining chromium (II) salt solutions may be used instead of direct solution of the chromium used, provided the product solutions contain no foreign substances which would affect the precipitation of the acetate.

PROPERTIES:

Dark-red crystals, slightly soluble in water and alcohol. Insoluble in ether. When dry, stable in air for a few hours; stable indefinitely under N_2 . Drying over P_2O_5 at $100^\circ C$ results in loss of the complexed water, change of color to brown, and increased sensitivity to air.

REFERENCES:

- S. Vanino. Handb. d. präp. Chemie [Handbook of Preparative Chemistry], Inorg. Section, Stuttgart, 1925, p. 710; E. Zintl and G. Rienäcker. Z. anorg. allg. Chem. 161, 378 (1927); M. R. Hatfield in: L. F. Audrieth, Inorg. Syntheses, Vol. III, New York-Toronto-London, 1950, p. 149; K. H. Zapp. Unpublished, Freiburg i. Br.; S. Herzog. Unpublished, Jena; M. Kranz and A. Witkowska. Przemysl Chem. 37, 470 (1958); Inorg. Syntheses, Vol. VI, 1960, p. 144.

Chromium (II) Oxalate

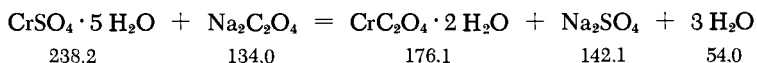

A dry mixture of 14 g. of $CrSO_4 \cdot 5 H_2O$, 8 g. of $Na_2C_2O_4$, and 0.25 g. of $H_2C_2O_4 \cdot 2 H_2O$ is covered with about 150 ml. of O_2 -free H_2O under a protective blanket of N_2 . This mixture is shaken vigorously. After some time, $CrC_2O_4 \cdot 2 H_2O$ separates as a fine, crystalline, green precipitate. It is filtered, washed with cold H_2O ,

and dried over CaCl_2 , giving a yellowish-green powder. The yield is 80-85%.

Alternate method: Reaction of solid $\text{Na}_2\text{C}_2\text{O}_4$ with concentrated solutions of chromium (II) salt obtained electrolytically (method of Walz).

REFERENCES:

H. Lux and G. Illmann. Chem. Ber. 91, 2143 (1958); H. Walz. M. S. thesis, Univ. of Freiburg i. Br., 1958.

Hexaaquochromium (III) Acetate

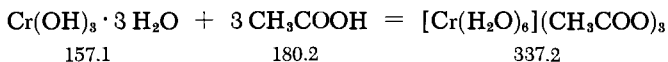
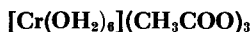

I. Excess glacial acetic acid is added to the light blue-green Achromium (III) hydroxide (for preparation see p. 1345). The reaction proceeds with appreciable evolution of heat. The crystals (which precipitate after a few hours) are separated from the mother liquor, washed thoroughly with acetone and ether, and dried over H_2SO_4 .

II. *Alternate method:* From chrome alum via the readily obtained dihydroxotetraaquochromium (III) sulfate.

PROPERTIES:

Needle-shaped blue-violet crystals, readily soluble in water; solvolyzed by alcohol.

REFERENCES:

I. A. Hantzsch and E. Torke. Z. anorg. allg. Chem. 209, 78 (1932).
II. A. Werner. Ber. dtsch. chem. Ges. 41, 3452 (1908).

Dihydroxohexaacetatotrichromium (III) Acetate and Chloride



Prepared from CrO_3 , glacial acetic acid and alcohol.

a) A two-liter round-bottom flask fitted with a reflux condenser is used. It is charged with 200 g. of CrO_3 (sulfuric acid-free),

which is then covered with 400 ml. of commercial glacial acetic acid. The reaction is induced by careful heating on a water bath which is held below the boil. Since pure CrO_3 does not react with very pure glacial acetic acid even at the boil, the reaction may be started by addition of some alcohol. If the reaction becomes too vigorous, the flask is cooled. When the evolution of CO_2 begins to subside, the flask contents are refluxed for about 2 hours on a rapidly boiling water (or steam) bath. The thick, brown contents of the flask, which consist of hexaacetatotrichromium chromates, are allowed to cool somewhat. To complete the reduction of any chromic acid still present, first 50% alcohol and then 96% alcohol (about 100 ml. of alcohol in all) is added in small portions through the condenser. The flask is now heated for one hour on a steam bath, and the green liquid is then concentrated on a water bath. The green diacetate powder has the formula



The monoacetate hexahydrate is obtained by dissolving the powder in some water and allowing evaporation to take place over H_2SO_4 . The monoacetate tetrahydrate crystallizes in long prisms when an aqueous solution of the diacetate is treated with acetone.

PROPERTIES:

Formula weight 675.41 (4 H_2O), 711.45 (6 H_2O). Green, water-soluble crystals.

b) Evaporation of a solution of the diacetate in dilute HCl over H_2SO_4 yields $[\text{Cr}_3(\text{OH})_2(\text{CH}_3\text{COO})_5]\text{Cl} \cdot 8 \text{H}_2\text{O}$.

PROPERTIES:

Formula weight 723.90. Dark green prisms, may be recrystallized from water.

REFERENCES:

R. F. Weinland and E. Büttner. *Z. anorg. allg. Chem.* 75, 329, Anm. 1 (1912); R. Weinland and P. Dinkelacker. *Ber. dtsch. chem. Ges.* 42, 3010, 3012 (1909).

Potassium Trioxalatochromate (III)

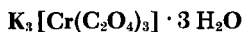

Prepared by treatment of oxalic acid and potassium oxalate with $\text{K}_2\text{Cr}_2\text{O}_7$.

A concentrated aqueous solution containing 12 g. $K_2Cr_2O_7$ is added dropwise with stirring to a solution containing 27 g. of oxalic acid dihydrate and 12 g. of neutral potassium oxalate monohydrate. The mixture is then evaporated to a small volume and slowly cooled to bring about crystallization.

SYNONYM:

Potassium chromium oxalate.

PROPERTIES:

Formula weight 485.4. Black-green, monoclinic scales with transparent blue edges. Readily soluble in water.

REFERENCE:

- H. Hecht, *Präparative anorg. Chemie [Preparative Inorganic Chemistry]*, Berlin-Göttingen-Heidelberg, 1951, p. 158.

Potassium Hexacyanochromate (III)

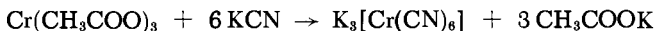
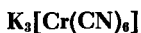

Seventeen grams of CrO_3 or 25 g. of $K_2Cr_2O_7$ is treated with 70 ml. of HCl (45 ml. of conc. HCl + 25 ml. of water) and reduced while hot by addition of a total of 25 ml. of ethanol in small portions. A very slight excess of ammonia is added to the boiling solution. The precipitate of $Cr(OH)_3$ is filtered hot through a fluted filter paper, washed several times with hot water, and finally dissolved in some dilute acetic acid. This solution is evaporated almost to dryness in order to remove the excess acetic acid. The residue is taken up in 150 ml. of water, filtered, and poured into a boiling solution of 100 g. of KCN in 200 ml. of water (use a hood!). The very dark-red solution thus formed is evaporated on a steam bath. A brownish-black solid usually separates; this is removed by filtration. On further concentration, bright-yellow crystals deposit on the walls. The mother liquor also yields additional fractions. The product is recrystallized two or three times from water and dried over H_2SO_4 . The yield is 38 g. (70%).

PROPERTIES:

Formula weight 325.41. d 1.71. Bright yellow, monoclinic crystals, isomorphous with $K_3[Fe(CN)_6]$; decomposes above $150^\circ C$. Solubility at $20^\circ C$: 30.96 g./100 g. water; insoluble in alcohol.

Aqueous solutions tend to decompose, especially in light or on heating, separating $\text{Cr}(\text{OH})_3$.

REFERENCES:

- F. V. D. Cruser and E. H. Miller. *J. Amer. Chem. Soc.* **28**, 1133 (1906); O. T. Christensen. *J. prakt. Chem.* [2] **31**, 163 (1885); see also J. H. Bigelow in: W. C. Fernelius, *Inorg. Syntheses*, Vol. II, New York-London, 1946, p. 203.

Potassium Hexathiocyanatochromate (III)

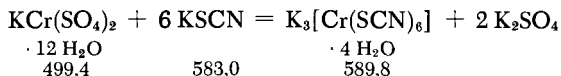

A moderately concentrated aqueous solution of 6 parts of KSCN and 5 parts of chrome alum is heated for 2 hours on a steam bath, and is then concentrated in a dish until the cooled residual liquid solidifies to a mass of red crystals. This solid is extracted with absolute alcohol, in which the $\text{K}_3[\text{Cr}(\text{SCN})_6]$ dissolves very readily while K_2SO_4 remains as a residue. After evaporation of the filtered alcohol extract, the salt is recrystallized once more from alcohol.

The analogous ammonium salt $(\text{NH}_4)_3[\text{Cr}(\text{SCN})_6] \cdot 4 \text{H}_2\text{O}$ is obtained in the same manner, except that reaction in the solution of NH_4SCN and chromium ammonium alum takes place only after a brief period of boiling.

SYNONYM:

Potassium chromium thiocyanate.

PROPERTIES:

Lustrous crystals; dark red-violet in reflected light and garnet red in transmitted light. The salt remains unchanged in air or over H_2SO_4 ; it loses its water of crystallization only when heated to 110°C . One part dissolves in 0.72 parts of water and in 0.94 parts of alcohol; d^{16} 1.711.

REFERENCE:

- J. Roesler. *Liebigs Ann.* **141**, 185 (1867).

Trilithium Hexaphenylchromate (III)

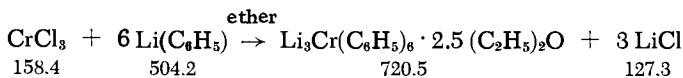
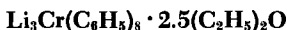

All operations are conducted in the absence of air and moisture, using high-purity N_2 as a protective gas.

a) The required solution of phenyllithium is prepared in a 500-ml. three-neck flask fitted with a reflux condenser and Hg seal, a high-speed Hg-sealed mechanical stirrer, a gas inlet tube, and a dropping funnel. The procedure is as follows: Clean, finely cut lithium (6 g.) is covered with 100 ml. of ether that has been freshly distilled over benzophenonesodium (referred to hereafter as ketyl ether). With the stirrer operating at high speed, 64 g. of freshly distilled bromobenzene, dissolved in 200 ml. of ketyl ether, is added dropwise at a rate sufficiently fast to keep the reaction solution boiling vigorously. After all the bromobenzene has been added, the solution is refluxed for one hour. After cooling, it is filtered through fine fritted glass. The clear solution thus obtained has a phenyllithium concentration of about 10%.

b) The preparation of the lithium chromium phenyl complex employs the same apparatus as described in (a). However, the dropping funnel is replaced by a tap-injection bulb containing 10 g. of anhydrous, very finely powdered chromium (III) chloride. With vigorous, high-speed stirring of the lithium phenyl solution in the flask, the chromium chloride is slowly introduced by tapping the bulb. The course of the reaction is monitored by observing the decrease in the number of black particles of chromium chloride. After 10-12 hours, the reaction is discontinued without waiting for complete conversion of the solid chromium chloride. The nascent yellow precipitate is filtered through fine fritted glass. By cooling the black-brown filtrate to -10°C , a portion of the complex is obtained in beautiful crystals. The reaction residue is rinsed back into the three-neck flask with 200 ml. of ketyl ether and again collected on the fritted glass.

The reaction flask is now replaced with a reflux condenser which is attached to the N_2 -generating apparatus (to equalize the pressure). The receiver flask is heated and the ether is distilled through the fritted glass plate and onto the residue; by cooling the receiver flask, the ether is suction-drawn through the residue back into the flask. This operation is repeated until the residue is colorless. On cooling, most of the complex compound crystallizes in the receiver. The crystal slurry thus obtained is recrystallized from a large quantity of ketyl ether; or it is extracted

with fresh ketyl ether as described above. The mother liquor must be yellow-brown and free of halogens. Yield: about 15 g.

PROPERTIES:

Yellow-orange crystals; soluble in ether, benzene and tetrahydrofuran; sensitive to air and moisture; completely hydrolyzed by water or alcohol.

REFERENCE:

F. Hein and R. Weiss. *Z. anorg. allg. Chem.* **295**, 145 (1958).

Ammonium Tetrathiocyanatodiamminechromate (III)

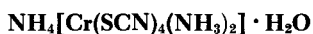

Prepared by fusion of NH_4SCN with $(\text{NH}_4)_2\text{Cr}_2\text{O}_7$ and extraction with water.

An enamel cooking pot of at least 4-liter capacity is charged with 800 g. (10.5 moles) of NH_4SCN and carefully heated; several small flames are used to provide as uniform heating as possible. The mass is stirred with a glass test tube which contains a thermometer; the heating is continued until the solid is partly melted and the temperature is 145–150°C. Now, an intimate mixture of 170 g. (0.675 mole) of finely powdered $(\text{NH}_4)_2\text{Cr}_2\text{O}_7$ and 200 g. (2.6 moles) of NH_4SCN is added in portions of 10–12 g. with continuous stirring. A fairly vigorous reaction begins after 10 such portions have been added; NH_3 is evolved and the temperature rises to 160°C. The flames are now extinguished and the rest of the mixture is added to the melt in such a way as to maintain the temperature at 160°C.

Stirring is continued as the melt cools; the solid product which deposits on the walls of the vessel is scraped away, ground to a fine powder while still warm, and stirred in a large beaker with 750 ml. of ice water. After 15 minutes, the insoluble residue is freed of mother liquor as completely as possible (suction-filtration, no washing). It is then stirred into 2.5 liters of water, preheated to 65°C. The temperature is rapidly restored to 60°C and the solution is filtered all at once through a funnel heated with hot water (heating above 65° causes rapid decomposition, with production of a blue color and generation of HCN).

The hot filtrate is placed overnight in an ice chest, and the separated crystals are then filtered with suction. The mother liquor is used for another extraction of the residue at 60°C, thus affording an additional quantity of crystalline Reinecke salt.

Finally, 12–13 additional grams of product may be obtained by concentrating the mother liquor to 250–300 ml. under reduced pressure at 40–50°C.

The total yield of air-dry Reinecke salt amounts to 250-275 g. (52-57% of theory).

The insoluble residue from the second extraction (about 130-135 g.) is composed predominantly of Morland salt, i.e., guanidium tetrathiocyanatodiamminechromate (III).

USES:

Used for the isolation of amines, amino acids, complex cations and organometallic bases; it forms sparingly soluble salts with all of the above; these salts usually crystallize well. Also used as reagent in quantitative determination of Cu and Hg (procedure of C. Mahr) and of quaternary onium cations (procedure of F. Hein).

SYNONYM:

Reinecke salt.

PROPERTIES:

Formula weight 354.45. Ruby-red, lustrous, light-sensitive leaflets, which lose their water of crystallization on drying at 100°C and form scarlet cubes and rhombododecahedra. Both forms are readily soluble in cold water, alcohol, acetone and moist ethyl acetate, insoluble in benzene. Decomposed by boiling water.

REFERENCES:

H. D. Dakin. *Org. Syntheses* 15, 74 (1935); *Coll. Vol. II*, 555 (1943).

Tetrathiocyanatodiamminechromic (III) Acid

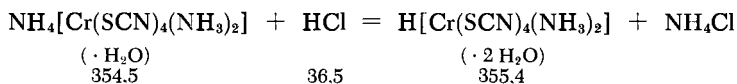

A concentrated aqueous solution of $\text{NH}_4[\text{Cr}(\text{SCN})_4(\text{NH}_3)_2] \cdot \text{H}_2\text{O}$ (see preceding preparation) is treated with a small excess of hydrochloric acid, then extracted thoroughly with ether. The free acid is absorbed in the ether with an intense dark red color; addition of NaCl makes the extraction almost quantitative. Evaporation of the ethereal solution in vacuum over H_2SO_4 and KOH yields a red mass which loses its solubility in ether after standing for a few

days. The product is recrystallized from 50°C water, in which it dissolves very readily, except for a small yellow residue. On cooling, small red scales separate; these are again recrystallized from water.

SYNONYM:

Reinecke acid.

PROPERTIES:

Lustrous red leaflets; readily soluble in water, alcohol and acetone. Heating for several days at 70°C renders the acid anhydrous; further heating at 110-115°C imparts a darker color. The undried compound decomposes between 80 and 90°C, puffing up and evolving water.

REFERENCE:

R. Escales and H. Ehrensperger. Ber. dtsh. chem. Ges. 36, 2681 (1903).

Ammonium Tetrathiocyanatodianilinochromate (III)

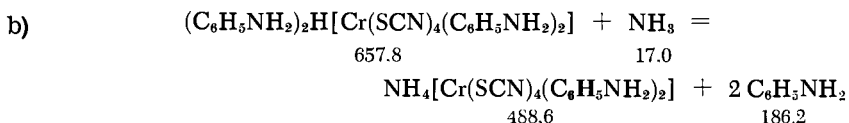
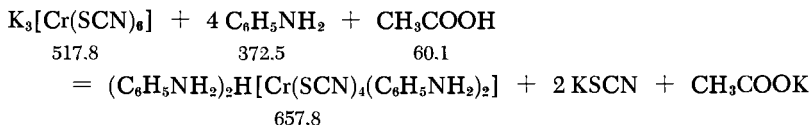
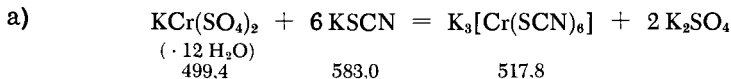

a) A mixture of 500 g. of chrome alum, 600 g. of KSCN, and 500 ml. of water is heated for 4 hours on a steam bath. The solution is cooled, 500 ml. of aniline is added, and the mixture is stirred for 3 hours at 60°C on a water bath. It is then again cooled and a mixture of 6 liters of water and 600 ml. of glacial acetic acid is added. After a few hours the precipitate is filtered and dissolved

in 1.5-2 liters of cold methanol. This solution is filtered, and 6 liters of water is added, whereupon $(C_6H_5NH_2)_2H[Cr(SCN)_4-(C_6H_5NH_2)_2]$ precipitates as a thick, violet crystal slurry. After a further precipitation from methanol-water, the yield is 330 g.

b) Four hundred grams of this anomalous anilinium salt is treated with 600 ml. of methanol and 300 ml. of conc. ammonia. This solution is cooled in ice and 3 liters of water is slowly added; the crude ammonium thiocyanato-aniline complex precipitates. After filtering with suction, it is treated once more in the same manner with methanol, ammonia and water. Yield: about 200 g.

USE:

Separation of amino acids, especially proline.

SYNONYMS:

Ammonium salt of rhodanilic acid; ammonium rhodanilate.

PROPERTIES:

Violet-red crystals, somewhat soluble in water, very soluble in methanol, acetone and ethyl acetate. The solutions decompose on boiling. Insoluble in ether, benzene and chloroform.

REFERENCE:

M. Bergmann. J. Biol. Chem. 110, 476 (1935).

Potassium Tetrathiocyanatodipyridinochromate (III)

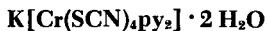

Prepared from $K_3[Cr(SCN)_6]$ and pyridine.

Ten parts of $K_3[Cr(SCN)_6]$ (for preparation, see p. 1374), dried at $110^\circ C$, is heated with 30 parts of anhydrous pyridine in a small flask (4 hours on the water bath, in the absence of moisture). The hot solution is then poured into a crystallizing dish and allowed to chill in an ice chest. The solid which crystallizes is a mixture of $KSCN$, $py_2 \cdot H[Cr(SCH)_4py_2]$, and $[Kpy_4][Cr(SCN)_4py_2]$. It is suction-dried and placed on a clay plate. The complex potassium salt deliquesces over a period of 1-2 days, and the $KSCN$ is extracted with water at room temperature, while the $K[Cr(SCN)_4py_2]$ is extracted with hot water. When cooled, the resulting red solutions gradually deposit small, lustrous red crystals of the potassium salt. The residue remaining after the hot water extraction affords pure dipyridinium salt $py_2 \cdot H[Cr(SCN)_4py_2]$.

PROPERTIES:

Formula weight 517.66. Small red crystals, which become anhydrous on heating to 110°C. Almost insoluble in cold water, but somewhat soluble in warm H₂O. Completely insoluble in benzene, chloroform and ether; very soluble in aqueous and absolute ethyl alcohol, methanol, ethyl acetate and pyridine; very readily soluble in acetone.

REFERENCE:

P. Pfeiffer. Ber. dtsch. chem. Ges. 39, 2121, 2123 (1906).

Trichlorotriaquochromium

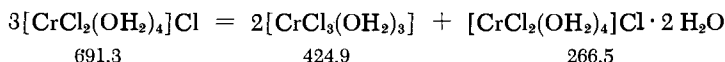

Green chromium chloride hydrate $[\text{CrCl}_2(\text{OH}_2)_4]\text{Cl} \cdot 2 \text{H}_2\text{O}$ is converted into $[\text{CrCl}_2(\text{OH}_2)_4]\text{Cl}$ on standing for 3 days in a vacuum desiccator over conc. H₂SO₄. It is then suspended in absolute ether; $[\text{CrCl}_3(\text{OH}_2)_3]$ is formed by disproportionation and dissolves with a brown-violet color. On evaporation of the ethereal solution in the absence of atmospheric moisture, $[\text{CrCl}_3(\text{OH}_2)_3]$ is obtained as an amorphous brown powder.

PROPERTIES:

Formula weight 212.43. Brown, amorphous, very hygroscopic powder, rapidly altered by traces of water. Soluble in water with a yellow-green color, which quickly becomes pure green owing to a reaction. Solutions in ether may be stored without change if moisture is absent.

REFERENCES:

A. Recoura. Comptes Rendus Hebd. Séances Acad. Sci. 194, 229 (1932); 196, 1854 (1933); see also F. Hein. J. prakt. Chem. 153, 168 (1939).

Trichlorotriethanolochromium

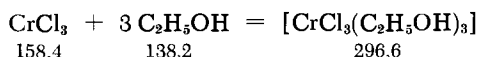

Dried CrCl₃ is refluxed (in the absence of moisture) with absolute alcohol and a small piece of zinc (or CrCl₂). The CrCl₃

dissolves; the solution, which is red when hot and green when cold, is concentrated in a vacuum desiccator over conc. H_2SO_4 . The red crystals which deposit are washed with some absolute alcohol and ether, and stored dry.

PROPERTIES:

Dark red, hygroscopic crystals; soluble in alcohol, acetone and chloroform with a red color which soon becomes green. The aqueous solution decomposes rapidly.

REFERENCE:

I. Koppel. Z. anorg. Chem. 28, 471 (1901).

Trichlorotriamminechromium

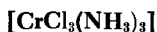

Prepared from $(NH_3)_3CrO_4$ and hydrochloric acid.

Five grams of triamminechromium tetroxide (for preparation, see p. 1392) is introduced into 50 ml. of well-cooled conc. HCl (constant stirring). The resulting gray- to blue-green precipitate is filtered off. The neutral complex, which deposits from the filtrate after standing for 1-2 days, is filtered with suction and washed with water until the washings become colorless. It is then dried by washing with alcohol and ether.

PROPERTIES:

Formula weight 209.48. Blue crystals with greenish tinge, insoluble in cold H_2O . Dissolution in warm H_2O causes aquation to $[CrCl_2(OH_2)(NH_3)_3]Cl$. Presumably trans form.

REFERENCE:

A. Werner. Ber. dtsch. chem. Ges. 43, 2289 (1910).

Trichlorotripyridinechromium

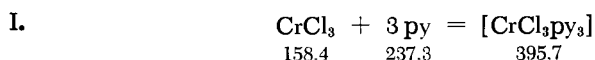

The $CrCl_3$, in excess of dry pyridine, is refluxed in the presence of a small granule of $CrCl_2$. The $CrCl_3$ dissolves completely after

some time, giving a green color. The solution is filtered and cooled, whereupon the $[\text{CrCl}_3\text{py}_3]$ crystallizes out. On distilling the pyridine from the mother liquor, the compound can be obtained in almost quantitative yield.

II. Addition of H_2O to a pyridine solution of green chromium chloride hydrate $[\text{CrCl}_2(\text{H}_2\text{O})_4]\text{Cl} \cdot 2 \text{H}_2\text{O}$ yields a green powder which consists essentially of a mixture of $[\text{CrCl}_3\text{py}_3]$ and $[\text{Cr}(\text{OH})_2(\text{H}_2\text{O})_2\text{py}_2]\text{Cl}$. When this mixture is treated with HCl , the latter salt goes into solution as $[\text{Cr}(\text{H}_2\text{O})_4\text{py}_2]\text{Cl}_3$, giving a deep red color. The residue consists of crude $[\text{CrCl}_3\text{py}_3]$. This is dissolved in conc. HCl and reprecipitated by pouring the filtered solution into a large amount of water. Finally the $[\text{CrCl}_3\text{py}_3]$ is recrystallized once more from pyridine.

PROPERTIES:

Green leaflets, readily soluble in pyridine, chloroform, acetone and conc. HCl ; sparingly soluble in ethyl alcohol; insoluble in water, ether, benzene and naphtha.

REFERENCES:

P. Pfeiffer. Z. anorg. Chem. 24, 282 (1900); 55, 99 (1907).

Chromium (III) Glycinate

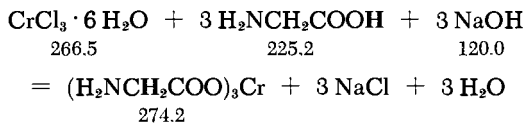

An aqueous solution of one mole of green chromium chloride hydrate and 3 moles of glycine is boiled while 3 moles of NaOH is added gradually. This gives a dark-red solution from which a violet compound separates. The latter is filtered off while the mixture is still hot. The filtrate, after cooling and standing in vacuum over H_2SO_4 , deposits still more of the violet compound, together with larger red crystals. After suction-filtration and drying, the heavy red crystals are separated from the lighter violet ones by slurring with alcohol. In this way, both compounds are obtained in analytically pure state.

PROPERTIES:

Red crystals = chromium (III) glycinate, $(\text{H}_2\text{NCH}_2\text{COO})_3\text{Cr}$.

Violet crystals = so-called "basic" chromium (III) glycinate, $(\text{NH}_2\text{CH}_2\text{COO})_2\text{Cr}(\text{OH})_2\text{Cr}(\text{OOCCH}_2\text{NH}_2)_2 \cdot \text{H}_2\text{O}$.

Both compounds are sparingly soluble in water and insoluble in organic solvents.

Chromium (III) α -alaninate can be obtained in an analogous manner. If the reaction is allowed to take place in conc. solution, the red chromium (III) alaninate separates; the "basic" chromium (III) alaninate is obtained by evaporation of the solution.

REFERENCE:

H. Ley. Ber. dtsch. chem. Ges. 45, 380 (1912).

Chromium (III) Xanthate

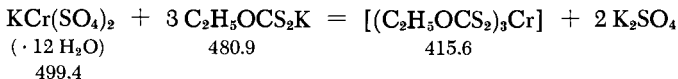

A solution of 20 g. of potassium xanthate in some water is treated with a solution of 23 g. of chrome alum. The blue-black compound which precipitates is filtered off with suction and dried on a clay plate. It is dissolved in pyridine, and water is added in drops until a permanent clouding is obtained. The solution is then allowed to stand undisturbed to bring about crystallization. The crystals are separated by filtration and dried in vacuum.

PROPERTIES:

Dark-blue crystalline powder, soluble in organic media, insoluble in water.

REFERENCE:

J. V. Dubsy. J. prakt. Chem. 90, 118 (1914).

Chromium (III) Acetylacetonate

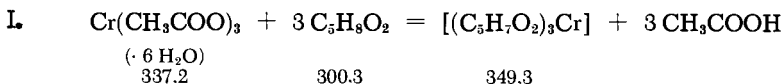

A mixture of 40 g. of $[Cr(OH_2)_6](CH_3COO)_3$ (for preparation, see p. 1371), 150 ml. of water, 40 g. of acetylacetonate and 50 ml. of

2 N acetic acid is heated until solution is complete and crystallization of the internal complex begins. Then the solution is boiled for a short time until the liquid bumps vigorously. It is cooled gradually, then chilled in ice and filtered. The first crop affords 18 g. of chromium acetylacetonate, which can be recrystallized from chloroform-benzene.

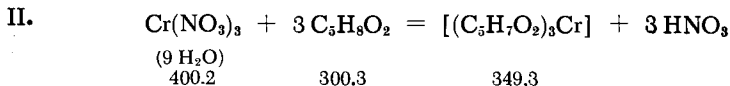

An alcoholic solution of $[\text{Cr}(\text{OH}_2)_6](\text{NO}_3)_3$ is treated with the stoichiometric quantity of acetylacetonate and then gently refluxed. The chromium complex crystallizes out after the excess alcohol is distilled off.

REFERENCES:

Red-violet crystals, m.p. 216° ; can be sublimed in vacuum. Soluble in alcohol, chloroform and benzene; virtually insoluble in water and petroleum ether.

REFERENCES:

F. Hein. J. prakt. Chem. 153, 169 (1939); F. Gach. Monatsh. Chem. 21, 108 (1900).—As far as preparation from chromium chloride hexahydrate and acetylacetonate in the presence of urea is concerned, see W. C. Fernelius and F. E. Blanch in: T. Moeller, Inorg. Syntheses, Vol. V, New York-Toronto-London, 1957, p. 130.

Chromyl Chloride

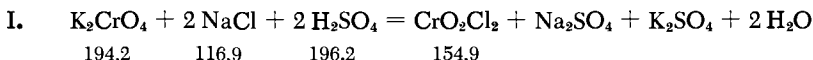

A clay crucible is used to fuse 200 g. of K_2CrO_4 with 122 g. of NaCl at a temperature which should not be excessive. The melt is poured onto a sheet of iron and broken up into coarse pieces. These are placed in a 2-liter ground-joint flask and covered with 200 ml. of 100% H_2SO_4 . A distilling condenser is connected to the flask at once, and a ground-joint receiving flask with a gas outlet tube is attached to the lower end of that condenser. When the initially vigorous reaction becomes moderate, the reaction flask is

heated gently until no further CrO_2Cl_2 distills. The crude product is purified by a second distillation in a dry ground-glass apparatus; the pure CrO_2Cl_2 is collected in dry glass ampoules, which are then melt-sealed.

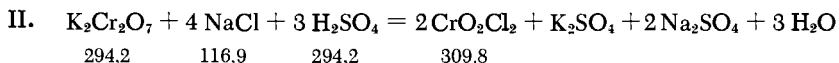

It is possible to omit the fusion step. Thus, 150 g. of fuming H_2SO_4 is added in portions to a mixture of 50 g. of NaCl and 80 g. of $\text{K}_2\text{Cr}_2\text{O}_7$ (both thoroughly dried). Further procedure is the same as in method I. The yield is approximately 50%, based on $\text{K}_2\text{Cr}_2\text{O}_7$.

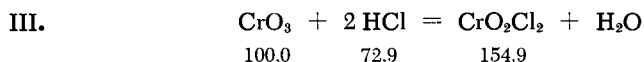

A solution of 50 g. of CrO_3 in 170 ml. of conc. HCl is prepared, and 100 ml. of conc. H_2SO_4 is added in 20-ml. portions while cooling the flask in ice. The fluid mixture is poured into a separatory funnel, and after 20 minutes the lower CrO_2Cl_2 layer is drained into a small ground-joint flask. Dry air is bubbled through it for several minutes and the crude CrO_2Cl_2 is distilled as in method I.

PROPERTIES:

Deep-red liquid; fumes copiously in moist air. Should be stored in the dark and in sealed glass containers. M.p. -96.5°C , b.p. 117°C ; d_4^{25} 1.9118. Can react explosively with combustible organic and inorganic substances. Soluble in other inorganic acid chlorides and organic liquids, such as POCl_3 , CCl_4 , CHCl_3 and C_6H_6 .

REFERENCES:

- I and III. L. Vanino. *Handb. d. Präp. Chemie* [Handbook of Preparative Chemistry], I, Stuttgart, 1925; p. 713.
 II. E. Moles and L. Gomez. *Z. phys. Chem.* **80**, 513 (1912).
 See also H. H. Sisler. *Inorg. Syntheses*, Vol. II, New York-London, 1946, p. 205.

Chromium Trioxide-Pyridine

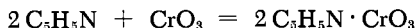
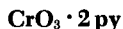

Four grams of CrO_3 (0.04 mole) is dried in vacuum for four hours at 110°C and then chilled in ice-salt mixture. Fifty ml. of

pyridine (0.63 mole) is similarly chilled in a 300-ml. Erlenmeyer flask. The pyridine flask is agitated vigorously while situated in a cold bath, and the CrO_3 is slowly added. The flask is then stoppered and shaken further until solution is complete (solution is hastened by the use of a large excess of pyridine). The cooling is necessary to prevent oxidation of the pyridine. The excess solvent is then removed in vacuum. The product is sensitive to light. Slow evaporation favors the formation of large crystals. Yield: 10.3 g. (100%).

PROPERTIES:

Yellow to dark-red crystals. Soluble in pyridine; insoluble in CCl_4 , benzene and ether. Hygroscopic. Decomposes slowly at 100°C ; at higher temperatures, burns to give voluminous green chromium oxide. Hydrolyzes at once with water. Stable indefinitely in the dark. Stored in sealed containers at room temperature.

REFERENCES:

- H. H. Sisler, J. D. Bush and O. E. Accountius. *J. Amer. Chem. Soc.* **70**, 3827 (1948); O. E. Accountius, J. D. Bush and H. H. Sisler in: *J. C. Bailar, Inorg. Syntheses, Vol. IV, New York-London-Toronto, 1953, p. 94.*

Chromyl Nitrate

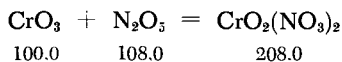
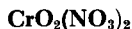

A powder funnel is used to rapidly pour 8.3 g. of N_2O_5 into a 50-ml. ground-joint flask precharged with 7 g. of CrO_3 and a few (vacuum) boiling stones. The flask is attached to a distillation apparatus whose joints are lubricated with silicone grease and which is protected against entry of atmospheric moisture by means of a P_2O_5 tube. The reaction begins after a short time, with fusion of the solids. The reaction mixture should be left standing overnight at room temperature.

The dark-red liquid product is distilled in aspirator vacuum. A liquid-nitrogen-cooled trap is interposed between the apparatus and the aspirator to prevent access of moisture and to condense the NO_2 and N_2O_5 which distill off. The $\text{CrO}_2(\text{NO}_3)_2$ distills at a bath temperature of about 75°C (partial decomposition). The receiver then contains 5.8 g. of pure $\text{CrO}_2(\text{NO}_3)_2$.

PROPERTIES:

Dark-red liquid, sensitive to moisture. M.p. -27°C , b.p. (10^{-3} mm.) 28°C ; (17 mm.) 67°C . Decomposes at about 120°C .

REFERENCES:

M. Schmeisser and D. Lützow. *Angew. Chem.* **66**, 230 (1954);
D. Lützow. Thesis, Univ. München, 1955.

Chromyl Perchlorate

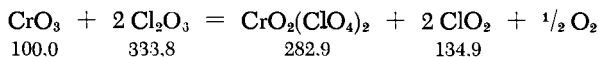
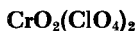

A two-neck flask is used; then, at -50°C , 5 g. of Cl_2O_3 , followed by 3 g. of CrO_3 , is added through one neck. This neck is then closed off either with a ground stopper lubricated with fluorinated hydrocarbon grease (see under Cl_2O , p. 299 f.), or by sealing off. The other neck leads to a manifold carrying sealable ampoules and a second, similar flask. The open end of the manifold is closed off with a P_2O_5 tube.

The cold bath is now replaced with a bath at $+6^{\circ}\text{C}$. The Cl_2O_3 melts, and the two components react vigorously. The reactor is allowed to stand at 0°C for several hours (preferably overnight). After this, no further gases are evolved.

The reactor is now cooled with liquid nitrogen and the entire system evacuated to about 0.1 mm. The cold bath is removed and the second flask (at the manifold) is cooled; within a few minutes, Cl_2 and ClO_2 distill with foaming. To remove these gases completely, the vessel is immersed in a bath at $+20^{\circ}\text{C}$ for one half hour and vacuum is applied. As soon as no further volatiles distill, the bath temperature is raised to about $35-36^{\circ}\text{C}$. The $\text{CrO}_2(\text{ClO}_4)_2$ now distills into the manifold and flows into the first ampoule (transparent red liquid). The manifold with the ampoules should be somewhat inclined. When sufficient compound has collected in the first ampoule, the latter is sealed off. Additional distilled product collects in the stub left from the first ampoule, and is driven into the next ampoule by heating with a hot-air blower.

PROPERTIES:

Red liquid, very sensitive to moisture. M.p. -1°C , b.p. (extrapolated) (760 mm.) 174.7°C ; (0.08 mm.) 35°C ; (0.8 mm.) 45°C . Powerful oxidant; dissolves in CCl_4 . May be stored for months in the dark at Dry Ice temperature. Often explodes at $+80^{\circ}\text{C}$.

REFERENCES:

M. Schmeisser. *Angew. Chem.* 67, 493 (1955); D. Lützow. Thesis, Univ. München, 1955.

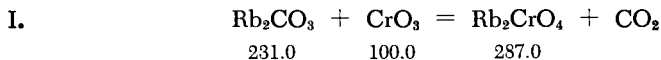
Rubidium Chromate

Obtained by evaporation of an aqueous solution of CrO_3 which has been neutralized with Rb_2CO_3 (or RbOH).

The by-product $\text{Rb}_2\text{Cr}_2\text{O}_7$ forms at even a very small excess of CrO_3 ; therefore somewhat more than the stoichiometric quantity of Rb_2CO_3 should be used.

II. Preparation analogous to that of Cs_2CrO_4 .

PROPERTIES:

Yellow, rhombic crystals, isomorphous with K_2CrO_4 and K_2SO_4 . Readily soluble in water (42% at 20°C).

REFERENCES:

L. Grandeau. *Ann. Chim. Phys.* (3) 67, 228 (1863); J. W. Retgers. *Z. phys. Chem.* 8, 39 (1891); Abeggs *Handbuch der anorg. Chemie* [Abegg's Handbook of Inorganic Chemistry], IV, 1, p. 362 (1921).

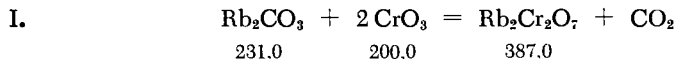
Rubidium Dichromate

Obtained by evaporation of stoichiometric mixtures of Rb_2CO_3 (or RbOH) and CrO_3 .

II. Preparation analogous to that of $\text{Cs}_2\text{Cr}_2\text{O}_7$.

PROPERTIES:

Trimorphic; forms A and B deposit together from solution above 35°C. Orange-colored monoclinic or red triclinic crystals. Moderately soluble in water (5% at 18°C).

REFERENCES:

L. Grandeau. Ann. Chim. Phys. (3), **67**, 227 (1863); Abeggs Handbuch der anorg. Chemie IV, 1, p. 362 (1921).

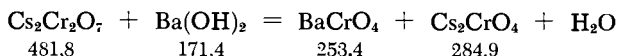
Cesium Chromate

A small excess of Ba(OH)_2 is added to a warm solution of $\text{Cs}_2\text{Cr}_2\text{O}_7$. The sparingly soluble BaCrO_4 is filtered off and the solution is concentrated until crystallization occurs.

PROPERTIES:

Yellow hexagonal or rhombic crystals, readily soluble in water.

REFERENCE:

J. H. de Boer, J. Broos and H. Emmens. Z. anorg. allg. Chem. 191, 113 (1930).

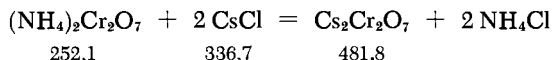
Cesium Dichromate

Reaction of warm solutions of $(\text{NH}_4)_2\text{Cr}_2\text{O}_7$ and CsCl , followed by cooling, yields orange-red crystals of $\text{Cs}_2\text{Cr}_2\text{O}_7$, which are still contaminated with about 5% of $(\text{NH}_4)_2\text{Cr}_2\text{O}_7$. To decompose the ammonium salt, the product is calcined at a low temperature. Recrystallization gives an excellent yield of pure $\text{Cs}_2\text{Cr}_2\text{O}_7$.

PROPERTIES:

Orange-red triclinic crystals; sparingly soluble in cold, readily soluble in hot water.

REFERENCE:

- J. H. de Boer, J. Broos and H. Emmens. *Z. anorg. allg. Chem.* 191, 113 (1930).

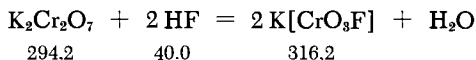
Potassium Fluorochromate

Powdered $\text{K}_2\text{Cr}_2\text{O}_7$ is heated in a Pt dish with excess of conc. HF until solution is complete. On cooling, $\text{K}[\text{CrO}_3\text{F}]$ separates as red crystals.

PROPERTIES:

Formula weight 158.11. Ruby-red bipyramids, readily soluble in water. Etches glass vessels in which it is stored. Crystal structure; tetragonal (space group C_{4h}^2).

REFERENCES:

- A. Streng. *Liebigs Ann.* 129, 227 (1864); J. A. A. Ketelaar and E. Wegerif. *Recueil Trav. Chim. Pays-Bas* 57, 1269 (1938).

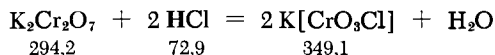
Potassium Chlorochromate

I. Fifty grams of fine $\text{K}_2\text{Cr}_2\text{O}_7$ powder is dissolved in a mixture of 65 ml. of conc. HCl and 50 ml. of water (by heating to 70°C). The solution is filtered through a jacketed funnel heated with hot water. After 1-2 days, the nascent crystals are filtered off with suction, recrystallized from glacial acetic acid, and dried in a vacuum desiccator over H_2SO_4 .

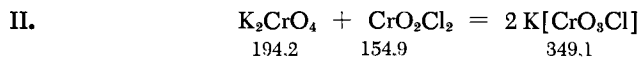

A three-neck flask is fitted with a stirrer, a thermometer, a dropping funnel, and a gas outlet tube. A solution of 75 g. of

K_2CrO_4 in 125 ml. of hot water is placed in the flask, and 86 g. of CrO_2Cl_2 is added dropwise with stirring. The temperature is held at 90-100°C by means of a Bunsen burner. Stirring is continued for 1 hour at the same temperature and the flask contents are then poured into a beaker. After 18 hours the nascent crystals are filtered off with suction and pressed together firmly to remove the mother liquor as thoroughly as possible without washing. The product is then placed on a clay plate, covered with a watch glass, and allowed to stand for 10 hours. Yield: 109 g. (81%, based on K_2CrO_4).

The mother liquor, cooled at 0°C for 1.5 hours, yields about 16 g. of less pure $K[CrO_3Cl]$. To purify this, 30 g. of the impure product is dissolved in 100 ml. of acetone, filtered, and 700-800 ml. of CCl_4 is added slowly with stirring; 16-17 g. of pure $K[CrO_3Cl]$ is thus obtained.

PROPERTIES:

Formula weight 174.56; d 2.497. Sparkling, orange-colored crystalline needles, soluble in glacial acetic acid and acetone. Undergoes hydrolytic cleavage in water. Heating the salt to 100°C causes loss of chlorine.

REFERENCES:

- I. L. Vanino. Handb. d. Präp. Chemie [Handbook of Preparative Chemistry], I, Stuttgart, 925, p. 321.
- II. H. H. Sisler in: W. C. Fernelius, Inorg. Syntheses, Vol. II, New York-London, 1946, p. 208.

Potassium Tetraperoxochromate (V)



Prepared from KOH, CrO_3 and H_2O_2 .

A mixture of 25 ml. of 50% CrO_3 solution, 100 ml. of 25% KOH, and 100 ml. of H_2O is cooled in a cold bath until ice begins to form. Now, 30 ml. of 30% H_2O_2 is added dropwise (with shaking), care being taken to keep the solution temperature from rising above 0°C. The initially red-yellow solution soon acquires a black-brown color. The salt which drops to the bottom of the vessel after 1-2 hours is filtered off with suction, washed with 95% alcohol until the washings are colorless, then with ether, and stored in a stoppered vessel. The yield is about 50%, based on the H_2O_2 used.

PROPERTIES:

Formula weight 297.30. Red-brown crystals, which may be stored for months without decomposition. Moderately soluble in cold water, insoluble in alcohol and ether.

REFERENCE:

E. H. Riesenfeld, H. E. Wohlers and W. A. Kutsch. Ber. dtsch. chem. Ges. 38, 1887 (1905).

Ammonium Pentaperoxodichromate



Prepared from NH_4Cl , CrO_3 and H_2O_2 .

The procedure for the blue ammonium salt is the same as that used for K_3CrO_8 (see above). The quantities used are: 100 ml. of H_2O , 5 ml. of conc. HCl , 10 g. of NH_4Cl , 10 ml. of 50% CrO_3 solution, and 25 ml. of 30% H_2O_2 . At the end, the product is washed only briefly with 90% alcohol.

PROPERTIES:

Formula weight 386.13. Violet-black crystalline powder consisting of flat prisms which show strong pleochroism (bright red-brown and dark blue-violet). May be stored for a few days in a cold desiccator; transforms completely to $(\text{NH}_4)_2\text{CrO}_4$ on 24-hour exposure in the air; decomposes explosively at 50°C to Cr_2O_3 . Soluble in ice water (violet-brown color).

REFERENCES:

E. H. Riesenfeld, H. E. Wohlers and W. A. Kutsch. Ber. dtsch. chem. Ges. 38, 1888 (1905); O. F. Wiede. Ber. dtsch. chem. Ges. 31, 518 (1898); R. Schwarz and H. Giese. Ber. dtsch. chem. Ges. 66, 310 (1933).

Diperoxotriamminechromium (IV)

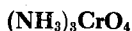

Prepared from ammonia, CrO_3 and H_2O_2 .

A mixture of 25 ml. of 10% ammonia and 5 ml. of 50% CrO_3 solution is treated dropwise at 0°C with 5 ml. of 30% H_2O_2 . The

resultant solution is first allowed to stand for one hour in a cooling mixture, and is then heated (together with the copious precipitate of $(\text{NH}_4)_2\text{Cr}_2\text{O}_7$ contained therein) to about 50°C until the vigorous evolution of gas ceases and the salt dissolves almost completely. Finally, the solution is filtered and cooled once more to 0°C . The $(\text{NH}_3)_3\text{CrO}_4$ which crystallizes is filtered off with suction, washed with absolute alcohol and ether, and dried in a desiccator over KOH. Yield: about 0.3 g.

SYNONYMS:

Chromium tetroxide triammine or triamminechromium tetroxide.

PROPERTIES:

Formula weight 167.11; $d^{15.8}$ 1.964. Light-brown needles, soluble in dilute ammonia and water (partial decomposition). Insoluble in other solvents. The product should be protected from moisture, but because of the danger of explosion, storage ampoules other than the type sealed by fusion of the outlet should be used.

REFERENCES:

- E. H. Riesenfeld. Ber. dtsh. chem. Ges. 38, 4070 (1905); O. F. Wiede. Ber. dtsh. chem. Ges. 30, 2180 (1897); for discussion of valence state, see S. S. Bhatnagar, B. Prakash and A. Hamid. J. Chem. Soc. (London) 1938, 1432.

Barium Orthochromate (IV)

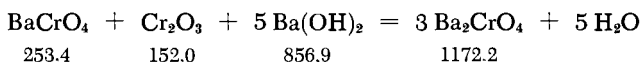

Stoichiometric quantities of the starting materials, which must be very pure and anhydrous, are thoroughly mixed. (However, a very small excess of $\text{Ba}(\text{OH})_2$, i.e., 0.03-0.06 moles BaO/atom Cr, must be provided. Any larger excess of the base will give rise, in the heating which follows, to partial or sometimes complete formation of tribarium chromate (IV), Ba_3CrO_5 . The latter is a heavy, blackish-green, glittering crystalline powder which appears olive-brown under the microscope.)

About 4 g. of the mixture is then heated in a sintered alumina boat in an O_2 -free nitrogen stream (2 hours at 900 - 950°C).

PROPERTIES:

Microcrystalline, heavy emerald green powder. Readily soluble in dilute HCl or HClO₄, even in the cold, with brownish yellow color. Water causes hydrolysis. Stable to methanol.

REFERENCE:

R. Scholder and G. Sperka. Z. anorg. allg. Chem. 285, 49 (1956).

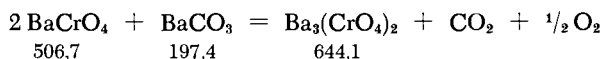
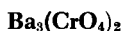
Barium Chromate (V)

An intimate mixture of 1 mole of BaCrO₄ and 0.50 moles of BaCO₃ is heated in an O₂-free nitrogen stream at 1000°C. Four hours of heating suffices for about 2 g. of reactants. The Ba₃(CrO₄)₂ product is of excellent purity.

PROPERTIES:

Black-green microcrystalline powder. Water causes gradual decomposition. Completely soluble in dilute acids, with disproportionation to Cr (III) and Cr (VI).

REFERENCE:

R. Scholder and W. Klemm. Angew. Chem. 66, 463 (1954).

Sodium Thiochromite

Prepared by reaction of K₂CrO₄ with a soda-sulfur melt.

An intimate mixture of 1 part of K₂CrO₄ with 30 parts of KNaCO₃ and 30 parts of sulfur is heated for 30-60 minutes in a covered sintered alumina crucible; the latter is placed in an electric furnace. The temperature is 750-850°C. After heating, the crucible is allowed to cool slowly. The cold melt is slurried in water, then washed by decantation several times with dilute NaOH. The thiochromite is filtered off and thoroughly washed, first with dilute alcoholic NaOH, then with pure alcohol, and finally with ether. The product is free of potassium despite the use of K salts.

PROPERTIES:

Formula weight 139.13; d 3.2. Crystalline gray-black aggregate with a greenish luster. Well-formed hexagonal leaflets are produced above 800°C ; these appear garnet-red by transmitted light. When moist, rapidly darkens and decomposes on exposure to air.

REFERENCES:

W. Rüdorff and K. Stegemann. *Z. anorg. allg. Chem.* 251, 379 (1943); R. Schneider. *J. prakt. Chem.* 56, 415 (1897).

Dibenzenechromium (0)

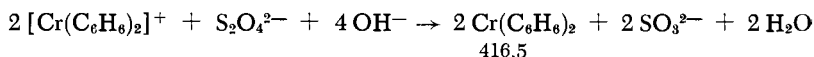
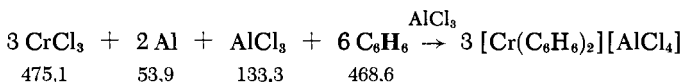

A 250-ml. three-neck flask is used, and 25 g. (0.16 moles) of anhydrous CrCl_3 , 3.5 g. (0.13 moles) of dry Al powder, and 60 g. (0.45 moles) of sublimed and rapidly ground AlCl_3 are weighed in. The flask is evacuated several times with an aspirator and refilled with dry, O_2 -free nitrogen. Then, 150 ml. of absolute benzene is introduced in a countercurrent stream of inert gas. The flask is again evacuated for several minutes to remove traces of HCl (with the evaporating benzene). Then, 10 drops (0.3 ml.) of mesitylene are added under protection of the N_2 blanket. The flask is now fitted with a reflux condenser carrying a mercury pressure-relief valve. A high-speed Hg-seal stirrer and a stopper are placed on the other necks.

The N_2 stream is cut off and the mixture is refluxed for 35-40 hours with vigorous stirring. The flask contents are cooled, then decomposed by pouring slowly (under N_2) into 200 ml. of CH_3OH contained in a 4-liter three-neck flask. The latter is cooled in ice; two of the necks are fitted with stopcocks and the third carries a high-speed Hg-seal stirrer. Then 200 ml. of H_2O is also added. When hydrolysis is complete, 2 liters of benzene is added, then a solution of 220 g. of KOH in 500 ml. of H_2O . Finally, 220 g. of solid sodium dithionite is rapidly introduced. After 2 hours of high-speed stirring, the dark-brown solution is carefully filtered with suction (in the absence of air) into an evacuated 3-liter flask,

which carries an N_2 inlet tube. The solution is dried with solid KOH. It is then transferred (under N_2) to a distillation apparatus, and the solvent is removed thoroughly on a hot water bath. The solid black residue is washed 3 times with absolute ether (under N_2) and then sublimed in high vacuum at $160^\circ C$. Yield: 29.5 g. (90% of theoretical).

PROPERTIES:

Black, diamagnetic crystals, sensitive to air. M.p. $284-285^\circ C$. Slightly soluble in ether and petroleum ether, giving a brown color; moderately soluble in benzene.

REFERENCES:

E. O. Fischer and W. Hafner. Z. Naturforsch. 10b, 665 (1955); Z. anorg. allg. Chem. 286, 146 (1956); E. O. Fischer, W. Hafner and J. Seeholzer. Private communication.

Bis(diphenyl)chromium (0)

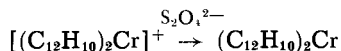

The melt is prepared and hydrolyzed in the same manner as described below for bis(diphenyl)chromium (I) iodide. The first filtrate is rejected.

An excess of alkaline sodium dithionite solution is added under N_2 to the later, pure orange-red filtrates, whereupon the bis(diphenyl)chromium (I) cation is reduced instantly and precipitates as bis(diphenyl)chromium (0). After standing for one half hour the precipitate is filtered off on a large, fine fritted-glass funnel and then dried for 1-2 days over P_2O_5 . It is then extracted with ether or pentane in the absence of air; the bis(diphenyl)chromium separates from the solvent in beautiful small crystals. These are filtered off, dried in vacuum, and stored under N_2 . Yield: 10 to 12 g.

PROPERTIES:

Crystals with brasslike luster. M.p. (not sharp) at $112^\circ C$. Soluble in ether, alcohol, benzene, etc.; diamagnetic. Limited stability in air when dry. Dibenzenechromium (0) and diphenylbenzenechromium (0) can be prepared from the corresponding chromium (I) salts in essentially the same way.

REFERENCES:

- E. O. Fischer and D. Seus. Chem. Ber. 89, 1814 (1956); F. Hein and W. Kleinwächter. Private unpublished communication.

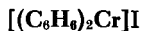
Dibenzenechromium (II) Iodide

Ten grams (0.05 moles) of $Cr(C_6H_6)_2$ fine powder is shaken with 200 ml. of benzene and 100 ml. of H_2O in a separatory funnel, while air is passed through, until all the solid dissolves and the benzene phase becomes virtually colorless. The yellow-brown aqueous layer is filtered and treated with saturated aqueous KI solution (stirring) until no further yellow precipitate separates out. After cooling in ice, the precipitate is filtered off, washed 3 times with some C_2H_5OH , and finally with ether. It is then dried in vacuum. Yield: 10.5 g., or 65% based on $Cr(C_6H_6)_2$.

PROPERTIES:

Egg-yellow, stable in air, moderately soluble in H_2O .

REFERENCES:

- E. O. Fischer and W. Hafner. Z. anorg. allg. Chem. 286, 146 (1956); E. O. Fischer. Private communication.

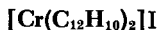
Bis(diphenyl)chromium (II) Iodide

Ten grams of sieved, anhydrous $CrCl_3$ dust, 8 g. of Al powder, 27 g. of sublimed diphenyl, and 30 g. of $AlCl_3$ (powdered in a mortar) are separately dried for one half hour in an oven at $110^\circ C$. Then, the $CrCl_3$ is mixed intimately with the Al powder, and the biphenyl with the $AlCl_3$. The two mixtures are then blended thoroughly with each other in a 150-ml. beaker placed in a drying oven. Finally, the total mixture is covered with a layer of pure biphenyl (3-4 g.), and the beaker is covered with a watch glass. The beaker is now placed in a silicone oil bath preheated to $100^\circ C$, and the bath temperature is slowly raised to $110^\circ C$. As soon as the reaction begins ($110-120^\circ C$, melting of the mass, followed by puffing up and evolution of HCl vapors), the heating of the oil bath is discontinued. The heat of reaction causes the

temperature of the mixture to rise spontaneously to 140-150°C. After 10 minutes the melt is stirred vigorously with a thermometer, care being taken to keep the temperature from rising above 160°C. The reaction is allowed to complete itself in one half hour. During this time, the oil bath temperature is kept at 120°C. Careful conduct of the melt reaction is most important in this preparation.

The beaker with the melt is now cooled to room temperature. The melt is added with a spatula to 100 ml. of methanol (addition in portions) in an 800-ml. beaker placed in an ice bath. An orange-red to brown solution forms; cold, saturated NaCl solution is then added with stirring. This yields an easily filtered product which is separated once on a 15-cm. Buchner funnel. Then about 3 g. of solid KI is added to the acidic, dark-brown filtrate; this causes precipitation of the bis(diphenyl)chromium (I) cation present. However, most of the product is in the filtration residue, and is obtained by leaching the residue several times (on the funnel) with 100-ml. portions of water, followed by suction-drying. Before each leaching, a fast stream of air is drawn through the filter cake for 10-15 minutes, in order to oxidize any remaining chromium (0) to the monovalent state. The leaching is discontinued when the wash water becomes almost colorless. The bis(diphenyl)chromium (I) iodide is reprecipitated by stirring about 8-10 g. of solid KI into the filtrate. It is filtered off with suction and washed with water, then 10 ml. of alcohol and two 10-ml. portions of ether. Yield: 22-25 g. The crude product is already very pure; it can be recrystallized from alcohol.

PROPERTIES:

Formula weight 487.33; m.p. 157°C. Depending on size, orange to reddish black crystals. Soluble in pyridine, alcohol, chloroform, acetone; almost insoluble in benzene and water; insoluble in ether and naphtha. Not sensitive to dilute hydrochloric acid.

REFERENCES:

F. Hein. Ber. dtsch. chem. Ges. 54, 2716 (1921); E. O. Fischer and D. Seus. Chem. Ber. 89, 1814 (1956); F. Hein and W. Kleinwächter. Unpublished private communication.

(Diphenyl)(benzene)chromium (I) Iodide



All operations are conducted under pure N₂ in the absence of moisture.

A Grignard solution is prepared from 37 g. of magnesium, 235 g. of bromobenzene and 900 ml. of absolute ether. After the

end of the reaction, the solution is decanted from the unreacted Mg into a 1.5-liter sulfonation flask, which is provided with a stirrer, a thermometer, a tap-injection bulb from which solid reagents can be added, and inlet and outlet tubes for N_2 .

The solution is cooled to -15 to $-18^\circ C$. Vigorous stirring and good cooling are provided, and 40 g. of sublimed $CrCl_3$ is tapped from the bulb into the flask at a uniform rate; total addition time: 2 to 3 hours. (The $CrCl_3$ is preextracted with boiling HCl, washed, dried, and sieved through a U. S. standard 60-mesh screen.) The reaction temperature should not rise above $-12^\circ C$. The mixture becomes black-brown. After the addition of $CrCl_3$, stirring is continued 2 to 3 hours. After standing overnight in an ice chest, the mixture is stirred thoroughly and decomposed by pouring it slowly onto an ice- H_2SO_4 mixture (750 g. of ice, 25 ml. of conc. H_2SO_4) contained in a 4-liter breaker. The addition proceeds in air and with constant stirring while the beaker is immersed in an ice-salt bath. The yellow-red ethereal emulsion is rapidly decanted into a dish and the ether is driven off. The aqueous layer is filtered through a suction funnel with the largest possible filtering surface.

The residue from the ethereal layer is stirred with approximately 50 ml. of 50% KI and 50 ml. of saturated Na_2SO_3 solution, and is then thoroughly extracted with chloroform (shaking in a separatory funnel) until the solvent is only slightly yellow. The aqueous solution, which contains KI, is combined with the filtrate from the aqueous layer and similarly extracted with chloroform. The residue from the filtration of the aqueous layer, the filter paper, the funnel, and all vessels are also extracted with chloroform. The combined orange-colored chloroform extracts (which contain the crude iodide) are washed twice, each time with 15 ml. of KI and 10 ml. of Na_2SO_3 solutions, then once with 25 ml. of H_2O , and dried for 24 hours over anhydrous potassium carbonate. The filtered chloroform solution is concentrated, under anhydrous conditions, in aspirator vacuum at a bath temperature of 25 to $30^\circ C$. The residual viscous mass is rinsed into a dish with a minimum amount of chloroform. To remove diphenyl, the material is triturated, first with 100-ml. portions and later with 30-ml. portions of absolute ether, until a sample of extract shows almost no residue on evaporation. A total of 1.5 to 2 liters of absolute ether is required. The viscous, red-orange, crude iodide hardens and becomes powdery as the extraction of diphenyl progresses. It is dried over P_2O_5 in vacuum. It may be kept for months if stored in a cool place away from light. Yield: 35-40 g. of crude iodide. It is composed of bis(diphenyl)chromium (I) iodide, (diphenyl)(benzene)chromium (I) iodide (the principal constituent), and a very small percentage of dibenzenechromium (I) iodide.

To obtain pure (diphenyl)(benzene)chromium (I) iodide, the procedure is as follows: 39 g. of crude iodide is dissolved in 900 ml. of methanol, treated with 300 ml. of water, and passed through an anion exchange column (e.g., OH form of Wofatit L 150 or Amberlite IRA 410; 150 g. of dry material in 70% methanol) at a rate of 3 ml./min. The column is then eluted with 70% alcohol and the yellow to orange fraction of the filtrate is collected in the absence of CO_2 . This fraction is concentrated in aspirator vacuum at a bath temperature of 30-35°C until a methanol-free solution remains. This is filtered to remove a slight cloudiness (diphenyl). The clear, filtered solution is diluted to 300 ml. with water and treated with a solution of 18 g. of anthranilic acid (m.p. 145°C) and 12 g. of KOH in 60 ml. of H_2O while cooling the flask in ice; this treatment causes the $(\text{C}_{12}\text{H}_{10})_2\text{Cr}$ (I) anthranilate to deposit as an orange-yellow, amorphous precipitate. After standing for 3 hours, the precipitate is removed by filtration through a very fine fritted-glass funnel. The filtrate is treated with 20 g. of solid KI in a separatory funnel. The $(\text{C}_{12}\text{H}_{10})$ - $(\text{C}_6\text{H}_5)\text{CrI}$ separates at once as an oil. The oil is extracted with chloroform until the latter is only slightly yellow. The combined chloroform extracts are thoroughly shaken with some 20% KI solution, and then with a very small quantity of water; the extracts are then dried for several hours over potassium carbonate. The filtered solutions are concentrated by distilling off the chloroform in vacuum (under anhydrous conditions) at a bath temperature of 30-35°C. Finally, about a 10-fold quantity of absolute ether is added, causing an orange-red oil to separate; this gradually solidifies and can be ground under ether. The supernatant ether layer is replaced 2 or 3 times to remove the chloroform. The powder is filtered off under anhydrous conditions, washed several times with ether, and dried in a drying pistol at 2 mm. and 55-60°C (using acetone as the heating medium). The product is recrystallized by dissolving in absolute alcohol at 60-70°C (anhydrous conditions), filtering through a very fine fritted-glass funnel while still hot, and storing overnight at -20°C. This yields massive orange-red crystals. The $(\text{C}_{12}\text{H}_{10})(\text{C}_6\text{H}_5)\text{CrI}$ can also crystallize in golden-yellow hexagonal leaflets, but these transform into the orange-red crystals after standing for several days in the mother liquor.

Since the $(\text{C}_{12}\text{H}_{10})(\text{C}_6\text{H}_5)\text{CrI}$ often separates as an oil, seeding the solution may be helpful. The precipitation can be completed by very slow addition of a 3- to 5-fold quantity of ether. The precipitate is filtered off under anhydrous conditions, washed twice with some 1:1 absolute ether/absolute ethanol, twice with absolute ether, and then dried to a constant weight in a drying pistol at 2 mm. and 55-60°C (using acetone as the heating medium). This drying quantitatively removes the ether, which otherwise adheres tenaciously. Yield: 26 g. of $(\text{C}_{12}\text{H}_{10})(\text{C}_6\text{H}_5)\text{CrI}$.

The (diphenyl)(benzene)chromium (I) iodide can also be prepared by a reductive Friedel-Crafts reaction, starting with an appropriate mixture of benzene, diphenyl, CrCl_3 , AlCl_3 and Al powder. The reaction can be carried out under reflux at atmospheric pressure, but again affords (diphenyl)(benzene)chromium in a mixture with dibenzenechromium and bis(diphenyl)chromium. After conversion to the iodides, they must be separated from each other in a manner analogous to that given above.

The yield in this method, even under the most favorable conditions, is lower than that of the Grignard procedure.

PROPERTIES:

Formula weight 411.33. Red-orange, massive, somewhat light-sensitive crystals. M.p. approximately 160°C (decomp.). Can be stored in vacuum or under N_2 in the dark. Readily soluble in pyridine; soluble in chloroform, alcohol and acetone; less soluble in water; insoluble in ether, benzene and petroleum ether.

REFERENCES:

- F. Hein. Ber. dtsh. chem. Ges. 54, 2741 (1921); F. Hein and H. Meininger. Z. anorg. allg. Chem. 145, 115 (1925); F. Hein and E. Markert. Ber. dtsh. chem. Ges. 61, 2261 (1928); F. Hein, P. Kleinert and E. Kurras. Z. anorg. allg. Chem. 289, 229 (1957); H. H. Zeiss and M. Tsutsui. J. Amer. Chem. Soc. 79, 3062 (1957); F. Hein and K. Eisfeld. Z. anorg. allg. Chem. 292, 162 (1957).

Molybdenum

Mo

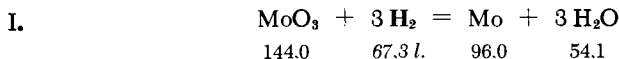

The MoO_3 is obtained by heating ammonium molybdate. Since MoO_3 is volatile at higher temperatures, it is pre-reduced in a stream of hydrogen at about 500°C to the nonvolatile lower oxides. The oxides are then reduced to the metal at about 1000°C . The product is allowed to cool in an H_2 stream, and the metal is obtained as a gray-black powder.

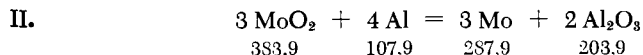

Because of the volatility of MoO_3 , the starting material is MoO_2 , which is obtained by reduction of MoO_3 with H_2 at

dark-red heat. A clay crucible embedded in dry sand is used, and a mixture of 80 g. of MoO_2 and 21 g. of Al powder (or, better, Al granules the size of grains of sand) is placed in it. The mixture is caused to react by means of an ignition mixture.* After cooling the crucible is broken up, and the solid melt of Mo, weighing about 50 g. (about 90% yield), is isolated. If 60 g. or 40 g. of MoO_2 is charged, the yield drops to 70-80%. The metal contains 98-98.5% Mo as well as some Si, Fe and Al.

PROPERTIES:

Solid Mo is bright, with a silvery luster. Powder is light- to black-gray, depending on particle size. M.p. 2620°C ; d 10.23; hardness 5.5. Attacked (with difficulty) by nonoxidizing acids and aqueous alkalis. Crystal structure: A 2 type.

REFERENCES:

- H. Funk. *Darst. der Metalle im Laboratorium* [Preparation of Metals in the Laboratory], Stuttgart, 1938, p. 69 f.; H. Biltz and R. Gärtner. *Ber. dtsch. chem. Ges.* **39**, 3370 (1906).

Dibenzemolybdenum (0)

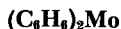

An intimate mixture of 4 g. (0.015 moles) of MoCl_5 , 3 g. (0.023 moles) of anhydrous fine AlCl_3 powder and 1 g. (0.04 g.-atoms) of Al powder is placed in a glass combustion tube of about 75-ml. capacity. About 30 ml. of absolute benzene is then added. The tube is evacuated, sealed, placed in an iron protective tube, and heated in a horizontal position for 15 hours at 120°C .

After cooling, the tube is carefully opened and the dark-colored contents are decomposed with 20 ml. of methanol (cooling) and then treated with 75 ml. of water. The residue is filtered off on a

*Ignition mixture (German "Zündgemisch" or "Zündkirsche"—ignition cherry) is made from 15 parts by weight of barium peroxide and 2 parts of powdered magnesium metal, intimately mixed and held together with collodion. The whole is wrapped with magnesium ribbon, a piece of the ribbon serving as the fuse. Magnesium burns with the evolution of much heat; the barium peroxide furnishes the large amounts of oxygen needed for such forced combustion (H. Blücher, *Auskunftsbuch für die chemische Industrie* [Data Book for the Chemical Industry], 18th ed., de Gruyter, Berlin, 1954, p. 1314).

fritted-glass funnel. The dark-colored filtrate is transferred to a 500-ml. three-neck flask, carefully prepurged with N_2 . The solution is covered with 200 ml. of benzene, and 10 g. of potassium diaminomethanedisulfinate $(NH_2)_2C(SO_2K)_2$ [or the same amount of formamidinesulfinic acid $(NH_2)_2CSO_2$] is added with vigorous stirring. Next, 60 ml. of conc. ammonia is added (under a protective nitrogen atmosphere). This gives rise to a green color in the nascent suspension, as well as in the benzene. After two hours of stirring, the green benzene solution is decanted (in the absence of air) into a fairly large Schlenk tube (see Part I, p. 75) which has been carefully prepurged with N_2 ; it is then dried with solid KOH.

A green crystalline residue remains after vacuum removal of the benzene. This is transferred to a sublimation vessel (complete exclusion of air) and sublimed in high vacuum at 100-105°C.

Yield: with $(NH_2)_2C(SO_2K)_2$, 1 g.; with $(NH_2)_2CSO_2$, 0.7 g.; or 27 and 20% of theoretical, respectively (based on $MoCl_5$).

PROPERTIES:

Green crystals, extremely sensitive to air; decomp. 115°C. Soluble in organic media such as benzene, ether and petroleum ether. Insoluble in water. Very sensitive to oxidation.

REFERENCE:

E. O. Fischer and H. O. Stahl. Chem. Ber. 89, 1805 (1956).

Molybdenum (II) Chloride

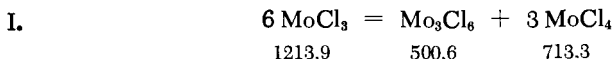

Heating of 20 g. of pure $MoCl_3$ to red heat in a small boat placed in an O_2 -free nitrogen stream gives bright yellow, analytically pure Mo_3Cl_4 (93% yield).

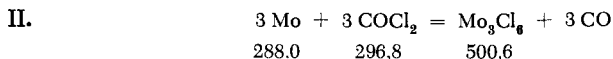

A stream of $COCl_2$ (3 bubbles/sec.) is allowed to react with 8 g. of very pure Mo in a Vycor tube (30 minutes at about 610°C). Yield is 90%; 0.5% is lost in the form of side products; the remainder is unreacted Mo. Heating is carried out with a thermostatically controlled electric furnace precalibrated to 610°C.

The sintered reaction mass is finely ground and extracted several times with a mixture of 95 parts of ether and 5 parts of alcohol (reflux). The filtered, golden-yellow solution gives (in vacuum) a scalelike residue which crumbles to a light-yellow dust when ground. This compound corresponds to the formula $\text{Mo}_3\text{Cl}_6 \cdot \text{C}_2\text{H}_5\text{OH}$; the alcohol cannot be removed without decomposing the product.

PROPERTIES:

Amorphous, dull-yellow powder, stable in air. Infusible, non-volatile; d_4^{25} 3.714. Insoluble in water, glacial acetic acid, toluene and naphtha. Soluble in alcohols, acetone and pyridine.

REFERENCES:

- I. W. Biltz and C. Fendius. *Z. anorg. allg. Chem.* **172**, 384 (1928); S. Senderoff and A. Brenner. *J. Elektrochem. Soc.* **101**, 28 (1954).
- II. K. Lindner, E. Haller and H. Helwig. *Z. anorg. allg. Chem.* **130**, 210 (1923).

Molybdenum (III) Chloride

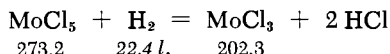

The reaction tube shown in Fig. 320 is used both for the preparation of MoCl_5 (see p. 1405) and the subsequent reduction to MoCl_3 .

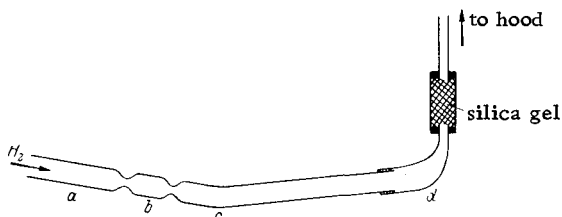

Fig. 320. Preparation of molybdenum (III) chloride. The lengths of the individual tube sections are: *a* 32 cm., *b* 8 cm., *c* 60-75 cm. The I.D. is 2-2.5 cm., 1-1.2 cm. at the constrictions.

Six grams of Mo powder is placed at *a*, and MoCl_5 is prepared from it (see next preparation); the product is then sublimed into *b* and *c* by means of a Cl_2 stream. After cooling, the Cl_2 is displaced with CO_2 , and this, in turn, with dry, O_2 -free hydrogen. The left end (near its lowest part) of zone *c* is now heated to about 250°C , so that a 5- to 10-cm. section of the tube is filled with red vapor. After some time, a white mist of HCl appears at the tube end adjacent to the moisture-retaining silica gel tube. Continued volatilization of the MoCl_5 (which keeps dropping into the lowest section of the tube) results in a copper-red coating.

The heat source is gradually shifted to the right, until all the MoCl_5 is transformed into MoCl_3 . Overheating should be scrupulously avoided. The reaction requires 2-3 hours. At the end, the H_2 is replaced by dry CO_2 , and the remaining MoCl_5 is distilled from section *b* so that none of it remains in the MoCl_3 . The excess MoCl_5 is driven into adapter *d* (this tube is attached to the reactor by means of an asbestos seal). After cooling, the reactor tube is cut into several pieces and the crystals are pushed out with a glass rod. Yield: 4-6 g.

PROPERTIES:

Copper- to brown-red powder; d_4^{25} 3.578. Stable in air; sparingly soluble in pyridine; insoluble in water, alcohol and ether. Forms a blue solution with conc. H_2SO_4 .

REFERENCES:

- H. Biltz and W. Biltz. *Übungsbeispiele aus der unorganischen Experimentalchemie* [Exercises in Inorganic Experimental Chemistry], 3rd and 4th eds., 1920; W. Biltz and C. Fendius. *Z. anorg. allg. Chem.* **172**, 389 (1928); L. P. Liechti and B. Kempe. *Liebigs Ann.* **169**, 344 (1873); see also A. Rosenheim, G. Abel and R. Lewy. *Z. anorg. allg. Chem.* **197**, 200 (1931).

Molybdenum (V) Chloride

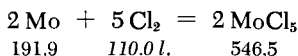

The apparatus shown in Fig. 321 is used for the chlorination of the Mo. During the experiment, an additional large-diameter piece of glass tubing is attached at *c* by means of a large-diameter

rubber hose. This glass tube is pointed upward. The left section of reaction tube *a-b* is charged with 6-10 g. of Mo (for preparation, see p. 1401). Then CO_2 and H_2 (both free of oxygen and very dry) are passed through the tube until the air is completely displaced from a wash bottle which is connected in series. The CO_2 flow is now shut off, and the Mo heated in the hydrogen stream for 1-2 hours (the temperature should be as high as possible). The water (which forms via reduction of the surface oxide layer) is driven off via the open end *c* by means of a burner and the tube is allowed to cool in the H_2 stream.

The oxide layer may also be reduced in an alternate procedure, whereby the Mo is heated in a dry HCl stream until no further wooly sublimate ($\text{MoO}_3 \cdot 2\text{HCl}$) is formed. The sublimate can be driven into the above mentioned glass tube by gentle warming (use a hood!). It is recommended that a drying tube or a wash bottle with conc. H_2SO_4 be attached at the end of the reaction tube to maintain anhydrous conditions. The outlet gases should pass through the drying arrangement before entering the hood.

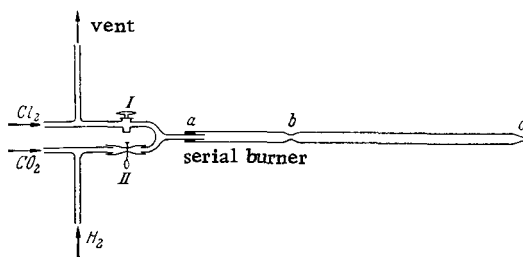

Fig. 321. Preparation of molybdenum (V) chloride. Overall length of reaction tube about 1 m.; part *a-b* 30 cm.; I.D. 2-2.5 cm. and 1-1.2 cm. at the constrictions.

Before chlorination, the tube is cooled, the attached wash bottle (conc. H_2SO_4) purged of air with Cl_2 , and the H_2 (or HCl) displaced from the tube with Cl_2 ; during this operation, pinchcock II remains closed. The reaction between Mo and Cl_2 either starts spontaneously or at most needs only very gentle heating with a serial burner for initiation. The reaction is accompanied by the appearance of streams of deep dull-red vapor which condense beyond the constriction *b*. By gentle heating of the Mo with a serial burner, as well as occasional heating of constriction *b* by fanning with a Bunsen flame, the MoCl_5 is collected in *b-c*, where it precipitates in a shower of very fine crystalline leaflets. Intense heating must be avoided. At the end, only a few small gray flakes remain at the left of *b*.

The tube contents are allowed to cool in a CO₂ stream, *c* is closed off with a cork, and *b* is sealed off with a torch. The crystals are loosened by tapping, and transferred to a CO₂-filled, 35-cm.-long storage tube of the same diameter as the combustion tube (the storage tube is slipped over constriction *c*). The storage tube is then sealed off.

PROPERTIES:

Blue-black, extremely hygroscopic crystals; dark green if oxychloride is present. M.p. 194°, b.p. 268°; d_4^{25} 2.927₅. Soluble in water and alcohol (solvolysis); soluble without decomposition in organic solvents such as ether, CHCl₃, CCl₄ and CS₂.

REFERENCES:

- H. Biltz and W. Biltz, *Übungsbeispiele aus der unorganischen Experimentalchemie* [Exercises in Inorganic Experimental Chemistry], 3rd and 4th eds., 1920, p. 216; W. Biltz and A. Voigt. *Z. anorg. allg. Chem.* 133, 299 (1924); P. Liechti and B. Kempe. *Liebigs Ann.* 169, 345 (1873); E. R. Epperson et al. *Inorg. Syntheses* 7, 163 (1963).

Molybdenum (III) Bromide

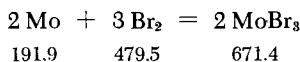

Obtained (75% yield) by heating Mo in a stream of Br₂ at 350°C. Separated from by-products by washing in cold, HBr-saturated water.

PROPERTIES:

Formula weight 335.70. Black, densely matted crystalline needles, which decompose to Mo₃Br₈ and Br₂ when calcined in the absence of air. Insoluble in water and acids, readily soluble in boiling anhydrous pyridine, forming [MoBr₃py₃].

REFERENCE:

- A. Rosenheim, G. Abel and R. Lewy. *Z. anorg. allg. Chem.* 197, 200 (1931).

Tribromotripyridinemolybdenum

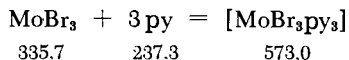

Five grams of MoBr_3 (see preceding preparation) is refluxed at 120°C with 20 g. of anhydrous pyridine (frequent swirling necessary). The hot pyridine solution is rapidly filtered (suction) to remove a small amount of residue and is then treated with conc. HCl until a weak acid reaction is obtained. The brown-yellow precipitate which forms is filtered off and washed with alcohol and ether. For purification the compound is extracted with chloroform in a Soxhlet apparatus. Crystal clusters consisting of small octahedra separate upon slow evaporation of the solution.

PROPERTIES:

Brownish-yellow needles; crystallize in octahedra from chloroform; soluble in pyridine; sparingly soluble in chloroform; insoluble in water, dilute acids, alcohol and ethyl acetate.

REFERENCE:

A. Rosenheim, G. Abel and R. Lewy. *Z. anorg. allg. Chem.* 197, 201 (1931).

Potassium Hexachloromolybdate (III)

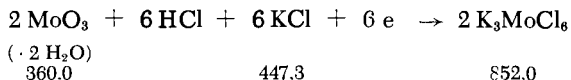

I. A solution of 20 g. of $\text{H}_2\text{MoO}_4 \cdot \text{H}_2\text{O}$ in 150 ml. of conc. HCl and 50 ml. of distilled water is electrolyzed for several hours at about 0.06-0.12 amp./in.²; the electrolysis vessel is water cooled and CO_2 is bubbled through the solution. The solution is thus reduced to the red, trivalent state.

Smooth Pt, Hg or amalgamated Pb may be used for the cathode. The carbon anode, immersed in 15% HCl , is separated from the cathodic electrolyte by a clay cell diaphragm.

The reduced solution is evaporated as rapidly as possible over a free flame until its volume is about 90 ml.; it is then saturated

with hydrogen chloride and treated with a deaerated 10% solution of 15-20 g. of KCl in distilled water. It is then concentrated at 70°C and reduced pressure until crystals begin to separate, filtered and resaturated with hydrogen chloride while cooling in ice. The crystals are suction-filtered, washed with conc. HCl, with alcoholic HCl and finally with alcohol; they are then dried in vacuum.

II. Potassium molybdate is dissolved in HCl and reduced at a cathode immersed in a clay cell. Gaseous HCl is bubbled through the cathode liquor to precipitate the K_3MoCl_6 .

PROPERTIES:

Formula weight 425.98. d^{18} 2.54. Brick-red crystals, readily soluble in water.

REFERENCES:

- I. W. R. Bucknall, S. R. Carter and W. Wardlaw. J. Chem. Soc. (London) 1927, 513; A. Rosenheim and W. Braun. Z. anorg. Chem. 46, 320 (1905).
- II. S. Senderoff and A. Brenner. J. Electrochem. Soc. 101, 28 (1954); see also K. H. Lohmann and R. C. Young in: J. C. Bailar, Inorg. Syntheses, Vol. IV, New York-London-Toronto, 1953, p. 97.

Molybdenum (IV) Oxide

MoO₂

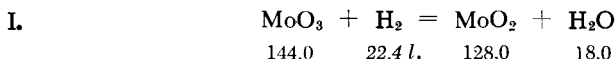

Molybdenum (VI) oxide is reduced for 5-7 hours in a stream of H₂ at 450°C; the oxide mixture is then calcined at dark-red heat in a porcelain boat while a stream of HCl is passed over it; this causes any remaining MoO₃ to volatilize as MoO₃ · 2 HCl. Finally the product is allowed to cool under H₂.

II. MELT REDUCTION OF MoO₃ WITH NH₃

The following method is useful for preparing pure MoO₂: Eight grams of dehydrated commercial ammonium molybdate, 7 g. of purified molybdic acid, 14 g. of calcined K₂CO₃, and 7 g. of H₃BO₃ are fused together in a large-capacity, covered Pt crucible and kept in the molten state for several hours. Cooling yields a

brittle cake, permeated with beautiful MoO_3 crystals; this is easily removed from the crucible. The pure crystals are readily separated by a simple extraction of the melt with boiling water.

III. A mixture of MoO_3 and Mo (2:1 mole ratio) is heated for 40 hours at 700°C in the absence of air.

PROPERTIES:

Brown-violet powder or crystals, insoluble in water; d_4^{26} 4.696. Crystal structure: C 4 (rutile) type.

REFERENCES:

- I. C. Friedheim and M. K. Hoffmann. Ber. dtsh. chem. Ges. 35, 792 (1902).
- II. W. Muthmann. Liebigs Ann. 238, 116 (1887).
- III. A. Magnéli, G. Andersson, B. Blomberg and L. Kihlborg. Analyt. Chem. 24, 1998 (1952).

γ -Molybdenum Oxide

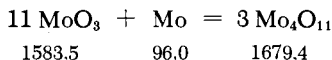

Very pure molybdenum powder and sublimed MoO_3 are intimately mixed and charged into a preignited alumina crucible, which is placed at the sealed end of a quartz tube. The mixture is degassed in high vacuum, purged frequently with O_2 -free argon, and then heated for 3 days at 580°C under an argon pressure of 150 mm. The product is allowed to cool, the material is reground to a fine powder, and reheated for 3 days in the same manner.

PROPERTIES:

Formula weight 559.80. Violet crystalline powder. Relatively stable to acids and alkalis. Concentrated HNO_3 causes slow oxidation to MoO_3 . Semiconductor material. d_4^{20} 4.18. Orthorhombic crystals (space group D_{2h}^{16}).

REFERENCES:

- G. Hägg and A. Magnéli. Ark. Kem. Mineral., Geol. 19 A, 1 (1944); O. Glemser and G. Lutz. Z. anorg. allg. Chem. 263, 2 (1950); A. Magnéli, G. Andersson, B. Blomberg and L. Kihlborg. Analyt. Chem. 24, 1998 (1952).

Lower Molybdenum Hydroxides

MOLYBDENUM BLUE, $\text{Mo}_4\text{O}_{10}(\text{OH})_2$

Obtained by reaction of nascent hydrogen with MoO_3 .

Fifty ml. of distilled water and 10 ml. of conc. HCl, followed by 3 g. of analytically pure zinc granules, are added to 10 g. of MoO_3 . The mixture is left standing overnight; the blue precipitate is then filtered off, washed until no chloride reaction is evident, and dried over P_2O_5 .

Alternate methods: a) Reduction with $\text{SnCl}_2 \cdot 2 \text{H}_2\text{O}$ in HCl solution.

b) Synthesis from MoO_3 and Mo powder (O. Glemser and G. Lutz, see below).

Other molybdenum blue compounds: See O. Glemser and G. Lutz (below).

PROPERTIES:

Formula weight 477.82. Blue crystalline powder. In air, oxidizes very slowly to MoO_3 . Stable to NH_3 and alkalis. Good electrical conductivity.

REFERENCE:

O. Glemser and G. Lutz. Z. anorg. allg. Chem. 264, 17 (1951).

$\text{Mo}_5\text{O}_5(\text{OH})_{10}$

This olive-colored hydroxide is obtained by the action of zinc granules on molybdenum trioxide in conc. HCl.

An Erlenmeyer flask is fitted with a water-filled valve to exclude air (Contat-Göckel attachment), whereupon 1 g. of MoO_3 is charged; 100 ml. of conc. HCl is then added, followed by about 50 g. of zinc granules. The solid phase first becomes blue [formation of $\text{Mo}_4\text{O}_{10}(\text{OH})_2$ and $\text{Mo}_2\text{O}_4(\text{OH})_2$], then red [$\text{Mo}_5\text{O}_7(\text{OH})_3$], and after about one hour green [$\text{Mo}_5\text{O}_5(\text{OH})_{10}$]. It is desirable to cool the flask with ice during the reduction. The $\text{Mo}_5\text{O}_5(\text{OH})_{10}$ is extremely sensitive to air; the latter must therefore be excluded during washing with water. The compound is dried with O_2 -free nitrogen and stored in sealed tubes.

PROPERTIES:

Oxidizes instantly in air, evolving heat. Evolves hydrogen on thermal decomposition in vacuum, forming Bordeaux red $\text{Mo}_5\text{O}_7(\text{OH})_3$. This is also the main product obtained in the reaction of aerated water with $\text{Mo}_5\text{O}_5(\text{OH})_{10}$.

REFERENCE:

O. Glemser, G. Lutz and G. Meyer. Z. anorg. allg. Chem. 285, 173 (1956).

Molybdenum (VI) Oxide



Prepared from ammonium molybdate and nitric acid.

Boiling conc. nitric acid is added to a boiling solution of pure, recrystallized ammonium molybdate, thus precipitating H_2MnO_4 . After standing for several hours, the granular precipitate is filtered off on a Büchner funnel, washed and dried for 16-20 hours at above 150°C , whereupon it dehydrates to MoO_3 . The MoO_3 may be purified by sublimation in a quartz tube at 780°C .

SYNONYMS:

Molybdenum trioxide; molybdic anhydride.

PROPERTIES:

Formula weight 143.95. White powder, turning yellow on heating and reverting to white on cooling. The sublimed product consists of sparkling, colorless crystalline flakes. M.p. 795°C , b.p. 1155°C ; d_4^{25} 4.696. Solubility at 28°C : 0.490 g. MoO_3 /liter H_2O . Crystal form: rhombic. Space group V_h^{16} .

REFERENCES:

W. C. Schumb and W. H. Hartford. J. Amer. Chem. Soc. 56, 2613 (1934); O. Hönigschmid and G. Wittmann. Z. anorg. allg. Chem. 229, 66 (1936).

Molybdic Acid



Prepared from ammonium molybdate and nitric acid.

An aqueous solution of ammonium molybdate (150 g./liter) is poured into 1 liter of 30% nitric acid [300 ml. of conc. HNO_3 (d 1.42) per liter] at room temperature (vigorous stirring). Then, 200 g. of solid NH_4NO_3 is dissolved in the clear liquid, which is then seeded with a few granules of $\text{H}_2\text{MoO}_4 \cdot \text{H}_2\text{O}$. On standing for

8-10 days $\text{H}_2\text{MoO}_4 \cdot \text{H}_2\text{O}$ separates in almost theoretical yield. The acid is washed for several days by repeated decantation with ice water.

PROPERTIES:

Formula weight 179.98. Transparent canary-yellow crystals, very sparingly soluble in water. Loses 1 mole of H_2O by standing for about 2 weeks in vacuum over H_2SO_4 . d^{15} 3.124. Monoclinic-prismatic crystals.

REFERENCE:

A. Rosenheim. Z. anorg. Chem. 50, 320 (1906).

Ammonium Oxopentachloromolybdate (V)

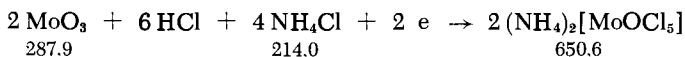

A) PREPARATION OF MoO_3 SOLUTION

The MoO_3 (100 g.) is dissolved in HCl (d 1.16, 500 ml.) by heating. The solution is concentrated to 250 ml., filtered and made up to 500 ml. with HCl .

B) ELECTROLYTIC REDUCTION

The above-prepared solution (75 ml.) is diluted with an equal volume of H_2O and electrolyzed at a platinized Pt cathode (surface = 5 cm.²) at 2.5 amp. until hydrogen evolves. The anode is made of smooth Pt sheet; it is immersed in 5 N HCl , which is separated from the cathode space by means of a clay cell.

The resulting red-brown solution is vacuum-concentrated to 50 ml. and treated with a solution of 9 g. of NH_4Cl in 30 ml of water; the mixture is heated for about one minute.

Hydrogen chloride is introduced while cooling the flask and emerald-green crystals are precipitated. These are recrystallized by dissolving in a minimum quantity of water at 80°C and saturating the solution with HCl while cooling. The crystals are washed with conc. HCl and dried in vacuum over KOH .

PROPERTIES:

Formula weight 325.32. Emerald-green octahedral crystals, which dissolve in water with hydrolysis and development of brown color.

REFERENCES:

- R. G. James and W. Wardlaw. *J. Chem. Soc. (London)* **1927**, 2146;
F. Foerster and R. Fricke. *Z. angew. Chem.* **36**, 458 (1923).

Potassium Hydrogen Diperoxomonomolybdate

Potassium molybdate solutions rich in H_2O_2 are treated with one equivalent of mineral acid per mole of molybdate, whereupon $\text{KHM}oO_8 \cdot 2 \text{H}_2\text{O}$ crystallizes.

PROPERTIES:

Formula weight 268.09. Long, pale yellow, crystalline needles.

REFERENCES:

- K. F. Jahr. *Ber. Ges. Freunde TH. Berlin* **1939**, 91; K. F. Jahr. *Naturforsch. u. Medizin in Deutschland [Scientific Research and Medicine in Germany]* 1939-1946 (FIAT Review) **25**, III, 189.

Tetraamminezinc Tetraperoxomolybdate (VI)

Prepared from ammonium molybdate, NH_4OH and ZnSO_4 by addition of H_2O_2 .

A mixture of 100 ml. of water, 100 ml. of conc. ammonia (d 0.91), and 20 ml. of an ammonium molybdate solution containing 1 g.-atom of Mo per liter is cooled to -12°C in an ice-salt mixture. Lower temperatures cannot be used, since water is frozen out (ice) at -14°C . Then 30 ml. of Perhydrol (30% H_2O_2) is added, followed by 20 ml. of 1 M ZnSO_4 solution (brief but thorough stirring). The solution is allowed to stand undisturbed for 1.5 hours at -12°C . After one half hour it is examined for signs of incipient crystallization. If none is observed, crystal formation is induced by careful rubbing of the flask walls with a glass rod. The crystals are filtered off, washed twice with ice-cold 96% alcohol and then twice with ice-cold ether. Yield: about 3 g.

PROPERTIES:

Formula weight 357.46. Deep red-brown, lustrous crystals; soluble in water (decomposition). Ammoniacal solutions are more

stable. Insoluble in organic solvents. Appreciably more stable than the corresponding potassium salt and barely explosive. However, it is not advisable to seal it into ampoules. May be stored in a desiccator over KOH and under NH_3 for about 1 week.

REFERENCE:

K. Gleu. Z. anorg. allg. Chem. 204, 73 (1932).

Molybdenum (IV) Sulfide

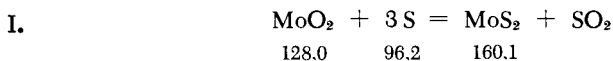

A mixture of 150 g. of K_2CO_3 , 310 g. of S, and 200 g. of MoO_2 is heated at red heat for one half hour. After cooling and extracting with water, the residue is 80 g. of MoS_2 . It is also possible to start with 200 g. of ammonium molybdate, 150 g. of K_2CO_3 , and 280 g. of S; this affords a more crystalline product, although in lower yield. According to Bell and Herfert, one may also start with MoO_3 , K_2CO_3 and S.



Stoichiometric quantities of Mo and S are heated in an iron tube. The MoS_2 thus obtained has the crystal lattice of natural molybdenite.

SYNONYM:

Molybdenum disulfide.

PROPERTIES:

Opaque, gray-blue leaflets with a greasy feel, or graphite-like powder. Sublimes at 450°C ; d^{15} 5.06. Soluble (decomposition) in aqua regia. Decomposed by H_2SO_4 to MoO_3 . Electrical conductor whose conductivity increases with illumination. Diamagnetic. Crystal structure: C 7 type.

REFERENCES:

- I. M. Guichard, Comptes Rendus Hebd. Séances Acad. Sci. 129, 1239 (1899); Ann. Chim. Phys. 7, 23, 552 (1901); R. E. Bell and R. E. Herfert. J. Amer. Chem. Soc. 79, 3351 (1957).
- II. A. E. van Arkel. Recueil Trav. Chim. Pays Bas 45, 442 (1926).

Ammonium Tetrathiomolybdate

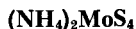

Prepared by treating an ammoniacal ammonium molybdate solution with H_2S .

A solution of 5 g. of $(\text{NH}_4)_6\text{Mo}_7\text{O}_{24} \cdot 4 \text{H}_2\text{O}$ in 15 ml. of water is prepared and treated with 50 ml. of ammonia (d 0.94). Then H_2S is introduced. The solution first turns yellow, later deep red, and after half an hour a copious quantity of crystals, some of them well-formed, precipitates suddenly. The crystals are washed with cold water, then with alcohol, and dried in vacuum.

PROPERTIES:

Formula weight 260.27. Blood-red crystals with metallic surface luster, readily soluble in water, very sparingly soluble in alcohol.

REFERENCE:

G. Krüss. Liebigs Ann. 225, 29 (1884).

Potassium Octacyanomolybdate (IV)



I. A solution of Mo (III) obtained by electrolytic reduction is oxidized to the quadrivalent state with a stoichiometric quantity of MoO_3 and is then treated with NH_4SCN and pyridine. The precipitate is converted to $\text{K}_4[\text{Mo}(\text{CN})_8] \cdot 2 \text{H}_2\text{O}$ by reaction with KCN.

A solution of 15 g. of pure MoO_3 in 150 ml. of 8 N HCl is reduced to the trivalent state at a lead cathode (5-10 amp.) while cooling the cathode cell (porous clay) with water and bubbling CO_2 through the solution. A graphite rod immersed in 15% HCl serves as the anode.

The reduced solution is treated with a solution of 7.5 g. of MoO_3 in 75 ml. of 8 N HCl; the solution thereby changes from red to green. The Mo (IV) salt solution thus obtained is poured into a concentrated solution of 95 g. of NH_4SCN ; 60 g. of pyridine is added, and the solution is made weakly alkaline with ammonia. These reactions are best carried out under CO_2 in the absence of air.

A black oil separates during the neutralization; this solidifies to a solid black tar on cooling with ice. The supernatant liquid is decanted; the tar is washed with water and added slowly to a hot,

saturated 10 M KCN solution. The reaction mixture is concentrated until crystals begin to deposit; it is then cooled in ice and filtered with suction.

The mother liquor is further concentrated and the cyano complex is precipitated with alcohol (rapid stirring). The crude product is dissolved in some water, the solution heated for some time with activated charcoal, filtered, concentrated by evaporation, and finally treated with alcohol. The precipitate of $K_4[Mo(CN)_8] \cdot 2 H_2O$ is fairly pure except for traces of thiocyanate, which can be removed by an additional recrystallization. Yield: about 55 g.

Alternate methods:

II. The product of the reaction of MoO_3 with HSCN and pyridine is treated with KCN. The yield is low. (See original reference for details.)

III. Via the following intermediates:

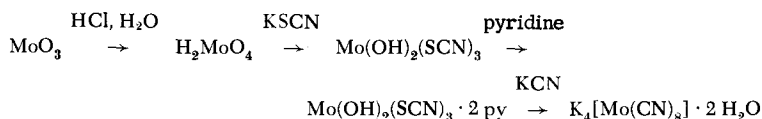

PROPERTIES:

Formula weight 496.50 (dihydrate). Golden or bright-yellow tablet-shaped crystals (rhombohedral bipyramidal); gives up its water of crystallization at 105-110°C. Very readily soluble in water, insoluble in ether. Solubility in absolute alcohol at 20°C: 0.017 g. per liter. d_4^{25} (anhydrous salt) 2.337.

REFERENCES:

- I. H. H. Willard and R. C. Thielke. *J. Amer. Chem. Soc.* **57**, 2610 (1935).
- II. A. Rosenheim. *Z. anorg. Chem.* **54**, 97 (1907); see also W. Biltz, E. Eschweiler and A. Bodensiek. *Z. anorg. allg. Chem.* **170**, 168 (1928).
- III. N. H. Furman and C. O. Miller in: L. F. Audrieth, *Inorg. Syntheses*, Vol. III, New York-Toronto-London, 1950, p. 160.

Tungsten

W

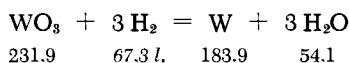

Pure ignited WO_3 is placed in a porcelain or, better, a nickel boat, which is then inserted into a tube of unglazed porcelain or

other refractory material. The tube is heated by means of an electric furnace while passing through a stream of pure, dry H_2 . The initial temperature is $800^\circ C$ (maintained for some time), later $1000-1200^\circ C$. The reduction proceeds fairly rapidly and is complete when no further H_2O vapor evolves. The tube is allowed to cool in the H_2 stream. Gray metal powder is the product.

Other authors report that the reduction with very pure H_2 may even be completed at $800^\circ C$ (8 hours of heating).

The particle size of the metal powder does not depend on that of the starting WO_3 , but (principally) on the reaction temperature, as well as the heating time and the H_2 flow rate. An especially fine tungsten powder is obtained when the above directions are followed; a very coarse powder results from reduction with moist H_2 above $1500^\circ C$. The product is pure if the starting WO_3 is also pure.

Alternate method:

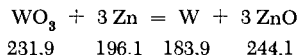

Pure, freshly ignited WO_3 is cooled and mixed with 1.5 times the theoretical quantity of dry Zn dust. This mixture is compressed in a crucible and overlaid with another 3- to 5-mm. layer of Zn dust, which is similarly compressed. The crucible is then closed off with a well-fitting cover and heated briefly to red heat. A vigorous reaction ensues after about 5 minutes, as shown by a cloud of evolving ZnO. The crucible is then allowed to cool completely while still covered. The light-gray top layer, composed principally of ZnO, is removed. The black crucible contents are crushed and thoroughly boiled with dil. HCl to remove ZnO and any Zn still present. The black residue is allowed to settle for a moment and the acid is decanted. The metal powder is washed by decantation with water once or twice, filtered rapidly with suction, and rewashed with water. In this operation the powder must always be covered with liquid. Finally the metal is washed with alcohol, suction-filtered, and dried in air. Careful preparation should yield a black powder containing at least 99.8% W.

SYNONYM:

Wolfram.

PROPERTIES:

Tungsten powder is gray to black, depending on particle size; the solid exhibits a light gray, lustrous surface. M.p. $\sim 3650^\circ C$, b.p. $> 5000^\circ C$ (calculated from the vapor pressure curve); d 19.3. Hardness 4.5-8, depending on the history. Crystal structure: A 2 type.

REFERENCES:

- H. Funk. *Darstellung der Metalle im Laboratorium* [Preparation of Metals in the Laboratory], Stuttgart, 1938, p. 72 f.; O. Ruff. *Angew. Chem.* **25**, 1892 (1912); O. Glemser and H. Sauer. *Z. anorg. allg. Chem.* **252**, 145 (1943); M. Delépine. *Comptes Rendus Hebd. Séances Acad. Sci.* **131**, 184 (1900); L. Weiss and A. Martin. *Z. anorg. allg. Chem.* **65**, 308 (1910).

Tungsten (V) Chloride

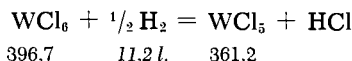

Reduction of WCl_6 vapor with H_2 for too short a period of heating and at too low a temperature results in hexachloride-containing WCl_6 . Too high a temperature affects the yield adversely, since considerable amounts of lower chlorides form.

A tube of high-melting glass (Fig. 322) is used. The WCl_6 produced in section *a* is distilled into the 50-cm.-long section *b* in a stream of H_2 . Section *b* is heated to the reduction temperature, which lies somewhat above the boiling point of WCl_6 (350–400°C, electric furnace). The WCl_5 is distilled into storage tube *c* in a stream of N_2 , thereby separating it from the lower chlorides; tube *c* is then sealed off at both ends.

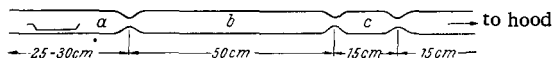

Fig. 322. Preparation of tungsten (V) chloride.

PROPERTIES:

Black, crystalline solid with somewhat greenish luster. Extremely hygroscopic. M.p. 248°C; d_4^{25} 3.875. Water causes immediate decomposition; somewhat soluble in dry CS_2 .

REFERENCES:

- H. E. Roscoe. *Liebigs Ann.* **162**, 356 (1872); W. Biltz and A. Voigt. *Z. anorg. allg. Chem.* **133**, 301 (1924); W. Biltz and C. Fendius. *Ibid.* **172**, 385 (1928); W. Klemm and H. Steinberg. *Ibid.* **227**, 193 (1936).

Tungsten (VI) Chloride



Prepared in a Vycor tube with several constrictions (Fig. 323). A quartz tube is even better and the special apparatus described by Hönigschmid and Menn is the best.

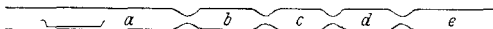
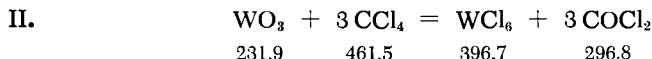

Fig. 323. Preparation of tungsten (VI) chloride.

A procelain or quartz boat containing W powder is placed in section *a* and is heated for 1-2 hours in a stream of H_2 (700-1000°C). After cooling, the H_2 flow is discontinued, the H_2 displaced by N_2 ; after about 30 minutes, air-free Cl_2 (see p. 272 for preparation) is introduced.

The tube area containing the boat is gradually heated to 600°C. The first product is a small amount of red oxychloride; later products consist only of blue-black hexachloride, which deposits in section *a* (beyond the heated boat) in the form of sparkling crystals. The tube constrictions are kept at 350-400°C during the chlorination, which requires 2-3 hours. Next the red oxychloride forerun is driven into *e*; then the WCl_6 collected in *a* is sublimed into *b* at 350-400°C, while an additional forerun deposits in *c*. For further purification, the WCl_6 can be sublimed into *c* (the oxychloride is moved into *d* prior to this sublimation). Finally, the WCl_6 is fused in a stream of Cl_2 ; on resolidification, the mass bursts into small crystals with a loud crackling noise. After cooling, the Cl_2 is displaced with dry, O_2 -free nitrogen and the tube section containing the purified WCl_6 is sealed off at both ends.



The chief requirements in this method are the presence of an excess of CCl_4 , completely anhydrous conditions, and thorough completion of the reaction; if these conditions are not observed, red by-product WOC_2Cl_4 forms readily. Moreover, the WOC_2Cl_4 has the undesirable property of catalyzing the hydrolysis of WCl_6 in moist air.

A dry glass bomb tube about 50 cm. long is charged with 0.5 g. of WO_3 and 11 g. of CCl_4 (the WO_3 must be completely dehydrated by previous ignition, after which it should be pure yellow; the CCl_4

is predried by long standing over granular CaCl_2 or P_2O_5 and is saturated with Cl_2 . The tube is then sealed. The water vapor from the torch flame should not be allowed to enter the tube. The tube is placed in a protective iron jacket and slowly heated (1.5-2 hours) to about 450°C ; it is kept at this temperature for 7-8 hours. After slow cooling, the tube is very carefully transferred to a well-drawing hood without removing it from its protective iron tube. The latter is inclined and clamped to a support. The sealed tip of the glass tube is then heated at low hood vacuum until the phosgene, present in the tube under high pressure, blows the tip away. The phosgene is driven out by vacuum as far possible, the CCl_4 poured off, the residual solid washed once with fresh CCl_4 , and the reactor tube connected to an aspirator via a CaCl_2 drying tower. All the CCl_4 is volatilized and the tube is resealed since the beautiful, almost black crystals of WCl_6 hydrolyze in air to yellow-red WOCl_4 and yellow WO_2Cl_2 . Proper procedure yields an almost black solid with no red or yellow spots.

PROPERTIES:

Blue-black, moisture-sensitive crystals. M.p. 275°C , b.p. 347°C ; d_4^{25} 3.520. Indefinitely stable if stored in a dark desiccator over H_2SO_4 . Very slightly soluble but decomposed in water; the purer the WCl_6 , the lower the decomposition rate. Very readily soluble in alcohol (with yellow color), CHCl_3 , CCl_4 (with red and dark-brown color, respectively), CS_2 , ether, benzene, ligroin and acetone. These solutions decompose on long standing in air, and very rapidly on heating or addition of water. Good crystals are obtained by heating WCl_6 in CCl_4 to 100°C in a sealed tube, followed by slow cooling (rectangular tablets and four-sided prisms). Crystallizes in space group C_{3i}^2 .

REFERENCES:

- I. O. Höning Schmid and W. Menn. Z. anorg. allg. Chem. 229, 58 (1936); see also M. H. Lietzke and M. L. Holt in: L. F. Audrieth, Inorg. Syntheses, Vol. III, New York-Toronto-London, 1950, p. 163.
- II. W. Jander. Lehrbuch für das anorganisch-chemische Praktikum [Lab. Text for Inorg. Chemistry], 5th ed., Leipzig, 1944, p. 403.

Tungsten (IV) Oxide

WO_2

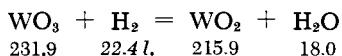

Stable at 900°C in a gaseous atmosphere composed of 40-55% H_2 and 45-60% H_2O .

I. Pure H_2 is subjected to an additional purification over silica gel and is then slowly passed through a water-filled flask to saturate it with water vapor. The flask is held in an $85^\circ C$ thermostat. To avoid condensation of the water vapor thus taken up, the tube which connects the flask to the reactor is wrapped with electric heating tape and heated to about $100^\circ C$. The H_2/H_2O mixture then flows over a boat with WO_3 set in a porcelain or a quartz reactor tube surrounded by a tubular electric furnace and heated to $800-900^\circ C$. The reduction is complete in 2 hours. The product is allowed to cool in an O_2 -free nitrogen stream. The nitrogen is admitted through a 3-way stopcock located between the water flask and the reactor.

II. A mixture of WO_3 and W (corresponding to the formula $WO_{2.00}$) is heated for 40 hours at $950^\circ C$ in a small evacuated and sealed quartz tube.

PROPERTIES:

Brown crystalline powder. M.p. $1500-1600^\circ C$ under N_2 , b.p. $1730^\circ C$; appreciably volatile above $1050^\circ C$; d_4^{25} 11.05. Hardness 5-5.5. Crystal structure: C 4 (rutile) type.

REFERENCES:

- I. O. Glemser and H. Sauer. *Z. anorg. allg. Chem.* 252, 151 (1943); J. A. M. van Liempt. *Ibid.* 126, 184 (1923); L. Wöhler and R. Günther. *Z. Elektrochem.* 29, 281 (1923).
- II. A. Magnéli, G. Andersson, B. Blomberg and L. Kihlberg. *Analyt. Chem.* 24, 1998 (1952).

γ -Tungsten Oxide



1/10	1364.1	92.0	1456.1
------	--------	------	--------

Very pure W powder and very pure WO_3 are intimately mixed in the prescribed ratio of $WO_{2.72}$ and heated for 6 hours at $800^\circ C$ in a small evacuated and sealed quartz tube. The product is ground and treated again for 24 hours at $800^\circ C$ in the same manner.

PROPERTIES:

Formula weight 4853.47. Red-violet crystalline powder; semiconductor. d_4^{20} 7.72. Deformed $D0_9$ type.

REFERENCES:

- O. Glemser and H. Sauer. Z. anorg. allg. Chem. 252, 144 (1943); A. Magnéli. Ark. Kem. 1, 223 (1949); A. Magnéli, G. Andersson, B. Blomberg and L. Kihlberg. Anal. Chem. 24, 1998 (1952).

Tungsten Blue

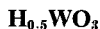

Produced by reaction of nascent hydrogen with WO_3 .

Fine WO_3 powder is slurried with distilled water in an Erlenmeyer flask, conc. HCl and analytically pure Zn granules are added, and the flask is closed with a valve which excludes air (Contat-Göckel attachment). When the Zn is consumed, the supernatant liquid is rapidly decanted and fresh conc. HCl and Zn granules are added. This is repeated until the reaction product is brown. Washing, drying and transfer of the product to a storage vessel must be carried out in the absence of oxygen.

PROPERTIES:

Formula weight 232.42. Brown to violet powder; d_4^{20} 7.35. Very readily oxidized. Evolves H_2 along with H_2O on thermal decomposition. Oxidized by water with H_2 evolution. Slow oxidation affords blue $\text{H}_{0.33}\text{WO}_3$ and $\text{H}_{0.1}\text{WO}_3$. D_{09} type with tetragonal distortion.

REFERENCE:

- O. Glemser and C. Naumann. Z. anorg. allg. Chem. 265, 288 (1951).

Tungsten (VI) Oxide

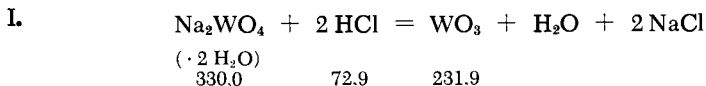

The yellow WO_3 is obtained by slow dropwise addition of a warm, saturated solution of Na_2WO_4 to 2-3 times its volume of boiling conc. HCl, followed by additional heating (for 1 hour) on a steam bath. The precipitate is allowed to settle, washed with

5% NH_4NO_3 solution until no further Cl^- reaction is obtained, and dried, first at 120°C and finally at 600°C .

PROPERTIES:

Lemon-yellow powder. M.p. about 1470°C , b.p. about 1700°C ; d_4^{25} 7.27. Crystals triclinic, pseudomonoclinic. Space group C_i .

REFERENCE:

W. Reinders and A. W. Vervloet. *Receuil Trav. Chim. Pay-Bas* 42, 627 (1923).

Yellow Tungstic Acid

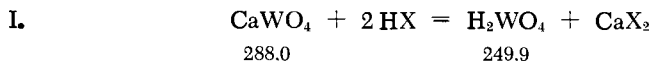

A boiling mixture of 50 ml. of H_2O , 40 ml. of conc. HCl , and 40 ml. of HNO_3 is treated with 20 g. of pure CaWO_4 . The resulting yellow precipitate is washed 8 times by decantation with slightly acidified water, and dissolved in 50 ml. of conc. ammonia. The clear filtrate is heated to boiling and treated with acid (60 ml. of H_2O , 50 ml. of HNO_3 and 10 ml. of HCl) to precipitate yellow tungstic acid, which is washed several times by decantation with pure H_2O , filtered through a leaf filter and slurried in pure H_2O . The suspension settles on standing for 14 days, during which an electric current is occasionally passed through it (Pt electrodes); the clear supernatant liquid is siphoned off; the residue is concentrated on a steam bath and then thoroughly dried in a desiccator over solid NaOH . The tungstic acid product is free of HCl and has the composition $\text{WO}_3 \cdot 1.13 \text{H}_2\text{O}$.

II. A boiling solution of 200 g. of ammonium tungstate [composition $2(\text{NH}_4)_2\text{O}$, 0.5WO_3 , $3 \text{H}_2\text{O}$] in 4.48 liters of H_2O is poured into 2 liters of boiling 35.4% HCl . The deep-yellow precipitate is filtered off and purified by a nine-day dialysis (until the wash water is free of Cl^- and the pH has reached a constant value of 4.4). Air drying of the residue gives a 55% yield of tungstic acid of composition $\text{WO}_3 \cdot 1.18 \text{H}_2\text{O}$; it still contains traces of NH_3 and Cl^- .

PROPERTIES:

Yellow powder, which appears amorphous under the microscope; it is claimed that its x-ray pattern is crystalline.

REFERENCES:

- I. G. F. Hüttig and B. Kurbe. *Z. anorg. allg. Chem.* 122, 45 (1922).
 II. A. M. Morley. *J. Chem. Soc (London)* 1930, 1990.

Tungsten Oxytetrachloride

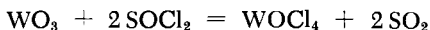

I. A mixture of WO_3 with 4 times its weight of SOCl_2 is heated in a sealed tube for 6-12 hours at 200°C . The reaction proceeds to completion only if the SO_2 is vented by opening the sealed tube for a brief time. The red WOCl_4 crystallizes from the excess SOCl_2 in long, well-formed needles, and is purified by removing the SOCl_2 in vacuum.

II. A sealed tube is used to heat the WO_3 with a solution of Cl_2 in CCl_4 (3 hours at 200°C). The tube is cooled and opened (caution: phosgene is present!); the WOCl_4 is washed in the tube with dry CCl_4 ; and the tube and its contents are heated to 160°C and immediately placed in a desiccator.

PROPERTIES:

Long, lustrous, red needles, yellow in transmitted light. M.p. 209°C , b.p. 232°C . Decomposed at once by water, more slowly by atmospheric moisture, forming tungstic acid.

REFERENCES:

- I. H. Hecht, G. Jander and H. Schlapmann. *Z. anorg. allg. Chem.* 254, 261 (1947).
 II. A. Michael and A. Murphy. *Amer. Chem. J.* 44, 382 (1910).

Tungsten (IV) Sulfide



A stoichiometric mixture of W and S is heated at 800°C under very pure N_2 in a sealed quartz tube for 24 hours.

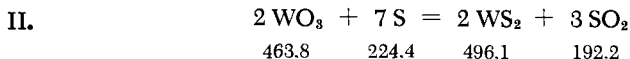

An intimate mixture of 33 g. of WO_3 , 40 g. of sulfur and 15 g. of K_2CO_3 is placed in a tubular crucible of unglazed porcelain (190 mm. long, 35 mm. I.D.) which is closed off with a perforated asbestos lid. The crucible is heated in a vertical tubular furnace at 600-700°C until the reaction is complete and the excess S has burned off. It is then heated for an additional 15 hours at 1400°C while H_2S is passed through. Large crystals of pure sublimed WS_2 are thus obtained.

Finely crystalline WS_2 is obtained from 92 g. of W powder and 35 g. of sulfur by following the above directions but heating only for 7 hours at 1450°C in a stream of H_2S .

PROPERTIES:

Blue-gray crystals with a metallic luster, insoluble in water; d_{20}^{10} 7.5. Crystal structure: C 7 type. Exhibits catalytic and radio-detector properties.

REFERENCES:

- I. O. Glemser, H. Sauer and P. König. Z. anorg. Chem. 257, 241 (1948).
- II. E. Tiede and H. Lemke. Ber. dtsch. chem. Ges. 71, 584 (1938).

Tungsten Hexaphenoxide

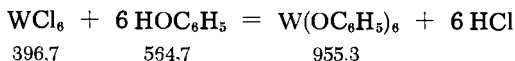

One wt. part of WCl_6 and about 10 parts of phenol are heated in a long, large test tube. Vigorous evolution of HCl begins as soon as the phenol melts. The tube is now heated over a small flame until the phenol boils. After some time the melt (which initially is brown-black even in thin layers) becomes deep red. Boiling is continued for a short time; the tube is then cooled while rotating it to distribute the melt on the walls of the vessel. The cooled melt is treated with some alcohol while crushing with a glass rod. The excess phenol dissolves in the alcohol and the product separates as a brick-red powder. It is filtered off with suction, washed with alcohol, and recrystallized from the latter.

SYNONYM:

Tungsten hexaphenolate.

PROPERTIES:

Dark-red needles or leaflets. M.p. 98°C. Readily soluble in CCl_4 , CS_2 , C_6H_6 , etc. Relatively poorly soluble in cold alcohol.

REFERENCE:

H. Funk and W. Baumann. Z. anorg. allg. Chem. 231, 265 (1937).

Potassium Enneachloroditungstate (III)



Prepared by electrolytic reduction of a KCl-containing solution of WO_3 in conc. hydrochloric acid.

A solution of 10 g. of $\text{WO}_3 \cdot \text{H}_2\text{O}$ in a conc. solution of 7.5 g. of K_2CO_3 is prepared. This solution (volume of about 15 ml.) is added in 2 or 3 portions to 260 ml. of conc. HCl (40°C); the hydrate, which precipitates after each addition, is allowed to redissolve before the next portion is introduced. After complete solution is finally obtained, the liquid is quickly cooled to 0°C. The crystalline precipitate thus obtained is composed for the most part of KCl. The solution, filtered through a fritted glass funnel, contains 3-4% WO_3 as $\text{H}[\text{WO}_2\text{Cl}_3]$, and is used in electrolysis.

The cathode vessel is a porous clay cell of about 6.5 cm. I.D. and 21 cm. high; this is set in a heavy-wall 12.5-cm.-I.D. and 20-cm.-high glass cylinder and centered with the aid of a rubber stopper. The rubber stopper contains five holes: two for the symmetrically placed carbon anodes, two for glass tubes used for passing CO_2 through the anodic electrolyte (so as to decrease the Cl_2 concentration in the latter), and a fifth hole through which the electrolyte is introduced. A drain is provided at the bottom of the anode vessel to permit rapid emptying at the end of the run. The clay cell is closed off hermetically with a rubber stopper, which carries a gas-tight stirrer (Hg seal), the cathode lead, and an opening for removal of samples during the electrolysis. The anodic liquor is conc. hydrochloric acid, while the clay cell is charged with 450 ml. of the W (VI) solution described above. The latter is reduced at 40°C and a current density of 0.4 amp./in.² until it turns yellow-green and the consumption of permanganate becomes constant.

The cathode is a 140-cm.² Pb sheet, which may be amalgamated if necessary. Runs with amalgamated electrodes require a longer

time (up to 2 hours) than do those with pure Pb cathodes (80-90 min.), but the product solution is free of Pb.

To obtain reproducible results with Pb cathodes, the latter must be formed by alternating anodic and cathodic polarization in 2 N H_2SO_4 ; this is unnecessary with the amalgamated electrodes (because of the purely chemical reducing action of the cathode metal, it is best to admit the cathodic liquid only after the voltage has been applied). The Pb, which initially goes into solution and later reprecipitates, causes no problem either during electrolysis or in the later workup of the solution.

After the completion of the reduction, the cathode is carefully removed from the solution, the anode vessel rapidly emptied, and the cathodic liquid containing the precipitated crystals poured into an Erlenmeyer flask, where it is then saturated with HCl while chilling in ice-salt mixture. After 1-2 days, the crystalline precipitate is collected on a fritted-glass funnel, washed with some conc. hydrochloric acid, then with alcohol and ether, and dried in a stream of air. The yield is about 60% based on the $\text{WO}_3 \cdot \text{H}_2\text{O}$ used.

For purification, $\text{K}_3\text{W}_2\text{Cl}_9$ is reprecipitated with a readily soluble potassium salt. For example, 25 g. of $\text{K}_3\text{W}_2\text{Cl}_9$ is dissolved in 175 ml. of boiled cold water; the solution is filtered into an Erlenmeyer flask which contains 150-175 g. of solid KSCN. The flask is then shaken. A copious quantity of deep green to yellow-green crystals separates even during the filtration; the solution meanwhile turns red. After one hour of standing in the cold, the crystals are suction-filtered, washed a few times with very concentrated KSCN solution, then with hot 80% alcohol, and dried in air. The product is fairly stable and can be stored for months in dry air over H_2SO_4 .

SYNONYM:

Potassium nonachloroditungstate (III).

PROPERTIES:

Formula weight 804.24. Small, dark-green tablets, yellow in transmitted light. Soluble in water, giving a dark-green color; very slightly soluble in alcohol. The aqueous solution oxidizes in air; the crystalline compound also oxidizes but more slowly.

REFERENCES:

- O. Collenberg and A. Guthe. *Z. anorg. allg. Chem.* 134, 317 (1924); O. Collenberg and K. Sandved. *Ibid.* 130, 9 (1923); O. Olson-Collenberg. *Ibid.* 88, 50 (1914); W. Biltz. *Ibid.* 170, 164 (1928); H. B. Jonassen, A. R. Tarsey, S. Cantor and G. F. Helfrich in: Th. Moeller, *Inorg. Syntheses*, Vol. V, New York-Toronto-London, 1957, p. 139.

Hexachlorotripyridineditungstate (III)

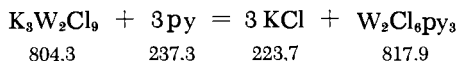

Ten grams of freshly recrystallized $\text{K}_3\text{W}_2\text{Cl}_9$ is refluxed in 150 ml. of dry pyridine for 6 hours (N_2 atmosphere). The red solution is filtered to remove the brown precipitate and treated with a large excess (10 volumes) of ether. This precipitates the dark-brown complex salt; it may be recrystallized from pyridine.

PROPERTIES:

Insoluble in water, somewhat soluble in ether and benzene. Diamagnetic. A corresponding aniline complex exists.

REFERENCE:

H. B. Jonassen, S. Cantor and A. R. Tarsey. J. Amer. Chem. Soc. 78, 271 (1956).

Potassium Octacyanotungstate (IV)

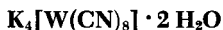

Prepared from $\text{K}_3\text{W}_2\text{Cl}_9$ and KCN.

A solution of 20 g. of $\text{K}_3\text{W}_2\text{Cl}_9$ in 150 ml. of cold, boiled water is prepared and treated on a water bath with 65 g. of KCN powder; this causes oxidation to W (IV), and the green color of the solution changes to red. The KCN should be added very carefully (shaking) over a period of 5 to 10 minutes.

The solution is now heated about two hours on the water bath, filtered (decolorizing charcoal being added if required) and evaporated until crystals begin to deposit. The first crystal fraction, consisting predominantly of KCl, is filtered off and discarded. The filtrate is diluted to 130 ml. and treated, while still warm, with 20-25 ml. of 95% alcohol. The $\text{K}_4[\text{W}(\text{CN})_8] \cdot 2\text{H}_2\text{O}$ separates in lustrous, bright-yellow plates on sharp cooling in a freezing mixture. After one hour, 15 additional ml. of alcohol is added. The mixture is suction-filtered after standing for 12 hours in the cold. The product is washed with hot 80% alcohol. Yield: 60-70%, based on tungsten.

For purification, the compound is first precipitated twice from 50% aqueous solution by adding an equal volume of alcohol. It is then dissolved in 16% KCN solution and, after concentrating, allowed to stand at 0°C until crystallization is complete. The product is again reprecipitated with water and alcohol to remove traces of KCN.

PROPERTIES:

Formula weight 584.5. d_4^{25} 1.989. Bright-yellow crystalline powder; slow evaporation of a KCN solution affords large, yellow-red crystals. Very readily soluble in water (about 13-14 g./10 ml. H₂O at 18°C). Insoluble in alcohol and ether.

REFERENCE:

- O. Olsson-Collenberg. Z. anorg. allg. Chem. 88, 50 (1914);
H. Baadsgaard and W. D. Treadwell. Helv. Chim. Acta 38,
1669 (1955).

Potassium Octacyanotungstate (V)



A solution of $\text{K}_4[\text{W}(\text{CN})_8] \cdot 2 \text{H}_2\text{O}$ (11.69 g. = 0.05 moles) in 125 ml. of water (acidified with 2 ml. of conc. HNO₃ and titrated with permanganate to a permanent red color) is prepared. The silver salt is then precipitated by addition of 0.21 g. (0.08 moles) of AgNO₃ dissolved in 50 ml. of water. The solid is washed with dil. HNO₃, dissolved in the minimum amount of ammonia, and reprecipitated with some dil. HNO₃. After thorough washing with water, the salt is suspended in 50 ml. of water and converted to the potassium salt by addition of 0.11 g. (0.07 moles) of KCl. The AgCl precipitate is removed by filtration, and the filtrate is treated with alcohol until the $\text{K}_3[\text{W}(\text{CN})_8] \cdot \text{H}_2\text{O}$ precipitates. It is filtered and dried over CaCl₂. The yield can be as high as 91%, based on the starting tungstate (IV).

PROPERTIES:

Formula weight 527.4. Small lemon-yellow crystals, readily soluble in water.

REFERENCES:

- O. Olsson-Collenberg. Z. anorg. allg. Chem. 88, 50 (1914);
H. Baadsgaard and W. D. Treadwell. Helv. Chim. Acta 38,
1669 (1955).

Uranium

U

The preparation of the pure metal is rendered difficult by its great tendency to combine with O, N, C, etc., and to alloy with many metals.

Basically, the following preparative methods are available:

- a) Reduction of uranium oxides or halides with suitable metals, such as Na, Mg, Ca (methods I to IV).
- b) Electrolysis (method V).

I. In the Jander method, UO_2 is reduced with metallic Ca:

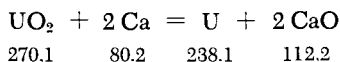

The reactor is an iron crucible about 13 cm. high, 1.6 cm. I.D., with a 0.1-cm. wall. This is charged with the reactant mixture, consisting of 7 g. of UO_2 and 11 g. of Ca turnings (the latter should be as freshly distilled as possible). The crucible cover is then welded on and the reactor heated for one hour at 1000-1100°C (the crucible should be embedded in charcoal powder to protect it from oxidation). The crucible is then completely cooled, opened, and the contents are covered with 90% alcohol saturated with NH_4Cl . Aqueous NH_4Cl solution is then added. The material is washed with water and then with alcohol. The product consists of four different fractions:

- a) a very finely divided oxide-containing uranium, which can be separated by slurring;
- b) iron metal particles with a small uranium content, which can be removed after drying by means of a magnet;
- c) nonmagnetic metal flakes (uranium with a high content of iron), which can be separated on a 140-170 U.S. standard sieve;
- d) a very fine gray-brown powder, containing about 97% U and 2-3% Fe, but only very small amounts of O. The yield of this fraction is 66%.

The presence of iron impurity in the product can be avoided by coating the inner surface of the iron crucible with calcium carbonate, but the shrinkage of this lining during drying and its fragility necessitate considerable care in handling. A reactor lined with calcium carbonate is capable of producing material containing 99.9% U, although the yield is appreciably lower than in the above-described procedure.

II. Very pure uranium is obtained by reduction of U_3O_8 with freshly distilled Ca in high vacuum. The mixture is heated above

the melting point of Ca, and the U is obtained as a fine gray powder which can be separated from the by-product CaO by sieving. Any unused Ca (which is present in excess) sublimes out from the product at the reaction temperature. The product analyzes as 99.95% U.

III. Both of the above procedures may be improved by adding to the reactant mixtures a mixture of scrupulously predried and prefused CaCl_2 and BaCl_2 . The salt mixture serves as a flux and at high temperatures dissolves both the CaO and Ca metal. It is further recommended that the product be reduced a second time under the same conditions; this is because the first reduction normally goes to equilibrium and no further.

IV. Many variations of the reaction of uranium chlorides with metallic Na in sealed iron vessels have been described. The products range in purity from 99 to 100% U. The preparative method described below is based on the earlier procedures and attempts to overcome some of their shortcomings; however, it affords a uranium whose x-ray diffraction pattern still clearly shows UO_2 lines. For this reason one must question the assertions of earlier authors who claimed that this procedure gives a completely pure product.

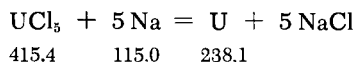
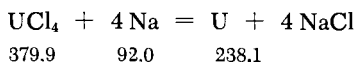

An alumina tube closed at one end (a so-called Tamman crucible), 12 cm. high and 2 cm. L.D., is charged successively with 5 g. of NaCl, 13 g. of uranium chloride (for preparation, see p. 1436 under UCl_4 , method I), and 4.5 g. of Na metal (freshly cut under ether). The materials must be added as rapidly as possible and then covered with NaCl up to 1 cm. below the top edge of the crucible. The filled tube is placed inside an only slightly larger iron crucible (3-mm. wall thickness) and the lid of the latter is welded on (see also Part III, Intermetallic Compounds, preparation of alloys by fusion of components). Two thick wires or bars are welded onto the outside of the iron crucible so that it may be suspended in a vertical tubular electric furnace. The reactor is gradually heated to 1150°C (2 hours), held for 15 minutes at this temperature, and then allowed to cool. The crucible is opened, and the contents of the alumina tube are treated with HCl-saturated methanol to remove unreacted Na, then with hot water to dissolve away the NaCl. Yellow $\text{Na}_2\text{U}_2\text{O}_7$ may appear

during this operation, even if the chloride reactant contained only a small percentage of UO_2Cl_2 . However, the $\text{Na}_2\text{U}_2\text{O}_7$ may be separated completely from the U metal residue by repeated slurring with water and decantation. The residue is then washed several times with HCl-saturated methanol and with water. Finally, light-gray metallic pellets are obtained.

V. ELECTROLYTIC PREPARATION

Very pure uranium is obtained by electrolysis of KUF_5 in an NaCl-CaCl_2 melt. A cylindrical graphite crucible serves both as the electrolysis vessel and the anode. It has an I.D. of 6 cm., a height of 15 cm. and walls 1-2 cm. thick. The electrical connection is made with a strip of Ni sheet wrapped around the upper part of the outside wall. The cathode is a strip of Mo sheet, 0.5 mm. thick and 1 cm. wide, which is immersed in the melt so that its lower end is 2.5 cm. above the bottom of the crucible. The latter stands in a suitable refractory vessel, around which a heating wire is wound. The entire apparatus is placed in a large-diameter lead vessel filled with thermal insulation.

A mixture of 250 g. of NaCl and 250 g. of anhydrous CaCl_2 is first fused together, and the melt temperature is adjusted as exactly as possible to 775°C . When the mixture is thoroughly melted, the cathode is inserted and the current is turned on (30 amp., potential drop between the electrodes about 5 v.). The current density should be 10 amp./in.².

Now, 30 g. of KUF_5 is added in small portions so that it melts as rapidly as possible. After addition of the KUF_5 is completed, a deposit of U begins to form on the cathode, where it appears in the form of a metallic tree; this reaches a thickness of about 2.5 cm. in 45 minutes. The old cathode is then slowly withdrawn from the melt, a new one is introduced, and the electrolysis is continued as before, while fresh salts are added to the melt as needed.

The material adhering to the cathode consists of a gray, spongy mass, which is permeated and surrounded by solidified melt. The melt protects the material from oxidation during cooling. After thorough cooling, the solids are stripped off the cathode and treated with water. Most of the salts dissolve quite easily, while the residue of heavy U powder can be readily and completely freed from traces of CaF_2 , etc., by slurring with water. The fraction consisting of very fine particles should be separated at the same time, since this material oxidizes very easily. The residue then comprises pure, fairly coarse particles of gray metal. The latter is washed with 5% acetic acid, followed by alcohol and ether; it is dried in vacuum and stored in air-tight vessels. This material is not pyrophoric. However, if the fine

metal powder is not removed the dry product may ignite in air under some circumstances.

PROPERTIES:

Light-gray pellets or black powder. M.p. 1689°; d 18.685. May be distilled using an electric furnace. Dissolves in dil. HCl and H₂SO₄ (slowly in cold acids but rapidly in warm ones), evolving H₂.

REFERENCES:

- H. Funk. *Darstellung der Metalle im Laboratorium* [Preparation of Metals in the Laboratory], Stuttgart, 1938.
- I. W. Jander. *Z. anorg. allg. Chem.* 138, 321 (1924).
- II. E. Botolfsen. *Bull. Soc. Chim. France* 45, 626 (1929).
- III. W. Kroll. *Z. Metallkunde* 28, 30 (1936).
- IV. J. Zimmermann. *Liebigs Ann.* 216, 16 (1883); A. Fischer. *Z. anorg. Chem.* 81, 170 (1913); A. Roderburg. *Ibid.* 81, 122 (1913); D. Lely and L. Hamburger. *Z. anorg. allg. Chem.* 87, 220 (1914); H. Haag and G. Brauer. Data from the Chem. Lab. of the Univ. of Freiburg i. Br., 1950.
- V. F. H. Driggs and W. C. Lilliendahl. *Ind. Eng. Chem.* 22, 516 (1930).

Uranium Hydride

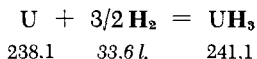

This procedure is successful only when very pure uranium metal is employed.

Uranium (10 g.) is freed of the adherent oxide layer by brief treatment with dil. nitric acid, washing with water, and drying over P₂O₅. The metal is then coarsely ground and placed in a porcelain boat, which should be large enough to accommodate the increase in volume which accompanies the hydride formation. Hydrogen is then passed over it at 250°C. [The pretreatment of the H₂ includes passage through a copper column heated to 650-700°C, a drying agent (magnesium perchlorate), and uranium powder heated to 700-750°C.] The reaction is complete after 20-30 minutes; the yield is quantitative.

See also Part II, Section 1, p. 113 f.

PROPERTIES:

Fine, black, pyrophoric powder. Loses H_2 when heated in vacuum above $250^\circ C$, forming a uranium of high chemical activity. Powerful reducing agent; reacts vigorously with water according to: $2 UH_3 + 4 H_2O = 2 UO_2 + 7 H_2$.

REFERENCES:

F. H. Spedding, A. S. Newton, J. C. Warf, O. Johnson, R. W. Nottorf, J. B. Johns and A. H. Daane. *Nucleonics* 4, 4 (1949).

Uranium (III) Chloride

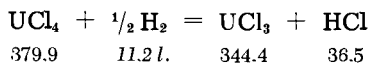

I. Completely pure UCl_4 is reduced with H_2 in the same tube in which it is prepared. The reduction proceeds below red heat and then at dull-red heat, until the off-gases are free of HCl. Absolutely pure H_2 must be used. The dull-brown, very hygroscopic UCl_3 adheres strongly to glass. Thus, when the mechanically separated product is dissolved, some brown to brick-red U (IV) silicate is always obtained as a residue.

II. Uranium is reacted with dry HCl at $250-300^\circ C$.

PROPERTIES:

Lustrous, dark-red, very hygroscopic needles; d_{25}^{25} 5.440. Very readily soluble in water, giving a purple-red liquid which becomes green within a few seconds as H_2 is evolved and a red precipitate forms. Insoluble in anhydrous alcohol, acetic acid, CCl_4 , $CHCl_3$, acetone and pyridine.

REFERENCES:

- I. A. Rosenheim and H. Leobel. *Z. anorg. Chem.* 57, 235 (1908);
 W. Biltz and C. Fendius. *Z. anorg. allg. Chem.* 172, 386 (1928);
 J. F. Suttle in: Th. Moeller, *Inorg. Syntheses*, Vol. V, New York-Toronto-London, 1957, p. 145.
- II. E. Staritzky. *Analyt. Chem.* 28, 1055 (1956).

Uranium (IV) Chloride



I. The preparation of completely pure UCl_4 (or UCl_5) is difficult since under normal conditions there exists an equilibrium: $2 \text{UCl}_4 + \text{Cl}_2 = 2 \text{UCl}_5$. However, for many purposes, especially for the subsequent reduction to metallic U, any mixture of the two uranium chlorides is adequate. Such a mixture is prepared rapidly and conveniently by the following method.

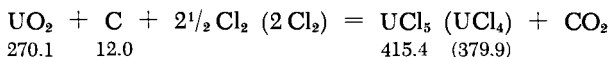

A quartz tube 40 cm. long and 2 cm. I.D., both ends of which carry ground joints, is charged with a mixture of 20 g. of UO_2 and 7 g. of carbon black, distributed along the entire length of the tube. One end of the reactor tube is connected to a wash bottle containing H_2SO_4 ; the latter, in turn, is connected to a U tube filled with P_2O_5 , which is attached to a Cl_2 cylinder. The other end of the reactor is connected to two ground-joint Erlenmeyer flasks in series (do not use round-bottom flasks; these are not as well suited for the precipitation operation), which in turn are attached to a wash bottle with H_2SO_4 (the latter is connected backward and serves as a trap for atmospheric moisture). All joints are lubricated with vitreous phosphoric acid. A very fast stream of Cl_2 is passed through this apparatus. When all the air is displaced, the reactor is heated with two rosette burners, beginning at the Cl_2 inlet. Within a short time the uranium chloride begins to sublime into the cooler part of the tube, largely as a brown vapor. By shifting the burners to the next zone of the tube as the reaction is completed in the preceding one, it is possible to sublime most of the uranium chloride into the two Erlenmeyer flasks. The yield is almost quantitative. It takes one hour to obtain about 13 g. of uranium chloride from 20 g. of UO_2 .

Chlorination of U_3O_8 under identical conditions, sometimes recommended in the literature, gives chlorides greatly contaminated with UO_2Cl_2 .

II. UCl_4 may be obtained by heating a mixture of 20 g. of UO_2 and about 6 g. of sugar-derived charcoal, covered with some additional sugar charcoal powder. The reactants are in an unglazed boat and a stream of Cl_2 is passed over the latter (the air is first displaced by evacuation and several purgings with Cl_2). The reaction begins at 450°C and is completed at $600\text{--}700^\circ\text{C}$. The UCl_4 is driven into a spherical receiver sealed onto the reactor tube to decompose the by-product UCl_5 . The material must be redistilled in a CO_2 stream into a second receiver sealed onto the first.

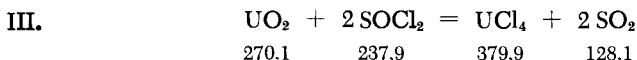

A bomb tube of ~ 1.5 cm. I.D. is charged with 5.6 g. of pure UO_2 and 10 ml. of SOCl_2 (freshly distilled in vacuum); these are then thoroughly mixed. The sealed tube is heated for 7 days at 200°C ; the time required for completion of the reaction may be somewhat reduced if the tube is briefly cooled at regular intervals and the SO_2 formed is permitted to escape.

The product consists of UCl_4 , partially dissolved in SOCl_2 and partially present as green crystals. The lower part of the bomb tube is cut off, the entire contents rinsed rapidly with some SOCl_2 into a 100-ml. ground-joint flask and distilled under reduced pressure (e.g., 140 mm.) in a stream of dry N_2 (or CO_2) to remove the SOCl_2 . Finally, the brown adduct of SOCl_2 and UCl_4 is decomposed by heating at about 150°C until a pure green residue of UCl_4 is obtained (half an hour is required). Yield: about 7.5 g. (95%).

IV. Analogous to Hönigschmid's method for UBr_4 (see p. 1440 f.). The product has the composition indicated by the formula. The procedure is somewhat tedious because of numerous precautionary measures necessary. Useful only for small quantities.

V. Chlorination of UCl_3 at 250°C .

PROPERTIES:

Formula weight 379.90. Light-green needles or dark-green octahedra, which sublime at red heat as a red vapor. M.p. 567° , b.p. 618° ; d^{25}_4 4.73-4.97. The aqueous solution gives a strongly acidic reaction because of hydrolysis. Soluble in ethyl acetate and benzoate; insoluble in ether, chloroform and benzene.

REFERENCES:

- I. H. Haag and G. Brauer. Experiments at chemical laboratories of the University of Freiburg i. Br., 1950.
- II. A. Voigt and W. Biltz. Z. anorg. allg. Chem. 133, 281 (1924).
- III. H. Hecht, G. Jander and H. Schlapmann. Ibid. 254, 255 (1947); checked at chemical laboratories of the University of Freiburg i. Br., 1951.
- IV. O. Hönigschmid and W. E. Schilz. Z. anorg. allg. Chem. 170, 148 (1928); O. Hönigschmid and F. Wittner. Ibid. 226, 296 (1936).
- V. E. Staritzky. Analyt. Chem. 28, 1056 (1956). See also J. A. Hermann and J. F. Suttle in: Th. Moeller, Inorg. Syntheses, Vol. V, New York-Toronto-London, 1957, p. 143.

Uranium (V) Chloride

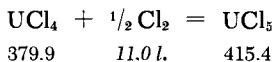

A very clean hard-glass tube *a-h*, bent as shown in Fig. 324, is charged at location *b* with a mixture of UCl_4 and finely divided wood charcoal, and attached immediately to a Cl_2 -generating apparatus via joint *a*. The reactants and the glass tube are carefully dried by heating in the Cl_2 stream, which is predried over P_2O_5 . When stronger heating is applied at *b*, a mixture of UCl_4 and UCl_5 distills toward *d*. To completely convert this chloride mixture into UCl_5 , a sufficient quantity of Cl_2 is first frozen in *f* by cooling the latter; the tube is then sealed off at *c* and (after evacuation via joint *h*) at *g*. The solid Cl_2 at *f* is brought to 0°C . This results in a vapor pressure of about 3.6 atm. Then heating the tip of tube *d* causes sublimation of pure UCl_5 from the heated zone; it forms a dark-brown deposit at *e*.

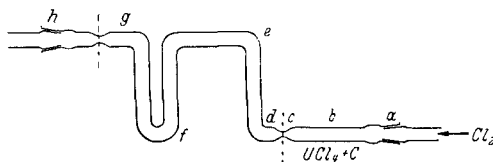

Fig. 324. Preparation of uranium (V) chloride.

Alternate method: Chlorination of U_3O_8 with CCl_4 in a sealed tube at 250°C (Michael and Murphy).

PROPERTIES:

Deep-brown, crystalline, very hygroscopic sublimate. Dissociates slowly, even at room temperature, to UCl_4 and Cl_2 (equilibrium partial pressure of Cl_2 at 20°C is at least 10^{-2} mm.); must therefore be stored in sealed vessels filled with Cl_2 . Soluble in water with fizzing and evolution of HCl ; soluble in absolute alcohol and acetone; the best solvents are ethyl acetate and benzonitrile.

REFERENCES:

- H. Martin and K. H. Eldau. *Z. anorg. allg. Chem.* **251**, 295 (1943);
 O. Ruff and A. Heinzelmann. *Ber. dtsh. chem. Ges.* **42**, 495 (1909);
 A. Michael and A. Murphy. *J. Amer. Chem. Soc.* **44**, 365 (1910).

Uranyl Chloride

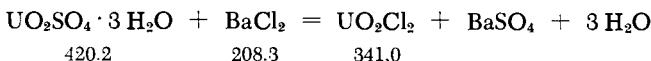

420.2 208.3 341.0

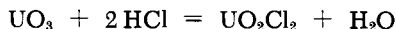

286.1 72.9 341.0

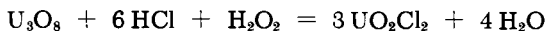

842.2 218.8 34.0 1023.0

An aqueous solution of uranyl chloride is prepared by (a) dropwise addition of a BaCl_2 solution to a conc. solution of $\text{UO}_2\text{SO}_4 \cdot 3\text{H}_2\text{O}$ [for preparation, see p. 1447 under uranium (IV) sulfate] until all of the SO_4^{2-} ion is precipitated (no excess of BaCl_2), followed by filtration; or (b) by thoroughly boiling UO_3 with water to give a yellow powder of H_2UO_4 , which is then dissolved in dil. HCl ; or (c) by slurring U_3O_8 in conc. HCl , followed by dropwise addition of 30% H_2O_2 ; the U_3O_8 is thus dissolved as UO_2Cl_2 , although the reaction is slow.

Careful evaporation of any of the UO_2Cl_2 solutions on a water bath and then in a vacuum desiccator over conc. H_2SO_4 affords a crystalline mass of composition $\text{UO}_2\text{Cl}_2 \cdot \text{H}_2\text{O}$. To obtain $\text{UO}_2\text{Cl}_2 \cdot 3\text{H}_2\text{O}$, a small portion of the residue is heated with some conc. HCl , the resulting solution is allowed to evaporate in a desiccator, and the small crystals which separate are added to a conc. solution of the main body of the monohydrate, whereupon they grow into large, uniform prismatic crystals.

The $\text{UO}_2\text{Cl}_2 \cdot \text{H}_2\text{O}$ and $\text{UO}_2\text{Cl}_2 \cdot 3\text{H}_2\text{O}$ can be dehydrated without decomposition by the following method. The uranyl chloride is first dried over P_2O_5 , placed in flat porcelain boats, and slowly heated in a dry HCl/Cl_2 stream to about 450°C over a period of 4-5 hours. Under these conditions no decomposition to the oxide takes place and only the water of crystallization is removed. If any $\text{UO}_2(\text{OH})\text{Cl}$ is present, it is converted to UO_2Cl_2 by reaction with the HCl , liberating water.

Alternate methods: a) repeated evaporation of uranyl nitrate or acetate with conc. HCl yields UO_2Cl_2 solutions, which are crystallized in a vacuum desiccator over KOH . The amount of water of crystallization present in the product depends on the duration of the drying period.

b) Oxidation of UCl_4 with O_2 (Leary and Suttle).

PROPERTIES:



Golden-yellow when completely anhydrous; hydrated UO_2Cl_2 exhibits a greenish luster.

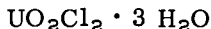

Formula weight 395.03. Yellow-green, fluorescent, oblique-angled prisms, deliquescent in air; extremely soluble in water, alcohol and ether. At 18°C, 7.35 wt. parts of $\text{UO}_2\text{Cl}_2 \cdot 3 \text{H}_2\text{O}$ dissolve in 1 part of H_2O ; the saturated solution is very viscous.

REFERENCES:

- F. Mylius and R. Dietz. Ber. dtsh. chem. Ges. 34, 2774 (1901); W. Oechsner de Coninck. Comptes Rendus Hebd. Séances Acad. Sci. 148, 1769 (1909); L. Ochs and F. Strassmann. Z. Naturforsch. 7 b, 637 (1952); H. A. Leary and J. F. Suttle in: Th. Moeller, Inorg. Syntheses, Vol. V, New York-Toronto-London, 1957, p. 148.

Uranium (IV) Bromide



Prepared by brominating a mixture of UO_2 and charcoal.

The apparatus used by Hönigschmid (Fig. 325) consists essentially of two parts: the glass section *A* and the quartz tube *B* with receiver *C*. Section *A* serves to hold the weighing tube and its stopper, and is attached to the quartz tube *B* by means of a large flange joint. Section *B* has a sacklike protuberance on one side, of the same I.D. as the quartz tube itself.

System *D*, comprising 3 quartz tubes connected by ground joints, is inserted into tube *B*. The side view of this system is shown separately in the figure, and is also reproduced in the main drawing. Tube *a-d*, constricted in the middle, carries a quartz boat containing the oxide-charcoal mixture. Tube *b*, which will be stored later in the weighing tube mentioned above, serves as a receiver for the pure, fused UBr_4 . Tube *c* leads the uncondensed bromide vapors into the receiver.

The quartz boat is charged with a mixture of 1 part of sugar-derived charcoal and 4 parts of uranium oxide, intimately ground together in an agate mortar. The boat is then inserted into tube *a*. The flanged joint and all stopcocks which will come in contact with bromine vapor are greased with sirupy metaphosphoric acid. The flanged connection is held together with strong metal springs. The apparatus is heated with small electric tube furnaces which can be shifted along the length of the quartz tube as far as the protuberance.

The apparatus is first filled with N_2 , and the quartz tube is heated along its entire length (beginning at the protuberance) in order to dry the material. Then a Br_2 -saturated stream of N_2 is

introduced and the furnaces are shifted in such a manner that the entire system of tubes can be heated as far as part *d*. The temperature is raised to yellow heat; the UBr_4 begins to form and condenses in *d*. Tubes *b* and *c* remain completely free of material and only a small amount of UBr_4 collects in receiver *C*. About 5 g. of UBr_4 forms in one hour. The furnaces are now shifted in such a way that the preweighed tube *b* remains cold, yet the sublimate in *d* is heated to yellow heat. The second sublimation (from *d* into *b*) is carried out either in bromine vapor or in pure N_2 .

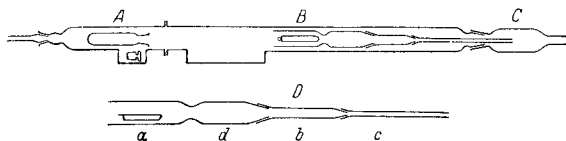

Fig. 325. Preparation of uranium (IV) bromide.

The melting of the UBr_4 should be accomplished without a loss, if possible, and without too long an exposure to high temperature. Thus, after completion of the sublimation, the entire system of tubes is pushed toward the protuberance by means of a quartz rod inserted through receiver *C*, while all furnaces are still at their maximum temperature. In this way the small tube *b* with the UBr_4 is shifted into the hottest part of the apparatus. The sublimate fuses in a few moments; the furnaces are now shut down and removed at once. Unnecessary overheating of the UBr_4 is thus avoided.

The apparatus is allowed to cool in a stream of N_2 , and are then filled with dry air. In disassembling the tube system, receiver *C* is removed first and the individual joints are loosened with a long glass rod provided with a small hook, while a steady, fast stream of air is passed through. Tube *a* is pushed up to the protuberance and is allowed to glide into the latter by gently turning the whole apparatus. Then tube *b* with the fused sublimate is pushed into the previously prepared weighing tube, which is then closed in the usual manner. The length of the run from the beginning of heating to the disassembly of the apparatus is 3 hours or less.

PROPERTIES:

Formula weight 557.73. d^{21}_4 4.838. Lustrous, brown to black leaflets, sublimable in a $\text{Br}_2\text{-N}_2$ stream; in N_2 alone, dissociates partially to UBr_3 and Br_2 . Dissolves in H_2O with fizzing and formation of a green liquid.

REFERENCES:

O. Hönigschmid. *Monatsh. Chem.* **36**, 59 (1915); O. Hönigschmid and F. Wittner. *Z. anorg. allg. Chem.* **226**, 296 (1936).

Uranium (IV) Oxide

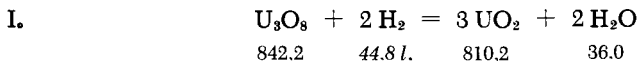

The starting U_3O_8 is prepared by heating pure uranyl nitrate, oxalate or peroxide (or ammonium diuranate) to 700-800°C; it is then reduced with H_2 at 900°C and allowed to cool in the stream of H_2 .

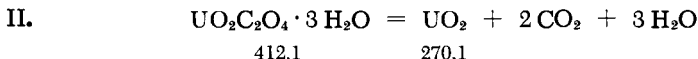

Precipitation of a hot conc. solution of uranyl nitrate with oxalic acid yields a yellow powder of $\text{UO}_2\text{C}_2\text{O}_4 \cdot 3 \text{H}_2\text{O}$; this is converted to black, very fine, pyrophoric UO_2 powder in a stream of H_2 even below red heat.

REFERENCES:

Formula weight 270.1. Brown powder. M.p. 2176° under N_2 ; d_{25}^{25} 10.8. Crystal structure: C 1 (fluorite) type.

REFERENCES:

- I. W. Biltz and H. Müller. Z. anorg. allg. Chem. 163, 261 (1927).
- II. W. Jander. Ibid. 138, 321 (1924).

Uranium (VI) Oxide



Pure UO_3 is difficult to prepare because the thermal cleavage of uranyl compounds does not free the product of traces of volatile components, while at high temperatures dissociation into U_3O_8 and O_2 becomes objectionable. To circumvent these drawbacks it is desirable to use O_2 at a pressure above atmospheric.

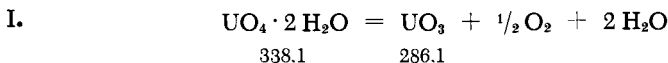

A weighing tube is charged with 5-10 g. of the dry peroxide and placed (unstoppered) in an electric crucible furnace preheated to 350°C. A fast stream of O_2 is admitted through the opening in the

furnace lid. The temperature is initially held for 3-5 hours at 350°C and then for one half to one hour at 400°C. The weighing tube is then stoppered and allowed to cool in a desiccator.

II. Uranyl nitrate is heated in O₂ to 500°C; however, the product still contains traces of water.

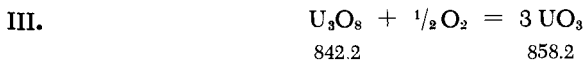

Figure 326 shows the apparatus in which rather large quantities of U₃O₈ can be converted to UO₃ at an oxygen pressure higher than atmospheric. The reactor *r* consists of an Inconel (a Cr-Ni alloy) tube which is screwed into a brass flange plate. This plate also carries a seal seat groove with a neoprene gasket. The upper, blind flange plate, also made of brass, carries the seal tongue and is drilled for a welded-on brass cross. The latter is connected to two high-pressure diaphragm valves and a pressure gage. A removable quartz insert *q* facilitates replacement of reactants. Manometer *m* is arranged in such a way that it also serves as a pressure-relief valve. The graduated tube *g* is for the liquid oxygen; it must contain sufficient oxygen to generate the desired pressure in the reactor.

Pure U₃O₈ (or UO₃ prepared as in method I) is placed in the quartz insert tube *g* and the reactor assembled to the flanges. The entire system is purged with O₂, beginning at stopcock *h*₁; the O₂ may be discharged at the pressure gage. Then stopcock *h*₁ is closed and the apparatus is evacuated by opening stopcocks *h*₂ and *h*₃; in this operation, valve *v*₄ is open and *v*₅ closed. The U₃O₈ is completely dried by heating reactor *r* for one hour at 850°C while maintaining the vacuum. A McLeod gage is used to ascertain when the apparatus is completely evacuated; the vacuum connection at stopcock *h*₂ is then closed, as are stopcock *h*₃ and valve *v*₄. Trap *f* is filled with liquid O₂ by immersing it in liquid N₂ and opening *h*₁. The amount of O₂ condensed in the trap should exceed by 10% that required to bring the pressure in the reactor to 27 atm. gage. This O₂ quantity can be estimated more exactly after the apparatus has been used once. When sufficient O₂ is condensed in the trap, stopcock *h*₁ is closed. Now the graduated tube *g* is immersed in a Dewar flask filled with liquid N₂ and stopcock *h*₃ is opened. The exact quantity of O₂ which is needed to attain the required gage pressure is measured into *g* and stopcock *h*₃ is then closed. The reactor is cooled in liquid N₂ and valve *v*₄ is opened. Tube *g* is then immersed in liquid O₂ in order to establish an inside pressure of about 1 atm.; this causes the O₂ to distill over into the reactor. Next, valve *v*₄ is closed and the reactor *r* is brought very gradually to room temperature in order to avoid scattering of the U₃O₈ by

the evaporating O_2 . The best procedure for doing this is to replace the liquid- N_2 -filled Dewar flask with an empty one. The reactor tube is placed in an electric furnace and heated for 40 hours at 600-700°C. If too much O_2 is condensed in the reactor, the excess can be discharged through valve v_5 . The liquid O_2 remaining in trap f can be removed by vacuum, or allowed to escape (slowly) through the manometer while the trap is in a Dewar flask containing gradually evaporating liquid N_2 .

According to x-ray diffraction data, this procedure yields pure UO_3 .

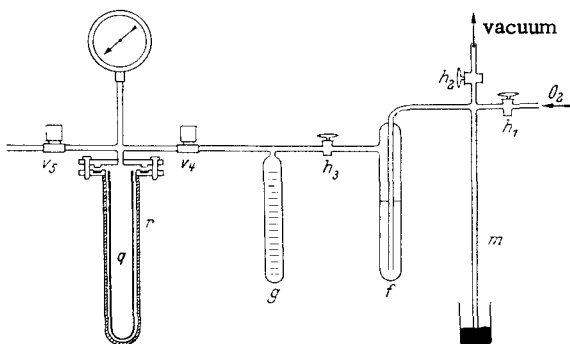

Fig. 326. Preparation of uranium (VI) oxide.
 r Inconel reactor; q quartz insert tube; g graduated condensation trap; f condensation trap; m manometer and pressure-relief valve; v valves.

PROPERTIES:

Bright orange-yellow, very hygroscopic, amorphous powder or hexagonal crystals; d_{25}^{25} 7.368. Soluble in mineral acids, forming uranyl salts. In water, it hydrates in 24 hours at room temperature to give $UO_3 \cdot H_2O$.

A red, hexagonal modification, which is less stable, forms at 450-500°C; its crystal structure resembles that of U_3O_8 .

REFERENCES:

- I. W. Biltz and H. Müller. *Z. anorg. allg. Chem.* **163**, 258 (1927).
- II. G. F. Hüttig and E. v. Schroeder. *Ibid.* **121**, 250 (1922); S. S. Lu, *Sci. Technol. China* **1**, 12 (1948), abstr. in *Chem. Zentr.* **1949**, II, 951.
- III. J. Sheft, S. Fried and N. Davidson. *J. Amer. Chem. Soc.* **72**, 2172 (1950).

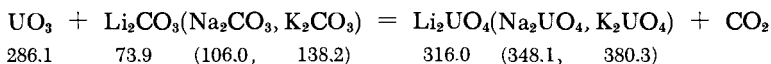
Alkali Uranates (VI)

Alkali carbonate and UO_3 (1:1 mole ratio) are intimately ground, placed in a large-diameter crucible, and gradually heated in an electric furnace to 800°C while O_2 is slowly passed through. The process is interrupted several times to regrind the reactants. The end of the reaction is recognized by the failure of a sample to evolve CO_2 on dissolution in dil. hydrochloric acid (2-3 days required to reach this point).

PROPERTIES:

Light orange when finely divided. Aqueous slurries show a distinctly alkaline reaction within a few minutes. Soluble in dilute hydrochloric acid and sulfuric acid, as well as in 2 N acetic acid (except for potassium uranate).

REFERENCE:

W. Rüdorff and H. Leutner. *Z. anorg. allg. Chem.* **292**, 193 (1957).

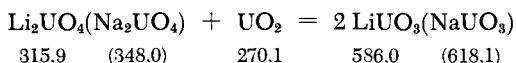
Alkali Uranates (V)

A mixture of alkali uranate (VI) and UO_2 (1:1 mole ratio) is heated in evacuated, sealed quartz ampoules at 650 - 750°C . The ampoules are opened at intervals of 10-20 hours, the reaction product is reground to a fine powder, and the heating is resumed using a new ampoule. The reaction is complete in 75-100 hours; the lithium compound forms in a somewhat shorter time and at a somewhat lower temperature.

PROPERTIES:

Formula weights: LiUO_3 293.0; NaUO_3 309.1. LiUO_3 is dark violet, NaUO_3 brown-violet. Both are very stable. Much more resistant to acids than the corresponding uranates (VI). Dilute hydrochloric and sulfuric acids have no effect in the cold. Dissolve in dil. nitric acid.

REFERENCE:

W. Rüdorff and H. Leutner. *Z. anorg. allg. Chem.* 292, 193 (1957).

Uranium Peroxide

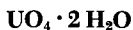

Precipitates from uranyl nitrate solutions on addition of H_2O_2 .

I. A boiling 10% solution of uranyl nitrate is treated dropwise with 30% H_2O_2 . The resulting amorphous, white precipitate is filtered on the finest filter possible (membrane or Millipore filter) and washed thoroughly with boiling water. The peroxide, which is a bright sulfur-yellow after filtration, is first dried in the air on a clay plate, then at 100°C to constant weight, and stored in vacuum over P_2O_5 .

II. Reaction of $(\text{NH}_4)_2[\text{UO}_2(\text{C}_2\text{O}_4)_2] \cdot 3\text{H}_2\text{O}$ with H_2O_2 yields crystalline, nonhygroscopic $\text{UO}_4 \cdot 3\text{H}_2\text{O}$, which is converted to the dihydrate by storing in vacuum over P_2O_5 .

III. A readily filterable peroxide hydrate is obtained from the reaction of 50 ml. of 30% H_2O_2 with 3 g. of UO_3 (half a day at room temperature).

PROPERTIES:

Formula weight of $\text{UO}_4 \cdot 2\text{H}_2\text{O}$: 338.10. Yellowish-white, amorphous powder or fine needles.

REFERENCES:

- I and II. A. Rosenheim and H. Daehr. *Z. anorg. allg. Chem.* 181, 178, 180 (1929).
 III. A. Sieverts and E. Müller. *Ibid.* 173, 299 (1928).

Uranium (IV) Sulfide

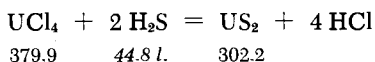

I. The best starting material for the preparation of US_2 is Na_2UCl_6 ; this material is preferable to UCl_4 because its volatility is lower.

The starting mixture is prepared during the synthesis of UCl_4 (see p. 1436, method II); thus, the sealed-on round receiving flask is precharged with 10 g. of ignited NaCl . Fusion of the UCl_4 with NaCl yields a green cake. The Cl_2 is removed by evacuation of the reactor tube. Then a stream of dry H_2S (either generated from the liquefied material or made by passing pure, dry H_2 over a boat containing molten S) is passed over the Na_2UCl_6 while heating the latter to 600-700°C; the reaction is continued for 4-5 hours until the off-gases are free of HCl . The US_2 is allowed to cool under H_2S and washed briefly with deaerated ice water, then with alcohol and ether, and dried in vacuum at 140°C.

II. Prepared from U_3O_8 and H_2S at 1150°C (electric furnace); depending on the reaction conditions, either α - or β - US_2 is formed.

PROPERTIES:

Black leaflets with a metallic luster, altered only by prolonged standing in air; d_4^{25} 7.96.

REFERENCES:

- I. E. F. Strotzer, O. Schneider and W. Biltz. *Z. anorg. allg. Chem.* 243, 307 (1940); A. Colani. *Ann. Chim. Phys.* (8) 12, 80 (1907); R. Flatt and W. Hess. *Helv. Chim. Acta* 21, 526 (1938).
- II. M. Picon and J. Flahaut. *Comptes Rendus Hebd. Séances Acad. Sci.* 237, 808 (1953).

Uranium (IV) Sulfate



Prepared by cathodic reduction of UO_2SO_4 :

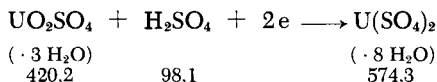

The electrolyte consists of an approximately saturated solution of $\text{UO}_2(\text{SO}_4) \cdot 3 \text{H}_2\text{O}$ (1 mole) in about twice the stoichiometric quantity (2 moles) of H_2SO_4 . The $\text{UO}_2\text{SO}_4 \cdot 3 \text{H}_2\text{O}$ is prepared from $\text{UO}_2(\text{NO}_3)_2 \cdot 6 \text{H}_2\text{O}$ by evaporating to dryness with H_2SO_4 and concentrating an aqueous solution of the residue to a sirupy consistency, whereupon the $\text{UO}_2\text{SO}_4 \cdot 3 \text{H}_2\text{O}$ slowly crystallizes. The

$\text{UO}_2\text{SO}_4\text{-H}_2\text{SO}_4$ solution is placed in a cooled glass cylinder which houses the cathode space. A clay cell contains the anode. The best results are obtained with an Hg cathode and a carbon rod anode. The Hg layer is placed on the bottom of the cathode vessel; the electrical connection is made with a copper wire sealed into a glass tube. The reaction proceeds quite rapidly at 3-5 amp. Any material which separates during the electrolysis is redissolved by addition of some water. At the end the cathode liquid becomes dark green with a steel-blue to black-violet fluorescence. If the electrolysis continues beyond the tetravalent state, the reddish brown color (in transmitted light) of trivalent uranium becomes apparent; however, this compound is very unstable and is quickly reoxidized in air to tetravalent uranium.

The concentrated acidic $\text{U}(\text{SO}_4)_2$ solution thus obtained is very stable and may be kept for weeks, in contrast to the very dilute solution.

Concentration of the solution in vacuum over H_2SO_4 yields $\text{U}(\text{SO}_4)_2 \cdot 8 \text{H}_2\text{O}$ as large, dark-green crystals; alternately, the product may be obtained by evaporation in air below 75°C . If the product is precipitated with alcohol in the cold, it is a light-green, fine crystalline powder.

The tetrahydrate $\text{U}(\text{SO}_4)_2 \cdot 4\text{H}_2\text{O}$ is prepared by dropwise addition of conc. H_2SO_4 to the reduced solution (high-speed stirring); the H_2SO_4 is added until no further precipitation occurs. During this operation the temperature rises to $40\text{-}50^\circ\text{C}$.

The salt is washed with alcohol and ether and dried on a clay plate.

PROPERTIES:

$\text{U}(\text{SO}_4)_2 \cdot 8 \text{H}_2\text{O}$: Formula weight 574.32. Dark-green monoclinic prismatic crystals. Hydrolyzes on solution in water, precipitating the basic sulfate $\text{UOSO}_4 \cdot 2 \text{H}_2\text{O}$. Solubility (20°C): 8.78 g./100 g. of solution in 0.1 N H_2SO_4 .

$\text{U}(\text{SO}_4)_2 \cdot 4 \text{H}_2\text{O}$: Formula weight 502.26. Whitish-green precipitate composed of needles arranged in a starlike form. Soluble in water with separation of the basic sulfate; soluble in dilute acids.

REFERENCE:

R. J. Meyer and H. Nachod. *Liebigs Ann.* **440**, 186 (1924).

Ammonium Uranyl Carbonate

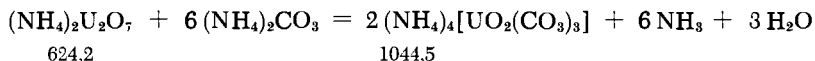
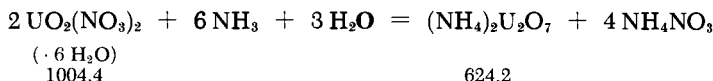

The $(\text{NH}_4)_2\text{U}_2\text{O}_7$ is precipitated from an aqueous solution of 10 g. of $\text{UO}_2(\text{NO}_3)_2 \cdot 6 \text{H}_2\text{O}$ by addition of conc. ammonia. The fine yellow powder is suction-filtered, washed with water, and stirred with an excess of conc. $(\text{NH}_4)_2\text{CO}_3$ solution for about 10 minutes (the flask is on a 70°C water bath). The clear supernatant liquid is decanted and allowed to stand overnight. Yellow crystals precipitate; these are filtered with suction and dried in air. The residue of undissolved $(\text{NH}_4)_2\text{U}_2\text{O}_7$ is treated several times with the mother liquor at 70°C, as described above, until crystals no longer form on cooling. Yield: 5-8 g.

PROPERTIES:

Formula weight 522.26. Well-formed, transparent yellow crystals, monoclinic prismatic; d 2.773. Sparingly soluble in water; insoluble in alcohol and ether; may be recrystallized without decomposition from aqueous $(\text{NH}_4)_2\text{CO}_3$.

REFERENCE:

Ebelmen. Liebigs Ann. 43, 302 (1842).

Uranium (IV) Oxalate

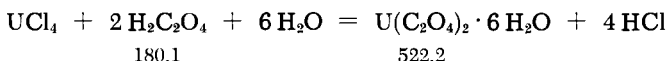
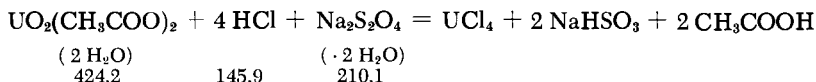
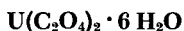

Five grams (0.012 moles) of $\text{UO}_2(\text{CH}_3\text{COO})_2 \cdot 2 \text{H}_2\text{O}$ powder is dissolved in 100 ml. of dilute HCl (1 : 10 in water) preheated to 80°C. While stirring, 5 g. (0.024 moles) of $\text{Na}_2\text{S}_2\text{O}_4 \cdot 2 \text{H}_2\text{O}$ powder is

added in small portions. The initial precipitate is brown, but rapidly changes to whitish-green. Then 5 ml. of conc. HCl is added and the mixture is heated for about 10 minutes on the water bath (until solution is complete). The dark-green solution of uranium (IV) salt is usually somewhat cloudy because of a haze of fine sulfur. It is filtered in the absence of air and treated while still warm (appr. 60°C) with a saturated oxalic acid solution; the latter is added slowly (good stirring). A heavy, solid gray precipitate forms at once. It settles in a few minutes and, after standing for one half hour, exhibits the dark-green color of uranium (IV) oxalate. It is washed 5 times with 100-ml. portions of water. Sulfite and oxalate should be removed completely by this operation. Since uranium (IV) oxalate is completely stable in air, it may be air dried. The yield is almost quantitative (5.7 g.).

PROPERTIES:

Dark-green microcrystals, stable in air [in contrast to solutions of uranium (IV) salts]. May be recrystallized from warm conc. hydrochloric acid. Only slightly soluble in water and dil. acids. Loses 5 moles of H₂O at 110°C, but the sixth mole only at about 200°C.

REFERENCES:

- V. Kohlschütter and H. Rossi. Ber. dtsh. chem. Ges. 34, 1473, 3630 (1901); E. Marchi in: L. F. Audrieth, Inorg. Syntheses, Vol. III, New York-Toronto-London, 1950, p. 166.

Potassium Tetraoxalatouranate (IV)

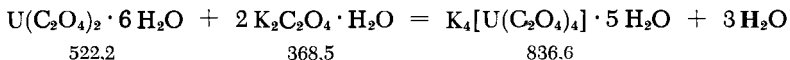
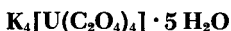

A slurry of 6 g. (0.014 moles) of U(C₂O₄) · 6 H₂O in 50 ml. of water is treated in the absence of air with a solution of 5 g. (0.027 moles) of K₂C₂O₄ · H₂O in 20 ml. of water and allowed to stand on a steam bath for one hour. It is then filtered and the dark-green filtrate is treated dropwise with 200 ml. of absolute alcohol (good stirring). Small light-green crystals precipitate. These are filtered off, washed with absolute alcohol, then with ether, and dried over P₂O₅.

PROPERTIES:

Readily soluble in water (21.7 g. per 100 g. of water at 17°C), but only very slightly soluble in water-alcohol mixtures. Converted to the monohydrate by heating for a few hours at 200°C.

REFERENCES:

- V. Kohlschütter. Ber. dtsh. chem. Ges. 34, 1472, 2619 (1901);
 E. Marchi in: L. F. Audrieth, Inorg. Syntheses, Vol. III,
 New York-Toronto-London, 1950, p. 169.

Uranium (V) Ethoxide

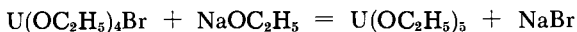
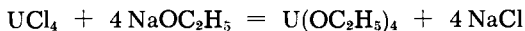

A sodium ethoxide solution is prepared from 800 ml. of absolute ethanol and 46 g. (2 g.-atoms) of Na (use a 1-liter, three-neck flask). Toward the end of the reaction, refluxing and good stirring are needed. The solution is cooled to room temperature. Then, while stirring rapidly, 190 g. (0.5 moles) of fine UCl_4 powder is added in portions of about 20 g. (5-minute intervals). The contents of the flask are protected at all times against atmospheric moisture by means of a CaCl_2 tube. The heat of reaction causes the alcohol to boil, and the flask is therefore set in cold water. When all the UCl_4 has been added and the reaction subsides, the flask contents are refluxed on a steam bath for two hours (stirring). They are then cooled to room temperature and a solution of 40 g. (0.5 g.-atoms) of bromine in 20 ml. of dry benzene is added dropwise (rapid stirring) over a period of 15 minutes. The color changes from light green to brown, then gray and, toward the end of the addition, dark green.

While continuing the stirring, a sodium ethoxide solution prepared from 11.5 g. (0.5 g.-atoms) of Na in 200 ml. of absolute alcohol is rapidly added, causing the color to turn brown. The mixture is then distilled under anhydrous conditions to remove the alcohol. To achieve this, about one third of the material is introduced as rapidly as possible into a 500-ml. Claisen flask and the alcohol is distilled off on an oil bath (good stirring). Then the second fraction is added, etc. When the mass becomes solid, the stirrer is removed; the flask is closed off with a stopper and gradually heated to 150°C at 2-3 mm. The completely dry residue, which contains NaCl and $\text{U}(\text{OC}_2\text{H}_5)_5$, is now heated further on an oil bath at a vacuum of 0.001-0.004 mm. The uranium (V) ethoxide distills at a bath temperature of about 180 - 240°C . The yield may be as high as 217 g. (94%).

SYNONYM:

Uranium (V) ethylate.

PROPERTIES:

Dark-brown liquid. B.p. about 123°C at 0.001 mm.; d^{25} 1.711. Considerably higher thermal stability than UCl_5 . Miscible with ethanol, ether, benzene, chloroform, pyridine, etc. Immediately decomposed in water.

REFERENCE:

R. G. Jones, E. Bindschadler, G. Karmas, F. A. Yoeman and H. Gilman. *J. Amer. Chem. Soc.* **78**, 4287 (1956).

Uranium (VI) Ethoxide

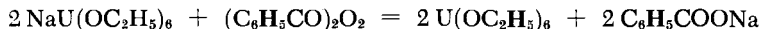

A 500-ml. three-neck flask is fitted with a gas-tight stirrer and a gas outlet tube. This flask is used to prepare a sodium ethoxide solution from 300 ml. of absolute alcohol and 1.69 g. (0.074 g.-atoms) of Na. When all of the Na is dissolved, the solution is cooled under N_2 and 20 ml. (34 g., 0.074 moles) of uranium (V) ethoxide (see above for preparation) is added with a pipette. The brown color of the ethoxide disappears, and a clear, light-green solution of $\text{NaU}(\text{OC}_2\text{H}_5)_6$ is formed. Now, 8.90 g. (0.037 moles) of dry benzoyl peroxide powder is added in three equal portions at about 10-minute intervals while vigorously stirring. The mixture becomes warm, acquiring a red color and forming a gelatinous precipitate of sodium benzoate. After one hour of additional stirring under N_2 , half of the material is transferred (still under N_2) to a 250-ml. Claisen flask fitted with a distilling condenser, and the alcohol is distilled out at atmospheric pressure on a steam bath. The second half is then added and the procedure repeated.

The receiver flask is now heated on an oil bath and the contents are subjected to a vacuum distillation. At first, with the bath temperature as high as 140°C and at 5-10 mm., the last of the alcohol is removed; the uranium (VI) ethoxide distills out at the same bath temperature but at a high vacuum (0.003 mm.). Yield: 20 g. Rectification in high vacuum affords the pure product. Yield: 16 g. (43%). The boiling point is 72-74°C at 0.001 mm.

SYNONYM:

Uranium (VI) ethylate.

PROPERTIES:

Red, mobile liquid; d 1.563. Monomeric in benzene. Readily soluble in benzene, ether, petroleum ether, etc. Extremely sensitive to moisture; forms uranyl hydroxide when hydrolyzed. Strong oxidizing agent. Readily reduced to uranium (V) ethoxide. Synproportionates with U (IV) ethoxide according:

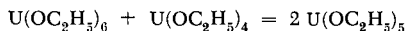

REFERENCE:

R. G. Jones, E. Bindschadler, D. Blume, G. Karmas, G. A. Martin, J. R. Thirtle, F. A. Yoeman and H. Gilman. *J. Amer. Chem. Soc.* **78**, 6030 (1956).

Uranyldibenzoylmethane

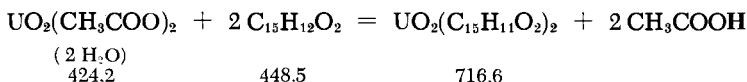

Methanolic solutions of uranyl acetate and dibenzoylmethane are combined in the cold. An intense reddish-yellow color appears at once, and after a few seconds uranyldibenzoylmethane powder begins to separate; it can be recrystallized from a large amount of hot alcohol. Other solvents may also be used for purification; however, one must bear in mind that uranyldibenzoylmethane forms well-crystallized addition compounds with almost all solvents.

Used analytically for the rapid separation of rare earths produced in the fission of uranium, since these do not form complexes with dibenzoylmethane in the presence of water. The uranium can be rapidly and conveniently separated by extraction (as the UO_2 complex).

PROPERTIES:

Orange-red crystals, which change color at about 180°C and begin to decompose at 245°C. Readily soluble in all ketones and esters and in pyridine; moderately soluble in ethyl alcohol; sparingly soluble in ether; insoluble in hydrocarbons such as benzene, toluene and naphtha. Stable to water, but is decomposed by acids and alkalies (even by ammonia).

REFERENCES:

H. Götte. *Z. Naturforsch.* **1**, 378 (1946). Preparation of dibenzoylmethane: A. Magnani and S. M. McElvain. *Org. Syntheses*, collective Vol. 3, p. 251, New York-London, 1955.

Manganese

H. LUX

Manganese**Mn**

I. BY ELECTROLYSIS

Very pure Mn may be produced by electrolysis under the following conditions:

The electrolysis is performed with anode and cathode spaces separated from each other, using canvas or a ceramic substance as the cell diaphragm. The cathode electrolyte contains 70 g. of $\text{MnSO}_4 \cdot 4\text{H}_2\text{O}$ and 200 g. of $(\text{NH}_4)_2\text{SO}_4$ per liter, the anode electrolyte 100 g. of $(\text{NH}_4)_2\text{SO}_4$ per liter. The cathode is a polished stainless steel sheet; the anode is a lead sheet. The cathodic current density is 0.16 amp./in.² and the temperature of the electrolyte should not exceed 40°C. The pH value in the cathode cell should be maintained between 4.5 and 8.5, and the free sulfuric acid content of the anode cell should not exceed 5%. To prevent oxidation of the catholyte and to promote uniform deposition of Mn, a small quantity of a saturated SO_2 solution is added from time to time to the catholyte so that a concentration of about 0.1-1 g. of SO_2 /liter is maintained in it.

The current efficiency is about 50-70%. In addition to impurities, the content of which is a function of the purity of the starting electrolyte, the metal contains up to 0.02% S and some H_2 ; however, the latter can be readily removed by heating in vacuum. The γ -Mn product is silver-gray, polishes readily and is stable in air. The boundary layer in contact with the cathode shows gradual transition to fine-grained β -Mn and is therefore hard. If performed under different conditions, the electrolysis will produce shiny layers of metal which rapidly turn dark upon exposure to air; in this case the metal should be immersed in a 5% $\text{Na}_2\text{Cr}_2\text{O}_7$ solution immediately upon removal from the electrolyte; this treatment passivates it and permits it to retain its lustrous surface.

II. BY DISTILLATION

Very pure Mn can be obtained by the distillation of Mn prepared via the aluminothermic or the electrolytic methods. The metal, in a sintered Al_2O_3 boat, is placed in a ceramic tube closed at one end. The tube must be pretested for gas tightness, and a vacuum of at least 0.005 mm. Hg. should be established in it. The tube is heated in a Globar furnace to a temperature of 1250 to 1350°C, at which temperature the Mn vapor pressure is 1-2 mm. The distilled metal deposits as small needles on a tubular nickel sleeve cooled by running cold water and located in the vicinity of the boat; the metal can be loosened by slight tapping. The product is extremely reactive and ignites upon exposure to air; all subsequent handling must therefore take place in an Ar atmosphere in the absence of O_2 .

Manganese prepared under the same conditions but deposited on an uncooled surface, e.g., an alumina rod, is less reactive. The dense, silvery scales of the crystalline metal are easily stripped off and reduced to powder. This product is the α -modification, which is stable at temperatures below 742°C.

PROPERTIES:

Atomic weight 54.93. M.p. 1212°C, b.p. 2152°C. Electrolytically precipitated Mn: d 7.2, crystal structure γ -Mn, A 6 type. Distilled Mn: d 7.44, crystal structure α -Mn, A12 type.

REFERENCES:

- I. R. Springer. Die elektrolytische Abscheidung des Mangans [The Electrolytic Deposition of Manganese], Akad. Verlagsges., Leipzig, 1951; S. M. Shelton and M. B. Royer. Trans. Electrochem. Soc. 74, 447 (1938), Chem. Zentr. 1939, I, 2284; I. A. Mendeleev, S. I. Orlova and Y. S. Shpichinetskiy. Tsvet. Metal. 16, 53 (1941), Chem. Zentr. 1942, II, 2196; E. Herrmann. Ann. Physik [5] 21, 139 (1934).
- II. R. Schenk and A. Kortengraber. Z. anorg. allg. Chem. 210, 273 (1933); H. Haraldsen and W. Klemm. Ibid. 220, 184 (1934); M. L. V. Gayler. Metallwirtschaft 9, 678 (1930); M. Picon and J. Flahaut. Comptes Rendus. Hebd. Séances Acad. Sci. 237, 569 (1953).

Manganese (II) Oxide

MnO

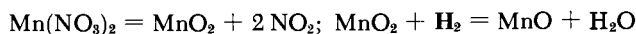

(· 6 H₂O)
287.0

70.9

The oxide varies from grassy green to light green and may be obtained from any of the oxides (or other suitable salts of

manganese) by reduction with H_2 at temperatures below $1200^\circ C$. Thus, for example, $Mn(NO_3)_2 \cdot 6H_2O$ is heated in air to about $300^\circ C$; the product (approx. $MnO_{1.95}$) is ground to powder and reduced for 4 hours at $800^\circ C$ with pure, oxygen-free hydrogen; the reaction rate becomes appreciable about $450^\circ C$. With prolonged heating or high temperatures the product turns an increasingly grayish color and finally becomes light gray; in the presence of oxygen, it is brown. A reduction temperature of $800^\circ C$ is sufficient for hydrated oxides; $MnCO_3$ must be heated to 1000 - $1100^\circ C$ for 15-20 minutes.

PROPERTIES:

M.p. $1785^\circ C$; d5.18. Crystal structure: B1 (rock salt) type.

REFERENCES:

- P. Dubois. Ann. Chimie [11] 5, 432; for preparation by heating $MnCO_3$ or MnC_2O_4 in a high vacuum, see M. LeBlanc and G. Wehner. Z. phys. Chem. A 168, 61 (1934); T. E. Moore, M. Ellis and P. W. Selwood. J. Amer. Chem. Soc. 72, 856 (1950); for preparation by heating $MnCO_3$ in flowing N_2 , see H. Ulich and H. Siemonsen. Arch. Eisenhüttenwesen 14, 27 (1940); Z. Elektrochem. 45, 637 (1939).

Manganese (II) Hydroxide

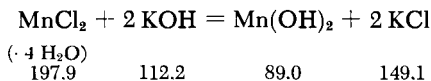

In the method of Simon, a solution of 300 g. of analytically pure KOH in 500 ml. of water in a round-bottom flask (see Fig. 327) is heated for about one half hour while a stream of completely O_2 -free hydrogen is passed through; a completely O_2 -free solution of 15-17 g. of $MnCl_2 \cdot 4H_2O$ in 15 ml. of boiled water is then added from a dropping funnel. The mixture is then heated to 190 - $200^\circ C$ (as rapidly as possible) on an oil bath while H_2 is bubbled through. When the amorphous precipitate of $Mn(OH)_2$ is completely dissolved, the flask is allowed to cool slowly on the oil bath, whereby the compound precipitates out as white flakes of pearly sheen.

After cooling to room temperature, boiled water prepurged with H_2 is added from a dropping funnel until the flask is almost filled; the liquor is then siphoned off by means of a glass tube which

reaches almost to the bottom of the flask (the flow of H_2 should not be interrupted either during this or the preceding operation). The glass tube is connected to a Pyrex glass filter (constantly flushed with a H_2 stream), which in turn is attached to a suction flask; the latter is connected to the suction pump by way of a wash bottle containing a solution of $CrCl_2$. The addition of small amounts of water (washing operation) to the flask is repeated several times. The crystals are transferred (by shaking the flask) to the glass filter, washed on the filter, first with a large quantity of O_2 -free water (a second dropping funnel is used), then with absolute alcohol through which H_2 is bubbled, and finally with peroxide-free ether. The product, still on the glass filter, is then dried in a desiccator over P_2O_5 while maintaining a high vacuum.

This procedure gives a moderate yield of a well-crystallized product. Larger amounts of the microcrystalline substance are prepared more conveniently by the method of Scholder and Kolb [boiling with concentrated sodium hydroxide to which $(NH_3OH)Cl$ is added].

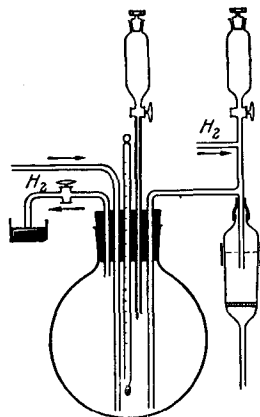

Fig. 327. Preparation of manganese(II) hydroxide.

PROPERTIES:

When free of alkaline hydroxides and amorphous components, the dry product can be kept in an air-filled desiccator for weeks. The crystalline compound occurs in nature as pyrochroite.

Solubility (18°C) 0.0019 g./liter. d 3.258. Crystal structure; type C 6.

REFERENCES:

- A. Simon. *Z. anorg. allg. Chem.* **232**, 369 (1937); T. E. Moore, M. Ellis and P. W. Selwood. *J. Amer. Chem. Soc.* **72**, 858 (1950); R. Scholder and A. Kolb. *Z. anorg. allg. Chem.* **264**, 211 (1951).

Manganese (III) Oxide

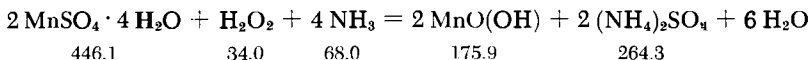
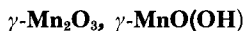

446.1

34.0

68.0

175.9

264.3

The method of Marti gives $\gamma\text{-MnO(OH)}$ with a well-defined x-ray pattern. A solution of 2.2 g. of $\text{MnSO}_4 \cdot 4 \text{H}_2\text{O}$ (10 mmoles)

in 350 ml. of water is treated in a large beaker (very vigorous mechanical agitation) with 34 ml. of a 3% H_2O_2 solution (30 mmoles). With continued very vigorous agitation, 50 ml. of a 0.2 M NH_3 solution (10 mmoles) is added at once from a graduated cylinder. The dark-brown or black suspension, which is evolving oxygen, is brought to a boil as rapidly as possible. The boiling is continued for about 4 minutes and the solution is filtered, washed with 1.5 liters of hot water, and dried over P_2O_5 in vacuum at temperatures below about 100°C .

Careful dehydration of $\gamma\text{-MnO(OH)}$ (vacuum, 250°C) yields $\gamma\text{-Mn}_2\text{O}_3$. $\gamma\text{-MnO(OH)}$ occurs in nature as manganite.

REFERENCES:

- W. Marti. *Über die Oxidation von Manganhydroxyd und über höherwertige Oxyde und Oxydhydrate des Mangans* [The Oxidation of Manganese Hydroxide and the Higher Oxides and Hydrated Oxides of Manganese], Thesis, Univ. of Bern, 1944, p. 83; W. Feitknecht and W. Marti. *Helv. Chim. Acta* 28, 142 (1945); T. E. Moore, M. Ellis and P. W. Selwood. *J. Amer. Chem. Soc.* 72, 861 (1950); P. Dubois. *Ann. Chimie* [11] 5, 434 (1936); A. Simon and S. Fehér. *Z. Electrochem.* 38, 137 (1932); F. Krull. *Z. anorg. allg. Chem.* 208, 134 (1932); K. L. Orr. *J. Amer. Chem. Soc.* 76, 857 (1954).

Manganese (IV) Oxide

MnO_2

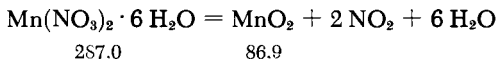

The starting $\text{Mn(NO}_3)_2 \cdot 6\text{H}_2\text{O}$ is decomposed in air by heating to about 190°C ; the product is ground to powder, boiled with nitric acid (conc. HNO_3 diluted 1:6) and heated in air to $450\text{-}500^\circ\text{C}$. The x-ray pattern of the product clearly shows the lines of pyrolusite ($\beta\text{-MnO}_2$). At atmospheric pressure, oxygen begins to split off above 530°C in air, and above 565°C in oxygen.

Alternate methods: a) From MnCl_2 and $(\text{NH}_4)_2\text{S}_2\text{O}_8$ in aqueous solution [A. Simon and F. Fehér, *Z. Elektrochem.* 38, 137 (1942)].

b) From NH_4MnO_4 and NH_3 in aqueous solution (A. Harzer, German Patent 713,904, Class 12, Group 3, as well as the references cited below).

c) From Mn_2O_7 [P. Dubois, *Ann. Chimie* [11] 5, 411 (1936); A. Simon and F. Fehér, *Kolloid-Z.* 54, 50 (1931); A. Simon and F. Fehér, *Z. Elektrochem.* 38, 137 (1932)].

SYNONYM:

Manganese dioxide.

REFERENCES:

- C. Drücker and R. Hüttner. *Z. phys. Chem.* 131, 263 (1928); O. Glemser. *Ber. dtsh. chem. Ges.* 72, 1879 (1939); F. Krüll. *Z. anorg. allg. Chem.* 208, 134 (1932); W. Marti. Thesis, Univ. of Bern, 1944; T. E. Moore, M. Ellis and P. W. Selwood. *J. Amer. Chem. Soc.* 72, 863 (1950); G. Butler and H. R. Thirsk. *J. Electrochem. Soc.* 100, 297 (1953); G. Gattow and O. Glemser. *Z. anorg. allg. Chem.* 309, 121 (1961).

Manganese (VII) Oxide

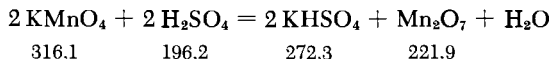

Concentrated H_2SO_4 (15 ml., d 1.84) is placed in a dry porcelain mortar precleaned with chromosulfuric acid; then 23 g. of KMnO_4 is carefully added over a period of 10-15 minutes, while constantly stirring with a pestle. To obtain the desired result, the following precautions must be observed: only very pure KMnO_4 crystals, free of dust and organic substances (preferably Merck A.R. quality; do not reduce the crystals to powder), can be used. The reaction slurry should be left standing overnight in a dry spot, protected against dust. Porous pyrolusite is formed during this time, and the Mn_2O_7 oil is very gently kneaded out from it. Proper safety measures must be observed during the preparation and further workup of the material, since it often explodes for no apparent reason (an asbestos face shield with safety glasses and heavy leather gloves should be worn and one should work behind heavy glass plate and a fine wire screen).

Yield: 10 g. (62%). The product is entirely free of K^+ and SO_4^{2-} .

SYNONYMS:

Manganese heptoxide, permanganic acid anhydride.

PROPERTIES:

An oil with green metallic luster in reflected light; dark red in transmitted light; specific odor. M.p. 5.9°C ; d_4^{20} 2.396; heat

of formation: -177.4 kcal (20°C); dissociation at approx. 55°C , detonation at 95°C . In vacuum, rapid and explosive dissociation above 10°C . Forms α - Mn_2O_3 during explosive decomposition, γ - MnO_2 during slow dissociation. Soluble in conc. H_2SO_4 and H_3PO_4 with an olive green color. Hygroscopic; dissociates slowly in humid air to MnO_2 , liberating O_3 -containing O_2 and, occasionally, a red mist of HMnO_4 . Stable under refrigeration (-10°C) provided anhydrous conditions are maintained. Reacts explosively with most organic compounds; attacks acetic acid, acetic anhydride and CCl_4 even below room temperature. *Dangerous compound!* The impact sensitivity of Mn_2O_7 is equal to that of mercuric fulminate.

REFERENCES:

J. M. Lovén. Ber. dtsh. chem. Ges. 25, Ref. 620 (1892); A. Simon and F. Fehér. Z. Elektrochem. 38, 138 (1932); O. Glemser and H. Schröder. Z. anorg. allg. Chem. 271, 294 (1953).

Sodium Manganate (V)

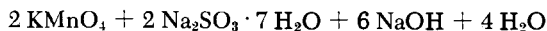

316.1

504.3

240.0

72.1

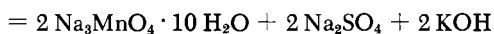

736.2

284.1

112.2

A solution of 2 g. of very fine KMnO_4 powder in 50 ml. of 28% sodium hydroxide is triturated in a small Erlenmeyer flask with 3.5 g. of finely divided $\text{Na}_2\text{SO}_3 \cdot 7 \text{H}_2\text{O}$; the flask stands in an ice bath. The trituration requires about 10 minutes, that is, until a light-blue crystalline slurry is obtained. This is then transported by vacuum onto an ice-cooled glass filter, and the product washed thoroughly with 28% sodium hydroxide at 0°C . The wet preparation is rapidly spread in a thin layer on fresh clay and stored at 0°C in an evacuated desiccator (no drying agent). The salt has the stoichiometric composition and contains, in addition to the hydroxide, about 0.4% SO_3 ; the preparative procedure should be designed to keep contamination by silicates or aluminates to a minimum.

PROPERTIES:

Formula weight 368.1. The salt, in the form of well-crystallized sky-blue rods, remains stable at 0°C if kept free of H_2O

and CO_2 . Solubility in 28% NaOH at 0°C is equivalent to 0.06% Mn_2O_5 . A solution of the salt in 50% potassium hydroxide turns grassy green upon heating or dilution; simultaneously, MnO_2 is precipitated according to the equation:

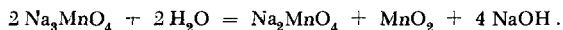

REFERENCES:

- H. Lux. *Z. Naturforschg.* **1**, 281 (1946) and unpublished work. The preparation of the sulfate-free product is described by R. Scholder, D. Fischer and H. Waterstradt, *Z. anorg. allg. Chem.* **277**, 236 (1954).

Potassium Manganate (VI)

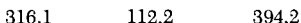
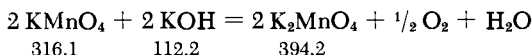

A solution of 30 g. of KOH in 50 ml. of water is prepared; 10 g. of KMnO_4 is added and the mixture is boiled in an open 250-ml. Erlenmeyer flask until a pure green solution is obtained. The water lost by evaporation is then replaced and the flask set in ice. The precipitated black-green crystals, which show a purplish luster, are collected on a Pyrex glass filter, washed (high suction) with some 1N potassium hydroxide, and dried over P_2O_5 . The salt can be recrystallized by dissolving in dil. potassium hydroxide and evaporating in vacuum.

PROPERTIES:

Formula weight 197.1. Solubility (20°C) in 2N potassium hydroxide 224.7 g./liter, in 10N potassium hydroxide 3.15 g./liter.

REFERENCES:

- K. A. Jensen and W. Klemm. *Z. anorg. allg. Chem.* **237**, 47 (1938); R. Luboldt. *J. prakt. Chem.* **77**, 315 (1859). Preparation of an especially pure, KOH -free product is described by R. Scholder and H. Waterstradt, *Z. anorg. allg. Chem.* **277**, 172 (1954).

Barium Manganate (VII)

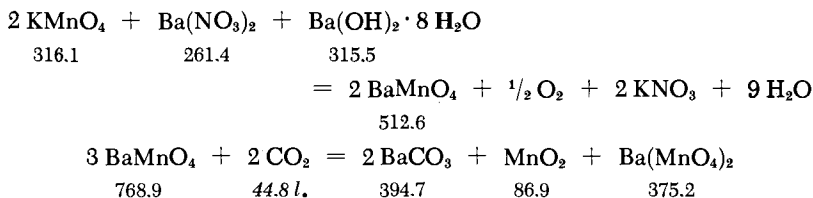

A solution of 100 g. of KMnO_4 and 100 g. of $\text{Ba}(\text{NO}_3)_2$ in 1.5 liters of boiling water is prepared and treated with 20 g. of $\text{Ba}(\text{OH})_2 \cdot 8 \text{H}_2\text{O}$. The solution is heated on a water bath with frequent agitation until the evolution of O_2 largely ceases, whereupon another 20 g. of $\text{Ba}(\text{OH})_2 \cdot 8 \text{H}_2\text{O}$ is added and the water lost by evaporation replaced. The procedure is continued until the liquid becomes colorless. When the sparingly soluble BaMnO_4 settles out (together with some MnO_2 and BaCO_3), the liquid is decanted, the precipitate washed repeatedly with several liters of boiling water, boiled with a dilute solution of $\text{Ba}(\text{OH})_2$, and rewashed thoroughly with boiling water.

The precipitate is then suspended in 1 liter of water and completely decomposed by introducing simultaneously CO_2 and superheated steam. This takes a few hours. The solution is left to settle; the liquor is suction-filtered through glass and concentrated until the almost black crystals appear upon cooling. The yield is 65-80 g. (80 to 100% of theory). Permanganates of all types of metals can be prepared by reacting the $\text{Ba}(\text{MnO}_4)_2$ with an equivalent quantity of sulfate.

SYNONYM:

Barium permanganate.

PROPERTIES:

Sparingly soluble in water; d 3.77.

REFERENCES:

W. Muthmann. Ber. dtsch. chem. Ges. 26, 1017 (1893); H. G. Grimm, C. Peters and H. Wolff. Z. anorg. allg. Chem. 236, 73 (1938).

Silver Manganate (VII)

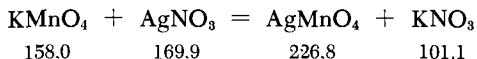

A hot (80°C) solution of 5 g. of AgNO_3 in 100 ml. of water is added to a hot (80°C) solution of 4.66 g. of KMnO_4 in 300 ml. of water to which a drop of conc. nitric acid has been added. The mixture is permitted to cool. Since the product still contains some K, it is recrystallized from water by slow cooling from 80°C.

The black, lustrous, needle-shaped crystals tend to decompose on prolonged storage. Because of its limited solubility, this salt is less suitable as a raw material for other permanganates than $\text{Ba}(\text{MnO}_4)_2$.

SYNONYM:

Silver permanganate.

PROPERTIES:

Solubility (room temperature) 9 g./liter H_2O ; d 4.49. Crystal structure: type H0_9 .

REFERENCE:

W. Büssem and K. Herrmann. Z. Kristallogr. A 74, 459 (1930).

 BaSO_4 - KMnO_4 Solid Solution

The solid solution (mixed crystals), described and examined in detail by Grimm and Wagner, is prepared simply by mixing together solutions of $\text{Ba}(\text{NO}_3)_2$ and K_2SO_4 , both containing a high percentage of KMnO_4 . As an example, the following conditions were found to be suitable:

A solution of 1.31 g. (5 mmoles) of $\text{Ba}(\text{NO}_3)_2$ and 50 g. of KMnO_4 in 1 liter of water is prepared; similarly, 0.87 g. (5 mmoles) of K_2SO_4 and 50 g. of KMnO_4 are dissolved in 1 liter of water. Heating is required in both cases. The clear solutions—suction-filtered through glass, if necessary—are brought to 50°C, added together, and allowed to stand for a short time at 50°C. The crystals are then separated by suction filtration.

Washing the mixed crystals with acetone until the wash liquid turns a light rose results in a product with a KMnO_4 content of 25-30 mole %; treatment with water, however, readily decomposes

the crystals. A more stable solid solution, containing 6-8 mole % KMnO_4 , is obtained by washing with water at 50°C , rinsing with a SO_2 solution, and repeating the washing. It is possible to boil the rose to purple powder with solutions of SO_2 or other reducing agents without a change in composition. The surface of the compound is decomposed on prolonged exposure to sunlight (with precipitation of manganese oxides).

REFERENCES:

- H. G. Grimm and G. Wagner. *Z. phys. Chem.* **132**, 135 (1928); see also A. Benrath and H. Schackmann. *Z. anorg. allg. Chem.* **218**, 139 (1934).

Potassium Manganese (III) Chloride

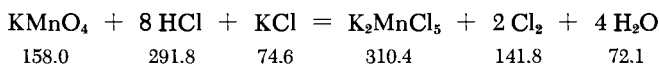

In the method of Weinland and Dinkelacker the compound is prepared as follows: 5 g. of KMnO_4 powder is added (constant shaking) to 50 ml. of approx. 40% HCl (d 1.19). The initial fine, brown precipitate is slowly dissolved on frequent shaking, while copious quantities of Cl_2 are being evolved. The solution is left standing for two hours, then decanted from any black K_2MnCl_5 that may have precipitated, and conc. aqueous KCl is added dropwise to the deep dark-red to brown solution (constant agitation) until the liquid becomes nearly colorless. The crystalline, brownish K_2MnCl_5 precipitate is filtered off by suction and dried over KOH .

REFERENCES:

- R. F. Weinland and P. Dinkelacker. *Z. anorg. allg. Chem.* **60**, 173 (1908). For the hydrate $\text{K}_2\text{MnCl}_5 \cdot \text{H}_2\text{O}$, see C. E. Rice. *J. Chem. Soc. (London)* **73**, 260 (1898).

Potassium Hexachloromanganate (IV)

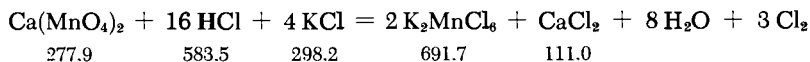

In the method of Weinland and Dinkelacker, 5.0 g. of $\text{Ca}(\text{MnO}_4)_2$ is added (constant agitation) to 50 ml. of 40% hydrochloric

acid cooled with an ice-salt mixture. A solution of 2 g. of KCl in 8 ml. of water is added simultaneously in drops. The almost black, crystalline precipitate is rapidly separated by suction filtration and dried for a short time on a clay plate over conc. H_2SO_4 .

PROPERTIES:

Formula weight 345.9. Small, translucent, deep dark-red crystals; liberates Cl_2 continuously even in dry air.

REFERENCE:

R. F. Weinland and P. Dinkelacker. *Z. anorg. allg. Chem.* **60**, 173 (1908).

Manganese (II) Sulfide

MnS

α -MnS, GREEN, CUBIC

This modification, which has been thoroughly studied by x-ray techniques, is obtained via the method of Classen.

A boiling solution of about 10 g. of $\text{MnCl}_2 \cdot 4\text{H}_2\text{O}$ in 500 ml. of water containing a small quantity of $\text{K}_2\text{C}_2\text{O}_4$ is reacted with an excess of a 50% NH_3 solution and saturated at its boiling point with H_2S . Upon further heating, the initial flesh-colored MnS precipitate is rapidly converted to the stable dark-green α -modification. To remove any coprecipitated sulfur, the sulfide is boiled three times with a dil. solution of freshly prepared, colorless $(\text{NH}_4)_2\text{S}$ and, after filtering, washed successively with H_2S -containing water, alcohol and ether. It is dried in an oil-pump vacuum at 120°C .

The dry preparation of α -MnS (alabandite) is described by H. Haraldsen and W. Klemm, *Z. anorg. allg. Chem.* **220**, 271 (1936); for the synthesis of MnS_2 (hauerite), see W. Biltz and F. Wiechmann, *ibid.* **228**, 271 (1936).

PROPERTIES:

Formula weight 86.99. M. p. 1610°C ; d 3.99. Crystal structure: B1 (rock salt) type.

REFERENCES:

- H. Schnaase. Z. phys. Chem. (B) 20, 89 (1933); F. Mehmed and H. Haraldsen. Z. anorg. allg. Chem. 235, 194 (1938); A. Classen. Z. analyt. Chem. 16, 319 (1877).

 β -MnS, RED, CUBIC

In the method of Schnaase, the γ -modification is obtained by introducing H_2S into a cold solution of 50 g. of $Mn(CH_3COO)_2 \cdot 4H_2O$ in 300 ml. of water. After some time, most of the sulfide settles on the bottom as a reddish-brown precipitate, while another fraction adheres to the glass wall as a beautiful, minium-red scale. The precipitate is washed with H_2S -saturated water (the preferred washing method is decantation), filtered off with suction while H_2S is being passed over it, washed again with alcohol and ether, and dried in an oil-pump vacuum at $80^\circ C$.

Crystal structure: B3 (sphalerite) type.

REFERENCES:

- H. Schnaase. Z. phys. Chem. (B) 20, 89 (1933); F. Mehmed and H. Haraldsen. Z. anorg. allg. Chem. 235, 194 (1938).

 γ -MnS, RED, HEXAGONAL

Schnaase prepares the γ -modification by first dissolving 20 g. of analytically pure $MnCl_2 \cdot 4H_2O$ and some NH_4Cl in 500 ml. of boiled water through which a stream of O_2 -free N_2 is being bubbled. Then H_2S is introduced at the boiling temperature and $Mn(OH)_2$ is precipitated out with a slight excess of concentrated NH_3 solution. The precipitate is initially white, gradually turns a light pink upon further contact with H_2S , and finally assumes the color of red meat, while the sulfide forming the surface layer is first orange yellow and later turns vermilion red. After settling, the precipitate is washed twice by decanting with H_2S -saturated water and boiled for two days in a 10% NH_3 solution while H_2S is bubbled through. Finally it is washed by decanting several times with H_2S -saturated water, filtered off in the absence of air while under a N_2 stream, washed with alcohol and ether, and dried in an oil-pump vacuum at $80^\circ C$. Any coprecipitated sulfur is removed by extraction with boiling CS_2 under nitrogen.

Crystal structure: B4 (wurtzite) type.

The conversion of the two dry, metastable red MnS modifications to the stable form starts at $200^\circ C$. The rate is appreciable, and is higher at $300^\circ C$. The red modifications also differ from the α -form in their magnetic behavior.

REFERENCES:

- H. Schnaase. Z. phys. Chem. (B) 20, 89 (1933); F. Mehmed and H. Haraldsen. Z. anorg. allg. Chem. 235, 194 (1938).

Manganese (III) Sulfate

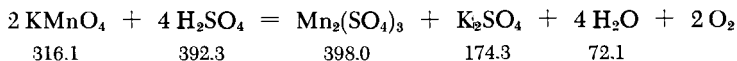
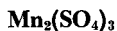

In the method of Domange, the crystalline $\text{Mn}_2(\text{SO}_4)_3$ is prepared by introducing 20 g. of KMnO_4 powder into 100 ml. of H_2SO_4 (d 1.84) contained in a porcelain crucible (agitation); the mixture is carefully heated for 10 minutes at 60°C while stirring vigorously, whereby vapors of the explosive Mn_2O_7 are removed. The solution is then heated to 70°C (or at most to 75°C) with continued very vigorous agitation and accurate temperature control (thermometer). Vigorous evolution of O_2 takes place while the liquid turns brown and becomes clouded, with a tendency for a spontaneous rise in temperature, so that the danger of an explosion persists. After about 15 minutes, with most of the reaction completed, the danger of an explosion passes. The mixture is now slowly (10 minutes) brought to 140°C with continued stirring and is finally raised to 200°C (in 15 minutes). Following slow cooling, the solution is washed twice by decantation with H_2SO_4 (d 1.84) to remove the K_2SO_4 . The product is collected on a glass filter and placed on a clay plate. The latter is placed for three to four days in a desiccator containing P_2O_5 . The H_2SO_4 may be completely removed by heating the preparation, together with a receiver cooled to -80°C , for about three hours at 200°C and high vacuum; the salt itself does not begin to decompose until about 300°C .

PROPERTIES:

Extremely hygroscopic salt consisting of small, dark-green needles. Soluble in 75.25% wt. % or more H_2SO_4 without alteration; a brown salt of composition $\text{Mn}_2(\text{SO}_4)_3 \cdot \text{H}_2\text{SO}_4 \cdot 6 \text{H}_2\text{O}$ crystallizes out from dilute (preferably 70%) sulfuric acid [A.R.J.P. Ubbelohde, J. Chem. Soc. (London) 1935, 1605]. Sulfuric acid in concentrations lower than 52% produces hydrolysis.

REFERENCE:

- L. Domange. Bull. Soc. Chim. France [5] 4, 594 (1937).

Cesium Manganese (III) Sulfate

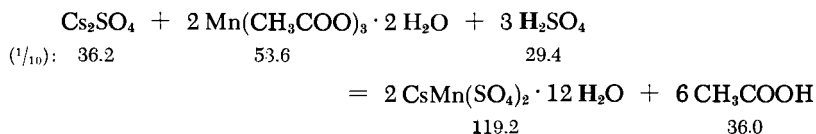
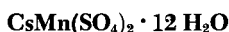

In Christensen's method, 5.3 g. (0.01 mole) of $\text{Mn}(\text{CH}_3\text{COO})_3 \cdot 2\text{H}_2\text{O}$ is dissolved in sulfuric acid (conc. H_2SO_4 diluted 1:3), starting at room temperature. Then, a solution of 3.6 g. (0.01 mole) of Cs_2SO_4 in 10 ml. of sulfuric acid of the same concentration is added; the solution is first cooled to -25°C in order to accelerate the precipitation and then left to stand for a long time at -5°C . The alum crystals are filtered off with suction and stored in a hermetically sealed bottle.

SYNONYM:

Cesium manganese alum.

PROPERTIES:

Coral-red crystalline powder. Melts at 40°C in the water of hydration; however, turns brownish black slightly above room temperature. The hydrated Mn_2O_3 is precipitated upon addition of water. The corresponding Rb alum melts at room temperature.

REFERENCES:

- O. T. Christensen. *Z. anorg. Chem.* **27**, 329 (1901); H. Bommer. *Z. anorg. allg. Chem.* **246**, 281 (1941).

Manganese Nitride



The nitride is prepared from very reactive sublimed manganese. The metal is heated in an apparatus which permits the continuous measurement of the amount of N_2 used in the reaction. A completely O_2 -free nitrogen is used, under a pressure of ~ 100 mm. and a temperature of 690°C . The reaction is continued until a constant final pressure is obtained (12-24 hours).

The product corresponds quite exactly to the formula Mn_4N (6.0% N; ϵ -phase according to Hägg) and is strongly ferromagnetic. Below 400°C the homogeneous region of the phase extends from about 6.0 to 6.5% N.

REFERENCES:

- U. Zwicker. Z. Metallkunde 42, 277 (1951); R. Schenk and A. Kortengraber. Z. anorg. allg. Chem. 210, 273 (1933); G. Hägg. Z. phys. Chem. B4, 346 (1929); L. F. Bates, R. E. Gibbs and D. V. Reddi Pantulu. Proc. Phys. Soc. 48, 665 (1936); see also H. Nowotny. Z. Elektrochem. 49, 245 (1943).
 For Mn_4P , Mn_2P , etc., see W. Blitz and F. Wiechmann, Z. anorg. allg. Chem. 234, 117 (1937).

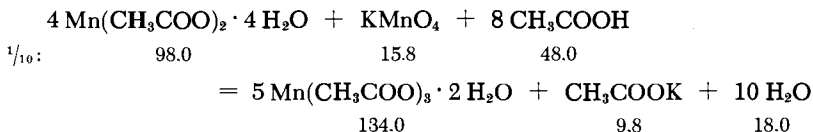
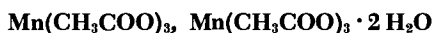
Manganese (III) Acetate

In the method of Christensen, the salt is obtained in the following manner: 19.6 g. (80 mmoles) of $Mn(CH_3COO)_2 \cdot 2 H_2O$ powder is added to 200 ml. of glacial acetic acid at the boiling temperature of the latter, and is stirred until completely dissolved. Then, $KMnO_4$ powder (3.1 g. = 20 mmoles) is gradually added and the mixture heated for a short time with constant agitation. After cooling, 3 ml. of water is added to the dark-brown solution; the mixture is allowed to stand overnight. If the quantity of precipitate is too small, another 3 ml. of water is added and the solution stirred. The formation of crystallization nuclei is promoted by frequent rubbing of the container walls with a glass rod. As a rule, copious crystallization occurs within about one hour. If necessary, the solution is allowed to stand for a few more days (frequent agitation) until the mother liquor is almost colorless. The salt is then filtered off with suction, washed with some glacial acetic acid and recrystallized. The last procedure consists in dissolving 30 g. of salt in 200 ml. of glacial acetic acid (heating), filtering off and working up further in the manner described above. Finally, the salt is dried over CaO .

PROPERTIES:

The cinnamon-brown crystals of a silky luster are immediately decomposed by cold water (hydration).

In activity the compound is likely to be a complex salt with three nuclei, of the following structure: $[\text{Mn}_3(\text{CH}_3\text{COO})_6(\text{H}_2\text{O})_2 - (\text{CH}_3\text{COO})_3 \cdot 4 \text{H}_2\text{O}]$.

REFERENCES:

- O. T. Christensen. *Z. anorg. Chem.* 27, 325 (1901); R. F. Weiland and G. Fischer. *Z. anorg. allg. Chem.* 120, 161 (1921).

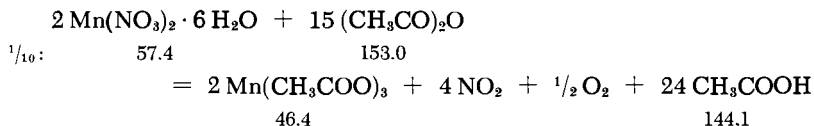
Mn(CH₃COO)₃

Chrétien and Varga obtain the salt from $\text{Mn}(\text{NO}_3)_2$ and acetic anhydride. A mixture of 20 g. of $\text{Mn}(\text{NO}_3)_2 \cdot 6 \text{H}_2\text{O}$ and 80 g. of acetic anhydride is heated slightly (shaking) until the vigorous, strongly exothermic reaction evolving large amounts of gas is well under way. When the reaction is completed, the homogeneous, oily liquid is cooled; the anhydrous acetate precipitates out as a brown, crystalline powder. The latter is collected on a glass filter, washed first with acetic anhydride and then with some ether to remove the odor of acetic acid, and stored in a closed container (anhydrous conditions). The yield, based on manganese, is 85%.

REFERENCE:

- A. Chrétien and G. Varga. *Bull. Soc. Chim. France* [5] 3, 2387 (1936).

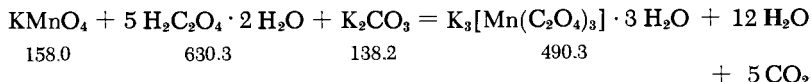
Potassium Trioxalatomanganate (III)

Cartledge and Ericks prepare the ferric ion-free compound (which is very sensitive to light) from analytically pure KMnO_4 according to the equation presented above. A solution of 31.5 g. (0.25 moles) of $\text{H}_2\text{C}_2\text{O}_4 \cdot 2 \text{H}_2\text{O}$ in 200 ml. of water is heated in

a 500-ml. beaker to 70-75°C; then, 6.32 g. (0.04 moles) of KMnO_4 powder is added little by little (constant agitation) and as soon as the solution turns colorless, 6.9 g. (0.05 moles) of K_2CO_3 is introduced in a similar manner. The mixture is cooled to 4-5°C (frequent stirring) and diluted with 150 ml. of 0-1°C water.

In all of the following operations light must be excluded as much as possible. The oxidation to Mn^{3+} is effected through the gradual addition of 1.58 g. (0.01 mole) of KMnO_4 powder; the solution is then stirred for about 10 minutes at 0 to 2°C. The intense cherry-red liquid is then suction-filtered through a glass filter precooled to 0°C, and is collected in a similarly cooled beaker. Next, the solution is reacted with half its volume of ice-cold alcohol and left to crystallize for two hours in an ice-salt mixture.

The precipitate is collected on a precooled glass filter, washed four times with 25 ml. of 50 vol. % alcohol, then with 95% alcohol, absolute alcohol and finally (three times) with ether; all of the wash liquids must be ice cold. After filtration with suction, the deep reddish-purple crystals are spread in a thin layer and exposed to air for a few hours; they are stored in brown bottles. The yield is ~50%.

PROPERTIES:

Very pure product can be stored for a long time at 20°C in the absence of air; stable for an almost unlimited time at -6°C. Readily soluble in water: concentrated solutions are deep reddish-brown; very dilute or acidified solutions are yellowish-brown. The color change is due to the shift of the instantly established equilibrium:

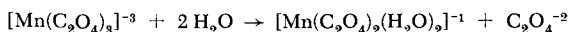

The salt is a normal complex.

REFERENCE:

- G. H. Cartledge and W. P. Ericks. *J. Amer. Chem. Soc.* **58**, 2061 (1936).

Potassium Dioxalatodihydroxomanganate (IV)

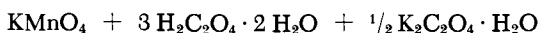
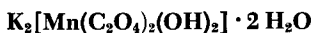

158.0

378.2

92.1

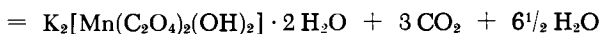

379.2

This compound, discovered by Cartledge and Ericks, is prepared in a manner quite similar to that of $\text{K}_3[\text{Mn}(\text{C}_2\text{O}_4)_3]$. Thus,

17.64 g. (0.14 moles) of $\text{H}_2\text{C}_2\text{O}_4 \cdot 2\text{H}_2\text{O}$ is dissolved in 250 ml. of water and the solution is cooled to 0°C ; then, 6.32 g. (0.04 moles) of KMnO_4 powder and 4.78 g. (0.026 moles) of $\text{K}_2\text{C}_2\text{O}_4 \cdot \text{H}_2\text{O}$ are added with constant agitation. The mixture is stirred vigorously for about 20 minutes; the temperature should rise gradually to 7°C during this time. As soon as CO_2 begins to evolve at this temperature, the dark-green solution is rapidly cooled to 0°C in an efficient cooling mixture (swirling necessary) and is quickly suction-filtered through a Büchner funnel (filter paper). The filtrate is immediately placed in a cooling mixture and reacted with 100 ml. of alcohol in small portions at 0°C ; the complex salt is thus precipitated as a very fine, crystalline powder. The latter is rapidly filtered off, washed successively with ice-cold 50% alcohol, 95% alcohol, absolute alcohol and ether, and stored at 0°C .

The salt can be recrystallized at 0°C : the powder is dissolved in 25 times its volume of cold 0.1 M oxalic acid, filtered rapidly at 0°C , the solution diluted with 1/6 its volume of ice-cold 95% alcohol and placed in a cooling mixture for crystallization. It is best to prepare the salt in a cold room, otherwise proper cooling becomes cumbersome.

PROPERTIES:

Green, crystalline salt; not homogeneous; consists of green and orange rods (probably the cis and trans forms). Rapidly decomposed at room temperature, particularly when exposed to light; remains stable for a few weeks at -6°C if light is excluded. Solutions are initially green, but rapidly turn brown and become clouded; solutions containing some oxalic acid kept at 0°C remain clear for some time.

REFERENCE:

G. H. Cartledge and W. P. Ericks. *J. Amer. Chem. Soc.* **58**, 2061 (1936).

Potassium Hexacyanomanganate (I)

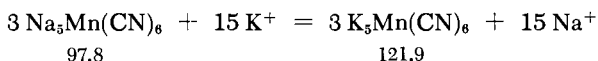
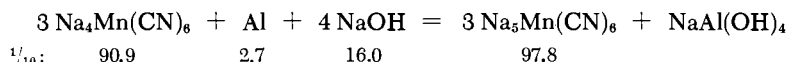

According to Manchot and Gall, the salt is best prepared by starting with $\text{Na}_4\text{Mn}(\text{CN})_6 \cdot x\text{H}_2\text{O}$ (see p. 1473). Thus, 10 g. of the

salt is dissolved in 150 ml. of 2% sodium hydroxide (Erlenmeyer flask), the air being kept out during this operation by a stream of H_2 . Then, 8 g. of Al granules is added little by little, but rather rapidly (2 minutes); the sparingly soluble $Na_2Mn[Mn(CN)_6]$ should not precipitate in the process. After about five minutes the solution becomes intensely yellow-brown; it is then rapidly suction-filtered through a Pyrex filter of small pore size. The filtrate is allowed to flow into 150 ml. of a solution containing 15 g. of KOH and 30 g. of KCN and saturated with KCl. The desired compound is thereby precipitated as a white, crystalline powder, only sparingly soluble in water; any Mn^{++} present remains in solution. The salt is separated by rapid filtration through a Pyrex filter and thoroughly washed, first with 200 ml. of 10% potassium hydroxide, then with 100 ml. of 20% KCN solution, and finally with about 700 ml. of boiled, ice-cold water (until the filtrate is completely colorless).

PROPERTIES:

The potassium salt obtained in the above manner is slowly oxidized in moist air, turning brown. The sodium salt solution is rapidly discolored in air; H_2 is liberated on boiling but there is a slow evolution even at room temperature.

REFERENCES:

- W. Manchot and H. Gall. Ber. dtsch. chem. Ges. 61, 1135 (1928).
Preparation by means of a sodium amalgam is described by
W. D. Treadwell and W. E. Raths. Helv. Chim. Acta 35,
2277 (1952).

Potassium Hexacyanomanganate (II)

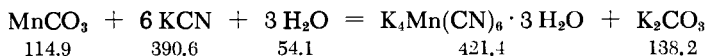
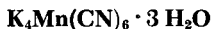

A paste of 20 g. of freshly precipitated $MnCO_3$ (see the next preparation) is placed in a flask from which the air has been displaced with N_2 and heated on a water bath to 70-80°C. A solution of 80 g. of KCN in 100 ml. of water is added slowly in drops, and the mixture is maintained at this temperature for an additional half hour (occasional swirling). The small residue of undissolved $MnCO_3$ is removed by rapid filtration of the hot solution, air being excluded as completely as possible. The bluish-purple crystals which precipitate from the yellow solution on cooling are separated by suction filtration, washed with alcohol, and dried in a N_2 stream at room temperature.

Alternate method: Readily prepared from $\text{Mn}(\text{CH}_3\text{CO})_2$ and KCN. The sodium compound $\text{Na}_4\text{Mn}(\text{CN})_6$ is prepared in a completely similar manner; it is more soluble than the potassium salt.

SYNONYM:

Potassium manganese (II) cyanide.

PROPERTIES:

Soluble without being altered only in solutions which have a KCN concentration higher than 1.5 N; at lesser CN concentrations, the greenish $\text{K}_2\text{Mn}[\text{Mn}(\text{CN})_6]$ is precipitated. The crystals effloresce in air with partial oxidation.

REFERENCES:

- G. Grube and W. Brause. *Ber. dtsh. Chem. Ges.* **60**, 2273 (1927); J. Meyer. *Z. anorg. allg. Chem.* **81**, 390 (1913); P. Straus. *Z. anorg. Chem.* **9**, 6 (1895).

Potassium Hexacyanomanganate (III)

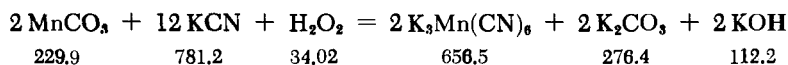
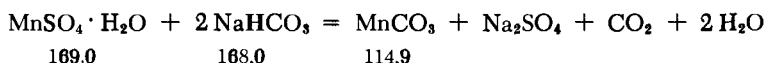

A fresh precipitate of MnCO_3 is prepared by slowly adding a solution of 50 g. of $\text{MnSO}_4 \cdot \text{H}_2\text{O}$ in 120 ml. water to a solution of 75 g. of NaHCO_3 in 950 ml. of water (20°C, good stirring; caution: the mixture tends to foam). The product is filtered off with suction, washed with a large amount of water, and, while still wet, thoroughly mixed with a solution of 135 g. of KCN in 270 ml. of water, producing a dark-blue solution of $\text{K}_4\text{Mn}(\text{CN})_6$. Following cooling to ~15°C, 150 ml. of 3% H_2O_2 is added slowly and with stirring. The solution is allowed to stand for a few minutes until its color turns deep dark brown. With sufficient cooling no appreciable amount of O_2 is evolved.

The solution is now passed without delay through a suction filter (to remove any small residues of MnO_2 and similar compounds) and allowed to crystallize overnight in a refrigerator. The precipitated crystals (60-70 g., 63-74% yield based on MnSO_4)

are filtered off with suction, washed with alcohol and dried in a desiccator. An additional crop can be recovered from the mother liquor by covering it carefully with a layer (roughly the same volume) of alcohol and allowing to stand for several days.

If it is necessary to recrystallize the salt, it is covered with 8-10 times its volume of 10% KCN, rapidly heated on a water bath to 45°C (stirring), immediately suction-filtered, cooled with ice and covered with alcohol as described above.

SYNONYM:

Potassium manganese (III) cyanide.

PROPERTIES:

Dark red-brown needles; stable in air; decomposed by water, forming hydrated Mn_2O_3 .

REFERENCES:

This procedure was developed in (unpublished) experiments in cooperation with E. Brodkorb; G. Grube and W. Brause. Ber. dtsch. chem. Ges. 60, 2273 (1927); J. Meyer. Z. anorg. allg. Chem. 81, 390 (1913).

Rhenium

O. GLEMSER

Rhenium Metal

Prepared by reduction of NH_4ReO_4 or KReO_4 with H_2 .

I. Fine NH_4ReO_4 powder is slowly heated to 200-250°C in very pure H_2 and held at that temperature for three hours. The temperature is then raised to 500°C and the reduction completed at 1050°C (six hours). The boats and reactor tubes should be porcelain.

If heating rates are too high, part of the product evaporates as the oxide and deposits to form a mirror on the cooler parts of the tube.

II. KReO_4 , in a silver boat, is reduced in very pure H_2 at 500°C. The product is extracted with H_2O containing a small amount of HCl , dried and again reduced with H_2 in a porcelain boat at 1000°C.

PROPERTIES:

Atomic weight 186.22. Gray metal powder; the solid has a platinum-like luster. M.p. 3170°C; d 20.35; Brinell hardness 250. Readily soluble in nitric acid and slowly in sulfuric acid. Crystal structure: A 3 type.

REFERENCES:

- I. W. Biltz and G. A. Lehrer. *Nachr. Gött. Ges.* 1931, 193.
- II. W. Biltz. *Z. Elektrochem.* 37, 498 (1931); W. Geilmann. Private communication.

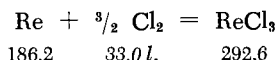
Rhenium (III) Chloride

Rhenium metal is placed in a reactor consisting of a hard glass tube joined to a receiver manifold with seven bulbs

sealed on. The air is displaced with oxygen-free H_2 and the Re then heated in a stream of Cl_2 . The raw sublimate is collected in the first bulb; it is resublimed into the second bulb under oxygen-free, dry N_2 (the less volatile $ReCl_3$ remains in the first bulb). The operation is repeated using the next set of bulbs, etc. The $ReCl_3$ fractions are then collected from all the bulbs and resublimed at 2-3 mm. and 500-550°C.

ANALYSIS:

Oxidation to ReO_4^- with sodium hydroxide + H_2O_2 ; the ReO_4^- ion is precipitated as nitron hydrogen perrhenate.

PROPERTIES:

Dark purple-red crystals. Bimolecular under normal conditions (Re_2Cl_6). Converted in moist air to $ReCl \cdot 2H_2O$ (2-3 hours); the water of hydration is readily removed by heating to 100°C in vacuum over P_2O_5 . Soluble in water with a deep dark-red color; the solution turns cloudy after several hours because of hydrolysis, and black $Re_2O_3 \cdot H_2O$ is precipitated. Complete hydrolysis on boiling. Soluble in glacial acetic acid and dioxane (reddish-purple color), alcohol and liquid ammonia; slightly soluble in ether. A $AgNO_3$ solution produces a precipitate only after lengthy heating with nitric acid. Forms well-crystallized compounds with $RbCl$, $CsCl$ and organic bases. Hexagonal crystal structure.

REFERENCES:

- W. Geilmann, F. W. Wrigge and W. Biltz. *Nachr. Gött. Ges.* 1932, 582; W. Geilmann and F. W. Wrigge. *Z. anorg. allg. Chem.* 214, 249 (1933); O. W. Kolling. *Trans. Kansas Acad. Sci.* 56, 378 (1953).

Rhenium (V) Chloride

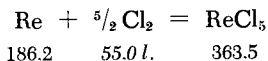

Rhenium metal is placed in a boat which is inserted into the hard glass apparatus of Fig. 328. The air is displaced by O_2 -free nitrogen and the Re chlorinated at 500°C in a stream of Cl_2 . The evolving black-brown vapors are condensed at *a* as a black solid. The apparatus is sealed off at 1, connected at 5 to a high vacuum,

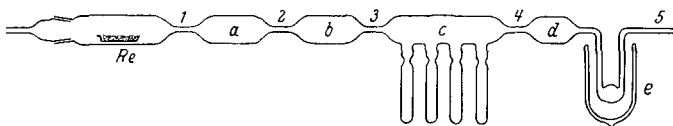

Fig. 328. Preparation of rhenium (V) chloride

evacuated and heated from 20 to 50°C; small fractions of the very volatile ReOCl_4 (b.p. 223°C) are then condensed in *d* and *e*. The bulk of the ReCl_5 is driven into *b* at 150 to 250°C, the tube melt-sealed at 2, and the substance sublimed at 200°C from *b* to *c*, leaving only a slight residue in *b*. Finally, the tube is melt-sealed at 3 and 4 and the preparation distributed (by shaking) into the small tubes attached at *c*; the latter are then melt-sealed.

PROPERTIES:

A deep, black-brown powder; dark brown vapor. Sensitive to air, sublimation at atmospheric pressure results in decomposition. Hydrolyzed by water, forming various products. Soluble in hydrochloric acid (green solution) with liberation of Cl_2 .

REFERENCES:

W. Geilmann, F. W. Wrigge and W. Blitz. *Angew. Chem.* **46**, 223 (1933); *Z. anorg. allg. Chem.* **212**, 244 (1933).

Potassium Rhenium (IV) Chloride

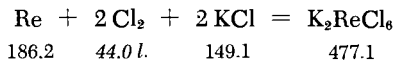

Fine Re powder is intimately ground with KCl (10% excess) and slowly heated to about 300°C in a porcelain boat, first under N_2 and then in a slow Cl_2 stream. The K_2ReCl_6 is formed immediately and only a slight quantity of rhenium chlorides is volatilized. Following cooling in a stream of N_2 , the substance is dissolved in some hot 5% HCl and recrystallized; the remainder is obtained by concentration and crystallization during cooling.

Alternate method: Reaction of KReO_4 with KI and hydrochloric acid. The procedure is involved and it is difficult to obtain a pure product [H. Schmidt, *Z. anorg. allg. Chem.* **212**, 188 (1933); O. W. Kolling, *Trans. Kansas Acad. Sci.* **56**, 379 (1953)].

PROPERTIES:

Yellowish-green powder or regular green crystals. Melts with decomposition. Addition of conc. H_2SO_4 at moderate temperatures produces HCl . Fair solubility in water. Solubility in 12% HCl : 21.4 (0°C); 30.3 (18°C) g./liter; in 37% HCl : 3.3 (0°C); 3.7 (18°C) g./liter. d_4^{15} 3.34. Crystal structure: type J1_1 .

REFERENCE:

W. Geilmann. Private communication.

Rhenium (VI) Oxychloride



Prepared via reaction of Re_2O_7 with ReCl_5 .

Rhenium metal is chlorinated at 500°C in a stream of Cl_2 in the apparatus described for the preparation of ReO_3Cl . Following cooling, the Cl_2 is displaced with O_2 and the sections of the tube in which brown-black crystals of ReCl_5 have appeared are heated with a small flame to $50\text{--}70^\circ\text{C}$. The ReCl_5 melts (often with appearance of a flame) and the crystals turn into a brown liquid, which is then distilled in a stream of N_2 into a well-cooled U tube receiver. The excess Cl_2 is evaporated, the apparatus filled with O_2 , and the liquid brought to a gentle boil. Heating at 200°C in an N_2 stream is continued for an hour in order to completely remove all traces of ReO_3Cl . Then about one third of the remaining liquid is distilled off. The receiver is now replaced by a fresh one and, except for a small residue, the remaining liquid is distilled over.

Alternate method: From ReCl_3 and dry O_2 at 110 to 130°C [O. W. Kolling, Trans. Kansas Acad. Sci. 56, 378 (1953)].

PROPERTIES:

Formula weight 344.05. Fibrous needles; dark orange in thin, brownish-red in thick layers. M.p. 29.3°C , b.p. 223°C (slight decomposition). Decomposes at 300°C . Immediately forms ReO_3Cl on heating in a stream of O_2 . Hydrolyzed by water to rhenium (IV) hydroxide and HReO_4 .

REFERENCE:

A. Brukl and K. Ziegler. Ber. dtsch. chem. Ges. 65, 916 (1932).

Rhenium (VII) Oxychloride



Prepared by reaction of Re_2O_7 (excess) with ReCl_5 .

Two boats, one containing five and the other two parts of Re, are placed in a high-melting glass reactor tube in a manner such that heating of one will not raise the temperature of the other. A U-shaped tube and two condensation traps are connected to the reactor by means of ground-glass joints (the traps are cooled to -65°C with alcohol-Dry Ice). The air in the apparatus is displaced with O_2 and the first boat (the one containing five parts of Re) is heated in a slow stream of O_2 in such a way that the Re_2O_7 formed is deposited in the tube (the U tube must be cooled to a low temperature during this operation). The oxygen is then displaced with Cl_2 and the second boat heated in a stream of Cl_2 . The rhenium chlorides formed in this manner react with the Re_2O_7 and the products of this reaction are condensed in the U tube. Any cocondensed Cl_2 is evaporated; then, the ReO_3Cl is distilled over as the first fraction boiling above 100°C (it is usually very light blue or green). On repeated fractionation in a stream of N_2 the product becomes colorless.

Alternate method: From ReO_3 and dry Cl_2 at $160\text{--}190^\circ\text{C}$. Yields exceed 70% [C. J. Wolf, A. F. Clifford and W. H. Johnston, J. Amer. Chem. Soc. 79, 4257 (1957)].

PROPERTIES:

Formula weight 269.68. Colorless liquid; strongly light refracting. M.p. 4.5°C , b.p. 131°C (corr.). Reacts instantaneously with Hg, Ag, stopcock grease and numerous other organic compounds. Soluble in CCl_4 . Hydrolyzes to HReO_4 and HCl .

REFERENCE:

A. Brukl and K. Ziegler. Ber. dtsh. chem. Ges. 65, 916 (1932).

Rhenium (IV) Oxide

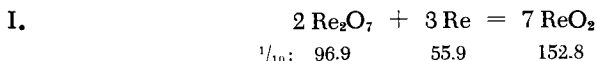

A stoichiometric mixture of Re and Re_2O_7 is heated to 300°C for one day in a small, evacuated, thick-wall quartz tube, which is

sealed by melting; the reactants are then heated to 600-650°C for an additional day. The product is orthorhombic ReO_2 .

II. Heating of NH_4ReO_4 in vacuum at 500°C yields monoclinic ReO_2 of the MoO_2 type; above 500°C, orthorhombic oxides are formed.

PROPERTIES:

Formula weight 218.22. Gray-black powder; dissociates in a high vacuum at 1000°C to Re and Re_2O_7 . Readily oxidized by O_2 . Insoluble in weak acids, but dissolved by conc. halogen acids. Converted to HReO_4 by H_2O_2 and HNO_3 . d_4^{25} 11.4. Heat of formation: -70 kcal.

REFERENCES:

- I. W. Biltz. Z. anorg. allg. Chem. 214, 227 (1933).
- II. W. H. Zachariasen. Amer. Crystallographic Assoc. Program and Abstracts of Winter Meeting, F 4 (1951); A. Magnéli. Acta Crystallogr. (Copenhagen) 9, 1038 (1956).

Rhenium (VI) Oxide

ReO_3

I. REDUCTION OF Re_2O_7 BY CARBON MONOXIDE

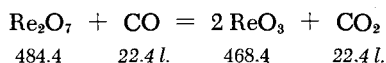

The apparatus is a glass tube sealed at one end; about 1 g. of Re_2O_7 is sublimed into it in a stream of O_2 . When the reaction is completed, the apparatus is evacuated and filled with CO to a pressure of 760 mm. The glass tube is then slowly heated to 175°C in a glycerol bath and held at that temperature until the preparation turns blue. The temperature is then slowly raised to 225°C and later, when red ReO_3 is formed, to 280°C. The run requires two to three hours. The yield is quantitative.

II. Reaction of Re_2O_7 with dioxane to form a complex compound, which dissociates at 125-145°C to ReO_3 and some volatile products.

The apparatus consists of a reaction flask protected against moisture; 4 ml. of dioxane is rapidly added to 1 g. of Re_2O_7 under anhydrous conditions (the dioxane should be predistilled

over Na metal). The mixture is gently heated on a water bath until a clear, colorless solution is obtained. Local overheating must be avoided, since it produces cloudy solutions and, ultimately, contaminated products. The flask is then placed in an ice bath to freeze the solution. After the freezing, the frozen substance is allowed to melt. The Re_2O_7 -dioxane complex crystallizes in the form of a dense, pearly-gray precipitate; the excess dioxane becomes liquid. The freezing-melting operation is then repeated, the excess of dioxane decanted, and the compound dried in a vacuum desiccator at room temperature over conc. H_2SO_4 . The dry complex is rapidly placed in a crucible and carefully heated on a hot plate (125 to 145°C). The substance is melted, forming a colorless to bluish-green liquid, which later dissociates to red ReO_3 and some volatile, Re-free products. The ReO_3 thus formed is pure. The yield is about 95%.

PROPERTIES:

Formula weight 234.22. Red powder. During reduction of Re_2O_7 , the preparation passes through intermediate stages with hues ranging from green to dark blue (rhenium blue) until the final red color is obtained. Decomposed in high vacuum at 400°C to Re_2O_7 and ReO_2 . Not attacked by hot hydrochloric acid, but converted to HReO_4 by strong HNO_3 . Disproportionates in warm NaOH to ReO_2 and NaReO_4 ; $\text{NaOH} + \text{H}_2\text{O}_2$ instantaneously produce NaReO_4 . d_4^{25} 6.9; heat of formation: -146.0 kcal. Crystal structure: D_{09} type.

REFERENCES:

- I. A. D. Melaven, J. N. Fowle, W. Brickel and C. F. Hiskey in: L. F. Audrieth, *Inorg. Syntheses*, Vol. III, New York-Toronto-London, 1950, p. 187.
- II. H. Nechamkin and C. F. Hiskey. *Ibid.*, p. 186; H. Nechamkin, A. N. Kurtz, and C. F. Hiskey. *J. Amer. Chem. Soc.* **73**, 2828 (1951).

Rhenium (VII) Oxide

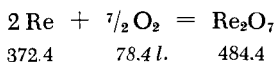

The compound is prepared in a combustion tube to which a U tube is sealed on; the latter is attached to a condensation trap.

Both ends of the tube are protected against humidity by vessels containing CaCl_2 and conc. H_2SO_4 . The rhenium metal is placed in a porcelain boat situated in the front section of the tube, which is heated to 150°C while a very fast stream of oxygen is passed over the metal. Crystals of Re_2O_7 deposit in the front section of the tube and in the condenser tube (there is virtually no vapor mist); if the starting Re is not entirely alkali-free, some KReO_4 will remain in the boat. The Re_2O_7 should be resublimed in a stream of O_2 .

The compound is used in the preparation of HReO_4 , of the lower oxides and of very pure Re (reduction with H_2).

PROPERTIES:

Bright-yellow crystalline powder. M. p. 301.5°C , b. p. 362.4°C ; d_4^{25} 6.103; heat of formation: -295.9 kcal. Extremely hygroscopic. Readily soluble in H_2O , forming HReO_4 ; soluble in alcohol; sparingly soluble in ether. Stored in melt-sealed glass tubes. Rhombic crystals.

REFERENCES:

- W. Geilmann. Private communication; W. A. Roth and C. Becker. *Z. phys. Chem.* **159**, 29 (1932); K. Wilhelmi. *Acta Chem. Scand.* **8**, 693 (1954).

Sodium Rhenate (IV)

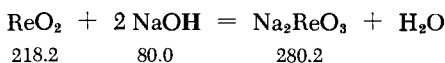

The apparatus is shown in Fig. 329. A gold crucible *c* is introduced into the quartz apparatus through opening *e* and placed in

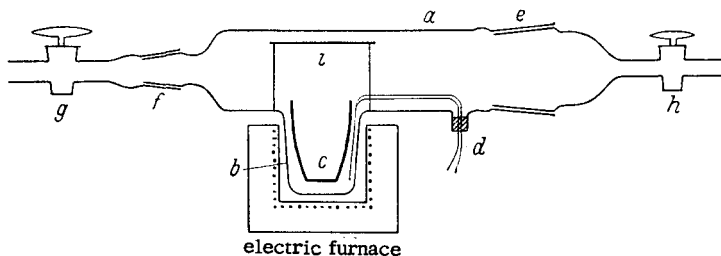

Fig. 329. Preparation of sodium rhenate (IV). *a* quartz tube; *b* crucible-shaped attachment; *c* gold crucible; *d* thermocouple; *l* movable gold shield (splash shield).

the attachment *b*; a stream of oxygen-free N_2 is passed from *h* to *g*. After thorough flushing with N_2 , 10 g. of very pure and dry NaOH is introduced (through *f*) into *c*. The apparatus is then heated to $500^\circ C$ and 4 g. of dry ReO_2 added by shaking to the melt. The ReO_2 dissolves, the melt turns reddish-brown, and water vapor escapes through *f*. After the reaction is completed, the heater is removed and attachment *b* cooled with ice water; this spalls the solidified melt off the crucible walls. The fused material contains (clearly separated) an upper layer of NaOH and a lower stratum of the brown rhenate. The fused cake is gently crushed, leached with deaerated ice water, decanted, filtered in the absence of air, washed with alcohol and dried, again in the absence of air. The filtering and drying device shown in Fig. 52, p. 74, is handy in this operation.

Alternate method: Fusion of ReO_3 with NaOH [W. Geilmann, F. W. Wrigge and W. Biltz, Z. anorg. allg. Chem. 214, 233 (1933)].

SYNONYM:

Sodium rhenite.

PROPERTIES:

Brown powder. On heating in air, converts to the yellow per-rhenate. Insoluble in H_2O and in bases; soluble in conc. hydrochloric acid, converting to the green H_2ReCl_6 .

REFERENCE:

I. and W. Noddack, Z. anorg. allg. Chem. 215, 134 (1933).

Ammonium Perrhenate

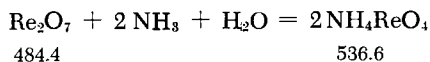

A solution of Re_2O_7 in some water is prepared, excess ammonia is added and the solution evaporated in a platinum crucible placed on a water bath.

Alternate method: Rhenium sulfides, oxides or rhenium metal are dissolved in HNO_3 . The solution is evaporated and diluted with ammonia. Recrystallization is required! May be used to prepare pure rhenium (see p. 1476).

PROPERTIES:

Thick, white, hexagonal crystals. Dissociates in air above 200°C to form NH_3 , H_2O and Re_2O_7 . Solubility: 2.9 (0°C); 6.2 (20°C); 32 (80°C) g. of salt/100 g. H_2O ; d 3.63. Crystal structure: HO_4 type.

REFERENCE:

I. and W. Noddack. Z. anorg. allg. Chem. 181, 23 (1929).

Barium Perrhenate

An aqueous solution of Re_2O_7 (= HReO_4) is neutralized exactly with baryta water, using neutral red as the indicator. The residue is dried, and the water-containing salt is converted to anhydrous $\text{Ba}(\text{ReO}_4)_2$ in vacuum or by heating to 120°C.

PROPERTIES:

Formula weight 637.80. Colorless columns or rhomboids. Solubility: 1.8 (0°C); 5.3 (20°C); 47 (70°C) g. of salt/100 g. H_2O . Solubility in alcohol: 2.4 g/liter of solution at 18.5°C.

REFERENCES:

I. and W. Noddack. Z. anorg. allg. Chem. 181, 25 (1929); W. Lewino. Thesis, Univ. of Hamburg, 1932.

Barium Rhenate (VI)

Prepared by reducing $\text{Ba}(\text{ReO}_4)_2$ with ReO_2 and NaOH in a melt.

The apparatus is the same as that used in the preparation of Na_2ReO_3 (Fig. 329). Sodium hydroxide (20 g.) is fused in crucible *c* under a stream of N_2 ; then, 8.00 g. of $\text{Ba}(\text{ReO}_4)_2$ is added, followed by 2.00 g. of ReO_2 . The melt is heated to 500°C and held at that temperature for one hour. It is then cooled to 300°C and held at that temperature for one hour. The heater is then removed and attachment *b* cooled with ice water. The melt cake is broken up and treated with 96% alcohol at 0°C; this loosens the NaOH and NaReO_4 in the melt; the former reacts with any unconverted $\text{Ba}(\text{ReO}_4)_2$ to form NaReO_4 and $\text{Ba}(\text{OH})_2$; the latter remains in the

residue. The product is filtered, using the device shown in Fig. 52, p. 74, and washed with some alcohol. It contains some NaOH and Ba(OH)₂.

ANALYSIS:

The compound is disproportionated in acetic acid. The leached-out Re (VII) fraction is filtered off and precipitated with nitron; the Re (IV) fraction is oxidized to Re (VII) and also precipitated with nitron.

PROPERTIES:

Formula weight 387.58. Foliage-green powder; readily dissociated. Slowly turns black in vacuum and white in air (formation of ReO₄⁻). Instantaneously dissociated by water, acids and bases. The presence of a slight amount of free NaOH is required for stability.

REFERENCE:

I. and W. Noddack. Z. anorg. allg. Chem. 215, 143 (1933).

Rhenium (IV) Sulfide



I.	Re + 2S = ReS ₂
	186.2 64.1 250.3

Rhenium and sulfur are mixed in stoichiometric proportions and heated for 18 hours in an evacuated, sealed small quartz tube at 980-1000°C.

II. Hydrogen sulfide is used to precipitate Re₂S₇ from a hydrochloric acid solution; the precipitate is filtered off with suction and washed with water and briefly with acetone. It is dried in a quartz or hard glass tube sealed at one end. It is then heated in high vacuum to 600°C until no further S sublimes out. The result is ReS₂ only slightly contaminated with sulfur.

Alternate method: Heating of Re in a stream of H₂S to red heat [H. V. A. Briscoe, P. C. Robinson and E. M. Stoddart, J. Chem. Soc. (London) 1931, 1441].

PROPERTIES:

Black solid (platelets are seldom recognizable); somewhat volatile at 1000°C. Strongly attacks quartz at 1000°C. No appreciable solubility in bases, alkaline sulfides, hydrochloric and sulfuric

acids. Converted by oxidizing agents to HReO_4 . d_4^{20} 7.506; heat of formation: -70.5 kcal. Crystal structure: C7 type.

REFERENCES:

- I. R. Juza and W. Biltz. *Z. Elektrochem.* 37, 499 (1931).
- II. W. Geilmann and G. Lange. *Z. analyt. Chem.* 126, 321 (1953).

Rhenium (VII) Sulfide

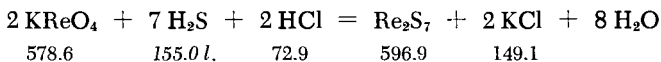

A solution of KReO_4 , containing 30 ml. of hydrochloric acid per 100 ml. of solution, is saturated for four hours with H_2S . The precipitated sulfide is washed with H_2S -saturated, 3% HCl water. The product is filtered in the absence of air, washed and then dried, first in a high vacuum for two hours at 140°C and then in high vacuum over freshly prepared P_2O_5 (60 hours at 165 - 170°C).

Alternate method: Precipitation with compressed H_2S from a solution of KReO_4 in hydrochloric acid; there is no need for the high HCl concentration in this case. The workup is similar to that described above [W. Geilmann, *Z. analyt. Chem.* 126, 321 (1943)].

PROPERTIES:

Black, readily oxidized powder. Dissociation to ReS_2 and S begins at 250°C . Insoluble in hydrochloric and sulfuric acids in the absence of air; oxidized by nitric acid or H_2O_2 plus a base to HReO_4 . d_4^{25} 4.866.

REFERENCE:

- W. Biltz and F. Weibke. *Z. anorg. allg. Chem.* 203, 4 (1931).

Barium Mesoperrhenate



Prepared by fusion of $\text{Ba}(\text{ReO}_4)_2$ with NaOH. The apparatus is the same as used in the preparation of Na_2ReO_3 (Fig. 329).

Crucible *c* is used to fuse 3 g. of $\text{Ba}(\text{ReO}_4)_2$ with 5 g. of carbonate-free NaOH under a stream of CO_2 -free air. The hot melt is red and cloudy. After cooling, it is crushed, leached with 90% alcohol to remove the excess NaOH and the NaReO_4 formed in the process, then filtered, again washed with alcohol and dried with suction.

ANALYSIS:

The salt is decomposed with CO_2 -free water; the Ba is precipitated as BaSO_4 and the ReO_4^- as nitron hydrogen perrhenate.

PROPERTIES:

Formula weight 944.52. Small, lemon-yellow hexagonal tablets and columns. Turns red upon heating to 800°C , returns to yellow on cooling. Stable in dry air. The wet salt is decomposed by CO_2 into BaCO_3 and $\text{Ba}(\text{ReO}_4)_2$.

REFERENCE:

I. and W. Noddack. Z. anorg. Chem. 215, 146 (1933).

Workup of Rhenium Residues

Precipitates of nitron hydrogen perrhenate from analyses of rhenium are collected and stored separately from rhenium solutions.

Workup of nitron precipitates: The material is carefully decomposed in a stream of H_2 , the products washed and oxidized to Re_2O_7 , and the latter dissolved in H_2O and concentrated in the presence of KOH or ammonia. The KReO_4 or NH_4ReO_4 obtained in this manner can be used without further purification.

Workup of various solutions: To avoid unnecessary contamination of the air with Re, the solution is neutralized and concentrated (if necessary, by boiling). It is then cooled and acidified with hydrochloric acid and the Re precipitated under pressure as Re_2S_7 . The Re_2S_7 is washed and dissolved in $\text{KOH} + \text{H}_2\text{O}_2$, and the KReO_4 is allowed to crystallize out. If the KReO_4 is still not sufficiently pure, it is reduced with H_2 and oxidized with O_2 to Re_2O_7 , and the latter is used to obtain Re or the perrhenate.

If traces of Mo must be removed, the procedure is as follows: the Re is precipitated with H_2S (under pressure) as Re_2S_7 , the precipitate is dissolved in $\text{KOH} + \text{H}_2\text{O}_2$, and the traces of Mo

are removed by extraction of the neutral solution with 8-hydroxyquinoline or chloroform. Following repeated precipitation under pressure as Re_2S_7 , the product is dissolved in $\text{KOH} + \text{H}_2\text{O}_2$ and crystallized as KReO_4 . The KReO_4 is recrystallized from hot water.

Iron

H. LUX

Metallic Iron

ELECTROLYTIC IRON

The following conditions are suitable for the preparation of very pure electrolytic iron: each liter of electrolyte contains about 800 g. of very pure $\text{FeCl}_2 \cdot 4\text{H}_2\text{O}$ (Fe^{3+} content less than 0.05%; sulfate-free) and 1.5-2.0 g. of $\text{AlCl}_3 \cdot 6\text{H}_2\text{O}$ or 0.1 g. of $\text{CrCl}_3 \cdot 6\text{H}_2\text{O}$. The concentration of free HCl is 0.01-0.02 N, and the temperature is 90°C or higher. The anode is made of the purest iron possible, and is wrapped in an asbestos bag. A sheet of vanadium steel serves as the cathode. The nature of cathode pretreatment is important if the deposit of electrolytic iron is to be easily stripped off. The steel sheet is first polished to a high luster, degreased by being used as a cathode in an alkaline KCN bath, rinsed with water, and after being connected to the electrical circuit, placed in a FeCl_2 bath. The cathodic density is 0.65-1.0 amp./in.²; if the operation is of long duration or proceeds at still higher current densities (up to 2 amp./in.²), the electrolyte must be continuously taken out of the bath, filtered, retreated, the HCl content adjusted to the one indicated above, and recycled to the bath.

The relatively soft α -iron deposited contains H_2 but no Al or Cr. The H_2 may be completely removed by baking in vacuum at 950°C. Electrolytic iron is free of C or Si, and of other metals if the electrolyte itself is pure.

PROPERTIES:

M. p. 1535°C, b. p. 2730°C; d 7.86. Crystal structure of α -Fe: A2 type.

REFERENCES:

G. A. Moore. *J. Metals* 5, 1443 (1953); F. Müller. *Z. Elektrochem.* 47, 135 (1941); F. Halla. *Korrosion und Metallschutz* 15, 380 (1939).

REDUCED IRON

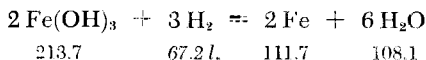

It is best to start from very pure Fe(OH)_3 ; this is prepared by adding a $\text{Fe(NO}_3)_3$ solution to aqueous NH_3 and drying the precipitate at 65°C . The product, finely ground, is placed in an aluminum or Pt boat (with Pt foil insert) and reduced in a stream of H_2 as the temperature is slowly raised. If the reduction temperature is lower than 550°C , the iron product is pyrophoric. As a rule, the temperature is raised slowly from 400 to 700°C (with 20 g. of Fe_2O_3 , this requires about 40 min.) and then held constant (about 20 min.) until further H_2O is produced. If less reactive starting materials (e.g., Fe_2O_3 prepared from the nitrate) are used, it may be necessary to heat to higher temperatures (1050 - 1100°C) and for much longer times (60 hours or more) to insure complete reduction. The preparations are cooled in H_2 ; their hydrogen content is minimal.

REFERENCES:

- R. Fricke and L. Klenk. *Z. Elektrochem.* 41, 617 (1935); R. Fricke, O. Lohrmann and W. Wolf. *Z. phys. Chem. (B)* 37, 60 (1937); P. M. Savelevich. *Trudy Inst. Chist. Khim. Reaktivov*, No. 15, 51 (1937); abstract in *Chem. Zentr.* 1939, I, 4583; G. P. Baxter and C. R. Hoover. *Z. anorg. allg. Chem.* 80, 211 (1913).

VERY PURE IRON:

- O. Hönigschmid, L. Birckenbach and R. Zeiss. *Ber. dtsh. chem. Ges.* 56, 1473 (1923); T. W. Richards and G. P. Baxter. *Z. anorg. Chem.* 23, 247 (1900); also A. Gatterer. *Commentationes Pontific. Acad. Sci.* 1, 77 (1937); abstract in *Chem. Zentr.* 1938, I, 1745; A. Gatterer and J. Junkes. *Specola astronom. Vaticana Comun.* No. 6 (1938); abstract in *Chem. Zentr.* 1938, II, 2243; J. Talbot, P. Albert, M. Caron and G. Chaudron. *Rev. Met.* 50, 817 (1953).

Iron (III) Chloride

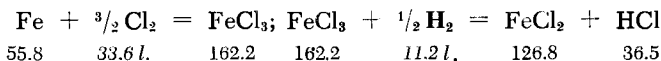

The starting anhydrous FeCl_3 is prepared from Fe and Cl_2 . The Cl_2 is then displaced by means of a stream of very dry N_2 , and

completely dry, pure H_2 is immediately introduced. The reduction proceeds rapidly at 300-350°C. It is advisable to spread the solid in a tube placed in a long electric furnace and to heat slowly, section by section, in the H_2 stream. Partly unconverted $FeCl_3$ sublimes in the H_2 below 300°C, while above 350°C the $FeCl_3$ tends to be reduced too far (to Fe).

The preparation of $FeCl_2$ from Fe and HCl is less satisfactory because of the higher temperatures required.

SYNONYMS:

Ferrous chloride, iron dichloride.

PROPERTIES:

White hygroscopic powder; can be resublimed in a stream of HCl at about 700°C. M. p. 674°C, b. p. 1023°C; $d(25^\circ)$ 3.162. Vapor pressure at 700°C: 12 mm. Readily soluble in water and alcohol. Crystal structure: C 19 type.

REFERENCES:

H. Wolfram. Thesis, Techn. Hochschule Dresden, 1913; W. Kangro and E. Petersen. Z. anorg. allg. Chem. 261, 157 (1950).

Iron (III) Chloride

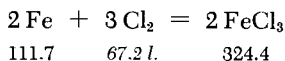

A stream of Cl_2 is very thoroughly dried over conc. H_2SO_4 and P_2O_5 , and is then liquefied by passage through a U tube cooled with Dry Ice-acetone mixture to about -40°C. The bath temperature is then raised to -34.1°C; pure Cl_2 volatilizes out. It passes into a very dry Pyrex tube containing the purest possible iron wire (about 0.2 mm. in diameter). The reaction takes place at 250-400°C; an excess of Cl_2 should always be present and should always bubble out from the H_2SO_4 -containing safety valve which terminates the reactor train. To avoid plugging the tube, the electric furnace (or the aluminum heating block) is occasionally shifted, so that a fresh condensation zone may be created.

At the end of the reaction, the preparation should be resublimed in a stream of Cl_2 at about 220°C (the temperature should

not exceed 300°C). All of the Cl₂ is then displaced from the apparatus with very dry N₂ (or air), and the product is transferred (under N₂) to storage vessels, which are then tightly sealed.

SYNONYMS:

Ferric chloride; iron trichloride.

PROPERTIES:

Formula weight 162.2. Leaflets with a somewhat greenish metallic luster. Extremely hygroscopic. M.p. (in Cl₂) 308°C, b.p. (calcd.) 316°C; d (25°) 2.898. Decomposes partially on sublimation in high vacuum. In the range of 160-210°C the decomposition pressure of Cl₂ over solid FeCl₃ and FeCl₂ obeys the equation: $\log P = 11.33 - 5.67 \cdot 10^3/T$. Very readily soluble in water, ethyl alcohol, ethyl ether and acetone. FeCl₃ and FeCl₂ form a eutectic, m.p. 297.5°C, containing 13.4 mole % of FeCl₂.

REFERENCES:

- G. G. Maier. Techn. Pap. Bur. Mines Washington No. 360, 40 (1925); O. Hönigschmid, L. Birckenbach and R. Zeiss. Ber. dtsh. chem. Ges. 56, 1476 (1923); H. Schäfer. Angew. Chem. 64, 111 (1952); for the preparation of larger amounts, see B. R. Tarr in: L. F. Audrieth, Inorg. Syntheses, Vol. III, New York, 1950, p. 191.

Iron (II) Bromide



FeBr₂, ANHYDROUS

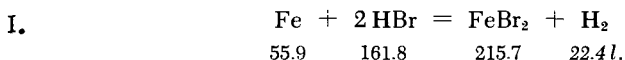

Very pure Fe (reduced with H₂) is placed in an unglazed porcelain boat situated in a porcelain tube and heated to about 800°C in a completely dry stream of HBr-saturated nitrogen, so that the nascent FeBr₂ distills out at once. The preparation is transferred (in dry N₂) to well-sealed vessels. This last operation is facilitated by attaching a snugly fitting tube onto the exit end of the reactor; the FeBr₂ can then sublime into this second tube.

II. Careful dehydration of $\text{FeBr}_2 \cdot 4\text{H}_2\text{O}$ in a stream of N_2 and HBr .

SYNONYM:

Ferrous bromide.

PROPERTIES:

Light-yellow to dark-brown crystals; hygroscopic. M. p. 684° ; $d(25^\circ)$ 4.624. Crystal structure; C 6 type.

REFERENCES:

- I. G. P. Baxter. Z. anorg. Chem. 38, 236 (1904).
- II. G. P. Baxter, Th. Thorvaldson and V. Gobb. Z. anorg. Chem. 70, 333 (1911).

FeBr_2 , HYDRATE

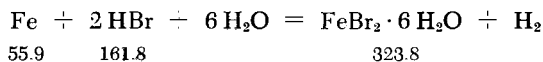

To prepare the hexahydrate, pure iron is dissolved in aqueous HBr and the solution evaporated below 49°C . Above this temperature one can obtain the tetrahydrate, and above 83°C the dihydrate.

Alternate method: Shaking Br_2 and water with an excess of iron powder.

PROPERTIES:

Pale-green rhombic tablets; not deliquescent.

REFERENCE:

F. Schimmel. Ber. dtsch. chem. Ges. 62, 963 (1929).

Iron (III) Bromide

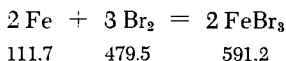

A Pyrex tube, sealed at the left end and provided with a 45° bend in the middle, is connected at the right to a high-vacuum pump and a supply of Br_2 . Reduced iron powder is introduced into the left leg with the aid of a long-stem funnel, and the right end of the tube is then drawn out to a capillary. The Fe is thoroughly degassed by evacuation and heating. Bromine is then condensed on

the iron (liquid nitrogen bath); the Br_2 excess is such that after completion of the reaction the pressure in the tube will still be at least 5 atm.

After the pump end of the reactor tube is sealed off, the Br_2 is condensed in the right leg by cooling the latter in ice water. The left leg is then heated to 175–200°C (maximum) and then the right leg to 120°C; this produces a Br_2 pressure of about 5 atm. The heating is done with two mating aluminum heating blocks. The butting ends are cut at an angle of 22.5° and separated only by a thin disk of asbestos (Fig. 330).

The reaction begins, although slowly, even at room temperature, but cannot be completed at this temperature even in several months. However, under the conditions given above, pure FeBr_3 condenses outside the 200°C zone. If the temperature of the Fe is too high or the Br_2 pressure too low, some yellow FeBr_2 is also deposited at the left end of the tube.

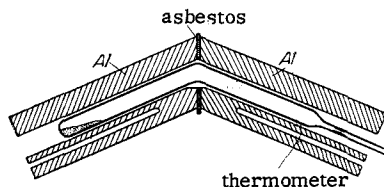

Fig. 330. Preparation of iron (III) bromide.

SYNONYM:

Ferric bromide.

PROPERTIES:

Lustrous black plates; very hygroscopic. The decomposition pressure of Br_2 at 90°C is 55 mm. and at 139°C is 760 mm.; below 139°C, it obeys the equation: $\log p \text{ (mm.)} = -3478.6/T + 11.327$. The vapor pressure of FeBr_3 becomes detectable above 139°C. Crystal structure: $D0_6$ type (same as FeCl_3).

REFERENCES:

- N. W. Gregory and B. A. Thackrey. *J. Amer. Chem. Soc.* **72**, 3176 (1950); N. W. Gregory. *Ibid.* **73**, 472 (1951).

Iron (II) Iodide



A high-melting glass tube is sealed at one end and provided with a side arm terminating in a break-seal capillary d (see Fig. 331). Very pure iron wire is placed at location *a* of the tube, and a small plug of freshly ignited asbestos wool *b* is inserted close

to the iron. Pure, dry I_2 (less than stoichiometric quantity), in the form of a coarse powder, is then placed on top of the asbestos wool plug. The reactor tube is then drawn out to smaller size at a , the I_2 is moved forward to c , and a good vacuum is applied by means of a mercury diffusion pump. At the same time, the other sections of the tube (a, b) are heated in an electric furnace to $500^\circ C$ to degas the Fe and the asbestos. The tube is then sealed off at f , and section c containing the I_2 is heated to $180^\circ C$ with a suitable Al block or in an air bath (the section containing the Fe is maintained at $500^\circ C$). The tube is slightly inclined forward to prevent the liquid iodine from flowing into the hot section. If the above temperatures are adhered to, the internal pressure does not exceed one atmosphere.

The nascent FeI_2 sublimes slowly toward the cooler zone, where it deposits as black leaflets which appear brownish red when viewed by transmitted light. As soon as the iodine vapor disappears completely, the tube is allowed to cool and a vacuum hose is carefully slipped over side arm d . The hose is connected via a three-way stopcock to a canned-rotor pump and a nitrogen supply. Vacuum is applied, the sealed capillary on the side arm is broken off, and pure, dry N_2 is slowly admitted. Care should be taken during this step to avoid entraining any glass fragments in the tube. As soon as a slight gage pressure is established, the reactor tube is broken off at e and the product is transferred in nitrogen to a storage vessel.

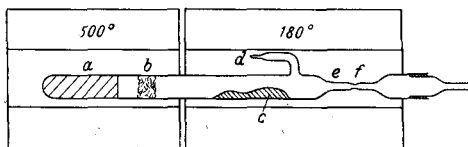

Fig. 331. Preparation of iron (II) iodide. a iron wire; b asbestos wool; c iodine; f seal location (after sealing, the section to the right of f is removed).

Alternate methods: II. Heating reduced Fe in a stream of I_2 -saturated hydrogen, followed by distillation in a steel tube.

III. Thermal decomposition of $Fe(CO)_4I_2$. The product is an extremely fine powder.

SYNONYM:

Ferrous iodide.

PROPERTIES:

M. p. 587° . Hygroscopic; becomes whitish in air. Aqueous solutions are colorless. Crystal structure: C 6 type.

REFERENCES:

- I. M. Guichard. *Comptes Rendus Hebd. Séances Acad. Sci.* **145**, 807 (1907).
- II. C. L. Jackson and I. H. Derby. *Amer. Chem. J.* **24**, 16 (1900); *Bull. Soc. Chim. France* [3] **24**, 863 (1900); see also W. Fischer and R. Gewehr. *Z. anorg. allg. Chem.* **222**, 303 (1935).
- III. W. Hieber and H. Lagally. *Ibid.* **245**, 300, 313 (1940).

Iron (II) Oxide

FeO

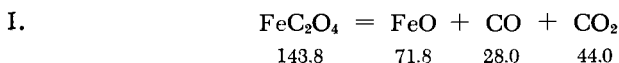

Thermal decomposition of FeC_2O_4 yields pure FeO only under specific conditions. The decomposition is carried out in a quartz vessel (Fig. 332) whose lower section is kept at 850°C by means of an electric furnace. The joint is surrounded by a water-cooled lead coil or a rubber hose. The nascent gases should be removed as quickly as possible; for this reason, the reactor is connected to two parallel mercury pumps and a good forepump; the gas is carried into two liquid-nitrogen-cooled traps containing activated charcoal.

The starting FeC_2O_4 (0.5-0.8 g.) is placed in the small bulb above the quartz vessel, and the water of crystallization is completely vaporized by heating in vacuum for 12 hours at 200°C . The bulb is turned in the joint, and the FeC_2O_4 drops into the heated lower section of the reactor where it is rapidly decomposed to FeO, CO and CO_2 (the decomposition is complete in about 20 seconds). The product FeO is retained by a quartz wool plug, which must be loose enough to prevent a buildup of pressure during the decomposition.

The furnace is now removed and the hot quartz tube is chilled as rapidly as possible in cold water, since FeO is unstable in the range of 300 - 560°C and decomposes according to:



(this decomposition proceeds most rapidly at about 480°C , but ceases below 300°C). The above procedure yields a jet-black

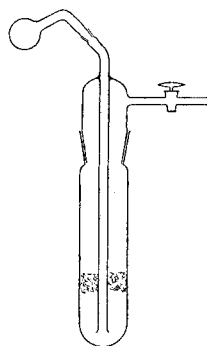

Fig. 332. Preparation of iron (II) oxide.

product, readily soluble in dilute acids; it is rapidly oxidized in air, but does not ignite.

II. The preparation from stoichiometric quantities of commercial Fe_2O_3 and reduced iron can also be recommended. The mixture and a few drops of water are sealed into a preevacuated quartz tube, heated for about three days at 900°C , and quenched in cold water.

SYNONYM:

Ferrous oxide.

PROPERTIES:

M.p. 1360° ; d 5.7. Crystal structure: B1 (rock salt) type.

REFERENCES:

- I. P. L. Günther and H. Rehaag. *Z. anorg. allg. Chem.* 243, 60 (1939).
- II. R. W. Blue and H. H. Claassen. *J. Amer. Chem. Soc.* 71, 3839 (1949); J. P. Coughlin, E. G. King and K. R. Bonnickson. *Ibid.* 73, 3891 (1951); see also L. Wöhler and R. Günther. *Z. Elektrochem.* 29, 281 (1923).

Iron (III) Hydroxide

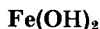

The preparation of pure $\text{Fe}(\text{OH})_2$ has been described in detail by Rihl and Fricke as an example of operation under an inert atmosphere. The general experimental arrangement is further described in Part I, p. 72 ff. It consists essentially of a bulb, one side of which can be connected to a high-vacuum pump as well as a source of N_2 or a drying vessel, while the other side is attached to devices for filtration, washing and transfer of products. All operations must be carried out with the most rigorous exclusion of O_2 in an atmosphere of pure, dry N_2 .

The apparatus is first evacuated (high vacuum); then a continuous stream of N_2 is introduced. A centrifuged solution of $\text{Fe}(\text{OH})_2$ (prepared from very pure FeCl_2) in conc. aqueous NH_3 is admitted through the filter and diluted with a large quantity of water, causing precipitation of the $\text{Fe}(\text{OH})_2$. To obtain a denser precipitate (which settles more rapidly), the mixture is heated for about three hours at 80°C and allowed to settle. The mother liquor is filtered off, and the precipitate is washed 10 to 12 times in similar fashion until a positive test for chloride is no longer obtained.

To remove the remaining water, the residue is solidified by immersion of the flask in an ice-salt mixture, full vacuum is applied, and the water is distilled off overnight as the solid slowly melts. The water is condensed in a large trap chilled in Dry Ice-acetone. Complete drying of the product is achieved by keeping it for several additional hours under high vacuum together with a vessel containing P_2O_5 .

PROPERTIES:

Nearly white, slight greenish tinge. When sprayed into air, burns with sparks. Crystal structure: C 6 type.

REFERENCE:

S. Rihl and R. Fricke. Z. anorg. allg. Chem, 251, 406 (1943).

Iron (II, III) Oxide

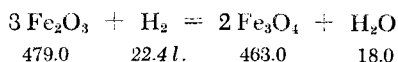

Fine Fe_2O_3 powder is heated to $400^\circ C$ in a large boat placed in a stream of N_2 ; then the N_2 is replaced with H_2 saturated with water vapor at $50^\circ C$. The connecting tubing between the saturating vessel and the reactor tube must be as short as possible and well insulated against thermal losses. When the reduction is complete, as shown by the disappearance of all of the red Fe_2O_3 , the product is cooled in a stream of N_2 . Conversion of 10 g. of Fe_2O_3 requires about five hours.

PROPERTIES:

Black, ferromagnetic powder. M.p. 1590° ; d 5.11. Mohs hardness 6. Crystal structure: H11 type.

REFERENCE:

S. Hilpert and J. Beyer. Ber. dtsh. chem. Ges. 44, 1608 (1911).

Iron (III) Hydroxide



α - $FeO(OH)$

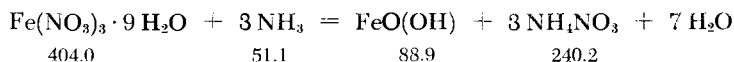

A cold solution of 810 g. of $Fe(NO_3)_3 \cdot 9 H_2O$ in two liters of water is poured slowly, with vigorous stirring, into an ammonia

solution prepared by dissolving 120 g. of gaseous NH_3 in two liters of water (cooling necessary). The hydroxide which precipitates is amorphous to x-ray analysis. It is washed by stirring at least five times with eight-liter portions of cold water, each portion being decanted as completely as possible. The residual slurry is then stirred with sufficient conc. KOH solution to give a mixture approximately 2N and allowed to stand for 3-4 hours. Finally 100°C steam is bubbled through for two hours. The precipitate is thereby transformed completely into bright-yellow $\alpha\text{-FeO(OH)}$, which shows a crystalline x-ray diffraction pattern.

Since removal of the potassium hydroxide by washing is difficult, it is converted to KCl by treatment with somewhat more than the calculated amount of NH_4Cl . The precipitate is then washed thoroughly with hot water until no further Cl^- can be detected. The K content is then usually below 0.04%. Drying in a vacuum desiccator affords a product whose water content still exceeds the theoretical (10.14%) by about 2%. Heating in vacuum or in a stream of dry air yields pure $\alpha\text{-Fe}_2\text{O}_3$.

The naturally occurring form of $\alpha\text{-FeO(OH)}$, 'needle iron ore' or goethite, has an E0_2 type structure.

REFERENCES:

- R. Fricke and P. Ackermann. *Z. Elektrochem.* **40**, 630 (1934); O. Glemser. *Ber. dtsh. chem. Ges.* **70**, 2117 (1937); R. Fricke and G. F. Hüttig. *Hydroxyde und Oxyhydrate [Hydroxides and Hydrated Oxides]*, Leipzig, 1937, p. 316; W. Hoppe. *Z. Kristallogr. (A)* **103**, 73 (1940).

$\gamma\text{-FeO(OH)}$

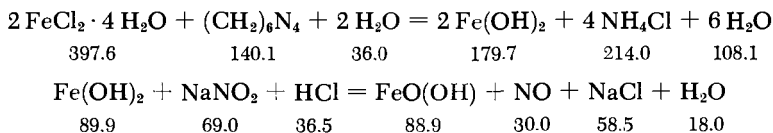

A solution of 120 g. of $\text{FeCl}_2 \cdot 4\text{H}_2\text{O}$ in three liters of water is filtered, and the filtrate is added to a filtered solution of 168 g. of hexamethylenetetramine (Urotropin) in 600 ml. of water. Blue-green Fe(OH)_2 is precipitated. Then a solution of 42 g. of NaNO_2 in 600 ml. of water is added with constant stirring; the mixture is heated to about 60°C and allowed to stand three hours (not longer) with occasional agitation. The oxidation, which produces $\gamma\text{-FeO(OH)}$, proceeds with the evolution of considerable quantities of nitrogen oxides. The supernatant liquid is drained off; the precipitate is washed thoroughly with warm water until free of chloride and dried at 60°C in a drying oven.

PROPERTIES:

Very friable deep-orange powder comprised of extremely fine needles. Can be converted to pure γ - Fe_2O_3 by heating in vacuum or in a dry air stream at about 250-400°C. On heating at higher temperatures, or in a sealed tube at 110°C, or even on very intensive grinding, the metastable preparations of the γ series are converted to the stable α modification.

Occurs in nature as lepidocrocite. Crystal structure: E0_4 type. For metastable β - $\text{FeO}(\text{OH})$, see O. Kratky and H. Nowotny, Z. Kristallogr. (A) 100, 356 (1938).

REFERENCES:

- O. Glemser. Ber. dtsh. chem. Ges. 71, 158 (1938); R. Fricke and W. Zerrweck. Z. Elektrochem. 43, 52 (1937); R. Fricke and G. Weitbrecht. Z. anorg. allg. Chem. 251, 427 (1943); F. Wagenknecht. Kolloid-Z. 112, 35 (1949).

Iron (III) Oxychloride

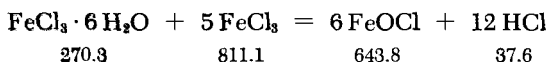

A mixture of 10 g. of $\text{FeCl}_3 \cdot 6\text{H}_2\text{O}$ and 35 g. of sublimed FeCl_3 is placed in a round, short-neck Pyrex reaction flask, fused on a steam bath, and allowed to solidify; then 15 additional g. of FeCl_3 is added. The reaction indicated above takes place when the mass is heated to 250-300°C (maximum). It is best to immerse the open flask rather deeply in an oil bath held at 250°C, so that no moisture condenses at the neck. The reaction is complete after 60-80 minutes, when no further evolution of HCl is observed.

The reaction mass, which converts to a solid red cake, is cooled and pulverized, washed briefly with a large amount of cold water and then with acetone (to remove excess FeCl_3), and dried in vacuum.

PROPERTIES:

Rust-colored powder consisting of small red needles. Free of Fe_2O_3 if made from sublimed FeCl_3 and if reaction temperatures no higher than 300°C are used. Disproportionates above 300°C into the oxide and chloride. Crystal structure: E0_5 type.

REFERENCE:

- H. Schäfer. Z. anorg. Chem. 260, 279 (1949).

Iron (II) Sulfide

FeS

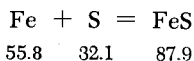

Pure FeS of stoichiometric composition is obtained from pure reduced Fe and distilled S. Exactly weighed quantities of the two substances are sealed in a quartz tube evacuated in high vacuum, and are heated for about 24 hours at 1000°C; at higher temperatures, the quartz tube bursts. One then tests for completeness of the conversion: the reaction is complete if S no longer collects at that end of the hot tube which is cooled for test purposes. The lustrous gray product obtained is somewhat sintered and readily pulverized.

SYNONYM:

Ferrous sulfide.

PROPERTIES:

M. p. 1195°; d 4.84. Crystal structure: B8 type.

REFERENCES:

H. Haraldsen, Z. anorg. allg. Chem. 231, 81 (1937); G. Hägg and J. Sucksdorff, Z. phys. Chem. (B) 22, 444 (1933).

Iron Nitrides

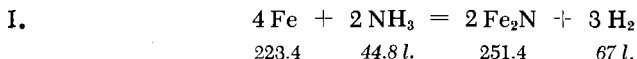
Fe₂N, Fe₄N

Fine Fe₂O₃ powder is placed in a porcelain boat at 500°C and reduced as completely as possible with H₂; then, without allowing any air to penetrate, NH₃ is introduced at 350-550°C until the H₂ content of the exit gas decreases to a low, constant level. The product is then allowed to cool in the stream of NH₃. It corresponds in composition to the formula Fe₂N (theoretically 11.1% N), has the structure of Hägg's ζ phase, and exhibits a very narrow region of homogeneity. Often, however, the same composition yields a mixed crystal (solid solution) phase ε. On heating in vacuum at about 500°C the product is converted (with loss of N₂) first to the solid solution ε and then to Fe₄N (γ' phase, theoretically 5.9% N).

II. Another method for preparing Fe_4N consists in heating reduced iron in the presence of an appropriate mixture of H_2 and NH_3 .

PROPERTIES:

Fe_2N : Formula weight 125.7; d 5.02.

Fe_4N : Formula weight 237.4; d 6.57 (?). Crystal structure: L 10 type.

REFERENCES:

- I. G. Hägg. Z. phys. Chem. (B) 8, 455 (1930); also E. Lehrer. Z. Elektrochem. 36, 388, 460 (1930); O. Eisenhut and E. Kaupp. Ibid. 36, 394 (1930); S. Satoh. Bull. Chem. Soc. Japan 7, 315 (1932); abstract in Chem. Zentr. 1933, I, 752.
- II. St. Brunauer, M. E. Jefferson, P. H. Emmett and S. B. Hendricks. J. Amer. Chem. Soc. 53, 1778 (1931); Ch. Guillaud and H. Creveaux. Comptes Rendus Hebd. Séances Acad. Sci. 222, 1170 (1946); H. W. Köhlschütter and M. Pavel. Z. anorg. allg. Chem. 255, 65, 73 (1947).

Iron Carbide



It is best to start with electrolytic iron sheet; this is held over benzene vapor to deposit a layer of carbon, then baked for a long time in vacuum at 700°C and slowly cooled. To isolate Fe_3C the sheet is placed in a neutral FeCl_2 bath and used as an anode at the lowest possible current density. The bath is the same as used in the preparation of electrolytic iron. In this way very pure Fe_3C is left behind as a coarsely crystalline gray powder. It is washed with dilute acetic acid, water, alcohol and ether, and dried in vacuum.

Alternate methods: a) Iron carbide may also be isolated quantitatively while measuring the anode potential; see E. Houdremont, P. Klinger and G. Blaschczyk, Techn. Mitt. Krupp, Forschungsber. 4, 311; Arch. Eisenhüttenw. 15, 257 (1941).

b) Solution of white, low-Si pig iron in 1N acetic acid; see O. Ruff and E. Gersten, Ber. dtsh. chem. Ges. 45, 64 (1912).

c) For the preparation of almost pure fused Fe_3C , see F. Wever, Mitt. KWI Eisenforschung 4, 67 (1923).

SYNONYM:

Cementite.

PROPERTIES:

Formula weight 179.52. Hardness 3.2-3.3; d (15°) 7.66. Crystal structure: D0_{11} type.

The decomposition of Fe_3C to Fe and C proceeds at a high rate only above 1050°C . Below 500°C a carbide having the formula Fe_2C may also be obtained in various modifications [L. J. E. Hofer, E. M. Cohn and W. C. Peebles, *J. Amer. Chem. Soc.* 71, 189 (1949); H. H. Podgurski, J. T. Kummer, T. W. de Witt and P. H. Emmett, *ibid.* 72, 5382 (1950)].

REFERENCE:

G. Naeser. *Mitt. KWI für Eisenforschung* 16, 211 (1934).

Lithium Ferrate (III)



Obtained by heating to high temperature or fusion of an intimate mixture of Li_2CO_3 with fine Fe_2O_3 powder derived from FeC_2O_4 . At temperatures above about 670°C , the stable modification is of the B1 type, with random distribution of the metal atoms; annealing at 570°C converts it to a nearly cubic tetragonal modification with ordered distribution.

Alternate method: Heating conc. LiOH solution with Fe_2O_3 at 600°C under pressure [E. Posniak and T. F. W. Barth, *Phys. Rev.* 38, 2234 (1931)].

REFERENCE:

F. Barblan, E. Brandenberger and P. Niggli. *Helv. Chim. Acta* 27, 88 (1944).

Potassium Ferrate (VI)

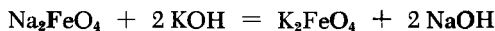
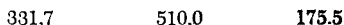
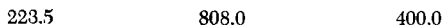
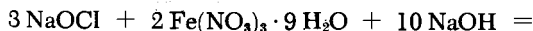
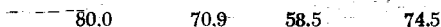
I. BY OXIDATION WITH NaOCl :

A solution of 30 g. of NaOH in 75 ml. of water is cooled, and Cl_2 is admitted with vigorous stirring until a weight increase of

20 g. is recorded. The cooling rate should be such that the mixture temperature does not rise above 20°C. Then 70 g. of solid NaOH is added slowly and with constant stirring; the temperature is allowed to rise to 25-30°C to speed the dissolution. As soon as this is complete, the solution is cooled once again to 20°C and passed through a glass filter to remove the precipitated NaCl.

With the NaOCl solution held at 25-30°C, 25 g. of solid $\text{Fe}(\text{NO}_3)_3 \cdot 9\text{H}_2\text{O}$ is slowly added (stirring), the mixture is saturated with solid NaOH at 30°C, and the ferrate (VI) solution is either filtered through a coarse glass filter or, better, centrifuged.

The precipitation of K_2FeO_4 is carried out in a 250-ml. beaker by addition of 100 ml. of saturated KOH while stirring and cooling to 20°C. After precipitation, stirring is continued for five minutes; the compound is collected on a medium-porosity glass filter and redissolved by treatment with four or five 10-ml. portions of 3M KOH. The solutions are combined in a 250-ml. beaker and 50 additional ml. of saturated KOH is added; after five minutes of stirring at 20°C the solution, which is now about 11 M in KOH, is filtered through a medium-porosity glass filter.

For further purification, the K_2FeO_4 collected on the filter is treated with 10 ml. of benzene, then three to five times with 20-ml. portions of 95% ethanol (aldehyde-free), and finally stirred for 20 min. (in a large beaker) with 1000 ml. of 95% ethanol. This last treatment is repeated three additional times. The product is collected on a glass filter, washed in the absence of atmospheric moisture with 50 ml. of ether, and dried in a vacuum desiccator.

The yield is 45-75% of theoretical, the purity 92-96%. One further reprecipitation from 6M KOH raises the purity to 98.5-99%.

II. ELECTROLYTIC METHOD:

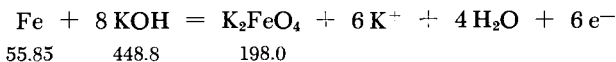

The electrolysis is conducted in a cylindrical vessel (95 mm. I. D. and 100 mm. high) in which a porous clay cell (50 mm. I. D. and 80 mm. high) is set. The cell is held in place by a paraffin-soaked cork ring in such a way that it touches the bottom of the cylinder. The anode is a strip of transformer iron sheet (0.3% Mn; 27×3.7 cm. = 100 cm.² of surface on each side) which adheres closely to the outer wall. The cathode consists of a screen of iron wire rolled into a cylinder and placed inside the cell. The anode is welded to a thick, acetylene-flame-cleaned iron wire, which passes through the cork ring and is sealed in

with piccin wax. The cork ring also carries a thermometer, a two-bulb pressure release tube containing 30% KOH, and a short tube (7 mm. I. D.) for removing samples.

Both cathode and anode are etched with 1:1 HCl shortly before the start of the experiment, and are then rinsed with water. The cylinder is now filled with 200 ml. and the cell with 60 ml. of freshly prepared 40% NaOH precooled to 25-28°C. The apparatus is assembled and cooled externally with ice water. To start with, the electrode intended as the anode is connected as the cathode and the electrolysis conducted for 3-5 min. at 3.5 amp. and 110 v. d.c. The resistance in the circuit should be about 30 ohms. The polarity is then reversed; the actual electrolysis takes four hours at 4.5 amp. (approximately 5.8 v.); the temperature in the anode space must never exceed 35°C.

The current is shut off and the anode electrolyte freed of traces of $\text{Fe}(\text{OH})_3$ by centrifuging or filtering rapidly through a medium-porosity glass filter. The filtrate is cooled to 10°C, and 75 g. of KOH pellets is added with continued cooling and vigorous shaking. An additional hour at 0°C is allowed for completion of the reaction. The K_2FeO_4 precipitate is rapidly collected on a medium-porosity glass funnel, washed at once with ice-cold absolute methanol, and dried in vacuum over P_2O_5 . The anode electrolyte, which after four hours is about 0.15 M in ferrate (VI), affords about 5 g. of K_2FeO_4 with a purity of 95%. The main impurity is carbonate; in addition there is 0.1% Mn, as well as compounds passing into the solution from the earthenware cell. These could probably be avoided by using a cell made of polytetrafluoroethylene or a similar material. The current efficiency is about 25%.

PROPERTIES:

Small lustrous crystals, very dark violet to black; stable only when completely dry. Readily soluble in water; concentrated solutions decompose rapidly; very dilute solutions are much more stable. Chloride ions and $\text{FeO}(\text{OH})$ markedly accelerate the decomposition. The instability of solutions as a function of pH is described by J. M. Schreyer and L. T. Ockerman, *Anal. Chem.* **23**, 1312 (1951).

REFERENCES:

1. G. W. Thompson, L. T. Ockerman and J. M. Schreyer. *J. Amer. Chem. Soc.* **73**, 1379 (1951); H. J. Hrostowski and A. B. Scott. *J. Chem. Phys.* **18**, 105 (1950); B. Helferich and K. Lang. *Z. anorg. Chem.* **263**, 171 (1950); R. Scholder, H. von Bunsen, F. Kindervater and W. Zeiss. *Z. anorg. allg. Chem.* **282**, 268 (1955); L. Moeser. *J. prakt. Chem.* [2] **56**, 431 (1897).

II. G. Grube and H. Gmelin. *Z. Elektrochem.* **26**, 160 (1920); modified directions based on unpublished experiments made together with H. Noeth.

Potassium Iron (III) Sulfide

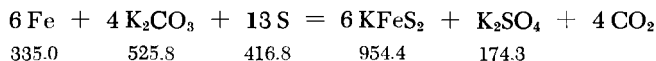

An intimate mixture of 5 g. of Fe powder (obtained by reduction with H_2), 25 g. of K_2CO_3 , 5 g. of Na_2CO_3 , and 30 g. of S is slowly heated in a half-filled covered porcelain crucible until the mass flows smoothly; it is then held at bright-red heat for about one hour. A better method consists in heating the mixture (which is placed in a boat inserted in a porcelain tube) under nitrogen at 900-1000°C. In either case the crucible is cooled slowly and broken. The fragments of the melt are soaked in warm water, the solution being frequently decanted, until the only substance remaining in the flask is the reddish violet needles of KFeS_2 (semimetallic luster). If a considerable quantity of colloidal, amorphous product is obtained, the reaction temperature was not sufficiently high. The crystals are washed with water and alcohol and dried as rapidly as possible at 100°C. The yield is 12-14 g.; the theoretical yield, based on Fe, is 14.25 g.

PROPERTIES:

Formula weight 159.1. Insoluble in water; indefinitely stable in dry air.

REFERENCES:

K. Preis. *J. prakt. Chem.* **107**, 12 (1869); R. Schneider. *Ibid.* **108**, 16 (1869).

Basic Iron (III) Sulfate

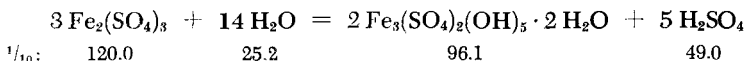
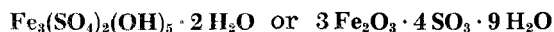

The basic sulfate, which is stable over a large temperature range (up to 170°C), is readily obtained in crystalline form by

heating a sealed tube containing an approximately 20% solution of $\text{Fe}_2(\text{SO}_4)_3$ at 150°C . The product is a fine, orange-yellow powder consisting of small, transparent, cubelike rhombohedra.

REFERENCES:

- E. Posniak and H. E. Merwin. *J. Amer. Chem. Soc.* **44**, 1965 (1922);
 N. V. Shishkin. *Zh. Obshch. Khim.* **21**, 456 (1951); Athanasesco.
Comptes Rendus Hebd. Séances Acad. Sci. **103**, 271 (1886).

Basic Iron (III) Acetate

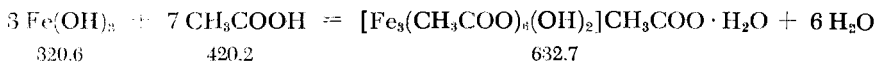

The monoacetate of the complex base, which occurs predominantly in the monoacidic form, crystallizes readily from dilute acetic acid (about 10% or 1.6 N). The triacetate is formed only from solutions containing at least 65% acetic acid by weight (11.4 N); these are allowed to stand in a vacuum desiccator over conc. H_2SO_4 .

To prepare the monoacetate, a very dilute FeCl_3 solution is treated at room temperature with aqueous NH_3 ; the precipitate is washed for several days with cold water, which is frequently decanted, and washed thoroughly again on a filter. The slurry of hydrated iron oxide thus obtained is dissolved (heating) in about an equal amount of acetic acid. Crystallization takes place if the solution is allowed to stand in an open dish for several days in a well-ventilated spot. After filtration, the salt is kept for some time over soda lime to absorb the acetic acid.

SYNONYM:

Triiron (III) hexaacetatodihydroxomonoacetate.

PROPERTIES:

Transparent, brick-red rhombic leaflets. Dissolves slowly in cold water, rapidly in hot water. Only sparingly soluble in acetic acid.

REFERENCES:

- A. Krause. *Z. anorg. allg. Chem.* **169**, 286 (1928); R. Weinland and E. Gussmann. *Ber. dtsh. chem. Ges.* **42**, 3888 (1909); *Z. anorg. Chem.* **66**, 157 (1910).

Hexacyanoferric (II) Acid

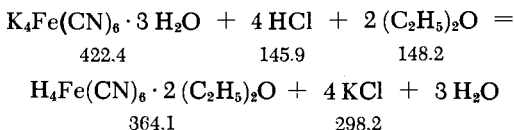
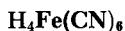

A solution of 42 g. of $\text{K}_4\text{Fe}(\text{CN})_6 \cdot 3 \text{H}_2\text{O}$ in 350 ml. of water is mixed with 100 ml. of conc. HCl (d 1.19); any KCl which separates is redissolved by addition of some water. After thorough chilling, about 50 ml. of ether is added. The etherate separates in several hours as colorless tablets. These are filtered off, washed with a small quantity of dilute HCl containing some ether, and redissolved in 50 g. of alcohol. After residual undissolved KCl is removed by filtration, the compound is reprecipitated by addition of 50 g. of ether, filtered off, and washed with ether. It is finally transferred to a round flask and converted to $\text{H}_4\text{Fe}(\text{CN})_6$ by heating at 40-50°C in aspirator vacuum.

SYNONYMS:

Hydrogen hexacyanoferrate (II), ferrocyanic acid.

PROPERTIES:

Snow-white when pure. d (25°) 1.536. Indefinitely stable if dry; gradually becomes blue in moist air. Elimination of HCN begins at about 100°. Readily soluble in water or alcohol; insoluble in ether or acetone. The bright lemon-yellow aqueous solution decomposes on heating or in light. Solubility (14°) 13 g./100 g. of aqueous solution.

REFERENCES:

W. Biltz. Z. anorg. allg. Chem. 170, 161 (1928); A. Mittasch and E. Kuss. Z. Elektrochem. 34, 159 (1928).

Ammonium Hexacyanoferrate (II)

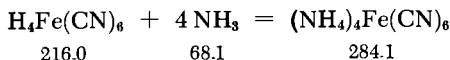

To prepare a completely potassium-free salt, a conc. aqueous solution of pure hexacyanoferric (II) acid is neutralized with pure

10% aqueous NH_3 ; the salt which precipitates is collected, washed several times with alcohol and then with ether.

PROPERTIES:

Readily soluble in water, insoluble in alcohol. In vacuum, decomposition begins above 100°C .

REFERENCE:

A. Mittasch and E. Kuss. *Z. Elektrochem.* **34**, 59 (1928).

Hexacyanoferric (III) Acid

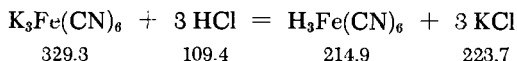
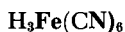

Cold saturated $\text{K}_3\text{Fe}(\text{CN})_6$ solution (40 ml.) is treated slowly and in the cold with 40 ml. of fuming HCl ; the mixture is allowed to stand in an ice bath with frequent agitation for about half an hour. The KCl precipitate is removed by filtration and the filtrate is shaken with 70 ml. of ether. Three layers are formed: aqueous, oily and ethereal. After draining the aqueous layer, the middle, oily layer is allowed to clarify. It is then separated from the ether layer and the oil is completely freed of ether under vacuum. This results in crystallization of a yellow etherate of $\text{H}_3\text{Fe}(\text{CN})_6$; finally, however, pure $\text{H}_3\text{Fe}(\text{CN})_6$ remains as a brown mass. The acid may be recrystallized by solution in absolute ethanol and evaporation of the solvent. The compound must not be allowed to contact metal or rubber and should be kept as dry as possible.

SYNONYM:

Hydrogen hexacyanoferrate (III), ferricyanic acid.

PROPERTIES:

Rather readily soluble in water and alcohol; unlike $\text{H}_4\text{Fe}(\text{CN})_6$, it is also soluble in ether-alcohol mixtures. The aqueous solution is yellow to brown.

REFERENCE:

W. M. Cumming and D. G. Brown. *J. Soc. Chem. Ind. Trans.* **44**, 110 (1925).

Sodium Hexathiocyanoferrate (III)

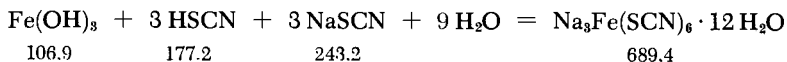

Aqueous HSCN solution is added in the cold to a known amount of freshly precipitated and well washed hydrated iron (III) oxide until the solid is barely dissolved. Then NaSCN is added until about nine moles of NaSCN are present for each mole of $\text{Fe}(\text{SCN})_3$. The solution is allowed to stand in a desiccator over conc. H_2SO_4 for several weeks; very dark-red crystals, which exhibit an intense green color when viewed by reflected light, separate out. On further evaporation of the mother liquor, precipitation of NaSCN also begins; on heating, the Fe^{3+} is partly reduced.

SYNONYM:

Sodium iron (III) thiocyanate.

PROPERTIES:

Deliquescent in air; converted to the trihydrate by storage over conc. H_2SO_4 . Soluble in alcohol, giving a permanganate-like violet color; may be recrystallized from such solutions without decomposition.

REFERENCES:

- G. Krüss and H. Morant. *Liebigs Ann.* 260, 209 (1890); A. Rosenheim and R. Cohn. *Z. anorg. Chem.* 27, 295 (1901); H. I. Schlesinger and H. B. van Valkenburgh. *J. Amer. Chem. Soc.* 53, 1215 (1931).

Sodium Pentacyanoamminoferrate (III)

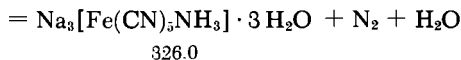
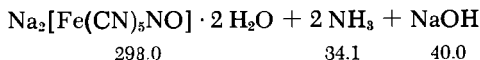

A mixture of 30 g. of $\text{Na}_2[\text{Fe}(\text{CN})_5\text{NO}] \cdot 2 \text{H}_2\text{O}$ with 120 ml. of water is prepared and cooled in an ice-salt mixture. Ammonia is then introduced at $+10^\circ\text{C}$ until saturation; the temperature during

this operation must not exceed 20°C. The solution is allowed to remain under a loose cover for several hours (not longer) at 0°C, and the crystals which separate from the deep brownish-yellow solution are collected by filtration. The remainder of the compound can be precipitated from the solution by addition of CH₃OH. The product may be purified by solution in some cold water, from which it is precipitated as fine, bright-yellow needles by careful addition of 90% alcohol.

The hexahydrate is hygroscopic and readily loses NH₃. It is dried to constant weight by storing for several days in a vacuum desiccator over CaCl₂. It then contains three (or, according to Hölzl, 2.5) moles of H₂O. Yield: 24 g. (73%). The yellow aqueous solution decomposes on heating, precipitating the hydroxide.

REFERENCES:

- K. A. Hofmann. Z. anorg. Chem. 10, 264 (1895); W. Manchot, E. Merry and P. Woringer. Ber. dtsh. chem. Ges 45, 2876 (1912); F. Hölzl and K. Rokitansky. Monatsh. Chem. 56, 82 (1930).

Sodium Pentacyanoamminoferrate (III)

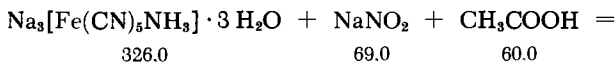

326.0 69.0 60.0

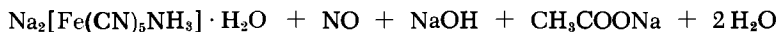

266.9 30.0 40.0 82.0

A solution of 20 g. of NaNO₂ in 50 ml. of water is treated at 0°C with 20 ml. of 30% acetic acid and then with 30 g. of Na₃[Fe(CN)₅NH₃] · 3H₂O. After two hours, 1:1 alcohol-ether is added; this first precipitates a violet aquo complex salt (formed in a side reaction); further addition of the alcohol-ether mixture precipitates the desired salt. This is purified by repeated solution in cold water and reprecipitation with alcohol. The dark-yellow powder is dried to constant weight in vacuum over conc. H₂SO₄; it then contains one or two moles of water.

The salt dissolves readily in water, giving a brownish-red color.

REFERENCES:

- K. A. Hofmann. Liebigs Ann. 312, 24 (1900); F. Hölzl and K. Rokitansky. Monatsh. Chem. 56, 82 (1930).

Cobalt, Nickel

O. GLEMSER

Metallic Cobalt

I. Prepared by reduction of precipitated cobalt oxalate with hydrogen.

Cobalt oxalate, precipitated in the cold, is dried at 120°C and ground to a fine powder. It is then reduced with H₂ (six hours at 500°C), with the temperature being raised rapidly at the beginning of the run. The product is cooled, ground and reduced once more; the fine metal powder is stored in a glass vessel under alcohol.

II. VERY PURE COBALT

Impurities, principally Fe, Cu and Ni, are removed by various precipitation reactions and by electrolysis. Finally, very pure Co is deposited electrolytically from a CoSO₄ solution. According to Kershner, Hoertel and Stahl, the pure metal still contains 0.001-0.002% Ni, 0.001-0.003% Fe, a maximum of 0.001% Cu, and 0.005% S.

A) REMOVAL OF IMPURITIES

A solution of the cobalt (II) salt is treated with Na₂CO₃ · 10 H₂O, added in small portions and with stirring, until the pH reaches 3.5; then 1 N Na₂CO₃ solution is added until the cobalt carbonate just barely precipitates. The precipitated carbonates are removed by filtration. Following this, 8 ml. of a saturated aqueous solution of 1,2-cyclohexanedione dioxime is added for each 10 mg. of Ni, Cu and Fe present in the filtrate. The Ni precipitates out; the suspension is heated for one hour at 90-95°C with occasional stirring, and the precipitate is filtered off.

The solution, which should now contain about 10% Co, is adjusted to a pH of 5.5 with H₂SO₄ or Na₂CO₃. Then, 0.2 moles of pyridine is added per liter of solution; the latter is electrolyzed

at 25°C (stirring), using a mercury cathode (206 cm.² of surface area) and a platinum sheet anode. The cathode potential stays constant at 0.78 volt. At a Ni content of 0.05–0.10 g./liter of solution, the electrolysis requires eight hours; at a level of 0.5 g. of Ni/liter, it takes 24–32 hours.

After the electrolysis, the solution is filtered and the Co(OH)_2 precipitated from the filtrate by addition of NaOH. The precipitate is washed by decantation with hot distilled water until the odor of pyridine is no longer apparent. The precipitate is then filtered off and dissolved in dilute H_2SO_4 in such a way as to give a solution containing 90–100 g. of Co. This solution then constitutes the starting material for the electrolytic separation of the metal (see the following).

B) SEPARATION OF THE METAL

The electrolysis cell is a 4-liter beaker with a side arm through which the solution can overflow into a collecting vessel. To avoid contamination from external sources, the cell and collecting vessel are placed in a glass cabinet. The solution is passed through the cell at 1–2 liters per hour, the pH being maintained at 1.2–1.6 by addition of the pyridine-free CoSO_4 solution. The electrolysis conditions are: 50–55°C, three platinum anodes and two titanium cathodes (the latter having about the same surface area as the anodes), cathode current density 40 amp./in.² The deposit of highly purified cobalt can be removed from the titanium cathodes.

To avoid accumulation of impurities in the electrolyte, the latter is periodically (as the need arises) reprocessed according to the procedure given in subsection A on removal of impurities (filtration, precipitation, washing and redissolution in H_2SO_4).

Alternate method: Reduction of CoO or Co_3O_4 with H_2 for five hours at 500°C (Gmelin, 8th ed., volume on cobalt).

PROPERTIES:

Atomic weight 58.94. Black metallic powder. M.p. 1492°C, b.p. 3183°C. Ferromagnetic. Readily soluble in dil. HNO_3 ; passivated by conc. HNO_3 .

REFERENCES:

- I. W. Biltz. Z. anorg. allg. Chem. 134, 25 (1924); G. F. Hüttig and R. Kassler. Z. anorg. allg. Chem. 187, 24 (1930).
- II. K. K. Kershner, F. W. Hoertel and J. C. Stahl. U. S. Dept. Interior, Bur. Mines Rep. Invest. 1956, I (Chem. Zentr. 1957, 255).

Cobalt (II) Chloride

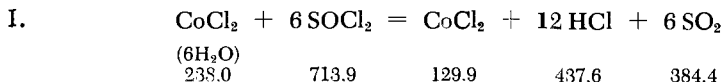

Fine $\text{CoCl}_2 \cdot 6 \text{H}_2\text{O}$ powder is placed in a flask provided with a ground joint and is covered with SOCl_2 . The mixture is refluxed for several hours. The excess SOCl_2 is then evaporated on a steam bath. The SOCl_2 which clings to the product is removed by repeated evacuation of the flask.

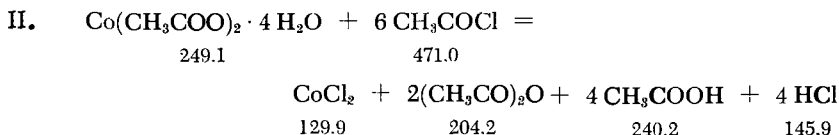

A Pyrex tube 18 × 200 mm. is charged with 4.0 g. of fine $\text{Co}(\text{CH}_3\text{COO})_2 \cdot 4 \text{H}_2\text{O}$ powder. It is then closed off with a rubber stopper; the latter carries a dropping funnel and a fritted-glass filtering finger. Then, 15 ml. of benzene is added with agitation (magnetic stirrer), followed by CH_3COCl (slow addition until about 10% excess). The mixture is stirred for 30 minutes, the CoCl_2 precipitate allowed to settle, and the mother liquor siphoned off through the filtering finger. The residue is treated with benzene and CH_3COCl to complete the reaction. The supernatant liquid is removed by filtration and the CoCl_2 is washed three or four times with anhydrous benzene; it is then dried for two hours at 150°C under nitrogen.

Alternate methods: a) Heating of $\text{CoCl}_2 \cdot 6 \text{H}_2\text{O}$ with COCl_2 in a sealed tube at 200°C [H. Hecht (1947)].

b) Heating of $\text{CoCl}_2 \cdot 6 \text{H}_2\text{O}$ in a stream of dry HCl at 160–170°C [G. L. Clark, A. J. Quick and W. D. Harkins, J. Amer. Chem. Soc. 42, 2483 (1920)]. Simple heating at 140°C yields a somewhat basic salt.

PROPERTIES:

Leaflets, colorless in very thin layers, pale blue in layers over 1 mm. thick. M. p. 735°C, b. p. 1049°C; d_4^{25} 3.367. Heat of formation (25°C): -77.8 kcal./mole. Decomposes on long heating in air at 400°C. Sublimes at 500°C in HCl gas, forming loose crystalline fragments. Hygroscopic. Solubility in H_2O (g. of $\text{CoCl}_2/100$ g. of solution): 29.5 (0°C); 34.86 (20°C); 51.93 (98°C). Soluble in

methanol, ethanol, acetone, pyridine and ether. Crystal structure: C 19 type.

REFERENCES:

- I. H. Hecht. Z. anorg. Chem. 254, 51 (1947).
- II. G. W. Watt, P. S. Gentile and E. P. Helvenston. J. Amer. Chem. Soc. 77, 2752 (1955).

Hexaammincobalt (II) Chloride

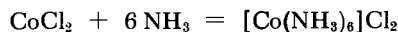

(6H ₂ O)		
238.0	102.2	232.0

A mixture of 15 g. of $\text{CoCl}_2 \cdot 6 \text{H}_2\text{O}$ and 14 ml. of H_2O is heated to boiling in the absence of air and treated hot with sufficient conc. NH_3 to produce complete solution; the solution is then filtered. Deaerated alcohol (air boiled out under reflux) is added to the hot filtrate until a permanent clouding is just barely obtained. The solution is cooled in running water and the solid thus precipitated is filtered off. It is washed with 1:1 conc. NH_3 : alcohol, then with the same mixture in 1:2 ratio, and lastly with deaerated, NH_3 -saturated alcohol. The product is dried over KOH in a high vacuum. Yield: 7 g.

The precipitation, washing, filtration and drying must be carried out in an O_2 -free atmosphere (for technique see Part I).

Alternate method: Passage of NH_3 over CoCl_2 at room temperature [W. Biltz and B. Fetkenheuer (1914)].

PROPERTIES:

Flesh-colored powder or rose-red crystals. In high vacuum over H_2SO_4 (65-67°C), converts to blue *trans*- $[\text{CoCl}_2(\text{NH}_4)_2]$. Relatively stable to O_2 when dry; gradually oxidized in air when moist. Readily soluble in dil. ammonia, sparingly soluble in conc. ammonia, insoluble in alcohol. d_4^{25} 1.479. Crystal structure: J 1₁ (K_2PtCl_6) type.

REFERENCE:

W. Biltz and B. Fetkenheuer. Z. anorg. allg. Chem. 89, 97 (1914).

Cobalt (II) Bromide

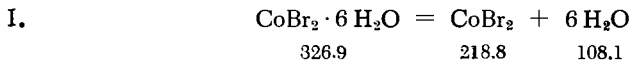
ANHYDROUS CoBr_2 

Prepared by careful heating of $\text{CoBr}_2 \cdot 6 \text{H}_2\text{O}$ to 130-150°C, followed by sublimation in high vacuum at 500°C.

II. Treatment of $\text{Co}(\text{CH}_3\text{COO})_2 \cdot 4 \text{H}_2\text{O}$ with CH_3COBr in benzene in a manner analogous to the preparation of CoCl_2 .

Alternate methods: a) Heating of $\text{CoBr}_2 \cdot 6 \text{H}_2\text{O}$ in a stream of HBr at 500°C [G. Crut. Bull. Soc. Chim. France [4] 35, 550 (1924)].

b) Allowing $\text{CoBr}_2 \cdot 6 \text{H}_2\text{O}$ to stand for one week over conc. H_2SO_4 [G. L. Clark and H. K. Bruckner (1922)].

PROPERTIES:

Green solid or lustrous green crystalline leaflets. M.p. 678° (under HBr and N_2); d_4^{25} 4.909. Heat of formation: -63.8 kcal./mole. Hygroscopic; in air, transforms to $\text{CoBr}_2 \cdot 6 \text{H}_2\text{O}$. Readily soluble in H_2O (red color). Saturated aqueous solution contains 66.7 g. of CoBr_2 at 59°C, 68.1 g. at 97°C (per 100 g. solution). Readily soluble in methanol, ethanol, acetone and methyl acetate; sparingly soluble in tetranitromethane. Crystal structure: C 6 type.

REFERENCES:

- G. L. Clark and H. K. Bruckner. J. Amer. Chem. Soc. 44, 230 (1922); W. Biltz and E. Birk. Z. anorg. allg. Chem. 127, 34 (1923); G. W. Watt, P. S. Gentile and E. P. Helveston. J. Amer. Chem. Soc. 77, 2752 (1955).

 $\text{CoBr}_2 \cdot 6 \text{H}_2\text{O}$

Precipitated cobalt carbonate is dissolved in aqueous HBr (d 1.49). The solution is heated on the steam bath until a deep blue color appears; it is then concentrated by evaporation on the steam bath. Cooling in ice water precipitates crystals of the hexahydrate; these are filtered off and washed with ice water.

PROPERTIES:

Formula weight 326.88. Red crystals. M.p. 47-48°C; d_4^{25} 2.46. Deliquescent in air. All water is removed by standing over conc. H_2SO_4 or by heating to 130-140°C.

REFERENCE:

G. L. Clark and H. K. Bruckner. J. Amer. Chem. Soc. 44, 230 (1922).

Cobalt (II) Iodide

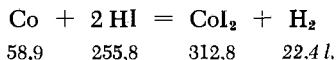
 $\alpha\text{-CoI}_2$ 

Fine Co powder obtained from cobalt oxalate is heated to 400-500°C in a stream of HI (4-5 hours). The product iodide is melted by heating to 550°C and allowed to cool in high vacuum.

PROPERTIES:

Black, graphitelike solid. M.p. 515-520°C (in high vacuum); d_4^{25} 5.584. Heat of formation; -39.13 kcal./mole. Solubility in H₂O: 58.7% (-2°C); 66.4% (25°C); 80.9% (111°C). Dilute solutions are red; concentrated solutions are red at low temperatures, while at higher temperatures all shades from brown to olive green are present. Very hygroscopic, becomes blackish green in air. Soluble in SOCl₂, POCl₃. Crystal structure: C 6 type.

REFERENCE:

W. Biltz and E. Birk. Z. anorg. allg. Chem. 127, 34 (1923).

 $\beta\text{-CoI}_2$

Sublimation of $\alpha\text{-CoI}_2$ in high vacuum yields $\beta\text{-CoI}_2$.

The starting $\alpha\text{-CoI}_2$ is placed at location *a* of the tube shown in Fig. 333 and heated slowly in a high vacuum to 570-575°C. Cobalt metal remains as a residue at *a*, and a black sublimate of $\alpha\text{-CoI}_2$ is deposited at *b*. Ochre-yellow $\beta\text{-CoI}_2$ appears at *c*, as do the I₂ crystals present in the tube. The tube is placed in a horizontal furnace in such a way that the section from *a* to *d* is at 100°C. The section projecting from the furnace is fanned with a flame until all I₂ collects at *e*. The loosely adhering $\beta\text{-CoI}_2$ is shaken from *c* into *f*. The apparatus is filled with N₂, and *f* with its contents is sealed off. About 0.8 g. of $\beta\text{-CoI}_2$ is obtained from 10 g. of $\alpha\text{-CoI}_2$.

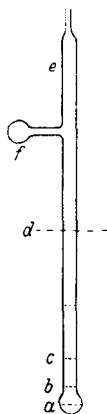

Fig. 333. Sublimation of cobalt(II) iodide.

PROPERTIES:

Ochre-yellow powder. d_4^{25} 5.45. Very hygroscopic; deliquesces in moist air, forming green droplets. Solution in H_2O is colorless, becoming rose-colored on heating. Blackens at $400^\circ C$ and converts to $\alpha-CoI_2$.

REFERENCE:

E. Birk and W. Biltz. Z. anorg. allg. Chem. 128, 46 (1923).

 $CoI_2 \cdot 6H_2O$

Precipitated cobalt carbonate or $Co(OH)_2$ is dissolved in aqueous HI. The solution is concentrated on a steam bath to a sirupy consistency and is then allowed to cool. The product is filtered off and washed with some water.

Alternate method: A solution of CoI_2 in water is cooled to a low temperature [G. L. Clark and H. K. Bruckner, J. Amer. Chem. Soc. 44, 230 (1922)].

PROPERTIES:

Formula weight 420.86. d 2.90. Long, dark-red crystals, which begin to lose water of crystallization above $27^\circ C$ and become anhydrous at $130^\circ C$.

REFERENCES:

O. Erdmann. J. prakt. Chem [1] 7, 254 (1836); A. Étard. Ann. Chim. Phys. [7] 2, 503 (1894).

Cobalt (II) Oxide **CoO**

Prepared by thermal decomposition of cobalt salts containing a volatile acid moiety.

Cobalt carbonate, precipitated from $Co(NO_3)_2 \cdot 6H_2O$ with aqueous Na_2CO_3 in the absence of air, is heated for several hours in high vacuum at $350^\circ C$.

Analysis for active oxygen is necessary (treatment with hydrochloric acid and determination by the Bunsen method).

Alternate method: (The product is less certain to have the composition CoO): heating of $Co(NO_3)_2 \cdot 6H_2O$ or Co_3O_4 to $1000^\circ C$ and cooling in a stream of N_2 .

PROPERTIES:

Formula weight 74.94. d_4^{18} 6.47. Heat of formation: -57.5 kcal./mole. Olive-green powder; takes up O_2 from air at room temperature. Becomes brown, and finally black, as the oxygen content increases. Stable in air when calcined at a high temperature. Converts to Co_3O_4 on heating in air at $390-900^\circ C$. Readily soluble in HCl , H_2SO_4 and HNO_3 . Fine CoO powder is also soluble in conc. alkali. Crystal structure: B1 (NaCl) type.

REFERENCE:

M. Le Blanc and E. Moebius. Z. phys. Chem. (A) 142, 151 (1929).

Cobalt (II,III) Oxide



Precipitated cobalt carbonate is heated for one hour at $700^\circ C$. Analysis for active oxygen is required (treatment with hydrochloric acid and determination by the Bunsen method).

Alternate methods: a) Heating of $Co(NO_3)_2 \cdot 6H_2O$ at $700^\circ C$ (crucible, one hour) (J. A. Hedvall and T. Nilson).

b) Heating of CoO in air at $700^\circ C$ [L. Wöhler and O. Balz, Z. Elektrochem. 27, 406 (1921)].

PROPERTIES:

Formula weight 240.82. d 6.073. Heat of formation: -206.1 kcal./mole. Blackish-gray powder. Converts in air to CoO ($905-925^\circ C$). Coarse crystalline Co_3O_4 is attacked only by conc. H_2SO_4 ; fine powder dissolves slowly in acids. Crystal structure: H 11 (spinel) type.

REFERENCE:

J. A. Hedvall and T. Nilson. Z. anorg. allg. Chem. 205, 425 (1932).

Cobalt (III) Hydroxide

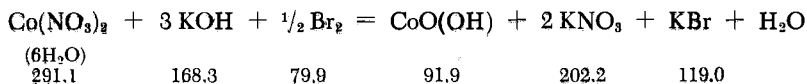

A solution of 56 g. of KOH in 300 ml. of H_2O is added dropwise (stirring) to a solution of 90 g. of $Co(NO_3)_2 \cdot 6H_2O$ and 12 ml. of

Br₂ in 1300 ml. of H₂O. The resulting precipitate settles in about three hours. It is washed by decantation with four 5-liter portions of CO₂-free water. Should the precipitate undergo peptization on repeated addition of wash water, it is filtered on a Zsigmondy membrane filter, suction-dried and slurried in five liters of CO₂-free water. The slurry is filtered as above and the solid dried in a vacuum desiccator over conc. H₂SO₄.

All operations (precipitation, decantation and filtration) must be conducted in a CO₂-free atmosphere. After drying in the vacuum desiccator, this precaution is no longer necessary.

Alternate methods: a) Air oxidation of a solution of CoCl₂ · 6 H₂O in aqueous NaOH [W. Feitknecht and W. Bédert, *Helv. Chim. Acta* **24**, 683 (1941)].

b) Precipitation of [Co(NH₃)₆]Cl₃ with aqueous KOH [G. F. Hüttig and R. Kassler (1929)].

ANALYSES REQUIRED:

Co (electrolytic), H₂O, CO₂, and active oxygen (treatment with hydrochloric acid and determination by the Bunsen method). Used as an oxidation catalyst.

PROPERTIES:

Black powder. d 4.29-4.90. Converts to Co₃O₄ on heating in vacuum at 148-150°C. Dissolves in HCl, evolving Cl₂. Soluble in HNO₃ and H₂SO₄. Not attacked by aqueous alkali or ammonia. Solution in organic acids such as oxalic or tartaric, accompanied by reduction.

REFERENCE:

G. F. Hüttig and R. Kassler. *Z. anorg. allg. Chem.* **184**, 279 (1929).

Cobalt (II) Hydroxide

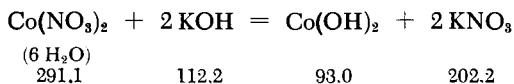
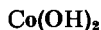

ROSE-COLORED Co(OH)₂

A solution of 40 g. of Co(NO₃)₂ · 6 H₂O in 1000 g. of H₂O, cooled to 0°C, is added dropwise and with vigorous shaking to a solution of 40 g. of KOH in 500 g. of H₂O maintained at 0°C. The

initial blue color of the precipitate rapidly turns to rose. The precipitate is washed by decantation with CO_2 - and O_2 -free water until K^+ and NO_3^- ions can no longer be detected. It is then filtered off and dried in a desiccator over 50% H_2SO_4 .

Precipitation, washing, filtration and drying must be carried out in an atmosphere free of CO_2 and O_2 , since $\text{Co}(\text{OH})_2$ oxidizes very readily (for technique, see Part I).

ANALYSES REQUIRED:

Co (electrolytic) H_2O and CO_2 .

PROPERTIES:

Rose-red powder. d_4^{15} 3.597. Heat of formation: -- 63.4 kcal. per mole. Converts to $\text{CoO} + \text{H}_2\text{O}$ when heated in vacuum at 168° . Oxidation leads to higher cobalt hydroxides. Readily soluble in acids, insoluble in dil. alkalies, appreciably soluble in ammonia. Crystal structure: C 6 type.

REFERENCE:

G. F. Hüttig and R. Kassler. *Z. anorg. allg. Chem.* 187, 16 (1930).

BLUE $\text{Co}(\text{OH})_2$

A small excess of NaOH solution is added to a 0.1 M cobalt salt solution containing about 1% glucose. The precipitate is thoroughly washed in the absence of air with aqueous alcohol, aqueous acetone and finally with pure acetone. It is then dried. The resulting blue hydroxide changes color very readily on drying (oxidation).

When only small quantities are needed, 5 ml. of the 0°C , 0.1 M cobalt salt solution is treated with 5.2 ml. of 0°C , carbonate-free 0.2 N NaOH in a small Erlenmeyer flask. The precipitate and the mother liquor are poured at once into a centrifuge tube chilled in ice-salt mixture and frozen. The tube, containing the frozen block of solution plus precipitate, is then removed from the ice-salt bath; as soon as the block detaches from the glass tube it is crushed in a porcelain mortar and melted in the centrifuge tube by addition of 25% alcohol. The precipitate is rapidly centrifuged and washed twice with chilled aqueous acetone and with pure acetone. The acetone clinging to the blue precipitate is evaporated in vacuum.

PROPERTIES:

Blue powder. Constitution: "double-layer lattice," related to C 6 type.

REFERENCE:

W. Feitknecht. *Helv. Chim. Acta* 21, 766 (1938) and private communication.

Cobalt Sulfides

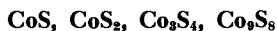
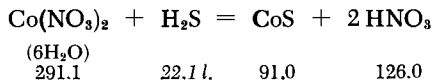
 α -CoS

Precipitated in the same way as α -NiS. The product is dried for 90 hours, with the temperature raised slowly from 100 to 540°C. The sulfide dried at 300°C is pyrophoric.

Catalyst for pressure hydrogenation of organic compounds.

PROPERTIES:

Black powder, soluble in HCl. Forms $\text{Co}(\text{OH})\text{S}$ in air. Amorphous (by x-ray analysis). Heat of formation: -21.71 kcal./mole.

REFERENCE:

E. Dönges. *Z. anorg. Chem.* 253, 346 (1947).

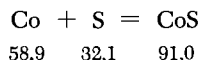
 β -CoS

Fine Co powder is mixed with the stoichiometric quantity of fine S powder and heated at 650°C for 2-3 days in an evacuated, sealed quartz tube. The tube is then quenched in cold water.

Analyses for Co and S are necessary. The compound is used as catalyst in the hydrogenation of organic compounds.

Alternate method: A 1 N solution of CoCl_2 is treated with acetic acid and precipitated with H_2S ; workup is the same as in the case of α -CoS.

PROPERTIES:

Gray powder. M.p. 1135°C; d 5.45. Soluble in acids. Crystal structure; B8 type. Long heating at 200°C produces a modification with a complicated structure. Material with an overall formula $\text{CoS}_{1.0}$ is not homogeneous; the CoS phase has the composition $\text{CoS}_{1.04}$ - $\text{CoS}_{1.13}$.

REFERENCES:

- D. Lundquist and A. Westgren. *Z. anorg. allg. Chem.* **239**, 85 (1938); E. Dönges. *Z. anorg. Chem.* **253**, 346 (1947).

CoS₂

Stoichiometric quantities of Co and S powders are mixed and reacted in the same way as described in the case of β -CoS.

II. REACTION OF H₂S WITH COBALT (III) COMPLEXES

Dry, H₂-free H₂S is allowed to react with [Co(NH₃)₅Cl]Cl₂ or [Co(NH₃)₆]Cl₃. The temperature is raised to 600-630°C over a period of one hour, and maintained at this level for two hours. The product is allowed to cool to 200°C in the stream of H₂S; then the H₂S is displaced with dry CO₂ and the product is cooled further. It is sensitive to air; it is heated with S in a sealed tube (one day at 750°C), and the excess S is extracted with CS₂ after the reaction is complete.

Analyses for Co and S are required. Used as a catalyst in organic syntheses.

PROPERTIES:

Gray-black crystalline powder; *d* 4.269. Liberates S when heated in absence of air. Not attacked by nonoxidizing acids or alkalis. Crystal structure: C 2 type.

REFERENCES:

- I. D. Lundquist and A. Westgren. *Z. anorg. allg. Chem.* **239**, 85 (1938).
 II. O. Hülsmann and W. Biltz. *Ibid.* **224**, 73 (1935).

Co₂S₄ (H11 type) and Co₉S₈ (cubic crystalline) are prepared in the same way as β -CoS: heating stoichiometric quantities of Co and S powders in an evacuated, sealed quartz tube at 650°C. [D. Lundquist and A. Westgren (1938)].

Cobalt (III) Sulfate

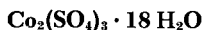

A sulfuric acid solution of CoSO₄ · 7H₂O (formula wt. 281.11) is anodically oxidized at 0°C.

A porous clay cell (about 120 ml. capacity) is charged with a solution of 24 g. of $\text{CoSO}_4 \cdot 7\text{H}_2\text{O}$ in 75 ml. of warm $8\text{N H}_2\text{SO}_4$. A cylindrical Pt sheet (4 cm. high, 12 cm. wide), which serves as anode, is also inserted. A Pt wire welded to the sheet serves as the electrical lead. A Cu cylinder (8 cm. high) with a suitable electrical lead is placed around the clay cell and serves as the cathode. The cathode electrolyte is $8\text{N H}_2\text{SO}_4$. The electrolysis vessel is cooled in ice water. The electrolysis starts when the anode electrolyte has reached 30°C and takes about 12 hours. The thick, deep-blue suspension is rapidly filtered through a fritted-glass funnel and is then pressed dry on a clay plate with a Pt spatula.

Alternate method: Gaseous fluorine is passed through an ice-cold solution of 24 g. of $\text{CoSO}_4 \cdot 7\text{H}_2\text{O}$ in 150 ml. of $8\text{N H}_2\text{SO}_4$ [F. Fichter and H. Wolfmann, *Helv. Chim. Acta* 9, 1093 (1926)].

PROPERTIES:

Formula weight 730.37. Lustrous, blue-green leaflets. Decomposes rapidly in ice-cold water, liberating O_2 and yielding CoSO_4 . Dilute H_2SO_4 gives a green solution which is stable for several days. Aqueous NaOH precipitates Co(OH) . Decomposes rapidly when heated in dry air, forming a brown (later reddish) powder. Powerful oxidizing agent.

REFERENCE:

E. Muller. *Elektrochem. Praktikum* [Laboratory Manual for Electrochemistry], 5th ed., Leipzig, 1940, p. 218.

Cobalt Aluminate

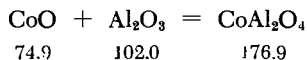

A stoichiometric mixture of CoO and Al_2O_3 is prepared and then mixed with 1.5 times its weight of KCl . The mixture is heated to about 1100°C in a porcelain crucible. The melt is cooled, pulverized, and extracted with boiling water until no further Cl^- reaction is obtained. The residue is dried at 60°C in a drying oven.

SYNONYM:

Thenard's blue.

PROPERTIES:

M. p. 1700-1800°; d_4^{18} 4.37. Not attacked by Cl_2 , mineral acids or aqueous alkalis. Decomposed by fusion with KHSO_4 and by heating with H_2SO_4 in a sealed tube at 200°C. Crystal structure: H 11 (spinel) type.

REFERENCES:

J. A. Hedvall. Z. anorg. allg. Chem. 92, 305 (1915); 96, 72 (1916).

Hexaamminecobalt (III) Nitrate

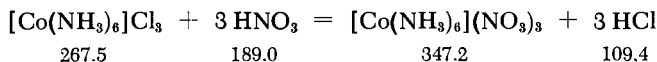
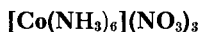

A solution of $[\text{Co}(\text{NH}_3)_6]\text{Cl}_3$ in a minimum quantity of water is prepared and dil. HNO_3 is added; the resulting precipitate is washed with dil. HNO_3 until free of the chloride ion, then with 90% alcohol until free of acid.

PROPERTIES:

Yellow tetragonal prisms. d_4^{25} 1.804. Solubility in H_2O in moles/liter: 0.0202 (0°C); 0.052 (20°C); 0.0704 (30°C).

REFERENCE:

S. M. Jørgensen. Z. anorg. Chem. 17, 457 (1898).

Cobalt (III) Amide



Fluffy $\text{Co}(\text{NH}_2)_3$ precipitates upon addition of KNH_2 to a solution of $[\text{Co}(\text{NH}_3)_6](\text{NO}_3)_3$ in liquid NH_3 .

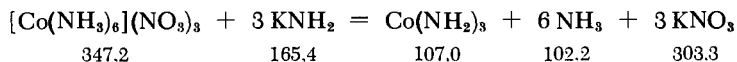

The process requires a supply of N_2 entirely free of oxygen traces (see p. 458 ff.); this nitrogen is then passed through a wash bottle with conc. KOH , a drying tower with solid KOH , and two U tubes with P_2O_5 . The stream of N_2 is then led to a manifold,

from which it may be directed through stopcocks to various reaction vessels and auxiliary apparatus such as transfer and storage tubes. A branch terminating in a mercury-filled beaker serves as a pressure-relief valve.

In addition, a stream of very pure NH_3 is required; this may be taken from a storage cylinder which contains some Na metal. The NH_3 is passed through a drying tube containing NaNH_2 and then a fritted-glass disk (not too fine) to remove any entrained solid particles. The NH_3 line has two side branches, one terminating in a vent stopcock, the other in an Hg manometer. The NH_3 line must be capable of withstanding pressures to about 10 atm.; thus, it must contain no ground joints and only a few well-secured stopcocks. The NH_3 line itself terminates in the above-mentioned manifold.

The reaction takes place in the pressure-resistant vessel shown in Fig. 334. This vessel and accessory equipment are attached to the manifold via flexible couplings made of lead tubing or corrugated pinchbeck (copper-zinc alloy); thus, they may be connected to the N_2 or NH_3 streams, as desired, and also can be moved to some extent.

The pressure apparatus is first heated while the N_2 stream passes through. Then, 1.5-2 g. of $[\text{Co}(\text{NH}_3)_6](\text{NO}_3)_3$ is admitted through *a* from a charging funnel and placed on the fritted-glass disk. The tube is then sealed at *c*. Next, a few mg. of Pt black and the required quantity of metallic K (3 moles of K per mole of $[\text{Co}(\text{NH}_3)_6](\text{NO}_3)_3 + 5\%$ excess K) are placed in reactor *b*, and the tube is sealed at *d*. The stopcock on the N_2 line is closed and the valve on the NH_3 cylinder is opened. When the manometer in the NH_3 line shows about 4 atm., the valve is closed and the NH_3 is vented to the atmosphere by opening the vent stopcock. This purging process is repeated three times to displace the N_2 from the apparatus. Then reactor *b* is immersed in ice-salt mixture, the valve on the NH_3 cylinder fully opened, and NH_3 allowed to condense in *b* until the latter is $3/4$ full of liquid. Stopcock *h* is then closed and tube *a* is cooled so that NH_3 distills from *b* into *a*. The hydrogen evolved in the reaction of K with NH_3 is vented

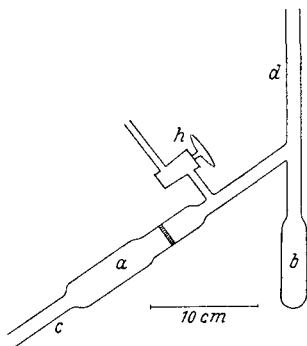

Fig. 334. Pressure vessel for preparation of cobalt (III) amide. Stopcock *h* and associated tubing are perpendicular to the plane of the diagram. The plug in *h* is held in place by a clamp to prevent it from being blown out by pressure in the apparatus.

from time to time by carefully opening *h* and the vent stopcock in the NH_3 line. All of the potassium is allowed to react, whereby all the $[\text{Co}(\text{NH}_3)_6](\text{NO}_3)_3$ dissolves. The apparatus is then tilted while tube *a* is cooled. The KNH_2 solution is thereby filtered into *a*; (at the same time, the apparatus is rocked to mix the contents). Reactor *b* is then recooled, thus recondensing the NH_3 in it; this liquid NH_3 is again filtered into *a*. This procedure is repeated three times in order to react all of the KNH_2 . The reaction mixture is allowed to remain in *a* for six hours (ice cooling and frequent shaking). It is then filtered into *b*, the precipitate being retained on the fritted-glass disk. The ammonia is again evaporated from *b* and condensed in *a*, shaken there with the solid, and filtered into *b* once more. This is repeated ten times, after which the precipitate is completely free of KNO_3 . Finally, the NH_3 is vented by opening *h* as well as the vent stopcock in the NH_3 line. Nitrogen is then introduced into the apparatus, which is then inverted and opened by breaking the seal at *c*. The amide on the filter plate is crushed with the aid of a bent Ni spatula, and transferred (in a stream of N_2) through the open end of *a* into a storage device (see Part I, Fig. 54b for the latter). This storage tube is also purged with very pure N_2 and, after the amide has been introduced, is closed with a ground stopper. The storage tube is cooled in ice while N_2 is passed over the amide until no further NH_3 is given off.

ANALYSIS:

The product amide is placed in a small glass bulb (air must be excluded). The bulb is then sealed. The following may then be done:

Determination of NH_3 : Aqueous KOH is added to the amide and the liberated NH_3 is distilled into a known quantity of acid.

Determination of Co : The $\text{Co}(\text{OH})_3$ which precipitates on addition of KOH is dissolved in sulfurous acid and the Co determined by analytical electrolysis.

The NO_3^- is determined with diphenylamine.

PROPERTIES:

Chocolate-brown powder; sometimes pyrophoric. Soluble in dil. acids with brown-red color, and in cold water with brown color; the slightly cloudy liquid gradually deposits brownish-black cobalt (III) hydroxide. Forms CoN in vacuum at $40\text{--}50^\circ\text{C}$. Heating in liquid NH_3 produces CoN , Co_2N and $\text{CoNo}_{.28}$.

REFERENCE:

O. Schmitz-Dumont, J. Pilzecker and H. F. Piepenbrinck. *Z. anorg. allg. Chem.* **248**, 175 (1941).

Dicobalt Nitride

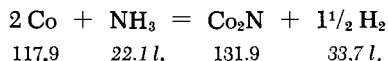

Ten mg. of Co_3O_4 is reduced with pure H_2 by heating in a corundum boat for two hours at 350°C . The resulting Co powder is then heated for three hours at 380°C in a stream of NH_3 which passes through the tube at 22 cm./sec. The product is ground and treated once more under the same conditions.

The reduction and nitridation must be carried out in one continuous operation, since the Co powder obtained by reduction of Co_3O_4 is pyrophoric. The cobalt powder prepared from cobalt oxalate cannot be completely converted to nitride under these conditions.

Alternate method: Thermal degradation of $\text{Co}(\text{NH}_2)_3$ in vacuum at 160°C [O. Schmitz-Dumont, *Angew. Chem.* 67, 231 (1955); J. Clarke and K. H. Jack, *Chem. and Ind.* 1951, 1004].

PROPERTIES:

Grayish-black powder. d 6.4. In the cold, dil. acids and alkalis react slowly, conc. HCl rapidly, and conc. HNO_3 violently. Warm dil. acids also dissolve Co_2N rapidly. The slow attack by acids gives a quantitative yield of the NH_4 salts (this is an analytical method), while vigorous decomposition evolves part of the nitrogen as N_2 . Forms a nitride with the approximate composition Co_3N on thermal decomposition. In vacuum, stable until formation of the compound $\text{CoN}_{0.41}$ at 200°C ; at 250°C , hexagonal metallic Co containing small amounts of Ni is produced. Crystal structure: rhombically deformed hexagonal close packing of metal atoms.

REFERENCE:

R. Juza and W. Sachse. *Z. anorg. Chem.* 253, 45 (1945).

Cobalt Nitride

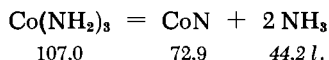

Cobalt amide is placed in a vapor-pressure eudiometer (see Part I, Fig. 85) and carefully decomposed at $50\text{--}70^\circ\text{C}$ in the absence

of air. The NH_3 evolved is absorbed in conc. H_2SO_4 . The degradation is continued until all NH_3 has been eliminated. The CoN thus formed is transferred in the absence of air to a glass bulb, which is then sealed off. The exact stoichiometric composition is never attained, since a small amount of N_2 is evolved along with the NH_3 . The degradation products usually have the composition $\text{CoN}_{0.8}$ - $\text{CoN}_{0.9}$.

ANALYSIS:

To determine the valence of Co, the sample is carefully heated with 2 N KOH until NH_3 can no longer be detected. The resulting blue liquid, which contains suspended cobalt (III) hydroxide, is treated with KI and NaHCO_3 in a flask closed off with a glass stopper, and is then carefully acidified. After standing for one day, the I_2 which separates is back-titrated with $\text{Na}_2\text{S}_2\text{O}_3$ solution.

PROPERTIES:

Black powder; pyrophoric. The nitrogen content of the degradation product drops off with increasing degradation temperature (the composition $\text{CoN}_{0.5}$, corresponding to the formula Co_2N , is obtained at 160°C). Heating in the presence of H_2O and aqueous alkali liberates NH_3 . Dilute H_2SO_4 liberates part of the bound nitrogen as N_2 . Crystal structure: B1 type.

REFERENCES:

- O. Schmitz-Dumont, H Broja and H. F. Piepenbrink. Z. anorg. Chem. 253, 118 (1947); O. Schmitz-Dumont. Angew. Chem. 67, 231 (1955).

Cobalt Phosphides

 CoP_3 , CoP , Co_2P

Prepared by heating stoichiometric quantities of pure Co metal and red P for 20 hours at 650 - 700°C in sealed, evacuated quartz tubes. The starting Co powder is obtained by reduction of CoO or Co_3O_4 with H_2 at 700°C .

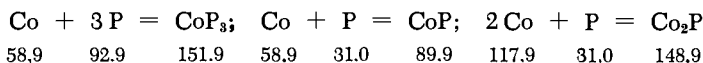

PROPERTIES:

- CoP_3 : Grayish-black powder; d_4^{25} 4.26.
 CoP : Grayish-black powder; d_4^{25} 6.24. Crystal structure: B21 type.
 Co_2P : Grayish-black powder; d_4^{25} 7.4. Crystal structure: C23 type.

REFERENCES:

- CoP₃: W. Biltz and M. Heimbrecht. Z. anorg. allg. Chem. 241, 349 (1939).
 CoP: K. E. Fylking. Ark. Kem. Mineral. Geol. 11 (B), No. 48 (1934).
 Co₂P: H. Nowotny. Z. anorg. Chem. 254, 31 (1947).

Dicobalt Carbide

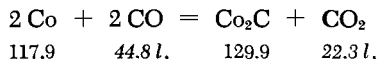

Fine Co powder, obtained from CoO and H₂ at 280-300°C, is heated at 220°C with dry, O₂-free CO (flow rate 0.75 liter/hour) for 550 hours. Reduction of the oxide and preparation of the carbide must be carried out in one continuous operation, since the Co powder is pyrophoric. The temperature must be held exactly at 220°C since Co₂C decomposes above 225°C.

ANALYSIS:

Heating of Co₂C (9.24% C) with H₂ at 250°C gives a quantitative yield of CH₄ (free C gives no CH₄ under these conditions).

PROPERTIES:

Metallic-gray powder. Decomposes between 260 and 310°C. Hydrogen converts the orthorhombic carbide to a hexagonal form between 198 and 275°C, N₂ between 297 and 369°C, and CO₂ between 364 and 540°C. Space group of the rhombic carbide: d₂¹⁴_h.

REFERENCES:

- H. A. Bahr and V. Jessen. Ber. dtsch. chem. Ges. 63, 2226 (1930);
 J. E. Hofer and W. C. Beebles. J. Amer. Chem. Soc. 69, 893 (1947).

Hexaammincobalt (III) Chloride

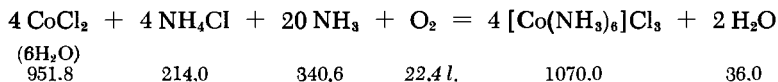

A mixture of 240 g. of CoCl₂ · 6 H₂O, 160 g. of NH₄Cl, and 200 ml. of H₂O is shaken until solution is almost complete. Then 4-5 g.

of activated charcoal and 500 ml. of conc. ammonia are added, and a fast stream of air is passed through the mixture until the red solution becomes yellow-brown. The air flow should not be so rapid as to reduce the ammonia content; should this occur, some additional conc. ammonia may be added.

The precipitated $[\text{Co}(\text{NH}_3)_5]\text{Cl}_3$ and the charcoal are filtered off, and the residue is dissolved in hot 1-2% HCl. The solution is filtered hot and the pure product is precipitated by adding 400 ml. of conc. HCl and chilling to 0°C. The precipitate is collected, washed first with 60% alcohol, then with 95% alcohol, and finally dried at 80-100°C. Yield: 85%.

Alternate method: From $[\text{Co}(\text{NH}_3)_5\text{Cl}]\text{Cl}_2$ and ammonia [S. M. Jørgensen, Z. anorg. Chem. 17, 455 (1898)].

SYNONYM:

Luteocobalt chloride.

PROPERTIES:

Wine-red or brownish-red monoclinic crystals. d_4^{25} 1.710. Solubility in H_2O in moles/liter: 0.152 (0°C); 0.26 (20°C); 0.42 (46.6°C); Boiling in water yields $\text{Co}(\text{OH})_2$.

REFERENCES:

- J. Bjerrum. Metal Ammine Formation in Aqueous Solution, p. 241, Copenhagen, 1941; J. Bjerrum and J. P. McReynolds in: W. C. Fernelius, Inorg. Syntheses, Vol. II, New York-London, 1946, p. 217.

Chloropentaamminecobalt (III) Chloride

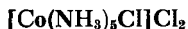

Obtained by oxidation of an ammoniacal CoCl_2 solution, and purified via $[\text{Co}(\text{NH}_3)_5\text{H}_2\text{O}]\text{Cl}_2 \cdot 4\text{H}_2\text{O}$.

A) CRUDE PRODUCT, $[\text{Co}(\text{NH}_3)_5\text{Cl}]\text{Cl}_2$

A solution of 20 g. of precipitated cobalt carbonate in some 1:1 HCl is prepared, filtered and cooled; a mixture of 250 ml. of conc. ammonia and 50 g. of $(\text{NH}_4)_2\text{CO}_3$ dissolved in 250 ml. of H_2O is then added. The mixture is oxidized for three hours by bubbling in a stream of air. After addition of 150 g. of NH_4Cl the solution is evaporated to sirup consistency on the steam bath. Dilute HCl is added to drive off the CO_2 and produce a weakly acid reaction;

then ammonia is added to give a weakly basic solution, followed by 10 ml. of additional conc. ammonia. The liquid, whose volume at this point is 400-500 ml., is heated on the steam bath until all the tetraammine salt disappears; it is then treated with 300 ml. of conc. HCl and heated for 30-45 minutes on the steam bath. The $[\text{Co}(\text{NH}_3)_5\text{Cl}]\text{Cl}_2$ precipitates on cooling. It is filtered off and washed with 1:1 HCl until free of NH_4Cl , then with alcohol until free of acid. The salt still contains some $[\text{Co}(\text{NH}_3)_5]\text{Cl}_2$. Yield: 34.5 g.

REFERENCE:

S. M. Jørgensen. Z. anorg. Chem. 5, 361 (1894).

B) AQUOPENTAAMMINECOBALT (III) OXALATE,
 $[\text{Co}(\text{NH}_3)_5(\text{H}_2\text{O})]_2(\text{C}_2\text{O}_4)_3 \cdot 4\text{H}_2\text{O}$

A mixture of 10 g. of finely powdered crude $[\text{Co}(\text{NH}_3)_5\text{Cl}]\text{Cl}_2$, 75 ml. of H_2O , and 50 ml. of 10% ammonia is heated on the steam bath in an Erlenmeyer flask covered with a watch glass (continuous agitation) until all of the basic aquopentaammine chloride dissolves and a deep-red solution forms. The solution is filtered, the filtrate is made very weakly acid with oxalic acid, and some additional $(\text{NH}_4)_2\text{C}_2\text{O}_4$ is added to complete the precipitation. The slurry is allowed to stand; the precipitate is then filtered off and washed with cold water. The yield of the dry salt is about 12 g.

SYNONYM:

Roseocobalt oxalate.

PROPERTIES:

Formula weight 660.36. Brick-red crystals. Solubility in water at 17.5°C is 0.0019 moles/liter.

REFERENCE:

S. M. Jørgensen. Z. anorg. Chem. 19, 78 (1899).

C) PURE CHLOROPENTAAMMINECOBALT (III) CHLORIDE,
 $[\text{Co}(\text{NH}_3)_5\text{Cl}]\text{Cl}_2$

Twenty grams of $[\text{Co}(\text{NH}_3)_5(\text{H}_2\text{O})]_2(\text{C}_2\text{O}_4)_3 \cdot 4\text{H}_2\text{O}$ is dissolved in 150 ml. of 2% ammonia in the cold, and the insoluble $[\text{Co}(\text{NH}_3)_6]_2(\text{C}_2\text{O}_4)_3 \cdot 4\text{H}_2\text{O}$ (luteooxalate) is filtered off. The filtrate is precipitated in the cold with dil. HCl. The $[\text{Co}(\text{NH}_3)_5\text{Cl}]\text{Cl}_2$ thus formed is filtered off, washed successively with alcohol, absolute alcohol and ether, and dried in air.

The purification method given by Jörgensen does not yield completely pure $[\text{Co}(\text{NH}_3)_5\text{Cl}]\text{Cl}_2$.

ANALYSIS:

Ionizable Cl and total Cl are determined in order to determine whether impurities are present.

SYNONYM:

Chloropurpureocobalt chloride.

PROPERTIES:

Formula weight 250.47. Ruby-red crystals. d_4^{25} 1.783. Solubility in H_2O : 0.0089 (0°C); 0.0225 (25°C); 0.040 (50°C) moles/liter. The presence of HCl lowers the solubility; at 25°, 10% HCl dissolves 0.00067 moles/liter. Neutral aqueous solutions decompose when boiled, and $\text{Co}(\text{OH})_2$ is deposited. Heating to higher temperatures produces CoCl_2 . Crystal type: orthorhombic-bipyramidal.

REFERENCE:

F. J. Garrick. Z. anorg. allg. Chem. 224, 27 (1935).

Nitropentaammincobalt (III) Chloride

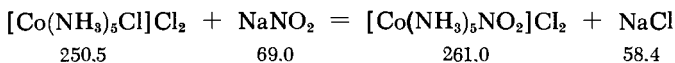
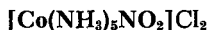

A mixture of 20 g. of $[\text{Co}(\text{NH}_3)_5\text{Cl}]\text{Cl}_2$, 200 ml. of H_2O , and 50 ml. of 10% ammonia is placed in an Erlenmeyer flask covered with a watch glass, and heated on the steam bath until the salt dissolves (frequent shaking is necessary). The solution is filtered, the filtrate cooled and made weakly acidic with dil. HCl, 25 g. of crystalline NaNO_2 is added, and heating on the steam bath is continued until the initial red precipitate dissolves completely. The cold, brownish-yellow solution contains a copious deposit of crystals. At this point, 250 ml. of conc. HCl is added (carefully at first). After chilling, the product is filtered off, washed with 1:1 HCl, then with alcohol until free of acid, and dried in air. Yield: 17 g.

SYNONYM:

Xanthocobalt chloride.

PROPERTIES:

Brownish-yellow monoclinic crystals. d_4^{25} 1.804. Solubility in H_2O at $20^\circ C$: 0.11 moles/liter of solution; more soluble in hot H_2O . Decomposes on heating to $210^\circ C$.

REFERENCE:

S. M. Jørgensen. Z. anorg. Chem. 17, 463 (1898).

Nitritopentaamminecobalt (III) Chloride

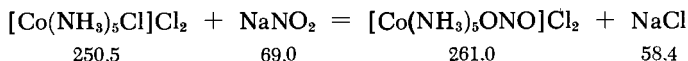
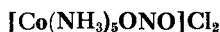

A solution of 10 g. of $[Co(NH_3)_5Cl]Cl_2$ in a mixture of 150 ml. of H_2O and 25 ml. of 10% ammonia is prepared with heating and agitation. The solution is filtered, cooled and exactly neutralized with dil. HCl. Then 25 g. of crystalline $NaNO_2$ is added and, when this has dissolved, 10 ml. of 1:1 HCl. The resulting precipitate is allowed to stand for several hours in the mother liquor while cooling in water; it is then filtered off and washed with cold water and alcohol.

PROPERTIES:

Chamois-colored crystalline powder, four times less soluble in water than nitropentaamminecobalt chloride. On standing for several weeks, converts to the isomeric form. The conversion is more rapid if a 10% aqueous solution of the compound is treated with an equal volume of conc. HCl.

REFERENCE:

S. M. Jørgensen. Z. anorg. Chem. 5, 168 (1894).

Carbonatotetraamminecobalt (III) Sulfate



An aqueous solution of $CoSO_4$ is treated with $(NH_4)_2CO_3$ and NH_4OH , then oxidized in a stream of air.

Precipitated cobalt carbonate (20 g.) is dissolved in a minimum quantity of dil. H_2SO_4 . The clear solution (about 100 ml.) is poured

into a solution of 100 g. of $(\text{NH}_4)_2\text{CO}_3$ in 500 ml. of H_2O and 250 ml. of conc. ammonia, and air is bubbled through for 2-3 hours. After complete oxidation, the blood-red solution, containing several small pieces of $(\text{NH}_4)_2\text{CO}_3$, is evaporated on a steam bath until the volume is 300 ml. The solution is then filtered, concentrated to 200 ml. and chilled, whereupon $[\text{Co}(\text{NH}_3)_4\text{CO}_3]_2\text{SO}_4 \cdot 3\text{H}_2\text{O}$ crystallizes as red prisms. The mother liquor is decanted; the precipitate is filtered off and washed once with a saturated solution prepared from a small portion of the precipitate. More salt is obtained by further evaporation of the mother liquor [add some $(\text{NH}_4)_2\text{CO}_3$]. Yield: 32 g.

PROPERTIES:

Formula weight 524.27. Garnet-red prisms. d 1.882. The aqueous solution decomposes on standing in light. Forms $[\text{Co}(\text{NH}_3)_4(\text{H}_2\text{O})_2]\text{SO}_4$ (tetraammineroseocobalt sulfate) with dil. H_2SO_4 . Loses all water over conc. H_2SO_4 . Crystal form: orthorhombic-bipyramidal.

REFERENCE:

S. M. Jørgensen. Z. anorg. Chem. 2, 281 (1892).

Dichlorotetraamminecobalt (III) Chloride

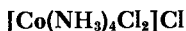

Two stable isomeric forms exist: these are the 1,2-dichloro- (*cis*-) and 1,6-dichloro- (*trans*-) compounds.

1,2-DICHLOROTETRAAMMINECOBALT(III) CHLORIDE (CIS),
 $[\text{Co}(\text{NH}_3)_4\text{Cl}_2]\text{Cl} \cdot 0.5\text{H}_2\text{O}$

Treatment of an ammoniacal solution of $\text{Co}(\text{CH}_3\text{COO})_2 \cdot 4\text{H}_2\text{O}$ with NaNO_2 , followed by air oxidation, affords $[\text{Co}(\text{NH}_3)_4(\text{NO}_2)_2]\text{NO}_2$, which is converted to the dichloro compound with conc. HCl .

Air is bubbled for five hours through a solution of 20 g. of NaNO_2 and 20 g. of $\text{Co}(\text{CH}_3\text{COO})_2 \cdot 4\text{H}_2\text{O}$ in 200 ml. of 20% NH_3 . The violet solution is concentrated to a small volume with occasional addition of solid NaHCO_3 , then chilled. A large excess of alcohol is added to cause precipitation. The precipitate is filtered off, washed with alcohol-ether, and dried in a vacuum desiccator. This is *cis*-dinitrotetraamminecobalt (III) nitrite, which is not contaminated with the *trans* compound. It is very easily hydrolyzed.

The *cis*-nitrite is added in small portions to conc. HCl maintained at -10°C , giving a quantitative yield of the chloride.

SYNONYM:

Formerly: Chlorovioleocobalt chloride.

PROPERTIES:

Formula weight 242.45. Violet needles. Water soluble; loses water of hydration at 60°C. Very unstable.

REFERENCE:

C. Duval. Comptes Rendus Hebd. Séances Acad. Sci. 182, 636 (1926).

DIAQUOTETRAAMMINECOBALT (III) SULFATE,

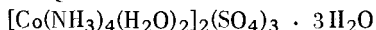

This is formed by treatment of $[\text{Co}(\text{NH}_3)_4\text{CO}_3]_2(\text{SO}_4)_3 \cdot 3\text{H}_2\text{O}$ with dil. H_2SO_4 .

A solution of 5 g. of pure $[\text{Co}(\text{NH}_3)_4\text{CO}_3]_2\text{SO}_4 \cdot 3\text{H}_2\text{O}$ in 100 ml. of cold H_2O and 10 ml. of dil. H_2SO_4 is prepared; this results in evolution of CO_2 . The clear solution is treated with 50-60 ml. of alcohol, added in small portions. The precipitate is filtered off, washed with 50% alcohol until free of acid, and dried in air. Yield: 6.2 g. (theoretical: 6.37 g.).

PROPERTIES:

Formula weight 668.45. Red quadratic prisms, which lose water of crystallization over conc. H_2SO_4 . Solubility at 22°C: 0.175 moles/liter of water.

REFERENCE:

S. M. Jørgensen. Z. anorg. Chem. 2, 296 (1892).

1,6-DICHLOROTETRAAMMINECOBALT (III) CHLORIDE (TRANS),

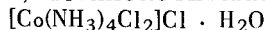

A solution of 10 g. of $[\text{Co}(\text{NH}_3)_4(\text{H}_2\text{O})_2]_2(\text{SO}_4)_3 \cdot 3\text{H}_2\text{O}$ in 50 ml. of cold conc. H_2SO_4 is prepared; the flask is allowed to stand for 24 hours, then placed in ice, and 50 ml. of conc. HCl is added dropwise with frequent and vigorous shaking. The *trans* salt separates in 48 hours. The flask is tilted and the mother liquor decanted as thoroughly as possible. Dilute HCl is then added; the precipitate is filtered off and washed with dil. HCl until free of H_2SO_4 , then washed with alcohol until free of acid. Yield: 7.25 g. (theoretical: 7.53 g.).

SYNONYM:

Formerly: Chloropraseocobalt chloride.

PROPERTIES:

Formula weight 251.46. Lustrous green crystals. d_{25}^{25} 1.860. Loses water of crystallization in 1-2 hours at 100°C. Solubility at 0°: 0.0141 moles/liter H₂O; hydration in solution, yielding [Co(NH₃)₄(H₂O)₂]Cl₃. The *trans* compound is more stable than the *cis* form.

REFERENCE:

S. M. Jørgensen. Z. anorg. Chem. 14, 404 (1897).

Triethylenediaminecobalt (III) Bromide

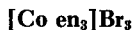

The preparation from cobalt salt, ethylenediamine and NaBr yields the racemate of the optically active forms of [Co en₃]Br₃ as the first product. The racemate can be resolved with tartaric acid into the *d*- and *l*-tartrate, and further converted to the *d*- and *l*-bromide.

A) RACEMIC TRIETHYLENEDIAMINECOBALT (III) BROMIDE,
[Co en₃]Br₃ · 3 H₂O

A solution of 10 g. of CoCl₂ · 6 H₂O in 150 g. of 10% aqueous ethylenediamine is prepared and oxidized by bubbling air through it for several hours. The brown solution is then acidified with HCl and concentrated until crystallization. The crystal mass is dissolved in H₂O and treated with NH₄NO₃, which precipitates 1,6-[Co en₂Cl₂]NO₃. This precipitate is removed by filtration; then NaBr is added to the filtrate, whereupon completely pure [Co en₃]Br₃ · 3 H₂O separates out.

PROPERTIES:

Formula weight 533.04. Small yellow needles. M.p. 271°; d_{4}^{25} 1.845. Solubility in H₂O at 16°C: 4.33 g. of anhydrous salt per 100 g. of solution.

B) RESOLUTION WITH TARTARIC ACID

A solution of 100 g. of [Co en₃]Br₃ in water is treated with the amount of silver tartrate (68.3 g.) needed for reaction with two atoms of bromine. After boiling, the AgBr precipitate is filtered off and then washed with boiling water until the water is no longer yellow. The filtrate and washings are combined and

concentrated. On chilling, the *d*-tartrate separates and is removed by filtration. The mother liquor is further concentrated and the additional precipitate of *d*-tartrate is removed. Cooling gels the solution to a mass of *l*-tartrate, still somewhat contaminated with *d*-tartrate.

C) *d*-TRIETHYLENEDIAMINECOBALT (III) BROMIDE TARTRATE

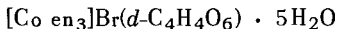

The *d*-tartrate crystals obtained in B are recrystallized from hot water. Rapid cooling yields needles with a silky luster; these disappear on standing for 1-2 hours in the mother liquor and are replaced by coarse platelike crystals.

PROPERTIES:

Formula weight 557.32. Small bright-yellow needles or dark-yellow platelets. Optical rotation (1% solution) $[\alpha]_{\text{D}} +98^\circ$, $[\text{M}]_{\text{D}} +555^\circ$.

D) *d*-TRIETHYLENEDIAMINECOBALT (III) BROMIDE,

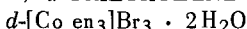

The $\textit{d}\text{-}[\text{Co en}_3]\text{Br}(\text{C}_4\text{H}_4\text{O}_6) \cdot 5\text{H}_2\text{O}$ obtained above is triturated with warm conc. HBr and the solution is filtered. On standing, large hexagonal tablets (acid bromide?) separate out; these are recrystallized from water to yield columnar crystals of the *d*-bromide.

PROPERTIES:

Formula weight 515.03. Yellow, columnar crystals. More readily soluble in H_2O than the racemic bromide. $d_{4}^{25} 1.971$. Optical rotation (1% solution): $[\alpha]_{\text{D}} + 117^\circ$; $[\text{M}]_{\text{D}} + 602^\circ$. Crystal-line form: ditetragonal-bipyramidal.

E) *l*-TRIETHYLENEDIAMINECOBALT (III) BROMIDE,



The gelatinous *l*-bromide tartrate is triturated with warm conc. HBr. The sparingly soluble racemic bromide tartrate which separates out is removed by filtration. On standing, the solution deposits crystals of *l*-bromide, which are recrystallized from hot water.

PROPERTIES:

Formula weight 515.03. Yellowish crystals. More readily soluble in H_2O than the racemic bromide. Optical rotation (1% solution): $[\alpha]_{\text{D}} -115^\circ$; $[\text{M}]_{\text{D}} -592^\circ$. Can be converted (with AgCl or AgNO_3) to the corresponding chloride or nitrate.

REFERENCE:

A-E: A. Werner. Ber. dtsh. chem. Ges. 45, 121 (1912).

Decaammine- μ -peroxocobalt (III) Cobalt (IV) Sulfate



The preparation involves oxidation of an ammoniacal solution of $\text{CoSO}_4 + (\text{NH}_4)_2\text{SO}_4$.

A mixture of 0.5 liter of 1 M $(\text{NH}_4)_2\text{SO}_4$, 1 liter of conc. ammonia, 1 liter of H_2O , 0.5 liter of 1 M CoSO_4 , 0.5 liter of 1 M H_2O_2 and 0.5 liter of 1 M $(\text{NH}_4)_2\text{S}_2\text{O}_8$ is prepared in the indicated sequence, the solutions being added at approximately 10-second intervals. The mixture is vigorously agitated after each addition. After all additions have been completed it is allowed to stand for 10-15 minutes. Most of the supernatant liquid is siphoned off; the precipitate is filtered off, washed first with dil. ammonia and then with alcohol and suction-dried. The crude product (50-70 g.) is dissolved as rapidly as possible in 1250-1750 g. of 2 N H_2SO_4 (heating to 80-85°C is necessary). The solution is filtered at once and allowed to stand one day. The yield is 30-50 g. of pure product.

ANALYSIS:

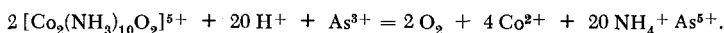

The product, in the sulfuric acid solution, is reduced with As^{3+} ; the evolving O_2 is collected in an azotometer over strong KOH by means of CO_2 . An aliquot of the solution is used to back-titrate the excess As^{3+} with $\text{Ce}(\text{SO}_4)_2$ and ferroin; another aliquot is used to determine Co by precipitation with 8-hydroxyquinoline and titration with KBrO_3 .

PROPERTIES:

Formula weight 663.45. Grayish-black, lustrous prisms. Almost insoluble in cold dil. sulfuric acid; more soluble at 50-60°C.

REFERENCE:

K. Gleu and K. Rehm. Z. anorg. allg. Chem. 237, 79 (1938).

Sodium Hexanitrocobaltate (III)

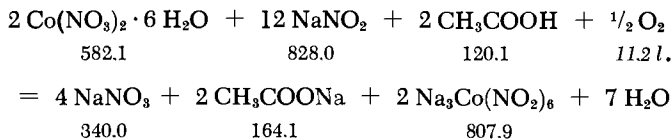
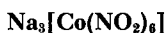

A solution of 150 g. of NaNO_2 in 150 ml. of H_2O is cooled to 50–60°C; some of the NaNO_2 is thus reprecipitated. Then 50 g. of $\text{Co}(\text{NO}_3)_2 \cdot 6 \text{H}_2\text{O}$ is added, followed by 50 ml. of 50% CH_3COOH in small portions (agitation). Then a fast stream of air is bubbled through for one half hour. After standing for two hours, the brown precipitate is filtered off. The filtrate must be clear at this point. The precipitate is stirred with 50 ml. of H_2O at 70–80°C. The solution is separated from undissolved $\text{K}_3[\text{Co}(\text{NO}_2)_6]$ on a small filter and combined with the above-mentioned clear filtrate. The combined solution (about 300 ml.) is treated with 250 ml. of 96% alcohol. The resulting precipitate is allowed to settle for about two hours, then filtered, suction-dried, washed four times with 25 ml. of alcohol, then twice with ether, and dried in air. Yield: 50–53 g. (75%).

Reprecipitation with alcohol is desirable. The pure preparation must give a perfectly clear solution in H_2O . To precipitate the salt, the alcohol is added from a wash bottle; during the addition, the flask is vigorously shaken to insure that the particle size of the precipitate will not be too small.

SYNONYM:

Sodium cobaltinitrite.

PROPERTIES:

Yellow crystalline powder. Very soluble in water, sparingly soluble in alcohol and ether. The aqueous solution is not stable and forms HNO_2 and HNO_3 . Crystal structure: J2_1 type (cubic).

REFERENCE:

E. Bijlman. *Z. analyt. Chem.* **39**, 284 (1900).

Potassium Hexacyanocobaltate (III)

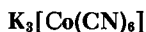

The intermediate $\text{K}_4[\text{Co}(\text{CN})_6]$ is prepared from $\text{Co}(\text{CN})_2$ and KCN. Boiling of its solution precipitates $\text{K}_3[\text{Co}(\text{CN})_6]$.

A clear, filtered solution of 48 g. of $\text{CoCl}_2 \cdot 6 \text{H}_2\text{O}$ in 500 ml. of H_2O is heated to boiling, and a clear solution of 30 g. of KCN

in 200 ml. of H_2O is added dropwise with vigorous stirring. Before adding the final portions of the KCN, a sample of the solution is filtered and the filtrate is treated with a drop of KCN solution, in order to establish whether any $CoCl_2$ is still present in the solution. The violet-red precipitate of $Co(CN)_2$ is filtered off, washed with cold H_2O , and dissolved while still moist in a conc. solution of 60 g. of KCN. The deep red solution of $K_4[Co(CN)_6]$ is heated to boiling for 10-15 min., whereupon it becomes yellow and evolves H_2 . If a small quantity of yellow $K_3[Co(CN)_6]$ crystallizes at this time, some water is added to redissolve it. The boiling solution is filtered and cooled. The $K_3[Co(CN)_6]$ precipitate is collected on a filter and washed with some cold water. Further quantities of the precipitate are obtained by concentrating the mother liquor to half its volume; this solid is worked up as above. The combined precipitates are recrystallized twice from hot water, some activated carbon being added to the solution. The pure, almost colorless crystals are filtered off and washed with some cold water. They must give a clear water solution.

The small excess of KCN called for in the directions for preparing the solution of $Co(CN)_2$ in KCN prevents the precipitation of green $K_2Co[Co(CN)_6]$, which is insoluble at room temperature.

Alternate method: Oxidation of $CoCl_2 \cdot 6H_2O + KCN$ in acetic acid solution with air, and several reprecipitations from acetic acid solution with alcohol [W. Biltz, W. Eschweiler and A. Bodensiek, Z. anorg. allg. Chem. 170, 161 (1928)].

SYNONYM:

Potassium cobalt (III) hexacyanide.

PROPERTIES:

Formula weight 332.35. Small, almost colorless needles with a yellowish tinge. d_4^{25} 1.878. Readily soluble in water; solubility in 87-88% alcohol (20°C): 1:7500 parts. Decomposes on heating in absence of air. Crystalline form: monoclinic, isomorphic with $K_3Fe(CN)_6$.

REFERENCE:

A. Benedetti-Pichler. Z. anal. Chem. 70, 257 (1927).

Hexacyanocobaltic (III) Acid

$H_3Co(CN)_6$

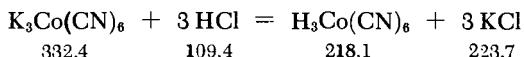

A solution of 3 g. of $K_3Co(CN)_6$ in 9 ml. of H_2O is treated with 9 g. of conc. HCl. The KCl precipitate is removed by filtration.

The solution is sensitive to light.

SYNONYM:

Hydrogen hexacyanocobaltate (III).

REFERENCE:

A. von Baeyer and V. Villiger. Ber. dtsch. chem. Ges. 34, 2687 (1901).

$\text{H}_3\text{Co}(\text{CN})_6 \cdot 5 \text{H}_2\text{O}$

A very small excess of H_2SO_4 (d 1.84) is added to a 25% aqueous solution of $\text{K}_3\text{Co}(\text{CN})_6$, which is then heated for 15-20 minutes to 50-55°C and cooled. Absolute alcohol is added and the alcohol-insoluble K_2SO_4 is removed by filtration. The solution is carefully concentrated at 50-55°C and the $\text{H}_3\text{Co}(\text{CN})_6 \cdot 5 \text{H}_2\text{O}$ thus formed is recrystallized three times from alcohol.

PROPERTIES:

Colorless crystalline needles; hygroscopic. Heating at 100°C yields white $\text{H}_3\text{Co}(\text{CN})_6 \cdot 0.5 \text{H}_2\text{O}$. At higher temperatures, colored products are formed until finally a black cobalt carbide remains. Not altered by brief boiling with HCl or HNO_3 , but forms $\text{Co}_3\text{-}[\text{Co}(\text{CN})_6]_2$ in hot H_2SO_4 (d 1.84).

REFERENCE:

O. K. Dobrolyubskiy. Zh. Prikl. Khimii 26, 1185, 1233 (1953).

Metallic Nickel

SABATIER METHOD

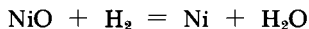

74.7 22.41. 58.7

Very pure, O_2 -free H_2 dried over P_2O_5 is passed for 15 hours over NiO [obtained by thermal decomposition of $\text{Ni}(\text{NO}_3)_2 \cdot 6 \text{H}_2\text{O}$] at 300-400°C. After cooling in the H_2 stream, the air-sensitive metal is transferred to small glass bulbs attached to the apparatus, and these are sealed off. The metal powder may also be stored in bottles under alcohol.

Used as hydrogenation catalyst.

PROPERTIES:

Atomic weight 58.71. Black metallic powder; pyrophoric. M. p. 1453°C, b.p. 3177°C. Ferromagnetic. Soluble in dil. HNO₃, passivated by conc. HNO₃.

REFERENCE:

P. Sabatier. *Die Katalyse in der organischen Chemie* [Catalysis in Organic Chemistry], translated into German and enlarged by B. Finkelstein and H. Häuber, Leipzig, 1927.

Nickel (II) Chloride

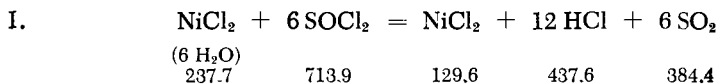

Water is removed by refluxing with SOCl₂ as described for CoCl₂.

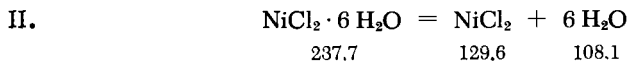

The starting NiCl₂ · 6 H₂O is dried in a combustion tube at 150°C; the final heating to 400°C proceeds in a stream of Cl₂-containing HCl. After the yellow NiCl₂ has formed, the tube is sealed at one end and the product is sublimed (oil-pump vacuum) at the highest temperature that the tube can withstand. To remove HCl, the NiCl₂ is annealed in high vacuum over KOH at 160°C.

Alternate methods: a) Heating of NiCl₂ · 6 H₂O in a sealed tube with COCl₂ at 200°C (Hecht).

b) The frequently recommended thermal decomposition of NiCl₂ · 6 NH₃ does not yield pure NiCl₂, since black by-products are formed.

c) Treatment of Ni(CH₃COO)₂ · 4 H₂O with CH₃COCl in benzene, analogous to the preparation of CoCl₂ [G. W. Watt, P. S. Gentile and E. P. Helvenston, *J. Amer. Chem. Soc.* 77, 2752 (1955)].

PROPERTIES:

Bright-yellow powder or crystalline leaflets (like mosaic gold). Subl. 993°C (760 mm.); m. p. 1001°C (in sealed tube); d₄²⁵ 3.521. Heat of formation: -73.0 kcal./mole (25°C). Sublimed NiCl₂ is

relatively stable and takes up water slowly; fine NiCl_2 powder is hygroscopic and becomes green in air. Solubility in H_2O (g. $\text{NiCl}_2/100$ g. solution): 34.8 (0°C); 40.4 (26.3°C); 46.7 (100°C). Moderately soluble in methyl and ethyl alcohol. Crystal structure: C 19 type.

REFERENCES:

- I. H. Hecht. Z. anorg. Chem. 254, 51 (1947).
 II. W. Biltz and E. Birk. Z. anorg. allg. Chem. 127, 34 (1923).

Hexaamminenickel (II) Chloride

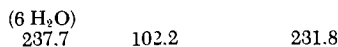
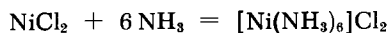

A conc. solution of cobalt-free $\text{NiCl}_2 \cdot 6 \text{H}_2\text{O}$ is treated with excess conc. NH_3 , then cooled in running water. The separation of fine crystals of $[\text{Ni}(\text{NH}_3)_6]\text{Cl}_2$ is completed by addition of an ammoniacal NH_4Cl solution. The precipitate is filtered off and successively washed with conc. ammonia, alcohol and ether.

Alternate methods: Action of NH_3 on anhydrous NiCl_2 at room temperature [F. Ephraim, Z. phys. Chem. 81, 513 (1913)].

PROPERTIES:

Blue-violet, fine crystalline powder. d_4^{25} 1.468. Heat of formation: -16.3 kcal./mole. The decomposition pressure at 176.5°C is 1 atm. Decomposes in H_2O , liberating NH_3 . Soluble in aqueous ammonia; not soluble in conc. ammonia or alcohol. Crystal structure: J 1₁ type.

REFERENCE:

- S. P. L. Sørensen. Z. anorg. Chem. 5, 354 (1894).

Nickel (II) Bromide

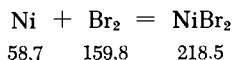
ANHYDROUS NiBr_2 

Nickel powder, produced by heating NiCl_2 in a hydrogen stream at 400°C , is covered with a layer of completely dry ether and then

treated with dry bromine. After 12 hours the ether is removed and the residue heated in vacuum at 130°C. In order to purify the preparation, which still contains some Ni, it is sublimed at 900°C (quartz or porcelain tube) in a CO₂-free stream of N₂ + HBr.

Alternate methods: a) Heating of NiCl₂ in a stream of HBr at 500°C (G. Crut).

b) Heating of NiBr₂ · 6 H₂O at 140°C in a drying oven [J. A. A. Ketelaar, Z. Kristallog. 88, 26 (1934)].

c) Reaction of Ni(CH₃COO)₂ · 4 H₂O with CH₃COBr in benzene, analogous to the preparation of CoCl₂ [G. W. Watt, P. S. Gentile and E. P. Helvenston, J. Amer. Chem. Soc. 77, 2752 (1955)].

PROPERTIES:

Yellow powder or bronze-yellow micalike particles. M. p. 963° (in sealed tube); d_4^{25} 5.018. Heat of formation: -51.8 kcal. per mole (25°). Solubility in H₂O (g. NiBr₂/100 g. solution): 56.6 (19°C); 61.0 (100°C). Soluble in methyl and ethyl alcohols, acetone and quinoline; insoluble in toluene. Crystal structure: sublimed product, C 19 type; unsublimed product, variable between C 6 and V 19 types.

REFERENCE:

G. Crut. Bull. Soc. Chim. France [4] 35, 550 (1924).

NiBr₂ · 6 H₂O

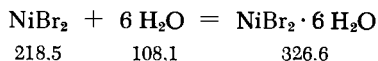

A solution of NiBr₂ in water is concentrated until crystallization begins and is then cooled. The crystals are filtered off and recrystallized from alcohol.

Alternate method: Precipitated nickel carbonate or Ni(OH)₂ is dissolved in aqueous HBr, concentrated on the steam bath, and the product recrystallized from alcohol [J. A. A. Ketelaar, Z. Kristallog. 88, 26 (1934)].

PROPERTIES:

Green crystals; transform to NiBr₂ · 3 H₂O at +28.5°C.

REFERENCE:

See G. L. Clark and H. K. Bruckner. J. Amer. Chem. Soc. 44, 230 (1922).

Nickel (II) Iodide

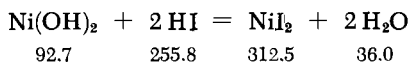
ANHYDROUS NiI₂

Either Ni(OH)₂ or precipitated nickel carbonate is dissolved in hydriodic acid and the solution evaporated to dryness. The solid is recrystallized from alcohol and dried at 140°C. A final sublimation in high vacuum at 500-600°C is recommended.

Alternate method: Dehydration of NiI₂ · 6 H₂O (Riedel, Thesis, Univ. of Halle, 1913).

PROPERTIES:

Black solid; forms small lustrous crystals when sublimed. M.p. 797°C (in sealed tube); d_4^{25} 5.834. Heat of formation; -41.40 kcal./mole. Decomposes when heated to high temperatures in air. Hygroscopic; rapidly forms a green solution when exposed to air. Solubility in H₂O (g. NiI₂/100 g. solution): 57.8 (11°C); 64.1 (43°C); 65.7 (90°C). Aqueous solutions of NiI₂ can dissolve up to two atoms of iodine, thereby acquiring a brown color. Dilute solutions are pure green, concentrated solutions dirty green or reddish brown. Slowly soluble in cold absolute alcohol, rapidly in hot. Crystal structure: C 19 type.

REFERENCE:

J. A. A. Ketelaar. Z. Kristallogr. 88, 26 (1934).

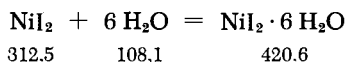
NiI₂ · 6 H₂O

A solution of NiI₂ in H₂O is evaporated to a sirup. The crystals of NiI₂ · 6 H₂O are filtered off and suction-dried.

Alternate method: As in the case of NiI₂, but without the dehydration at 140°C [J. A. A. Ketelaar, Z. Kristallogr. 88, 26 (1934)].

PROPERTIES:

Blue-green crystals; rapidly deliquescent in air, becoming brown and giving off iodine. Exists up to 43°C; becomes anhydrous when heated on steam bath.

REFERENCES:

- O. Erdmann. J. prakt. Chem [1] 7, 254(1936); A. Étard. Ann. Chim. Phys. [7] 2, 503 (1894).

Nickel (II) Oxide

NiO

Prepared by thermal decomposition of nickel salts of volatile acids.

I. Precipitated nickel carbonate or $\text{Ni}(\text{NO}_3)_2 \cdot 6\text{H}_2\text{O}$ is heated in a Pt crucible for six hours at 1000-1100°C and allowed to cool in O_2 -free nitrogen.

On cooling in air, a surface skin forms, which can be removed by postreduction with pure H_2 at 100°C.

Test for active oxygen is essential.

II. Precipitated nickel carbonate is placed in a pear-shaped decomposition vessel, the air is displaced several times with O_2 -free nitrogen, and the entire apparatus is degassed in high vacuum at 100°C. After high vacuum is established, the system is heated, over a period of 90 minutes, to 350°C. The product is transferred to previously prepared storage bulbs, which are then sealed.

The oxide blackens immediately in the presence of air. Test for active oxygen is essential.

Alternate method: Small chips of nickel are heated in air at 1000°C (for procedure, see method II, subsection on Cu_2O) [H. H. von Baumbach and C. Wagner, Z. phys. Chem. (B) 24, 61 (1934)].

Used as oxidation catalyst.

PROPERTIES:

Formula weight 74.71. M. p. 1990°C; d 6.67. Heat of formation: -58.4 kcal./mole. Bright-yellow powder, brown when heated. When the oxygen content is in slight excess, the color is dark olive green, becoming darker as the oxygen content increases. NiO prepared at high temperatures is almost insoluble in acids and alkalis; the lower the temperature of preparation, the more soluble it is, especially in hot nitric acid and ammonia. Crystal structure: B1 type.

REFERENCE:

- M. Le Blanc and H. Sachse. Z. Elektrochem. 32, 58(1926).

Nickel (III) Hydroxide

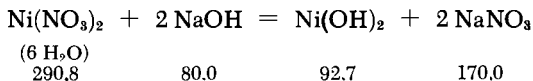

A solution of 25 g. of KOH in 250 ml. of carbonate-free H₂O is added dropwise and with vigorous stirring to a warm (about 35°C) solution of 60 g. of Ni(NO₃)₂ · 6 H₂O in 250 ml. of H₂O. The precipitate is washed by decantation with several five-liter portions of warm, CO₂-free H₂O (until the washings are no longer alkaline), then once with five liters of CO₂-free H₂O containing some ammonia, and finally with similar portions of warm, CO₂-free water until both precipitate and washings are free of K⁺ and NO₃⁻. The precipitate is filtered off and dried in a vacuum desiccator over conc. H₂SO₄.

The preparation still contains about one mole of adsorptively bound water, which can be removed by heating to 200°C.

Precipitation, decantation and filtration are carried out in the absence of CO₂. Another suitable starting material is Ni(NO₃)₂ · 6 NH₃; however, NiCl₂ · 6 H₂O and NiSO₄ · 7 H₂O are not recommended, since the precipitate then tenaciously retains Cl⁻ and SO₄²⁻.

PROPERTIES:

Apple-green crystalline powder; d 3.65. Decomposes at 230°C into NiO and H₂O. Soluble in ammonia, ethylenediamine and acids. Crystal structure: C 6 type. Heat of formation: -62.68 kcal./mole.

REFERENCE:

G. F. Hüttig and A. Peter. Z. anorg. allg. Chem. 189, 183 (1930).

β-Nickel (III) Hydroxide

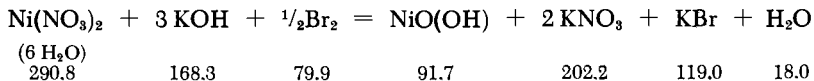

A solution of 100 g. of Ni(NO₃)₂ · 6 H₂O in 1500 ml. of H₂O is added dropwise and with vigorous stirring to a solution of 55 g. of KOH and 12 ml. of Br₂ in 300 ml. of H₂O. The precipitation temperature should not exceed 25°C. The precipitate is washed

five times (decantation) with CO_2 -free H_2O , then several times (decantation) using a centrifuge, until NO_3^- and K^+ can no longer be detected in either the precipitate or the wash water. The wet product is dried for three days over conc. H_2SO_4 , then two weeks over 1:1 H_2SO_4 .

Precipitation, decantation and filtration must be carried out in a CO_2 -free atmosphere.

Tests for active oxygen, Ni, H_2O and CO_2 are necessary. The oxygen and H_2O contents vary. In view of the rapid conversion to $\text{Ni}_3\text{O}_2(\text{OH})_4$, it is advisable to work up the precipitate as quickly as possible.

To determine active oxygen, a 100-mg. sample is covered with 100 ml. of H_2O , and 1 g. of KI and 25 ml. of 2 N H_2SO_4 are added. The liberated I_2 is titrated with $\text{Na}_2\text{S}_2\text{O}_3$.

Alternate method: A solution of $\text{Ni}(\text{NO}_3)_2 \cdot 6\text{H}_2\text{O}$ is treated with sodium acetate and electrolyzed at room temperature. The low yield is a disadvantage of this method [O. Glemser and J. Einerhand (1950)].

PROPERTIES:

Black powder. d_4^{20} 4.15. Readily soluble in acids. Rapidly converted to $\text{Ni}_3\text{O}_2(\text{OH})_4$ by H_2O and bases. Loses water when heated in vacuum and is converted to $\text{Ni}_3\text{O}_2(\text{OH})_4$. Crystal structure: C 6 type.

REFERENCES:

- G. F. Hüttig and A. Peter. *Z. anorg. allg. Chem.* **189**, 190 (1930);
O. Glemser and J. Einerhand. *Z. anorg. Chem.* **261**, 26 (1950).

γ -Nickel (III) Hydroxide



Metallic Ni is fused with $\text{Na}_2\text{O}_2 + \text{NaOH}$ and the melt is extracted with H_2O .

A crucible of pure nickel is filled to one third of its volume with a mixture of one part of Na_2O_2 and three parts of NaOH, and heated for four hours at 600°C . The melt is cooled, then carefully extracted with ice water, avoiding any rise in temperature. Washing by decantation with H_2O is carried out until there no longer is an alkaline reaction. The tiny crystals settle very easily; the flocculent precipitate is removed by slurring.

Tests for active oxygen [see under β -NiO(OH)], Ni, and H_2O are necessary.

Used as an oxidation catalyst.

PROPERTIES:

Small, lustrous, black hexagons or needles. d_4^{20} 3.85. Soluble in dil. H_2SO_4 with evolution of O_2 . Decomposes on heating to 138-140°C. Crystal structure: resembles C 19 type.

REFERENCE:

O. Glemser and J. Einerhand. Z. anorg. Chem. 261, 26 (1950).

Nickel (II,III) Hydroxide



The precipitation of $Ni_3O_2(OH)_4$ is carried out by dropwise addition of a solution of $Ni(NO_3)_2 \cdot 6H_2O$ to aqueous $KOH + Br_2$ at 50°C (as described under β - $NiO(OH)$). The product is washed by decantation with warm, CO_2 -free H_2O . All operations are conducted in a CO_2 -free atmosphere.

Tests for active oxygen: see under β - $NiO(OH)$. Analysis for Ni and H_2O is recommended. Water and oxygen contents vary.

Used as an oxidation catalyst.

Alternate method: Electrolysis (50-60°C) of a solution of $Ni(NO_3)_2$ treated with sodium acetate. The low yield is a disadvantage of this method (O. Glemser and J. Einerhand, see reference below).

PROPERTIES:

Formula weight 276.16. Black powder. d_4^{20} 3.33. Readily soluble in acids. On heating to 140°C, converts to NiO , H_2O and O_2 . Crystalline form: hexagonal.

REFERENCES:

O. Glemser and J. Einerhand. Z. anorg. Chem. 261, 26 (1950).

Nickel (II) Sulfide



α -NiS

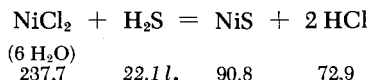

The apparatus used for precipitation of nickel sulfides in the absence of air is shown in Fig. 335. The α -NiS is prepared

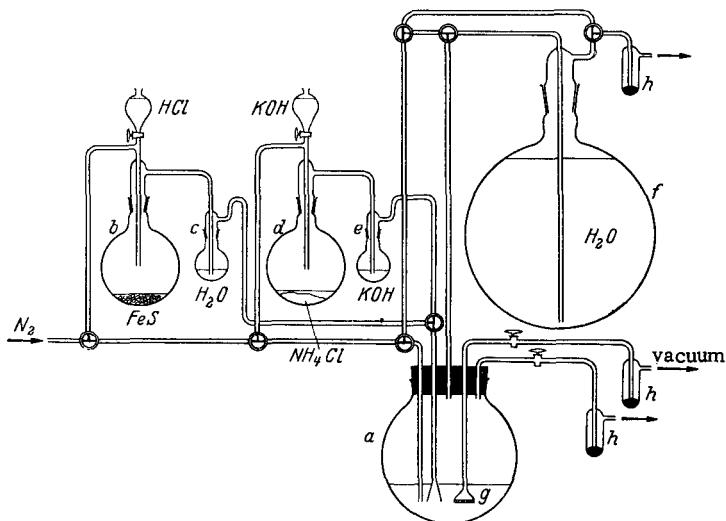

Fig. 335. Preparation of nickel sulfides in the absence of air.

as follows. The air is displaced from the apparatus by a stream of CO_2 -free, O_2 -free nitrogen. At the same time, all liquids in the apparatus are boiled and allowed to cool in the N_2 stream. These liquids comprise the solution in *a*, which is 0.4 N in NiCl_2 and 0.8 N in NH_4Cl ; the water in *b*, which covers the chunks of FeS ; the water in wash bottle *c*; the saturated NH_4Cl , with excess of solid NH_4Cl , in *d*; the conc. KOH in the bubble-counting tube *e*; and the wash water in *f*. The mercury trap *h* serves to prevent the entrance of air into the reactor. Now CO_2 -free H_2S is generated in *b*, and the sulfide precipitates in *a*. The wash water is transferred into *a* (N_2 pressure), shaken with the precipitate, and (after the latter has settled) drawn off through fritted disc *g*, using a vacuum pump. The washing procedure is repeated 15-20 times.

The NiS should not be completely precipitated from the solution, otherwise it does not settle well during washing.

PROPERTIES:

Black powder, soluble in HCl . Converts to $\text{Ni}(\text{OH})\text{S}$ in air. Amorphous on x-ray analysis. Heat of formation: -19.37 kcal./mole.

REFERENCE:

E. Dönges. *Z. anorg. Chem.* **253**, 345 (1947).

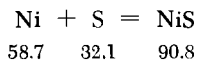
β -NiS

A stoichiometric mixture of Ni and S is heated for six hours at 900°C in a sealed, evacuated quartz tube.

Alternate methods: a) Precipitation with H₂S from a 1 N NiCl₂ solution containing acetic acid, workup as for α -NiS [A. Thiel and H. Gessner, Z. anorg. Chem. **86**, 1 (1914)].

b) The alpha form of NiS is digested with 0.2 N acetic acid for several days in the absence of air (A. Thiel and H. Gessner, see above).

PROPERTIES:

Black powder. M.p. 810°; d 5.0-5.6. Dissolves rapidly on boiling in 2 N HCl. Crystal structure: B8 type.

REFERENCE:

W. Klemm and W. Schüth. Z. anorg. allg. Chem. **210**, 39 (1933).

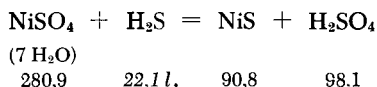
 γ -NiS

The apparatus shown for α -NiS is used and H₂S is bubbled through 1 N NiSO₄ solution weakly acidified with dil. H₂SO₄. Air must be rigorously excluded during the reaction. The precipitate is worked up in the same way as α -NiS.

PROPERTIES:

Black powder. d₄³⁰ 5.34. Converts to β -NiS at 396°C. Crystal structure: B13 type.

REFERENCE:

R. G. Levi and A. Baroni. Z. Kristallogr. **92**, 210 (1935).

DRYING OF PRECIPITATED NiS

The slurry of the sulfide is dried in a drying pistol for eight hours (aspirator vacuum); the temperature is slowly raised to 150°C. Then NaOH is placed in the drying pistol and the material is dehydrated for four additional hours at 180°C in an oil-pump vacuum.

The sulfide is then transferred to another small flask and dried for 5-12 hours at 300-400°C (high vacuum). The latter operation must be carried out with care, to avoid dusting of the product.

REFERENCES:

W. Biltz. Z. anorg. allg. Chem. 228, 275 (1936); 239, 82, 126 (1938).

Nickel (IV) Sulfide

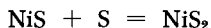

90.8	32.1	122.8
------	------	-------

Completely dry NiS is heated in a sealed tube with triple distilled S (five hours at 450°C). Four to five times the stoichiometric amount of S is used. After the reaction is complete, the excess S is removed by extraction with CS₂ in a Soxhlet apparatus.

Test for S: The sulfide is dissolved in HNO₃, and BaCl₂ is added to cause precipitation.

PROPERTIES:

Black to gray powder. d 4.39. Sensitive to air even when dry, evolving SO₂, which remains partly adsorbed. Can incorporate S into the crystal lattice. Soluble in nitric acid. Crystal structure: C2 type.

REFERENCES:

W. F. deJong and H. W. V. Willems. Z. anorg. allg. Chem. 160, 185 (1927); W. Biltz. Ibid. 228, 278 (1936).

Nickel (II) Amide



174.9	110.2	90.8	194.4
-------	-------	------	-------

The apparatus shown in Fig. 334 [see subsection on Co(NH₂)₃] is charged with an excess of dry Ni(SCN)₂. Then a solution of KNH₂ in liquid NH₃ is added. A flocculent red precipitate forms; this is washed with liquid NH₃ until peptization just starts. The product is transferred to an auxiliary apparatus (as in the procedure on p. 1527) and dried in high vacuum at 40°C.

Used for the preparation of Ni₃N₂.

PROPERTIES:

Red powder. Reacts mildly with H_2O to form $Ni(OH)_2$ and NH_3 . Decomposes when heated in vacuum to $120^\circ C$.

REFERENCE:

G. S. Bohart. J. Phys. Chem. 19, 537 (1915).

Trinickel Dinitride

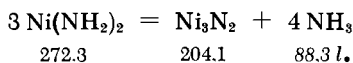

Nickel (II) amide (see preceding preparation) is heated in vacuum at $120^\circ C$; NH_3 is slowly evolved and Ni_3N_2 is formed. Some N_2 is also produced in a side reaction.

Alternate method: A mixture of 10 parts of NiO and 7.4 parts of completely anhydrous $Ni(CN)_2$ is fused in an electric arc surrounded by pure N_2 [A. C. Vournasos. Comptes Rendus Hebd. Séances Acad. Sci. 163, 889 (1919)].

PROPERTIES:

Black powder. Reacts very slowly with water. Decomposes to Ni and N_2 above $120^\circ C$. Alkalies liberate NH_3 .

REFERENCE:

G. S. Bohart. J. Phys. Chem. 19, 537 (1915).

Trinickel Nitride

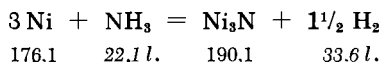

An alumina boat is charged with 20 mg. of nickel obtained from $Ni(CO)_4$. The boat is heated for three hours at $445^\circ C$ in a reaction tube through which flows a stream of NH_3 (22 cm./sec.). The preparation is cooled in the NH_3 stream, ground carefully in an agate mortar, and allowed to react with NH_3 once more under the same conditions.

The test for N in the product may be made by the micro-Kjeldahl method.

PROPERTIES:

Black-gray powder. d_4^{25} 7.66. Unaffected by moisture and O_2 . Dissolved slowly by dil. mineral acids in the cold, rapidly by conc. HCl and conc. HNO_3 . Dissolved rapidly by all hot acids. Not attacked by aqueous NaOH. Crystal structure: hexagonal close packing of Ni atoms, oriented incorporation of N.

REFERENCE:

R. Juza and W. Sachse. Z. anorg. allg. Chem. 251, 201 (1943).

Nickel Carbide

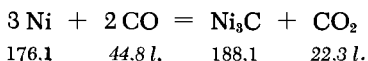

Pure NiO is reduced with pure H_2 at 275-285°C until constant weight. The fine Ni powder is heated at once with pure CO (completely free of O_2) for 260 hours at 270°C. The Ni_3C thus produced is pyrophoric. This may be remedied by heating for a long time in O_2 -free nitrogen at 250°C and cooling in the N_2 stream.

Test for bound C: Heating with pure H_2 at 250-270°C evolves C as CH_4 .

PROPERTIES:

Gray-black powder. d_4^{25} 7.97. Heat of formation: -9.2 kcal. per mole. Decomposed at room temperature by conc. and dil. HCl; precipitation of C does not occur (see Fe_3C). Soluble in dil. HNO_3 ; dil. H_2SO_4 causes separation of C. Stable at temperatures up to 380-400°C. Crystal structure: hexagonal close packing of Ni atoms.

REFERENCE:

H. A. Bahr and Th. Bahr. Ber. dtsch. chem. Ges. 61, 2177 (1928).

Nickel (II) Carbonate



Prepared by electrolysis of CO_2 -saturated H_2O with nickel electrodes.

An electrolysis cell ($20 \times 15 \times 20$ cm.) is covered with a wooden lid from which three pieces of nickel sheet electrodes ($20 \times 12.7 \times 0.05$ cm.) are suspended. Two of the electrodes are placed at the sides of the vessel and are interconnected; the third is in the center and serves as the anode. The cell is filled with conductivity water to 2.5 cm. below the top, pure CO_2 is bubbled through, and the current is turned on and controlled at 2-2.2 amp. The cell is cooled externally with running water. The $\text{NiCO}_3 \cdot 6\text{H}_2\text{O}$ drops to the bottom. It is filtered off and dried at 100°C . The yield is about 30 g./day.

PROPERTIES:

Formula weight 226.82. Pale-green rhombohedra or monoclinic prisms. Readily soluble in acids. The product prepared in the above manner is free of alkali, but contains some black hydroxide.

REFERENCE:

E. C. C. Baly and N. R. Hood. Proc. Roy. Soc. London 122, 313 (1929).

NiCO_3

Anhydrous NiCO_3 exists in two forms, one green (I) and one yellow (II).

GREEN FORM (I):

A solution of 0.12 moles of NiCl_2 in 100 ml. of water is acidified with HCl and charged into an autoclave. At 250°C and a CO_2 pressure of 1700 p.s.i., a solution of 0.18 moles of NaHCO_3 in 100 ml. of water is added dropwise. Green, crystalline NiCO_3 precipitates. Yield: 25-30%.

YELLOW FORM (II):

The yellow NiCO_3 forms under the same conditions as the green, but at a temperature of 180°C and from very conc. solutions (0.22 moles of NiCl_3 in 25 ml. of water and 0.38 moles of NaHCO_3 in 100 ml. of water). The yield is poor. At lower temperatures only colloidal products are obtained; at temperatures between 180° and 250°C a mixture of I and II is produced.

PROPERTIES:

The green form consists of microscopically small, transparent, doubly refracting green rhombohedra; it is not attacked by warm

conc. acids or by boiling water. The habit and physical and chemical properties of II are the same as those of I. On heating to approximately 400°C, both carbonates decompose to CO₂ and green NiO. Both crystallize as rhombohedra.

REFERENCE:

R. de St. Léon Langlés. *Ann. Chimie* 7, 568 (1953).

Nickel (II) Thiocyanate



Prepared by dissolving Ni(OH)₂ in a dilute HNCS solution and evaporating the resulting solution of Ni(SCN)₂.

A dilute HNCS solution is saturated with Ni(OH)₂ or nickel carbonate and the deep-green solution is evaporated at about 15°C. Large green crystals of Ni(SCN)₂ · 4H₂O are deposited. Above 15°C and on drying of Ni(SCN)₂ · 4H₂O, a yellow powder of Ni(SCN)₂ · 0.5H₂O is obtained. It can be rendered anhydrous by heating to 150°C.

PROPERTIES:

Formula weight 174.88. Dark chocolate-colored powder. On addition of water, becomes first yellow and then dissolves with a green color.

REFERENCES:

A. Rosenheim and R. Cohn. *Z. anorg. Chem.* 27, 280 (1901); *Ber. dtsch. chem. Ges.* 33, 1111 (1901); A. de Sweemer. *Natuurwetensch. Tijdschr.* 14, 231 (1932).

Di- μ -sulfido-tetrakis(dithiobenzoato)dinickel (IV)

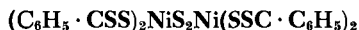

This nickel (IV) complex compound is obtained by oxidation of the corresponding nickel (II) complex compound with O₂.

An alcoholic solution of 1 mmole (0.13 g.) of NiCl₂ is treated with an alcoholic solution of 12 mmoles (0.15 g.) of monothio-benzoic acid and 6 mmoles (0.24 g.) of NaOH. The clear yellow-brown solution (in which the Ni is present as [Ni(SCOC₆H₅)₄]²⁻) is refluxed at 50°C, and at the same time a gentle stream of O₂ is introduced. The oxidation is shown by a change in color, first to red and then to violet. The reaction is complete in about four

hours. The dark-violet compound is filtered off, washed with alcohol and water, and recrystallized from benzene.

PROPERTIES:

Formula weight 794.55. Tuft-shaped aggregates of dark-violet crystals. May be recrystallized from benzene, alcohol, ether and CS_2 . Very stable to acids and bases; decomposed only by oxidizing acids.

REFERENCE:

W. Hieber and R. Brück. Z. anorg. allg. Chem. 269, 26 (1952).

Potassium Tetracyanonickelate (II)

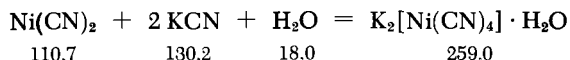
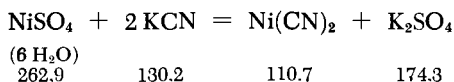

A solution of 60 g. of $\text{NiSO}_4 \cdot 6 \text{H}_2\text{O}$ in 200 ml. of water is prepared, and a solution of 29.7 g. of KCN in 70 ml. of water is added slowly, with constant stirring. The gray-green precipitate of $\text{Ni}(\text{CN})_2$ is washed until free of sulfate and then filtered off.

The solid $\text{Ni}(\text{CN})_2$ is placed in a solution of 29.2 g. of KCN in about 30 ml. of water. The solution, which is now red, is heated on a hot plate until small crystals appear. These are redissolved and the solution is allowed to cool. The compound precipitates as beautiful crystals. The yield is 57.4 g. (97%).

SYNONYM:

Potassium nickel (II) cyanide hydrate.

PROPERTIES:

Orange-red crystals. The water of hydration is completely removed by heating to 100°C. Very soluble, even in cold water; decomposed to $\text{Ni}(\text{CN})_2$ by mineral acids. Forms black precipitates of higher nickel hydroxides on addition of hypobromites.

REFERENCE:

W. C. Fernelius and J. J. Burbage in: W. C. Fernelius, Inorg. Syntheses, Vol. II, New York-London, 1946, p. 227.

The Platinum Metals

H. L. GRUBE

Pure Platinum

Pt

Platinum obtained from Russian or Colombian platinum ores or by industrial recovery processes contains the other platinum metals as impurities, as well as gold, iron and copper.

The following methods are recommended for its purification: the lead fusion process, based on the analytical procedures of Saint-Claire-Deville and Stas, and the caustic soda precipitation of Schneider [1] and Seubert [2], in which all the platinum metals except Pt pass into their lower oxidation states, which are not precipitated by NH_4Cl . There is also the Finkener process, based on recrystallization of Na_2PtCl_6 from dilute soda solutions; this has been described by Mylius and Förster [3]. However, this method leads to poor yields because of the low solubility of Na_2PtCl_6 . A process by Reerink [4] makes use of platinum's ability to form a volatile carbonyl chloride with Cl_2 and CO .

The hypochlorite method developed by Mylius and Mazzucchelli [5] for the preparative purification of the platinum metals can be recommended as a laboratory procedure. Platinum (in the form of small foil clippings or sponge) is dissolved in the purest aqua regia available (glass or porcelain vessels); the solution is withdrawn (or decanted) and carefully evaporated in a porcelain dish over a small flame; the concentrate is dissolved in hydrochloric acid and hot H_2O . The chloride solution is diluted with a large amount of water, heated to about 80°C , and made slightly alkaline with soda. Any IrO_2 present is precipitated with Cl_2 , bubbled through for a short time. The initially colloidal iridium-containing precipitate coagulates after a short time to a black flocculent deposit which settles rapidly in the yellowish-red solution. Addition of a few milliliters of alcohol produces a marked increase in the speed of separation. The more carefully the solution is neutralized (without, however, going below a pH of 7), the more complete is the separation of the unwanted oxide.

The other platinum metals, gold and the heavy base metals may be precipitated as the oxides by addition of hypochlorite. This reaction can therefore be used for the removal of all metallic impurities. The only oxide soluble in an excess of hypochlorite is the black RuO_2 (it is thereby converted to the volatile RuO_4).

The filtered platinum solution is heated in a beaker or porcelain vessel and treated with NH_4Cl . The $(\text{NH}_4)_2\text{PtCl}_6$ deposit is then filtered off and extracted by boiling with distilled water to dissolve any small quantities of $(\text{NH}_4)_2\text{PdCl}_6$ still remaining.

The very pure platinum obtained after ignition is free of all the other platinum metals, gold and the heavy base metals. If the Pt still contains a few tenths or hundredths of a percent of Ir, the purification process can be repeated.

REFERENCES:

1. W. von Schneider. *Liebigs Ann.* 5, 271 (1997).
2. K. Seubert. *Ibid.* 207, 8 (1881).
3. F. Mylius and F. Förster. *Ber. dtsh. chem. Ges.* 25, 665 (1892).
4. E. H. Reerink. *Z. anorg. allg. Chem.* 173, 45 (1928).
5. F. Mylius and A. Mazzucchelli. *Ibid.* 89, 1 (1914).

Reclaimed Platinum

In order to reclaim platinum residues from the laboratory (e.g., platinum absorbed on filter papers, scraps, filter ash, etc.), these are well ignited and then sieved through a fine screen, separating the residues into "fine" and "coarse" fractions.

The coarse fraction remaining on the screen contains the metallic residues, such as small pieces of wire, small clippings and pieces of foil. It is advisable to pass a magnet through this material to locate and remove any iron present in the form of nails, wire, etc. In some cases, it may be advisable to extract the iron from this fraction by boiling with dilute hydrochloric acid. Copper or brass residues are extracted by boiling with dilute nitric acid. The coarse material is then dissolved in aqua regia and processed to recover the Pt and its associated metals. In order to expel the nitric oxides present, the aqua regia solution is evaporated to a sirupy thickness, taken up with water and some dil. hydrochloric acid, and treated with NH_4Cl to precipitate the $(\text{NH}_4)_2\text{PtCl}_6$. The Pt still remaining in the mother liquor is precipitated with pure Zn.

The iron in the fine fraction is first extracted by boiling with dilute hydrochloric acid; after ignition, the residue is dissolved by heating in aqua regia. This solution is evaporated to a sirupy

thickness and taken up with H_2O and HCl ; the Pt is precipitated as $(NH_4)_2PtCl_6$.

If aged solutions or more or less reduced salts and preparations are to be processed, Berthold's work-up method is recommended. Often dirt appears in the residue on long standing, and sometimes the Pt salts are partially reduced by alcohol on long storage. In either case the liquid is first filtered, the residue is treated with aqua regia to dissolve any platinum it may contain, and the resulting solution is filtered.

The last filtrate is not combined with the first one, but is evaporated to drive off the aqua regia. The residue is extracted with hot water and this solution added to the main (that is, the first) filtrate.

When the solution to be worked up originates from an analytical laboratory, the main impurities are likely to be salts of K, Na, Mg and NH_4 . Alcohol and ether may also be present. In this case, the liquid is treated with some conc. HCl and pure Zn. If K_2PtCl_6 precipitates, it must be reduced by heating to convert it into soluble material. Any alcohol or ether present must first be driven off.

After the reduction, which is clearly indicated by the decoloration of the liquid, the supernatant is decanted; the residue is thoroughly extracted by boiling with conc. HCl and washed by decantation with hot distilled water until the wash water no longer contains any chloride.

Double salts containing a platinum and an alkali metal ion (and especially the ammonium ion) are best treated by careful calcination in a Pt crucible under a layer of NH_4Cl , extraction with boiling water acidified with some hydrochloric acid, and reignition.

For reclaiming procedure for Pt from electrolytic Pt baths, see p. 1567.

REFERENCE:

A. Berthold. *Z. angew. Chem.* 14, 621 (1901).

Platinum Sponge

Platinum sponge is best produced by prolonged ignition of $(NH_4)_2PtCl_6$ in a Pt dish or bowl (dull red heat, about $600^\circ C$). The ignited sponge should be boiled with dilute hydrochloric acid, and then with distilled H_2O . Finally it is gently heated again in a Pt dish.

Platinum Black

Of the various methods of preparation given in the literature, that described by Gutbier and Maisch seems to be the best. A 5%

solution of H_2PtCl_6 is heated, neutralized with Na_2CO_3 , and poured into a boiling solution of sodium formate. The black residue which precipitates immediately is washed by decantation with hot H_2O . It is then filtered off with suction and freed from residual water by pressing between filter papers; it is further dried over P_2O_5 or conc. H_2SO_4 .

PROPERTIES:

Black powder, very active toward H_2 , with a maximum absorptive capacity for H_2 at 0°C .

REFERENCE:

A. Gutbier and O. Maisch. Ber. dtsch. chem. Ges. 52, 1370 (1919).

Platinized Asbestos

Asbestos is saturated with an alcoholic solution of $\text{H}_2\text{PtCl}_6 \cdot 6 \text{H}_2\text{O}$ (technical "platinum chloride"), thereby producing a material with a definite platinum concentration. In view of the cost of the solution, the calculated quantity of H_2PtCl_6 must be absorbed quantitatively by the asbestos; it is therefore essential to establish accurately (by preliminary experiments) the absorbance of the asbestos to be used. The H_2PtCl_6 -saturated asbestos is kneaded as uniformly as possible and the mass is ignited while being agitated with a Pt spatula or rod. This method is particularly suitable for producing asbestos with low Pt contents (0.1-1% Pt). Its advantage lies in that the product contains no foreign salts which could obstruct the pores of the asbestos fibers and adversely affect its catalytic activity.

To prepare platinized asbestos with high platinum contents (5-10%), the mass is saturated with a H_2PtCl_6 solution which does not contain alcohol. The procedure is the same as described above. The mass is made slightly alkaline by treating it with dil. sodium hydroxide, and the chloride is then reduced to fine, particulate Pt with sodium formate. The reduction is best carried out in a muffle furnace at about $300\text{-}400^\circ\text{C}$. Finally the asbestos is freed of alkali salts by thorough washing with cold water and is dried in a muffle furnace. At this point the asbestos should be light gray.

Erdmann gives another method. Asbestos saturated with conc. H_2PtCl_6 is placed in a conc. solution of NH_4Cl . The asbestos, which is thus permeated with $(\text{NH}_4)_2\text{PtCl}_6$, is placed on a glass funnel to allow the excess solution to drain, and is then slowly heated to incandescence. This produces an asbestos with a high concentration of platinum sponge; however, the uniformity of the product leaves much to be desired.

For analytical purposes the platinized asbestos fibers should be as short as possible (almost powdery). For large-scale catalytic processes, the fibers should, on the other hand, be as long as possible.

REFERENCE:

- O. Erdmann. Lehrb. d. anorg. Chem. [Inorganic Chemistry Text], 5th ed., p. 175 (1910).

Handling of Platinum Equipment

Because the various chemicals used in ignition and melting processes may be corrosive, certain precautions must be observed in using platinum apparatus. Unfortunately, the use of platinum as vessel material is not a panacea for all the corrosion problems that plague the chemist.

Materials which readily form alloys with Pt (nonmetals P, As, Te, Si, B and C) or metals which melt at low temperatures (Pb or Sn) or substances which liberate these materials during ignition or melting processes can not only damage but even destroy platinum apparatus. This also holds for all melts containing potassium hydroxide, sodium nitrate, or mixtures of the alkali hydroxides or alkali carbonates with sodium nitrate; melts containing peroxides, cyanides or sulfides are particularly injurious to crucibles.

In general, ignitions should not be carried out at unnecessarily high temperatures or with reducing flames; reduction with an acetylene flame is forbidden.

Reducing conditions involving burner or flue gases, activated charcoal and the like are particularly deleterious when free silicic acid is also present. In this case, platinum-silicon alloys are formed, leading to the characteristic silicon fracture.

The critical corrosion temperature, i.e., the temperature above which serious corrosion occurs, generally lies around 700°C. However, this temperature is about 500-600°C for melts consisting mainly of KOH, Ba(OH)₂, peroxides or cyanides; for melts composed mainly of carbonates or neutral salts, it is 800°C or somewhat higher. Further details are given in the *Mitteilungen aus dem Chem. Laboratorium, W. C. Heraeus Co., Hanau*; publications of the Engelhardt Industries, Newark, N. J.; G. Bauer, *Chemiker-Ztg.* 62, 257 (1938).

CLEANING

Careful treatment of Pt vessels after use is essential. Usually the crucible contents can be easily removed by mechanical means.

In some cases, the contents can be dissolved with warm hydrochloric acid or chlorine-free nitric acid. If this does not suffice, sodium pyrosulfate is heated in the Pt crucible until liberation of SO_3 , the molten liquid is poured out, and the material still adhering to the walls is dissolved with hot water (O. Brunck). The crucible is not damaged at all by this treatment. If the edges of the crucible lid become bent out of shape, they can be smoothed out against a glass plate with a spatula made of horn or plastic. A very badly dented crucible should best be repaired by a goldsmith or other expert.

A Pt crucible that develops a small tear due to careless handling can readily be repaired in the laboratory. A small piece of thin gold foil of suitable size and shape is placed over the tear, and the spot is heated with an oxyhydrogen torch until the gold melts, after which the patch is smoothed with a burnisher. Such a crucible can still be used for most purposes. Very small tears can be healed with an oxyhydrogen torch; there is no need for a patch material in this case. Platinum wires, e.g., the leads to thermocouples or electrodes, can also be welded together quite simply with an oxyhydrogen torch: the two wires to be joined are laid close together and fused, or are welded together at a slightly lower temperature by a light tap with a hammer.

In case of serious damage, however, it is advisable to have the vessel repaired by a specialist.

Platinum Electroplating

Thin layers of platinum can easily be deposited from electrolytic baths; however, the deposition must be repeated several times to produce thicker deposits.

Böttger gives a very good bath formula; it consists of a solution of $(\text{NH}_4)_2\text{PtCl}_6$ in sodium citrate. Langbein gives the following instructions for preparing this bath: 500 g. of citric acid is dissolved in two liters of H_2O and neutralized with sodium hydroxide. This solution is heated to boiling and the $(\text{NH}_4)_2\text{PtCl}_6$, freshly precipitated from a solution of 75 g. of dry H_2PtCl_6 , is added with stirring; the mixture is heated until the $(\text{NH}_4)_2\text{PtCl}_6$ is completely dissolved; the solution is then cooled and diluted with H_2O to five liters. To reduce the electrical resistance of the bath, 4-5 g. of NH_4Cl is added per liter.

The electrolysis proceeds at 3-4 volts, a current density of 0.065 amp./in.² and a temperature of 70-90°C. Thin Pt sheet is always used as the anode in platinum plating baths; it is scarcely attacked at all. The bath must always be kept slightly alkaline; if this is no longer the case after prolonged passage of current, dilute aqueous ammonia is added until an odor of ammonia is

noticeable. If the bath is acid, Pt sponge will rapidly precipitate.

C. W. Keitel et al. give another bath formula: cis-dinitrodiammineplatinum is dissolved in ammonia, and ammonium nitrate and sodium nitrite are added to improve the conductivity of the bath.

Objects to be plated with platinum (cathodes) are prepared in exactly the same way as in any other method of electroplating. Given the cost of platinum, these objects are usually small; platinum electrolysis vessels therefore need to hold only a few liters of the solution; the vessel will thus usually be a glass or porcelain beaker or a small iron trough coated on the inside with a special alkali- and acid-resistant enamel. If the platinum deposit is too dull, it can be rubbed and scoured in the same way as gilt-ware, and then replaced in the platinum bath to deposit a further platinum layer; this treatment may be repeated until the required deposit thickness is reached.

The current efficiency in platinum coating is very small (only 30-40% of the theoretical) since large quantities of energy are consumed in liberating the great amount of H_2 that evolves. This H_2 also hardens the platinum deposits.

REFERENCE:

Pfanhauser et al. *Galvanotechnik* [Applied Electrochemistry], Leipzig, 1949, pp. 939-942; gives further details on bath compositions and on other recently developed plating baths.

According to Lummer and Kurlbaum, the liquid most suitable for the platinization of electrodes for potential measurements consists of 3 g. of $H_2PtCl_6 \cdot 6 H_2O$ plus 0.10 g. of lead acetate in 97 ml. of H_2O ; the bath temperature is 20-30°C, the potential about 4 volts. Two series-connected storage batteries are used as a power source and the current is regulated to produce a moderate gas evolution. The current is reversed, so that each electrode serves alternately as the anode and cathode. The total time for initial platinization is 10-15 minutes; usually only 1-2 minutes is sufficient for replating electrodes already covered with platinum black (before platinum plating these electrodes must be carefully cleaned; it is best to do this with chromosulfuric acid).

A thin coat of platinum (burnished platinum) can be produced on glass and porcelain by baking on either of the following special solutions:

I. A solution of 1 g. of platinic chloride ($H_2PtCl_6 \cdot 6 H_2O$) in 3.5 ml. of absolute alcohol is mixed with 10 ml. of a concentrated alcoholic solution of boric acid and 25 ml. of a solution of Venetian turpentine in lavender oil.

II. A solution of 1 g. of platinic chloride ($H_2PtCl_6 \cdot 6 H_2O$) in the minimum amount of absolute alcohol is added slowly (stirring) to

6 ml. of ice-cold lavender oil. After warming, Burgundy pitch is added to the mixture to give the required consistency.

In either case, the platinum-containing mass is spread uniformly on the glass (or porcelain) and carefully heat-dried so that no bubbles develop. The coated surface is then heated to a dull red heat in a muffle furnace or in a sulfur-free blowtorch flame.

The ingredients of these solutions are not usually available in the laboratory. However, ready-for-use solutions for producing burnished platinum (with instructions) are provided by companies handling noble metals (e.g., W. C. Heraeus of Hanau or Degussa of Frankfurt or Engelhardt Industries of Newark, N. J.).

REFERENCE:

Ostwald-Luther. *Physiko-Chemische Messungen* [Physicochemical Measurements], 4th ed., Leipzig, 1925, pp. 158-159.

RECLAIMING PLATINUM FROM USED BATHS

If the liquid quantity is not too large, then the best method is to precipitate the platinum with H_2S (this is preferred over the procedure involving concentration of the solution and reduction of the residue to the metal). The platinum can be precipitated from larger liquid quantities with pure Zn (following acidification of the bath liquid).

Platinum Chlorides

Streicher and Krustinsons gives the following facts about the stability of chlorides of platinum as a function of temperature at 1 atm. of Cl_2 pressure:

$PtCl_4$ (russet) stable up to $382^\circ C$,

$PtCl_3$ (dark green) stable between 382 and $435^\circ C$,

$PtCl_2$ (greenish brown) stable between 435 and $515^\circ C$.

The existence of $PtCl$ (pale yellow-green), 581 - $583^\circ C$, is not altogether certain.

REFERENCES:

S. Streicher. Thesis, Univ. of Darmstadt, 1913; J. Krustinsons. *Z. Elektrochem.* 44, 537 (1938).

$PtCl_4$

Prepared by decomposition of $H_2PtCl_6 \cdot 6 H_2O$ in a stream of chloride. The starting material is placed in a boat set in a

combustion tube made of high-melting glass. The temperature is increased slowly from 60 to 150°C, which drives off water. When the material is completely dry, the temperature is raised to 275-300° over a period of two hours, and held at this level for 0.5 hour. The temperature must not be allowed to rise above 360°C. After cooling to about 150°C, the product is removed, quickly ground, replaced in the combustion boat, and reheated for 0.5 hour at 275°C while a stream of Cl₂ is passed over it. The resultant chloride is placed, while still hot, in a hermetically closable storage bottle. The yield from 6 g of H₂PtCl₆ · 6 H₂O is 3.7 g. of PtCl₄.

PROPERTIES:

Red-brown, very hygroscopic crystals. Very soluble in water, sparingly soluble in alcohol. Absorbs moisture on standing in air, yielding PtCl₄ · 5 H₂O.

REFERENCES:

- A. Gutbier. Z. anorg. Chem. 81, 381 (1913); M. S. Kharasch and T. A. Ashford. J. Amer. Chem. Soc. 58, 1736 (1936); R. N. Keller in: W. C. Fernelius, Inorg. Syntheses, Vol. II, New York-London, 1946, p. 247.

PtCl₂

I. Prepared by heating platinum sponge to about 500°C in a stream of Cl₂ or, better, by thermal decomposition of PtCl₄ or H₂PtCl₆ · 6 H₂O.

The H₂PtCl₆ · 6 H₂O (or the commercial product containing 40% Pt) is subjected to a preliminary decomposition over a free flame at 150°C. The resulting residue is ground and decomposed in a slow air stream at 360°C. Depending on the quantities involved, the operation may require several hours. At the end the undecomposed H₂PtCl₆ should be removed by extracting and washing with H₂O, after which the product is redried at 360°C.

PROPERTIES:

Formula weight 266.0. Greenish-brown powder. Insoluble in water. At 250°C, dry PtCl₂ forms a very volatile carbonyl chloride with CO. Thus gases containing CO should not be used in reductive ignition of platinum chloride (the same holds for the chlorides of the other platinum metals). Very sparingly soluble in dil. hydrochloric acid, yielding H₂ PtCl₄.

REFERENCE:

- M. S. Kharasch and T. A. Ashford. J. Amer. Chem. Soc. 58, 1776 (1936).

II. A chocolate-brown form of platinum (II) chloride can be prepared by careful concentration of a solution of tetrachloroplatinic (II) acid (see p. 1570) in hydrochloric acid; this material is more soluble in hydrochloric acid and aqueous ammonia than the product obtained by method I.

REFERENCE:

W. E. Cooley and D. H. Busch in: T. Moeller, *Inorg. Syntheses*, Vol. V, New York-Toronto-London, 1957, p. 208.

Hexachloroplatinic (IV) Acid

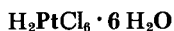

Obtained by dissolving platinum in aqua regia. To prepare large quantities, the platinum, in the form of thin shavings of foil, is dissolved in a porcelain or glass vessel and the solution poured into a porcelain dish. Hydrochloric acid is added and the solution evaporated to sirupy consistency in order to drive off the nitric acid and any $\text{PtCl}_4 \cdot 2 \text{NOCl}$ which may form. The thick solution is taken up with HCl and the resulting solution reevaporated to a sirup. This is repeated several times. Since the last traces of nitric oxide are very difficult to remove, finely divided Pt may also be dissolved in hydrochloric acid through which Cl_2 is bubbled (or nascent Cl_2 may be generated in the solution itself by carefully adding HClO_3 or H_2O_2 to it).

The concentrated solution is placed in a large tared dish and the percentage of platinum in the chloride is adjusted (usually to 39.5 or 40%) by controlled evaporation of the acid on a burner (check on the decrease in weight).

When the required percentage of platinum is reached, the dish is removed from the burner and allowed to stand until the chloride solution becomes a definite slurry. The solution is then stirred with a thick glass rod until it is completely cool.

SYNONYMS:

Chloroplatinic acid, platinum chloride, platinic chloride.

PROPERTIES:

Formula weight ($\text{H}_2\text{PtCl}_6 \cdot 6 \text{H}_2\text{O}$) 518.0. Commercial "platinum chloride" containing 39.5-40% Pt is not a definite hydrate, but has the composition of $\text{H}_2\text{PtCl}_6 \cdot 4.5 \text{H}_2\text{O}$ and is deep orange. Starting material for the preparation of most platinum compounds.

Tetrachloroplatinic (II) Acid



Stable only in solution; prepared by reduction of H_2PtCl_6 with a stoichiometric quantity of $\text{N}_2\text{H}_4 \cdot 2 \text{HCl}$:

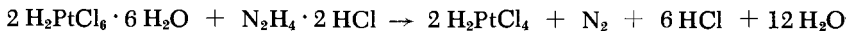

Commercial platinum chloride (10 g., 40% Pt) is dissolved in 50 ml. of water in a 150-ml. beaker. Then 1.07 g. of solid $\text{N}_2\text{H}_4 \cdot 2 \text{HCl}$ is added in small portions, so that the solution effervesces each time due to evolution of N_2 . Within five minutes of adding the last of the hydrazine salt, the deep red solution is heated on a steam bath until no further gas evolves; it is then filtered to remove the small quantity of platinum black which may deposit out.

PROPERTIES:

Red solution; leaves a brown deposit of PtCl_2 on careful evaporation. Very stable in hydrochloric acid solution. With an excess of ammonia it forms $[\text{Pt}(\text{NH}_3)_4] [\text{PtCl}_4]$ or $[\text{Pt}(\text{NH}_3)_4]\text{Cl}_2$.

REFERENCE:

W. E. Cooley and D. H. Busch in: T. Moeller, *Inorg. Syntheses*, Vol. V, New York-Toronto-London, 1957, p. 208.

Ammonium Hexachloroplatinate (IV)

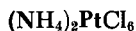

A dilute, weakly acidic (HCl) solution of H_2PtCl_6 is prepared and, if that is needed, oxidized with H_2O_2 . It is then reacted with an excess of NH_4Cl (at least three parts by weight of NH_4Cl to one of Pt) and slowly evaporated to dryness on a steam bath. The salt crust mixed with the resulting residue is broken up with a glass rod and the solids heated on a steam bath with continuous stirring until the powdery mass no longer gives off the odor of HCl. The dry residue is then carefully moistened with some distilled water, taken up in cold saturated NH_4Cl solution and filtered. It is washed first with NH_4Cl solution, then with alcohol. The mother liquor should be completely colorless and show only traces of Pt on reaction with H_2S and SnCl_2 .

SYNONYMS:

Platinic salammoniac, ammonium platinichloride, ammonium chloroplatinate.

PROPERTIES:

Formula weight 443.9. Lemon-yellow octahedra. A color of yellow ochre to brick red instead of lemon yellow indicates the presence of other platinum metals, particularly Pd, Ir and Ru. Greenish-yellow to green indicates that Rh is present. Completely decomposed on ignition in a platinum dish, leaving fine particles of platinum sponge. Very sparingly soluble in H_2O , less soluble in NH_4Cl solutions. Solubility ($15.5^\circ C$) 0.67 g., ($100^\circ C$) 1.25 g./100 ml. H_2O . Colorless solution in conc. ammonia. Like K_2PtCl_6 , insoluble in alcohol.

Potassium Hexachloroplatinate (IV)



Prepared by adding a solution of KCl to H_2PtCl_6 (the ratio of solid components is 3:1). For complete precipitation of the Pt with KCl or NH_4Cl , the Pt must be completely oxidized to the +4 state and the solution must be as concentrated as possible; however, the solution should not be so concentrated that it becomes viscous while the product is being formed.

SYNONYM:

Potassium platinichloride.

PROPERTIES:

Formula weight 486.0. Pure yellow crystals; dissolve with difficulty in water; insoluble in alcohol. The color changes in the presence of the other platinum metals in the same way as does that of $(NH_4)_2PtCl_6$. Solubility in water:

$^\circ C$	g. K_2PtCl_6 /100 g. H_2O
0	0.74
10	0.90
20	1.12
50	2.16
80	3.79
100	5.13

Sodium Hexachloroplatinate (IV)



Prepared by passing Cl_2 over a mixture of platinum sponge with twice its weight of NaCl. The reaction temperature should be higher

than 500°C, but should not under any circumstances exceed 660°C. Purification is effected by solution of the product in alcohol, filtration to remove NaCl and platinum metals, and concentration of the solution, after which the salt is dried in a drying oven.

If the reaction mixture is dissolved in water (instead of alcohol) and the solution concentrated, $\text{Na}_2\text{PtCl}_6 \cdot 6 \text{H}_2\text{O}$ is produced as triclinic, orange-colored crystals. A very pure salt is obtained by recrystallization from 1% soda solution; it loses its water of crystallization below 100°C.

SYNONYM:

Sodium platinichloride.

PROPERTIES:

Formula weight (anhydrous) 453.8. Orange crystals. Soluble in water and alcohol.

REFERENCE:

L. Wöhler and P. Balz. Z. anorg. allg. Chem. 149, 356 (1925).

Potassium Tetrachloroplatinate (II)



Prepared by reduction of K_2PtCl_6 with SO_2 or $\text{N}_2\text{H}_4 \cdot 2 \text{HCl}$.

I. A suspension of 4.7 g. of K_2PtCl_6 in 35 ml. of H_2O is prepared in a 50-ml. beaker; small portions of freshly prepared SO_2 solution are added while stirring the suspension mechanically and heating it to 85-90°C on a water bath. About 15 additions of 0.6 ml. should be made first, followed by 10-15 additions of 0.4 ml. After each addition, 2-3 minutes (later 3-4 minutes) should be allowed until the SO_2 is consumed and its odor disappears. Toward the end of the reduction, when the suspended particles are gradually disappearing, it is necessary to proceed even more slowly. The solution remaining on complete reduction is concentrated on a water bath until crystallization begins. After cooling, it is suction-filtered, and the red K_2PtCl_4 is dissolved in 40 ml. of cold water, filtered to remove any small residue of K_2PtCl_6 , and the residue rinsed with 5 ml. of water. The solution is carefully transferred (rinsing with 10 ml. of water) into an 800-ml. beaker; its total volume at this point is 55-60 ml. Then 660 ml. of a 1:1 mixture of acetone and ether is added with stirring. This precipitates the solid chloroplatinate,

which is allowed to settle. The bright yellow liquid is decanted, and the salt is washed three times with 120 ml. of acetone-ether mixture (decantation) and then three times with 80 ml. of ether. After filtering and drying the product in air, the salt is recrystallized from hot, slightly acidified water.

II. The K_2PtCl_6 can be reduced with $N_2H_4 \cdot 2 HCl$ in the same way as H_2PtCl_6 .

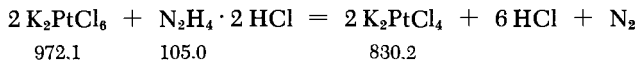

The K_2PtCl_6 is suspended (brisk stirring) in 10-12 times its weight of water. With continuous stirring, the stoichiometric quantity of solid $N_2H_4 \cdot 2 HCl$ is added in small portions, the temperature being raised to 50°C within 10 minutes. The K_2PtCl_6 dissolves with evolution of N_2 . The solution is brought to the boiling point, filtered and concentrated, first over an open flame and then on a water bath, until crystallization begins. Since no foreign ions are introduced in this preparative method, recrystallization can be omitted, provided the starting materials used are pure.

An excess of $N_2H_4 \cdot 2 HCl$ leads to the formation of platinum black, while a deficiency leaves undissolved K_2PtCl_6 .

The compounds $(NH_4)_2PtCl_4$ and Na_2PtCl_4 can also be prepared in this way.

PROPERTIES:

Formula weight 415.1. Red crystals or bright red powder. Solubility in water (16°) 0.93 g., (100°C) 5.3 g./100 ml. Insoluble in alcohol; reduced in alcohol.

REFERENCES:

- I. Magnus. Pogg. Ann. 14, 241 (1828).
- II. R. N. Keller in: W. C. Fernelius, Inorg. Syntheses, Vol. II, New York-London, 1946, p. 247; N. G. Klynchnikov and R. N. Savel'eva, abstract in Chem. Abs. 51, 10288 (1957).

Platinum (II) Oxide

PtO

Wöhler's method is recommended in preference to others. Oxygen is passed at 150°C over platinum sponge that is as finely divided as possible; the temperature must not exceed 560°C.

PROPERTIES:

Completely anhydrous black powder. Readily soluble in aqua regia. Instantly reduced by H_2 at ordinary temperatures, liberating heat and forming gray platinum sponge. Decomposes at atmospheric pressure ($560^\circ C$): $2 PtO = 2 Pt + O_2$.

REFERENCE:

L. Wöhler. Z. Elektrochem. 15, 136 (1909).

Platinum (IV) Oxide



I. It is impossible to prepare completely anhydrous PtO_2 without decomposing it. In addition, even the hydrated material (which contains variable quantities of water) is not easy to obtain in pure form. The procedure of Wöhler and Frey appears to be the most suitable. Red-brown hydrated platinum dioxide is precipitated by boiling a pure, concentrated solution of H_2PtCl_6 with concentrated Na_2CO_3 solution. The precipitated solid is made acid-insoluble by heating for several hours in a drying oven at $200^\circ C$; it is then freed of chlorides by vigorous boiling with dilute soda solution and distilled water. Finally, it is freed of alkali by treatment with dilute sulfuric acid and distilled water, filtered off and dried on a water bath.

PROPERTIES:

Straw yellow after brief drying; on further drying, becomes yellow ochre and then dark brown; at this point the oxide is acid-insoluble.

REFERENCE:

L. Wöhler. Z. anorg. Chem. 40, 436 (1904).

II. A 10% solution of H_2PtCl_6 (10 ml.) is added to 9 g. of $NaNO_3$ in a 50-ml. beaker. The solution is evaporated to dryness over a flame (covered with asbestos-wire gauze) while continuously stirring with a glass rod. Local melting of the mixture must be carefully avoided. Then 100 g. of $NaNO_3$ is heated to $520^\circ C$ in a 400-ml. beaker (controlling the temperature with a thermocouple), and the dry, fine powder residue from the evaporation is added at once. The flame is then removed. The olive-brown platinum oxide is

precipitated more or less quantitatively and settles rapidly. During cooling and solidification, the beaker is rotated, so that the contents solidify on the walls in fine particles, thus avoiding the cracking of the beaker.

The cooled melt is dissolved in about two liters of H_2O , and the residue is filtered off with suction. It is then washed repeatedly with H_2O , taking care that the residue remains covered with water at all times, since otherwise it passes into solution as a colloid. Finally it is dried over CaCl_2 in an evacuated desiccator.

PROPERTIES:

Heavy brown powder; insoluble in aqua regia. Blackens and settles rapidly when treated with H_2 in an alcoholic suspension (this powder is soluble in aqua regia). Very active catalyst for the hydrogenation of olefins and carbonyl groups.

REFERENCE:

V. L. Framton, J. D. Edwards, Jr., and H. R. Henze. *J. Amer. Chem. Soc.* 73, 4432 (1951).

Hexahydroxyplatينات (IV)

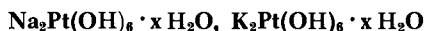

An aqueous solution of Na_2PtCl_6 or K_2PtCl_6 is boiled with NaOH and then treated with alcohol. The precipitate consists of small colorless crystals, which are filtered off and dried in air. Depending on the conditions of precipitation, the product contains from 0.5 to 3 moles of H_2O . Aqueous solutions of these two salts are very good electrolytes for electroplating platinum.

Platinum (II) Sulfide



Produced by heating an intimate mixture of very fine powders of platinum sponge and sulfur; may also be produced by decomposition of a boiling solution of PtCl_2 by bubbling in H_2S , or by adding to it a solution of one of the alkali sulfides. The black precipitate can be washed and dried without being altered.

PROPERTIES:

Insoluble in acids, even at the boil. Yields metallic Pt when heated in air.

Platinum (IV) Sulfide



Produced as a dark-brown precipitate by passing H₂S through a hot solution of H₂PtCl₆ in hydrochloric acid. The precipitation can be greatly accelerated and made almost quantitative if the weakly acidic platinate solution is mixed with a 5% solution of MgCl₂ and then saturated with H₂S gas. After the excess H₂S is driven off by boiling, the PtS₂ is filtered off and carefully dried.

PROPERTIES:

Insoluble in hydrochloric and sulfuric acids, soluble in nitric acid and particularly in aqua regia. Even though Pt belongs to the group of elements forming thio salts, PtS₂ is only slightly soluble in colorless alkali sulfides and yellow ammonium sulfide.

Potassium Tetracyanoplatinate (II) and

Barium Tetracyanoplatinate (II)



Both salts are obtained by precipitation reactions.

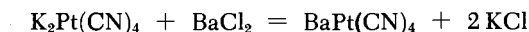
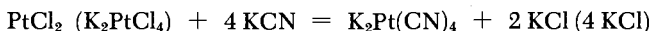

A solution of PtCl₂ or K₂PtCl₄ is added to a cold, saturated solution of KCN (use a good hood!). The precipitated K₂Pt(CN)₄ · 3 H₂O is filtered off with suction. If it is to be used for preparing the barium salt, it is dissolved in water and treated with a concentrated aqueous solution of BaCl₂. The precipitated BaPt(CN)₄ · 4 H₂O is filtered off with suction and washed with cold water.

SYNONYMS:

Potassium platinocyanide; barium platinocyanide.

PROPERTIES:

K₂Pt(CN)₄ · 3 H₂O: Polychromatic, blue and yellow. Readily soluble in hot water; most of it rapidly reprecipitates on cooling the solution. d 2.455.

$\text{Ba}[\text{Pt}(\text{CN})_4] \cdot 4 \text{H}_2\text{O}$: Crystals with brilliant polychromism (pleochroism), iridescent violet-blue on the prism faces, yellow-green in the axial direction. Solubility (20°C) 3.5 g./100 g. H_2O . d 2.076.

Ammine Complexes of Platinum (III)

(Platinum Ammines)

Magnus's Salt $[\text{Pt}(\text{NH}_3)_4][\text{PtCl}_4]$ and Reiset's First Chloride $[\text{Pt}(\text{NH}_3)_4]\text{Cl}_2 \cdot \text{H}_2\text{O}$

An excess of 50% ammonia is added to a boiling solution of H_2PtCl_4 (obtained by reduction of H_2PtCl_6 , see p. 1570). Cooling precipitates the dark-green crystals of Magnus's salt. If heating with the excess of ammonia is continued with stirring, ignoring the appearance of the precipitate, the latter redissolves and the solution becomes colorless. It now contains $[\text{Pt}(\text{NH}_3)_4]\text{Cl}_2$, Reiset's first chloride. This salt can be precipitated directly by adding alcohol whereby it is obtained as colorless crystals. However, for higher purity, the preparation should proceed via Magnus's salt.

This requires a solution of H_2PtCl_4 in which the latter is present in a quantity exactly equivalent to the Reiset's chloride. The simplest way to achieve this is to divide a given quantity of H_2PtCl_4 solution into two equal parts and use only one of these for conversion of the solute to $[\text{Pt}(\text{NH}_3)_4]\text{Cl}_2$ in the manner described above. The excess NH_3 is driven off as completely as possible by heating on a water bath. The two solutions are then gradually combined (stirring), and pure green Magnus's salt is precipitated:

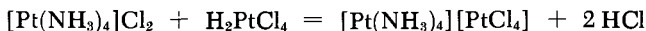

The precipitate is allowed to settle, the mother liquor decanted, and the solid washed with small portions of hot water (on a filter) until the wash water is free of chlorides. The Magnus's salt is now pure and can be dried.

For conversion into pure Reiset's chloride, the moist Magnus's salt is placed in a beaker, covered with some dil. hydrochloric acid, and treated with an excess of concentrated ammonia. The mixture is boiled gently with continuous stirring, gradually dissolving the solids. The evaporating ammonia must be replaced from time to time to maintain the original volume. After the green salt is completely dissolved the solution is evaporated until only a faint odor of NH_3 remains. Then it is neutralized to litmus, 1 ml. of concentrated HCl added, and the mixture treated with 10 times its volume of 1:1 alcohol-acetone. It is allowed to stand for an

hour; the white precipitate is removed, washed a few times with small portions of alcohol-acetone, and rinsed with pure acetone on a suction filter. The resulting Reiset's chloride is dried in air.

PROPERTIES:

Magnus's salt: Dark-green crystalline needles. Very difficult to dissolve in water. Rapidly transformed into trans-[PtCl₂(NH₃)₂] on dry heating to 290°C.

Reiset's first chloride: Colorless tetragonal crystals. Solubility (20°C) about 20 g./100 g. H₂O; more soluble in hot water. Insoluble in alcohol, ether and acetone. Forms the hydrate [Pt(NH₃)₄]Cl₂·H₂O on recrystallization or concentration of an aqueous solution.

Reiset's Second Chloride



If Reiset's first chloride is heated at 250°C until no further NH₃ is given off, the product is trans-diamminedichloroplatinum (II):

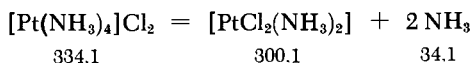

A mixture of this chloride with NH₄Cl is obtained by evaporating the first chloride with a large excess of concentrated HCl; the NH₄Cl is extracted from the residue with cold water.

Purification is effected by recrystallization from hot water or by converting the solid to the nitrate by means of AgNO₃, followed by reprecipitation of the chloride from the nitrate solution with concentrated HCl.

PROPERTIES:

Sulfur-yellow crystalline powder. Very slightly soluble in cold water; solubility (100°C) 0.7 g./100 g. H₂O. Decomposes above 340°C.

Peyrone's Chloride



I. A cold, clear solution of 20 g. of (NH₄)₂PtCl₄ in 100 ml. of H₂O is reacted with 50 ml. of 5 N ammonia and allowed to stand for

12-48 hours in a closed flask at 0°C. The crystalline precipitate contains Peyrone's chloride and some Magnus's salt. The mixture is filtered off and washed with ice water until no Magnus's salt is precipitated from the filtrate with PtCl_4^{2-} . The Peyrone's chloride on the filter is then dissolved with boiling water, and the yellow solution is mixed with 1/3 its volume of 50% hydrochloric acid. After standing for 24 hours, the crystalline precipitate is filtered off, washed until free of acid with ice water and then with alcohol, and finally dried in air. Yield: 10.7 g.

II. A lukewarm solution of 41 g. of K_2PtCl_6 and 27 g. of NH_4Cl in 200 ml. of H_2O is reacted with 54.4 ml. of 3.75 N ammonia (0.204 mole) and allowed to stand for two days at room temperature and for an additional day at 0°C. The precipitate which has formed is then filtered off with suction (removing the liquid as completely as possible), thoroughly washed with ice water, and dried in air. The yield is 27.1 g. of a product which is not completely pure but contains, in addition to $\text{cis-}[\text{PtCl}_2(\text{NH}_3)_2]$, a few percent of Magnus's salt and $[\text{PtCl}(\text{NH}_3)_3]_2 [\text{PtCl}_4]$.

PROPERTIES:

Yellow crystalline powder (needles or platelets). Solubility (0°C) 0.26 g., (100°C) 3 g./100 ml. H_2O . Dissolves very slowly in water at 100°C. Rapidly converted to the trans compound on dry heating to 275°C.

REFERENCES:

Gmelins Handb. d. anorg. Chem. [Gmelin's Handbook of Inorganic Chemistry], 8th ed. (1957), Platinum, Part D, pp. 45, 53, 236, 241; S. M. Jörgensen. Z. anorg. Chem. 24, 153 (1900); S. M. Jörgensen and S. P. L. Jörgensen. Ibid. 48, 441 (1906); L. Ramberg. Ibid. 83, 33 (1913); R. N. Keller in: W. C. Fernelius, Inorg. Syntheses, Vol. II, New York-London, 1946, p. 250.

cis-Dinitrodiammineplatinum (II)



The cis form of this neutral salt complex is precipitated when an aqueous solution of potassium platinum (II) nitrite is treated with aqueous ammonia.

The starting $\text{K}_2\text{Pt}(\text{NO}_2)_4$ can be prepared from K_2PtCl_6 , which is allowed to react with an excess of alkali nitrite, evolving nitric oxide.

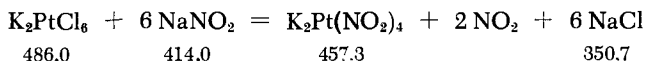

One part by weight of K_2PtCl_6 is suspended in water and treated with a concentrated solution of 10 parts by weight of $NaNO_2$. The mixture is then heated with stirring. The yellow K_2PtCl_6 first dissolves giving a dark solution, and then nitric oxide is liberated as fine bubbles while the solution clears to a pale greenish yellow. When no further gas evolves the solution is cooled and, if necessary, the precipitated impurities are filtered off.

The $K_2Pt(NO_2)_4$ solution can also be prepared, in a smooth reaction, from K_2PtCl_4 :

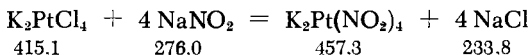

To produce the desired complex $[Pt(NO_2)_2(NH_3)_2]$, the cold, filtered solution of $K_2Pt(NO_2)_4$ is reacted with a stoichiometric quantity of 20% aqueous ammonia:

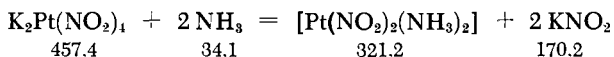

After a short time the complex precipitates as a dense whitish mass of fine, needlelike crystals. After filtration and washing with cold water, it can be recrystallized from hot water; the product consists of pale-yellow needles.

PROPERTIES:

Formula weight 321.17. Pale-yellow needlelike crystals. Decompose explosively at $200^\circ C$. Sparingly soluble in water; readily soluble in aqueous ammonia, forming $[PtNO_2(NH_3)_3]NO_2$, which can be used to prepare a good platinum electroplating bath.

REFERENCE:

W. Keitel and H. E. Zschiegner. U.S. Patent 1,779,436.

Pure Palladium

Pd

In the Wilm method, very pure palladium is obtained by treating a solution of $PdCl_2$ or Na_2PdCl_4 with NH_4Cl in order to precipitate as $(NH_4)_2PtCl_6$ any slight Pt impurity which may be present. The filtrate is boiled with an excess of NH_3 , filtered again if necessary, and acidified with HCl. A yellow precipitate of very pure $[PdCl_2(NH_3)_2]$ should form. If the salt has a dull, dirty yellow color,

it contains a small quantity of $[\text{RhCl}(\text{NH}_3)_5]\text{Cl}_2$, which is insoluble in cold ammonia. The salt is therefore digested with cold aqueous ammonia; completely pure palladodiammine chloride $[\text{PdCl}_2(\text{NH}_3)_2]$ is obtained from the filtrate by a second precipitation with hydrochloric acid; it is a bright-yellow crystalline salt. This is reduced by ignition in a stream of H_2 to light gray palladium sponge.

PROPERTIES:

M.p. 1554°C ; d 11.97. Absorbs large quantities of many gases, especially H_2 .

REFERENCE:

Th. Wilm. Ber. dtsh. chem. Ges. 15, 241 (1882).

Colloidal Palladium

A solution of 2 g. of sodium protalbinic acid (the sodium salt of protalbinic or lysalbinic acid) in 50 ml. of water is prepared; aqueous NaOH is added in slight excess, followed by a solution of 1.6 g of PdCl_2 (equivalent to 1 g. of Pd) in 25 ml. of H_2O . Then $\text{N}_2\text{H}_4 \cdot \text{H}_2\text{O}$ is added dropwise to the resulting clear red-brown liquid, producing immediate reduction (foaming). After standing for three hours, the black solution is dialyzed against water to remove the excess NaOH , $\text{N}_2\text{H}_4 \cdot \text{H}_2\text{O}$ and NaCl ; this is continued until the dialyzing water no longer gives a reaction for $\text{N}_2\text{H}_4 \cdot \text{H}_2\text{O}$ and NaCl . The purified solution is concentrated at $60\text{--}70^\circ\text{C}$ and dried in vacuum over H_2SO_4 . The product consists of shiny black platelets, which dissolve in water leaving no residue.

PROPERTIES:

Stable when dry. Its solution appears opaque and black in incident light; thin layers are clear black-brown with a greenish tinge in transmitted light. One volume of the product (about 50% Pd) contained in this colloidal solution can absorb approximately 3000 volumes of H_2 .

REFERENCES:

C. Paal and C. Amberger. Ber. dtsh. chem. Ges. 37, 124 (1904);
P. Stecher et al. Merck Index, 7th ed., p. 623 under "lysalbinic acid."

Palladium Black

The Böttger method for preparing palladium black consists in reducing an aqueous solution of a Pd (II) salt with sodium formate.

The reaction occurs slowly at room temperature and is instantaneous at 50°C.

PROPERTIES:

According to C. Paal, an aqueous suspension of palladium black absorbs 12,000 times its volume of H_2 ; the dry material absorbs only 870 times its volume.

REFERENCE:

Jahresber. d. phys. Vereins Frankfurt a.M. [Annual Report of the Frankfurt a.M. Physics Society], 1872-73, p. 11.

Palladized Asbestos

Palladized asbestos is prepared in exactly the same way as platinized asbestos (see p. 1563).

Palladium (II) Chloride



The anhydrous salt is prepared by heating loose palladium sponge (contained in a porcelain boat set in a glass tube) to a dull red heat in a stream of Cl_2 . According to Krustinsons, the decomposition pressure of $PdCl_2$ reaches 1 atm. at 738°C.

By dissolving finely divided Pd in conc. HCl through which Cl_2 is bubbled, one obtains a solution in which both H_2PdCl_4 and H_2PdCl_6 can be detected. Concentrating the solution also yields a residue of $PdCl_2$.

$PdCl_2$ Solution for the Detection of CO

Winkler gives the following method for preparing this solution. Pure Pd (0.2 g.) is dissolved with gentle heating in about 10 ml. of aqua regia. The solution is evaporated to dryness in a 50-ml. porcelain dish placed on a steam bath. The residue is dissolved in 10 ml. of 20% hydrochloric acid and the solution is again evaporated to dryness; this last procedure is repeated three times. The resulting residue, which is now completely nitrate-free, is mixed with 2 g. of KBr and dissolved (gentle heating) in 10 ml. of 1 N HCl. After dilution to about 150 ml. with water, a few particles of pumice and 1 ml. of alcohol are added to the solution, which is then boiled for about 10 minutes in an Erlenmeyer flask in order

to reduce any Pd (IV) not decomposed during the drying to Pd (II) and to drive off the excess alcohol. After cooling, 2.5 g. of $\text{CH}_3\text{COONa} \cdot 3 \text{H}_2\text{O}$ is dissolved in the liquid. The solution is filtered through a small wad of cotton wool and diluted to 200 ml. with the water used for washing the cotton wool. The clear, reddish-brown liquid, which contains 0.1% palladium, is stable when stored in a flask provided with a ground-glass stopper. To be on the safe side, it is best to filter the solution before use; it should be stored in the dark.

REFERENCES:

- J. Krustinsons. *Z. Elektrochem.* 44, 537 (1938); L. Winkler. *Z. anal. Chem.* 100, 321 (1935); 97, 18 (1934); also describes analytical methods for detecting CO with PdCl_2 solutions. Explicit directions for the preparation of palladium catalysts using PdCl_2 are given by R. Mozingo in *Organic Syntheses*, collective vol. III, p. 685 (Wiley, New York, 1955).

Palladium (II) Oxide

PdO

A reasonably pure PdO, particularly suitable for catalytic purposes, can be prepared by decomposition of palladium nitrate. Sodium nitrate (50 g.) and a solution of PdCl_2 containing 2 g. of Pd are mixed and evaporated to dryness. The dry mixture is then heated (it fuses in the process), first for some time at 270-280°C, then at 350-370°C, until evolution of nitric oxides ceases; finally, it is heated to 575-600°C for a short time. The melt is extracted with 200 ml. of water, leaving behind the PdO. This is washed with a 1% NaNO_3 solution and dried in vacuum over H_2SO_4 . The product still contains about 1.5% H_2O and 2.5% alkali salts. The pure material can be obtained by ignition in O_2 , but this causes a loss of catalytic activity.

PROPERTIES:

Black powder; tetragonal crystals. Stable in air up to about 700°C, in O_2 to about 800°C. Insoluble in aqua regia; soluble in conc. HBr. d 8.7.

REFERENCES:

- Gmelin. *Handb. d. anorg. Chem.* [Gmelin's Handbook of Inorganic Chemistry], 8th ed., System No. 65, Berlin, 1942; R. L. Shriner and R. Adams. *J. Amer. Chem. Soc.* 46, 1685 (1924).

Tetrachloropalladates (II)

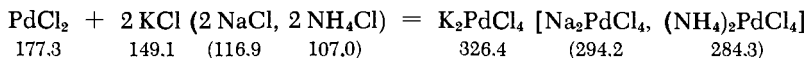

These three salts are obtained as well-formed crystals by treating PdCl_2 solutions with stoichiometric quantities of the respective alkali chlorides and slowly evaporating the solutions.

SYNONYMS:

Potassium, sodium and ammonium palladochlorides.

PROPERTIES:

K_2PdCl_4 : Crystallizes in dark yellow or brownish prisms. Readily soluble in hot water, soluble with difficulty in cold water. Precipitated in golden yellow lamellae by addition of alcohol to a hot aqueous solution.

Na_2PdCl_4 : Brown, deliquescent; also soluble in alcohol.

$(\text{NH}_4)_2\text{PdCl}_4$: Crystallizes in long olive-colored prisms; can be recrystallized from water.

Hexachloropalladates (IV)



A solution of PdCl_2 with an excess of KCl (NH_4Cl) is prepared, from which bright red K_2PdCl_6 [$(\text{NH}_4)_2\text{PdCl}_6$] is precipitated on introduction of chlorine. This is rapidly suction-filtered, washed quickly with KCl (NH_4Cl)-containing water, and rinsed with alcohol.

SYNONYMS:

Potassium and ammonium palladium (IV) chlorides.

PROPERTIES:

Bright red crystals. Soluble with difficulty in water, even less soluble in KCl and NH_4Cl solutions. Crystal structure: K_2PtCl_6 type.

Diamminepalladium (II) Salts



If a slight excess of ammonia is added to a fairly dilute, cold solution of PdCl_2 , a red precipitate known as Vauquelin's salt is formed. After drying, this becomes a crystalline, flesh-colored to dark-red powder, corresponding to the formula $[\text{Pd}(\text{NH}_3)_4]-[\text{PdCl}_4]$ (analogous to Magnus's green platinum salt). On boiling in water, most of it dissolves; the solution precipitates small yellow octahedral crystals on cooling; this is *trans*- $[\text{PdCl}_2(\text{NH}_3)_2]$. Larger quantities can be easily prepared via methods described in the section on the preparation of pure palladium (p. 1580).

A PdBr_2 solution behaves in an exactly parallel manner upon addition of ammonia: a red, crystalline precipitate of $[\text{Pd}(\text{NH}_3)_4]-[\text{PdBr}_4]$ is obtained from the mixture. This undergoes the same transformation as the chloride to give yellow octahedral crystals of $[\text{PdBr}_2(\text{NH}_3)_2]$.

Pure Rhodium

Rh

I. Reasonably pure sodium or potassium hexachlororhodate (see p. 1588 for preparation) is the starting material. The salt is dissolved in water; the solution is boiled with an excess of ammonia and concentrated. This gives the so called purpureo salt $[\text{RhCl}(\text{NH}_3)_5]\text{Cl}_2$ as a straw-colored powder, which must be purified. The salt is first digested for a long time in hot 50% hydrochloric acid, is then suction filtered (removing as much water as possible) and dried. The lumps are carefully broken up with a broad glass spatula and transferred to a container of cold, concentrated H_2SO_4 (salt: H_2SO_4 ratio = 1:1.5). Too large an excess of H_2SO_4 should be avoided, and the mixture should be warmed very carefully, since otherwise an insoluble sulfate will result. Upon addition of the powder, small lumps, not wetted by the H_2SO_4 , are easily formed; these must be broken up with the glass spatula. The powder must be added in small portions with continuous stirring; the HCl escapes in bubbles, so that the mass foams. It is digested until it becomes a honeylike, viscous, lump-free yellowish paste. Hot water is added and the mass is filtered; the filtrate is allowed to run into concentrated HCl so that the resulting solution is approximately 50% in hydrochloric acid. The purified purpureo salt precipitates as a dense, yellowish-white residue. It is filtered off with suction, washed, dried, ground with a glass spatula, and boiled

for two hours with five times its quantity of concentrated HNO_3 , after which the solution is mixed with an equal volume of water. The nitrate is allowed to crystallize overnight; it is then filtered off, washed and recrystallized once from water. It is then redissolved in water, the solution is filtered, and the filtrate is again allowed to run into hydrochloric acid. The salt is washed with liquids whose compositions approximate those of the respective mother liquors. Since the salt is only slightly soluble in cold H_2O , it is given a final rapid wash with cold H_2O , preferably on a filter connected to a vacuum pump. The purpleochloride obtained in this way is placed in a covered quartz crucible set inside a graphite crucible and ignited carefully in a gas-heated or muffle furnace.

II. According to Wichers and Gilchrist, pure rhodium can be prepared as follows. The finely divided, impure metallic raw material is mixed intimately with 1.5 times its weight of NaCl and heated at 600°C in a stream of Cl_2 for 2-4 hours. It is then cooled in the stream of Cl_2 , and the fused mass is dissolved in H_2O . The insoluble residue is again treated with chlorine until all of the rhodium becomes soluble. The solution is then diluted to a concentration of 40 g. of Rh/liter and filtered. The filtrate is heated on a steam bath and NaNO_2 is added until the color changes from red to yellow; this requires about 500-550 g. of NaNO_2 per 100 g. of Rh. Finally the solution is boiled for an hour. The platinum metals and some of the base metals are converted into soluble double nitrites, while other base metals are precipitated as hydroxides or basic salts. The mixture is filtered; the cold solution is treated with Na_2S and allowed to stand overnight (5-10 g. of Na_2S is sufficient for a solution containing several hundred g. of Rh). The odor of H_2S indicates the end of the reaction, which precipitates Pb and small quantities of Pd, Pt and Ir. The filtrate is boiled to decompose the excess Na_2S . The purified solution is again treated with 30-50 g. of NaNO_2 per 100 g. of Rh (to convert the rhodium completely to the double nitrite). The cooled solution is treated with a saturated solution of NH_4Cl , which precipitates the sparingly soluble $(\text{NH}_4)_3[\text{Rh}(\text{NO}_2)_6]$, which is white when pure. This product is allowed to react with hydrochloric acid. The resulting hydrochloric acid solution of rhodium chloride is treated with NaNO_2 (after evaporating the excess of the acid) and treated again as described above, except that smaller additions of Na_2S are made in the successive purifications. Finally, the concentrated solution of rhodium chloride in hydrochloric acid is converted to $(\text{NH}_4)_3\text{RhCl}_6 \cdot \text{H}_2\text{O}$ by addition of a small excess of NH_4Cl , and the mixture is treated with 95% alcohol. The precipitate is filtered off and washed with alcohol. The $(\text{NH}_4)_3\text{RhCl}_6 \cdot \text{H}_2\text{O}$ may be redissolved in water and reprecipitated with alcohol.

The $(\text{NH}_4)_3\text{RhCl}_6 \cdot \text{H}_2\text{O}$ is ignited to rhodium sponge and post-reduced with hydrogen.

PROPERTIES:

M.p. 1970°C. Harder and more difficult to work than Pt. The solid metal and the fine rhodium blackpowder obtained by reduction from salt solutions differ in their solubility in acids. The solid metal is insoluble in all acids and mixtures of acids, and is not attacked by molten NaOH even if KNO_3 is added at dull red heat. If Rh is fused with KHSO_4 , it slowly forms the water-soluble potassium rhodium sulfate, which imparts a dark-red color to the melt; at high Rh concentrations, the melt becomes black.

REFERENCE:

E. Wichers and R. Gilchrist, *Trans. Amer. Inst. Mining Metallurg. Eng.* **76**, 619 (1928).

Rhodium (III) Chloride



The anhydrous chloride is prepared by heating the metal in a stream of Cl_2 at about 400°C. Above 800°C, it recombines to the metal and chlorine. This chloride is red and insoluble in water and acids.

However, the hydrated rhodium (III) oxide mentioned on page 1588 dissolves readily in hydrochloric acid, giving a yellow solution. On evaporation of this solution, a residue of the hydrated chloride $\text{RhCl}_3 \cdot x\text{H}_2\text{O}$ ($x = 3-4$) is left as a red deliquescent mass, which is called "water-soluble rhodium chloride" to distinguish it from the first product. Heating above 200°C converts this product to the water-insoluble RhCl_3 .

Hexachlororhodates (III)

Sodium hexachlororhodate (III), $\text{Na}_3\text{RhCl}_6 \cdot 12\text{H}_2\text{O}$

First RhCl_3 is prepared by passing Cl_2 over very fine rhodium powder at about 400°C. One part by weight of the product RhCl_3 is carefully mixed with 2-3 parts by weight of NaCl and heated to about 300°C in a stream of Cl_2 . The aqueous solution of this chlorination product is filtered; after concentration, $\text{Na}_3\text{RhCl}_6 \cdot 12\text{H}_2\text{O}$ crystallizes out as deep-red, monoclinic prismatic crystals.

Potassium hexachlororhodate (III), $K_3RhCl_6 \cdot H_2O$, $K_2[RhCl_5(H_2O)]$

A solution of the potassium salt is prepared in exactly the same way as that of the sodium salt. On concentration, the first crystallization yields $K_2[RhCl_5(H_2O)]$. This salt is dissolved in an almost saturated aqueous KCl solution and the solution concentrated; the hexachlororhodate $K_3RhCl_6 \cdot H_2O$ crystallizes out on cooling. Both of the above compounds form dark-red crystals.

Ammonium hexachlororhodate (III), $(NH_4)_3RhCl_6 \cdot H_2O$, $(NH_4)_2[RhCl_5(H_2O)]$

Concentration of a platinum-rhodium solution which has been freed of platinum by the addition of NH_4Cl yields crystals of the red $(NH_4)_3RhCl_6 \cdot H_2O$. Green crystals occasionally obtained are $(NH_4)_2PtCl_6$ containing Rh as an impurity.

A better method starts with soluble rhodium chloride (see page 1587), which is evaporated together with an excess of aqueous NH_4Cl .

If the $(NH_4)_3RhCl_6 \cdot H_2O$ is taken up in water and heated to a high temperature, the much less soluble $(NH_4)_2[RhCl_5(H_2O)]$ crystallizes out on cooling.

REFERENCE:

M. Delépine. Bull. Soc. Chim. Belgique 36, 114 (1927).

Rhodium (III) Oxide **Rh_2O_3**

I. Very pure Rh_2O_3 is obtained by heating $RhCl_3$ to 750-800°C in a stream of O_2 until Cl_2 is no longer given off.

II. The highly hydrated compound $Rh_2O_3 \cdot 5 H_2O$ is obtained when concentrated KOH is added slowly to solutions of rhodium salts. A lemon-yellow compound precipitates; after washing and drying, it becomes a pale-yellow powder. This material is not completely alkali-free and is insoluble in water; however, it dissolves readily in acids and on ignition reverts to nonhydrated Rh_2O_3 , which is insoluble in acids.

SYNONYM:

$Rh_2O_3 \cdot 5 H_2O$: Rhodium hydroxide.

REFERENCES:

- I. Gmelin. Handb. d. anorg. Chem. [Gmelin's Handbook of Inorganic Chemistry], 8th ed., Rhodium, p. 46; L. Wöhler and W. Müller. Z. anorg. allg. Chem. 149, 132 (1925).
- II. F. Krauss and H. Umbach. Z. anorg. allg. Chem. 180, 47 (1929); G. Grube and G. Bau-Tschang Gu. Z. Elektrochem. 43, 398 (1937).

Rhodium Sulfate

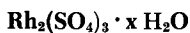

According to Krauss and Umbach, attempts to prepare rhodium sulfate from rhodium hydroxide and sulfuric acid lead to two different products, depending on the conditions: these are yellow rhodium sulfate $\text{Rh}_2(\text{SO}_4)_3 \cdot 15 \text{H}_2\text{O}$ and red rhodium sulfate $\text{Rh}_2(\text{SO}_4)_3 \cdot 4 \text{H}_2\text{O}$.

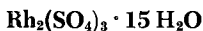

The yellow sulfate is produced on solution of moist hydrated rhodium (III) oxide (rhodium hydroxide) in dilute (1:10) sulfuric acid at temperatures not exceeding 50°C. Then the hydrated Rh (III) oxide is precipitated from the cold solution with KOH (avoiding an excess of the latter) and washed on a membrane filter until the colloidal hydroxide passes through. Suction is then applied and as much water as possible is removed; the residue is dissolved without heating in dilute sulfuric acid.

The solid salt is obtained by evaporating this solution in vacuum, dissolving the residue in absolute alcohol, and precipitating with 10-20 times its volume of ether; this gives a pale-yellow, fine, flocculent residue. After filtration, washing and drying, this becomes a light, yellowish-white powder. The yield is always poor, at most 20%.

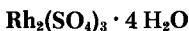

Red, amorphous rhodium sulfate is obtained either by evaporating a solution of the isomeric yellow salt or by precipitating hydrated Rh (III) oxide from a RhCl_3 solution at the boiling point, washing the precipitate with hot water, dissolving it in hot dilute sulfuric acid, and evaporating the mixture. To remove the excess H_2SO_4 , the product is dissolved in H_2O and $\text{Ba}(\text{OH})_2$ is added until Rh (III) hydroxide begins to precipitate. The solution is filtered and again evaporated.

The two sulfates undergo quite different precipitation reactions. Barium chloride precipitates the SO_4^{2-} almost quantitatively from solutions of the yellow salt prepared in the cold. These are acidic and KOH precipitates the rhodium from such solutions. On the other hand, the red salt solutions prepared under the same conditions either fail to give these reactions, or react only gradually, but in any case, not quantitatively. We must therefore conclude that in this last case we are dealing with a complex in which the bonds are stronger than in the yellow salt.

REFERENCE:

F. Krauss and H. Umbach. Z. anorg. allg. Chem. 180, 42 (1929).

Chloropentaamminerhodium Salts



The preparation of the chloride and nitrate of these compounds, which are also known as purpureo salts, is given in the section on the preparation of pure rhodium (p. 1585 ff.).

Pure Iridium

Ir

Chemically pure iridium is best prepared by ignition of $(\text{NH}_4)_2\text{IrCl}_6$. To obtain especially pure material, the metal should be reconverted to $(\text{NH}_4)_2\text{IrCl}_6$ (see p. 1594), which is then re-ignited.

PROPERTIES:

Very hard, fairly brittle metal; m.p. 2454°C. On ignition in air, forms small quantities of a volatile unstable oxide, IrO_3 ; thus, under conditions of oxidizing ignition the weight of Pt-Ir alloys does not remain constant. Extraordinarily resistant to acids; insoluble even in aqua regia. Attacked with comparative ease by Cl_2 , particularly in the presence of NaCl, with which the nascent chloride forms a double salt.

Iridium (IV) Oxide

IrO_2

In the method of Wöhler and Streicher, IrO_2 is prepared from green IrCl_3 which can be readily oxidized in a stream of O_2 at 600°C, giving blue-black IrO_2 .

The oxidation of fine iridium powder in a stream of air or oxygen does not give IrO_2 quantitatively.

PROPERTIES:

Black to blue-black powder, insoluble in acids. Crystal structure: rutile type.

REFERENCE:

- L. Wöhler and S. Streicher. Ber. dtsh. chem. Ges. 46, 1721 (1913).

Hydrated Iridium (IV) Oxide

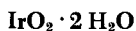

I. An aqueous solution of IrCl_4 or H_2IrCl_6 , prepared by the old method of Vauquelin (see H_2IrCl_6 , method I, p. 1593), is evaporated several times to a sirupy consistency in a vacuum at 40°C . After each evaporation, the sirup is redissolved in water; this treatment completely removes the excess of HCl . The final concentrate is again diluted, and dilute aqueous KOH is added in drops to the boiling solution until the color changes from dark red-brown to green and then to blue. The solution is then held at the b.p. for some time to oxidize any Ir (III) which may be present and to complete the precipitation of the hydrated Ir (IV) oxide. The residue of deep-blue coarse floc is filtered off, washed with water, then with absolute alcohol, and dried in a vacuum desiccator.

II. Gerlach's method consists in adding the KOH solution in drops to a boiling solution of Na_2IrCl_6 , to give the alkali-free hydrated oxide. The use of excess hydroxide leads to a product which contains alkali. Purification is the same as in method I.

PROPERTIES:

Very dark-blue powder. The hydrated oxide prepared by method I may be converted to IrO_2 at 350°C in a stream of N_2 . Freshly precipitated $\text{IrO}_2 \cdot 2\text{H}_2\text{O}$ is soluble in acids.

REFERENCES:

- I. F. Krauss and H. Gerlach. Z. anorg. allg. Chem. 143, 126 (1925).
II. H. Gerlach. Thesis, Tech. Hochschule, Braunschweig, 1925, pp. 4, 42; N. K. Pschenizyn and S. E. Krassikow, abstract in Chem. Zentr. 1933, I, 3911.

Hydrated Iridium (III) Oxide



A solution of Na_3IrCl_6 is prepared either in the same way as in method II for $\text{K}_3\text{IrCl}_6 \cdot 3 \text{H}_2\text{O}$ (see p. 1594) or, better, as suggested by Ogawa, from a solution of Na_2IrCl_6 and sodium oxalate at 50°C according to the equation

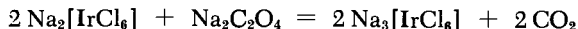

In either case the solution is treated with potassium hydroxide or potassium carbonate solution in a stream of CO_2 . The separation, washing and drying of the hydrated oxide must be carried out under an inert gas (CO_2 or N_2). The alkali cannot be completely removed from the product.

PROPERTIES:

Pale-green to dark powder, depending on the precipitation conditions and water content; oxidized in air to the hydrated Ir (IV) oxide, particularly when damp. The Ir (III) compounds are more stable in acid solutions than the Ir (IV) salts; the reverse is true in alkaline solutions.

REFERENCES:

L. Wöhler and W. Witzmann. *Z. anorg. Chem.* **57**, 334 (1908); Preparation of Na_3IrCl_6 solution: E. Ogawa. *J. Chem. Soc. Japan* **50**, 246 (1929).

Iridium (III) Chloride

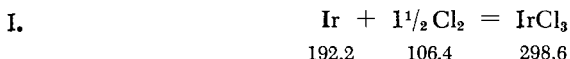

Fine iridium powder is placed in a porcelain boat set in an open-end glass combustion tube. The gas inlet side of the tube is drawn to a small-diameter tubing, while the other end carries a ground-glass joint. An O_2 -free stream of chlorine, containing a small percentage of CO , is passed through the tube, which is heated to about 600°C with a burner and illuminated either with direct sunlight or light from a burning magnesium ribbon. The chlorination is complete in about 15 minutes.

II. Alternatively, $\text{IrO}_2 \cdot 2 \text{H}_2\text{O}$ is heated to 240°C in a stream of Cl_2 and illuminated with sunlight or a burning magnesium ribbon.

III. Finally, $(\text{NH}_4)_2\text{IrCl}_6$ may be decomposed in a stream of Cl_2 at $440\text{--}550^\circ\text{C}$; the conversion of 0.5 g. requires two hours.

PROPERTIES:

Dark olive-green powder. Stable up to 760°C under a Cl_2 pressure of 1 atm. (Streicher); at 700°C the color changes to bright yellow.

REFERENCES:

- F. Krauss and H. Gerlach. *Z. anorg. allg. Chem.* 147, 265 (1925);
L. Wöhler and S. Streicher. *Ber. dtsch. chem. Ges.* 46, 1720, 1582 (1913); S. Streicher. Thesis, Univ. of Darmstadt, 1913.

Hexachloroiridic (IV) Acid



I. A solution of $(\text{NH}_4)_2\text{IrCl}_6$ is decomposed by bubbling Cl_2 through it at about 4°C ; then the liquid is concentrated at 40°C (12-15 mm.) until a dark-brown sirupy mass results. This is allowed to stand for some time in an evacuated desiccator containing CaO (until it congeals and crystallizes). The low temperatures mentioned must be maintained to avoid the formation of NCl_3 .

II. A solution of $(\text{NH}_4)_2\text{IrCl}_6$ is heated with aqua regia on a water bath (approximately 10 hours) until the NH_4^+ is completely split off; the solution is repeatedly concentrated with conc. HCl until the HNO_3 is completely removed.

REFERENCES:

- I. Vauquelin. *Liebigs Ann.* 89, 150, 225 (1845); A. Gutbier and F. Lindner. *Z. phys. Chem.* 69, 304 (1909).
II. S. C. Woo and D. M. Yost. *J. Amer. Chem. Soc.* 53, 884 (1931).

Potassium Hexachloroiridate (IV)



I. A mixture of fine iridium powder and twice its weight of KCl is heated in a porcelain boat almost to red heat while chlorine is

passed over it. After cooling, the excess KCl is extracted by washing with the least possible quantity of cold water. Then the double salt is dissolved in boiling water and filtered free of unconverted Ir. The solution is slowly evaporated in a porcelain dish. The K_2IrCl_6 crystallizes as small, shiny, red-black octahedra, which yield a red powder on grinding.

In the above extraction with boiling water it is best to add a few drops of nitric acid in order to prevent the formation of K_3IrCl_6 and convert any Ir (III) present to Ir (IV).

II. According to Puche, better results are obtained by allowing Na_2IrCl_6 solution to react with solid KCl while a stream of Cl_2 is bubbled through the mixture. The crystalline deposit is filtered off with suction and washed several times with dilute alcohol. It is then rapidly washed with some water. The product is dried in a drying oven at about $100^\circ C$.

PROPERTIES:

Deep dark-red octahedra. Solubility ($20^\circ C$) 1.12 g./100 g. H_2O . Insoluble in alcohol. d 3.5.

REFERENCES:

- I. Old process of Berzelius: G. Gire. *Ann. Chim.* 4, 210 (1925).
- II. F. Puche. *Ibid.* 9, 270 (1938).

Ammonium Hexachloroiridate (IV)

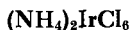

A mixture of iridium metal powder plus twice its weight of NaCl is converted to Na_2IrCl_6 by heating to $400^\circ C$ in a stream of Cl_2 (compare the preparation of the analogous K_2IrCl_6); this salt is dissolved in some water. Addition of NH_4Cl to this solution [or to other solutions of Ir (IV)] leads to the formation of $(NH_4)_2IrCl_6$; the latter is only slightly soluble.

SYNONYM:

Ammonium iridium (IV) chloride.

PROPERTIES:

Dark-red octahedra. Solubility (cold) about 5 g., ($100^\circ C$) about 10 g./100 ml. H_2O . d 3.03. Crystal structure: K_2PtCl_6 type.

REFERENCE:

- A. Gutbier. *Z. phys. Chem.* 69, 307 (1909).

Potassium Hexachloroiridate (III)

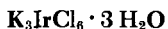

I. A hydrogen stream is passed over gently heated (not over 150°C) K_2IrCl_6 placed in a quartz or porcelain boat; the reduction proceeds according to the equation

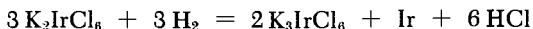

II. A solution of K_2IrCl_6 (the concentration should be as high as possible) in freshly prepared H_2S water is heated until the color turns olive-green. Then KCl is added and crystals of $\text{K}_3\text{IrCl}_6 \cdot 3\text{H}_2\text{O}$ deposit out; these can be dehydrated, if need be. The K_2IrCl_6 can be reduced with SO_2 in the same manner, but the product must be neutralized with K_2CO_3 .

Alternate method: Reduction with oxalate: see section on $\text{Ir}_2\text{O}_3 \cdot x\text{H}_2\text{O}$ (p. 1592).

SYNONYM:

Potassium iridium (III) chloride.

PROPERTIES:

Dark olive-green crystals. Readily soluble in water, insoluble in alcohol.

REFERENCE:

I. F. Puche. *Ann. Chim.* 9, 273 (1938).

Pure Ruthenium

Ru

Gutbier and Trenkner give the following method for the preparation of the pure metal. To start with, 30 g. of the fine metal powder is heated to dull red heat for three hours in a stream of O_2 in order to volatilize Os, which is often present as an impurity. The partially oxidized Ru is then reduced in a stream of H_2 ; then a mixture of the metal, the purest KOH , and the purest KNO_3 (3 : 25 : 3 by weight) is prepared and fused in a flat silver dish.

The green melt is kept in the liquid state for half an hour. It is then cooled, and the reaction product is broken into small lumps and dissolved in lukewarm water. The orange-yellow solution is poured into a large retort, the neck of which is joined to a 2-m.-long glass tube in such a way that the neck of the retort projects as far as possible into the tube. That tube is placed in a metal trough of about the same length filled with an ice-salt mixture. The other end of the tube is connected to a flask half-filled with 30% KOH. Then a fast stream of dry Cl_2 is introduced through the filler tube of the retort. So much heat of reaction is evolved that the RuO_4 distills over in a very short time. It is in the form of golden-yellow drops which solidify as a yellowish-red mass in the cooled condenser tube.

As soon as the formation of the tetroxide subsides, the contents of the retort are heated to 80-90°C with a microburner while continuing to introduce Cl_2 ; the whole operation is stopped only when a yellow vapor (a mixture of RuO_4 and Cl_2) can be seen in the attached flask. Since only ruthenium is capable of forming volatile compounds under these conditions (the osmium having been removed previously), all the other impurities remain in the retort.

To convert the tetroxide to the metal, the RuO_4 is washed out from the tube with lukewarm water, transferred to a porcelain dish and, when completely dissolved, reduced immediately with pure alcohol (if the alcohol is added before solution is complete a violent explosion may occur!). The resulting inky liquid is concentrated on a water bath and the residue reduced to elemental Ru with pure H_2 .

Alternate method: A method which is related to the analytical procedure of Wichers et al. separates the osmium by distillation of a nitric acid solution of the products of the alkali fusion step. The residue from this distillation is made alkaline and ruthenium is then distilled off, using Cl_2 as above. Regarding the danger of explosions, see the properties of RuO_4 .

PROPERTIES:

M. p. \sim 2400°C; d 12.43. Very hard and brittle; can be pulverized. When melted, part of the metal oxidizes and volatilizes as RuO_4 , which is stable at very high temperatures and gives off a peculiar choking odor.

REFERENCES:

- A. Gutbier and C. Trenkner. *Z. anorg. Chem.* **54**, 167 (1905); E. Wichers, R. Gilchrist and W. H. Swanger. *Trans. Amer. Inst. Mining Metallurg. Eng.* **76**, 626 (1928).

Ruthenium (IV) Hydroxychloride



Heating of RuO_4 with conc. HCl on a water bath gives a dark-brown solution; according to Remy and Wagner, this contains the Ru (IV) chloride. If inhibited, the reaction (which involves the splitting off of Cl_2) can be started by addition of a few drops of alcohol. The product solution is evaporated and a dark-brown product $[\text{Ru(OH)Cl}_3]$ is obtained. On the basis of an early incorrect assumption, this is often called "water-soluble ruthenium trichloride."

PROPERTIES:

Dark-brown salt. Very readily soluble in water. A certain proportion is apparently always present as RuCl_3 .

REFERENCES:

- A. Gutbier and C. Trenkner. *Z. anorg. Chem.* **45**, 167 (1905). H. Remy and A. Lührs. *Ber. dtsch. chem. Ges.* **61**, 917 (1928); **62**, 201 (1929); H. Remy. *Ibid.* **61**, 2110 (1928).

Ruthenium (III) Chloride



RuCl_3

I. In the method of Remy et al., a mixture of carefully predried Cl_2 and CO (initial ratio of 1:4) is passed over a boat containing ruthenium powder and placed in a Vycor combustion tube. After displacing all the air from the tube, the latter is heated to 700-800°C, and the fraction of Cl_2 in the gas stream is simultaneously increased. The beginning of the reaction is clearly marked by a considerable swelling of the material. At the end of the reaction the boat is kept for half an hour at bright red heat, and the CO throughput is gradually reduced and finally stopped. Cooling in the Cl_2 stream yields a well-crystallized product.

II. In the method of Wöhler and Balz, RuCl_3 is prepared without the use of CO . A mixture of the metal and NaCl is heated at 700°C in a stream of Cl_2 , after which the products are reduced with H_2 at 400°C and extracted with H_2O . The finely divided, velvety-black metal obtained in this way is chlorinated at 800°C.

PROPERTIES:

Formula weight 207.5. Method I gives good crystals in the form of shiny black platelets. Insoluble in water.

REFERENCES:

- I. H. Remy (with M. Köhn). *Z. anorg. allg. Chem.* 137, 365 (1924);
H. Remy and Th. Wagner. *Ibid.* 168, 2 (1928).
- II. L. Wöhler and P. Balz. *Ibid.* 139, 413 (1924).

 $\text{RuCl}_3 \cdot \text{H}_2\text{O}$

Since warm hydrochloric acid solutions of Ru (III) are partly oxidized by atmospheric oxygen (for example, on concentration) commercial "water-soluble ruthenium trichloride" is not free of Ru (IV). A pure product corresponding to the formula $\text{RuCl}_3 \cdot \text{H}_2\text{O}$ can be obtained from this material by electrolytic reduction.

A cathode of platinized Pt foil (40 × 35 mm.) and an anode of polished Pt foil are suspended inside a small porous clay cylinder placed inside a rectangular, 200-ml. glass trough. The cathode liquid is a 0.03 M solution of commercial RuCl_3 [or a solution of an evaporation residue which corresponds approximately to $\text{Ru}(\text{OH})\text{Cl}_3$] which is 2N in HCl; the anode liquid is 2N HCl. Efficient stirring is necessary. The electrolysis is carried out at 0.03-0.1 amp., with separate control of the cathode potential. The initial dark-brown color of the solution gradually clears. The electrolysis is stopped when the cathode potential becomes constant at 0.01 volt and H_2 evolution commences. The reduced solution should be red. A blue color indicates the formation of the undesirable Ru (II).

The RuCl_3 solution must be concentrated to crystallization in the absence of air, in order to prevent reoxidation by atmospheric oxygen. The evaporation is carried out in a round-bottom flask fitted with a dropping funnel; the flask is purged of air with HCl gas. The reduced solution is then introduced via the dropping funnel; with HCl continuously passing over it, it is evaporated at the boiling point to a sirupy thickness, and finally to dryness at 80-100°C. It is finally dried to constant weight in a vacuum desiccator over H_2SO_4 .

The salt obtained in this way is free of Ru (IV) and has the composition indicated by the formula.

REFERENCE:

- G. Grube and G. Fromm. *Z. Elektrochem.* 46, 661 (1940).

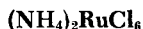
Ammonium Hexachlororuthenate (IV)

A concentrated solution of NH_4Cl is added to a ruthenium chloride solution and the resultant mixture concentrated in air. The dark-red crystalline powder is not homogeneous; it contains $(\text{NH}_4)_2[\text{Ru}(\text{OH})\text{Cl}_5]$.

SYNONYM:

Ammonium ruthenium (IV) chloride.

Ruthenium (IV) Oxide

In the method of Remy and Köhn, RuO_2 is prepared by heating fine ruthenium powder at about 1000°C in a stream of carefully predried O_2 . It can also be prepared by ignition of RuS_2 in air (the RuS_2 is obtained by precipitation of ruthenium chloride solutions with H_2S). Wöhler et al. suggest heating pure RuCl_3 at $600\text{--}700^\circ\text{C}$ in a stream of O_2 .

PROPERTIES:

Dark-gray powder with a metallic luster, iridesces green and blue. Insoluble in acids. Readily reduced by H_2 even at moderate heating. d 7.0. Crystal structure: rutile type.

REFERENCES:

- H. Remy (with M. Köhn). *Z. anorg. allg. Chem.* **137**, 381 (1924);
L. Wöhler, P. Balz and L. Metz. *Ibid.* **139**, 213 (1924).

Ruthenium (VIII) Oxide

Chlorine is passed through a solution of an alkali ruthenate, as described earlier in the section on the purification of ruthenium.

In another method (Ruff and Vidic) mixtures of ruthenium powder with KMnO_4 and KOH are fused; the ruthenate produced in this way is decomposed with H_2SO_4 while still hot; a CO_2 stream is simultaneously passed through the reaction vessel and the RuO_4 distills off.

A mixture of Ru, KMnO_4 and KOH (1 : 2 : 20 by weight) is fused to a mobile liquid. The dark-green melt is kept liquid for 0.5-1 hour after all the permanganate has been added. After cooling, the melt is dissolved in water and placed, with one additional part of KMnO_4 , in a flask fitted with a dropping funnel and containing 1 : 3 H_2SO_4 . An ice-cooled flask containing some water is used as the first receiver (no alcohol! see properties), followed by a flask containing some 7% NaOH. Sulfuric acid is introduced until the color changes from green to red; then further H_2SO_4 (1/3 of the total liquid volume) is added. After this a fast air stream is bubbled through while the solution is heated to 40-50°C. Long golden-yellow needles of RuO_4 soon form in the ice-cooled flask. Later, ruthenate is formed in the NaOH solution, producing an orange-red color. Finally the solution is heated to boiling in order to steam-distill any remaining RuO_4 . The yield is almost quantitative.

PROPERTIES:

Formula weight 497.1. A solid composed of golden-yellow rhombic prisms. Very volatile, subliming even at room temperature. Characteristic odor comparable to nitric oxide or ozone; very irritating to the respiratory tract. Less irritating to the eyes than OsO_4 . Melts at 25°C to an orange-red liquid. Solubility (20°C): 20.3 g./liter of H_2O . Vapors and concentrated solutions tend to react explosively with organic substances, such as alcohol, filter fibers, etc. Distillation must therefore be carried out in perfectly clean equipment.

REFERENCE:

O. R. Ruff and E. Vidic. Z. anorg. allg. Chem. 136, 49 (1924).

Potassium Ruthenate and Potassium Perruthenate



A dark-green melt is obtained by heating a mixture of Ru powder with KOH and adding KClO_3 or KNO_3 ; this readily takes up water, giving an orange-red solution. On evaporation, $\text{K}_2\text{RuO}_4 \cdot \text{H}_2\text{O}$ crystallizes in iridescent green prisms which appear red when spread in thin layers and viewed by transmitted light. If Cl_2 is introduced into the red solution, the latter becomes green due to the formation of perruthenate. Continued passage of Cl_2 yields RuO_4 . However, if the Cl_2 stream is shut off at the right moment, KRuO_4 is precipitated on cooling as small black tetragonal crystals. In contrast to the ruthenates, the perruthenates are not stable above 200°C.

REFERENCES:

- A. Gutbier, F. Falco and H. Zwicker. *Z. anorg. Chem.* 22, 490 (1909); F. Krauss. *Z. anorg. allg. Chem.* 132, 306 (1924).

Pure Osmium

Os

Osmium powder is purified by fusion in an oxidizing alkali melt. Nitric acid liberates the volatile OsO_4 from an aqueous solution of this melt; the OsO_4 is distilled in a stream of air into a receiver containing aqueous NaOH and is absorbed. The osmium is then reprecipitated as OsS_2 and filtered off. It is reduced to the metal in a stream of hydrogen.

The procedure is almost the same as in the purification of ruthenium. The fine metal powder is mixed with KOH and KNO_3 and fused at red heat. After cooling, the melt is dissolved in water in a retort. Nitric acid is added until the solution becomes acidic, and the OsO_4 liberated is carried in an air or oxygen stream to a receiver containing aqueous NaOH, in which it is absorbed. The solution is treated with H_2S , which precipitates the osmium quantitatively (as OsS_2). The precipitate is filtered off and reduced in a stream of hydrogen.

Since the sulfur is difficult to extract from the metal after the hydrogen reduction, the distillation receiver can also be charged with aqueous KOH (instead of NaOH), the resulting osmic acid salt may be reduced to K_2OsO_4 with alcohol, and the K_2OsO_4 reduced to Os with H_2 .

PROPERTIES:

M.p. $> 3000^\circ\text{C}$. Very hard and brittle, readily pulverized. The powder always retains the characteristic odor of OsO_4 , since traces of the latter are formed in air even at room temperatures. Heating in air leads to complete combustion to OsO_4 .

Osmium (IV) Chloride

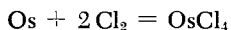
 OsCl_4 

190.2 141.8 332.1

Small quantities of Os (prepared, for instance, by reduction of OsO_2 with H_2) are heated to $650\text{--}700^\circ\text{C}$ in a porcelain boat set in

a glass combustion tube, while a slow stream of very pure Cl_2 is passed through. The tube is constricted beyond the boat and lagged for 20 cm. with asbestos to produce a zone of gradual temperature drop. About 2 hours are required for 0.2-0.5 g. of Os to react. The chloride precipitates in various forms (crusts to powders) and in various colors (black to red-brown). It deposits in the reactor tube at and beyond the constriction. The tube is melt-sealed at the constriction, and the part of the tube containing the chloride is evacuated, a cooling trap being inserted before the pump. The material is sublimed in vacuum, using the same tube, and deposited in a further section of the tube.

PROPERTIES:

Black crust with a metallic luster, or red-brown powder. Insoluble in water and other solvents and in concentrated oxidizing acids. Slowly hydrolyzed by water. The above product does not correspond exactly to the composition given by the formula.

REFERENCE:

O. Ruff and F. Bornemann. *Z. anorg. Chem.* 65, 446 (1910).

Sodium Hexachloroosmate (IV)



In the method of Gutbier and Maisch, fine osmium powder and NaCl are mixed in a 1:1 ratio and the mixture heated in a porcelain boat in a stream of Cl_2 for half an hour, at which point the temperature should correspond to a dull red heat. The conversion to Na_2OsCl_6 is almost complete. The sintered contents of the boat are dissolved in the minimum quantity of cold dilute hydrochloric acid. The unreacted metal is filtered off and the filtrate is saturated with HCl (careful cooling). Most of the excess NaCl is thus separated although part of the Na_2OsCl_6 also precipitates out.

Gradually evaporation of the filtrate yields Na_2OsCl_6 as beautiful crystals, which, however, obstinately retain traces of NaCl even after repeated crystallization from dilute hydrochloric acid.

REFERENCE:

A. Gutbier and K. Maisch. *Ber. dtsch. chem. Ges.* 42, 4239 (1909).

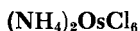
Ammonium Hexachloroosmate (IV)

In the method of Gutbier and Maisch, this salt is precipitated by allowing a dilute alcoholic solution of NH_4Cl to react with the stoichiometric quantity of Na_2OsCl_6 (also in alcoholic solution). The precipitate is a fine, dark-red powder. It crystallizes from dilute hydrochloric acid (or from a mother liquor consisting of the components) in beautiful, shiny black octahedra which are opaque under the microscope.

Gutbier claims that $(\text{NH}_4)_2\text{OsCl}_6$ is also obtained by dissolving in HCl the sublimates from osmium fusion, concentrating the solution, and mixing the filtered liquid with NH_4Cl .

REFERENCE:

A. Gutbier and K. Maisch. Ber. dtsch. chem. Ges. 42, 4239 (1909).

Osmium (IV) Oxide

Osmium (VIII) oxide is reduced in the cold by a stream of H_2 . If, however, the OsO_4 is heated in the H_2 stream, the product is the metal. Osmium (IV) oxide can also be prepared by heating a fine powder consisting of a mixture of K_2OsCl_6 and three times its amount of Na_2CO_3 . The temperature should be lower than red heat; the cooled product is extracted with water which is slightly acidified with dilute hydrochloric acid. The product is perfectly pure OsO_2 .

Alternate method: Heating of Os to 600-610°C in a nitrogen stream saturated with OsO_4 vapor. Unreacted OsO_4 is reclaimed from the nitrogen stream by cooling it to a low temperature [O. Ruff and H. Rathsburg, Ber. dtsch. chem. Ges. 50, 495 (1917)].

PROPERTIES:

Formula weight 222.2. d 11.4. Black powder. Insoluble in water and acids. Forms OsO_4 on heating in air; readily reduced to the metal by H_2 . Crystal structure: rutile type.

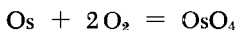
Osmium (VIII) Oxide

190.2	64.0	254.2
-------	------	-------

Pure OsO_4 is best prepared by a dry method. Osmium powder is heated in a boat placed in a glass or quartz tube through which a

stream of dry oxygen is passed. The metal burns to OsO_4 , which deposits beyond the heated zone of the tube or, better, in a bulb fused to the tube and cooled in ice. The deposit consists of white shiny crystals, though at first it may be a liquid (occasionally pale yellow in color), which forms a crystalline solid on cooling. Two or three receivers, preferably connected via ground-glass joints, are fitted to the glass tube beyond the bulb. They are half-filled with KOH to absorb the OsO_4 vapor entrained by the oxygen. The OsO_4 in the receivers is reclaimed by reduction to potassium osmate (violet-blue octahedra); this is accomplished by treating the combined caustic liquors from the receivers with an equal quantity of alcohol.

The temperature at the boat is increased gradually so that the reaction does not proceed too vigorously, heating initially to 300°C and gradually increasing the temperature to 800°C . The temperature is then slowly reduced, and the product allowed to cool in the tube. The heating is most conveniently carried out in a small tubular electric furnace.

PROPERTIES:

M.p. $40.6\text{--}40.7^\circ\text{C}$, b.p. 130°C ; d 4.9. Soluble in water without decomposition; may be volatilized in steam. Dissolves slowly. Decomposed by conc. HCl with evolution of Cl_2 . A solution of OsO_4 is not decomposed by light and can be indefinitely stored in transparent bottles. Toxic; the vapor first irritates the respiratory passages and (particularly) the eyes. Decomposed in a stream of H_2 at red heat, forming a mirror.

Potassium Osmate (VI)

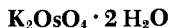

A solution of OsO_4 in potassium hydroxide solution is reduced with alcohol.

Osmium powder (2 g.) is heated with 5 g. of KOH and 3 g. of KNO_3 in a silver dish to form a smoothly flowing melt. After cooling, the brown solid is dissolved in 50 ml. of water. The gray-violet crude salt is precipitated by adding twice the volume of alcohol. It is readily decomposed and cannot be recrystallized from water. It is decomposed by heating with 5 g. of CrO_3 and conc. H_2SO_4 , the OsO_4 distilling off is collected in 10% KOH, and $\text{K}_2\text{OsO}_4 \cdot 2\text{H}_2\text{O}$ is precipitated from the resulting solution by adding an equal volume of alcohol. The solid is filtered off with suction, washed with 50% alcohol and with absolute alcohol, and dried in vacuum over H_2SO_4 .

In a simpler method, osmium powder is heated directly in a stream of O_2 (compare preparation of OsO_4), and the OsO_4 vapor is collected in 10% KOH.

PROPERTIES:

Pale violet-red octahedra. Readily soluble in water, insoluble in alcohol and ether. Stable only in dry air. The water of crystallization is removed by heating to $200^\circ C$ in an inert gas. Heating in air produces OsO_4 .

REFERENCE:

O. Ruff and F. Bornemann. *Z. anorg. Chem.* 65, 434 (1910).

Potassium Osmiamate

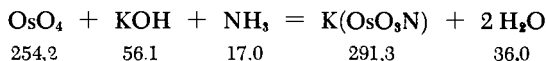

In the method of Joly, 100 g. of OsO_4 is dissolved in a solution of 100 g. of KOH in 50 ml. of H_2O ; the solution is heated to $40^\circ C$ and dilute ammonia is added; this clears the dark-brown liquid and precipitates $K(OsO_3N)$ as a granular, yellow crystalline powder.

Excess ammonia should be avoided because it may produce $NH_4(OsO_3N)$. The product is washed with some cold water and recrystallized. Larger crystals may be obtained by gradual evaporation of the solution; however, these crystals are dark due to incipient decomposition.

PROPERTIES:

Fine, granular, yellow crystals. Readily soluble in water, only slightly soluble in alcohol. Darkens on heating to $180^\circ C$, with decrepitation at higher temperatures. d 4.5. Tetragonal crystals.

REFERENCE:

A. Joly. *Comptes Rendus Hebd. Séances Acad. Sci.* 112, 1442 (1891).

Part III
Special Compounds

Adsorbents and Catalysts

R. WAGNER

Introduction

Solid adsorbents or catalysts must possess large surface areas to allow contact with large quantities of reactants. Large surface areas can be obtained via two methods:

1) SUBDIVISION OF THE SOLID

The solid is subdivided into very small granules so that a large fraction of the total crystal lattice structure becomes exposed as particle surface. Comparison of x-ray and ultramicroscopic data then shows whether the resulting granules are primary particles (i.e., coherently diffracting single crystals) or secondary particles (i.e., a mosaic consisting of several primary crystals).

2) CREATION OF A NETWORK OF INTERNAL PORES

In this case, the solid is permeated by a system of pores (interconnected or not), somewhat in the manner of a sponge. The net result is the creation of a large internal surface. The pore openings of such active solids should not be too narrow since they must allow the gases to penetrate into the interior (see [8]).

The two methods of achieving high surface may be illustrated on the classic catalyst, platinum; thus, platinum black is the subdivided solid, while platinum sponge is the porous form.

Active substances not only must have a large surface area, but must also possess a proper surface structure. As a general rule, one can expect the surface lattice of metals and ionic compounds to differ from the interior lattice of the crystal [12, 13, 14]. Thus, the active surface is very readily affected by external agents (such as impurities), and is also subject to other influences, such as the method of preparation, etc. In addition, it is often found that the same particle may carry several crystallographically differing surfaces. Obviously, these will differ not

only in their chemical properties [2, 4, 5] but also in their catalytic activity [7, 9, 11]. This fact, as well as the presence of intrinsic and impurity defects in the lattice, results in an overall surface which is usually very heterogenous; this, in turn, affects its adsorptive and catalytic behavior.

The methods of controlling particle size, surface area and surface structure during preparation of various adsorbents and catalysts are given in the preparative directions for individual substances, as well as in the general notes. A more extensive treatment of these problems is given in Ref. [A], especially in the articles in Vol. 4. The usual methods are frequently employed to obtain substances whose activity is not only related to their particle size and surface structure, but is also a direct consequence of other factors such as lattice defects, amorphism, the existence of unstable modifications [1, 10], etc.

We have seen in the above that the activated state of solids, which is the result of the existence of special conditions in the material, is rather unstable and can easily be destroyed. In the preparation of activated solids, this state is fixed by removing the conditions favorable to a transition to a more stable form (for example, slow aging at preparative conditions); i.e., the solid is "frozen" in the activated state. This may be done, for example, by rapid quenching, quick removal of supernatant mother liquors, etc. The active state also implies higher than normal surface energies. For this reason, active materials are generally very reactive, and are frequently used in heterogeneous reactions (solid-solid, solid-liquid, or solid-gas). They are more readily decomposed chemically than inactive preparations; thus, active metals oxidize faster, oxides hydrate more easily, hydroxides and hydrated oxides are more sensitive to CO_2 . All of these solids decrease in activity with time, due to a slow healing of surface defects and an eventual increase in grain size. The kinetics of such aging processes are in some ways analogous to those of the ion-hole processes in semiconductors. Aging proceeds via a series of individual steps and, depending on the activation energy of these steps, different optimum temperatures are required if the aging is to proceed at a significant rate. The temperature scale of Hüttig [6], derived as an extension of the work of Tammann (see table), is based on studies of metals and ionic compounds and provides a useful rule-of-thumb guide to the temperatures at which these processes take place.

It is seen from the table that some healing of surface defects is possible without undue reduction of particle size. In general, however, the temperature of any heat treatment of active materials must be strictly controlled to avoid deleterious effects. In heterogeneous gas catalysis, reaction temperatures exceeding those recommended in the table are often unavoidable; this leads to a

Period	α^*	Processes occurring in the catalytic material
Initial surface degradation	< 0.23	Reduction in adsorbing surface; degradation of those surface defects which possess the highest energy.
Surface activation	0.23-0.36	Degradation of surface defects.
Deactivation of the surface	0.33-0.45	Formation of a surface which is stable in a thermal equilibrium; beginning of particle sintering.
Activation of the crystal center	0.37-0.53	Degradation of defects in the interior of the crystal.
Deactivation of the interior of the crystal	0.48-0.8	Accretive crystallization.
Relaxation and disintegration of the crystal	> 0.8	Stage prior to melting.

* $\alpha = T/T_m$, where T is the temperature of the experiment and T_m the melting point of the substance ($^{\circ}\text{K}$).

rapid inactivation of the catalyst. In such cases a stabilization of the surface and of the remainder of the defect structure may be achieved by precipitating the catalyst onto a suitable carrier substance. This method is also used to transform into a quasi-solid form substances that, when pure, normally exist only in a subdivided form.

Such carriers must have good accessibility to gases, combined with reasonable mechanical strength and thermal stability. The frequently used carriers are:

NATURAL MATERIALS

Pumice, kieselgur, various silicates (asbestos, meerschaum, etc.), adsorbent clays, etc.

SYNTHETIC MATERIALS

Magnesium oxide, γ -aluminum oxide, synthetic rutile, thorium dioxide, silica gels, barium sulfate, activated carbons, metallic network supporting structures, various silicates (especially of Mg, Al), etc.

Natural materials are transformed into carriers in a variety of ways such as slurring, washing and treatment with acids or alkalis; or they may have to be fractionated to separate the most active structures before the catalyst itself is deposited. Catalytic substances containing alumina, silica, thoria and similar carriers may also be obtained by coprecipitation.

It is frequently observed that the activity of a catalyst varies with the carrier and substrate and that certain catalyst-substrate combinations give especially good results (see [3]). This is a particular case of catalyst promotion which is frequently observed in mixed catalysts. This phenomenon is of great practical importance. It permits the creation of catalyst mixtures that are very active and capable of influencing reactions in a very specific manner, something that the individual components of the combination cannot achieve qualitatively or quantitatively.

REFERENCES:

- [A] Handbuch der Katalyse [Handbook of Catalysis], G. M. Schwab, editor, Vienna, 1940-1957, especially the following:
Vol. 4. Heterogeneous Catalysis I, Vienna, 1943,
Vol. 5. Heterogeneous Catalysis II, Vienna, 1957,
Vol. 6. Heterogeneous Catalysis III, Vienna, 1943.
- [B] Advances in Catalysis, Edited by W. G. Frankenburg, V. I. Komarewsky and E. K. Rideal, New York, beginning with 1948.
- [C] Reviews of patents dealing with the preparation of adsorbents and catalysts appear from time to time in *Kolloid-Zeitschrift*.
1. R. Fricke. See [A], Vol. 4, pp. 1-150, especially p. 21 ff.
 2. R. Fricke. *Naturwiss.* 31, 469 (1943).
 3. A. Guyer et al. *Helv. Chim. Acta* 38, 960 (1955).
 4. K. W. Hausser and P. Scholz. *Wiss. Veröff. Siemens-Konzern* 5, No. 3, p. 144 (1927).
 5. J. A. Hedvall and R. Hedin. *Chemie* 56, 45 (1943).
 6. G. F. Hüttig. See [A], Vol. 6, pp. 318-577, especially p. 420 ff.
 7. V. J. Kehrer, Jr., and H. Leidheiser, Jr. *J. Phys. Chem.* 58, 550 (1954).
 8. H. Noller. *Angew. Chem.* 68, 761 (1956).
 9. D. Papée. *Bull. Soc. Chim. France, Mém.* [5] 1954, 91.
 10. R. Rohmer. *Ibid.* 1955, 159.
 11. H. M. C. Sosnovsky. *J. Chem. Phys.* 23, 1486 (1955).
 12. I. N. Stranski and K. Molière. *Z. Phys.* 124, 421, 429 (1947); 127, 168, 178 (1950).
 13. W. A. Weyl. *J. Amer. Ceram. Soc.* 32, 367 (1949).
 14. —. *Trans. New York Acad. Sci.* [II] 12, 245 (1950).

ACTIVE METALS

The usual methods for the preparation of active metals fall into three groups, which are characterized by common preparative methodology and the same type of defect structure of the products.

PREPARATION BY REACTIONS OF SOLIDS

These reactions should be carried out topochemically; i.e., the active metal should be formed in the boundary region of the solid starting substances and not via a reaction between dissolved or gaseous particles. It is also desirable to avoid transport of the atoms of the solid from the initial reaction site; thus, any regrouping of atoms due to the reaction should involve minimum displacement. The desired product should be a loose network of mutually joined primary crystallites. The lower the temperature, the shorter the exposure of the material to high temperature; and the looser the structure of the starting material, the closer the approach to this ideal condition.

Reactions of this type include:

- 1) Reduction of solids with gaseous agents (see preparation of pyrophoric cobalt, p. 1615; Ni-Mg mixed oxalate catalyst, p. 1615).
- 2) Reduction of solids with solid reducing agents, solid-solid reactions (see tungsten, p. 1622).
- 3) Reduction of solids with solutions of reducing agents (see "molecular" silver, p. 1623).
- 4) Leaching out one component from a solid mixture (see Raney Ni, p. 1625).
- 5) Thermal decomposition of solids, resulting in liberation of a metal (see nickel formate-paraffin catalyst, p. 1631).

PREPARATION OF ACTIVE METALS BY DEPOSITION FROM A HOMOGENEOUS MEDIUM

These reactions give materials with a broad particle size distribution, which does not follow a predetermined probability function, but is controlled by the processes of nucleation and phase formation. A precondition for such a distribution is a high degree of supersaturation of the homogeneous phase, something which is readily achieved given the poor solubility and high boiling of metals. One thus obtains many nuclei. Local supersaturation is insufficient and is to be avoided. Processes of this kind involve:

- 1) Reductions of compounds from the gaseous phase and from homogeneous solutions (see active copper, p. 1633).
- 2) Thermal decomposition of volatile metal compounds, especially carbonyls (see carbonyl iron, p. 1636).

PREPARATION BY PRECIPITATION ON INTERFACES

The structure of such precipitates can be influenced by the carrier. Thus, oriented deposits are known in which the crystallites of the deposit are preferentially attached to a specific crystal plane of the carrier. Further, there exists the phenomenon of epitaxy, in which the crystal axes of the individual deposit particles have a definite spatial and geometric relationship to each other and to the crystal axes of the carrier. Under such conditions, there may occur significant changes in the relative proportions of some crystal surfaces to the total surface area. Precipitation on a surface is not necessarily preceded by a chemical reaction.

Among such methods of preparations are:

- 1) Electrolytic preparation of finely divided and active metals (see explosive antimony, p. 1638).
- 2) Electrochemical reduction, cementation (see silver, p. 1641).
- 3) Deposition from a vapor (see metallic deposits from a vapor, p. 1643).

Pure metallic preparations normally do not have a very high intrinsic activity; the total activity of a catalyst depends very much on the development of the surface. Lattice imperfections are usually observed only in the presence of impurities (incomplete reaction of starting materials) or in metals supported on carriers. The carriers prevent sintering of metal particles [73] on heat treatment during preparation or use, and in addition they stabilize crystal modifications beyond their normal range of existence.

The extremely active metals are pyrophoric; that is, they oxidize spontaneously on contact with air or in a high-temperature environment, becoming brightly incandescent (spontaneous and latent pyrophoric tendencies, respectively). The spontaneous pyrophoric tendency, which causes some obvious difficulties in the handling of these materials, may be converted to the latent one by mixing the products with a 0.5% solution of acetyl cellulose in acetone or a very dilute solution of polystyrene in benzene, followed by evaporation of the solvent. Frequently, a spontaneously pyrophoric metal may be sufficiently deactivated either by shaking it for some time with pure benzene, petroleum ether, ethanol or a similar substance, or by allowing such a liquid to evaporate from the mixture. On such treatment the particle surfaces become covered with a thin layer of oxide due to slow diffusion of oxygen through the liquid or due to slow exposure on evaporation. Because the exposure is slow and the particle is at least partly submerged in a heat-removing liquid, the heat generated by the oxidation does not increase the temperature to the point of ignition.

Pyrophoric Cobalt

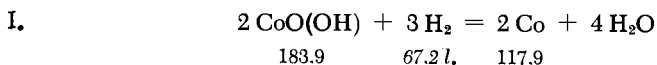

Cobalt (III) hydroxide (prepared as on p. 1520) is placed in a porcelain boat and reduced in a stream of hydrogen. The boat is heated by a tubular electric furnace whose temperature is regulated by a thermocouple connected to an on-off relay. For practical purposes, a temperature exceeding 300°C gives a sufficiently high reduction rate. The crystal structure and pyrophoric nature of the product (at room temperature) are related to the reduction temperature as follows:

Temperature, °C	300	400	500	600	700	800
Crystal structure	α -Co (hexagonal [49]) . . . β -Co (cubic)					
Pyrophoric tendency (see p. 1614)	spontaneous		latent		not pyrophoric	

II. CARRIER-SUPPORTED PYROPHORIC COBALT, BY REDUCTION OF A COPRECIPITATE

A solution of 75.0 g. of $\text{Al(NO}_3)_3 \cdot 9 \text{H}_2\text{O}$ (0.2 moles) in 300 ml. of water is prepared and 200 ml. of 20% sodium hydroxide solution is added with efficient stirring. The initial precipitate is redissolved and a solution of 29.1 g. of $\text{Co(NO}_3)_2 \cdot 6 \text{H}_2\text{O}$ (0.1 moles) and 20 ml. of conc. HNO_3 (d 1.40) in 500 ml. of water is immediately poured in (thin stream, good agitation). The violet-rose precipitate is allowed to settle and then is washed 4 or 5 times by decanting with pure water. It is then centrifuged off and dried in an oven at 75°C. The coprecipitate is then ground under water and boiled several times with water (250 ml. each time) until the absence of nitrate in the product can be established by some qualitative test reaction. The product is again collected by centrifugation and dried at 75°C, then at 100°C. Reduction of such coprecipitates by method I yields spontaneously pyrophoric materials even at the highest reaction temperatures. While β -Co prepared by method I is converted more or less completely to the α -form on grinding in the absence of air in an agate mortar, materials prepared via method II remain completely unchanged [17] on such grinding. The β -form appears to be the more active hydrogenation catalyst [56].

Ni-Mg Mixed Oxalate Catalyst (1:1)

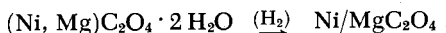

In the Langenbeck method [34] a solution of 15 g. of $\text{Ni(NO}_3)_2 \cdot 6 \text{H}_2\text{O}$ and 70 g. of $\text{Mg(NO}_3)_2 \cdot 6 \text{H}_2\text{O}$ in 600 ml. of water is heated

to 50°C and the mixed oxalate precipitated by addition of a solution of 29.6 g. of $\text{H}_2\text{C}_2\text{O}_4 \cdot 2 \text{H}_2\text{O}$ in 400 ml. of water (constant stirring). The mixture is then left standing for 12 hours to complete the crystallization. The compound is collected by suction filtration and the light-green crystals washed with water until free of nitrates. Drying at 100°C yields 16 g. of the mixed oxalate.

The material is reductively decomposed in the apparatus of Fig. 336. The sample is placed over the fritted-glass plate *b* (which acts as a distributor). When the hydrogen stream is adjusted to 10 liters/hour at STP, the mixed oxalate should form a stable fluidized bed. The temperature is then raised to 350°C. The decomposition takes 150 minutes.

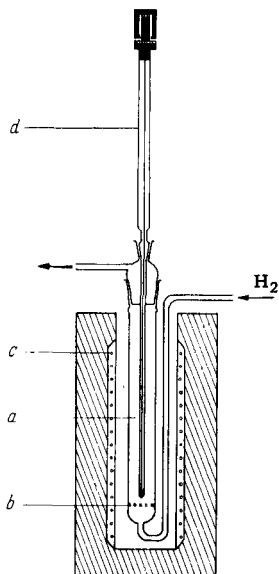

Fig. 336. Preparation of mixed salt catalysts by fluidized bed decomposition of oxygen-containing compounds. *a* reactor, *b* fritted-glass plate (distributor), *c* electric heating coil, *d* thermometer connected to an on-off relay in the heater circuit.

from this, fewer undesirable side reactions can be expected with hydrogen than with other (possibly) useful gases such as CO , the lower hydrocarbons and NH_3 , with which formation of carbonyls and contamination with carbides and nitrides is possible [20]. The flow rate must be sufficiently high to remove the volatile decomposition products as fast as they are formed; otherwise the reaction may be inhibited and the activity of the final product may be less than the optimum [56, 69, 71]. If necessary, the exit gas composition

PROPERTIES:

Black, pyrophoric powder. Aside from the metallic Ni produced in the decomposition, contains a nearly unchanged magnesium oxalate carrier [32]. Extremely active hydrogenation catalyst.

GENERAL:

The reduction of oxygenated compounds to active metals presented above is a very general method. Hydrogen is frequently the only useful gaseous reducing agent. It possesses a high thermal conductivity, and therefore the heat of reaction tends to be removed as fast as it is generated. This is important in systems where the metal, once produced, catalyzes another further reaction [2, 52]. Apart

may be monitored [2]; a continuous monitoring system based on the thermal conductivity of the gas can be especially useful [8].

The oxygenated starting material must also be carefully chosen. In the following, we shall present some remarks pertaining to individual classes of starting materials.

OXIDES

The best starting materials are active oxides, possibly produced *in situ*, preferably from hydroxides, hydrated oxides or carbonates. In some cases it may be necessary to start with a very well-defined oxide modification in order to obtain an active catalyst [29]. Occasionally, the required starting oxides are produced by thermal decomposition of nitrates. However, the activity of such products is not very high and their maximum specific surface does not exceed a few m^2/g . For this reason, nitrate decomposition is important only for the production of supported catalysts (see below). Oxides calcined at a high temperature, as well as spinel-type materials, should be avoided, since their reduction times tend to be extremely long [2].

FORMATES AND OXALATES

Heavy-metal salts in this class may be reduced directly since their anions also are reducing agents and thus promote the overall reaction [36]. In some cases (see p. 1665), simple thermal decomposition of the formate or oxalate will yield the metal; in such cases the hydrogen acts only as a protective gas which prevents reoxidation. Metals obtained by this method are not always completely free from carbon [33, 37]. The nature of the starting material may influence the activity of the product metal catalyst to some extent; this is especially true if the material is reduced at a temperature just sufficient to effect the reaction [42].

The following methods apply to the production of carrier-supported catalysts:

a) **Precipitation** of the compound to be reduced (hydroxide and carbonate by precipitation from solution, oxide by nitrate decomposition) on the desired carrier. The major methods involved are those of Sabatier [60, 61] and that illustrated by the case of active copper [47] (see copper tower, p. 459). Many industrial catalysts are prepared in this manner; it is especially recommended for cases where the active material must participate in a stoichiometric reaction.

b) **Coprecipitation**. In this case, the noble and the base metal are both attached to the same type of anion. The noble metal is in the form of a compound which yields the actual catalyst upon reduction, while the base-metal compound yields the carrier upon

reductive decomposition. The coprecipitation must be carried out in such a way as to avoid possible fractionation of the two components [66]. Thus, it is desirable that the coprecipitants form compounds or solid solutions under the mother liquor. It is known for instance, that divalent metal couples (Co/Zn; Ni/Zn [12]) as well as mixed bi- and trivalent metal couples (Mn/Al; Co/Al [13]; Ni/Al [13, 43, 44, 46]; Cu/Al [5]) can form double hydroxides. Solid solutions (or mixed crystals) tend to give especially finely divided active metal catalysts, because this subdivision tends to exist in the material even prior to the reduction. Systematic studies by Langenbeck have shown that mixed formate and oxalate crystals tend to give especially active catalysts. Such mixed salts decompose at low temperatures and the active metal exists in a finely divided form [56]. The specific surface in such cases is high (in isolated cases it may exceed 200 m.²/g. [54, 56]).

To achieve homogeneity with these relatively soluble compounds, which, however, have different solubilities, the mixed formates must be prepared by a special spray-drying technique [31]. The mixed oxalates, which are precipitated with oxalic acid and ammonium oxalate rather than with alkali oxalates (this tends to give more active catalysts), yield, as a rule, homogeneous materials via a simple precipitation. Complex oxalates are just as usable as the mixed oxalates [33].

c) **Activation of the surface** of suitably shaped metals by surface oxidation and reduction. This process may have to be repeated; highest activation is usually obtained after 3-4 cycles [21]. The product particle consists of a small solid metal nucleus—the carrier—to which the reduced metal, in finely divided or porous form, adheres tightly. The roughening of the surface accompanying this process leads to a useful increase in specific surface. The starting materials are usually thin metal foils, but sometimes oxidized wire cuttings (see CuO “wire” [45]) give a useful catalyst with a carrier of exceptionally high thermal conductivity. This is a useful feature because it helps achieve a uniform temperature distribution within a closely packed catalyst mass.

The above methods may also be used for the production of alloy powders and solid metallic solutions. However, the mechanical properties [24], the tendency to lattice imperfections [25], and the catalytic activity [4, 68] of such preparations are not simple functions of the composition.

The hydrogen reduction method is also used for the preparation of active forms of lower oxides and sulfides of multivalent metals. However, these materials require a much longer time to achieve reduction, even though the procedure is otherwise identical.

The optimum reduction temperature depends on a variety of factors. Among these the nature of the metal is, of course, of primary importance. However, the type of the anion, the purity of

the starting material [51], the degree of decomposition and the defect state of the compound to be reduced are also important determinants of the optimum temperature. The deposition on a carrier or the presence of admixtures [11, 55, 62] may decisively influence the reductive behavior. The lowest reduction temperatures are achieved with specially purified gases (carefully dried H_2 [56], CO free from CO_2), if necessary, at reduced pressure [48].

Literature references dealing with the preparation of active metals by reduction with gaseous agents:

Metal or alloy	Starting material for the reduction					
	Oxide	Nitrate	Hydroxide	Car-bonate	Formate	Oxalate
Fe	I [28]	—	[18]	—	[3]	[3,6,37]
	II —	—	<i>a, b</i> [29]	—	—	—
Fe—Cr } Fe—Mn }	I [28]	—	—	—	—	—
Fe—Co	I —	—	—	[68]	[3,38,40]	—
Fe—Ni	I —	[53]	—	—	[38]	[25]
	II —	—	—	<i>a</i> [10]	—	—
Fe—Cu	I —	—	[57]	—	—	[24]
Fe—Ag } Fe—Au } Fe—Pb }	I —	—	[57]	—	—	—
Co	I —	[53,59]	[17]	—	[39,41,42,56]	[39,42]
	II —	<i>a</i> [59]	<i>b</i> [17]	<i>a</i> [27]	<i>b</i> [56]	<i>b</i> [34]
Co—Ni	I —	[53]	—	—	[38,40]	—
Ni	I [41]	[15,42,53]	[19,41,42]	[4,19]	[39,41,42]	[9,39,41]
	II <i>c</i> [70]	<i>a</i> [64,65]	<i>b</i> [14,50,63]	<i>a</i> [7]	<i>a</i> [58] <i>b</i> [30,31,35,54]	<i>b</i> [32,34,35]
Ni—Cu	I —	[53]	—	[4]	—	—
Cu	I [16]	—	—	[16]	—	[72]
	II <i>c</i> [1,21]	<i>a</i> [26,67]	<i>c</i> [16,47]	—	<i>b</i> [33]	<i>b</i> [33]
W	I [22,23]	—	—	—	—	—

I: free metal or free alloy.

II: metal on supported carriers: *a* deposited by precipitation; *b* deposited by coprecipitation; *c* obtained by activation (see text).

REFERENCES:

1. F. C. Aldred and F. Happey. *Nature* **160**, 267 (1947).
2. A. F. Benton and P. H. Emmett. *J. Amer. Chem. Soc.* **46**, 2728 (1924).
3. E. F. Bertaut. *Bull. Soc. Franc. Minéralog. Cristallogr.* **76**, 1 (1953).

4. R. J. Best and W. W. Russel. *J. Amer. Chem. Soc.* 76, 838 (1954).
5. Y. Carteret and B. Imelik. *Comptes Rendus Hebd. Séances Acad. Sci.* 234, 834 (1952).
6. B. Chatterjee and P. P. Das. *Nature* 173, 1046 (1954).
7. L. W. Covert, R. Connor and H. Adkins. *J. Amer. Chem. Soc.* 54, 1651 (1932).
8. E. Cremer and E. Prior. *Z. Elektrochem.* 55, 66 (1951).
9. R. M. Dell and F. S. Stone. *Trans. Faraday Soc.* 50, 501 (1954).
10. D. A. Dowden and P. W. Reynolds. *Discuss. Faraday Soc. No.* 8, 184 (1950).
11. J. J. B. van Eijk, van Voorthuijsen and P. Franzen. *Rec. Trav. Chim. Pays-Bas* 70, 793 (1951).
12. W. Feitknecht. *Helv. Chim. Acta* 21, 766 (1938).
13. —. *Ibid.* 25, 555 (1942).
14. R. M. Flid and M. Y. Kagan. *Zh. Fiz. Khimii* 24, 1409 (1950).
15. M. Foex. *Bull. Soc. Chim. France, Mém.* [5] 19, 373 (1952).
16. R. Fricke and F. R. Meyer. *Z. phys. Chem. [A]* 183, 177 (1939).
17. R. Fricke and H. Müller. *Naturwiss.* 30, 439 (1942).
18. R. Fricke, O. Lohrmann and W. Wolf. *Z. phys. Chem. [B]* 37, 60 (1937).
19. R. Fricke and W. Schweckendiek. *Z. Elektrochem.* 46, 90 (1940).
20. W. E. Garner. *J. Chem. Soc. (London)* 1947, 1239.
21. W. E. Garner, T. J. Gray and F. S. Stone. *Proc. Roy. Soc. [A]* 197, 294 (1949).
22. A. J. Hegedüs, T. Millner, J. Neugebauer and K. Sasvari. *Z. anorg. allg. Chem.* 281, 64 (1955).
23. J. O. Hougen, R. R. Reeves and G. G. Mannella. *Ind. Eng. Chem.* 48, 318 (1956).
24. G. F. Hüttig and A. Vidmayer. *Z. anorg. allg. Chem.* 272, 40 (1953).
25. F. Hund. *Z. Elektrochem.* 56, 609 (1952).
26. P. E. Jacobson and P. W. Selwood. *J. Amer. Chem. Soc.* 76, 2641 (1954).
27. M. F. L. Johnson and H. E. Ries. *J. Phys. Chem.* 57, 865 (1953).
28. P. Jolibois and B. Fleureau. *Comptes Rendus Hebd. Séances Acad. Sci.* 232, 1272 (1951).
29. H. Kölbel. *Chem.-Ing.-Technik* 23, 153, 183 (1951).
30. W. Langenbeck and A. Giller. *Z. anorg. allg. Chem.* 272, 64 (1953).
31. W. Langenbeck and H. Dreyer. *J. prakt. Chem.* [4] 1, 288 (1955).
32. W. Langenbeck, H. Dreyer and D. Nehring. *Naturwiss.* 41, 332 (1954).
33. W. Langenbeck and V. Ruzicka. *Z. anorg. allg. Chem.* 278, 192 (1955).

34. W. Langenbeck, H. Dreyer, D. Nehring and J. Welker. *Ibid.* 281, 90 (1955).
35. W. Langenbeck, H. Dreyer and D. Nehring. *J. prakt. Chem.* [4] 4, 161 (1956).
36. W. Langenbeck. *Angew. Chem.* 68, 453 (1956).
37. F. Lihl. *Monatsh. Chem.* 81, 632 (1950).
38. —. *Metall* 5, 183 (1951).
39. F. Lihl, H. Wagner and P. Zemsch. *Z. Elektrochem.* 56, 612 (1952).
40. —. *Ibid.* 56, 619 (1952).
41. F. Lihl and P. Zemsch. *Ibid.* 56, 979 (1952).
42. —. *Ibid.* 57, 58 (1953).
43. J. Longuet-Éscard. *Bull. Soc. Chim. France, Mém.* [5], 16, D 153 (1949).
44. —. *J. Chim. Physique, Physico-chim. biol.* 47, 238 (1950).
45. C. L. McCabe and G. D. Halsey. *J. Amer. Chem. Soc.* 74, 2732 (1952).
46. A. Merlin, B. Imelik and St. Teichner. *Comptes Rendus Hebd. Séances Acad. Sci.* 238, 353 (1954).
47. F. R. Meyer and G. Ronge. *Angew. Chem.* 52, 637 (1939).
48. A. G. Moskvicheva and G. I. Chufarov. *Dokl. Akad. Nauk SSSR* 105, 510 (1955).
49. H. Nowotny and R. Juza. *Z. anorg. Chem.* 253, 109 (1945).
50. L. d'Or and A. Orzechowski. *Bull. Soc. Chim. Belge* 62, 138 (1953).
51. G. Parravano. *J. Amer. Chem. Soc.* 74, 1194 (1952).
52. M. M. Pavlyuchenko and Y. S. Rubinchik. *Zh. Prikl. Khimii* 24, 666 (1951).
53. G. Rienäcker and S. Unger. *Z. anorg. allg. Chem.* 274, 47 (1953).
54. G. Rienäcker, M. Schubert-Birckenstaedt, J. W. Birckenstaedt and H. Walter. *Ibid.* 279, 59 (1955).
55. G. Rienäcker and G. Schneeberg. *Ibid.* 282, 222 (1955).
56. G. Rienäcker, J. W. Birckenstaedt, M. Schubert-Birckenstaedt and G. Techel. *Ibid.* 289, 29 (1957).
57. P. Royen and H. Reinhardt. *Ibid.* 281, 18 (1955).
58. A. M. Rubinshteyn, S. S. Novikov, S. Ya. Lapshina and N. I. Shuykin. *Dokl. Akad. Nauk SSSR* 74, 77 (1950).
59. A. M. Rubinshteyn and N. A. Pribytkova. *Izv. Akad. Nauk SSSR, Otd. Khim. Nauk* 1951, 70.
60. P. Sabatier and J. B. Senderens. *Comptes Rendus Hebd. Séances Acad. Sci.* 132, 210 566 (1901).
61. P. Sabatier. *Catalyse, German transl. by B. Finkenstein, Leipzig*, 1927.
62. N. G. Schmahl. *Angew. Chem.* 65, 447 (1953).
63. N. I. Shuykin, Kh. M. Minachev and L. M. Feofanova. *Izv. Akad. Nauk SSSR, Otd. Khim. Nauk* 1953, 96; *Chem. Techn.* 5, 391 (1953).

64. G. C. A. Schuit and N. H. de Boer. *Rec. Trav. Chim. Pays-Bas* 70, 1067 (1951).
65. —. *Ibid.* 72, 909 (1953).
66. G. M. Schwab and K. Polydoropoulos. *Z. anorg. allg. Chem.* 274, 234 (1953).
67. P. W. Selwood and N. S. Dallas. *J. Amer. Chem. Soc.* 70, 2145 (1948).
68. R. A. Stowe and W. W. Russel. *Ibid.* 76, 319 (1954).
69. A. Takasaki. *Sci. Rep. Res. Inst. Tohoku Univ.* [A] 5, 365 (1953).
70. D. Toyama. *Rev. Phys. Chem., Japan*, 12, 115 (1938).
71. G. I. Chufarov, B. D. Averbukh, Y. P. Tatyevskaya and V. K. Antonov. *Zh. Fiz. Khimii* 26, 31 (1952).
72. K. Fischbeck and O. Dorner. *Z. anorg. allg. Chem.* 182, 228 (1928).
73. J. T. McCartney, B. Seligman, W. K. Hall and R. B. Anderson. *J. Phys. Colloid Chem.* 54, 505 (1950).

Tungsten

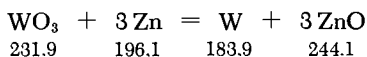

Small amounts of a homogeneous mixture of 50 g. of finely powdered calcined WO_3 (prepared from analytical grade sodium tungstate) and 150 g. of fine zinc dust (containing as little oxide as possible and dried at 150°C) are pressed into unglazed porcelain crucibles. An unglazed porcelain tube may be used when a larger batch is to be prepared; the tube, centered vertically in the crucible, provides better heat conduction. The mixture is then covered with a 1- to 2-cm. layer of zinc dust, and the crucible is then closed with a closely fitting asbestos lid. To initiate the reaction, the crucible is heated to $500\text{--}520^\circ\text{C}$ in an electric furnace. As soon as the mixture ignites and a bright glow is visible through a small hole in the asbestos cover, the current is cut off. The reaction is completed within a few minutes and the crucible may then be removed from the furnace. After complete cooling, the crucible is broken up and the product added (in small portions) to cold, dilute (1:4) hydrochloric acid. The mixture is boiled until hydrogen evolution ceases and the supernatant is of Zn-free acid (must be added from time to time). The product is washed in a centrifuge with oxygen-free water; at the end, the wash liquors must be free of chloride ion. Toward the end of the washing procedure, the metal begins to form a colloidal suspension. It should be covered with water at all times to avoid reoxidation. After washing, the water is displaced with ethanol, under which the

product may be stored in active form; or it is inactivated with benzene (see p. 1614) and dried in vacuum over P_2O_5 . In the latter case, the product consists of coarse lumps, which may be cautiously triturated under benzene to give a fine powder upon drying [1, 3, 5].

PROPERTIES:

High density black powder which consists of 99% W, provided the workup has been rapid and no oxygen contacted the product. The average size of the primary particles is about 400 A, with the individual crystallites showing a slight lattice distortion [3]. Preparations which are not inactivated prior to storage oxidize in air, evolving heat; after this, they show oxygen bands in the powder pattern.

GENERAL:

This method is obviously applicable only to very high-melting metals which retain their subdivision and defect state in spite of the high reaction temperature. The retention of these properties is aided by the fact that the particles of the reaction product are embedded in ZnO, which, together with the unreacted Zn, gives effective protection against penetration of atmospheric oxygen during cooling. This form of tungsten, as well as the analogously prepared molybdenum [4], consists of such small particles that it gives colloidal solutions on peptization by the etching method (alternate treatment with dilute acids and bases).

Other solid reducing agents include metal hydrides (for example, CaH_2) [2] and carbon. However, reduction with carbon does not yield solid oxidation products and introduces the danger of carbide formation.

REFERENCES:

1. M. Delépine. Comptes Rendus Hebd. Séances Acad. Sci. 131, 184 (1900).
2. A. D. Franklin and R. B. Campbell. J. Phys. Chem. 59, 65 (1955).
3. K. Roeder, Thesis, Univ. of Stuttgart, 1951.
4. E. Wedekind and O. Jochem. Z. angew. Chem. 40, 434 (1927).
5. L. Weiss. Z. anorg. Chem. 65, 279 (1909), especially p. 307.

"Molecular" Silver

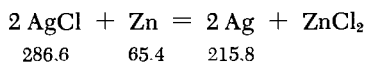

In the method of Gomberg and Cohne [3], pure, thoroughly washed silver chloride is placed in a beaker and covered with

water. A platinum disk, attached to a thoroughly flame-cleaned platinum wire, is embedded in the AgCl. A porous clay cell, closed at the bottom and containing some water and a few Zn rods, is placed on top of the AgCl. The reaction starts as soon as the protruding platinum wire is connected to the zinc rods. To increase the reaction rate, a few drops of HCl are added to the clay cell. Reduction of 250 g. of AgCl requires a few days. To decrease the migration of impurities from the zinc into the silver, the liquid level in the clay cell is always kept below that in the beaker. After completion of the reaction, the product (a metal-containing sludge) is washed with water, ammonium hydroxide, again with a large quantity of water, alcohol and finally ether.

PROPERTIES:

High-density gray powder. The individual particles are permeated with many pores (pore radius of the order of 10^4 Å); the interconnected single grains are primary particles [8].

GENERAL:

The reduction of a suspended solid is applicable only to noble metals, but under favorable reaction conditions it produces highly dispersed materials [2]. Here again it pays to use very active starting materials, preferably prepared (by precipitation) immediately prior to use. Apart from the galvanic reduction method, one can use dissolved reducing agents. However, these must be absorbed to some extent by the precipitate to be reduced. If the precipitate is unable to absorb the reducing agent, the ions are reduced in solution, with consequent loss of the topochemical nature of the reaction [5].

Reactions of the above type give Cu from hydrated Cu oxide and N_2H_4 [2]; Ag from Ag_2O and H_2O_2 [7]; Ag from AgCl and H_2CO [9], NH_2OH [5], N_2H_4 [6], Cr^{2+} [4]; Pt from PtO_2 and H_2 [1]. Platinum-asbestos and palladium-asbestos may also be prepared by this method (see p. 1563).

REFERENCES:

1. V. L. Framton, J. D. Edwards and H. R. Henze. J. Amer. Chem. Soc. 73, 4432 (1951).
2. W. E. Garner, F. S. Stone and P. F. Tiley. Proc. Roy. Soc. [A] 211, 472 (1952).
3. M. Gomberg and L. H. Cohn. Ber. dtsch. chem. Ges. 39, 3274 (1906).
4. E. H. Huffmann. Ind. Eng. Chem., Anal. Edit. 18, 278 (1946).
5. T. H. James. J. Amer. Chem. Soc. 62, 536, 1649 (1940).

6. —. *Ibid.* 62, 1654 (1940).
7. F. Jirsa and J. Jelinek. *Z. anorg. allg. Chem.* 158, 63 (1926).
8. G. M. Schwab. *J. Phys. Colloid Chem.* 54, 576 (1950).
9. L. Vanino. *Ber. dtsh. chem. Ges.* 31, 1764 (1898).

Raney Nickel

I. METHOD OF PAUL AND HILLY [29]

A fireclay crucible is charged with 400 g. of Al. It is then heated to 1200°C, and 300 g. of nickel cubes are added at once to the Al melt. Nickel cubes are especially useful in this case since the material is porous and thus quickly dissolved at the initial, comparatively low temperature. The nickel dissolves in a vigorous reaction which raises the temperature of the melt to 1500°C. The alloy must be prepared under a salt melt layer or in an inert atmosphere to protect the Al from oxidation.

After cooling, the alloy is broken up or cut on a lathe (however, it is best to grind it in a ball mill). Then, 250 g. of the powder is added in small portions to one liter of ice-cold, 25% aqueous NaOH. During the initial vigorous reaction the flask is kept in ice; then, the mixture is gradually heated to 90-100°C and this temperature is maintained until hydrogen evolution ceases. The solid is allowed to settle, the spent hydroxide solution is removed, and the process is repeated twice, each time with one liter of fresh base. The Ni sludge is then washed by decantation with water until the wash water is neutral to phenolphthalein. At the end, the water is displaced with ethanol or dioxane.

II. RANEY NICKEL, W-6 [2]

The reactor is a two-liter Erlenmeyer flask equipped with a thermometer and a stainless steel stirrer. This flask is charged with 160 g. of NaOH and 600 ml. of water. The solid is dissolved with intensive stirring and the solution is cooled in an ice bath to 50°C. Then, 150 g. of Raney nickel-aluminum alloy (1:1) is added in small pieces. The rate of addition should be such that the temperature of the mixture remains constant at $50 \pm 2^\circ\text{C}$. The addition takes 20-30 minutes. The solution is then stirred for an additional 50 minutes while the temperature is kept at 50°C (first by cooling and later by heating on a water bath). The catalyst sludge product is washed three times by decantation with water. It is immediately placed in the washing tube *c* of the apparatus in Fig. 337 (the last of the product is transferred into *c* with a stream of water from a wash bottle).

Tube *c* and the one-neck Woulfe flask *b* are filled with water and the apparatus is assembled as quickly as possible. All rubber stoppers and tubing should be held in place with clamps or wires. Then, O₂-free hydrogen is introduced via *e* until the entire apparatus is under a gage pressure of 0.5 atm. This pressure is then maintained while stirring at such a rate that the catalyst is fluidized to a height of 18-20 cm. above the bottom of tube *c* and the wash water flow rate from *b* is 250 ml./min. When the water reservoir *b* is nearly empty, stopcocks *g* and *a* (the latter is connected to a large pressurized water reservoir) are simultaneously opened, and *b* is replenished at the same rate as water runs out at *g* (the flow rate is checked by a differential manometer).

In this way, 15 liters of H₂O are allowed to pass through *c*. The stirrer motion and wash water flow are then stopped, the pressure is released, and the apparatus is disassembled. The water layer above the catalyst is decanted and the solid transferred into a 250-ml. centrifuge tube by flushing with 95% ethanol. The material is washed three times by stirring (not shaking) with 95% ethanol (150 ml. each time) and the same number of times with absolute ethanol. If centrifuged after each washing at 1500-2000 r.p.m., one to two minutes are usually sufficient to settle out the product. The product catalyst is stored under absolute ethanol in a refrigerator. It cannot be stored indefinitely.

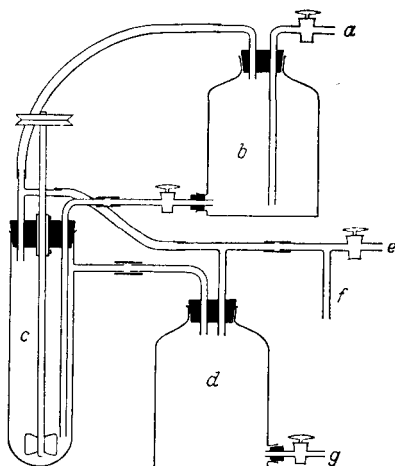

Fig. 337. Apparatus for continuous washing of Raney nickel in the absence of air. *a* water inlet; *b* water reservoir; *c* wash vessel; *d* discarded wash water; *e* hydrogen inlet; *f* nozzle for attaching a manometer; *g* waste water outlet.

All the above operations should be carried out as rapidly as possible. The time from the beginning of the run to the final placing of the catalyst into cold storage should not exceed three hours.

PROPERTIES:

Very dense grayish-black powder. Used as a hydrogenation catalyst [34]; it can also serve, just as Raney iron or cobalt, as the starting material for the production of the corresponding carbonyl compounds [19]. Also used as a catalyst carrier [9]; can be efficiently activated by treatment with metals of the platinum group [4].

The individual catalyst particles are very porous. The primary particle size ranges from 10 to 100 Å [18, 42]. Raney Ni W-6 contains 12.7% Al [20]; its specific surface was determined as 87 m.²/g. [44].

GENERAL:

The intermediate stages of Raney's [33] general method for the preparation of catalytically active metal skeletons can be varied over a wide range, making possible products of widely varying activities. Let us discuss these individual stages.

The **starting alloy** is usually prepared by fusion of the components; this fusion should yield as homogeneous a structure as possible [39]. In another method, a fine powder of the pure catalytic metal is mixed with Al powder; the mixture is pressed into tablets and sintered for some time at moderate (of the order of 700°C) temperatures [46]. The Raney alloys can also be obtained by aluminothermic synthesis [11].

The **optimum composition** of the starting alloy, which determines the catalytic properties to some extent [36], is controlled by several considerations, namely: a) alloys with too high a content of catalytic metal yield products of low activity [6]; the upper limit of allowable active metal content varies from metal to metal. b) Catalysts obtained from alloys of differing active metal contents have somewhat different selectivities in the same reactions [6, 7]. c) Alloys with a definite composition such as NiAl may be so resistant to the leaching solvent used that no useful catalyst, results. The use of ordered solid solutions (e.g., Ni₂Al₃) does not offer any advantages, since the Ni atoms tend to regroup into an undesirable configuration after the Al is leached out [42].

Decomposition of the alloy should expose the skeletal metal structure. However, complete removal of the alloying metal (which accompanies the active one) requires drastic conditions and leads to products of poor activity [3]. For this reason the decomposition conditions are selected so as to leave some Al in

the catalyst. The milder the conditions under which the decomposition takes place, the more active the catalyst and the larger the percentage of Al in the final product. In some case, it is sufficient to leach out the surface Al [40, 41; see also 34]. This also permits activation of the walls of the catalyst-containing reactor [38]. It is improbable that the Al in the catalyst is present as Al_2O_3 [20, 45].

Literature references for the preparation of active metals
by the Raney process.

Skeletal metal	Second metal (weight %)	Leaching fluid	References
Fe	Al (20/80) Al	Aqueous NaOH Aqueous NaOH	[17, 30, 34] [15]
Co	Al	Aqueous NaOH	[5, 11, 12, 34]
Ni W-1	Al (50/50)	Aqueous NaOH	[8]
W-2	Al (50/50)	Aqueous NaOH	[27]
W-3, -4	Al (50/50)	Aqueous NaOH	[32]
W-5, -6, -7	Al (50/50)	Aqueous NaOH	[2]
W-8	Al (50/50) Al Mg (50/50)	Aqueous NaOH Aqueous NaOH Acetic acid	[25] [6, 29, 39] [28]
Cu	Zn Al, Zn (50/45/5) (Devarda's alloy)	Aqueous NaOH Aqueous NaOH	[24] [10, 26]
CoNi	Al (2/48/50) (5/45/50) Si (25/25/50)	Aqueous NaOH Aqueous NaOH	[35] [12]

As far as the effect of the decomposition conditions is concerned, the following can be reported. The activity of the product is proportional to the rate of the decomposition and varies inversely with the decomposition temperature. The rate can be enhanced by starting with as fine metal powder as possible and adding the latter as rapidly as possible to the decomposing medium [6]. The primary particle size of the catalyst (as determined by x-ray analysis) always increases with the hydroxide concentration and the temperature [23]. However, the hydroxide concentration has little effect on the activity of the catalyst. Adkins [1] has presented a number of conclusions on the effect of these external conditions on the preparation of Raney Ni.

MISCELLANEOUS CONSIDERATIONS

In addition to the Al, the ready Raney nickel catalyst also contains hydrogen, to which the pyrophoric nature of the product [22] is due. For the nature of bonding of the hydrogen, see [13, 14, 16, 37, 43]. The removal of hydrogen leads to loss of catalytic activity, which can not be restored by renewed treatment with hydrogen, even though the powder patterns of hydrogen-treated inactive preparations do not differ from those of active ones [22]. Since the catalyst must contain hydrogen, a special technique is required if it is to be used in deuteration reactions [25].

This general method for preparation of catalytically active structures is also applicable to metals other than Ni. It is also useful with alloys [31, 34]. In addition to Al, the alloy component which is leached out may be Si [12], Zn [24] and occasionally Mg [28] (dilute acetic acid is used as the leaching fluid). In determining the optimum composition of the Raney alloy for a specific purpose, one must also take into account the effect of the second metal.

Highly active skeletal Si was obtained by multistage removal of Ca from CaSi_2 ; the silicon metal was arranged in the form of a network consisting of six-membered rings [21].

REFERENCES:

1. H. Adkins and A. A. Pavlic. *J. Amer. Chem. Soc.* 69, 3039 (1947).
2. H. Adkins and H. R. Billica. *Ibid.* 70, 695 (1948).
3. J. Aubry. *Bull. Soc. Chim. France, Mém.* [5] 5 1333 (1938).
4. R. B. Blance and D. T. Gibson. *J. Chem. Soc. (London)* 1954, 2487.
5. A. J. Chadwell and H. A. Smith. *J. Phys. Chem.* 60, 1339 (1956).
6. R. Cornubert and J. Phéllisse. *Bull. Soc. Chim. France, Mém.* [5] 1952, 399.
7. R. Cornubert, M. Réal and P. Thomas. *Ibid.* 1954, 534.
8. L. M. Covert and H. Adkins. *J. Amer. Chem. Soc.* 54, 4116 (1932).
9. J. Décombe. *Comptes Rendus Hebd. Séances Acad. Sci.* 222, 90 (1946).
10. L. Faucounau. *Bull. Soc. Chim. France, Mém.* [5] 4, 58 (1937).
11. —. *Ibid.* 4, 63 (1937).
12. F. Fischer and K. Meyer. *Ber. dtsch. chem. Ges.* 67, 253 (1934).
13. L. Kh. Freydlin and N. I. Simonova. *Dokl. Akad. Nauk SSSR* 74, 955 (1950).
14. L. Kh. Freydlin and K. G. Rudneva. *Ibid.* 91, 569 (1953).

15. —. *Ibid.* 91, 1171 (1953).
16. —. *Izv. Akad. Nauk SSSR, Otd. Khim. Nauk* 1954, 491, 1082.
17. L. Kh. Freydlin, K. G. Rudneva and S. S. Sultanov. *Ibid.* 1954, 511.
18. A. Guinier. *Ann. Physique* [11] 12, 161 (1939).
19. E. Hieber. *Naturforsch. u. Medizin in Dtschld.* 1939-46, Vol. 24, *Inorg. Chem.*, Part II, p. 112 (1948).
20. V. N. Ipatieff and H. Pines. *J. Amer. Chem. Soc.* 72, 5320 (1950).
21. H. Kautsky and L. Haase. *Chem. Ber.* 86, 1226 (1953).
22. L. M. Kefeli and S. L. Lelchuk. *Dokl. Akad. Nauk SSSR* 83, 697 (1952).
23. L. M. Kefeli and N. G. Sevastvyanov. *Ibid.* 83, 863 (1952).
24. L. M. Kefeli and S. L. Lelchuk. *Ibid.* 84, 285 (1952).
25. N. A. Khan. *J. Amer. Chem. Soc.* 74, 3018 (1952).
26. C. van Mechelen and J. C. Jungers. *Bull. Soc. Chim. Belge.* 59, 597 (1950).
27. R. Monzingo. *Organic Syntheses* 21, 15 (1941).
28. J. N. Pattison and E. F. Degering. *J. Amer. Chem. Soc.* 72, 5756 (1950).
29. R. Paul and G. Hill. *Bull. Soc. Chim. France, Mém.* [5] 3, 2330 (1936).
30. —. *Ibid.* 6, 218 (1939).
31. R. Pual. *Ibid.* 1946, 208.
32. A. A. Pavlic and H. Adkins. *J. Amer. Chem. Soc.* 68, 1471 (1946).
33. M. Raney. *U.S. Pat.* 1,628,190 (1927).
34. R. Schröter. *Angew. Chem.* 54, 229, 252 (1941).
35. J. Sfiras and A. Demeilliers. *Recherches* 1953, 32.
36. H. A. Smith, W. C. Beddit and J. F. Fuzek. *J. Amer. Chem. Soc.* 71, 3769 (1949).
37. H. A. Smith, A. J. Chadwell and S. Kirslis. *J. Phys. Chem.* 59, 820 (1955).
38. Standard Oil Co. *U.S. Pat.* 2,583,619 (1944).
39. Y. A. Stolyarov and D. M. Todes. *Zh. Fiz. Khimii* 30, 23 (1956).
40. S. Tsutsumi and S. Nagao. *J. Chem. Soc. Japan, Ind. Chem. Sect.* 54, 371 (1951).
41. S. Tsutsumi and H. Akatsuka. *Ibid.* 55, 105 (1952).
42. G. G. Urasov, L. M. Kefeli and S. L. Lelchuk. *Dokl. Akad. Nauk SSSR* 55, 745 (1947).
43. C. Vandael. *Ind. Chim. Belge* 17, 581 (1952).
44. G. W. Watt, W. F. Roper and S. G. Parker. *J. Amer. Chem. Soc.* 73, 5791 (1951).
45. G. W. Watt. *Ibid.* 74, 1103 (1952).
46. T. Yamanaka. *Rep. Sci. Res. Inst. [Kagaku-Kenkyujo-Hokoku]* 31, 58 (1955).

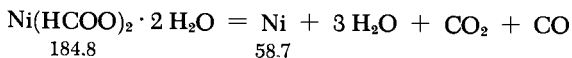
Nickel Formate-Paraffin Catalyst

Dry, precipitated NiCO_3 is dissolved in a 20% stoichiometric excess of 50% formic acid (80°C). The salt that crystallizes on cooling is filtered and dried at 110°C. Then, 100 g. of this formate is placed in a 500-ml. round-bottom flask equipped with a 12-mm. I.D. condenser tube (method of Allison et al. [1]) and slowly heated in aspirator vacuum together with 100 g. of paraffin wax and 20 g. of paraffin oil. The evolving gases are washed three times with paraffin oil to trap entrained paraffin wax which might plug the tubing. The product is then held for one hour at 170-80°C to remove the water of crystallization, and then the temperature is raised to 245-255° to decompose the formate; the termination of the reaction after an additional four hours can be recognized by a decrease in pressure. The reaction product is poured onto a metal sheet while still hot. After cooling as much as possible, the top paraffin layer is scraped off and the remaining very black mass is broken up into coarse pieces. Immediately before use, these paraffin-coated pieces are treated on a large Buchner funnel with a large quantity of hot water to remove most of the paraffin. The residue is dehydrated with pure ethanol; it is then immersed several times in petroleum ether, removing the petroleum ether by suction.

PROPERTIES:

Loose, black, nonpyrophoric powder; relatively stable in air, provided the paraffin is completely removed and well wetted by water. Shows an activity level similar to that of Raney Ni in hydrogenation of aromatic nitro compounds in aqueous solutions.

GENERAL:

Thermal decomposition of some metal compounds whose anions are reducing agents gives the metal, which may have a very high catalytic activity. The active metal may then react with air or with gaseous reaction products. If air is not allowed to penetrate (the reaction is conducted in an inert liquid), and the nascent gaseous products are quickly removed (use of high vacuum or a stream of inert gas—see use of H_2 , p. 1616), it is sometimes possible to obtain the metal in its active form.

The following starting metal compounds can be used in this procedure.

Hydrides, for example, CuH [16], ZnH_2 [15], CeH_3 [5], UH_3 [8] and so forth; these are decomposed in high vacuum at relatively low temperatures. Active uranium prepared from UH_3 has the remarkable ability to absorb large quantities of H_2 , O_2 , N_2 , CO , CO_2 and other "base" gases; it can thus be used for the purification of "inert" gases, especially in closed systems [4].

Formates, for example, those of Co [17], Ni [2, 9, 17] and Cu [17]. Decomposition of these compounds yields a very porous active metal structure of crystallites; the same is true of Ni and Co oxalates [3, 13]. The decomposition of these salts is, to a large extent, a topochemical reaction, in which the nascent free-metal atoms regroup themselves within a very small region. To obtain these metals in the form of carrier-supported catalysts, one can start with a mixture of salts [3].

A number of other organometallic compounds among them several acetylides [7] and nitrides, give the metal in a more or less pure form on thermal decomposition.

Finally, active, sometimes even pyrophoric metals can be obtained by thermal decompositions of **amalgams**. Thus, fine powders of Be [14], Cr [6] and Ni [9, 10] are obtained from their amalgams upon removal of Hg by distillation. Since electrochemically obtained Fe and Co amalgams [10, 11, 12] decompose spontaneously, the active metal can be separated by simple mechanical means. This type of cobalt is an extremely active hydrogenation catalyst, while Ni produced from an amalgam is totally inactive [10].

Highly active noble metals may also be generated from other compounds. Thus, Pd, Ir and Pt "sponges" are obtained upon calcination of their ammoniumhexachloro complex salts (see p. 1562).

REFERENCES:

1. F. Allison, J. L. Comte and H. E. Fierz-David. *Helv. Chim. Acta* 34, 818 (1951).
2. L. L. Bircumshaw and J. Edwards. *J. Chem. Soc. (London)* 1950, 1800.
3. V. Danes and P. Jiru. *Chem. Listy* 50, 302, 1048 (1956).
4. G. H. Dieke et al. *J. Opt. Soc. America* 42, 187, 433 (1952).
5. E. D. Eastmann, L. Brewer, H. A. Bromley, P. W. Gilles and N. Lofgren. *J. Amer. Chem. Soc.* 72, 2248 (1950).
6. J. Ferec. *Comptes Rendus Hebd. Séances Acad. Sci.* 129, 822 (1895).
7. R. Fricke and F. R. Meyer. *Z. Phys. Chem. [A]* 183, 177 (1939).
8. T. R. P. Gibb, J. J. McSharry and H. W. Kruschwitz. *J. Amer. Chem. Soc.* 74, 6203 (1952).

9. K. Heinle. Thesis, Univ. of Stuttgart, 1952.
10. F. Lihl and P. Zemsch. Z. Elektrochem. 56, 985 (1952).
11. A. Mayer and E. Vogt. Kolloid-Z. 125, 174 (1952).
12. F. Pavelek. Z. Metallkunde 41, 451 (1950).
13. J. Robin. Bull. Soc. Chim. France, Mém. [5] 1953, 1078.
14. C. I. Whitman and M. C. Kell. 131st Meeting, Amer. Chem. Soc., 1957; Angew. Chem. 69, 518 (1957) (abstract).
15. E. Wiberg, W. Henle and R. Bauer. Z. Naturforsch. 6b, 393 (1951).
16. E. Wiberg and W. Henle. Ibid. 7b, 250 (1952).
17. V. Zapletal et al. Chem. Listy 50, 1406 (1956).

Active Copper

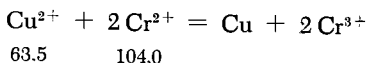

A fresh solution (800 ml.) of anhydrous Zn-free CrCl_2 (80 g.) is prepared in water strongly acidified with HCl (see p. 1367). Carbon dioxide is bubbled through and the solution is cooled to 0°C. Then, an ice-cold solution of 60 g. of $\text{CuSO}_4 \cdot 5\text{H}_2\text{O}$ in 350 ml. of water is added with vigorous stirring. The reduction starts immediately and ends in a short while. The precipitated copper powder is washed several times by decanting with water. The water is then displaced with ethanol. The alcohol is, in turn, displaced with ether or benzene. The product may be stored under either of these liquids, unless it must be inactivated before use (see p. 1614).

PROPERTIES:

Extremely fine red powder with no metallic luster. Very useful as a catalyst in organic chemistry [16, 17].

GENERAL:

The usefulness of this homogeneous phase reduction is restricted to the more noble metals. The range of reducing agents which can be used here is quite wide: cations of low valence (Cr^{2+} , Fe^{2+} , Tl^{3+} and others), reducing anions ($\text{S}_2\text{O}_4^{2-}$, PH_2O_2^- , HCOO^-), as well as H_2O_2 , N_2H_4 , NH_2OH , H_2CO and so forth may all be employed.

These reductions require, as a rule, quite specific reaction conditions, especially as far as the hydrogen ion concentration

and temperature are concerned. Both of the latter factors also affect the particle size of the product: the temperature does so in the way one would expect, but the pH in a less predictable fashion. Thus, for instance, gold precipitates from alkaline solutions in smaller primary crystallites than those obtained from acidic solution [8]. Certain reactions require above-atmospheric pressures [6, 10].

Homogeneous phase reductions have also been carried out in liquid NH_3 [1-5, 22-30]. The use of this solvent extends the general method to less noble metals, whose halides may thus be reduced with alkali metals. The intermediate compounds used are frequently metal ammines; these are carefully decomposed to give the active metal. The activity of the product increases with the atomic weight of the reducing alkali metal [26]; it is frequently maximum when Ca is the reducing agent [4, 5]. Many metals obtained via this procedure have remarkable catalytic activities. The use of the method is restricted by the tendency of many of the metals to combine with the reducing agent under the reaction conditions. Also, some of these metals undergo irreversible reactions with the solvent [2]. Solid solutions may be precipitated from solutions which contain two easily reduced cations (see below). Since the free energy of the less noble metals decreases as a result of formation of mixed crystals with more noble metals, the aqueous-solution procedure is not restricted to the alloys of noble metals. If the more readily reduced metal is also quite insoluble under the reaction conditions, it yields the nuclei upon which the remainder of the precipitate crystallizes. Such precipitates are, in general, finer and have a much narrower particle size distribution than chemically uniform materials [14, 24].

Precipitation from aqueous solutions:

Metal	Reducing agent	Reaction medium	References
Cu	Cr^{2+} $\text{S}_2\text{O}_4^{2-}$	acid ammoniacal	[7, 16, 17] [9]
Ni	PH_2O_2^-	neutral; ammoniacal	[6, 10]
Ag	N_2H_4	ammoniacal	[19]
Pt (Pt black)	HCOO^-	neutral	see p. 1562
Au	H_2O_2 NH_2OH	alkaline —	[8] [20]
Ag-Au	Fe^{2+}	acid	[14]
	H_2CO	alkaline	[12]
Ag-Hg	H_2CO	alkaline	[11]

Precipitation from solutions in liquid ammonia:

Metal	Reducing agent	References	Metal	Reducing agent	References
Fe	K	[23]	Ru, Rh, Pd	K	[29]
Co	K	[25]	Ag	Na, K, Ca	[1, 3, 4]
Ni	K	[5, 22, 24]	Ir	K	[28]
	Li, Na, K, Rb, Cs	[26]	Pt	K	[27]

Homogeneous reductions may also be carried out in the **gaseous phase**. In this case, the product metal must form a sufficiently volatile reducible compound (chlorides are frequently useful in this respect) and the reduction temperature must not be too high. Suitable reducing agents are the vapors of easily volatile base metals or hydrogen:

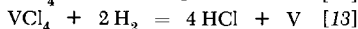
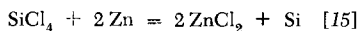

REFERENCES:

1. W. M. Burgess and E. Smoker. *J. Amer. Chem. Soc.* 52, 3573 (1930).
2. —. *Chem. Reviews* 8, 265 (1931).
3. W. M. Burgess and F. R. Holden. *J. Amer. Chem. Soc.* 59, 459 (1937).
4. —. *Ibid.* 59, 462 (1937).
5. W. M. Burgess and J. W. Eastes. *Ibid.* 63, 2674 (1941).
6. W. G. Courtney. *J. Chem. Physics* 23, 1174 (1955).
7. L. Domange. *Ann. Chim. Anal. Chim. Appl.* [4] 25, 5 (1943).
8. R. Fricke and F. R. Meyer. *Z. Phys. Chem.* [A] 181, 409 (1938).
9. —. *Ibid.* [A] 183, 177 (1938).
10. A. W. Goldenstein, W. Rostoker and F. Schossberger. *J. Electrochem. Soc.* 104, 104 (1957).
11. F. Hund and J. Müller. *Naturwiss.* 38, (1951); *Z. Elektrochem.* 57, 131 (1953).
12. F. Hund and E. Trägner. *Naturwiss.* 39, 63 (1952).
13. G. Jantsch and F. Zemek. *Monatsh. Chem.* 84, 1119 (1953).
14. P. Krumholz and A. Watzek. *Mikrochim. Acta* 2, 80 (1937).
15. D. W. Lyon, C. M. Olson and E. D. Lewis. *J. Electrochem. Soc.* 96, 359 (1949).
16. J. Piccard and L. M. Larsen. *J. Amer. Chem. Soc.* 39, 2006 (1917).

17. J. Piccard. *Helv. Chim. Acta* 5, 147 (1922).
18. H. Rabowski. Thesis, Univ. of Stuttgart, 1949.
19. G. Rienäcker and H. Bremer. *Z. anorg. allg. Chem.* 272, 126 (1953).
20. J. Turkevich, P. C. Stevenson and J. Hillier. *J. Phys. Chem.* 57, 670 (1953).
21. J. Voigt. *Das kolloidale Silber [Colloidal Silver]*, Leipzig 1929, p. 31 ff.
22. G. W. Watt and D. D. Davies. *J. Amer. Chem. Soc.* 70, 3753 (1948).
23. G. W. Watt and W. A. Jenkins. *Ibid.* 73, 3275 (1951).
24. G. W. Watt, W. F. Roper and S. G. Parker. *Ibid.* 73, 5791 (1951).
25. G. W. Watt and C. W. Keenan. *Ibid.* 74, 2048 (1952).
26. G. W. Watt and P. I. Mayfield. *Ibid.* 75, 1760 (1953).
27. G. W. Watt, M. T. Walling and P. Mayfield. *Ibid.* 75, 6175 (1953).
28. G. W. Watt and P. I. Mayfield. *Ibid.* 75, 6178 (1953).
29. G. W. Watt, A. Broodo, W. A. Jenkins and S. G. Parker. *Ibid.* 76, 5989 (1954).
30. W. Weyl. *Ann. Phys.* 123, 350 (1864).

Carbonyl Iron

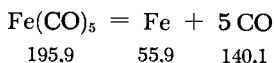

I. "FIBROUS" IRON

In the method of Beischer [1], a nitrogen stream saturated with Fe(CO)_5 at some temperature is combined in the bulb-shaped reactor of the apparatus shown in Fig. 338 with a stream of very hot nitrogen. The hot-gas quantity is always several times that of the cold one. Thus, for example, if the carbonyl-saturated N_2 flows at a rate of 2 liters/hour, the flow rate of the hot N_2 must be 40-100 liters/hour. If the reaction temperature is maintained between 200 and 700°C and the Fe concentration in the decomposition zone does not exceed 10 mg./liter, a uniform, fibrous product collects in the settling chamber.

PROPERTIES:

Fibrous carbonyl iron, prepared at 200°C and at a reactor concentration of 1 mg. of Fe/liter, quickly absorbs 10-15% of its weight in O_2 upon exposure to air; it must therefore be handled

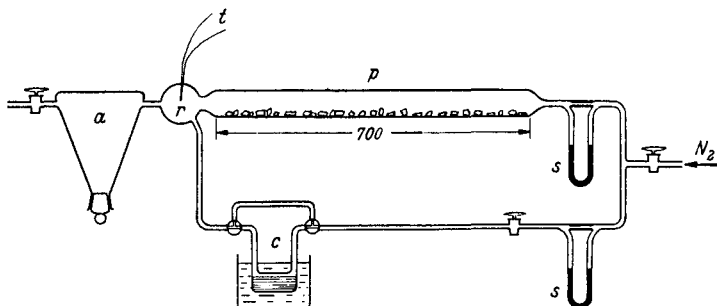

Fig. 338. Preparation of very fine iron powder with fibrous particles. *a* settling chamber; *r* reactor (30 mm. I.D.); *t* thermocouple; *p* nitrogen heating tube (20 mm. diameter), filled with small porcelain pieces, and heated either electrically or with a series burner; *s* flowmeter; *c* carbonyl storage.

and used in an N_2 atmosphere. The individual fibers reach a length of 10^8 A at a rather uniform thickness of about 2000 A. They consist of primary particles 70-90 A long (as determined by x-ray analysis).

II. IRON GLOBULES

In the method of Beischer [1] iron globules are formed at the maximum possible $Fe(CO)_5$ concentration in the decomposition zone. The apparatus of Fig. 339 is used. The air is flushed out with a moderately fast stream of N_2 introduced via the inlet tube to *a*. Then the liquid carbonyl compound is vaporized at a rate of 30 ml./hr. and the vapor fed into the decomposition chamber, which is heated to 200-600°C (depending on the reaction conditions). At this point the N_2 flow is either reduced or shut off completely. The tubing from the distillation flask to the decomposition tube (which is surrounded by a vertical heater) must be well insulated or maintained at about 110°C by means of a small electric coil or tape in order to avoid decomposition of the iron carbonyl. The first crop of product does not have the desired properties. A uniform powder consisting of microscopic globules is obtained only after a certain induction period.

PROPERTIES:

The individual globules have a diameter of 10^4 - 10^5 A and a peculiar structure similar to onion skin [5]. They contain (probably due to catalytic decomposition of CO on their surface) about

1% C, and they pick up 1-2% O₂ on exposure to air. The particles grow rapidly when heated to above 350°C [4]. Because of its particle size carbonyl iron is useful in solid-solid reactions (e.g. in metallurgical sintering processes).

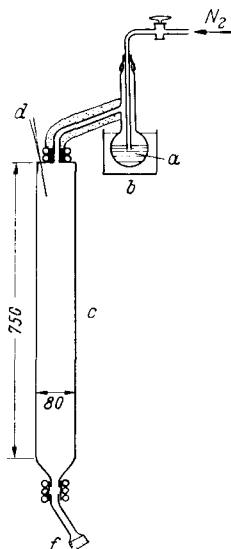

Fig. 339. Preparation of very fine iron powder with globular particles. *a* iron carbonyl distillation flask; *b* oil bath; *c* decomposition reactor and furnace; *d* thermocouple; *f* filter.

GENERAL:

The process may also be used with other metals that form volatile, readily decomposed carbonyls. The optimum reaction conditions vary from case to case. In some instances, suppression of carbide formation is the major problem [2].

A material with a developed inner structure (i.e., porous) is developed if the decomposition is carried out completely in the reactor chamber (whereby the heat is supplied by radiation or hot gases). If the reacting gases are also made to follow a vortex path, then uniform, small particles are obtained [3]. However, any undecomposed carbonyl which reaches the wall of the vessel decomposes on it, precipitating the metal in the form of a tenaciously adhering mirror or in layers of leaflets (see p. 1644). Incomplete removal of air or deliberate addition of oxygen to the reactor may produce fine metal oxide aerosols (see p. 1669).

REFERENCES:

1. D. Beischer. *Z. Elektrochem.* **45**, 310 (1939).
2. D. T. Hurd, H. R. McEntee and P. H. Brisbin. *Ind. Eng. Chem.* **44**, 2432 (1952).
3. I. G. Farbenindustrie A.G. French Pat. 691,243 (1930).
4. F. E. Jaumot and L. Muldower. *J. Franklin Inst.* **256**, 377 (1935).
5. L. Schlecht, W. Schubardt and F. Duftschmidt. *Z. Elektrochem.* **37**, 485 (1931).

Explosive Antimony

A 25% solution of SbCl₃ in 10% hydrochloric acid is electrolyzed at 20°C in the apparatus shown in Fig. 340 [6]. The solution is

obtained by adding 300 ml. of conc. HCl to 500 ml. of water, dissolving 250 g. of SbCl_3 in this mixture, and adding water to make up one liter. The electrolysis vessel, placed in a constant-temperature bath, is either a 650-ml. three-neck Woulfe flask or a one-liter filter jar [7]. The anode *a* consists of very high-purity antimony; if it is short and does not protrude from the electrolysis jar, it is extended with a platinum wire, the remaining length being supplied with a copper wire. The cathode *c* is best prepared from a 10-cm.-long piece of 1-mm.-diameter Pt wire, but copper [7] or manganin [18] wires of the same diameter are also suitable; the cathode *c* is bent to a U shape and rigidly attached to the stirrer (with the two free ends directed downward). The electrical connection is made via a drop of mercury placed inside the hollow stirrer shaft; this pool contacts a sealed-in platinum wire, which in turn makes contact with the cathode wire.

The electrolysis is started at a very low current; after five minutes the current is increased to give a cathode density of approximately 0.3 amp./in.², while stirring at a rate of 1000 r.p.m. Since the cathode surface gradually increases during the run due to deposition of the smooth, shiny metal, the current must be gradually increased (25% in two hours). A two-hour run yields about 400 mg. of metal deposit, sufficient for demonstration purposes. After completion of the electrolysis the cathode is carefully removed (avoid bumping against the vessel wall), washed with conc. HCl, then with water, and rinsed with alcohol and ether.

PROPERTIES:

X-ray analysis [8, 10, 11] indicates that explosive antimony is amorphous, with a crystal structure almost like that of a liquid except for some short-range ordering of the atoms. This state is stabilized by small amounts of SbCl_3 or SbOCl , which contaminate the precipitate. The electrical conductivity is 4-5 orders of magnitude smaller than that of the pure element [4, 18]. Crystallization, which is a first-order reaction [4], may be initiated by scratching the walls, by slight heating, or by an electric discharge. Due to a

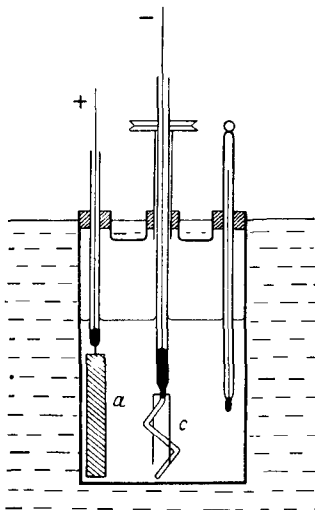

Fig. 340. Preparation of explosive antimony. *a* anode of pure antimony; *c* cathode of platinum wire.

“heat of crystallization” of 2.5 kcal./g.-atom [5, 7], the trichloride is vaporized and becomes visible as a fog.

GENERAL:

Good cathodic deposition of metal powder or sponge is controlled by a number of factors which depend on the material itself and on the experimental conditions employed [14, 20, 21].

a) **Cathode surface conditions.** A low concentration of the deposited ion in the cathode surface film tends to prevent the formation of a solid deposit layer, as the crystals then tend to grow away from the surface. Low surface concentrations are enhanced by the use of a dilute electrolyte, complexes in which the metal is firmly bound, the presence of high concentrations of neutral salts, low solution temperatures, and high current density in an unagitated electrolyte.

b) **Low overvoltage** of the metal to be deposited; this causes needlelike and dendritic deposits which are easily crushed to a crystalline powder, e.g., Cd [19]. The overvoltage of the metals generally increases with complex formation and decreases with increasing temperature. These factors therefore work in a direction exactly opposite to that cited under (a).

c) **Coprecipitation of basic salts** from the cathode film also gives a porous precipitate, a condition favored by the use of neutral or weakly acid solutions (depending on the tendency of the metal ion to hydrolyze). It is, however, also possible to remove H^+ from the cathode film; this can be done by electrolytic deposition of electron-bearing ions (low cathode current yield)—a factor which may be enhanced by metallic impurities or low hydrogen overvoltage—or by oxidizing agents which use up H^+ while accepting electrons. The effect of temperature on this coprecipitation varies: higher temperatures favor hydrolysis, but also favor the increased supply of hydrogen ions from the solution by increasing the diffusion rate.

An appropriate selection and balance of these factors should permit electrolytic production of powders of every metal that can be deposited from aqueous solution. The particle size of the cathode deposit can be reduced by the use of ultrasound [2, 3].

The simultaneous evolution of H_2 , which is not absolutely essential for the preparation of metal powder, nevertheless causes a certain fluffing of the metal precipitates, allowing them to occlude considerable amounts of nonmetallic impurities from the electrolyte. Thus Cu or Ag precipitates may, under proper electrolysis conditions, occlude several percent of citric or tartaric acids (or their salts), as well as asparagine, and so forth. In this state the powders have lower negative potentials than the pure metals [15], in the same way as explosive antimony [18].

Fused salts (fluorides, chlorides) easily yield metal powders [1] because they have virtually no overvoltage as long as the bath temperatures are kept low.

The following metal powders have been obtained by electrolysis of aqueous solutions: Fe [12, 20, 21], Ni [12, 20, 21], Cu [12, 16, 20, 21], Zn [12, 13, 20, 21], Ag [17], Cd [19, 20, 21], Sn, Pb [12], Ni-Pd alloy [9].

REFERENCES:

1. J. Andrieux. *Rev. Metallurg.* 45, 49 (1948).
2. B. Claus. *Z. techn. Physik* 16, 80 (1935).
3. B. Claus and E. Schmidt. *Kolloid-Beih.* 45, 41 (1937).
4. C. C. Coffin. *Proc. Roy. Soc. [A]* 152, 47 (1935).
5. C. C. Coffin and C. E. Hubley. *Canad. J. Res. [B]* 28, 644 (1950).
6. E. Cohen and C. C. Coffin. *Z. phys. Chem. [A]* 149, 417 (1930).
7. H. J. Fraden. *J. Chem. Educ.* 28, 34 (1951).
8. R. Glocker and H. Hendus. *Z. Elektrochem.* 48, 327 (1942).
9. Y. D. Kondrashev, I. P. Tverdovskiy and S. L. Vert. *Dokl. Akad. Nauk SSSR* 78, 729 (1951).
10. H. Krebs. *Naturwiss.* 40, 389 (1953); *Angew. Chem.* 65, 261 (1953).
11. H. Krebs and F. Schultze-Gebhardt. *Naturwiss.* 41, 474 (1954).
12. E. Mehl. *Metal Treatment, Drop Forging* 17, 118 (1950).
13. M. Passer and G. Hänsel. *Wiss. Veröff. Siemens-Konzern, Werkstoff-Sonderheft.* 1940, 124.
14. M. Passer. *Kolloid-Z.* 97, 272 (1941).
15. E. Raub. *Metallkunde* 39, 33 (1948).
16. G. Rienäcker and H. Bremer. *Z. anorg. allg. Chem.* 272, 126 (1953).
17. G. F. Smith and F. W. Cagle. *Analyt. Chem.* 20, 83 (1948).
18. H. von Steinwehr and A. Schulze. *Z. Physik* 63, 815 (1930).
19. W. D. Treadwell, M. Lüthi and A. Rheiner. *Helv. Chim. Acta* 4, 551 (1921).
20. G. Wranglen. *Trans. Roy. Inst. Technol. Stockholm, No.* 37 (1950).
21. Same, *J. Electrochem. Soc.* 97, 353 (1950).

Silver

(Active Agent for Reductors)

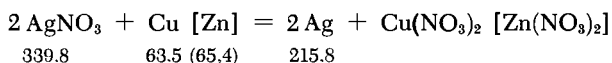

A sheet of electrolytic copper [7] or several zinc rods [2] are suspended in a well-stirred solution of 29 g. of AgNO_3 in 400 ml.

of water acidified with a few drops of HNO_3 . The reaction starts immediately. When the solution is free from Ag^+ , the copper sheet and the stirrer are removed and the silver sludge is washed several times with dilute sulfuric acid (decantation). This removes most of the copper (zinc); the sludge is then transferred to the reductor tube and further washed with dilute sulfuric acid until free from Cu (Zn). The sulfuric acid is then displaced with 1N HCl; the acid must always cover the silver in the reductor, whether it is being used or just stored. Any air bubbles present are removed by shaking.

The regeneration of the silver in the reductor proceeds via method of Wislicenus [9]. A small piece of zinc is placed on top of the silver filling of the column (this column packing is blackened for about 3/4 of its length by superficial chloride formation). The reductor should be filled with dilute sulfuric acid. The reduction of the AgCl proceeds rapidly if the Zn makes good contact with the reductor material.

PROPERTIES:

Fine silver-gray powder; used in analytical chemistry as a packing for Jones reductors (reductions in hydrochloric acid solutions).

GENERAL:

This process does not usually yield very pure products [4, 6]. The less noble metals (e.g., Cu [4]) become pyrophoric at low temperatures. The somewhat higher energy level of these preparations is due to the large surface area and to lattice defects. Some metals tend to form fibrous structures [8] with appropriate reducing metals and solvents.

Zinc can also be used as a reducing agent for the preparation of Cu [4, 5], Ni [3] and Sn [1].

REFERENCES:

1. G. Buchner. *Chemiker-Ztg.* 1894, 1904.
2. K. Fischbeck and W. Ellinghaus. *Z. anorg. allg. Chem.* 165, 55 (1927).
3. L. Kh. Freydlin and K. G. Rudneva. *Dokl. Akad. Nauk SSSR* 100, 723 (1955).
4. R. Fricke and F. R. Meyer. *Z. phys. Chem.* [A] 183, 177 (1938).
5. L. Gattermann. *Ber. dtsch. chem. Ges.* 23, 1218 (1890).
6. M. E. Straumanis and C. C. Fang. *J. Electrochem. Soc.* 98, 9 (1951)
7. G. H. Walden, L. P. Hammett and S. M. Edmonds. *J. Amer. Soc.* 56, 350 (1934).

8. M. Yanagisawa and H. Fujihira. Bull. Inst. Chem. Res. Kyoto Univ. 31, 85 (1953).
9. W. Wislicenus. Liebigs Ann. 149, 220 (1869).

Deposition of Metals from the Vapor Phase

Deposits of metals from the vapor phase [2, 5, 6, 10] are especially useful for studies of very pure materials, where it is desired to correlate the structure and the electronic state of a solid with its catalytic activity. Metal deposits can be investigated by electron diffraction, conductivity measurements, and optical and magnetic techniques even while they are covered with a layer of adsorbed material or while actually participating in a catalytic process.

The **experimental apparatus** varies with the type of study. In general, the parts of a glass apparatus should be fused together so as to avoid greased glass joints. This means that not only the reaction vessels proper but all the auxiliary devices such as gas receivers, cold traps, manometers and so forth must be fused to the apparatus prior to the start of a run. To obtain reproducible results, the catalyst carrier is carefully purified prior to sealing the apparatus, heated slowly to 400-500°C, and baked at this temperature for several hours in a high vacuum. Only then is the carrier temperature adjusted to the level required for condensation and the deposition of the metal vapor started. All these operations must be carried out in the vacuum of a running pump. Fresh metal deposits adsorb gases extremely readily. For this reason all gases other than those actually needed in the process (especially those which may be catalyst poisons) should be removed from the apparatus prior to the start of deposition.

Reaction vessels: The inside wall is usually used as the support for the deposit. The vessels, which are made of quartz or glass, are of two common types: spherical flasks for adsorption measurements [1, 29] and cylinders, which are especially suited for experiments in catalysis [5, 22]. Since the studies are usually conducted at constant temperature, the wall must have good thermal conductivity. The vessel is either immersed in a bath or surrounded by a jacket filled with a heat transfer medium.

Vaporization of the metal: The metal must be melted in vacuum. Aside from this requirement, which applies in all cases, the experimenter can choose from a variety of options. The usual procedure involves resistance heating of a suitably shaped wire coil. This method can be used where the metal has a sufficiently high volatility below the melting point to produce the vapor at an appreciable rate. In other cases it may be necessary to vaporize the metal at or above its m.p. In these cases, it is

vaporized from the surface of a resistance-heated spiral or boat made of a high-melting metal (W, Mo or Ta). The current leads are sealed to the glass vessel; if necessary, they may be introduced in water-cooled ground joints. Suitable sheet-metal screens prevent condensation of metal in unwanted places.

Additional possible heating methods include high-frequency induction heating and cathode sputtering. However, one should remember that deposits obtained from a vapor and from a sputtered cathode differ somewhat in structure [14].

Condensation. In general, the condensation conditions greatly affect the secondary structure and the catalytic activity of the metallic deposit [7]. Depending on condensation conditions, the metal layers deposited on amorphous supports (glasses) at low temperatures may be either crystallographically disordered (random) or oriented [5, 25]. In an oriented layer the crystallites adhere to the support in a uniform fashion, the boundary with the support being the simply indexed crystal lattice plane that has the lowest atomic (or molecular) density. The crystallite arrangement in all other directions is totally random. Epitaxial growth may occur on crystalline material, with deviations of up to 15% in the lattice dimensions [8, 24, 34]. Metastable crystal modifications have also been observed in vapor deposits [11].

Condensation at low temperatures favors the formation of homogeneous mirrors, which remain stable at room temperature. Under these conditions mirrors are formed even by metals that otherwise would appear dull [28]. The specific surface area, which is controlled primarily by the melting point of the metal, is slightly higher in deposits obtained at low temperatures than in those produced at 0°C [32]. Higher condensation temperatures or the presence of inert gases (noble gases can be used in all cases, nitrogen sometimes, while hydrogen is completely unsuitable; see [12]) results in a decrease of the orientation of the crystallites (the latter cease to be oriented at sufficiently high condensation temperatures). An additional phenomenon appearing at high condensation temperatures or in the presence of gases is that the individual crystallites become smaller while retaining their normal lattice constants [20] and the deposits become dull black. In contrast to mirrors, they show a strong small-angle x-ray scattering [9].

Simultaneous deposition of lattice-distorting substances (NaCl, H₂O) has been recommended for obtaining defect structures [12].

Metal deposits which are useful for preparative purposes may be obtained by **thermal decomposition** of suitable volatile metal compounds (hydrides, carbonyls) on hot surfaces. For instance, decomposition of Ni(CO)₄ on Pyrex glass wool at 150°C produces a deposit of very finely divided nickel, which is an excellent catalyst for gas-phase hydrogenation of olefinic double bonds [4].

Literature on metal deposition from a vapor

Metal	Studies on the properties of the deposit	Adsorption measurements	Catalytic studies
Fe	[13, 14, 32]	[3, 21, 33]	[18, 27]
Co	[13]	[21]	
Ni	[5, 7, 11, 13, 20, 25 32]	[5, 7, 26, 29, 33]	[5, 15, 16, 17, 18, 22, 23, 27, 30]
Cu	[9, 13, 19, 28]	[1]	
Rh	[32]		[16, 17, 18]
Pd			[16, 17]
W	[32]	[31, 33]	[17, 18, 27]

REFERENCES:

1. J. A. Allen and J. W. Mitchell. *Discuss. Faraday Soc.* No. 8, 309 (1950).
2. J. A. Allen. *Rev. Pure Appl. Chem.* 4, 133 (1954).
3. J. Bagg and F. C. Tompkins. *Trans. Faraday Soc.* 51, 1071 (1955).
4. L. L. Baker and R. B. Bernstein. *J. Amer. Chem. Soc.* 73, 4434 (1951).
5. O. Beeck, A. E. Smith and A. Wheeler. *Proc. Roy. Soc. [A]* 177, 62 (1940).
6. O. Beeck. *Discuss. Faraday Soc.* No. 8, 118 (1950).
7. O. Beeck and A. W. Ritchie. *Ibid.* No. 8, 159 (1950).
8. M. Blackman. *J. Physique Radium* 17, 176 (1956).
9. B. Carroll and I. Fankuchen. *J. Chem. Phys.* 16, 153 (1948).
10. E. C. Crittenden and R. W. Hoffman. *J. Physique Radium* 17, 179 (1956).
11. G. I. Finch, K. P. Sinha and A. Goswami. *J. Appl. Phys.* 26, 250 (1955).
12. W. Frankenburger, K. Mayrhofer and E. Schwamberger. *Z. Elektrochem.* 37, 473 (1931).
13. R. W. Hoffman, R. D. Daniels and E. C. Crittenden. *Proc. Phys. Soc. [B]* 67, 497 (1954).
14. A. van Itterbeek, L. de Greve and F. Heremans. *Appl. Sci. Res. B* 2, 320 (1952).
15. C. Kemball. *Trans. Faraday Soc.* 48, 254 (1952).
16. —. *Proc. Roy. Soc. [A]* 214, 413 (1952); 217, 376 (1953).
17. —. *Trans. Faraday Soc.* 50, 1344 (1954).
18. —. *J. Chem. Soc. (London)* 1956, 735.
19. G. L. Kington and J. M. Holmes. *Trans. Faraday Soc.* 49, 417, 425 (1953).
20. S. Mamiya. *Science of Light (Japan)* 1, 42 (1972).

21. A. S. Porter and F. C. Tompkins. Proc. Roy. Soc. [A] 217, 529, 544 (1953).
22. G. Rienäcker and N. Hansen. Z. anorg. allg. Chem. 284, 162; 285, 283 (1956); Z. Elektrochem. 60, 887 (1956).
23. H. C. Rowlinson, R. L. Burwell and R. H. Tuxworth. J. Phys. Chem. 59, 225 (1955).
24. L. Royer. J. Physique Radium 17, 171 (1956).
25. W. M. H. Sachtler, G. Dorgelo and W. v. d. Knaap. J. Chim. Physique, Physicochim. Biol. 51, 491 (1954).
26. W. Scheuble. Z. Physik 135, 125 (1953).
27. J. H. Singleton, E. R. Roberts and E. R. S. Winter. Trans. Faraday Soc. 47, 1318 (1951).
28. R. Suhrmann and G. Barth. Z. Phys. 103, 133 (1936).
29. R. Suhrmann and K. Schultz. Z. Phys. Chem. [N.F.] 1, 69 (1954).
30. R. Suhrmann and G. Wedler. Z. Elektrochem. 60, 892 (1956).
31. B. M. W. Trapnell. Trans. Faraday Soc. 48, 160 (1952).
32. —. Ibid. 51, 368 (1955).
33. M. Wahba and C. Kemball. Ibid. 49, 1351 (1953).
34. D. W. Pashley. Advances in Physics 5, 173 (1956).

HYDRATED OXIDE GELS

The hydrated oxides used as adsorbents are called, more precisely, xerogels* or aerogels. They are prepared by drying the corresponding hydrogels. The adsorptive capacity of the xerogels depends on the drying process used. The starting hydrogels are prepared by the following methods:

PRECIPITATION REACTIONS

The molecules of precipitated hydrogels are usually arranged in a random order. However, ordered structures may form if the conditions are such that basic salts or aggregated anions can be produced during the precipitation or when such starting materials are used. The surface properties and pore structure of these gels, which show aggregates of submicroscopic globular particles under the electron microscope, depend on the precipitation reaction used. Among these reactions are:

1) Precipitation with an acid or a base (see hydrated chromium oxide gel, p. 1648; silica gel, p. 1648).

*Translation Editor's Note: In American practice the term "xerogel" is little used, although more precise. We prefer "resin" for organic materials and "dry gel" for inorganic ones.

2) Hydrolyses of alkoxides that give preparations free of electrolytes (see aluminum hydroxide gel p. 1652).

REACTIONS OF SOLIDS

These reactions should be topochemical and may use preformed starting materials. Among the preparative methods of this class are:

1) Topochemical hydroxide formation [see "glimmering" iron (III) hydrated oxide, p. 1654].

2) Leaching out one component of a solid mixture (see p. 1656).

The preparation of gels by controlled coagulation of sols is used more rarely. However, it may still be of interest in special cases. For instance, globular gel particles, which are useful as fluidized bed catalysts, are obtained by allowing the sol to drop into a medium which causes its spontaneous coagulation.

On simple drying in air or heating (if necessary), gels obtained by precipitation reactions show a much higher shrinkage than those obtained by reactions of solids. The shrinkage may, however, be avoided to a large extent if instead of drying the material one displaces the water with organic solvents of low surface tension. These are then removed by evaporation. In general, the pore volume increases as the surface tension of the liquid used decreases [7].

Aerogels with an especially high surface activity and specific surface (up to $800 \text{ m}^2/\text{g}$. [4]) are obtained via the procedure of Kistler [5, 6]. In this case, the water in the hydrogel is displaced with an organic liquid which is miscible with water. The preparation is then heated in an autoclave to a point above the critical temperature of the solvent where the supercritical vapor is released. Gels prepared by this method retain the volume and the structure that existed prior to drying. In the preparation of hydrated oxide gels, one must remember that the reaction products age rapidly on contact with the aqueous mother liquor; in addition the aging process is markedly affected by the electrolyte content of the solution. Only a few precipitates remain amorphous for any length of time; most convert fairly rapidly to crystalline hydroxides or hydrated oxides [2, 3]. However, their gel nature initially remains almost the same. Some hydrated oxide gels must not be heated above a certain temperature during drying to avoid spontaneous crystallization with glimmering deflagration (compare also metamictic minerals [1, 8, 9]).

REFERENCES:

1. A. Faessler. *Z. Kristallogr.* **104**, 81 (1942).
2. R. Fricke. *Kolloid-Z.* **69**, 312 (1934).

3. H. B. Weiser and W. O. Milligan, "The constitution of inorganic gels" in: *Advances of Colloid Science*, Vol. I, New York, 1942; W. O. Milligan. *J. Phys. Colloid Chem.* 55, 497 (1951).
4. M. F. L. Johnson and H. E. Ries. *J. Amer. Chem. Soc.* 72, 4289 (1950).
5. S. S. Kistler. *J. Phys. Chem.* 36, 52 (1932).
6. S. S. Kistler et al. *Ind. Eng. Chem.* 26, 388, 658 (1934).
7. I. Y. Neymark and R. Y. Sheynfayn. *Kolloid. Zh.* 15, 145 (1953).
8. A. Pabst. *Amer. Mineralogist* 37, 137 (1952).
9. W. Primak. *Phys. Rev.* [2] 95, 837 (1954).

Hydrated Chromium Oxide Gel

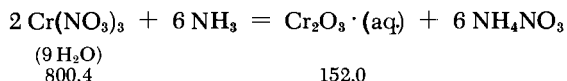

Slightly more than one liter of 0.12M NH₃ solution is added with efficient stirring to one liter of 0.04M Cr(NO₃)₃ (the excess of NH₃ favors the formation of a flocculent precipitate). The precipitate is washed 10 times by decantation with water, filtered and dried at 150°C [5].

PROPERTIES:

Dark-green glasslike granules. The N₂ absorption isotherm gives a specific surface of 310 m²/g. (BET method) [5]. Used as a hydrogenation and dehydrogenation catalyst [18].

Silica Gel

To start with, 3.4 liters of sodium silicate solution (sodium waterglass, d²⁰ 1.37) is diluted with one liter of water (mechanical stirring). Then, 10N HCl is added at a rate of 10 ml./min. until thymol blue shows an acid reaction (pH 2-2.8). (After addition of 400 ml. of the acid the mixture becomes viscous and rubberlike. The acid addition is interrupted and the mass is broken up. It is then manually stirred while acid is added in drops. The mixing is continued until a thin suspension is obtained. The remainder of the acid is then added at the original rate until the desired pH is reached.) The mixture is then stirred for two additional hours at room temperature, suction-filtered and washed until the wash liquid is no longer acid. The gel is dried at 200°C for 12 hours, ground to the desired particle size, and finally washed free of Cl⁻.

The product is then dried at 250°C for 24-48 hours [11]. Yield: 1.5 kg.

PROPERTIES:

Dull-white gel granules; hardness approximately that of glass; high specific surface (500 m²/g.). Gels prepared according to the above directions are especially useful for chromatographic purposes [11].

GENERAL:

Many other hydroxide precipitates may be obtained in a way similar to that used for the hydrated chromium oxide gel. However, when selecting the starting metal salts one must remember that anions of multivalent acids, especially SO₄²⁻, are frequently difficult to remove from the product by washing. For this reason nitrates, chlorides and perchlorates are preferred. In addition, hydrated oxides obtained from sulfates frequently have a very high tendency to spontaneous deflagration. Isomeric hydrated salts, such as chromium (III) chloride hydrates, may give a variety of hydroxide precipitates ([10]; see p. 1345). The base is usually a freshly prepared, carbonate-free NH₃ solution. In cases when the metal ion forms stable ammine complexes which make a quantitative precipitation difficult, the precipitation may be carried out with ammonium acetate or tetramethylammonium hydroxide solutions [22]. In addition to these agents and the various alkali metal hydroxides, active MgO and alkaline earth hydroxides may also be used as precipitants. The impurity cations that are adsorbed on the precipitate may, under certain circumstances, act as catalyst or adsorption promoters. Hydrated oxide gels of amphoteric metals may also be obtained by careful neutralization of the corresponding alkali hydroxometallate solutions. As a rule, such precipitates are microcrystalline and contaminated with large amounts of alkali ions. Hydrated oxides of cations with a high ionic potential, such as Ti⁴⁺, may also be obtained by hydrolysis of their salts, whereby a dialyzer may also be used [28, 33, 34].

The quantity of the precipitating agent has a large effect on the properties of the product gel. Incomplete precipitations (final acidic solution in the case of hydrated metal oxide gels, final alkaline solution in the case of silica gels) produce soft, friable, strongly opalescent gels with a wide range of pore sizes and low specific surfaces. An excess of the precipitating agent, on the other hand, usually causes the condensation reaction to go to completion. As a result, the gel products are thoroughly cross-linked and the presence of the three-dimensional network makes them hard, elastic and translucent, with fairly uniform pore size.

The properties of the product gels depend also on the reaction temperature, as well as the order and rate of addition of the reagent solutions. If the precipitating agent is added slowly to the salt solution, there is a possibility of forming an intermediate basic salt [12, 24]; these may then precipitate as well defined compounds [6]. On the other hand, slow addition of the precipitant may yield isopolyanions (polysilicate ions and so forth); these last may also be added beforehand to obtain special effects. Such precipitation products are aged in a specific way compared with gels obtained by fast addition of the salt solution to the precipitant [17, 20].

The adsorptive selectivity of the gels may be influenced to a certain extent by the preparative conditions. One may, for instance, produce silica gels which adsorb a specific dye of characteristic molecular shape and charge distribution. This is done by dispersing this dye in the silicate solution and the precipitating the gel in the presence of the dye [2, 4, 9]. Similar experiments have been carried out with optically active compounds ([3], see also [1]). The silica gel surface may also be modified in a specific way by adsorbing on it appropriate substances; this yields preparations with completely new adsorptive properties [14, 19].

The adsorptive activity of gels is reduced not only by heat but also by grinding. Grinding produces a slight reduction in the specific surface. This is occasionally accompanied by a reduction of the average pore radius [16].

The above general remarks apply also to mixed precipitates of metal hydroxides as well as to silica-hydrated metal oxide mixed gels. As would be expected, products obtained by simultaneous precipitation of two (or more) compounds differ from those obtained by mechanical mixing of finished gels; both of these types of gels are in turn different from mixed gels produced by sequential precipitation in the same solution. Finally, we should mention the so-called chalky silica gels (see p. 1656).

To summarize, the quality of the final product gels depends on the history of the preparation. In view of the many possible slight variations in the procedure which affect the reactions involved, it is not surprising that the products vary in quality.

The product gels may be freed from impurity ions (usually present in large amounts) by dialysis or electrodialysis. However, even this procedure does not yield gels completely free from electrolytes. If completely pure products are desired, it is best to use the hydrolysis of alkoxides presented on p. 1652.

Finally, let us cite a number of new publications dealing with the preparation and testing of hydrated oxide gels: hydrated aluminum oxides [30, 32]; silica gels, unmodified [11, 13, 16, 21, 27]; silica gels, modified [1-4, 9, 14, 19]; hydrated titanium oxides [8, 15, 28, 33, 34]; hydrated chromium oxides [5, 10, 18, 23-25];

hydrated iron oxides [7, 17, 20, 23, 29]; hydrated zirconium oxide [26]; hydrated tin oxide [31]; hydrated thorium oxides [8].

REFERENCES:

1. A. H. Beckett and P. Anderson. *Nature* 179, 1074 (1957).
2. S. A. Bernhard. *J. Amer. Chem. Soc.* 74, 4946 (1952).
3. R. Curti and O. Colombo. *Ibid.* 74, 3961 (1952).
4. F. H. Dickey. *Proc. Nat. Acad. Sci. USA* 35, 227 (1949); *J. Phys. Chem.* 59, 695 (1955).
5. P. H. Emmett and M. Cines. *J. Amer. Chem. Soc.* 68, 2535 (1946).
6. W. Feitknecht. *Fortschr. chem. Forschg.* 2, 670 (1953).
7. R. Fricke and L. Klenk. *Z. Elektrochem.* 41, 617 (1935).
8. O. Glemser. *Ibid.* 45, 825 (1939).
9. R. G. Haldeman and P. H. Emmett. *J. Phys. Chem.* 59, 1039 (1955).
10. A. Hantsch and E. Torke. *Z. anorg. allg. Chem.* 209, 60 (1932).
11. R. Harris and A. M. Wick. *Ind. Eng. Chem., Anal. Edit.* 18, 276 (1946).
12. J. Heubal. *Ann. Chimie [12]* 4, 699 (1949).
13. C. B. Hurd, R. C. Pomatti, J. H. Spittle and F. J. Alois. *J. Amer. Chem. Soc.* 66, 388 (1944) and previous articles.
14. H. Kautsky and H. Wesslau. *Z. Naturforsch.* 9 b, 569 (1954).
15. J. J. Kipling and D. B. Peakall. *J. Chem. Soc. (London)* 1957, 834.
16. I. Kirshenbaum and R. K. Grover. *J. Amer. Chem. Soc.* 70, 1282 (1948).
17. H. W. Kohlschütter and E. Kalippke. *Z. phys. Chem. [B]* 42, 249 (1939).
18. W. A. Lazier and J. V. Vaughen. *J. Amer. Chem. Soc.* 54, 3080 (1932).
19. K. G. Miyeserov. *Zh. Obshchey Khimii* 24, 947 (1954).
20. L. N. Mulay and P. W. Selwood. *J. Amer. Chem. Soc.* 77, 2693 (1955).
21. A. C. de Pradel and B. Imelik. *Comptes Rendus Hebd. Séances Acad. Sci.* 242, 122 (1956).
22. G. Rienäcker and G. Schneeberg. *Z. anorg. allg. Chem.* 282, 222 (1955).
23. P. Royen, A. Orth and K. Ruths. *Ibid.* 281, 1 (1955).
24. G. M. Schwab and K. Polydoropoulos. *Ibid.* 274, 234 (1953).
25. A. Simon, O. Fischer and T. Schmidt. *Ibid.* 185, 107 (1930).
26. A. Simon and O. Fischer. *Ibid.* 185, 130 (1930).
27. K. S. W. Sing and J. D. Madeley. *J. Appl. Chem.* 3, 549 (1953); 4, 365 (1954).
28. H. B. Weiser and W. O. Milligan. *J. Phys. Chem.* 38, 513 (1934); 45, 1227 (1941).

29. D. H. Weitzel and O. E. Park. *Rev. Sci. Instruments* 27, 57 (1956).
30. R. Willstätter and H. Kraut. *Ber. dtsch. chem. Ges.* 56, 149, 1117 (1923); 57, 58, 1082 (1924).
31. R. Willstätter, H. Kraut and W. Fremery. *Ibid.* 57, 63, 1491 (1924).
32. R. Willstätter, H. Kraut and O. Erbacher. *Ibid.* 58, 2448, 2458 (1925).
33. S. Wilska. *Acta Chem. Scand.* 8, 1796 (1954).
34. S. Ya. Berestneva, G. A. Koretskaya and V. A. Kargin. *Kolloid. Zh.* 12, 338 (1950).

Aluminum Hydroxide Gel

α -GEL BY THE METHOD OF WILLSTÄTTER AND KRAUT

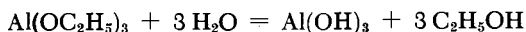

In the method of Schmäh [25], 400 ml of CO_2 -free double-distilled water is placed in a one-liter, three-neck flask, whose center neck carries a mercury-seal stirrer. One side neck is closed off with a soda lime tube. The other is fitted with a dropping funnel with an ungreased stopcock from which a solution of 3 g. of aluminum ethoxide in 200 ml. of absolute ethanol is allowed to run in a thin stream into the vigorously stirred water (the aluminum ethoxide is prepared from Si- and Fe-free 99.99% Al by one of the methods given on page 840 and is then dissolved by refluxing with the required amount of ethanol). During the hydrolysis of the ethoxide, the temperature rises by 6-8°. The precipitate is washed by decantation with double-distilled water (the settling may be speeded up by centrifugation).

PROPERTIES:

The α -gel is completely free of electrolytes; its surface is quite alkaline. The fresh gel is completely amorphous [19]; it ages rapidly to bayerite via the intermediate stage of böhmite, the alkalinity of the surface decreasing considerably in the process [16, 17]. Aluminum oxides prepared from this gel are more active than the usual aluminum oxide catalysts [1].

GENERAL:

This method of preparation allows some latitude in the hydrolysis conditions as well as in the alcohol moiety of the alkoxide. The hydrolysis may be carried out in absolute ethanol

solution, the hydrolysis agent being atmospheric moisture (stirring in air). Alternatively, aqueous alcohol may be added to the ethanol solution, or the hydrolysis may be carried out in the reverse fashion, by addition of the alcoholic solution to water (the water may be hot, if required). Ammonia solution may be used instead of water. Solid alkoxides (such as some methoxides) may be hydrolyzed in a stream of moist air with heating if required [27]. Since the hydrolysis of alkoxides of metals of variable valence may proceed in steps [2, 5, 11], the most active products are obtained on fast precipitation.

The ability of the alkoxide to undergo hydrolysis depends on the nature of the alcohol moiety. This ability decreases with increase in the molecular weight of the organic part and increases in the order of primary to tertiary alcohol (as shown by zirconium and titanium alkoxides [6, 8, 26]). The volatility of the alkoxides increases in the same order. This fact is of some importance, because with elements having a high atomic number, it is often only the tert-alkoxides that can be distilled (and thus purified), even in high vacuum (for example, Th [10]).

A high hydrolysis temperature accelerates the aging process, so much so that in some cases the amorphous hydrated oxide cannot be isolated.

The following references deal with metal alkoxides:

Metal	Method of preparation of the alkoxide	Hydrolysis and products of hydrolysis
Al	p. 840 this handbook	[1, 3, 16, 17, 19, 21, 25]
Si	[7], see p. 702	[2, 18, 22, 32], see p. 698
Ti	[4, 7, 11, 24, 26, 27]	[5, 11, 15, 18, 20, 23, 26, 27]
Cr	[30]	[30]
Fe	[24, 28, 29]	[29]
Zr	[6-8, 24]	[6]
Nb	[14]	
Sn	[24, 31]	[31]
Ce	[13]	
Hf	[9]	
Ta	[12]	
Th	[10, 13]	

REFERENCES:

1. H. Adkins and S. H. Watkins. *J. Amer. Chem. Soc.* **73**, 2184 (1951).
2. R. Aelion, A. Loebel and F. Eirich. *Ibid.* **72**, 5705 (1950).
3. H. A. Benesi. *Ibid.* **78**, 5490 (1956).
4. F. Bischoff and H. Adkins. *Ibid.* **46**, 256 (1924).

5. T. Boyd. *J. Polym. Sci.* 7, 591 (1951).
6. D. C. Bradley and W. Wardlaw. *J. Chem. Soc. (London)* 1951, 280.
7. D. C. Bradley, R. C. Mehrotra, J. D. Swanwick and W. Wardlaw. *Ibid.* 1952, 2027, 4204, 5020; 1953, 2025.
8. D. C. Bradley, F. M. Abd-el Halim, E. A. Sadek and W. Wardlaw. *Ibid.* 1952, 2032.
9. D. C. Bradley, R. C. Mehrotra and W. Wardlaw. *Ibid.* 1953, 1634.
10. D. C. Bradley, M. A. Saad and W. Wardlaw. *Ibid.* 1954, 1091, 3488.
11. D. C. Bradley, R. Gaze and W. Wardlaw. *Ibid.* 1955, 721, 3977.
12. D. C. Bradley, W. Wardlaw and A. Whitley. *Ibid.* 1955, 726.
13. D. C. Bradley, A. K. Chatterjee and W. Wardlaw. *Ibid.* 1956, 2260, 3469.
14. D. C. Bradley, B. N. Chakravarti and W. Wardlaw. *Ibid.* 1956, 2381, 4439.
15. D. P. Dobychin and Y. N. Andreyev. *Zh. Fiz. Khimii* 28, 1465 (1954).
16. R. Fricke and H. Schmäh. *A. anorg. allg. Chem.* 255, 253 (1948).
17. R. Fricke and H. Keefer. *Z. Naturforsch.* 4a, 76 (1949).
18. R. Fricke. *Naturwiss.* 37, 428 (1950).
19. S. Geiling and R. Glocker. *Z. Elektrochem.* 49, 269 (1943).
20. O. Glemser and E. Schwarzmann. *Angew. Chem.* 68, 791 (1956).
21. S. J. Gregg and K. H. Wheatley. *J. Chem. Soc. (London)* 1955, 3804.
22. R. G. Haldeman and P. H. Emmett. *J. Amer. Chem. Soc.* 78, 2917 (1956).
23. T. Ishino and S. Minami. *Technol. Rep. Osaka Univ.* 3, 357 (1953).
24. H. Meerwein and T. Bersin. *Liebigs Ann.* 476, 113 (1929).
25. H. Schmäh. *Z. Naturforsch.* 1, 322 (1946).
26. F. Schmidt. *Angew. Chem.* 64, 536 (1952).
27. S. Teichner. *Comptes Rendus Hebd. Séances Acad. Sci.* 237, 900 (1953).
28. P. A. Thiessen. *Z. anorg. allg. Chem.* 180, 65 (1929).
29. P. A. Thiessen and O. Körner. *Ibid.* 180, 115 (1929).
30. P. A. Thiessen and B. Kandelaky. *Ibid.* 181, 285 (1929).
31. P. A. Thiessen and O. Körner. *Ibid.* 195, 83 (1931).
32. P. B. Weisz and E. W. Swegler. *J. Chem. Phys.* 23, 1567 (1955).
33. R. Willstätter, H. Kraut and O. Erbacher. *Ber. dtsh. chem. Ges.* 58, 2448 (1925).

"Glimmering" Hydrated Iron (III) Oxide

In the method of Kohlschütter et al. [3], 20 g. of $\text{FeSO}_4 \cdot 7 \text{H}_2\text{O}$ (analytical grade) is boiled for 40-60 minutes in a Kjeldahl flask

with 200 ml. of pure 70% H_2SO_4 . The water vapor is allowed to escape in order to concentrate the acid. Following the reaction the tablet-shaped crystals (which range in size up to 2 mm.) are collected on a fritted-glass filter. They are washed with some water, then several times with acetone, and are then dried in vacuum. The dry crystals are reacted (vigorous stirring) with 200 ml. of 2N aqueous ammonia (or correspondingly less of a more concentrated solution). The reaction is over in 10-15 minutes. The product is allowed to settle, the mother liquor is decanted, and the residue washed 4-5 times by decantation with water. The hydrated oxide is collected on a filter, rinsed several times with water, and dried with acetone and ether.

To obtain a preparation with a particularly impressive glimmer, the substance is predried with ether (as above) and then carefully heated at 300°C for 30 minutes.

PROPERTIES:

Contains, even after baking at high temperature, a considerable amount of water. Single, freely flowing particles retaining the external shape of sulfate crystals. Amorphous on x-ray analysis; the hydroxide framework is permeated by numerous pores. Crystallizes spontaneously and with glowing to α - Fe_2O_3 on heating to 350°C.

GENERAL:

The ability of the system to undergo a topochemical reaction depends on several prerequisites: the solid should not dissolve too rapidly (otherwise the reaction does not occur at the interface but in solution). This prerequisite is often fulfilled by sulfates of trivalent metals. If necessary, the rate of solution may be reduced by adding a sufficient quantity of an organic substance to the aqueous solution. The organic substance may be acetone, glycol, glycerol, dioxane and so forth, or in the case of hydroxide "precipitations," it may be pyridine, mono-, di- or triethanolamine, morpholine and so forth (see [6]).

The reaction product, which is formed on the surface of the reacting crystals, should not form a solid film: it must be permeable to all reagents present in solution so as to allow the completion of the reaction throughout the individual crystallites.

Instead of simple salts, one can use double salts with readily soluble components. Thus, $KAl(SO_4)_2 \cdot 12 H_2O$ yields a granular hydrated aluminum oxide with a very porous structure [6]. Basic salts may also be reacted topochemically to yield hydrated oxides.

The "glimmering" was also observed in hydrated oxides of Cr, Ti, Zr [1, 10], Sc, Nb, Ta [10] and others.

Another topochemical method for preparation of hydrated oxides consists of an extension of the procedure proposed by Raney in the case of metals. The required starting mixtures may be obtained by fusion of the components or by coprecipitation. A commercial fusion procedure yields Vycor glasses with interesting adsorptive and catalytic properties [4, 5, 9]. The fusion procedure is also used to obtain sodium ferrite-aluminate mixed crystals; these then yield hydrated iron (III) oxide skeletal structures showing considerable chemical activity (reacting with hot aqueous NaOH) provided the starting mixture contains an excess of aluminate [7]. The activity of such structures is due both to the small particle size of the product and to a strongly distorted crystal lattice due to "frozen" thermal vibrations [8].

Coprecipitation of silicic acid with hydrated oxides of metals such as Fe, Al, Cr, Ca, Cu, Ni and so forth yields silica gels that, after washing, drying and activation by leaching with hydrochloric acid, give chalky materials (provided the metal concentration in the starting mixtures is high [2]).

REFERENCES:

1. J. Böhm. *Z. anorg. allg. Chem.* 149, 217 (1925).
2. H. N. Holmes and J. A. Anderson. *Ind. Eng. Chem.* 17, 280 (1925).
3. H. W. Kohlschütter et al. *Z. anorg. allg. Chem.* 236, 165 (1938); 240, 232 (1939).
4. K. Kühne. *Z. phys. Chem.* 204, 20 (1955).
5. M. E. Nordberg. *J. Amer. Ceram. Soc.* 27, 299 (1944).
6. U. S. Pat. 2,436,509 (1945).
7. A. Simon and M. Marchand. *Z. anorg. allg. Chem.* 277, 1 (1954).
8. A. Simon and M. Lang. *Ibid.* 286, 1 (1956).
9. W. A. Weyl. *Angew. Chem.* 63, 85 (1951).
10. L. Wöhler. *Kolloid-Z.* 38, 97 (1926).

ACTIVE METAL OXIDES

The methods of preparing active metal oxides may be grouped according to similarities of procedure or of structure of the product.

PREPARATION BY TOPOCHEMICAL REACTIONS

The topochemical reactions that give activated oxides are essentially thermal decompositions of suitable compounds:

- 1) Dehydration of hydroxides [see aluminum oxide, p. 1660; α -iron (III) oxide, p. 1661].

2) Thermal decomposition of nitrates, carbonates, oxalates and so forth (see magnesium oxide, p. 1663; zinc oxide, p. 1664).

3) Dehydration of hydrated oxides in the mother liquor [see lead (IV) oxide, p. 1668].

The products prepared under mild conditions are usually (porous) pseudomorphs of the particles of the starting material (see [17]). Reproducible preparation of active oxides requires not only constant decomposition conditions, but also consistently uniform starting materials (constant conditions during precipitation and so forth). The effects of the chemical composition and the physical structure of the starting material on the properties of the final product decreases with increasing decomposition temperature. The extent of this decrease is proportional to the extent of ageing of the products during reaction conditions.

Kinetic measurements on thermal decomposition reactions yield several empirical equations. In general, these may be interpreted as follows:

1. If the order of the reaction is $1/3$, the process is diffusion-controlled.

2. If the order of the reaction is $2/3$, the process is a decomposition reaction which progresses from the outside to the center.

If the specific surfaces of the products are plotted against the decomposition temperature (at constant decomposition time), typical curves are obtained [3]. From these, one can not only read off the optimum conditions for creation of maximum surface but one can also obtain some indication of the mechanism of the decomposition reaction. Complete explanation of these phase relations (in some cases, an extremely complicated problem) requires the use of x-ray and IR spectroscopy and thermogravimetric methods.

In practice the decomposition temperature must be exactly maintained. Thus one cannot employ a shorter reaction time at higher temperature without incurring a loss of activity in the material. The effect of the atmosphere in which the reaction proceeds is especially remarkable. In some cases it was possible to reduce the activation energies for the decomposition by 10-15 kcal./mole (by comparison with those needed in air or vacuum) by proper choice of the gaseous atmosphere. In many cases, a properly chosen gaseous atmosphere allows the decomposition to proceed at unusually low temperatures; this in turn gives high active preparations [2].

PREPARATION BY CONDENSATION FROM A HOMOGENEOUS PHASE

The only oxides that can be condensed from the gas phase are those that are vaporized products of a chemical reaction occurring immediately prior to the condensation. Otherwise,

vaporization of oxides is usually impossible due to the high boiling points involved.

Colloidal suspensions of oxides in air (smokes, see p. 1669) usually are very nonuniform because of the randomness of nuclei formation [1, 6]. The individual particles are usually globular. The growth of particles from the gas phase occurs in two stages:

Primary growth, which is exceedingly rapid and produces particles 500-1000 Å in diameter. In this stage, the only material condensed is that which finds itself within the confines of a "sphere of influence" of a nucleus.

Secondary growth, which is much slower and depends mainly on the vapor pressure of the material under the temperature conditions prevailing during growth. This stage, corresponding to the aging of precipitates under mother liquors, can be suppressed by quenching of the material.

PREPARATION BY INTERFACE REACTIONS

Under some conditions, the texture of oxide growth layers is determined by epitaxy with the support. Such layers are obtained by:

- 1) Surface oxidation of metals and alloys (e.g., bluing layers by heat treatment).

- 2) Oxidation of metal layers deposited electrolytically or from a vapor on carriers other than the metal itself. Occasionally, such surface layers show oxide modifications which are not known to occur in the pure material. In some metals the colored layers formed by strong oxidation are covered with needles or leaflets of the oxide [9]. The dimensions of these depend on the duration and the temperature of the oxidation. The rough surface thus produced may sometimes offer twice the normal specific surface [11].

Because these processes are related to catalysis, they have recently been studied by many investigators. This is especially true of the initiation reaction and the process kinetics [5, 7].

In view of the enormous complexity of the subject, the methods for the preparation of **mixed** and **carrier-supported** oxide catalysts can only be summarized here. They include:

1. Mechanical mixing (dry, in an atmosphere laden with moisture, under special gases, in suspension, and so forth [10]).

2. Coprecipitation, especially when solids of definite composition are desired; it is also applicable to the more rarely used solid solutions.

3. Precipitation of one component onto a carrier which is itself suspended in solution.

4. Adsorption of ions of one component from a solution and so forth [8].

The interaction of the components of a mixed catalyst (promotion of catalytic activity), which in general requires thermal activation for development of the full effect, is a very complex process; occasionally, it yields very active and very specific catalysts.

The two special effects accompanying such an interaction are:

1. Alteration of the **semiconductor properties** of an oxide by inclusion of other oxides with different valences in the crystal lattice [5, 16]; this may also alter the activation energy of a catalytic process [14].

2. **Adaptation of valence.** The metal in the precipitated oxides of some transition metals adapts to the valence of the metal in the oxide carrier. Thus, transition metals preferably deposit on MgO in divalent forms while on γ -Al₂O₃ they are trivalent and on TiO₂ (rutile) tetravalent [15]. This is because the oxide precipitate attempts to continue the crystal lattice of the carrier.

Various methods are available for **shaping** the oxide catalysts [4]. The following methods are used in laboratories:

The material, which may be moist if required, is pressed into a sheet. After drying, it is broken up and sieved. However, the high pressure applied during sheet forming produces a large decrease in the average pore size. This may lead to a considerable reduction of the catalytic activity of such preparation, especially at large reagent throughputs (the diffusion, which controls the overall process rate, becomes hindered by the small pore size [12]).

In the second method the dry powder is made into a paste with 80% ethanol. The paste is then rolled (without applying any high pressure) into a thin sheet, which is then forced through a polished copper or nickel screen of suitable mesh size (1-2 mm.). After drying, the granulated material may be scraped off from the reverse side of the screen. If the dilute ethanol does not yield stable granules, the paste may be made with a saturated aqueous solution of the corresponding metal nitrate. In this case, the granules are shaped as above, dried and baked at 200-220°C until nitrous fumes cease to evolve [13].

REFERENCES:

1. D. Beischer. Z. Elektrochem. 44, 375 (1938).
2. F. Bischoff, Radex-Rundschau 1950, 141.
3. S. J. Gregg. J. Chem. Soc. (London) 1953, 3940.
4. R. A. Griffith in: Handbuch der Katalyse [Catalysis Handbook], Vol. IV, Vienna, 1943.
5. K. Hauße. Reaktionen in und an festen Stoffen [Reactions in and on Solids], Berlin, 1955.
6. R. Meldau and M. Teichmüller. Z. Elektrochem. 47, 95, 191, 630, 634 (1941).

7. W. J. Moore. *J. Electrochem. Soc.* 100, 302 (1953).
8. G. Natta and R. Rigamonti. *Handbuch der Katalyse [Catalysis Handbook]*, Vol. V, Vienna, 1957.
9. G. Pfefferkorn. *Naturwiss.* 40, 551 (1953); *Z. Metallkunde* 46, 204 (1955).
10. O. Reitlinger. *Chem.-Ing.-Technik* 24, 1 (1952).
11. T. N. Rhodin. *J. Amer. Chem. Soc.* 72, 4343 (1950).
12. G. Rienäcker and G. Horn. *Z. Elektrochem.* 60, 828 (1956).
13. G. M. Schwab et al. *Z. phys. Chem.* [B] 9, 265 (1930); [A] 185, 405 (1939).
14. G. M. Schwab and J. Block. *Z. Elektrochem.* 58, 756 (1954).
15. P. W. Selwood. *J. Amer. Chem. Soc.* 70, 883 (1948); *Bull. Soc. Chim. France* [5] 1949, 167.
16. F. Stöckmann. *Naturwiss.* 38, 151 (1951).
17. E. Cremer and L. Bachmann. *Z. Elektrochem.* 59, 407 (1955).

Aluminum Oxide

Depending on the conditions, certain aluminum hydroxides yield active γ -oxides on thermal decomposition. These possess interesting adsorptive and catalytic properties.

I. ADSORBING AGENT

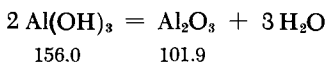

An aluminum oxide which is especially suitable for use as an adsorbing agent is obtained by heating aluminum hydroxide gel (see p. 1652) or hydrargillite (see p. 820; for preparation of an almost completely alkali-free material, see [18]) for several hours at 250-300°C. The heating proceeds in vacuum or in a stream of dry gas, and is continued until the concentration of the water has bound in the crystals decreases to 6-8 wt. %.

PROPERTIES:

Fine, white powder which flows like sand; specific surface: 250-300 m.²/g. [26]. The powder pattern shown böhmite lines, although the water content differs significantly from that of böhmite (15.02%). The thermodynamic potential, amounting to several kcal./mole, is due to the large surface and the defect lattice [27].

II. CATALYSTS

Aluminum oxide catalysts are prepared by heating hydrargillite at 550-650°C (other aluminum oxides give less active preparations); the content of water of crystallization is 1% or slightly less.

PROPERTIES:

Hygroscopic powder, very similar in appearance to the above-described adsorption agent. The particles show a honeycomb-like secondary structure; the preparations show very uniform powder patterns (according to Glemser [17], they consist of ϵ -phase). Any water adsorbed during use is incorporated in the form of OH groups and thus causes rehydration [18].

 α -Iron (III) Oxide**For chromatographic adsorption**

In the method of Glemser and Rieck [19] a solution of 1000 g. of $\text{Fe}(\text{NO}_3)_3 \cdot 9 \text{H}_2\text{O}$ (A.R. or pure) in 2.4 liters of water is added with constant stirring to 2.4 liters of 6% aqueous ammonia. The precipitate is centrifuged off and washed with water until the wash liquor is free of nitrates. It is then dried at 50°C. After two days at this temperature it is broken up and freed of dust on a U.S. 400 standard screen. Long heating (10-16 hours) of this crude product at high temperatures gives preparations with other activities. The maximum activity is usually reached by heating at 180-220°C for 10 hours.

GENERAL:

The rate of dehydration of hydroxides and hydrated oxides may be varied within limits by choice of suitable experimental conditions. Aside from the obvious effect of temperature, the following dehydration procedures are open to the experimenter and give better products than does simple heating in open dishes or crucibles:

1. Removal of the water by means of a dry stream of air or other gas. The dehydrating action of the various gases is quite specific; hydrogen is an especially efficient dehydrating gas [25].

2. Reduction of the vapor pressure of water in the atmosphere surrounding the solid by operating under vacuum or using drying agents. If a drying agent is used, the material may be placed in a drying pistol instead of a desiccator. In this case, the sample may be heated to a high temperature while cooling the drying agent. This produces a large water vapor pressure gradient. It should be remembered that the pressure of water in equilibrium with active oxides is much lower than that encountered in equilibrium with inactive materials. In many cases it is impossible to obtain completely dry oxides without reducing the activity to a level considerably below the maximum.

One remarkable phenomenon, which has been proved over and over again, is the fact that dehydrations of the above type do not alter the shape and size of secondary particles, while the size of the primary particles is subject to sharp variations [29].

Dehydration in hydroxides and hydrated oxides is often quite sensitive to impurities [1]. To obtain reproducible results, one should always use starting materials of the same purity.

Literature references for the preparation of active metal oxides by dehydration of hydroxides:

Oxide	Starting material	References
BeO	α -Be(OH) ₂ (see p. 894)	[9]
MgO	Mg(OH) ₂ (see p. 912)	[10, 23]
γ -Al ₂ O ₃	Al(OH) ₃ , amorphous (see p. 1652)	[24, 26]
	Al(OH) ₃ , hydrargillite (see p. 820)	[2, 18, 20, 26, 27]
	Al(OH) ₃ , bayerite (see p. 821)	[4, 18, 20, 27]
	AlOOH, böhmite (see p. 821)	[12, 13, 18, 26, 27, 29]
TiO ₂	Hydrated titanium (IV) oxide	[21]
Cr ₂ O ₃	Hydrated chromium (III) oxide, amorphous (see p. 1648)	[3, 25]
α -Fe ₂ O ₃	Hydrated iron (III) oxide, amorphous	[6, 8, 14, 19, 22]
	α -FeOOH (see p. 1499)	[6]
γ -Fe ₂ O ₃	γ -FeOOH (see p. 1500)	[15, 16]
NiO	Ni(OH) ₂ (see p. 1549)	[28]
ZnO	ϵ -Zn(OH) ₂ (see p. 1074)	[5]
	Other crystalline hydroxides	[11]
CdO	Cd(OH) ₂ (see p. 1097)	[7]

REFERENCES:

1. S. C. Chakraborty and A. Roy. *J. Chem. Phys.* **25**, 1079 (1956).
2. R. P. Eischens and P. W. Selwood. *J. Amer. Chem. Soc.* **69**, 1590 (1947).
3. H. Harbard and A. King. *J. Chem. Soc. (London)* **1940**, 19.
4. R. Fricke and W. Steiner. *Z. Naturforsch.* **1**, 649 (1946).
5. R. Fricke and P. Ackermann. *Z. anorg. allg. Chem.* **214**, 177 (1933).
6. —. *Z. Elektrochem.* **40**, 630 (1934).

7. R. Fricke and F. Blaschke. *Ibid.* 46, 46 (1940).
8. R. Fricke and L. Klenk. *Ibid.* 41, 617 (1935).
9. R. Fricke and J. Lüke. *Z. Phys. Chem.* [B] 23, 219 (1933).
10. —. *Z. Elektrochem.* 41, 174 (1935).
11. R. Fricke and K. Meyring. *Z. anorg. allg. Chem.* 230, 366 (1937).
12. R. Fricke, F. Niermann and C. Feichtner. *Ber. dtsh. chem. Ges.* 70, 2318 (1937).
13. R. Fricke and G. Wessing. *Z. Elektrochem.* 49, 274 (1943).
14. R. Fricke and H. Wiedmann. *Kolloid-Z.* 89, 178 (1939).
15. R. Fricke and W. Zerrweck. *Z. Elektrochem.* 43, 52 (1937).
16. O. Glemser. *Ber. dtsh. chem. Ges.* 71, 158 (1938).
17. O. Glemser and G. Rieck. *Angew. Chem.* 67, 652 (1955).
18. —. Report at the Third International Conference on the Reactivity of Solids, Madrid, April 1956, p. 361.
19. —. *Angew. Chem.* 69, 91 (1957).
20. —. *Naturwiss.* 44, 180 (1957).
21. O. Glemser and E. Schwarzmann. *Angew. Chem.* 68, 791 (1956).
22. S. J. Gregg and K. J. Hill. *J. Chem. Soc. (London)* 1953, 3945.
23. S. J. Gregg and R. K. Packer. *Ibid.* 1955, 51.
24. S. J. Gregg and K. H. Wheatley. *Ibid.* 1955, 3804.
25. G. F. Hüttig and H. Dreithaler. *J. A. Hedvall-Festschrift, Göteborg, 1948*, p. 285.
26. M. Prettre et al. *Angew. Chem.* 65, 549 (1953).
27. H. C. Stumpf et al. *Ind. Eng. Chem.* 42, 1398 (1950).
28. S. J. Teichner and J. A. Morrison. *Trans. Faraday Soc.* 51, 961 (1955).
29. G. Weitbrecht and R. Fricke. *Z. anorg. allg. Chem.* 253, 9 (1945).

Magnesium Oxide

Active MgO is prepared by calcination of the basic carbonate (for preparation, see p. 911). The following particle sizes have been observed, depending on the temperature and the duration of the calcination, [12]:

Temp., °C	Heating time, hr.	Particle size in Å	
		Determined by x-ray analysis	Observed by ultra-microscope
370	60	30	100
725	1-4	46	100
820	1-4	50	100
920	1-4	300	200- 300
980	1-4	300	300- 500
1200	4	300	1000-3000

Since commercial basic magnesium carbonates are not well-defined compounds, the properties of the oxides vary to some extent. To obtain preparations with reproducible properties it is better start with well-defined compounds such as fine crystalline $\text{Mg}(\text{OH})_2$ (for preparation, see p. 912) or with $\text{MgCO}_3 \cdot 3 \text{H}_2\text{O}$ [3, 22].

Zinc Oxide

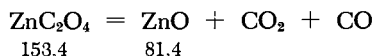
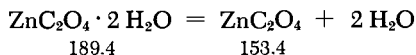

A solution of 27.3 g. of anhydrous ZnCl_2 is in 200 ml. of water and 2.5 ml. of 2N HCl is prepared. Another solution, containing 31.3 g. of $(\text{NH}_4)_2\text{C}_2\text{O}_4 \cdot \text{H}_2\text{O}$ in 2.0 ml. of water and 2.5 ml. of 2N aqueous NH_3 solution, is prepared separately. Both solutions are heated to 70°C, and the oxalate solution is then poured in a thin stream into the vigorously stirred zinc salt solution. The oxalate precipitate is washed by decantation with water until it is free of chlorides. It is then placed on a filter and dried by suction. The $\text{ZnC}_2\text{O}_4 \cdot 2 \text{H}_2\text{O}$ is then transferred to a flat pan which is placed in a drying oven. The temperature is then raised to 240°C over a period of 6 hours and is then maintained at this level for an additional 12 hours. This treatment removes nearly all of the water of crystallization. The anhydrous oxalate is then converted to ZnO by heating at 400°C for 4 hours.

PROPERTIES:

Fine, white powder; untamped bulk density (pouring into a cylinder) 0.85 g./ml. The primary particles, whose lattice still contains defects, are larger than 500 Å [18].

GENERAL:

Oxides of metals exhibiting low basicity may be obtained by thermal decomposition of their salts with volatile or readily decomposed acids. Such salts include nitrates, carbonates, formates and oxalates. In order to obtain active preparations, the decomposition conditions should be as mild as possible. The decomposition proceeds faster in vacuum than in air, so that the reaction temperature may be lower (for the same yield per unit time). An even stronger influence on the reaction rate is sometimes exerted by an appropriate gaseous atmosphere (see below).

NITRATES

Hydrates of most heavy metal nitrates have low melting points. Thus, on heating, they liquefy, decompose and leave sintered or foamed oxides of low surface area. The product may sometimes be improved by starting with lower hydrates or basic nitrates. Nitrate decomposition is important primarily in the production of carrier substances.

In compounds possessing several oxidation stages (e.g., elements of the manganese series), nitrate decomposition always yields the highest oxide possible at the given reaction temperature.

CARBONATES

Vacuum decomposition of carbonates is often used to obtain metal oxides where the metal is at the oxidation stage corresponding to that in the starting carbonate. However, with air present, at least partial oxidation is possible, sometimes even after the material has been cooled to room temperature. In addition to carbonates and their hydrates, as well as basic carbonates, this method is suitable for the decomposition of double carbonates where ammonium is one of the cations [for example, $\text{MgCO}_3 \cdot (\text{NH}_4)_2\text{CO}_3 \cdot 4 \text{H}_2\text{O}$]. When the conditions are mild, very fine oxide powders are frequently obtained.

The decomposition of magnesite has been studied very thoroughly and proves to follow $2/3$ order kinetics (see p. 1657 and [17, 21]). The effect of a gaseous atmosphere on the kinetics of this reaction consists mainly in the change in the activation energy for decomposition which it causes [8, 9].

Atmosphere	Dry air	Vacuum	H_2	Moist air	H_2O
Activation energy in kcal./mole	42.15	36.13	27.89	27.22	26.79

The preparative decomposition of magnesite may be carried out even at 500°C when a suitable atmosphere, e.g., air containing H_2O and NH_3 at a total partial pressure of 40 mm., is provided [19]. The gaseous atmosphere over the preparation also affects the particle size of the nascent solid phase. Thus, given identical decomposition temperatures, the particle size of MgO crystals formed from magnesite will decrease with decrease of the CO_2 pressure during the decomposition [10].

FORMATES AND OXALATES

The nature of the thermal decomposition of formates and oxalates is not uniformly the same. Depending on the basicity of

the metal and the degree to which it approaches the noble metals, one may obtain carbonates, oxides or the metals themselves, provided secondary oxidation reactions are prevented (the production of metals is due to reduction by the organic anions or their decomposition products). According to presently available data, formates and oxalates behave in this respect in practically identical fashion. As far as is known, the composition of products obtained on vacuum decomposition is identical to that of the primary products of decomposition in air. The following data are available on some of the divalent metals:

Formate or oxalate of	Decomposition products in vacuum and primary products of decomposition in air	Terminal products of decomposition in air
Mg*	MgO	MgO
Mn	MnO	Higher oxides
Fe	FeO	α - and γ -Fe ₂ O ₃
Co	Co	Higher oxides
Ni	Ni	NiO _{1+x}
Cu	Cu	CuO
Zn	ZnO	ZnO

*At the mild decomposition temperatures assumed in this table, the salts of the heavier alkaline earths always produce carbonates.

Under certain decomposition conditions, Cd and Pb (II) oxalates give a mixture of oxide and metal [6, 11, 15]. In contrast to the corresponding formates, the oxalates of the metals mentioned here are rather insoluble in water; in general, they are readily obtained by precipitation, which usually gives a fine powder well suited as a starting material for decomposition. Provided the solvent is cautiously removed, hydrated or solvated compounds also yield suitable starting materials, and decomposition of these gives products with high activities.

Ultramicroscopic and x-ray studies show that oxides obtained from carbonates and oxalates at low decomposition temperatures are pseudomorphous with the crystals of the starting material [10, 12]. Since the molar volume of the new substance is as a rule considerably smaller than that of the starting material, the particles of the product are usually very porous, that is, provided the reduced decomposition temperature $T/T_m < 1/3$ (compare p. 1611). If the decomposition temperature is higher, aggregate crystallization can be expected to an increasing degree [19], except when the starting substance (which must in this case be a uniform fine powder) is heated for such a short time that only the desired

reaction occurs and no time is left for the material to undergo aggregation [20]. Fast cooling from the decomposition temperature may help in this case.

The following are literature references for the preparation of active oxides by thermal decomposition of suitable compounds:

Preparation	Formation from			
	Nitrate	Carbonate	Formate	Oxalate
BeO		See p. 893		
MgO		[3, 7, 22]	[25]	[16, 23]
Mn oxides	[9]; see p. 1458	See p. 1456	[25]	[23]; see p. 1456
Fe oxides			[5]	[5, 23]; see p. 1497
Co oxides		See p. 1519	[25]	[23]
Ni oxides	[14, 26]; see p. 1548	[14, 24]; see p. 1548	[25]	[1, 23]
CuO	[24]; see p. 1012		[25]	
ZnO	[18]	[18, 27]	[25]	[18, 23]
CdO			[25]	[11, 15]
ThO ₂	See p. 1221			[2, 13]; see p. 1221

REFERENCES:

1. J. A. Allen and D. E. Scaife. *J. Phys. Chem.* **58**, 667 (1954).
2. V. D. Allred et al. *Ibid.* **61**, 117 (1957).
3. J. d'Ans and G. Gloss. "Potassium and Related Salts," *Erdöl* **32**, 155 (1938).
4. L. Bachmann and E. Cremer. *Z. Elektrochem.* **60**, 831 (1956).
5. E. F. Bertaut. *Bull. Soc. Franc. Minéralog. Cristallogr.* **76**, 1 (1953).
6. L. L. Bircumshaw and I. Harris. *J. Chem. Soc. (London)* **1939**, 1637; **1948**, 1898.
7. L. S. Birks and H. Friedman. *J. Appl. Phys.* **17**, 687 (1946).
8. F. Bischoff. *Radex-Rundschau* **1950**, 141.
9. J. Brenet and N. Busquere. *Comptes Rendus Hebd. Séances Acad. Sci.* **230**, 1767 (1950).
10. E. Cremer and L. Bachmann. *Z. Elektrochem.* **59**, 407 (1975).
11. G. Denk and W. Dewald. *Z. anorg. Chem.* **257**, 145 (1948).
12. W. R. Eubank. *J. Amer. Ceram. Soc.* **34**, 225 (1951).
13. R. W. M. d'Eye and P. G. Sellman. *J. Inorg. Nuclear Chem.* **1**, 143 (1955).

14. J. Francois. Comptes Rendus Séances Acad. Sci. 230, 1282 (1950).
15. P. Hagenmüller. Ibid. 234, 1168 (1952).
16. H. Hartmann and H. Narten. Z. anorg. allg. Chem. 267, 37 (1951).
17. G. F. Hüttig et al. Z. phys. Chem. [B] 19, 1, 420 (1932).
18. G. F. Hüttig. Kolloid-Beih. 39, 277 (1934).
19. —. Kolloid-Z. 124, 160 (1951).
20. I. G. Farbenindustrie A.G. Dutch Pat. 53,576 (1939).
21. J. Y. McDonald. Trans. Faraday Soc. 47, 860 (1951).
22. H. Menzel and A. Brückner. Z. Elektrochem. 36, 63, 188 (1930).
23. J. Robin. Bull. Soc. Chim. France, Mém. [5] 20, 1078 (1953).
24. G. D. L. Schreiner and C. Kemball. Trans. Faraday Soc. 49, 190 (1953).
25. V. Zapletal et al. Chem. Listy 50, 1406 (1956).
26. G. Parravano. J. Amer. Chem. Soc. 75, 1448 (1953).
27. A. B. Shekhter. Dokl. Akad. Nauk SSSR 72, 339 (1950); Izv. Akad. Nauk SSSR, Otd. Khim. Nauk 1951, 388.

Lead (IV) Oxide

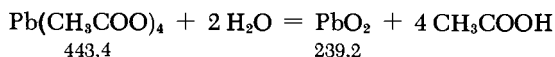

The instructions given on p. 767 are used to prepare 50 g. of $\text{Pb}(\text{CH}_3\text{COO})_4$. The material is then crushed and trituated with 460 ml. of water in centrifuge tubes until all tetraacetate is converted to brown PbO_2 . The fine suspension is then centrifuged. The deposit is stirred four times with water (500 ml. each time); the suspension is centrifuged each time before decanting the liquid. The last wash water should not be acid. The PbO_2 is then suspended in 50 ml. of water, filtered with suction, and washed on the filter with 50 ml. of water. Then the material is washed on the funnel with four 25-ml. portions of acetone to displace the water. The acetone is then displaced by washing with four 25-ml. portions of ether. This imparts the final color to the material. The product is immediately placed in a vacuum desiccator [5].

PROPERTIES:

Very fine, dense powder with a light brown, coffeelike color; reacts with dil. HCl to give chlorine. Its physical state, characterized by small particle size, lattice defects and occlusions of admixtures which prove to be amorphous and on x-ray analysis are recognizable under an ultramicroscope [6], causes an extraordinary high chemical activity. Especially useful in dehydrogenation of aromatic dihydroxy compounds to the corresponding

quinones. Pure preparations age with release of O_2 , losing their activity (5% in 15 hours, 8-11% in 7 days).

GENERAL:

Spontaneous dehydration of hydroxides is occasionally also observed in precipitations with alkali hydroxide solutions. The method is especially useful in preparation of CuO [2, 7], ZnO [3] and Ag_2O [4]. The products thus obtained are usually fine powders and quite frequently contain occluded admixtures which prove amorphous on x-ray analysis. The rate of dehydration depends on the particle size of the precipitated hydroxide and on the possible formation of intermediate basic salts. The latter may inhibit the dehydration to a considerable extent. An especially useful starting material for preparation of CuO is $Cu(NO_3)_2$ [1].

REFERENCES:

1. W. Feitknecht, K. Maget and A. Tobler. *Chimia* **2**, 122 (1948).
2. R. Fricke, E. Gwinner and C. Feichtner. *Ber. dtsch. chem. Ges.* **71**, 1744 (1938).
3. R. Fricke and K. Meyring. *Z. anorg. allg. Chem.* **230**, 366 (1937).
4. E. Høst Madsen. *Z. anorg. Chem.* **79**, 195 (1913).
5. R. Kuhn and I. Hammer. *Chem. Ber.* **83**, 413 (1950).
6. R. Kuhn. Private communication.
7. C. Ott. *Comptes Rendus Hebd. Séances Acad. Sci.* **236**, 2224 (1953).

Colloidal Suspensions of Oxides in Gases (Smokes)

Oxides of especially small particle size (smokes) may be obtained under appropriate reaction conditions. Such reactions are nearly always described in conjunction with special investigations where only very small amounts of compound are necessary. Only occasional literature references to work on a preparative scale are available. However, these may be supplemented by data and descriptions from the patent literature, since oxide smokes are prepared on an industrial scale. The following methods are the most useful for generation of oxide smokes:

1) **Burning of the metal** (e.g., Mg , Zn , Cd and so forth); however, this procedure frequently converts only part of the oxide to the desired colloidal (smoke) dispersion.

2) **Oxidation of a metal volatilized in an electric arc**. This simple method is frequently used to demonstrate the present phenomenon. The procedure consists of striking an arc between

two electrodes made of the desired metal. However, it is only rarely useful for preparative purposes, since the quantity of product is very small due to the high thermal conductivity of the electrodes and the frequent shifts in the arc focus.

A much higher efficiency is reached in the apparatus developed by V. Kohlschütter [5] (see Fig. 340), comprising an arc furnace with vertical electrodes. The bottom electrode has an indentation for the metal to be volatilized. The arc is struck between the metal and the top (movable) electrode. Usually the vaporization proceeds very smoothly if the metal is the anode. The optimum conditions for the operation of the arc and for removal of the vapors from the electrodes vary somewhat from metal to metal.

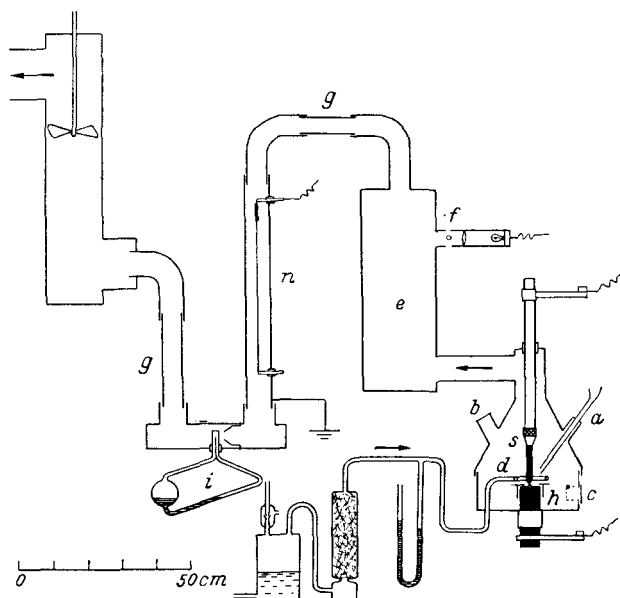
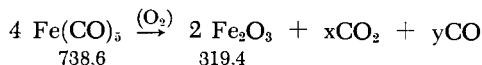

Fig. 340. Preparation of active metal oxides by oxidation of metal vapor. *a* funnel for addition of metal; *b* observation port; *c* side port; *d* circular nozzle for air intake; *e* first chamber with lateral observation ports (these are not shown); *f* illuminating device; *g* glass tubes (the remaining parts of the apparatus are made from sheet iron); *h* carbon electrodes; *i* flow meter activated by differential pressure; *n* precipitation cell; *s* movable carbon electrode.

3) Thermal or photochemical decomposition of volatilized metal compounds in the presence of oxygen. Metal compounds that

are usable in such reactions are carbonyls and certain metal hydrides or organometallic compounds, for example, alkylated metals. To avoid explosions, the reaction must be carried out at very low pressures or the partial pressure of the reagents must be reduced by appropriate dilution with an inert gas. The reactions may be carried out either in closed systems [4, 10] or in a gas stream [11]. The continuous apparatus is shown in Fig. 338.

The decomposition of $\text{Fe}(\text{CO})_5$ has been investigated very thoroughly. It was found that it oxidizes according to the following equation:



Low O_2 concentrations in the starting mixture, high temperatures and short reaction times give thoroughly crystalline $\gamma\text{-Fe}_2\text{O}_3$; this material gives sharp powder patterns. Lower decomposition temperatures and higher oxygen partial pressures produce smaller smoke particles; however, the particles show powder patterns which are less distinct [11]. Similar investigations have also been carried out on the decomposition of $\text{Pb}(\text{CH}_3)_4$ [6].

4) **Decomposition of halide vapors.** Readily vaporized halides, especially the chlorides of elements such as Al, Si, Ti, Zr, Sn and so forth, may also be converted to oxides in the gas phase. This may be done in either of the following ways:

a) Saturation of a stream of an inert gas with the chloride, followed by reaction with steam. External heating is required in this case.

b) Combustion of the chloride together with hydrogen or with a combustible gas which contains bound hydrogen, e.g.:

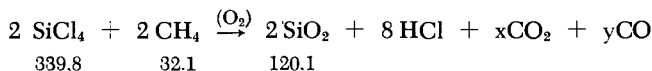

The second gas may be preheated or the combustion mixture may be diluted with an inert gas (to avoid excessive temperatures), depending on circumstances.

Under suitable reaction conditions this procedure yields extremely fine oxide powders which are used industrially as active, white fillers [2, 7].

Some difficulties in the preparation of oxide smokes arise in the separation and collection of the smoke particles. The apparatus of Kohlschütter solves the problem partially by using a dust collector and a Cottrell precipitator. However, losses are still heavy due to elutriation of the smallest particles.

The following are literature references for the preparation of oxide smokes from metals or carbonyls:

Oxide	MgO	Al ₂ O ₃	Cr ₂ O ₃	Fe ₂ O ₃	NiO	CuO	ZnO	CdO	SnO ₂	PbO	Bi ₂ O ₃
from metal	[1]	[5]	[5]	[1, 9]	[1, 5]	[5]	[1, 5]	[1, 3, 5]	[5]	[5]	[5]
from carbonyl				[1, 4, 8, 10, 11]							

REFERENCES:

1. D. Beischer. *Z. Elektrochem.* **44**, 375 (1938).
2. E. Cernia and G. Cevidalli. *Chim. e Ind.* **33**, 353 (1951).
3. F. H. Healey, J. M. Fetsko and A. C. Zettlemyer. *J. Phys. Chem.* **57**, 186 (1953).
4. G. Jander and A. Winkel. *Kolloid-Z.* **63**, 5 (1933).
5. V. Kohlschütter and J. L. Tüscher. *Z. Elektrochem.* **27**, 225 (1921).
6. P. Nagel, G. Jander and G. Scholz. *Kolloid-Z.* **107**, 194 (1944).
7. Report of F. Endter, A. Weihe and K. Dithmar in: "Aus Forschung und Produktion," *Techn. Berichte der Degussa*, p. 274 f., Frankfurt, 1953.
8. E. O. Schweckendieck. *Z. Naturforschg.* **5a**, 397 (1950).
9. A. Simon and R. Schrader. *Chem. Techn., Sonderheft 1952*, 18.
10. K. E. Stumpf. *Z. anorg. allg. Chem.* **270**, 114 (1952).
11. A. Winkel and R. Haul. *Z. Elektrochem.* **44**, 823 (1938).

Copper-Chromium Oxide

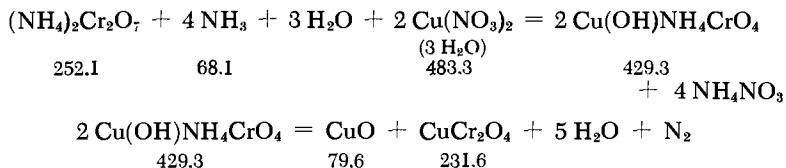

A solution of 126 g. of $(\text{NH}_4)_2\text{Cr}_2\text{O}_7$ A.R. in 600 ml. of water is prepared, and 150 ml. of 28% aqueous ammonia is added to it. This solution is poured in a thin stream into a warm (50–60°C) solution of 242 g. of $\text{Cu}(\text{NO}_3)_2 \cdot 3 \text{H}_2\text{O}$ in 800 ml. of water while stirring manually. The reddish-brown precipitate of $\text{Cu}(\text{OH})\text{NH}_4\text{CrO}_4$ [3] is stirred for an additional few minutes and then filtered on a Büchner funnel. The moisture is pressed out and the filter cake dried in an oven at 110°C. The mass is then broken up into coarse pieces and heated in a covered nickel or porcelain dish in a muffle

furnace (350-450°C, one hour). The product ($\text{CuO} + \text{CuCr}_2\text{O}_4$) [10, 11] is ground in a mortar and suspended three times in 10% acetic acid (1.2 liters each time); the product is settled and the liquid decanted after each washing. This removes the CuO . The residue is washed four times with water in the same manner, filtered with suction, dried at 110°C and ground. After the last washing the precipitate sometimes settles only with difficulty due to partial peptization [8].

After this treatment, the catalyst may still contain an excess of CuO ; the latter may convert during use to Cu_2O [9], which decreases the catalytic activity. The deactivation of the catalyst is much less likely if 24 g. of the $\text{Cu}(\text{NO}_3)_2 \cdot 3 \text{H}_2\text{O}$ in the initial charge is replaced by 26 g. of $\text{Ba}(\text{NO}_3)_2$. The Ba appears in the product catalyst as BaCrO_4 [11]. Equivalent quantities of Mg, Ca, Mn (II) or Zn nitrates may be used instead of the $\text{Ba}(\text{NO}_3)_2$.

PROPERTIES:

Fine black powder; completely stable in atmospheric oxygen and moisture. Active catalyst for the hydrogenation of organic hetero compounds containing multiple bonds [1, 5].

GENERAL:

Even the simple ammonium chromates can undergo thermal decomposition [4, 6, 7, 12] which yields very active Cr (III) oxides on decomposition in the air. Partial formation of higher chromium oxides is observed at reduced pressures [6]. Since these decomposition reactions release a considerable quantity of heat, they must be carried out in thin layers (flat dishes); the mildest conditions are obtained if only one spot in the dish is heated at a time and that spot is pushed onto a cold surface as soon as the material starts to react. The thermal decomposition of NH_4MnO_4 in air leads to explosions; vacuum decomposition yields, apart from NH_4NO_3 , manganese oxides [Mn (III)-Mn (IV)], which are pseudomorphous to the starting crystals [2].

The above method is also useful for the production of other mixed oxides where chromium oxide is a constituent, e.g., Mn-Cr oxide, Zn-Cr oxide [13].

REFERENCES:

1. H. Adkins. Organic Reactions 8, 1 (1954).
2. L. L. Bircumshaw and F. M. Tayler. J. Chem. Soc. (London) 1950, 3674.
3. G. Calingaert and G. Edgar. Ind. Eng. Chem. 26, 878 (1934).
4. K. Fischbeck and H. Spingler. Z. anorg. allg. Chem. 235, 183 (1938); 241, 209 (1939).

5. C. Grundmann. *Angew. Chem.* **54**, 469 (1941).
6. E. Harbard and A. King. *J. Chem. Soc. (London)* **1938**, 955; **1939**, 55; **1940**, 19.
7. W. Lazier and J. V. Vaughen. *J. Amer. Chem. Soc.* **54**, 3080 (1932).
8. W. Lazier and H. Arnold. *Organic Syntheses* **19**, 31 (1939).
9. I. Rabes and R. Schenk. *Z. Elektrochem.* **52**, 37 (1948).
10. P. W. Selwood et al. *J. Amer. Chem. Soc.* **68**, 2055 (1946).
11. J. D. Stroupe. *Ibid.* **71**, 569 (1949).
12. D. Taylor. *J. Chem. Soc. (London)* **1955**, 1033.
13. H. S. Taylor and S. Ch. Liang. *J. Amer. Chem. Soc.* **69**, 2989 (1947).

Hopkalite (Hopcalite)

HOPKALITE I

Hopkalite I is a mixture of 50% MnO, 30% CuO, 15% Co₂O₃ and 5% Ag₂O [9]. Its constituents are prepared as follows:

a) Manganese dioxide [2, 5]

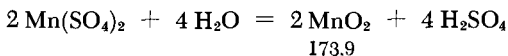
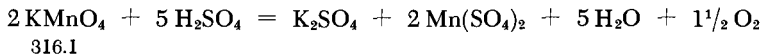

Cold 75% sulfuric acid (650 g.) is poured over 100 g. of fine KMnO₄ powder; the mixture is left standing for several days. During this time, the initially separating HMnO₄ decomposes with evolution of oxygen, leaving a dark yellow Mn(IV) solution. This is added to a large excess of water; a very fine powder of hydrated MnO₂ separates out. This powder is washed several times by decantation with water. The washing is continued on a funnel until the filtrate is free of sulfate.

Alternate method: Reduction of permanganate by Mn(II) salts [1, 4, 13].

b) Copper oxide [9] (see also [6]):

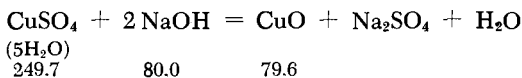

A solution of 103.5 g. of CuSO₄ · 5 H₂O in 300 ml. of water is poured with efficient stirring into 430 ml. of 2N NaOH preheated to about 80°C. The mixture is stirred for a few minutes; during

this time, 2N H_2SO_4 is added until the solution, which contains the CuO in suspension, becomes neutral (about 15 ml. of the acid is required). The mixture is allowed to settle and washed in the same way as the MnO_2 (see above).

c) Cobalt (III) oxide [8]

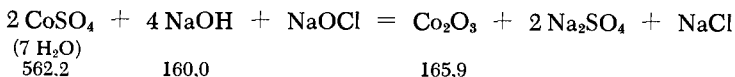

A solution of 56.2 g. of $\text{CoSO}_4 \cdot 7 \text{H}_2\text{O}$ in 200 ml. of water is mixed at room temperature with a slight excess of strongly alkaline hypochlorite solution. As soon as gas evolution comes to a virtual stop, the solution is decanted from the immediately appearing dense black precipitate, which catalyzes the decomposition of excess hypochlorite. The washing procedure is the same as for MnO_2 .

The oxides prepared as in (a), (b) and (c) are suspended in about 1.5 liters of water. This suspension is then mixed with a solution of 8.07 g. of AgNO_3 in the minimum amount of water, and the Ag_2O is precipitated by addition of 23.8 ml. of 2N NaOH (intensive stirring). Further treatment is given under Hopkalite II.

HOPKALITE II

Hopkalite II consists of 60% MnO_2 and 40% CuO (the MnO_2 : CuO molar ratio is 1.375). The catalyst may be prepared by mixing the separately prepared components [10] or by mixed precipitation ([13]; see also [11]).

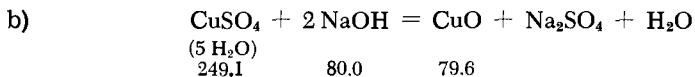
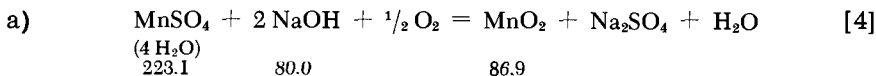

The reactor is a three-liter Erlenmeyer flask, in which 155 g. of $\text{MnSO}_4 \cdot 4 \text{H}_2\text{O}$ and 125 g. of $\text{CuSO}_4 \cdot 5 \text{H}_2\text{O}$ are dissolved in 1.5 liters of hot (70–80°C) water. A fast stream of air is then bubbled through the hot solution and 400 ml. of 25% NaOH is added (vigorous shaking) from a dropping funnel. The passage of air is continued for another 10 minutes. The precipitate is then washed several times by decantation with hot water. Then washing is continued on a filter until the wash liquor is neutral. The precipitate is suction-dried (the water should be removed as completely as possible by repeated pressing). After the by-product fine powder

has been sieved out, the product is granulated by heating for 3 hours at 200°C.

PROPERTIES:

Brownish-black granules, which must be stored under anhydrous conditions. Catalyzes the combustion of CO at room temperature; used in gas-mask cartridges.

GENERAL:

The methods of preparation described above consist of precipitation immediately followed by a reaction of the precipitated product (dehydration, oxidation). The oxidation is a topochemical reaction yielding products with defect structures. The full activity of such a multiple-compound catalyst can frequently be developed only after an aging process called forming. To strengthen the structure of the catalyst granules (which at the same time increases the accessibility of their internal surfaces to gases), rather large amounts (up to 50% and more) of kieselgur may be added to the catalyst (as, for instance, in the Fischer-Tropsch catalysts).

Some other oxidation catalysts based on metal oxides have been described in the literature: $\text{Ag}_2\text{O}-\text{Cu}_2\text{O}$ [7]; $\text{Ag}_2\text{O}-\text{Cr}_2\text{O}_3$ [12] and $\text{MnO}_2-\text{CuO}-\text{Co}_x\text{O}_y$ [3].

REFERENCES:

1. J. Attenburrow et al. J. Chem. Soc. (London) 1952, 1094.
2. Badische Anilin- und Sodafabrik, German Pat. 163,813 (1903); Z. Elektrochem. 11, 853 (1905).
3. R. Dolique and J. Galindo. Bull. Soc. Chim. France [5] 10, 64 (1943).
4. W. Feitknecht and W. Marti. Helv. Chim. Acta 28, 129, 149 (1945).
5. E. Fremy. Comptes Rendus Hebd. Séances Acad. Sci. 82, 1231 (1876).
6. R. Fricke et al. Ber. dtsch. chem. Ges. 71, 1744 (1938); 72, 405 (1939).
7. R. J. Harrison and M. Moyle. Org. Syntheses 36, 37 (1956).
8. E. Hüttner. Z. anorg. Chem. 27, 81 (1901).
9. A. B. Lamb, W. C. Bray and J. C. Frazer. J. Ind. Eng. Chem. 12, 213 (1920).
10. A. B. Lamb, C. C. Scalione and G. Edgar. J. Amer. Chem. Soc. 44, 738 (1922).
11. L. S. Mathieu-Levy. Ann. Mines 138, 23 (1949).
12. G. Rienäcker and G. Schneeberg. Z. anorg. allg. Chem. 282, 222 (1955).
13. P. W. Selwood, R. P. Eischens, M. Ellis and K. Wethington. J. Amer. Chem. Soc. 71, 3039 (1949).

Hydroxo Salts

R. SCHOLDER

General

“Hydroxo salt” is the term used for a group of complexes where the central atom of the complex anion is a metal to which hydroxyl ions are bound as ligands. The number of these ions depends on the normal coordination number of the metal. The cation of a hydroxo salt is usually an alkali metal, particularly sodium, or the alkaline earth metals barium, strontium and, in some cases, calcium. Heavy-metal salts can be prepared from a few hydroxo anions via a double decomposition reaction.

Hydroxo salts correspond closely to the well-known halo salts in their formula type and structure. Accordingly, mixed halo-hydroxo salts of a number of metals can be prepared. At elevated temperature, hydroxo salts can be converted into oxo salts, provided it is feasible to prepare the latter from a metal hydroxide (the central atom) and an alkali or alkaline earth metal hydroxide. In numerous systems, however, such oxometalates can be obtained only from oxides. In some cases, oxohydroxo salts are also formed as intermediates.

Complex hydroxometal anions are formed in solution via the following equilibrium reaction:

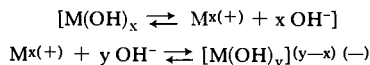

The reagents are strong bases and poorly soluble metal hydroxides. In the above equations, the metal hydroxides function as “acids,” in agreement with the modern theory of their amphoteric behavior. As far as is presently known, the following metals (arranged in order of increasing valence) form hydroxo salts:

M(II): Be, Mg, Sn, Pb, Mn, Fe, Co, Ni, Cu, Zn, Cd

M(III): Al, Ga, In, Bi, Cr, Mn, Fe

M(IV): Sn, Pb, Pt

M(V): Sb

The equilibrium distribution is of controlling importance in the preparation of crystalline alkali hydroxometalates. Most hydroxo salts, alkali salts in particular, rapidly decompose into their components in the presence of H_2O or dilute alkali hydroxide. Only the hexahydroxo salts of Sn (IV), Pt (IV) and Sb (V) dissolve in H_2O at room temperature without decomposition, whereas the other alkali hydroxometalates are stable only when they constitute the solid phase in the presence of (usually very concentrated) alkali hydroxide solution. The alkaline earth hydroxometalates are relatively sparingly soluble and hence are stable in dilute hydroxide; the compound $Ca[Zn(OH)_3]_2 \cdot 2 H_2O$ is stable even in water. The equilibrium shifts toward the reagents with temperature.

Metal oxide-sodium oxide-water systems at constant temperature exhibit the same general behavior regardless of the particular compounds involved (see Fig. 341). Thus, with increasing alkali hydroxide concentration, the solubility at first increases to a maximum and then decreases sharply. The rising branch of the curve corresponds to solid $M(OH)_m$ or MO_n while the decreasing branch corresponds to sodium hydroxometalate, whose solubility is sharply reduced as the NaOH concentration increases.

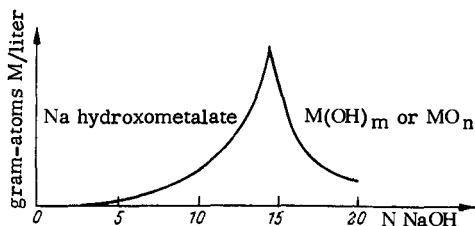

Fig. 341. Solubility of the system metal oxide-sodium oxide-water as a function of sodium hydroxide concentration.

The experimental fact that the sodium hydroxide concentration at the solubility maximum is usually over 30% indicates that highly concentrated (usually 45-50%) NaOH is required for the preparation of most alkali hydroxo salts. This is also necessary to ensure good yields. However, most alkaline earth hydroxometalates can be prepared from more dilute NaOH solutions.

Spreading the microcrystalline solid phase on a clay dish does not afford complete separation from the residual mother liquor. It has recently been established that alkali hydroxometalates can be separated from the mother liquor much more efficiently by brief shaking with pure isoamyl alcohol, and the alkaline earth salts by treatment with anhydrous methanol, possibly containing a small amount of NaOH.

Several types of hydroxo salts of some di- and trivalent metals can be prepared just as in the case of halo salts. These differ in the number of coordinated OH^- ions. The number of OH^- ligands depends on the concentration and temperature of the alkali hydroxide.

Among the less stable alkali hydroxometalates, it is often only the Na salt, but not the K salt, that can be prepared. This is due to the unusually high solubility of the corresponding K salts. In fact, the precipitation of the latter even from highly concentrated hydroxide solutions is often impossible without simultaneous crystallization of KOH. The rather sparingly soluble Ba and Sr salts can be precipitated from the metal hydroxide or oxide solutions by addition of Ba^{2+} or Sr^{2+} . The alkaline earth salts can be obtained more conveniently by simultaneous dropwise addition, in proper ratios, of concentrated solutions of the perchlorates of the central metal atom and of the alkaline earth metal to hot, moderately concentrated sodium hydroxide (sodium perchlorate is much more readily soluble in strong sodium hydroxide than is NaCl). The free hydroxo acids, which should exist as well-defined higher hydrates of the metal oxides, are not known, the exception being hexahydroxoplatinic (IV) acid, $\text{H}_2[\text{Pt}(\text{OH})_6]$.

In some cases the fact that the hydroxometalates are chemical complexes is indicated by the color of the salts and of their solutions. The proof of structure is based on their thermal dehydration curve, their ability to form mixed halo-hydroxo salts, data on isomorphic relations, and some powder pattern studies.

Handling of Concentrated Alkali Hydroxides

STARTING MATERIALS

Very pure or reagent grade (97-98%) NaOH pellets and a similar grade of potassium hydroxide (containing an average of 85% of KOH, the remainder being H_2O) are used.

CONTAINER MATERIALS

Chemical glassware is sufficiently resistant to concentrated alkali hydroxide solutions at room temperature that it can be used without adversely affecting the purity of the products. However, hot, concentrated alkali hydroxide solutions attack any glass so strongly that the latter can be used at high temperatures only for short periods of time, if at all. Such experiments must therefore be run in refined silver containers, which resist even concentrated boiling alkali hydroxide solutions. While pure nickel containers are also suitable, they are not cheaper than silver.

FILTERS

Fritted Pyrex glass of medium and high porosity is suitable. However, its life may be limited in repeated use for filtering hot alkali hydroxide solutions. When filtering very hot and concentrated alkali hydroxide solutions, the glass suction funnel should be wrapped with a strong cloth so as to reduce as much as possible the ever-present danger of sudden breakage (this danger is real even with infrequently used filters). To prevent solidification of solutions containing more than 50% NaOH during filtration, the glass suction funnel is surrounded with a sheet metal jacket containing hot glycerol. When such solutions are boiled in a flask, the rubber stopper must be protected with an asbestos liner.

Even though filter plates made of certain plastics resist hot concentrated alkali hydroxide solutions, we have not yet tested them sufficiently to recommend them for laboratory use.

CARBONATE-FREE SODIUM HYDROXIDE

A 50% sodium hydroxide solution is prepared from the calculated amount of commercial NaOH in a silver flask. To prevent the occasional nuisance of the NaOH sticking to the bottom, the flask is vigorously shaken; solution is promoted by the strong, spontaneous heat evolution. However, external heating should be avoided because of the danger that the hot caustic solution will bump and spill out of the flask, a danger not obviated by the presence of a reflux condenser on the flask. The 50% hydroxide solution is allowed to cool slowly and, if possible, to stand at room temperature for 2-3 days. The precipitated Na_2CO_3 is then filtered off on glass frit of small pore size (rigorous exclusion of air). The completely clear filtrate is virtually carbonate-free. To avoid waiting for precipitation of the carbonate, one can add 1-2 g. of $\text{Ba}(\text{OH})_2$ per 100 ml. of hot, 50% sodium hydroxide; the mixture may then be filtered immediately after cooling to room temperature.

Sodium hydroxide solutions of lower concentration can be prepared by dilution of the 50% solution with boiled H_2O . Removal of Na_2CO_3 from a solution containing more than 50% NaOH must be carried out at 40-60°C to prevent crystallization of NaOH. Such solutions may also be prepared by distilling the calculated amount of water from carbonate-free 50% sodium hydroxide into a graduated cylinder. For obvious reasons, CO_2 must be rigorously excluded. All equipment, including the reflux condenser and the glass suction filter, is protected with Peligot tubes (containing 50% KOH) held in place by rubber stoppers.

Handling alkali hydroxide solutions is often facilitated by a knowledge of their boiling points. For this reason, the boiling points of 20-70% NaOH and KOH solutions, taken from Gerlach [2], are tabulated below.

	25	42.8	53.8	66.7	81.8	100	122.2	150	233.3	g. NaOH (KOH)/ 100 g. H ₂ O
	20	30	35	40	45	50	55	60	70	% NaOH (KOH)
NaOH	108	116	121.5	128	134.5	142.5	150.5	160	180.5	B.p., °C
KOH	106	113	118	124.5	133	145	160.5	177.5	228	B.p., °C

SAFETY RULES

The destructive action of caustic alkali solutions begins immediately. Therefore, the eyes must always be protected by goggles which fit tightly on all sides. Any caustic solution under the fingernails should immediately be washed off with a large amount of water followed by dilute acetic acid. Silver being a much better heat conductor than glass, one should remember that silver equipment will get hot much more rapidly than glass.

REFERENCES:

1. R. Scholder. Chem. Fabrik 11, 541 (1938).
2. G. T. Gerlach. Z. anal. Chem. 26, 463 (1887); see also A. von Antropoff and W. Sommer. Z. phys. Chem. 123, 192 (1926).

Sodium Hydroxozincates

The system ZnO-Na₂O-H₂O contains the following four solid hydroxozincates, whose existence depends on the NaOH concentration:

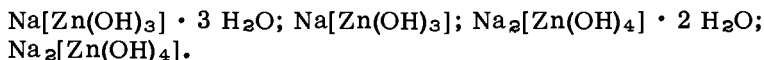

SODIUM TRIHYDROXOZINCATE, Na[Zn(OH)₃]

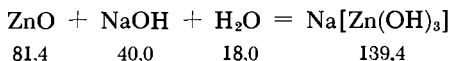

PREPARATION OF CRUDE MATERIAL

A hot solution of 185 g. of NaOH in 100 ml. of H₂O is prepared, and ZnO (105 g.) is added. The mixture is refluxed 0.5 hours and cooled to 100°C. Water (85 ml.) is then gradually added through the condenser (use a funnel). The solution is filtered hot to remove residual ZnO and the filtrate is immediately cooled to about 15°C. If crystallization does not set in within a day, some NaOH pellets are dissolved in a few milliliters of the boiling zincate solution, the solution is cooled in a freezing mixture, and the resulting tetrahydrozincate, which precipitates readily at this higher NaOH concentration, is used to seed an additional 5-ml. portion of the original zincate solution (moderate cooling). Rubbing with a glass rod initiates crystallization of the trihydrozincate. The entire zincate solution is then seeded with this material. The precipitate obtained is filtered off after a few hours, washed with 50% sodium hydroxide, and dried on a clay plate in an empty desiccator. Yield: 50-60 g.

B. PREPARATION OF THE PURE COMPOUND

A solution (prepared at the boil) of 60 g. of ZnO and 250 ml. of pure, 51% sodium hydroxide is filtered at about 40°C, cooled to 15°C, and seeded with zincate prepared as described under (A). After 12 hours the mixture is filtered and worked up as under (A). Yield 40 g.

The moist product (10 g.) is shaken for two hours with 150 ml. of alkaline methanol solution (100 ml. of CH₃OH plus 15 g. of NaOH), filtered, washed first with the same methanol solution and then repeatedly with acetone, and dried over silica gel. This method removes the last traces of NaOH, and the analysis shows the calculated percentages of ZnO, Na₂O and H₂O.

PROPERTIES:

Colorless, microcrystalline powder (small rods). Decomposes immediately in water; decomposes after a few hours in 10% methanolic NaOH; stable in 15% methanolic NaOH (18°C). When prepared by method (A), contains about 0.1 moles of NaOH per mole of zincate.

SODIUM TETRAHYDROXOZINCATE, Na₂[Zn(OH)₄]

A carbonate-free, clear solution of 195 g. of NaOH in 140 ml. of H₂O is prepared, and ZnO (56 g.) is dissolved in it at the boil; the mixture is filtered at 90°C. The crystals that separate out after a few hours are washed with 50% NaOH and spread in as thin a

layer as possible on a clay dish. They are dried in an empty desiccator. Yield: about 100 g.

PROPERTIES:

Formula weight 179.42. Microcrystalline, thin platelets. The NaOH traces (about 0.2 moles per mole of zincate) cannot be removed.

REFERENCES:

- R. Scholder and H. Weber. *Z. anorg. allg. Chem.* 215, 355 (1933);
 R. Scholder and G. Hendrich. *Ibid.* 241, 76 (1939); R. Scholder
 and K. Osterloh. Unpublished data.

Sodium Tetrahydroxomagnesate

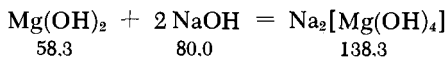
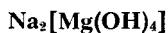

An approximately 65% NaOH solution is prepared in a silver flask by distilling 180 ml. of H₂O from 500 ml. of 50% sodium hydroxide. The solution is cooled to about 100°C and 6 g. of Mg(OH)₂, prepared by slaking MgO (calcined at 500°C) with hot H₂O, is added to it. The mixture is agitated with a silver stirrer and refluxed for 20 hours at 100°C in the absence of CO₂. Without interrupting the heating, the flask contents are transferred by suction (use silver tubing interconnected with polyethylene sleeves) onto a glycerol-heated, medium-pore-size fritted-glass filter, which is maintained at 100°C. The filter cake is dried by suction and immediately spread on a clay dish heated to 100°C. The dish is then kept for about five hours in a vacuum desiccator heated to 100°C, to promote absorption of the surface sodium hydroxide by the clay plate. This procedure yields 8-10 g. of relatively dry sodium hydroxomagnesate which is strongly contaminated with NaOH. To remove the NaOH, 3 g. of the crude product is pulverized in the absence of CO₂ and H₂O, and then shaken for 30-45 min. with freshly distilled isoamyl alcohol (b.p. 127-129°C). The mixture is suction-filtered (again in the absence of CO₂) through a medium-pore-size fritted-glass filter, and rinsed with 50 ml. each of isoamyl alcohol and ether. The product is then dried for a few hours over silica gel while simultaneously removing the ether in vacuum.

PROPERTIES:

Microcrystalline hexagonal platelets. Yields crystalline $\text{Mg}(\text{OH})_2$ (brucite) on treatment with H_2O . Decomposed by strongly alkaline methanol or ethanol even below 0°C ; isoamyl alcohol gradually splits off NaOH , but only on prolonged reaction.

REFERENCE:

R. Scholder and C. Keller. Unpublished data.

Sodium Tetrahydroxocuprate (II)

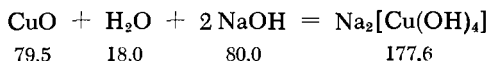
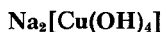

A. CRUDE MATERIAL

Very pure CuO (15 g.) is dissolved in a clear, carbonate-free solution of 500 g. of NaOH in 330 ml. of H_2O (brief refluxing). The dark-blue solution is cooled to 110°C and carefully diluted by adding 140 ml. of H_2O through the reflux condenser (use a funnel). The small quantity of unreacted CuO is then filtered off, collecting the filtrate in a preheated Erlenmeyer flask of refined silver. The Erlenmeyer flask is protected by a Peligot tube (filled with 50% KOH) and kept in an electric drying oven for six days at 75°C to allow the filtrate to crystallize. The mixture is then filtered; the crystals are washed with some 50% and 45% sodium hydroxide (once each) at room temperature and dried on a clay plate over H_2SO_4 . Yield: 13 g.

B. PURIFICATION

The considerable amount of NaOH still present in the product is removed immediately following the washing with the 50% NaOH . Thus the dark-blue crystals are shaken for one hour with 150 ml. of 40% NaOH at room temperature and filtered.

The crystals are then shaken for one minute with the following solutions (in the order given): 150 ml. CH_3OH + 22.5 g. NaOH (18°C); 150 ml. CH_3OH + 15 g. NaOH (0°C); 150 ml. CH_3OH + 1.5 g. NaOH (-10°C).

After decantation, the solid is finally digested twice with pure methanol (-10°C), filtered and washed with methanol at -15°C . The crystals are placed on a clay plate and dried over silica gel in a minimum size desiccator.

When the cuprate solution remaining after filtering off the CuO is quickly cooled to room temperature in a freezing mixture, the salt precipitates as very thin, light-blue platelets. These, however, cannot be completely freed of the excess NaOH. Yield: 20 g.

PROPERTIES:

Firm, dark-blue crystals. The very pure salt obtained by method (B) is extremely sensitive to moisture and rapidly turns dark brown on exposure to air.

REFERENCES:

R. Scholder, R. Felsenstein and A. Apel. *Z. anorg. allg. Chem.* **216**, 138 (1934); R. Scholder and K. Osterloh. Unpublished data.

Barium Hexahydroxocuprate (II)

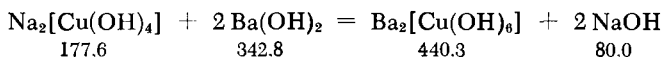

A solution of 10 g. of CuBr₂ in 25 ml. of H₂O is added to 200 ml. of carbonate-free 50% sodium hydroxide at +5°C. The resulting mixture is heated to 70°C (water bath) and the small amount of CuO filtered off. The filtrate is refluxed 130°C and a hot solution of 30 g. of Ba(OH)₂·8 H₂O in 50 ml. of H₂O is added to it through a fluted filter (shaking). The salt that separates is immediately filtered off, cooled to 0°C in an Erlenmeyer flask, shaken for 5 min. with 100 ml. of methanol at -10°C, and filtered off. It is washed with methanol at 0°C and then thoroughly with acetone and anhydrous ether. The residual ether is removed by prolonged vacuum treatment in a desiccator. The product is completely pure. Yield: 13 g.

PROPERTIES:

Light-blue powder (rhombic crystal aggregates). Decomposed by H₂O.

REFERENCES:

R. Scholder, R. Felsenstein and A. Apel. *Z. anorg. allg. Chem.* **216**, 138 (1934); R. Scholder and V. Voelskow. Unpublished data.

Sodium Tetrahydroxoferrate (II)

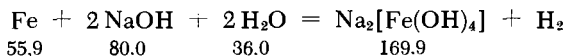
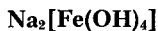

The reactor is a round-bottom, refined-silver flask, carrying a rubber stopper holding a reflux condenser protected by a Peligot tube (filled with an alkaline pyrogallol solution) and a silver tube serving as inlet for pure nitrogen. The flask is charged with 8 g. of reduced iron and 350 ml. of a 50% solution of pure NaOH. The air is displaced with N₂ and the mixture is refluxed for 2.5 hours in a steady N₂ stream. The blue solution is cooled to 120°C and suction-filtered (in the absence of air) through a glass frit covered with a layer of reduced iron. The filtrate is collected in a Pyrex suction flask containing 100 ml. of 50% sodium hydroxide, through which a nitrogen stream may be passed. The filtrate is allowed to cool for about 12 hours under N₂; the gray-green precipitate is then filtered off under N₂, washed with 50% sodium hydroxide, and dried on a clay dish in a nitrogen-filled desiccator. Yield: 4 g.

PROPERTIES:

Gray-green microcrystalline powder (polyhedral crystals); very sensitive to moisture and O₂. Besides the polyhedra, microscopic examination also reveals colorless platelets with oblique sides of Na₄[Fe(OH)₇] · 2 H₂O (see p. 1689).

REFERENCE:

R. Scholder. *Angew. Chem.* **49**, 255 (1936).

Strontium Hexahydroxonicelate (II)

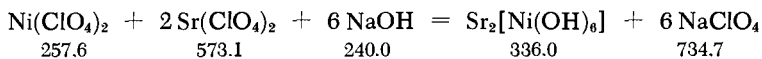

A mixture of 250 g. of NaOH and about 8 g. of Sr(OH)₂ · 8 H₂O is dissolved in 455 ml. of H₂O contained in a silver flask. The solution is briefly refluxed and allowed to stand for 24 hours; the SrCO₃ precipitate is then filtered off. The solution is then brought to a boil, and 35 ml. of a Ni(ClO₄)₂ : Sr(ClO₄)₂ solution (molar ratio ~ 1 : 4) is added. The latter solution is prepared by adding

25 ml. of H₂O to 6.5 g. of NiCl₂ · 6 H₂O and 16 g. of SrCO₃, and then gradually adding 25 ml. of 70% HClO₄. To remove HCl, this solution is concentrated until dense HClO₄ fumes are evolved, and then diluted with H₂O to 35 ml. After addition of the perchlorate solution, the reactor mixture is refluxed in the absence of CO₂. The Sr₂[Ni(OH)₆] precipitate is filtered off with suction while the mother liquor is still hot (use small-pore-size glass frit) with thorough exclusion of CO₂; it is washed with 35% NaOH at room temperature, and then with absolute methanol. The precipitate is shaken for eight hours with absolute methanol, filtered, and washed with methanol and ether. The product is dried and freed of ether by keeping it for several hours in vacuum in a desiccator containing silica gel.

PROPERTIES:

Gray-green, very fine crystalline powder of unidentifiable crystalline habit; not attacked by half-saturated aqueous Sr(OH)₂ solution (0.35 g. SrO/100 ml. H₂O); gradually decomposed by H₂O.

REFERENCE:

R. Scholder and E. Giesler. Unpublished data.

Sodium Trihydroxostannate (II)

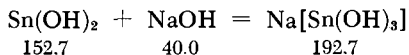
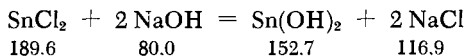

Tin (II) hydroxide is prepared by treating a milky solution of 25 g. of SnCl₂ · 2 H₂O in 1.5 liters of H₂O with a small excess of approximately 10% ammonia (room temperature), diluting to two liters, allowing the solid to settle, removing the slightly turbid supernatant by aspiration, adding two liters of H₂O, again removing the supernatant, and then repeating this process 2-3 times. The precipitated Sn(OH)₂ is filtered off on a large Pyrex glass frit of medium pore size, at first without suction, then by slowly applying vacuum; it is then washed until essentially chloride-free. The paste is thoroughly dried by suction, calcined to SnO₂, and analyzed for Sn(OH)₂ content. Yield of Sn(OH)₂: 85%; Sn(OH)₂ content of paste: about 50%.

Reagent grade NaOH (35 g.) is dissolved in 23 ml. of H₂O contained in a wide-mouth 150-ml. Erlenmeyer glass flask. The

solution is cooled to 50-60°C and the entire Sn(OH)₂ paste is added to it, even though some crystalline NaOH may be present. The container is immediately closed off with a rubber stopper carrying a Peligot tube filled with an alkaline pyrogallol solution. The Sn(OH)₂ after brief shaking dissolves while a small amount of dark SnO separates from the sodium hydroxide solution (the concentration of which is now 50%). The mixture is filtered warm through small-pore-size glass frit. The clear filtrate is protected from air and kept at 0°C; after a few hours, crystallization of the salt is complete. The mixture is carefully warmed to 8°C and filtered through large-pore-size glass frit. To remove the mother liquor still on the crystals, the latter are spread on a clay dish precooled to 0°C, and the dish is kept for 12 hours at 0-3°C in an evacuated desiccator. Yield: 6 g.

PROPERTIES:

Colorless, partly clustered small rods, pointed at the ends. When stored for some time in a closed container (even at 0°C) turns dark because of decomposition; very sensitive to moisture and O₂. After removal from the clay dish, the product is still contaminated with 0.1-0.2 moles of NaOH per mole. During separation and drying, a small percentage of the Sn (II) is converted to Sn (IV).

REFERENCES:

- R. Scholder and R. Pättsch. *Z. anorg. allg. Chem.* **216**, 176 (1933);
R. Scholder and K. Krauss. Unpublished data.

Sodium Hexahydroxochromate (III)

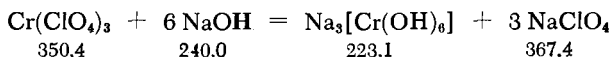
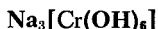

Since commercial chromic hydroxide always contains an appreciable percentage of carbonate, sodium hexahydroxochromate (III) is best prepared from an aqueous Cr(ClO₄)₃ solution obtained from Cr₂O₃ · aq.; the NaClO₄ formed by reaction with NaOH is sufficiently soluble even in highly concentrated NaOH.

A sample of commercial Cr₂O₃ · aq. of known Cr₂O₃ content corresponding to 3 g. of Cr₂O₃ is dissolved in the stoichiometric quantity of 20-25% HClO₄. The solution is concentrated to 25 ml. and filtered; the filtrate is then added to 300 ml. of carbonate-free 51% NaOH. The mixture is refluxed for about 0.5 hours, cooled to

about 120°C, and filtered into a suction flask preheated to 95°C. The dark-green filtrate is transferred to a silver flask protected by a Peligot tube (filled with 50% KOH) and allowed to stand for about four hours in an electric drying oven at 85°C. The precipitated hexahydroxochromate is washed twice with some 40% NaOH (18°C), shaken for 0.5 hours with 80 ml. of 5% methanolic NaOH (18°C), washed several times with the same alkaline methanol solution, and, finally, thoroughly washed with acetone; the acetone is then removed by prolonged vacuum evaporation in a desiccator containing silica gel. The product is very pure (Cr:Na = 1:2.99-3.02). Yield: 5-6 g.

On cooling, the $\text{Na}_3[\text{Cr}(\text{OH})_6]$ mother liquor deposits tightly clustered platelets of mixed crystals of hepta- and octahydroxochromate (III).

PROPERTIES:

Microcrystalline green powder (well-formed polyhedra). At first soluble in cold H_2O , affording a clear solution, which after a long time gradually yields a flocculent precipitate of $\text{Cr}_2\text{O}_3 \cdot \text{aq}$.

REFERENCE:

R. Scholder and R. Pättsch. *Z. anorg. allg. Chem.* **220**, 411 (1934).

Sodium Hydroxoferrates (III)

These products are obtained by the oxidation of a solution of $\text{Na}_2[\text{Fe}(\text{OH})_4]$ in 50% NaOH with O_2 . Under otherwise identical conditions, sodium octahydroxoferrate (III) is formed at 20-25°C, heptahydroxoferrate (III) at 50-60°C, and olive-green oxoferrate (III) at 100-130°C. Boiling 55-60% NaOH yields the red oxoferrate (III), NaFeO_2 .

SODIUM HEPTAHYDROXOFERRATE (III), $\text{Na}_4[\text{Fe}(\text{OH})_7] \cdot 2 \text{H}_2\text{O}$

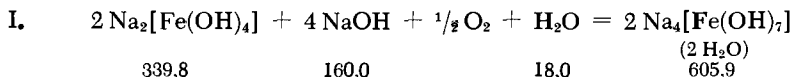

A solution of $\text{Na}_2[\text{Fe}(\text{OH})_4]$ in 50% NaOH, prepared as described on p. 1686 and cooled to 120°C, is filtered into an Erlenmeyer flask containing 100 ml. of 50% NaOH. This flask is connected to two wash bottles each containing 50% KOH, and a fast O_2 stream is passed through the solution (kept at 60°C) for about 12 hours. This causes a gradual discoloration of the greenish-blue solution

and simultaneous crystallization. The crystals are filtered off, rapidly washed with 50% NaOH, and dried as a thin layer on a clay dish in an empty desiccator containing silica gel.

The oxidation with Br_2 is more elegant. The flask containing $\text{Na}_2[\text{Fe}(\text{OH})_4]$ solution is closed off with a rubber stopper carrying a Peligot tube and a dropping funnel. Then a solution of 2-3 ml. of Br_2 in 10 ml. of CCl_4 is added dropwise at 50-60°C with vigorous agitation until the iron solution just turns colorless. An excess of Br_2 must be avoided. The mixture is allowed to stand for two hours at the same temperature and filtered.

II. Freshly precipitated, thoroughly washed $\text{Fe}_2\text{O}_3 \cdot \text{aq.}$ is added to carbonate-free 50% NaOH. An amount of NaOH equal in weight to the water contained in the Fe_2O_3 paste is then added and the latter is dissolved with moderate heating (not to exceed 60°C). The mixture, in a silver Erlenmeyer flask protected with a Peligot tube (filled with 50% KOH), is allowed to stand for several days in an electric drying oven at 70°C. In this manner, the $\text{Fe}_2\text{O}_3 \cdot \text{aq.}$ is completely converted into the nearly colorless, microcrystalline $\text{Na}_4[\text{Fe}(\text{OH})_7] \cdot 2 \text{H}_2\text{O}$, which is sparingly soluble in concentrated NaOH.

PROPERTIES:

Nearly colorless crystalline powder (beveled, partly clustered platelets); very sensitive to moisture. Instantly decomposed by H_2O and CH_3OH , affording $\text{Fe}_2\text{O}_3 \cdot \text{aq.}$ Unstable even in 30% NaOH (18°C).

SODIUM OCTAHYDROFERRATE (III), $\text{Na}_5[\text{Fe}(\text{OH})_8] \cdot 5 \text{H}_2\text{O}$

Oxidation of $\text{Na}_2[\text{Fe}(\text{OH})_4]$ with O_2 in a strongly alkaline solution (see method I above) at 20°C yields fine needles of octahydroferrate (III), which is also nearly colorless. When allowed to stand at room temperature for a few days, freshly prepared $\text{Fe}_2\text{O}_3 \cdot \text{aq.}$ (see method II above) is converted to a large extent, but never completely, to the same salt.

REFERENCES:

- R. Scholder. *Angew. Chem.* **49**, 255 (1936); R. Scholder and K. Krauss. Unpublished data.

Barium Hydroxoferrates (III)

Barium hydroxoferrates (III) are prepared by dropwise addition of an $\text{Fe}(\text{ClO}_4)_3\text{-Ba}(\text{ClO}_4)_2$ solution to hot NaOH. If the initial

NaOH concentration is 25-39%, a precipitate of the hexahydroxo salt, $\text{Ba}_3[\text{Fe}(\text{OH})_6]_2$, is obtained; however, if this NaOH concentration exceeds 42%, the heptahydroxo salt, $\text{Ba}_2[\text{Fe}(\text{OH})_7] \cdot \frac{1}{2} \text{H}_2\text{O}$, precipitates.

The starting $\text{Fe}(\text{ClO}_4)_3\text{-Ba}(\text{ClO}_4)_2$ solution (1:3 molar ratio) is obtained by dissolving 3.5 g. of Fe_2O_3 (analytical grade) in a mixture of 35 ml. of 70% HClO_4 and 25 ml. of conc. HCl . To eliminate the HCl , the solution is concentrated until dense fumes of HClO_4 are given off. The resulting solution is added, with agitation, to a slurry of 26 g. of BaCO_3 in 125 ml. of H_2O ; the mixture is then filtered.

BARIUM HEXAHYDROXOFERRATE (III), $\text{Ba}_3[\text{Fe}(\text{OH})_6]_2$

The starting 33% NaOH is prepared by diluting 180 ml. of carbonate-free 50% NaOH with 140 ml. of CO_2 -free H_2O in a refined silver flask. The mixture is heated to reflux with exclusion of CO_2 , and 75 ml. of the above $\text{Fe}(\text{ClO}_4)_3\text{-Ba}(\text{ClO}_4)_2$ solution is added dropwise. A white precipitate of $\text{Ba}_3[\text{Fe}(\text{OH})_6]_2$ forms immediately. The mixture is allowed to reflux for one hour, after which it is cooled to room temperature, suction-filtered through a medium-pore-size glass frit, and washed with a small amount of 33% NaOH. The precipitate is vigorously shaken for a few minutes with 200 ml. of absolute methanol, filtered through a small-pore-size glass frit, and washed with absolute methanol and anhydrous ether. It is then dried for one hour in a vacuum desiccator over silica gel.

PROPERTIES:

White to slightly yellowish hexagonal platelets. Decomposed by H_2O , affording $\text{Fe}_2\text{O}_3 \cdot \text{aq.}$; stable in absolute methanol.

BARIUM HEPTAHYDROXOFERRATE (III), $\text{Ba}_2[\text{Fe}(\text{OH})_7] \cdot \frac{1}{2} \text{H}_2\text{O}$

The preparation of this compound is analogous to that of $\text{Ba}_3[\text{Fe}(\text{OH})_6]_2$. However, instead of 33% sodium hydroxide, 400 ml. of 50% NaOH is used.

PROPERTIES:

White to slightly yellowish hexagonal platelets. Decomposed by H_2O , affording $\text{Fe}_2\text{O}_3 \cdot \text{aq.}$ Prolonged contact with absolute methanol yields a brown solution.

Strontium hexahydroxoferrate (III), $\text{Sr}_3[\text{Fe}(\text{OH})_6]_2$, can be prepared in a similar way, using 5% NaOH, while strontium heptahydroxoferrate (III), $\text{Sr}_2[\text{Fe}(\text{OH})_7] \cdot 3 \text{H}_2\text{O}$ requires 20% NaOH.

REFERENCE:

R. Scholder. W. Zeiss and M. Kreutz. Unpublished data.

Alkali Aluminates

Depending on the temperature, the following three sodium aluminates crystallize from a solution containing NaOH and Al_2O_3 in equal concentrations:

tetrasodium heptahydroxoaluminate $\text{Na}_4[\text{Al}(\text{OH})_7] \cdot 3 \text{H}_2\text{O}$
 monosodium oxohydroxoaluminate I $\text{Na}_2\text{O} \cdot \text{Al}_2\text{O}_3 \cdot 2.67 \text{H}_2\text{O} =$

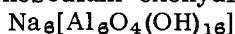

monosodium oxohydroxoaluminate II $\text{Na}_2\text{O} \cdot \text{Al}_2\text{O}_3 \cdot 2.5 \text{H}_2\text{O} =$

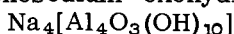

Only monopotassium oxohydroxoaluminate, $\text{K}_2\text{O} \cdot \text{Al}_2\text{O}_3 \cdot 3 \text{H}_2\text{O} = \text{K}_2[\text{Al}_2\text{O}(\text{OH})_6]$, is obtained from a potassium aluminate solution.

TETRASODIUM HEPTAHYDROXOALUMINATE, $\text{Na}_4[\text{Al}(\text{OH})_7] \cdot 3 \text{H}_2\text{O}$

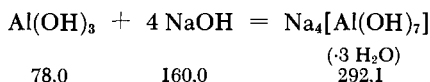

Aluminum hydroxide (45 g.) is dissolved in a solution of 130 g. of NaOH in 100 ml. of H_2O by refluxing one half hour. The solution is slowly cooled to room temperature, allowed to stand for six hours, and only then filtered through a small-pore-size glass frit to remove the considerable amount of Na_2CO_3 precipitate [commercial $\text{Al}(\text{OH})_3$ often contains a large percentage of carbonate]. The crystallization of sodium aluminate, which usually takes a long time to develop, does not start during this period. The clear filtrate is transferred to a round-bottom glass flask closed off with rubber stoppers carrying an air-tight agitator and a Peligot tube. The flask is immersed in 18°C water and its contents are vigorously stirred for 10-14 hours. A thick crystal slurry is formed; this is dried by suction, spread out in a thin layer on a clay dish, and finally dried in an empty desiccator. Yield: 38 g.

PROPERTIES:

Microcrystalline powder; strongly birefringent oblong prisms with beveled end faces. Soluble in H_2O . Contains (as impurity) 0.2-0.3 moles of NaOH per mole of aluminate.

MONOSODIUM OXOHYDROXOALUMINATE I, $\text{Na}_6[\text{Al}_6\text{O}_4(\text{OH})_{16}]$

A clear aluminate solution is prepared in the manner described above and stirred for 8-10 hours at 40-45°C. The crystal slurry is washed with 50% NaOH, covered with methanol, and shaken for 0.5 hours with 150 ml. of methanol. The mixture is filtered, thoroughly washed with a large quantity of methanol followed by acetone, and vacuum-dried over silica gel. Yield: 24 g. Analysis shows Al : Na = 1 : 1.02-1.04.

PROPERTIES:

Formula weight 636.15. Microcrystalline powder (square plates with beveled edges). Transient solubility in H_2O .

MONOSODIUM OXOHYDROXOALUMINATE II, $\text{Na}_4[\text{Al}_4\text{O}_3(\text{OH})_{10}]$

The aluminate solution (see above) is stirred for about six hours at 100-105°C. Otherwise, the preparation, isolation, purification and drying are the same as described above. Very pure product is obtained.

PROPERTIES:

Formula weight 417.98. Microcrystalline powder (thin polygonal platelets).

MONOPOTASSIUM OXOHYDROXOALUMINATE, $\text{K}_2[\text{Al}_2\text{O}(\text{OH})_6]$

A solution prepared at the boil from 120 g. of KOH, 30 g. of $\text{Al}(\text{OH})_3$, and 100 ml. of H_2O is allowed to stand for several hours at room temperature, filtered, seeded with the salt (see below), and shaken for 24 hours. The microcrystalline solid deposit is washed with a small amount of 50% KOH, then with 150 ml. of methanol containing 5% KOH, and finally with acetone; it is then vacuum-dried over silica gel. Yield: 5 g.

Without seeding, the crystallization is delayed for several days. The seeding crystals are obtained by preparing a solution containing 20 g. of KOH, 5 g. of $\text{Al}(\text{OH})_3$, and 10 ml. of H_2O , filtering at room temperature, and shaking for 12 hours. This produces an abundant crop (about 6.5 g.) of monopotassium aluminate crystals. These crystals, however, are very small and are difficult to free from the adhering KOH, particularly if the latter is very concentrated.

PROPERTIES:

Formula weight 250.20. Microcrystalline powder (polyhedra); incompletely soluble in water. Can be obtained very pure.

REFERENCES:

- R. Fricke and P. Jucaitis. *Z. anorg. allg. Chem.* **191**, 129 (1930);
 R. Scholder, W. Kleeberg and M. Schröder. *Naturforschung
 und Medizin in Deutschland, 1939-1946 (FIAT Review)*, Vol.
 25, *Inorg. Chem.*, part III, p. 141.

Sodium Hexahydroxostannate (IV)

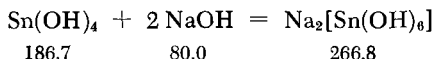
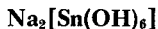

A solution of SnCl_4 in very dilute hydrochloric acid is neutralized to methyl orange with carbonate-free NaOH . The $\text{SnO}_2 \cdot \text{aq}$. precipitate is filtered off, washed until chloride-free with H_2O , and added in portions to an excess of concentrated, 100°C NaOH , in which it dissolves rapidly, affording a clear solution. The crystalline hexahydroxostannate precipitates after a short time. The crystal slurry is filtered in the absence of CO_2 and washed with 30% NaOH and then several times with ethanol and ether.

PROPERTIES:

Colorless crystalline powder (thin hexagonal leaflets). Readily soluble in H_2O ; the solubility decreases markedly with temperature (see Reiff and Toussaint). Always contains small amounts of adsorbed NaOH . Very sensitive to CO_2 .

REFERENCES:

- H. Zocher. *Z. anorg. allg. Chem.* **112**, 1 (1920); R. Reiff and S. M. Toussaint. *Ibid.* **241**, 372 (1939).

Sodium Hexahydroxoplumbate (IV)

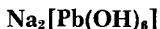

I. ELECTROCHEMICAL METHOD

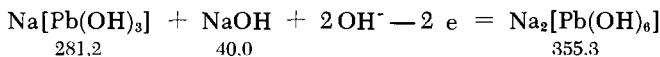

Yellow PbO (analytical grade, 18.5 g.) is dissolved in 300 ml. of boiling 13N NaOH ; the solution is suction-filtered through a

small-pore-size glass frit and allowed to cool in a CO₂-free atmosphere. This hydroxoplumbate (II) solution is unstable and on prolonged standing gradually deposits crystalline lead oxide. Hence it should be electrolyzed as soon as it has cooled to room temperature. Sometimes it may be necessary to separate the solution from the precipitated PbO by decantation right after cooling.

A rectangular 300-ml. glass jar covered with a rubber plate forming an air-tight seal is used as the electrolysis cell. Through appropriate openings in the lid the tank is provided with a gas outlet tube, a thermometer, an air-tight stirrer, an anode lead-in wire cemented into a glass tube, and a porous clay cell serving as the cathode space. The entire system must be gas-tight. Smooth platinum electrodes (5 × 5 cm.) are used. The electrolysis is carried out at ambient temperature with a current density of 0.12-0.18 amp./in.², while vigorously stirring the strongly alkaline hydroxoplumbate (II) solution in the anode space. The cathode space contains concentrated NaOH. The plumbate (IV) separates in the form of a white crystalline precipitate. The precipitate is allowed to settle, the clear solution is siphoned off, and the crystal slurry is covered with absolute ethanol. The crystals and liquid are then transferred to a smaller container and repeatedly digested with absolute ethanol until the latter no longer shows an alkaline reaction. The pure white crystals become slightly yellowish on vacuum drying in a desiccator.

II. CHEMICAL METHOD

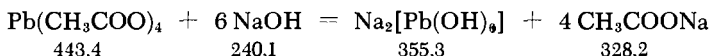

A one-liter, round-bottom glass flask equipped with an air-tight stirrer, a dropping funnel and a Peligot tube (filled with 30% KOH), all inserted through rubber stoppers, is charged with 200 ml. of carbonate-free 30% NaOH. The tip of the dropping funnel is inserted into a short glass tube (15 mm. I.D.) to protect it from the splashing NaOH solution. A solution (usually yellowish) of 50 g. of Pb(CH₃COO)₄ in 200 ml. of K₂CO₃-dried chloroform containing 1 ml. of glacial acetic acid (filtered, if necessary) is added drop-by-drop with vigorous stirring. The brown PbO₂, formed at the site of contact between the drops of the chloroform solution and the NaOH in the flask, dissolves rapidly; after a while, Na₂[Pb(OH)₆] begins to precipitate. Following the addition of the chloroform solution, the mixture is stirred until the crystalline suspension is pure white. The precipitate is allowed to settle for several hours; it is then filtered off and washed twice with 30% NaOH and at least five times with methanol containing 1%

alkali. During this procedure, atmospheric moisture and CO_2 must be absent. The precipitate is then dried on a clay dish placed in an evacuated desiccator over silica gel. A pure white product is obtained provided processing is rapid. Yield: 33 g.

Should the salt be yellowish, it can be purified as follows. The moist product is added in small portions to 500 ml. of 15% NaOH at 75°C (agitation), making sure that each portion is completely dissolved before adding the next. The small residue is filtered off, 150 g. NaOH is added to the filtrate while it is still hot, and the mixture is vigorously shaken to complete dissolution. After cooling, the pure white crystalline powder is filtered off and washed and dried as described above. Yield: 26 g.

PROPERTIES:

Colorless crystalline powder (hexagonal polyhedra); stable in 2% NaOH at 18°C ; very sensitive to moisture. Discolors after absorbing H_2O . Always contains some excess NaOH.

REFERENCES:

- I. G. Grube. Z. Electrochem. 28, 273 (1922); A. Simon. Z. anorg. allg. Chem. 177, 109 (1929).
- II. R. Scholder. Unpublished data.

Barium Oxohydroxostannate (II)

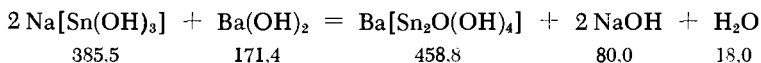

The entire $\text{Sn}(\text{OH})_2$ paste obtained from 25 g. of $\text{SnCl}_2 \cdot 2 \text{H}_2\text{O}$ (preparation as for $\text{Na}[\text{Sn}(\text{OH})_3]$, p. 1687) is added to a 50°C solution of 60 g. of NaOH in 50 ml. of H_2O . The mixture is cooled to 30°C and a hot solution of 1 g. of $\text{Ba}(\text{OH})_2 \cdot 8 \text{H}_2\text{O}$ in 2 ml. of H_2O is added. The mixture is allowed to stand at this temperature for about one hour (air must be absent) and is then filtered to remove the dark SnO and the precipitated carbonate. The clear filtrate is heated to 65°C and treated with a hot solution of 9 g. of $\text{Ba}(\text{OH})_2 \cdot 8 \text{H}_2\text{O}$ in 20 ml. of H_2O (95°C). The greenish-yellow barium oxohydroxostannate precipitates within a few minutes. The supernatant is decanted; the solid is filtered off and covered with 50% NaOH. The salt is then washed with 50 ml. of 2% $\text{Ba}(\text{OH})_2 \cdot 8 \text{H}_2\text{O}$ solution in methanol, followed by pure, 0°C methanol; it is dried on a clay dish over silica gel. Yield: 5 g. Slightly contaminated with BaCO_3 .

PROPERTIES:

Yellowish microcrystalline powder (plates beveled at ends).
Decomposed by H_2O .

REFERENCES:

- R. Scholder and R. Pättsch. Z. anorg. allg. Chem. 216, 176 (1933);
R. Scholder and K. Krauss. Unpublished data.

Iso- and Heteropoly Acids and Their Salts

B. GRÜTTNER AND G. JANDER

Introduction

ISOPOLY COMPOUNDS

Compounds with higher aggregated anions, in which the anion-forming element occurs at least twice, are termed isopoly compounds. Usually it is the alkali or ammonium salts of the isopolyacids that are synthesized. Compounds with isopolyanions are formed, among others, by boron, silicon, phosphorus, arsenic, sulfur, vanadium, molybdenum and tungsten. They may be prepared in a number of ways, e.g., by fusion of an acid anhydride with an alkali hydroxide, dehydration of acid salts, or treatment of a normal salt with its acid anhydride.

Derivatives of the weaker, oxygen-containing metallic acids, such as those of tungstic, molybdic or vanadic acids, exhibit a quite characteristic behavior, and may therefore be considered as the "classical" isopoly compounds. One property characteristic of these metallic acids is the more or less sharply pronounced hydrolysis of their salts in aqueous solution, particularly in the presence of H^+ ions. The hydrolysis products then undergo, over a period of time, a secondary reaction, combining to more highly aggregated ions, that is, the isopolyanions. For example:

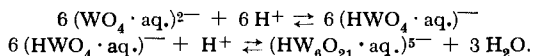

In addition, the following rules apply to the isopoly compounds of vanadium, molybdenum and tungsten.

Specific isopolyanions of definite degrees of condensation and specific chemical properties predominate in the solution; their existence is a function of the H^+ concentration and their crystalline salts may be isolated if certain conditions are observed. When solid, almost all salts of these isopolyacids contain water of crystallization. In keeping with their structure, these compounds

are very sensitive to OH^- , which rapidly degrades most of them to simple molecular compounds. The free acids cannot be isolated since the presence of excess H^+ causes progressive aggregation until insoluble high-molecular-weight hydrated oxides precipitate. "Metatungstic acid" (dodecatungstic acid) is an exception; its overall chemical and crystallographic behavior places it among the heteropoly compounds; thus, it will be discussed in that section.

The preparation of polyphosphates, polysilicates and polyborates is discussed in sections on the respective elements, e.g., on pages 546 ff., 697 ff., 793 ff., and 704 ff. of this handbook.

HETEROPOLY COMPOUNDS

Heteropoly compounds are composed not only of the weak, oxygen-containing metallic acids (tungstic, molybdic and vanadic), but also of moderately strong to weak acids of nonmetals, e.g., boric, silicic, phosphoric, arsenic, telluric, etc., acids. Stable heteropoly compounds very frequently show nonmetallic to metallic acid ratios of 1:12, 1:6 or 1:9. Since the heteropoly compounds form under conditions similar to those in which isopoly compounds are obtained, that is, only in solutions containing H^+ ions, it is assumed that the building blocks of the heteropolyanions are isopolyanions [1].

In keeping with their constitution, all compounds of this class are quite unstable in the presence of OH^- ions and are degraded to the simple metallic and nonmetallic acids. The careful degradation of very complex heteropolyanions by agents such as K_2CO_3 , which act as weak sources of hydroxyl ions, permits the isolation of several intermediates, but nothing further is yet known concerning the mechanism. The heteropolyacids are somewhat more stable to H^+ ions, so that partial isolation of the free acids is possible. Further characteristic properties of numerous heteropoly compounds include their good crystallizability and their relatively high water content per mole of the solid. No heteropoly compounds lacking water in the anion complex are known. Another peculiarity of this class of compounds is that many of the free acids, as well as their salts, crystallize isomorphously [2]. The free acids are rather basic and the formation of neutral salts occurs only as an exception; generally, only acid salts can be isolated. The free acids are specifically capable of forming heavy, oily addition compounds with ether, even when the latter is in the vapor form; these have only a limited miscibility with water and excess ether and easily decompose [3]. This property is commonly used in the preparation of the crystalline acids (see below).

In general the heteropoly compounds of tungstic acid are more complexed and more resistant to hydrolysis than those of molybdic

or even vanadic acid. The stability within the same class of compounds varies depending on the nonmetallic acid, so that compounds with phosphoric and silicic acids are more stable than those containing arsenic acid.

Several recently described compounds of molybdic and tungstic acids with phosphoric acid, where the ratio of Mo (or W)/P is below 3:1 (e.g., $2 \text{ MoO}_3 \cdot \text{P}_2\text{O}_5$ or $\text{Na}_2\text{O} \cdot 2 \text{ WO}_3 \cdot \text{P}_2\text{O}_5$), are not heteropoly compounds; rather, the Mo or W is bound as a cation [4]. We shall omit their discussion.

REFERENCES:

1. G. Jander and K. F. Jahr. *Kolloid-Beihefte* 41, 297 (1935).
2. See, e.g., A. Rosenheim and J. Jaenicke. *Z. anorg. Chem.* 77, 239 (1912); 101, 235 (1917); H. Copaux. *Ann. Chim. Phys.* [8] 17, 207 (1909); R. Abegg. *Handbuch d. anorg. Chem.* [Handbook of Inorganic Chemistry], Vol. IV., part 1, 2nd half, p. 993.
3. E. Drechsel. *Ber. dtsh. chem. Ges.* 20, 1452 (1887); A. Rosenheim and J. Jaenicke. *Z. anorg. allg. Chem.* 101, 224, 250 (1917).
4. I. Schulz. *Ibid.* 281, 99 (1955); 284, 31 (1956).

General Methods

1. FREE HETEROPOLYACIDS BY THE METHOD OF DRECHSEL

A solution of the sodium salt of a heteropoly acid is concentrated as far as possible (even to the sirupy state), placed in a separatory funnel, and covered with about 1/3 its volume of ether. The funnel is shaken vigorously to saturate the solution with the ether. Ice-cold, conc. (37%) iron-free HCl is now added in small portions, with vigorous shaking after each addition. The liquid must not be allowed to heat up during this step; if necessary, the separatory funnel should be externally cooled with water. The liberated acid immediately forms an adduct with the ether and sinks to the bottom as heavy, oily drops which form a third layer. When this layer clarifies, it is drained into a flask. The reaction is complete when addition of hydrochloric acid does not produce further oily droplets at the ether-solution interface. The oil is treated with about an equal volume of H_2O , and the ether is driven off by drawing a stream of clean, dry air through the mixture. The residual clear aqueous solution of the acid is placed, until incipient crystallization, in a vacuum desiccator over conc. H_2SO_4 and then over solid KOH to absorb the still present HCl. Only the 12-tungstic-1-boric acid should be crystallized in desiccator over P_2O_5 , in which case this is done to

prevent decomposition of the heteropolyacid by volatilization of the boric acid. Only hydrochloric acid should be used for extraction since the ether adduct is always capable of absorbing this acid, and the latter can then be removed more readily than either sulfuric or nitric acids.

2. FREE HETEROPOLYACIDS VIA ION EXCHANGE

The advantage of this method lies in the high purity of the final product. The starting materials—heteropoly salts prepurified by many recrystallizations and extremely soluble in water—are best prepared by the method given below (see 3). In view of the very pronounced acidity of the heteropolyacids and their frequent sensitivity to reducing agents, it is desirable to use cation exchange resins carrying sulfonic acid groups (e.g., Permutit RS), which exhibit only a strong acid function and have almost no reducing power. The operating conditions depend on the sensitivity, quality and quantity of the heteropolyacid to be prepared, and can easily be optimized in preliminary experiments. The following rules of thumb should be observed: The exchange capacity of the resin normally amounts to about 2 meq./cm³ (bulk volume); it is desirable to work with starting solutions which are as concentrated as possible; the throughput of the solution through the column should be low (approx. 2-5 cm³/min.). The free heteropolyacid solutions should be concentrated on a steam bath or in a desiccator and, if needed, crystallized.

The method fails with heteropolysalts whose aqueous solutions exhibit a strong acid reaction. Additional complications arise if salt impurities (NaCl, NaNO₃, etc.) are present in the solution, since these salts produce HCl, HNO₃, etc., during passage through the column. A too strongly acid medium hinders the formation of free, crystalline heteropolyacids during concentration of the eluate.

The one advantage of this method has already been mentioned. The disadvantages are that one must begin with pure, crystalline alkali salts (which in some cases can only be obtained by the roundabout route of first preparing the free acid by Drechsel's method), and, in addition, the heteropolyacid solutions obtained by ion exchange are often relatively dilute so that their concentration is time-consuming.

3. HETEROPOLYSALTS

If the salts cannot be synthesized from their components or cannot be isolated in pure form, they may be conveniently obtained from moderately concentrated solutions of their acids by supersaturation with metal chlorides, or in better yield and

purer form by addition of stoichiometric quantities of the metal carbonate. The carbonate should be added carefully, since an excess will induce decomposition of the heteropolyanion.

REFERENCES:

1. E. Drechsel. Ber. dtsh. chem. Ges. 20, 1452 (1887); A. Rosenheim and J. Jaenicke. Z. anorg. allg. Chem. 101, 224 (1917).
2. Based on unpublished experiments of G. Jander and D. Ertel; L. C. W. Baker, B. Loev and Th. P. McCutcheon. J. Amer. Chem. Soc. 72, 2374 (1950); R. Klement. Z. anorg. Chem. 260, 267 (1949); F. Hein and H. Lilie. Z. anorg. allg. Chem. 270, 45 (1952).
3. A. Rosenheim and J. Jaenicke. Ibid. 101, 224 (1917); H. Copaux. Ann. Chim. Phys. [8] 17, 217 (1909).

ISOPOLY COMPOUNDS

Isopolyvanadates

1. The Sodium Salt $2\text{Na}_2\text{O} \cdot \text{V}_2\text{O}_5 \cdot \text{aq.}$

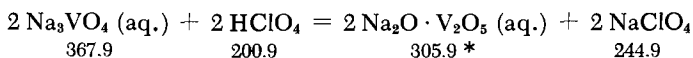

A 1.1M Na_3VO_4 solution is prepared by dissolving V_2O_5 in the stoichiometric quantity of carbonate-free NaOH solution, so that 3 moles of Na are present per mole of V; this corresponds to 100.0 g. of V_2O_5 and 132.0 g. of NaOH per liter. Then, 100 ml. of this solution is acidified by dropwise addition of 24.9 ml. of 4.44N HClO_4 (vigorous mechanical stirring). The solution is briefly heated on a steam bath to achieve equilibrium, whereupon the orange liquid becomes colorless. This is then concentrated in vacuum at 25-30°C. The resulting crystals are filtered and washed with some water.

SYNONYM:

Sodium pyrovanadate.

PROPERTIES:

Colorless, water-soluble crystals. Water content: 15 moles of H_2O /mole. In keeping with its molecular weight, should be considered a salt of a divanadic acid $\text{H}_4(\text{V}_2\text{O}_7 \cdot \text{aq.})$.

*The formula weights given here and subsequently refer to the anhydrous compound.

REFERENCES:

G. Jander and K. F. Jahr. Z. anorg. allg. Chem. 211, 53 (1933);
Kolloid-Beihefte 41, 35 (1935).

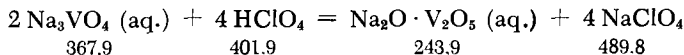
2. The Sodium Salt $\text{Na}_2\text{O} \cdot \text{V}_2\text{O}_5 \cdot \text{aq.}$ 

A 0.812M solution of Na_3VO_4 is prepared as in (1) but using 73.9 g. of V_2O_5 and 97.5 g. of NaOH per liter. Then, 100 ml. of this solution is treated with 57.5 ml. of 2.54N HClO_4 (dropwise addition with stirring) and briefly heated on a steam bath until colorless. The mixture is then concentrated in vacuum at 25-30°C. After filtration the crystals are washed with some water.

SYNONYM:

Sodium metavanadate.

PROPERTIES:

Colorless, water-soluble crystals. Water content: 3 moles of H_2O /mole. In keeping with its molecular weight, should be considered a salt of a tetravanadic acid $\text{H}_8(\text{V}_4\text{O}_{13} \cdot \text{aq.})$. Many authors also consider it as the derivative of a trivanadic acid $\text{H}_3(\text{V}_3\text{O}_9 \cdot \text{aq.})$.

REFERENCES:

G. Jander and K. F. Jahr. Z. anorg. allg. Chem. 211, 53 (1933);
Kolloid-Beihefte 41, 35 (1935).

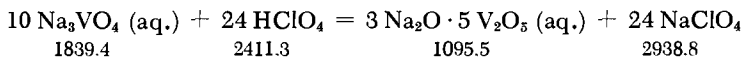
3. The Sodium Salt $3 \text{Na}_2\text{O} \cdot 5 \text{V}_2\text{O}_5 \cdot \text{aq.}$ 

The 0.812M Na_3VO_4 solution (150 ml.) is prepared as in (2) and 381 ml. of 0.8M HClO_4 is added dropwise with stirring. The mixture is then allowed to stand for about 14 days in a closed flask. At first it becomes dark red, changing to a permanent brighter orange-red in the course of time. It is concentrated in vacuum at 25-30°C. The crystals which form are washed with some water.

PROPERTIES:

Small, hexagonal orange-red platelets with beveled edges, or thin rhombohedra. Grinding changes the crystals into a bright yellow powder. Soluble in H_2O . Water content: 22 moles of H_2O /mole. In keeping with the molecular weight, should be considered as a salt of a pentavanadic acid $H_7(V_5O_{16} \cdot aq.)$ [G. Jander and K. F. Jahr, *Kolloid-Beihefte* **41**, 35 (1935)]. Regarded by many authors as a mixture of salts of different basicity, all of them derivatives of hexavanadic acid $H_4(V_6O_{17} \cdot aq.)$ [see P. Souchay and G. Carpeni, *Bull. Soc. Chim. France* (5) **13**, 160 (1946); A. Rosenheim, *Z. anorg. allg. Chem.* **96**, 139 (1916)].

REFERENCE:

G. Jander and K. F. Jahr. *Z. anorg. allg. Chem.* **211**, 53 (1933).

4. The Potassium Salt $K_2O \cdot 3 V_2O_5$

This salt is obtained from solutions of commercial potassium "metavanadate" ($1.04 K_2O \cdot V_2O_5 \cdot 0.78 H_2O$) by addition of 1.4 moles of acetic acid per mole of vanadate.

Commercial potassium "metavanadate" (7 g.) is dissolved in 25 ml. of water in a beaker placed in a large heating bath ($75^\circ C$). The hot solution, which is about 2M in vanadium, is then treated with 70 ml. of 1M acetic acid added from a burette whose tip is immersed in the vanadate solution (vigorous mechanical stirring). The acetic acid is introduced at the rate of 1 ml./minute. The red solution is allowed to remain in the heating bath until the latter cools to room temperature (about 15 hours). The clear solution is then cooled to $0^\circ C$ to induce crystallization. The crystals are filtered off and washed with some ice-cold water, then with acetone.

PROPERTIES:

Formula weight 545.7. Orange-red rhombic crystals or hexagonal platelets, sometimes rather large double pyramids. In view of its chemical behavior and molecular weight, this salt also should be regarded as the salt of pentavanadic acid $H_5(V_5O_{15} \cdot aq.)$. A part of the vanadium is said to be bound cationically, the salt thus having the formula $K_2(VO)[V_5O_{15}]$.

REFERENCE:

K. F. Jahr and G. Jander. *Z. anorg. allg. Chem.* **220**, 204 (1934).

Isopolyniobates

Three types of anions exist in aqueous solutions of alkali niobates; these are in reversible equilibria with each other and their ranges of stability depend on the pH of the solution. All alkali isopolyniobates are salts of the hypothetical hexaniobic acid $H_8Nb_6O_{19}$. The general method of preparation of those salts in which six to eight H^+ are replaced by M^+ consists of fusion of Nb_2O_5 with alkali hydroxide or carbonate, solution of the fused cake in H_2O , and concentration to obtain crystals. The ortho-niobate M_3NbO_4 (M = alkali cation) formed in the melt is irreversibly converted to an isopolyniobate by treatment with water. The solubility of the alkali isopolyniobates in water is strongly dependent on the size of the cation. Thus, Li and Na salts invariably dissolve with difficulty (especially in the presence of excess Li^+ or Na^+), while K, Rb and Cs salts are readily to very readily soluble. The solutions are strongly alkaline. All alkali niobate solutions are very sensitive to acids; even small amounts of mineral acids produce irreversible clouding of the solutions or precipitates of $Nb_2O_5 \cdot aq.$ On heating to over $300^\circ C$, all alkali isopolyniobates lose water irreversibly to give the anhydrous, insoluble alkali metaniobates $MNbO_3$.

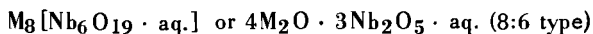

To prepare the K salt, Nb_2O_5 and KOH (mole ratio $\sim 1:20$, weight ratio $\sim 4:17$) are heated in a silver or alumina crucible until a clear melt is obtained. The melt is cooled, ground and dissolved in H_2O . The solution is decanted to remove any insoluble matter which may be present, then concentrated in vacuum over conc. H_2SO_4 until formation of crystals. These are washed with some water and dried on filter paper.

The corresponding Na salt is obtained from aqueous solutions of the K salt by treatment with NaOH (stirring). The fine, crystalline, white precipitate is filtered off, washed with water, alcohol and ether, and dried.

PROPERTIES:

Well-crystallized salts; the water content varies somewhat depending on the method of preparation. The large, transparent crystals of the K salt effloresce when stored under sharply desiccating conditions; they then become cloudy, but retain their good solubility in water.

Depending on the conditions of precipitation (hot or ice-cold solutions), the 8:6 sodium salt gives differing crystalline forms (needles or leaflets), which also differ in their water content.

In aqueous solutions, salts of the type $M_8[Nb_6O_{19} \cdot aq.]$ are stable only at $pH > 13$.

$M_7[HNb_6O_{19} \cdot aq.]$ or $7M_2O \cdot 6Nb_2O_5 \cdot aq.$ (7:6 type)

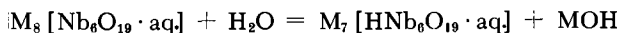

Two recrystallizations of the 8:6 sodium salt from H_2O afford $Na_7[HNb_6O_{19} \cdot aq.]$.

Another method of preparation starts with the fusion of Nb_2O_5 with Na_2CO_3 (mole ratio $\sim 1:4$, weight ratio $\sim 5:8$); the cooled melt is ground, treated with a large amount of H_2O , and stirred for several hours. Since the solubility of sodium niobate is poor, only the excess Na_2CO_3 dissolves in this operation. The residue is recrystallized from H_2O to give pure 7:6 sodium niobate.

The corresponding K salt is best prepared by addition of alcohol to solutions which contain 10 weight percent or more of pure 8:6 potassium niobate.

PROPERTIES:

The 7:6 sodium niobate forms long crystalline needles; water content: 32 moles of H_2O /mole.

The 7:6 potassium niobate precipitated with alcohol readily loses its water of crystallization and forms lower hydrates; e.g., at $100^\circ C$, it gives the penta- or tetrahydrate, and at $150^\circ C$, the dihydrate.

In aqueous solutions, salts of the type $M_7[HNb_6O_{19} \cdot aq.]$ are stable only in the pH range of 9 to 13.

$(M_8[Nb_6O_{18} \cdot aq.])_n$ or $(6M_2O \cdot 6Nb_2O_5 \cdot aq.)_n$ (6:6 type)

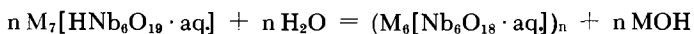

A 2-4% aqueous solution of 8:6 potassium niobate (or a concentrated solution of 7:6 potassium niobate) is treated by dropwise addition of an equal volume of methyl alcohol (cooling in ice, vigorous mechanical stirring). The product is an amorphous, flocculent hydrated potassium niobate.

It is filtered, washed with 50% methyl alcohol, and dried under mild conditions.

PROPERTIES:

Pure white powder. Readily soluble in water. The water content varies depending on the conditions of preparation. The hydrated

metaniobate is stable only in aqueous solutions of $\text{pH} < 8$ (probably as far as the region of the isoelectric point, which occurs at $\text{pH} \sim 4.5$). At higher pH values, changes first to the 7:6 type ($\text{pH} 9-13$), and then to the 8:6 type ($\text{pH} > 13$). Based on diffusion measurements, the anion $([\text{Nb}_6\text{O}_{18} \cdot \text{aq.}]^{6-})_n$ has an ionic weight ~ 3000 ($n = 3-4$), so that the designation in the heading of this section is preferred to the formulas $\text{M}_2\text{O} \cdot \text{Nb}_2\text{O}_5 \cdot \text{aq.}$ or $\text{MNbO}_3 \cdot \text{aq.}$ which are sometimes encountered.

REFERENCES:

- G. Jander and D. Ertel. *J. Inorg. Nuclear Chem.* **14**, 71, 77, 85 (1960); A. V. Lapitskiy and V. I. Spitsyn. *Zh. Prikl. Khim.* **26**, 101 (1953); F. Windmaisser. *Österr. Chemiker-Ztg.* **45**, 201 (1942); P. Süe. *Ann. Chimie [11]* **7**, 493 (1937).

Isopolytantalates

As far as the general method of preparation of alkali isopolytantalates, their water solubility and their thermal behavior are concerned, the introductory remarks made in the section on isopolyniobates apply here as well. However, the composition of the alkali isopolytantalates, i.e., the base:acid ratio, is not yet completely clear. While some authors find hexatantalates (8:6) exclusively, others have established that only pentatantalates (7:5) exist, and still others insist that both types of compounds occur together, and are possibly related to each other via a region in which only one exists.

For this reason, we have given here several procedures taken from the original references.

$\text{K}_7[\text{Ta}_5\text{O}_{16} \cdot \text{aq.}]$ or $7\text{K}_2\text{O} \cdot 5\text{Ta}_2\text{O}_5 \cdot \text{aq.}$ (pentatantalate, 7:5 type)

$\text{K}_8[\text{Ta}_6\text{O}_{19} \cdot \text{aq.}]$ or $4\text{K}_2\text{O} \cdot 3\text{Ta}_2\text{O}_5 \cdot \text{aq.}$ (hexatantalate, 8:6 type)

Either Ta_2O_5 and KOH (mole ratio $\sim 1:20$, weight ratio $\sim 2:5$) or Ta_2O_5 and K_2CO_3 (mole ratio $\sim 1:4$) are heated in a silver or alumina crucible (or a platinum vessel) until a clear melt is obtained. The melt is cooled, ground and dissolved in H_2O . The solution is decanted from any insoluble matter and concentrated in vacuum over conc. H_2SO_4 until crystallization occurs. The crystals are rinsed with H_2O and dried on filter paper. The crystal size increases with the excess alkali hydroxide or carbonate present in the mother liquor.

PROPERTIES:

Hexagonal prismatic columns up to 1 cm. long, with blunt edges; effloresce when stored under sharply desiccating conditions.

Readily soluble in water, giving a strong alkaline reaction. The content of water of crystallization varies.

REFERENCES:

- G. Jander and H. Schulz. Z. anorg. allg. Chem. 144, 233 (1925);
G. Jander and D. Ertel. J. Inorg. Nuclear Chem. 3, 139 (1956);
F. Windmaisser. Z. anorg. allg. Chem. 248, 283 (1941).

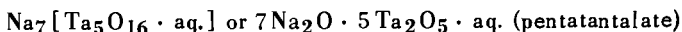

A mixture of Ta_2O_5 and NaOH (mole ratio 1:5, weight ratio 11:5) is melted. The melt is cooled, ground, dissolved in H_2O and treated in the cold (stirring) with 0.1N NaOH. Pure white Na pentatantalate precipitates. It is washed with H_2O , alcohol and ether, and dried. Sodium pentatantalate also forms when the aqueous solution of the melt is evaporated at 85°C .

Alternate method: The same salt is obtained by treatment of a hot potassium tantalate solution with hot aqueous NaOH.

PROPERTIES:

Small prismatic needles; d^{20} 3.78. Water content: 22 moles of H_2O /mole; moderately soluble in water. The pH of a 1% solution is 8.48.

REFERENCES:

- V. I. Spitsyn and N. N. Shavrova. Zh. Obshch. Khim. 26, 1258 (1956);
G. Jander and D. Ertel. J. Inorg. Nuclear Chem. 3, 139 (1956).

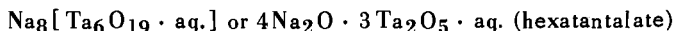

The melt obtained by fusion of Ta_2O_5 and NaOH (mole ratio 1:5, weight ratio 11:5) is cooled, ground and treated with ten times its weight of cold H_2O to remove excess alkali. The residue is dissolved in H_2O at 80°C and concentrated at 50°C .

PROPERTIES:

Small leaflets; d^{20} 3.58. Water content: 33 moles of H_2O /mole; moderately soluble in water; pH of a 1% solution = 8.58. Goniometric measurements indicate that this Na hexatantalate belongs to the hexagonal system.

REFERENCES:

V. I. Spitsyn and N. N. Shavrova. Zh. Obshch. Khim. 26, 1258, 1262 (1956).

Isopolyarsenates

Sodium Hydrogen Triarsenate $\text{Na}_3\text{H}_2\text{As}_3\text{O}_{10}$

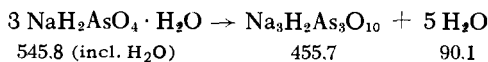

This salt is formed on dehydration of $\text{NaH}_2\text{AsO}_4 \cdot \text{H}_2\text{O}$. Very slow heating of the starting material yields several intermediate products (NaH_2AsO_4 and $\text{Na}_2\text{H}_2\text{As}_2\text{O}_7$), which transform above 135°C to the triarsenate $\text{Na}_3\text{H}_2\text{As}_3\text{O}_{10}$. The last is stable up to 230°C . Rapid heating of the starting $\text{NaH}_2\text{AsO}_4 \cdot \text{H}_2\text{O}$ to temperatures above 96°C yields the triarsenate directly.

The best method of preparation is to place about 10 g. of $\text{NaH}_2\text{AsO}_4 \cdot \text{H}_2\text{O}$ (see p. 602) in a weighing bottle and heat it to constant weight (about 25 hours) in an electric furnace at 135°C .

PROPERTIES:

Absorbs H_2O from air at room temperature; after several intermediate stages, $\text{NaH}_2\text{AsO}_4 \cdot \text{H}_2\text{O}$ is finally regenerated. Immediately hydrated to the orthoarsenate upon solution in water. Considered by Thilo and Plaetschke to be the doubly acid salt of the pentabasic triarsenic acid $\text{H}_5\text{As}_3\text{O}_{10} = \text{As}_2\text{O}_5 \cdot \frac{5}{3} \text{H}_2\text{O}$. For the preparation of $\text{As}_2\text{O}_5 \cdot \frac{5}{3} \text{H}_2\text{O}$, see this handbook, p. 601.

REFERENCE:

E. Thilo and I. Plaetschke. Z. anorg. Chem. 260, 315 (1949).

Isopolychromates

Potassium Trichromate $\text{K}_2\text{O} \cdot 3\text{CrO}_3$

This salt is formed on careful evaporation of an aqueous solution of $\text{K}_2\text{Cr}_2\text{O}_7$ and excess CrO_3 .

A solution of 11.0 g. of $\text{K}_2\text{Cr}_2\text{O}_7$ and 17.4 g. of CrO_3 (mole ratio $\text{K}_2\text{O}:\text{CrO}_3 = 1:6.66$) in 22.0 ml. of water is prepared at 60°C , a temperature at which the solution is saturated. Evaporation at 60°C yields deep red crystals. The liquid is evaporated to about

13 ml. and then decanted rapidly while still warm. The crystals are dried by pressing on filter paper. Yield: about 7.8 g.

PROPERTIES:

Formula weight 394.2. Deep red prisms, containing no water of crystallization; decomposes on solution in water. Stable in solutions only in the presence of excess CrO_3 or conc. HNO_3 .

Potassium Tetrachromate $\text{K}_2\text{O} \cdot 4\text{CrO}_3$

This salt is obtained from aqueous solutions of $\text{K}_2\text{Cr}_2\text{O}_7$ in the presence of a large excess of CrO_3 . The evaporation should not be carried too far.

A saturated solution of 15.67 g. of $\text{K}_2\text{Cr}_2\text{O}_7$ and 43.43 g. of CrO_3 (mole ratio $\text{K}_2:\text{CrO}_3 = 1:10.15$) in 40.9 ml. of water is prepared at 60°C and concentrated at this temperature to about 10 ml. The nascent crystals are separated and dried as described in the case of the trichromate. Yield: about 13 g.

PROPERTIES:

Formula weight 494.2. Brownish red tablets, containing no water of crystallization; decomposes on solution in water. Stable in solutions only in the presence of excess CrO_3 or conc. HNO_3 .

REFERENCES:

- E. Jäger and G. Krüss. *Ber. dtsh. chem. Ges.* 22, 2040 (1889);
 F. A. H. Schreinemakers. *Z. phys. Chem.* 55, 71 (1906).
 Checked by the present authors.

Isopolymolybdates

The compounds described below should be considered derivatives of a hexamolybdic acid $\text{H}_6(\text{Mo}_6\text{O}_{21} \cdot \text{aq.})$ [see G. Jander and K. F. Jahr, *Kolloid-Beihefte* 41, 27 (1935)].

The Sodium Salt $5\text{Na}_2\text{O} \cdot 12\text{MoO}_3 \cdot \text{aq.}$

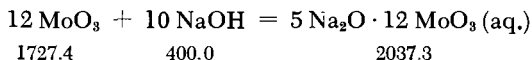

Sodium hydroxide (8 g.) is dissolved in 100 ml. of hot H_2O , and 29 g. of MoO_3 is added. The pH of the cooled, clear solution (filtered, if necessary) is about 5. It is evaporated in a vacuum

desiccator over H_2SO_4 to $3/4$ to $2/3$ of its original volume. The compound precipitates in the form of a slurry, which is filtered and washed with some H_2O .

SYNONYM:

Sodium paramolybdate.

PROPERTIES:

According to Rosenheim, large, lustrous monoclinic prisms which effloresce easily. Water content: 38 moles of $\text{H}_2\text{O}/\text{mole}$. Soluble in H_2O . In our own experiments, evaporation in vacuum or on a steam bath gave a granular white mass, which was not significantly soluble in water either after drying or when freshly prepared and moist.

REFERENCE:

A. Rosenheim. Z. anorg. allg. Chem. 96, 143 (1916). Checked by the present authors.

The Ammonium Salt $5(\text{NH}_4)_2\text{O} \cdot 12\text{MoO}_3 \cdot \text{aq}$.

The reaction vessel is a porcelain dish. It contains 20 g. of MoO_3 , covered with 230 ml. of conc. ammonia. The solution is gently evaporated on a steam bath (solution temperature $60-70^\circ\text{C}$) until the excess NH_3 is removed and the first crystals form (this occurs upon concentration to about $1/5$ of the original volume). The concentrate is cooled and the crystals are filtered off. Yield: about 20 g.

PROPERTIES:

Formula weight 1987.8. According to Rosenheim, large, clear, colorless hexagonal prisms, moderately soluble in H_2O . Water content: 7 moles of $\text{H}_2\text{O}/\text{mole}$. This product is the ammonium molybdate of commerce. Its aqueous solution gives an acid reaction and the compound undergoes hydrolytic cleavage on prolonged boiling. Our own experiments yielded small, white crystals, soluble in hot H_2O .

REFERENCE:

A. Rosenheim. Z. anorg. allg. Chem. 96, 141 (1916). Checked by the present authors.

The Sodium Salt $\text{Na}_2\text{O} \cdot 4\text{MoO}_3 \cdot \text{aq.}$

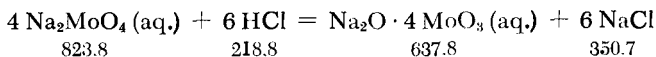

A solution of 9.3 g. of $\text{Na}_2\text{MoO}_4 \cdot 2 \text{H}_2\text{O}$ in about 8 ml. of hot H_2O is treated, while still hot, with 11 ml. of 5.5N HCl added dropwise from a burette. The initial precipitate redissolves, giving a yellowish solution. The liquid, in a stoppered Erlenmeyer flask, is left in a cool place to crystallize. A crystalline crust appears after 24 hours and its thickness increases in the course of the next few days. The crystals are filtered off, washed three times with cold water, and dried by drawing air through the crystal layer. Yield: 6 g.

SYNONYM:

Sodium metamolybdate.

PROPERTIES:

Relatively long needles, partially pulverized when touched. Moderately soluble in cold H_2O , very soluble in hot. Water content: 6 moles of H_2O /mole.

REFERENCE:

G. Wempe. Z. anorg. Chem. 78, 302 (1912). Checked by the present authors.

Isopolytungstates

The compounds described below are derivatives of a hexatungstic acid $\text{H}_6(\text{W}_6\text{O}_{21} \cdot \text{aq.})$ [see G. Jander and K. F. Jahr, Kolloid-Beihefte 41, 18 (1935)].

The Sodium Salt $5\text{Na}_2\text{O} \cdot 12\text{WO}_3 \cdot \text{aq.}$

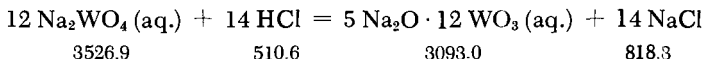

A solution of 20 g. of $\text{Na}_2\text{WO}_4 \cdot 2 \text{H}_2\text{O}$ in 40 ml. of hot H_2O is neutralized to litmus with 2N HCl. About 23.5 ml. of HCl is required (about 1.2 moles of HCl per mole of Na_2WO_4). The pH of the solution is then 6.8. The salt is allowed to crystallize in a vacuum desiccator at room temperature over H_2SO_4 .

SYNONYM:

Sodium paratungstate.

PROPERTIES:

Large transparent or milky-white trichlinic crystals. Water content: 28 moles of H_2O /mole. Readily soluble in water. Other hydrates exist at higher temperatures. The recent views on the complex processes involved in the formation of paratungstates are given by Jander and Krüerke.

REFERENCES:

- A. Rosenheim. Z. anorg. allg. Chem. 96, 160 (1916); C. Scheibler. J. prakt. Chem. 83, 284 (1861). Checked by the present authors. G. Jander and U. Krüerke. Z. anorg. allg. Chem. 265, 244 (1951).

The Ammonium Salt $5(NH_4)_2O \cdot 12WO_3 \cdot aq.$

Hydrated tungstic acid is dissolved in excess ammonia, and the solution is concentrated on a steam bath or at room temperature, whereby the excess ammonia evaporates.

SYNONYM:

Ammonium paratungstate.

PROPERTIES:

Formula weight 3042.72. Microscopically small, rectangular tablets when the solution is evaporated at high temperatures. Water content: 7 moles of H_2O /mole. A different hydrate exists at room temperature and below. Rather sparingly soluble in H_2O . On prolonged boiling in aqueous solution, the salt is hydrolytically decomposed and loses NH_3 .

REFERENCE:

- A. Rosenheim. Z. anorg. allg. Chem. 96, 158 (1916).

The Zinc Salt $5ZnO \cdot 12WO_3 \cdot aq.$

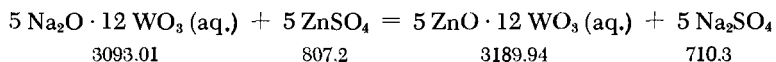

A solution is prepared by heating a mixture of 7.8 g. of sodium paratungstate (prepared as above) and 70 ml. of water. This mixture is then reacted with a warm, saturated solution of 2.4 g. of

$\text{ZnSO}_4 \cdot 7 \text{H}_2\text{O}$ in 15 ml. of water. A white precipitate forms, partially redissolves, and then settles out. It is suction-filtered and dried over conc. H_2SO_4 .

SYNONYM:

Zinc paratungstate.

PROPERTIES:

White needles or fine, crystalline precipitate; poor solubility in H_2O . Water content: 35 moles of H_2O /mole.

REFERENCE:

A. Rosenheim. Z. anorg. allg. Chem. 96, 162 (1916). Checked by the present authors.

Isopolysulfates

Potassium Trisulfate $\text{K}_2\text{S}_3\text{O}_{10}$

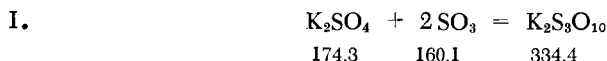

According to Baumgarten and Thilo, $\text{K}_2\text{S}_3\text{O}_{10}$ may be prepared from K_2SO_4 by treatment with SO_3 . The apparatus used is shown in Fig. 342.

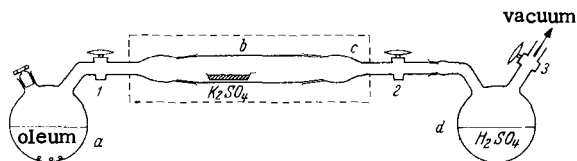
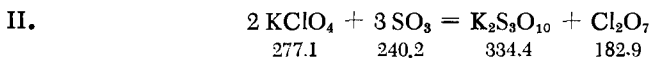

Fig. 342. Preparation of potassium trisulfate. *a* flask with oleum; *b* reactor tube, here shown surrounded by an electric tubular furnace; *d* flask with conc. H_2SO_4 ; 1-3 stopcocks. The reactor tube *c* is longer in relation to other parts of the apparatus than shown.

All parts of the glass apparatus are connected by ground joints. The joints are sealed with a paste made from 10 g. of powdered talc (preboiled several times in HCl) and 14 g. of anhydrous phosphoric acid. Stopcock plugs 1 and 2 should be of as large a

diameter as possible; stopcock 3 may be of normal size. After thorough drying of all parts of the apparatus a boat of quartz, glazed porcelain, or platinum containing finely powdered, ignited K_2SO_4 is inserted into reaction tube *b*; following this, adapter *c* and flask *d* (containing 96.5% H_2SO_4) are attached. Stopcock 1 is closed, and the section *b-d* is evacuated with an aspirator. Stopcock 3 is then closed, and the apparatus is left to dry for a while. Flask *a* is then filled with 70% oleum, a few glass beads are added, stopcock 1 is reopened, and the entire apparatus is rapidly evacuated with the aspirator, so that the oleum evolves. Stopcocks 2 and 3 are then closed. The flask containing the oleum is heated to about 110°C in a sulfuric acid bath until enough SO_3 distills and condenses in tube *b* to entirely surround the boat with the liquid. Flask *a* is then allowed to cool somewhat and stopcock 1 is closed. Tube *b* (between 1 and 2) is heated externally to 50-53°C, using a sheet iron heating trough lined with asbestos, and covering the top with asbestos. The trough is heated with a row burner, while the stopcocks and flasks are insulated with asbestos to prevent heating. The 50-53°C temperature desired is measured in the space between the reactor tube and the trough. Alternatively, an electric furnace may be used, as shown in the figure.

In the next two hours, the K_2SO_4 will sinter, become a slurry and finally convert to a clear liquid. If the quantity of SO_3 present is insufficient, the melt may resolidify. At the end of the reaction, stopcock 2 is reopened, flask *d* is cooled in ice, and the excess SO_3 is distilled onto the cooled H_2SO_4 , first at room temperature and finally by heating the reaction tube two hours at 100°C. The apparatus is allowed to cool and stopcock 3 is opened; little or no fuming should then occur.



According to Lehmann and Krüger, the reaction of SO_3 with $KClO_4$ produces potassium trisulfate and Cl_2O_7 ; the latter dissolves in the excess SO_3 . The residue obtained on vacuum evaporation of the excess SO_3 and the Cl_2O_7 is chlorine-free, stoichiometric $K_2S_3O_{10}$.

Extremely dry, fine $KClO_4$ powder, free of reducing impurities, is placed in the apparatus of Baumgarten and Thilo shown in Fig. 342 and treated with SO_2 -free SO_3 at 25-30°C until the contents of the boat become completely liquid. Excess SO_3 and Cl_2O_7 are then absorbed in conc. H_2SO_4 at room temperature, while vacuum is applied at 3.

PROPERTIES:

According to recent studies, $K_2S_3O_{10}$ is thermally stable up to 110°C. Above this temperature the vapor pressure of SO_3 begins

to increase and the compound decomposes into potassium pyrosulfate and SO_3 . The $\text{K}_2\text{S}_3\text{O}_{10}$ prepared by the method of Baumgarten and Thilo is a cake which can readily be ground to a fine powder. It absorbs water from the air and converts to an adduct of sulfuric acid and pyrosulfate or hydrogen sulfate. It decomposes immediately (with fizzing) in cold water; in the first stage of decomposition, only 1 mole of SO_3 is evolved and a pyrosulfate of relatively poor solubility is formed.

REFERENCES:

- P. Baumgarten and E. Thilo. Ber. dtsh. chem. Ges. 71, 2596 (1938); H. A. Lehmann and G. Krüger. Z. anorg. allg. Chem. 274, 141 (1973); H. A. Lehmann and A. Kluge. Ibid. 264, 120 (1951).

HETERPOLY COMPOUNDS

12-Tungstic Acid-1-Borates

In keeping with their constitution and molecular weight, these compounds should be regarded as salts of 12-tungstic-1-boric acid $\text{H}_5[\text{BO}_4(\text{W}_3\text{O}_9)_4 \cdot \text{aq.}]$ [R. Signer and H. Gross, Helv. Chim. Acta 17, 1076 (1934)].

The Free Acid $\text{B}_2\text{O}_3 \cdot 24\text{WO}_3 \cdot \text{aq.}$

The first step involves the preparation of a solution of $5 \text{Na}_2\text{O} \cdot \text{B}_2\text{O}_3 \cdot 24 \text{WO}_3 \cdot \text{aq.}$ from $\text{Na}_2\text{WO}_4 \cdot \text{aq.}$ and H_3BO_3 . A large excess of boric acid is used to bind the alkali of the Na_2WO_4 and to ensure that the solution remains acidic. The acid can be isolated from the solution of the sodium salt by addition of ether and sulfuric acid according to the method of Drechsel (see p. 1700 f.).

A solution of 100 g. of $\text{Na}_2\text{WO}_4 \cdot 2 \text{H}_2\text{O}$ and 150 g. of H_3BO_3 is prepared in 400-500 ml. of boiling H_2O . The solution is boiled until a sample deposits no tungstic acid when dil. HCl is added. The solution is cooled, suction-filtered to remove the boric acid and sodium polyborate crystals, reacted again with 70 g. of H_3BO_3 , and concentrated over a free flame. The crystalline mass which separates on cooling is again filtered off and washed with some 33% H_2SO_4 . The mother liquor, which contains $5 \text{Na}_2\text{O} \cdot \text{B}_2\text{O}_3 \cdot 24 \text{WO}_3 \cdot \text{aq.}$, is extracted with 2-3 volumes of 33% H_2SO_4 and ether according to the method of Drechsel. For further workup see p. 1701.

PROPERTIES:

Formula weight 5634.3. Two forms:

a) Perfectly clear octahedral crystals, initially bright but acquiring a greasy luster and a yellowish cast on storage; otherwise, can be stored for a long time. Water content: 65 or 66 moles of H_2O /mole. M.p. 45-51°C. Soluble in water.

b) Hexagonal needles, less stable, more apt to become yellow and cloudy. Water content: 53 moles of H_2O /mole. Soluble in H_2O . The m.p. cannot be determined, since heating causes decomposition. These crystals were formerly thought to be those of an isoborotungstic acid.

REFERENCE:

A. Rosenheim and J. Jaenicke. Z. anorg. Chem. 77, 244 (1912); 101, 236 (1917).

The Sodium Salt $5Na_2O \cdot B_2O_3 \cdot 24WO_3 \cdot aq.$

The crystalline sodium salt is best prepared from the free acid by addition of the stoichiometric quantity of Na_2CO_3 .

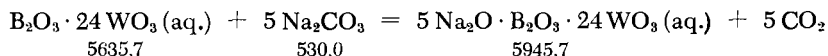

A solution containing 34.4 g. of free 12-tungstic-1-boric acid (equivalent to about 41.6 g. of the hydrated acid) is reacted with 3.1 g. of anhydrous Na_2CO_3 , and concentrated first on a steam bath and then in a desiccator over conc. H_2SO_4 .

PROPERTIES:

White, well-formed octahedra. Soluble in H_2O . Water content: 58 moles of H_2O /mole.

REFERENCE:

A. Rosenheim and H. Schwer. Z. anorg. Chem. 89, 236 (1914).

12-Tungstic Acid-1-Silicates

In view of their structure and molecular weight, all compounds of this type should be considered as salts of 12-tungstic-1-silicic acid $H_4[SiO_4(W_3O_9)_4 \cdot aq.]$ [R. Signer and H. Gross, Helv. Chim. Acta 17, 1076 (1934)].

The Free Acid $\text{SiO}_2 \cdot 12\text{WO}_3 \cdot \text{aq.}$

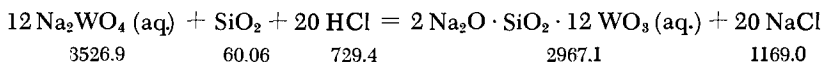

The free acid is isolated from a solution of $2 \text{Na}_2\text{O} \cdot \text{SiO}_2 \cdot 12 \text{WO}_3 \cdot \text{aq.}$ by the method of Drechsel, that is, extraction with ether and conc. HCl.

A solution of 50 g. of $\text{Na}_2\text{WO}_4 \cdot 2 \text{H}_2\text{O}$ in 400 ml. of cold H_2O is prepared. It is then treated by dropwise addition of about 27 ml. of 6N HCl, until neutral to litmus. The white precipitate formed during the addition redissolves on swirling the flask. An excess of freshly precipitated silicic acid hydrate is now added to the solution. (The silicic acid is prepared as follows. Commercial sodium silicate is dissolved in a minimum of cold H_2O and made neutral to litmus by dropwise addition of conc. HCl. After 15 minutes a small excess of acid is added. The solution is decanted and the precipitate is washed once or twice with cold water, which is likewise decanted.)

The mixture of tungstate and silicic acid is boiled for about two hours (the liquid being kept acidic by periodic addition of small amounts of HCl) until a filtered sample of the solution no longer precipitates tungstic acid hydrate on addition of dil. HCl. The solution is filtered to remove undissolved SiO_2 and shaken with ether and conc. HCl. For further workup, see p. 1701. If the free acid is to be used only as starting material for preparation of a salt, the oily adduct may be decomposed at about 40°C , the ether removed by long heating, and the excess hydrochloric acid removed by drawing air through the slowly solidifying residue. The yield is 27 g.; the product is not completely pure.

PROPERTIES:

Formula weight 2842.4. The acid crystallizes at room temperature in colorless, lustrous octahedra; m.p. 53°C . Water content: 32 moles of H_2O /mole. Readily soluble in H_2O . Several different crystalline hydrates exist, one of which is denoted the "iso acid."

REFERENCE:

- A. Rosenheim and J. Jaenicke. *Z. anorg. allg. Chem.* 101, 240 (1917). Checked by the present authors.

The Potassium Salt $2\text{K}_2\text{O} \cdot \text{SiO}_2 \cdot 12\text{WO}_3 \cdot \text{aq.}$

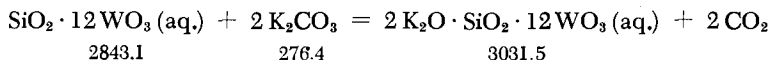

An aqueous solution of the free acid (about one part by weight of acid to three or four parts of H_2O), whose content is determined

by evaporation and ignition of an aliquot, is treated by slow addition of the stoichiometric quantity of solid K_2CO_3 (two moles of K_2CO_3 per mole of acid) while applying heat. The clear solution, which must retain an acidic reaction, is evaporated on a steam bath to 1/2 to 1/4 its volume. Cooling precipitates $2 K_2O \cdot SiO_2 \cdot 12 WO_3 \cdot aq.$, first in hexagonal prisms and then also as rhombic crystals. The product is recrystallized from hot H_2O .

PROPERTIES:

The hexagonal, colorless prisms effloresce easily. Water content: 18 moles of H_2O /mole. Readily soluble in hot H_2O , somewhat less so in cold. The rhombic crystals are said to be the salt of the so-called "iso acid"; they do not effloresce so rapidly. Water content: 9 moles of H_2O /mole.

REFERENCE:

- A. Rosenheim and J. Jaenicke. *Z. anorg. allg. Chem.* 101, 243 (1917). Checked by the present authors.

10-Tungstic Acid-1-Silicates

The Potassium Salt $7K_2O \cdot 2SiO_2 \cdot 20WO_3 \cdot aq.$

This salt is obtained by careful decomposition of a 12-tungstic acid-1-silicate with K_2CO_3 .

A solution of 8 g. of $2 K_2O \cdot SiO_2 \cdot 12 WO_3 \cdot aq.$ in a minimum of H_2O is prepared at room temperature and treated carefully (no heating) with a fairly conc. solution of K_2CO_3 in H_2O (2 moles of $K_2CO_3 = 276.4$ g. per mole of $2 K_2O \cdot SiO_2 \cdot 12 WO_3$; one mole of the compounds containing 18 or 9 moles of H_2O /mole weight 3355.8 or 3193.6 g., respectively). At this point, the solution gives a neutral reaction, and the desired potassium salt crystallizes out immediately with no need for further concentration. The salt is washed with some cold water. Yield: 4.5 g.

PROPERTIES:

Formula weight 5416.78. Sparkling crystals. Water content: 23 moles of H_2O /mole.

REFERENCE:

- F. Kehrman. *Z. anorg. Chem.* 39, 103 (1904). Checked by the present authors.

12-Tungstic Acid-1-Phosphates

In keeping with their molecular weight and constitution, these compounds should be regarded as derivatives of a 12-tungstic-1-phosphoric acid $H_3[PO_4(W_3O_9)_4 \cdot aq.]$ [J. F. Keggin, Proc. Roy. Soc. A 144, 75 (1934)].

The Sodium Salt $3Na_2O \cdot P_2O_5 \cdot 24WO_3 \cdot aq.$

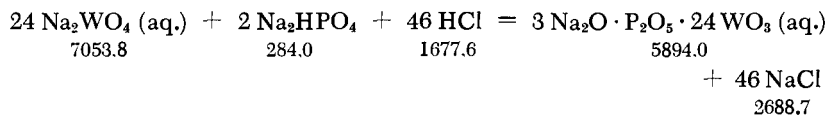

A solution of 50 g. of $Na_2WO_4 \cdot 2 H_2O$ and 25 g. of $Na_2HPO_4 \cdot 12 H_2O$ in 80 ml. of H_2O is evaporated until a surface skin of crystals forms; then 75 ml. of 24% HCl (d 1.12) is added with stirring. A precipitate forms momentarily, but then redissolves completely. The solution is reevaporated on a steam bath until a crystal skin begins to form. The product is recrystallized from H_2O .

PROPERTIES:

Large colorless (sometimes slightly greenish) columnar crystals. Water content: 30 moles of H_2O /mole. Another hydrate also exists. Soluble in H_2O .

REFERENCE:

A. Rosenheim and J. Jaenicke. Z. anorg. allg. Chem. 101, 251 (1917). Checked by the present author.

The Free Acid $P_2O_5 \cdot 24WO_3 \cdot aq.$

This salt is obtained by Drechsel's method (p. 1700), that is, by extracting a solution of $3 Na_2O \cdot P_2O_5 \cdot 24 WO_3 \cdot aq.$ with ether and conc. HCl. Light yellow or greenish crystals precipitate. However, if the starting sodium salt is first recrystallized once or twice, the product consists of transparent, colorless crystals.

This acid is also prepared very readily by ion exchange (see p. 1701). The starting solution contains 20 g. of $3 Na_2O \cdot P_2O_5 \cdot 24 WO_3 \cdot aq.$ in 100 ml. of H_2O . The colorless eluate is concentrated in a vacuum desiccator. Yield: 11 g.

PROPERTIES:

Formula weight 5706.59. The colored crystals disintegrate, often even in a few hours, to a crystalline powder; the colorless

crystals may often be kept for months. Large, lustrous octahedra, soluble in H_2O . Water content: 63 moles of H_2O /mole. This hydrate readily converts to a hydrate with 51 moles of H_2O /mole, which forms trigonal crystals and begins to melt at $89^\circ C$. It loses its water of crystallization in a vacuum desiccator over H_2SO_4 .

REFERENCES:

- A. Rosenheim and J. Jaenicke. *Z. anorg. allg. Chem.* 101, 251 (1917); G. Jander and D. Ertel, unpublished experiments.

The Potassium Salt $3K_2O \cdot P_2O_5 \cdot 24WO_3 \cdot aq.$

The Ammonium Salt $3(NH_4)_2O \cdot P_2O_5 \cdot 24WO_3 \cdot aq.$

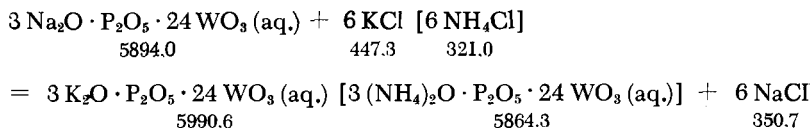

A solution of the free acid $P_2O_5 \cdot 24 WO_3 \cdot aq.$ or the sodium salt $3 Na_2O \cdot P_2O_5 \cdot 24 WO_3 \cdot aq.$ is treated with KCl or NH_4Cl . A thick white precipitate forms, even if the solutions are very dilute and contain free mineral acids.

PROPERTIES:

Microcrystalline white precipitates, which filter with difficulty. Very poor solubility in H_2O .

REFERENCE:

- F. Kehrman and M. Freinkel. *Ber. dtsch. chem. Ges.* 24, 2326 (1891). Checked by the present authors.

The Barium Salt $3BaO \cdot P_2O_5 \cdot 24WO_3 \cdot aq.$

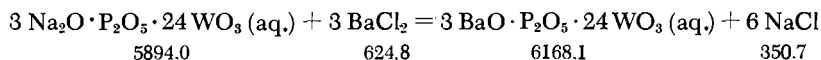

A saturated solution of 14 g. of $3 Na_2O \cdot P_2O_5 \cdot 24 WO_3 \cdot aq.$ is mixed, while hot, with 60 ml. of hot, saturated $BaCl_2$ solution. The liquid becomes cloudy, and a heavy, white crystalline precipitate forms on cooling. Concentration of the mother liquor (not too far) gives a second fraction of the desired barium salt. Yield: about 7 g.

PROPERTIES:

Well-formed, regular, colorless octahedra, which effloresce in air. Water content: 58 moles of H_2O /mole. Moderately soluble in H_2O .

REFERENCE:

F. Kehrman and M. Freinkel. Ber. dtsh. chem. Ges. 24, 2326 (1891). Checked by the present authors.

22-Tungstic Acid-2-Phosphates

The Potassium Salt $7K_2O \cdot P_2O_5 \cdot 22WO_3 \cdot aq.$

Produced by careful decomposition of a 12-tungstic acid-1-phosphate with K_2CO_3 .

An approximately 30% suspension of $3K_2O \cdot P_2O_5 \cdot 24WO_3 \cdot aq.$ in water is heated to boiling and treated with about 10% K_2CO_3 solution until solution is complete. Excess K_2CO_3 should be avoided. The solution, which then has a neutral reaction, is evaporated on the steam bath. On cooling, $7K_2O \cdot P_2O_5 \cdot 22WO_3 \cdot aq.$ separates out. It may be recrystallized from H_2O which contains some acetic acid.

PROPERTIES:

Formula weight 5902.3. Large, octahedral crystals, partially present as spearlike aggregates, accompanied by a fine powder. Soluble in hot water, less so in cold. Decomposes in the presence of free mineral acid (see next preparation).

REFERENCES:

F. Kehrman. Z. anorg. Chem. 1, 435 (1892); P. Souchay. Ann. Chimie [12] 2, 204 (1947). Checked by the present authors.

21-Tungstic Acid-2-Phosphates

The Potassium Salt $3K_2O \cdot P_2O_5 \cdot 21WO_3 \cdot aq.$

Produced from $7K_2O \cdot P_2O_5 \cdot 22WO_3 \cdot aq.$ by treatment with HCl. In addition to the desired compound, the potassium salt of 12-tungstic-1-phosphoric acid, $3K_2O \cdot P_2O_5 \cdot 24WO_3 \cdot aq.$, is also formed.

A conc. solution of $7 \text{K}_2\text{O} \cdot \text{P}_2\text{O}_5 \cdot 22 \text{WO}_3 \cdot \text{aq.}$ is prepared at the boiling point, and dilute (about 7%) HCl is added dropwise until the solution becomes acidic. An insoluble white precipitate of $3 \text{K}_2\text{O} \cdot \text{P}_2\text{O}_5 \cdot 24 \text{WO}_3 \cdot \text{aq.}$ appears. This is filtered off, and the filtrate is treated with KCl powder to salt out the desired compound. The latter is recrystallized from H_2O containing two drops of HCl.

PROPERTIES:

Formula weight 5293.6. Relatively large, lustrous, hexagonal columns, partly intergrown. Readily soluble in H_2O . The aqueous solution is unstable on boiling, depositing a white precipitate.

REFERENCES:

F. Kehrman. Z. anorg. Chem. 1, 436 (1892); P. Souchay. Ann. Chimie [12] 2, 204 (1947). Checked by the present authors.

18-Tungstic Acid-2-Phosphates

Based on molecular weight determinations, these compounds should be regarded as salts of an 18-tungstic-2-phosphoric acid $\text{H}_2[\text{(PO}_4)_2(\text{W}_3\text{O}_9)_3 \cdot \text{aq.}]$ [G. Jander and F. Exner, Z. phys. Chem. (A) 190, 195 (1942)].

The Ammonium Salt $3(\text{NH}_4)_2\text{O} \cdot \text{P}_2\text{O}_5 \cdot 18 \text{WO}_3 \cdot \text{aq.}$

A solution of $\text{Na}_2\text{WO}_4 \cdot \text{aq.}$ is boiled for a long time with a large excess of phosphoric acid. This involves an apparently slow condensation reaction. The resulting solution of the sodium salt of 18-tungstic-1-phosphoric acid is treated with solid NH_4Cl to salt out the ammonium salt.

One mole of $\text{Na}_2\text{WO}_4 \cdot 2 \text{H}_2\text{O}$ is dissolved in hot H_2O and treated with four moles of phosphoric acid (in the form of a conc. solution, d 1.17) and about 100 ml. of additional H_2O . The yellow solution is boiled for 3-5 hours while stirring and replacing the water lost by evaporation; the boiling point is 108°C . To remove any reduction products which may have formed, a few drops of nitric acid are added at the end. As the solution cools, solid NH_4Cl is added until the desired ammonium salt $3(\text{NH}_4)_2\text{O} \cdot \text{P}_2\text{O}_5 \cdot 18 \text{WO}_3$ is completely precipitated and the solution becomes colorless. The salt is filtered out, redissolved in hot H_2O , and reprecipitated with conc. NH_4Cl solution. It is then filtered out again, washed and recrystallized twice from water; the first crystal fraction is discarded each time. An analytically pure preparation is thus obtained.

SYNONYM:

Ammonium luteophosphotungstate.

PROPERTIES:

Formula weight 4471.7. Lemon-yellow or pale yellow-green triclinic crystals. Water content: 14 moles of H_2O /mole. Soluble in H_2O .

REFERENCES:

F. Kehrman, Z. anorg. Chem. 1, 432 (1892); Ber. dtsch. chem. Ges. 20, 1808 (1887); G. Jander and H. Banthien. Z. anorg. allg. Chem. 229, 142 (1936).

The Free Acid $P_2O_5 \cdot 18WO_3 \cdot aq.$

Obtained by the method of Drechsel (see p. 1700 f.) from the solution of the sodium salt described in the previous preparation.

It can also be prepared by ion exchange (cf. p. 1701), using a solution of 10 g. of $3(NH_4)_2O \cdot P_2O_5 \cdot 18WO_3 \cdot aq.$ in 50 ml. of H_2O . The eluate is clear and pale yellow-green. It is concentrated in a vacuum desiccator. Yield: 9 g.

SYNONYM:

Luteophosphotungstic acid.

PROPERTIES:

Formula weight 4315.4. M.p. $28^\circ C$. Lemon-yellow hexagonal tablets. Water content: 42 moles of H_2O /mole. Readily soluble in H_2O .

REFERENCES:

A. Rosenheim and J. Jaenicke. Z. anorg. allg. Chem. 101, 261 (1917); G. Jander and F. Exner. Z. phys. Chem. (A) 190, 195 (1942); G. Jander and D. Ertel. Unpublished experiments.

12-Tungstic Acid-1-Arsenates

By analogy with the 12-tungstic acid-1-phosphates, compounds of this class should be regarded as salts of a 12-tungstic-1-arsenic acid $H_3[AsO_4(W_3O_9)_4 \cdot aq.]$ [J. W. Illingworth and J. F. Kegg, J. Chem. Soc. (London) 1935, 575].

All tungstic acid arsenates resemble closely the tungstic acid phosphates in their manner of preparation and their behavior. They are only a little less stable.

The Ammonium Salt $3(\text{NH}_4)_2\text{O} \cdot \text{As}_2\text{O}_5 \cdot 24\text{WO}_3 \cdot \text{aq.}$

Obtained by addition of NH_4Cl to a solution of the corresponding sodium salt $3\text{Na}_2\text{O} \cdot \text{As}_2\text{O}_5 \cdot 24\text{WO}_3 \cdot \text{aq.}$, which is not known to exist as a solid.

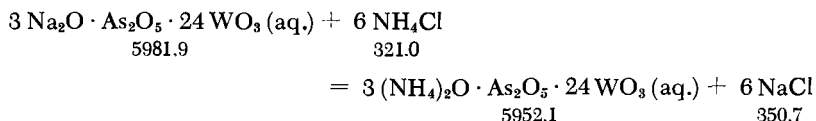

A solution of 52.8 g. of $\text{Na}_2\text{WO}_4 \cdot 2\text{H}_2\text{O}$ is prepared by heating a mixture of the salt and sufficient water to make the final volume 90 ml. A second solution is prepared from 2.3 g. of As_2O_5 and 15 ml. of very concentrated aqueous NaOH , and is then diluted with water to a final volume of 70 ml. After cooling, both solutions are combined and treated with conc. HCl until the mixture is strongly acid (pH paper). This requires 15-20 ml. of conc. HCl . The resulting mixture is unstable; on long standing, a white sediment is formed. Therefore 21 g. of solid NH_4Cl is added immediately; the mixture is heated once to boiling and allowed to stand for two hours on a steam bath. The white precipitate is filtered out, washed first with NH_4Cl solution acidified with HCl and then with some cold H_2O , and dried in a desiccator.

PROPERTIES:

Fine white, crystalline precipitate. Water content: 12 moles of H_2O /mole. Relatively sparingly soluble in H_2O .

REFERENCES:

F. Kehrman, *Z. anorg. Chem.* **22**, 286 (1900); A. Rosenheim and J. Jaenicke, *Z. anorg. allg. Chem.* **101**, 268 (1917). Checked by the present authors.

18-Tungstic Acid-2-Arsenates

These compounds are exactly the same in appearance and water content as the 18-tungstic acid-2-phosphates. The ammonium salt and the free acid are obtained by methods used for those compounds (see p. 1723), using arsenic acid instead of phosphoric.

Formula weights: $\text{As}_2\text{O}_5 \cdot 18 \text{WO}_3 \cdot \text{aq.}$: 4404.4; $3 (\text{NH}_4)_2\text{O} \cdot \text{As}_2\text{O}_5 \cdot 18 \text{WO}_3 \cdot \text{aq.}$: 4560.6.

REFERENCES:

F. Kehrman, Z. anorg. Chem. 22, 290 (1900); A. Rosenheim and J. Jaenicke, Z. anorg. allg. Chem. 101, 270 (1917).

6-Tungstic Acid-1-Tellurates

In keeping with their molecular weight, these compounds should be considered 6-tungstic acid-1-tellurates (salts of a 6-tungstic-1-telluric acid $\text{H}_6[\text{TeO}_6 \cdot 6 \text{WO}_3 \cdot \text{aq.}]$) [G. Jander and K. F. Jahr, Kolloid-Beihefte 41, 308 (1935)].

The Guanidinium Salt $3(\text{CN}_3\text{H}_6)_2\text{O} \cdot \text{TeO}_3 \cdot 6 \text{WO}_3 \cdot \text{aq.}$

Tungsten (VI) oxide is dissolved in guanidinium carbonate, HCl is added to ensure the level of acidity required for the formation of a heteropoly compound, and the required quantity of telluric acid is introduced.

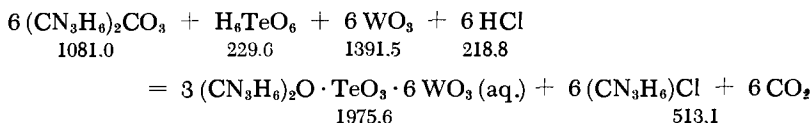

A boiling aqueous solution of 0.06 moles of guanidinium carbonate is gradually treated (stirring) with 0.06 moles of fine yellow tungstic acid powder (not too strongly ignited). The tungstic acid dissolves. The solution is filtered, and 0.06 moles of HCl is added to the clear filtrate. The nascent precipitate is redissolved by addition of hot H_2O . Then, 0.01 moles of telluric acid is added. On cooling, the desired salt crystallizes out. It is recrystallized from hot H_2O .

PROPERTIES:

Pure white, well-formed platelike crystals. Relatively poor solubility in H_2O . Water content: 3 moles of H_2O /mole.

REFERENCE:

R. Häberle, Thesis, Univ. of Berlin, 1911.

Metatungstates, Dodecatungstates

In keeping with their molecular weight and structure, these compounds should be considered salts of a dodecatungstic acid $H_2[H_2O_4(W_3O_9)_4 \cdot aq.]$ [see, for example, G. Jander, Z. phys. Chem. (A) 187, 149 (1940); R. Signer and H. Gross, Helv. Chim. Acta 17, 1076 (1934); G. Schott and C. Harzdorf, Z. anorg. allg. Chem. 288, 15 (1956)]. P. Souchay [Ann. Chim. (11) 18, 1; 169 (1943)] terms the product obtained by acidification of a monotungstate a ψ -metatungstate. These compounds are hexatungstates; and also differ chemically from the "true" metatungstates, but they are not identical with the "paratungstates." [See G. Jander and U. Krüerke, Z. anorg. allg. Chem. 265, 244 (1951).]

The Sodium Salt $Na_2O \cdot 4WO_3 \cdot aq.$

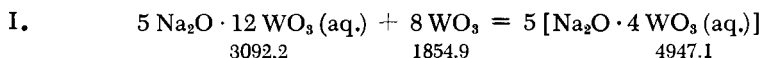

A dilute solution of "sodium paratungstate" $5 Na_2O \cdot 12 WO_3 \cdot aq.$ is boiled with an excess of yellow tungstic acid hydrate until a filtered sample no longer gives a precipitate of tungstic acid when treated with dil. HCl. The solution is then filtered to remove the excess tungstic acid and the insoluble white products formed during boiling. The filtrate is concentrated somewhat on a steam bath and allowed to crystallize in a desiccator over H_2SO_4 .

II. The salt may be prepared more simply as follows:

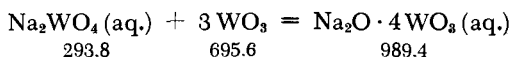

A solution of 20 g. of $Na_2WO_4 \cdot 2 H_2O$ in 200 ml. of H_2O is prepared and an excess of yellow tungstic acid is added to it in portions. The suspension is boiled for about 1.5 hours, which produces white insoluble precipitates, settling out together with the excess tungstic acid. The pH of the solution after boiling and filtration is about 3. It is concentrated as described above.

SYNONYM:

Sodium metatungstate.

PROPERTIES:

Colorless tetragonal bipyramids. Water content: 10 moles of H_2O /mole. The crystals effloresce easily, and lose almost all their water over H_2SO_4 . Readily soluble in H_2O .

REFERENCES:

- I. C. Scheibler. J. prakt. Chem. 83, 301 (1861).
 II. Authors' experiments.

The Silver Salt $\text{Ag}_2\text{O} \cdot 4\text{WO}_3 \cdot \text{aq.}$

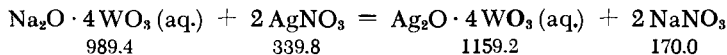

A solution of "sodium metatungstate" $\text{Na}_2\text{O} \cdot 4\text{WO}_3 \cdot \text{aq.}$ is allowed to react with a solution containing the equivalent quantity of AgNO_3 . A white precipitate slowly crystallizes out.

PROPERTIES:

Small white scales. Water content: 3 moles of H_2O /mole. Quite insoluble in H_2O .

REFERENCE:

A. Rosenheim and F. Kohn. Z. anorg. Chem. 69, 250 (1911).

The Free Acid $\text{H}_2\text{O} \cdot 4\text{WO}_3 \cdot \text{aq.}$

The free acid may be isolated from a solution of $\text{Na}_2\text{O} \cdot 4\text{WO}_3 \cdot \text{aq.}$ (see above for preparation) by Drechsel's method (see p. 1700 f.). The oily ether addition product is best distributed onto several watch glasses, which are then placed in a fast stream of dry air. The product is then rapidly dried by pressing on clay plates. This affords a relatively stable preparation, which is soluble in H_2O , forming a clear solution. Some preparations convert to yellow tungstic acid in only a few days.

Better results are obtained if the acid is prepared by ion exchange (see p. 1701) from crystalline "sodium metatungstate." A solution of 20 g. of the sodium salt $\text{Na}_2\text{O} \cdot 4\text{WO}_3 \cdot \text{aq.}$ in 50 ml. of H_2O is used. The clear eluate does not hydrolyze when concentrated in a vacuum desiccator. White crystals. Yield: 18 g.

PROPERTIES:

Formula weight 945.5. Large octahedra; according to some authors, also rhombohedra or bipyramids; readily effloresce in air. Water content: 8 moles of H_2O /mole; some authors report deviation from this value. Readily soluble in H_2O . Dilute solutions may be kept in the cold for extended periods of time, but coagulation occurs on heating. Concentrated solutions often coagulate

even at moderately high temperatures. Because of its constitution and chemical behavior, this acid should be considered a heteropoly compound.

REFERENCES

- A. Rosenheim and F. Kohn. *Z. anorg. Chem.* **69**, 253 (1911); G. Jander and D. Ertel. Unpublished experiments.

12-Molybdic Acid-1-Silicates

In keeping with their constitution, all compounds of this composition are salts of a 12-molybdic-1-silicic acid $H_4[SiO_4(Mo_3O_9)_4 \cdot aq.]$ [J. W. Illingworth and J. F. Keggin, *J. Chem. Soc. (London)* **1935**, 575].

The Sodium Salt $2Na_2O \cdot SiO_2 \cdot 12MoO_3 \cdot aq.$

The procedure given below affords a nitric acid-soluble solution of the sodium salt, which is the starting material for the preparation of the rubidium or cesium salts. Since this solution of the sodium salt also contains a very large quantity of $NaNO_3$, it cannot be used directly for the preparation of the crystalline sodium salt or the free acid (by Drechsel's method).

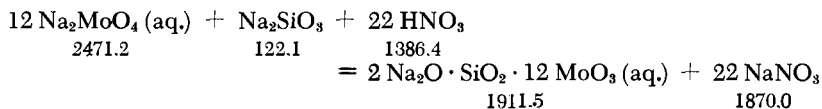

Solid NaOH (60 g.) is dissolved in 400 ml. of boiling H_2O and a total of 172 g. of MoO_3 (free of ammonium salt) is added in portions during the course of 10-15 min. When this is completely dissolved, boiling is interrupted and 500 ml. of cold H_2O is poured in. Then 250 ml. of HNO_3 (d 1.39) is made up to 350 ml. with water, and portions of this are rapidly added to the molybdate with constant stirring. No appreciable amount of precipitate should form. The sodium silicate solution described below is added immediately in a thin stream and with constant stirring.

The sodium silicate solution is made by dissolving 28 g. of commercial crystalline $Na_2SiO_3 \cdot 9 H_2O$ in 125 ml. of 2N NaOH and boiling 10-15 minutes to effect conversion to the monosilicate.

The solution of $2 Na_2O \cdot SiO_2 \cdot 12 MoO_3$ is intensely yellow and is not as stable as solutions of other heteropolysalts. It is therefore advisable to maintain the conditions specified above, particularly as far as the H^+ concentration is concerned.

A solution of the sodium salt is used in the potassium industry for recovering rubidium and cesium from carnallite.

Formula weight 1911.5.

REFERENCE:

G. Jander and F. Busch. Z. anorg. allg. Chem. 187, 173 (1930).

The Rubidium Salt $2\text{Rb}_2\text{O} \cdot \text{SiO}_2 \cdot 12\text{MoO}_3 \cdot \text{aq.}$

The Cesium Salt $2\text{Cs}_2\text{O} \cdot \text{SiO}_2 \cdot 12\text{MoO}_3 \cdot \text{aq.}$

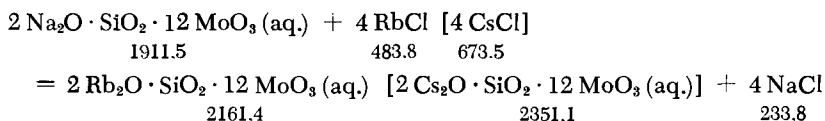

A nitric acid solution of the sodium salt described above is treated at about 65°C with a solution of RbCl or CsCl. Cooling to 40-50°C gives a fine yellow crystalline precipitate of the rubidium or cesium salt.

PROPERTIES:

Fine yellow powder. Relatively poor solubility in cold H₂O, better in hot.

REFERENCE:

G. Jander and H. Faber. Z. anorg. allg. Chem. 179, 323 (1929).

12-Molybdic Acid-1-Phosphates

In keeping with their structure, compounds of this class should be classified as salts of 12-molybdic-1-phosphoric acid H₃[PO₄(Mo₃O₉)₄ · aq.] [J. W. Illingworth and J. F. Keggin, J. Chem. Soc. (London) 1935, 575].

The Ammonium Salt $3(\text{NH}_4)_2\text{O} \cdot \text{P}_2\text{O}_5 \cdot 24\text{MoO}_3 \cdot \text{aq.}$

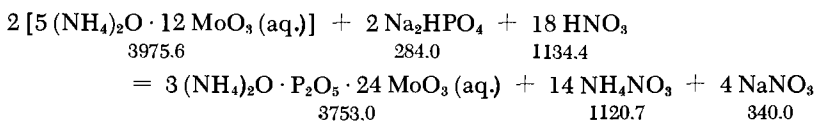

A solution of 50 g. of Na₂HPO₄ in a mixture of 300 ml. of nitric acid (d 1.48) and 300 ml. of H₂O is prepared, cooled and

mixed with a clear, cold solution of 200 g. of commercial ammonium molybdate [this generally is $5(\text{NH}_4)_2\text{O} \cdot 12\text{MoO}_3 \cdot \text{aq.}$; see p. 1711] in the minimum of H_2O ; the last solution is added in a thin stream and with stirring. A precipitate forms immediately. It is washed with hot H_2O to which a few drops of conc. HNO_3 have been added.

The ammonium salt is of value in analytical chemistry, where it is used for the determination and separation of phosphoric acid.

PROPERTIES:

Deep yellow, microcrystalline salt, soluble with great difficulty.

REFERENCE:

F. Kehrman. Z. anorg. Chem. 7, 417 (1894).

The Free Acid $\text{P}_2\text{O}_5 \cdot 24\text{MoO}_3 \cdot \text{aq.}$

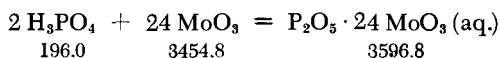

About 35 g. of MoO_3 is added in portions to a boiling solution of 6.3 g. of 25% phosphoric acid in 100 ml. of H_2O , and the boiling is continued for another 2-2.5 hours. The insolubles are removed by filtration and the yellow solution is shaken with ether to purify the crude product. It is unnecessary to add acid here. Further workup is the same as on p. 1701. Yield: about 20 g. The crystals thus obtained may be recrystallized from a small amount of hot water to which some HNO_3 has been added.

The success of the preparation depends on the availability of ammonium-free MoO_3 . Commercial MoO_3 frequently contains some ammonium ions. To purify this material, the proper quantity is dissolved in an excess of pure aqueous NaOH and the solution is boiled until NH_3 can no longer be detected. The molybdic acid is reprecipitated by careful addition of conc. HNO_3 . It is freed of HNO_3 and NaNO_3 by several decantations with water and filtered out.

PROPERTIES:

Well-formed orange-yellow octahedra. Very readily soluble in H_2O . Water content: 63 moles of H_2O /mole. Melting range 78 to 98°C. Other hydrates also exist.

REFERENCE:

A. Rosenheim and J. Jaenicke. *Z. anorg. allg. Chem.* **101**, 248 (1917). Checked by the present authors.

The Barium Salt $3\text{BaO} \cdot \text{P}_2\text{O}_5 \cdot 24\text{MoO}_3 \cdot \text{aq.}$

This salt is obtained by treatment of the free acid with BaCl_2 solution.

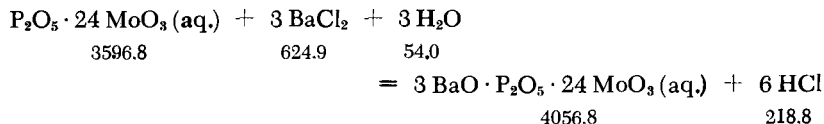

A clear conc. solution of the free acid is mixed with excess hot, saturated BaCl_2 solution. The barium salt separates at once as coarse crystals. These are filtered out and washed with small amounts of cold H_2O , then recrystallized twice from hot H_2O to which some HNO_3 has been added.

PROPERTIES:

Lemon-yellow octahedra; appreciably soluble in H_2O .

REFERENCE:

F. Kehrman. *Z. anorg. Chem.* **7**, 417 (1894). Checked by the present authors.

18-Molybdic Acid-2-Phosphates

By analogy with the 18-tungstic acid-2-phosphates, compounds of this class should be classified as salts of an 18-molybdic-2-phosphoric acid $\text{H}_6[(\text{PO}_4)_2(\text{Mo}_3\text{O}_9)_6 \cdot \text{aq.}]$.

The Free Acid $\text{P}_2\text{O}_5 \cdot 18\text{MoO}_3 \cdot \text{aq.}$

The sodium salt of 18-molybdic-2-phosphoric acid is prepared first.

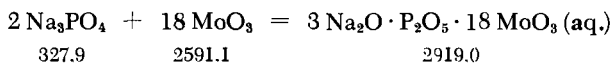

The free acid is then obtained by Drechsel's method. Since the resulting product is still contaminated with 12-molybdic-1-phosphoric acid, the pure 12-molybdic-1-phosphoric acid is prepared by addition of H_3PO_4 .

A boiling solution of Na_3PO_4 is treated with portions of MoO_3 ($\text{Na}_3\text{PO}_4:\text{MoO}_3$ mole ratio = 1:9). The solution is filtered and concentrated to a small volume. Any reduction products present are oxidized by means of some bromine water. The free acid is obtained from the solution by extraction with ether and HCl (see p. 1700 f.). The 18-molybdic-2-phosphoric acid thus prepared is never pure, but still contains rather large amounts of 12-molybdic-1-phosphoric acid. Therefore the aqueous solution of the acid is treated with sirupy phosphoric acid, the latter being added in a quantity corresponding to the amount missing in the formula. (Roughly, it may be assumed that about $1/3$ of the heteropolyacid product is still in the form of 12-molybdic-1-phosphoric acid. To convert this, two moles of H_3PO_4 are required for three moles of $\text{P}_2\text{O}_5 \cdot 24 \text{ MoO}_3 \cdot \text{aq.}$) The aqueous solution is allowed to stand until NH_4 or K salts cause no further precipitation. The free 18-molybdic-2-phosphoric acid then separates out in a vacuum desiccator over conc. H_2SO_4 .

SYNONYM:

Luteophosphomolybdic acid.

PROPERTIES:

Formula weight 2733.06. Orange-colored prisms, readily soluble in H_2O . Several hydrates exist; various water contents are reported by individual authors. Quite unstable; an aqueous solution soon reverts to 12-molybdic-1-phosphoric acid.

REFERENCE:

G. Jander and E. Drews. *Z. phys. Chem. (A)* 190, 228 (1942).

The Potassium Salt $3\text{K}_2\text{O} \cdot \text{P}_2\text{O}_5 \cdot 18\text{MoO}_3 \cdot \text{aq.}$

May be obtained from a solution of the free acid by salting out with solid KCl .

A solution of 18-molybdic-2-phosphoric acid, as concentrated as possible, is treated in the cold with KCl powder until the desired potassium salt separates as a yellow precipitate.

PROPERTIES:

Formula weight 3015.64. Orange yellow, prismatic crystals. Water content: 14 moles of H_2O /mole. Soluble in H_2O .

REFERENCE:

F. Kehrman. *Z. anorg. Chem.* 7, 147 (1894). Checked by the present authors.

12-Molybdic Acid-1-Arsenates

By analogy to the 12-molybdic acid-1-phosphates, which they very closely resemble, all compounds of this class should be classified as salts of a 12-molybdic-1-arsenic acid $H_3[AsO_4(Mo_3O_9)_4 \cdot aq.]$.

The Potassium Salt $3K_2O \cdot As_2O_5 \cdot 24MoO_3 \cdot aq.$

Commercial ammonium molybdate $5(NH_4)_2O \cdot 12MoO_3 \cdot aq.$ (see p. 1711) is heated with an excess of aqueous KOH, forming a solution of $K_2MoO_4 \cdot aq.$ Addition of HNO_3 and As_2O_3 yields the desired salt.

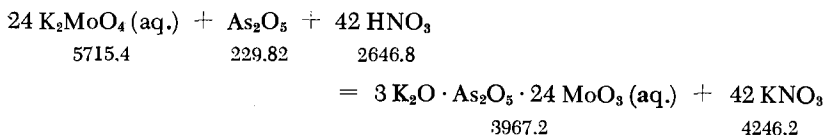

Commercial ammonium molybdate (30 g.) is heated in a porcelain dish with an aqueous solution of KOH (one part of KOH by weight to two parts of H_2O) until all NH_3 has been driven off. (An excess of KOH should be avoided, since excessive quantities of KNO_3 are then formed during the reaction; this can crystallize out under some circumstances and contaminate the product.) After cooling, the solution is diluted with 50 ml. of H_2O and slowly poured into an excess of conc. HNO_3 ; external cooling may be used if required. The solution remains clear. It becomes deep yellow on addition of the stoichiometric quantity of As_2O_5 in 50 ml. of H_2O . It is briefly heated to 60–70°C to produce a yellow precipitate, more of which appears on cooling. Yield: about 8 g. about 8 g.

PROPERTIES:

Fine, yellow crystalline powder. Water content: 12 moles of H_2O /mole. Not particularly soluble in cold water, somewhat more soluble in hot.

REFERENCE:

O. Pufahl. Thesis, Univ. of Leipzig, 1888. Checked by the present authors.

18-Molybdic Acid-2-Arsenates

By analogy with the 18-molybdic acid-2-phosphates, these compounds should probably be classified as salts of an 18-molybdic-2-arsenic acid $H_6[(AsO_4)_2(Mo_3O_9)_6 \cdot aq.]$.

The Sodium Salt $3\text{Na}_2\text{O} \cdot \text{As}_2\text{O}_5 \cdot 18\text{MoO}_3 \cdot \text{aq.}$

Since the 18-molybdic acid-2-arsenates are more stable than the 12-molybdic acid-1-arsenates, $3\text{Na}_2\text{O} \cdot \text{As}_2\text{O}_5 \cdot 18\text{MoO}_3 \cdot \text{aq.}$ is produced when a sodium arsenate solution is treated with excess MoO_3 .

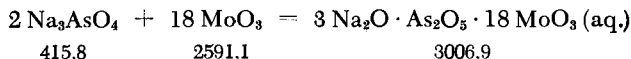

A solution of Na_3AsO_4 is saturated with MoO_3 at the boil, and boiling is continued for some time. The deep-yellow solution is then filtered and concentrated. The desired sodium salt precipitates as yellow crystals.

PROPERTIES:

Yellow monoclinic crystals. Water content: 23 or 24 moles of H_2O /mole. Soluble in H_2O .

REFERENCE:

A. Rosenheim and A. Traube. Z. anorg. allg. Chem. 91, 92 (1915).

The Free Acid $\text{As}_2\text{O}_5 \cdot 18\text{MoO}_3 \cdot \text{aq.}$

I. Drechsel's method (see p. 1700) (that is, extraction of a solution of the sodium salt with HCl and ether) is used.

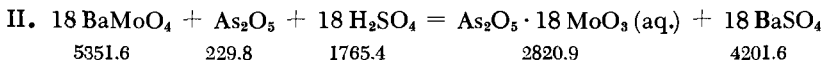

Preparation of BaMoO_4 : About 50 g. of commercial ammonium molybdate is dissolved in about 300 ml. of boiling H_2 (some ammonia is added). This solution is introduced gradually into a solution of 100 g. of $\text{Ba}(\text{OH})_2 \cdot 8\text{H}_2\text{O}$ in 300 ml. of H_2O heated on a steam bath. The mixture is heated and stirred for 2-3 hours longer. The white precipitate is washed several times with hot H_2O , then heated once more with baryta water [aqueous $\text{Ba}(\text{OH})_2$] and thoroughly washed.

The BaMoO_4 is suspended in a solution of arsenic acid so that one g.-atom of As is present per nine moles of MoO_3 . Then the Ba is precipitated by addition of the stoichiometric quantity of H_2SO_4 (mechanical stirring). The filtered yellow solution is concentrated in vacuum at about 40°C and crystallized over conc. H_2SO_4 .

PROPERTIES:

Deep-red triclinic crystals; decompose readily when stored damp. Water content: 28 moles of H_2O /mole. Quite soluble in H_2O . A yellow hydrate containing more water also exists.

REFERENCES:

- A. Rosenheim and A. Traube. *Z. anorg. allg. Chem* 91, 91 (1915);
O. Pufahl. Thesis, Univ. of Leipzig, 1888.

6-Molybdic Acid-2-Arsenates

According to molecular weight studies, the compounds of this class are salts of a 6-molybdic-2-arsenic acid $H_6[(AsO_4)_2(Mo_3O_9)_2 \cdot aq.]$ [G. Jander and E. Drews, *Z. phys. Chem. (A)* 190, 219 (1942)].

The Free Acid $As_2O_5 \cdot 6MoO_3 \cdot aq.$

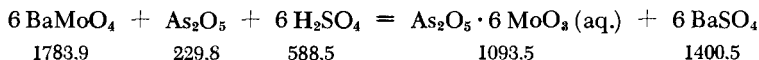

A solution of 2.6 g. of As_2O_5 in 200 ml. of boiling H_2O is prepared; the hot solution is poured onto 20 g. of $BaMoO_4$ (one g.-atom of As per three moles of MoO_3). A solution of 6.6 g. of conc. H_2SO_4 in about 20 ml. of H_2O is added, and the mixture is heated for one hour on a steam bath (stirring). The $BaSO_4$ precipitate is filtered off, and the clear (sometimes greenish) solution is concentrated in a vacuum desiccator until crystallization.

PROPERTIES:

Large, fragile, colorless crystalline scales. Water content: 18 moles of H_2O /mole. Soluble in H_2O . The compound is a strongly held, very stable complex.

REFERENCE:

- O. Pufahl. Thesis, Univ. of Leipzig, 1888. Checked by the present authors.

The Sodium Salt $Na_2O \cdot As_2O_5 \cdot 6MoO_3 \cdot aq.$

A solution of sodium paramolybdate $5 Na_2O \cdot 12 MoO_3 \cdot aq.$ is treated with the stoichiometric quantity of As_2O_5 , and the salt

is synthesized by addition of HCl. However, only half of the theoretical quantity of HCl is used, since otherwise the salt decomposes.

A solution of "sodium paramolybdate" is prepared by dissolving three moles (431.9 g.) of MoO₃ in three moles (120.0 g.) of NaOH. One mole of H₃AsO₄ is added, and the clear solution is gradually treated with one mole of HCl. The desired salt crystallizes out on concentrating the solution.

PROPERTIES:

Formula weight 1155.5. Transparent, lustrous prisms. Water content: 12 moles of H₂O/mole. Readily soluble in H₂O.

REFERENCE:

A. Rosenheim and A. Traube. Z. anorg. allg. Chem. 91, 88 (1915).

12-Molybdic Acid-2-Chromites

The Ammonium Salt 3(NH₄)₂O · Cr₂O₃ · 12MoO₃ · aq.

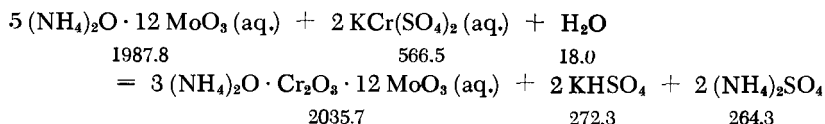

A solution of 2 g. of KCr(SO₄)₂ · 12 H₂O in 20 ml. of H₂O is heated to boiling and a solution of 30 g. of ammonium paramolybdate 5(NH₄)₂O · 12 MoO₃ · aq. in 110 ml. of H₂O is slowly added. During this operation the color of the solution changes from green to brownish and then bluish-rose. The pH of the solution should be about 5. On cooling, the desired rose-colored salt crystallizes out, although it sometimes takes 24 hours for this to occur. Yield: about 6 g.

PROPERTIES:

Relatively large, rose-colored rectangular platelets or scales. Water content: 20 moles of H₂O/mole. Quite soluble in hot H₂O, somewhat poorer solubility in cold H₂O. A relatively weak complex.

REFERENCE:

A. Rosenheim and H. Schwer. Z. anorg. allg. Chem. 89, 226 (1914).
Checked by the present authors.

6-Molybdic Acid-1-Periodates

These compounds are salts of a 6-molybdic-1-periodic acid $H_5[IO_6 \cdot 6 MoO_3 \cdot aq.]$ [G. Jander and K. F. Jahr, *Kolloid-Beihefte* 41, 305 (1935)].

The Sodium Salt $5 Na_2O \cdot I_2O_7 \cdot 12 MoO_3 \cdot aq.$

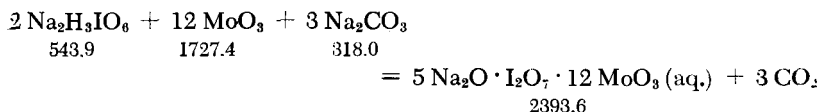

It has been found advisable to use two moles of Na_2CO_3 rather than the three moles called for by the equation.

A mixture of 10 parts by weight of $Na_2H_3IO_6$ and almost 32 parts of MoO_3 in about 120 parts of H_2O is heated. After a short time Na_2CO_3 (four parts) is added. When solution is complete, the liquid is concentrated to a small volume. Well-formed white, rhombohedral crystals appear, together with many-faceted, somewhat yellowish prisms.

PROPERTIES:

The rhombohedral crystals effloresce easily in air, becoming pure white and opaque. Water content: 34 moles of H_2O /mole. Readily soluble in H_2O .

The asymmetric, lustrous yellowish prisms do not effloresce in air. Water content: 26 moles of H_2O /mole. Soluble in H_2O .

The Free Acid $I_2O_7 \cdot 12 MoO_3 \cdot aq.$

The free acid can be prepared by ion exchange (see p. 1701). Thus, 25 g. of $5 Na_2O \cdot I_2O_7 \cdot 12 MoO_3 \cdot aq.$ is dissolved in 100 ml. of H_2O . After passage through the column, the eluate is clear and colorless. Gas evolves during concentration in a vacuum desiccator. A bright-yellow crystalline compound is obtained. Yield: 22 g.

PROPERTIES:

Bright-yellow crystals; moderately soluble in cold H_2O , readily soluble in hot.

REFERENCES:

C. W. Blomstrand, *Z. anorg. Chem.* 1, 10 (1892); G. Jander and D. Ertel. Unpublished experiments.

48. Vanadic Acid-2-Phosphates and

24. Vanadic Acid-2-Phosphates

It was concluded from chemical and physicochemical studies that the anions of these heteropolyacid compounds consist of phosphate ions and ions of octavanadic acid $H_{10}(V_8O_{25} \cdot aq.)$ in varying molecular ratios [G. Jander and K. F. Jahr, *Kolloid-Beihefte* 41, 324 (1935)]. Other authors obtained compounds which they classify as salts of a 12-vanadic-1-phosphoric acid $H_7[PV_{12}O_{36} \cdot aq.]$ [A. Rosenheim and M. Pieck, *Z. anorg. allg. Chem.* 98, 223 (1916); P. Souchay and S. Dubois, *Ann. Chimie* (12) 3, 88 (1948)].

In addition to the compounds described here, there exists an immense number of salts of other compositions. The composition of the crystalline salt depends essentially on the molar ratio of phosphoric and vanadic acids in the starting solution, and also on the H^+ concentration, the nature of the cation, and the absolute concentration.

The brownish-red heteropolyacid compounds of this class, rich in vanadic acid, are designated in the older literature as "purpureophosphovanadates."

The Sodium Salt $10Na_2O \cdot P_2O_5 \cdot 24V_2O_5 \cdot aq.$

Prepared by combining solutions of $NaVO_3$, Na_2HPO_4 and HNO_3 . Thus, the solution used is 0.75M in sodium metavanadate ($NaVO_3 \cdot aq.$), 0.315M in Na_2HPO_4 , and 1.125M in HNO_3 (these quantities do not take the reaction into account); it therefore contains 2.38 moles of vanadic acid per mole of phosphoric acid. This deep-red solution is treated with 1/5 its volume of acetone and allowed to stand in the cold. After a while, the desired salt crystallizes out.

PROPERTIES:

Formula weight 5128.5. Small, dark-red octahedral crystals. Soluble in H_2O . Like all "purpureophosphovanadates," it is quite susceptible to hydrolysis; excessive heating of the solution must be avoided.

REFERENCE:

G. Jander and K. F. Jahr. *Kolloid-Beihefte* 41, 332 (1935).

The Barium Salt $10 \text{BaO} \cdot \text{P}_2\text{O}_5 \cdot 24 \text{V}_2\text{O}_5 \cdot \text{aq.}$

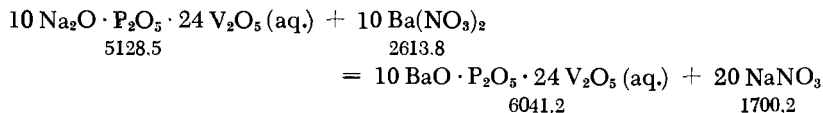

A solution prepared in the same way as described for the sodium salt (50 ml.) is treated with 100 ml. of 0.375N $\text{Ba}(\text{NO}_3)_2$ solution and about 1/5 its volume of acetone. After standing for some time, the barium salt crystallizes out.

PROPERTIES:

Deep-red cubic crystals; poor solubility in H_2O .

REFERENCE:

G. Jander and K. F. Jahr. Kolloid-Beihefte 41, 332 (1935).

The Potassium Salt $11 \text{K}_2\text{O} \cdot 2 \text{P}_2\text{O}_5 \cdot 24 \text{V}_2\text{O}_5 \cdot \text{aq.}$

The Ammonium Salt $5(\text{NH}_4)_2\text{O} \cdot 2 \text{P}_2\text{O}_5 \cdot 24 \text{V}_2\text{O}_5 \cdot \text{aq.}$

These are obtained from solutions of the sodium salt $10 \text{Na}_2\text{O} \cdot \text{P}_2\text{O}_5 \cdot 24 \text{V}_2\text{O}_5 \cdot \text{aq.}$ by means of KNO_3 or NH_4NO_3 .

The same solution as described above in the case of the sodium salt (50 ml.) is treated with 100 ml. of 0.375N KNO_3 solution or 0.375N NH_4NO_3 solution and 1/5 its volume of acetone. After standing for some time, the desired salt crystallizes out.

PROPERTIES:

Formula weight of $11 \text{K}_2\text{O} \cdot 2 \text{P}_2\text{O}_5 \cdot 24 \text{V}_2\text{O}_5$: 5685.5; formula weight of $5(\text{NH}_4)_2\text{O} \cdot 2 \text{P}_2\text{O}_5 \cdot 24 \text{V}_2\text{O}_5$: 4909.9. The potassium salt crystallizes in deep red rhombohedra, the ammonium salt in six-sided columns. Both are soluble in H_2O .

REFERENCE:

G. Jander and K. F. Jahr. Kolloid-Beihefte 41, 332 (1935).

Carbonyl and Nitrosyl Compounds

F. SEEL

General Introduction

The classical method for the preparation of Mo, Fe, Co and Ni carbonyls consists of a direct reaction of CO with the respective metal at high pressures (150-200 atm.) and temperatures (100-200°C). Under these conditions steel is generally attacked by CO with formation of $\text{Fe}(\text{CO})_5$, so that pressure vessels fully lined with a CO-resistant material (e.g., copper-silver alloy) must be used. Since such special autoclaves are not normally found in general-purpose chemical laboratories, this compilation of carbonyl syntheses will be restricted to preparative methods which are compatible with the usual laboratory apparatus, i.e., atmospheric-pressure syntheses or those requiring simple steel autoclaves.

With this goal in mind, several completely new methods were worked out { i.e., for $\text{Ni}(\text{CO})_4$, $[\text{Co}(\text{CO})_4]_2\text{Hg}$, $\text{Co}(\text{CO})_3\text{NO}$ }, while in the case of others [$\text{Fe}(\text{CO})_4\text{H}_2$, $\text{Co}(\text{CO})_4\text{H}$] the apparatus used was improved. All methods were rechecked. For this we thank especially W. Hieber and his co-workers.

Descriptions of specific autoclaves for preparation of carbonyl compounds may be found in L. Mond, *Z. anorg. Chem.* **68**, 207 (1910) and W. Hieber, H. Schulten and R. Martin, *Z. anorg. allg. Chem.* **240**, 261 (1939).

Chromium, Molybdenum, Tungsten Carbonyls

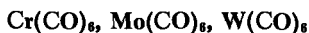

The hexacarbonyls of the chromium group are formed via reaction of CO with a suspension of anhydrous halides of Cr, Mo or W in a Grignard solution, followed by hydrolysis. The reaction mechanism has not yet been elucidated.

The reactor vessel *f* in Fig. 343 is a one-liter flask fitted with a two-hole rubber stopper. The dropping funnel *t* has a

considerably enlarged tip to prevent plugging during the reaction. It is used for the addition of the Grignard solution (via *a*), as well as that of CO (at *b*). Stopcock *h* is a gas vent which remains normally closed during the reaction but which is occasionally opened to allow flushing the reactor with CO. Flask *f* is fitted exactly into the ice bath *e*, and the whole apparatus is vigorously shaken on a machine. To monitor the CO consumption, a standardized gasometer is connected to *b* via a drying train (whose last tube is filled with P_2O_5).

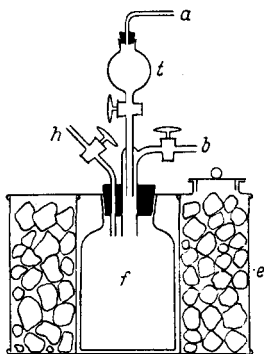

Fig. 343. Preparation of hexacarbonyls of the chromium group. *a* and *b* inlet tubes; *e* ice bath; *f* reactor vessel; *t* dropping funnel. Note that the tip of funnel *t* should be enlarged.

The reactor flask *f* is filled with nitrogen. The metal chloride (10 g. of fine anhydrous $CrCl_3$ powder; 17 g. of sublimed $MoCl_5$; or 20 g. of WCl_6 [0.05 moles]) is introduced, and the vessel is evacuated and filled with CO. A mixture of 50 ml. of anhydrous ether and 50 ml. of anhydrous benzene is added through the dropping funnel and the apparatus is then connected to the CO line.

The Grignard reagent is prepared from 12 g. (0.5 moles) of Mg, 54 g. of C_2H_5Br and approximately 300 ml. of anhydrous ether. This solution is added to the metal chloride suspension first in portions of about 5 ml. each, later dropwise. The initiation of the CO reaction as well as its progress may be observed via a wash bottle containing some conc. H_2SO_4 provided the stopcock of *t* is closed. The absorption of CO, which for reasons unknown occasionally slows down and then accelerates, is continued for about 4-6 hours after the addition of all of the Grignard reagent. The reaction absorbs on the average 7 liters and occasionally up to 9 liters of CO.

The reddish-brown reaction product is hydrolyzed by cautious addition to a mixture of ice and dilute H_2SO_4 , and the mixture is then steam-distilled without prior removal of ether and benzene. The steam distillation is continued for 3-4 hours or as long as white needles of the carbonyl product are observed in the (descending) condenser. The organic layer (benzene-ether) in the distillate is separated and the aqueous phase extracted 3-4 times with fresh ether. The combined ether extracts are concentrated by distillation, keeping the temperature below $60^\circ C$, and the residue is allowed to crystallize in a refrigerator.

The yields of crude carbonyls are quite variable; in the case of $Cr(CO)_6$ they are 2 g. maximum, while up to 3-4 g. of $W(CO)_6$ may be isolated. Higher yields of $Cr(CO)_6$ (up to 67%) are obtained in an autoclave under high CO pressure (35-70 atm.). To remove strongly adhering, odorous organic impurities, an immediate vacuum sublimation of the hexacarbonyls is recommended.

PROPERTIES:

Formula weight of $Cr(CO)_6$: 220.1; of $Mo(CO)_6$: 264.0; of $W(CO)_6$: 352.0. Colorless, strongly refractive orthorhombic crystals which are isomorphic among themselves; well soluble in inert organic solvents and sublimable. $Cr(CO)_6$ melts at $149-50^\circ C$ in a sealed tube. The hexacarbonyls are remarkably stable in comparison to all other metal carbonyls. Their vapors decompose above $120^\circ C$ in a combustion tube, depositing the metals as mirrors.

REFERENCES:

- W. Hieber and E. Romberg. *Z. anorg. allg. Chem.* **221**, 321 (1935);
B. B. Owen, J. English, Jr., H. C. Cassidy and A. V. Dundon.
J. Amer. Chem. Soc. **69**, 1723 (1947).

Iron Pentacarbonyl



Iron carbonyl is an industrial product which is prepared by classical carbonyl synthesis from CO and finely divided iron:

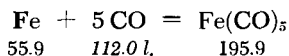

This material serves as the starting substance for work in the field of iron carbonyls; laboratory preparation is not worthwhile since it requires the special autoclaves mentioned on page 1741.

There is, however, a method for the preparation of small quantities of $\text{Fe}(\text{CO})_5$ in which a regular laboratory autoclave may be used; it starts with $\text{Fe}(\text{CO})_4\text{I}_2$ (see p. 1751):

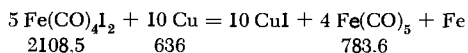

An intimate mixture of equal weights of $\text{Fe}(\text{CO})_4\text{I}_2$ and copper dust is heated in a CO stream. The initial temperature is 40°C. It is then increased to 55°C and the $\text{Fe}(\text{CO})_5$ (30% yield) is condensed in a U tube at -50°C.

If an autoclave at about 10 atm. pressure is used, the yield becomes nearly quantitative since the decomposition reaction

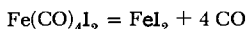

which occurs at atmospheric pressure, becomes impossible. Iron pentacarbonyl can then be distilled directly from the reaction vessel.

PROPERTIES:

At room temperature yellow, oily liquid, d^{20} 1.46. Vapor pressure equation in the range of 0 to 102.7°C.: $\log p = 7.349 - 1681/T$. At -25°C, solidifies to monoclinic needles; distills without decomposition at 102.6°C and 760 mm.; crit. temp. 285-288°C. Produces a metallic iron mirror on passage through a hot glass tube (200-350°C). Not altered in the dark; decomposed in light to $\text{Fe}_2(\text{CO})_9$ and CO (must be stored in dark bottles). Pyrophoric in air (caution!); burns to Fe_2O_3 . Nearly insoluble in water; readily soluble in many organic solvents, especially benzene, petroleum ether, ether, glacial acetic acid and acetone.

REFERENCE:

W. Hieber and H. Lagally. Z. anorg. allg. Chem. 245, 295 (1940).

Diiron Nonacarbonyl

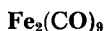

Formed during decomposition of $\text{Fe}(\text{CO})_5$ by light:

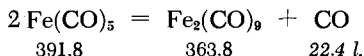

A solution of 20 g. of $\text{Fe}(\text{CO})_5$ in 40 ml. of glacial acetic acid (or acetic anhydride) is prepared and exposed to direct sunlight

in an atmosphere of hydrogen or under vacuum. Very soon, turbidity and crystallization of $\text{Fe}_2(\text{CO})_9$ are observed. The nascent CO is removed by flushing with H_2 or by reevacuation of the vessel. After several hours of illumination, the crystals are collected by filtration and washed with ethanol and ether. Minimum yield: 30% (5 g.). Further illumination of the mother liquors yields more $\text{Fe}_2(\text{CO})_9$.

PROPERTIES:

Shiny, orange hexagonal platelets; d^{18} 2.085. Nearly insoluble in ether, petroleum ether and benzene; somewhat soluble in methanol, ethanol, and acetone; more readily soluble in pyridine. Stable at room temperature in dry air; on heating to 100-120°C, decomposes according to:

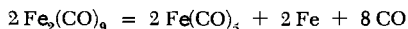

SYNONYM:

Diiron enneacarbonyl.

REFERENCE:

E. Speyer and H. Wolf. Ber. dtsch. chem. Ges. 60, 1424 (1927).

Triiron Dodecacarbonyl

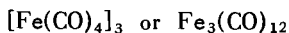

Oxidation of $\text{Fe}(\text{CO})_4\text{H}_2$ gives $\text{Fe}(\text{CO})_4$. The former may be prepared and oxidized in one consecutive process.

A) PREPARATION OF $\text{Fe}(\text{CO})_4\text{H}_2$ SOLUTION:

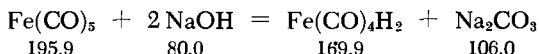

A two-liter flask is filled with N_2 . Then, 14 ml. (= 20 g.) of $\text{Fe}(\text{CO})_5$ and 60 ml. of methanol are added and agitated until a complete mixture of both liquids has been obtained. At this point, 30 ml. of 50% sodium hydroxide is added and, to avoid decomposition of the product, the mixture is cooled to 0°C. The reaction of the base with the pentacarbonyl occurs at room temperature and is completed after several minutes of shaking. Immediately after the addition of the base, the solution shows a milky turbidity due

to the formation of sodium methyl carbonate, which is only slightly soluble. Exposure to air (it is not necessary to exclude the latter completely to obtain the product) soon leads to a deep reddish-brown color.

B) OXIDATION WITH MnO_2

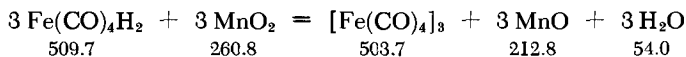

An aqueous suspension of MnO_2 , prepared from 35 g. of $\text{MnSO}_4 \cdot 7 \text{H}_2\text{O}$, 5.6 ml. of Br_2 and 20 g. of NaOH and purified by decantation, is added slowly with constant shaking to a freshly prepared solution of $\text{Fe}(\text{CO})_4\text{H}_2$. The color of the reaction mixture changes immediately to a deep green. The excess MnO_2 is dissolved by addition of FeSO_4 in sulfuric acid or of NaHSO_3 . At the end, 100 ml. of sulfuric acid (1 : 1) is added, resulting in a vigorous evolution of gas. After completion of the gas evolution, the solution is refluxed on a water bath for about 30 minutes. This coagulates the $\text{Fe}(\text{CO})_4$; because it is hydrophobic, it floats on top of the solution as a dark green, crystalline mass. The product is collected on a fritted-glass filter, washed with hot, dilute H_2SO_4 , H_2O , ethanol, and petroleum ether, and weighed in a desiccator. Yield: 90% (15-16 g.).

PROPERTIES:

Deep-green, nearly black, strongly dichroic square plates. Insoluble in water; slightly soluble (dark green color) in organic solvents such as benzene, petroleum ether, ether and acetone; more soluble in $\text{Fe}(\text{CO})_5$ and $\text{Ni}(\text{CO})_4$; in contrast to the other iron carbonyls, very sensitive to air. d^{18} 1.996; crystal structure: tetragonal.

REFERENCES:

- W. Hieber. Z. anorg. allg. Chem. 204, 171 (1932); R. B. King and F. G. A. Stone in: Inorg. Syntheses, Vol. VII, New York-London, 1963, p. 193.

Cobalt Carbonyls

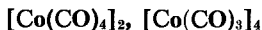

Decomposition of the hydride $\text{Co}(\text{CO})_4\text{H}$ above its melting point gives $[\text{Co}(\text{CO})_4]_2$:

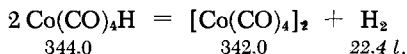

The hydride $\text{Co}(\text{CO})_4\text{H}$ (see p. 1753) is slowly evaporated under CO from a bath at an initial temperature of -30°C , which

may be left unattended. Beautiful crystals of orange-red $[\text{Co}(\text{CO})_4]_2$ remain as a residue.

Alternate method: Direct high-pressure synthesis from Co metal and CO [L. Mond, H. Hirtz and M. D. Cowap, Z. anorg. Chem. **68**, 215 (1910)].

PROPERTIES:

Orange crystals, m.p. 51°C . Insoluble in H_2O ; soluble in ethanol, ether and other organic solvents. Decomposes in air to the violet, basic Co carbonate. Melting of $\text{Co}(\text{CO})_4$ results in a very slow decomposition to cobalt tricarbonyl $[\text{Co}(\text{CO})_3]_4$; this reaction is clearly observable at 53°C and proceeds so fast at 60°C that it is complete after two days. After recrystallization from benzene, the tricarbonyl, formed according to the equation $\text{Co}(\text{CO})_4 = \text{Co}(\text{CO})_3 + \text{CO}$, consists of deep black crystals.

REFERENCE:

W. Hieber, F. Mühlbauer and E. A. Ehmman. Ber. dtsch. chem. Ges. **65**, 1090 (1932).

Nickel Carbonyl



Forms even under such mild conditions as the reaction of CO with an alkaline solution of NiS. However, the reaction of CO with a solution of nickel sulfoxylate-ammonia complex, $\text{NiSO}_2 \cdot (\text{NH}_3)_x$, is especially recommended. This solution is easily prepared from NiSO_4 , NH_3 and $\text{Na}_2\text{S}_2\text{O}_4$.

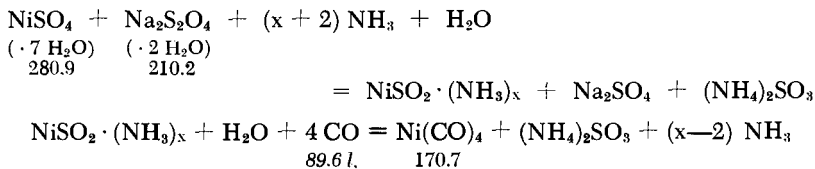

The apparatus shown in Fig. 345 comprises a large gas-liquid mixing flask to which the shaking vessel shown in Fig. 344 can be attached. This mixing flask is attached to a large U tube filled with pea-sized calcium chloride granules and P_2O_5 deposited on glass beads. This tube is in turn attached to three condensing traps, two tees with stopcocks, and a bubble counter at the end of the train. The individual parts of the apparatus may be connected

by short pieces of rubber, provided glass touches glass; however, a ground-glass connection is required at s (this allows attaching the two condensing traps k , which are fused to each other, to a vacuum line).

The mixing flask is charged with a solution of 14.0 g. (0.05 moles) of $\text{NiSO}_4 \cdot 7 \text{H}_2\text{O}$ in 400 ml. of water and 60 ml. of 25% aqueous ammonia. The carefully predried shaking vessel is charged with 12.5 g. of 80% $\text{Na}_2\text{S}_2\text{O}_4$; then 30 ml. of concentrated ammonia solution and 80 ml. of water are added under flowing nitrogen. The materials are dissolved by shaking, and the shaking vessel is attached to the mixing vessel by means of a rubber stopper, as shown in the figure. At this point CO , carefully pre-purified to remove traces of iron carbonyl and oxygen, is passed through the clear blue nickel (II) salt solution; after a few minutes, a dropwise flow of the ammonial dithionite solution is started. (Pressures must be constantly equalized.) The dithionite solution is added over a period of about 20 minutes. The $\text{Ni}(\text{CO})_4$ forms instantly and is condensed in the traps by cooling the latter with Dry Ice-acetone (or ethanol) mixture; the unreacted CO may be burned at t_2 after a reasonable flow rate has been established.

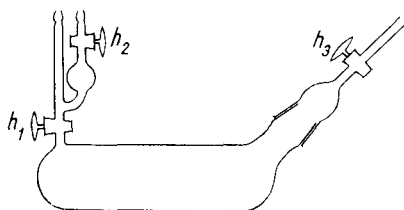

Fig. 344. Shaking vessel for work in the absence of air.

The nickel salt solution becomes nearly colorless in about 5 hours; a slight amount of decomposition, shown by the deposition of a mirrorlike layer of NiS_x on the glass walls, can not be avoided. Redistillation of the carbonyl (which condenses primarily in the first trap) in a stream of CO gives a completely pure product. Yield: 7.5 g. (5.5-6.0 ml.) of $\text{Ni}(\text{CO})_4 = 85-90\%$.

PROPERTIES:

Colorless liquid. M.p. -25°C , b.p. 43°C ; d^{20} 1.310. Crit. temp. approximately 200°C , crit. pressure 30 atm. Insoluble in water, soluble in organic solvents. Readily oxidized in air;

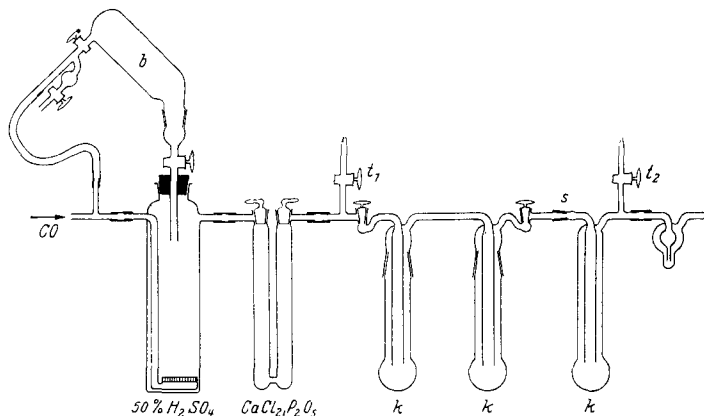

Fig. 345. Apparatus for the preparation of nickel carbonyl, carbonyl hydrides, and nitroyl carbonyls. *b* shaking vessel from Fig. 344; *k* condensing traps

burns with a luminous flame when ignited. A mixture with air is explosive. A bright Ni mirror is formed on passage through a heated tube at 180–200°C. The vapor is extraordinarily toxic.

REFERENCE:

W. Hieber, E. O. Fischer and E. Böckly. *Z. anorg. allg. Chem.* **269**, 308 (1952).

Dipyridine Chromium Tetracarbonyl,
Tripyridine Chromium Tricarbonyl

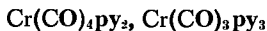

Up to one half of the CO contained in metal carbonyls can frequently be replaced by pyridine, o,o'-dipyridyl and phenanthroline.

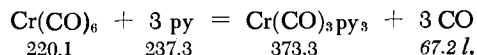
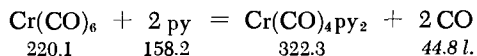

A mixture of 1 g. of $\text{Cr}(\text{CO})_6$ and 5 ml. of pure anhydrous pyridine is heated in a sealed tube for 2 hours at 200°C. A large fraction of the $\text{Cr}(\text{CO})_6$ separates unchanged on cooling the

deep-brown solution. The solution is filtered into a small distilling apparatus and most of the pyridine is quickly distilled off in a stream of N_2 . On cooling the residue, crystals of $Cr(CO)_4py_2$ separate out; addition of petroleum ether increases the yield.

If 10-15 ml. of pyridine is used in the above experiment and the heating is repeated after discharge of the CO, the product is $Cr(CO)_3py_3$. Pyridine can be substituted into $Mo(CO)_6$ more readily than into $Cr(CO)_6$; the $Mo(CO)_6$ is converted into $Mo(CO)_3py_3$ on heating with pyridine for several hours at $135^\circ C$.

PROPERTIES:

$Cr(CO)_4py_2$: Blunt, yellowish-brown prisms. On heating, loses pyridine and turns brownish-black. $Cr(CO)_3py_3$: Yellowish-red to red prisms, stable in air; gives up pyridine very readily.

REFERENCE:

W. Hieber and F. Mühlbauer. Z. anorg. allg. Chem. 221, 341 (1935).

o-Phenanthroline Nickel Dicarbonyl

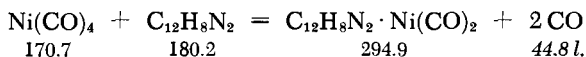
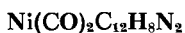

Readily formed from solutions of equimolar quantities of the components in acetone or absolute ethanol. The almost immediate CO generation is preceded by a blood-red color of the reaction mixture. As the gas evolution increases, the compound separates in long needles (of the order of 1 cm.). After suction-filtration, the compound is washed with absolute ethanol, followed by petroleum ether.

PROPERTIES:

Ruby-red needles with high luster; very stable. Decomposed by air only in the presence of moisture (slow process, accompanied by a green color).

REFERENCE:

W. Hieber, F. Mühlbauer and E. A. Ehmman. Ber. dtsch. chem. Ges. 65, 1098 (1932).

Iron Tetracarbonyl Halides



I. The simplest method consists of reacting the halogens with $\text{Fe}(\text{CO})_5$ in organic solvents.

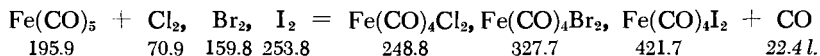

Pure $\text{Fe}(\text{CO})_4\text{Cl}_2$ can be obtained only at -20°C by slow passage of Cl_2 through a 1M solution of $\text{Fe}(\text{CO})_5$ in petroleum ether; the slight decomposition of the $\text{Fe}(\text{CO})_5$ does not affect the purity of the product. The product (yield $\sim 60\%$) is a yellow powder, which loses CO at room temperature and turns gray.

$\text{Fe}(\text{CO})_4\text{Br}_2$ is prepared by slowly adding the reactants to a 2M petroleum ether solution, while cooling in ice and conducting the reaction under anhydrous conditions. The product is a reddish-brown powder. Yield: 75%.

$\text{Fe}(\text{CO})_4\text{I}_2$ is obtained in anhydrous ether solution using a slight excess of $\text{Fe}(\text{CO})_5$ [the ether solution is 2M in $\text{Fe}(\text{CO})_5$ and 0.5M in I_2]. On evaporation, the compound separates in large, black crystals. Yield: quantitative.

PROPERTIES:

The iron carbonyl halides are light-sensitive: water converts them to the corresponding Fe (II) salt solutions (the chloride and bromide react instantaneously, the iodide only upon heating). The thermal decomposition of iron carbonyl halides is a convenient way to produce fine powders of anhydrous Fe(II) halides.

II. $\text{Fe}(\text{CO})_4\text{I}_2$ can be obtained from anhydrous FeI_2 and CO at pressures above 6.3 atm. Thus, it can be prepared in ordinary laboratory autoclaves.

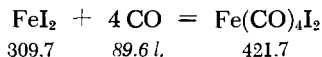

The preparation proceeds in anhydrous ethereal solution, using 50 ml. of ether/g. of FeI_2 ; the air is displaced from the autoclave by evacuating and flushing with CO (which may be taken directly from a cylinder). While the yield is quantitative, the duration of the CO absorption depends on the surface/volume ratio in the solution. Thus, in unagitated systems the reaction may occasionally take several days.

pure. It contains the products of its own decomposition, $\text{Fe}(\text{CO})_5$ and $\text{Fe}(\text{CO})_3$, and occasionally its oxidation product $\text{Fe}(\text{CO})_4$. Repeated fractionation in high vacuum at -40°C , with condensation at -80°C , is necessary for complete purification. The removal of the last traces of $\text{Fe}(\text{CO})_5$, which is frequently still present in small quantities (since it is re-formed during the distillation due to the extreme instability of the hydride), is achieved by repeated distillation into a liquid-nitrogen-cooled vessel.

Since the isolation and purification of the free carbonyl hydride require considerable time, the acid decomposition should be started at the beginning of a full working day. $\text{Fe}(\text{CO})_4\text{H}_2$ can be stored indefinitely, provided it is placed in suitable containers which are evacuated and cooled with liquid nitrogen.

PROPERTIES:

At the temperature of liquid nitrogen, a completely colorless, crystalline substance. M.p. -70°C . The autodecomposition

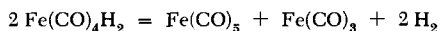

of the water-white, mobile liquid is already observed at -10° , as is indicated by a slight reddish color [$\text{Fe}(\text{CO})_3$], but is completed only at higher temperature. The presence of even traces of $\text{Fe}(\text{CO})_3$ and $\text{Fe}(\text{CO})_5$ in the hydride is indicated by a weak red or yellow color; absence of color (only below -10°C) is a sensitive test for the purity of the product. The gaseous hydride has an extremely nauseating odor.

REFERENCES:

W. Hieber and H. Vetter. *Z. anorg. allg. Chem.* **212**, 145 (1933).

An ether-soluble iron carbonyl hydride $\text{Fe}_4(\text{CO})_{13}\text{H}_2$ was isolated from the reaction of pyridine-iron carbonyl with acids [W. Hieber and R. Werner, *Chem. Ber.* **90**, 286 (1957)].

Cobalt Tetracarbonyl Hydride



An alkaline suspension of $\text{Co}(\text{OH})_2$ absorbs CO in the presence of a small amount of cyanide to form a solution of the alkali salt

of $\text{Co}(\text{CO})_4\text{H}$. The hydride is then liberated from this solution with acid.

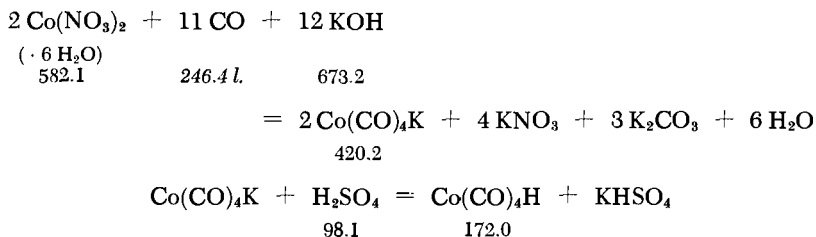

The same apparatus as is shown in Figs. 344 and 345 (see preparation of $\text{Ni}(\text{CO})_4$) is used. Since the acid decomposition of the alkaline hydride solution produces considerable foaming, a second mixing vessel, placed in series with the first one, is recommended. The evacuated shaking vessel is charged with 14.6 g. (0.05 moles) of $\text{Co}(\text{NO}_3)_2 \cdot 6 \text{H}_2\text{O}$ in 30 ml. of water, 22.4 g. of KOH in 22 ml. of water, 10 ml. of water, 3.2 g. of KCN in 6 ml. of water (in this order), and finally with 10 ml. of water. Then stopcock h_1 is connected to a gas-liquid mixing vessel equipped with a fritted disk and containing an alkaline pyrogallol solution. The vessel is connected to a calibrated gasometer containing 6 liters of CO. After flushing the inlet piece via stopcock h_2 , the gas is admitted to the shaking vessel; the latter is flushed briefly via h_3 , h_3 is closed again, and the assembly is shaken on a machine under CO pressure. The CO absorption may be observed via the pyrogallol wash bottle: it varies with the intensity of shaking and even quantitative absorption may occasionally be achieved. During the absorption, the initially brown suspension is converted into a yellow solution which, in the case of absorption of the theoretical amount of CO, is nearly free of suspended matter and consists of a solution of $\text{Co}(\text{CO})_4\text{K}$.

The free hydride is isolated in the same way as described in the preceding preparation of $\text{Fe}(\text{CO})_4\text{H}_2$. On the same scale of preparation, the acid decomposition requires 50 ml. of 50% sulfuric acid. The hydride is finally sublimed from a bath maintained at -30°C to a cooler condensing trap.

PROPERTIES:

The pure solid hydride is completely colorless and crystalline; it melts at -26.2°C to a light-yellow solution which changes to dark yellow at slightly higher temperature {beginning of decomposition to $[\text{Co}(\text{CO})_4]_2$ }. In gas form $\text{Co}(\text{CO})_4\text{H}$ has a nauseating odor and is extremely toxic.

REFERENCES:

- W. Hieber and H. Schulten. *Z. anorg. allg. Chem.* **232**, 29 (1937);
 A. A. Blanchard and P. Gilmont. *J. Amer. Chem. Soc.* **62**,
 1192 (1940).

Iron Carbonyl Mercury

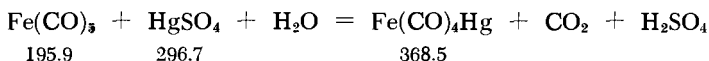

A solution of 7.5 g. (0.025 moles) of HgSO_4 in 50 ml. of 10% H_2SO_4 is shaken with 3.5 ml. (5 g.) of $\text{Fe}(\text{CO})_5$ at room temperature to yield a dark-yellow, microcrystalline precipitate of $\text{Fe}(\text{CO})_4\text{Hg}$. The precipitate is collected by filtration, washed several times with dilute H_2SO_4 , 2-3 times with 2N HCl, then with water and acetone, and dried in vacuum.

PROPERTIES:

Insoluble in common solvents. Decomposes at about 150°C into Fe, Hg and CO. Reaction of HgCl_2 with $\text{Fe}(\text{CO})_5$ gives $\text{Fe}(\text{CO})_4\text{Hg}_2\text{Cl}_2$.

REFERENCE:

- H. Hock and H. Stuhlmann. *Ber. dtsch. chem. Ges.* **61**, 2097 (1928);
62, 431 (1929).

Cobalt Carbonyl Mercury



Produced by reaction of solutions of a salt of $\text{Co}(\text{CO})_4\text{H}$ with Hg (II) salts. The optimum preparative method requires work in an ammonia solution.

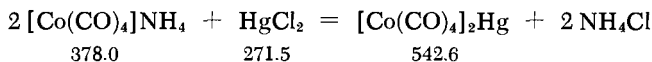

The potassium salt of $\text{Co}(\text{CO})_4\text{H}$ is prepared as described on page 1754. However, only one half the amount is needed. The shaking vessel is evacuated, and 25 ml. of a saturated NH_4Cl

solution (corresponding to about 10 g. of NH_4Cl) and 3.5 g. of HgCl_2 in 100 ml. of water are added in that order. The instantly formed ochre precipitate consists of $[\text{Co}(\text{CO})_4]_2\text{Hg}$, HgNH_2Cl and traces of Hg. The reaction flask is immediately opened; the precipitate is collected by filtration (without any special protective measures) and washed twice with water, dilute hydrochloric acid (to dissolve HgNH_2Cl) and finally again with water. The crude product is dried in a desiccator and dissolved in some acetone; water is added until persistent turbidity. The product is left in a refrigerator to crystallize.

Alternate method: Precipitation from a solution of $[\text{Co}(\text{CO})_4]\text{NH}_4$, as prepared by the dithionite method [see section on $\text{Ni}(\text{CO})_4$, p. 1747 f.] [W. Hieber, E. O. Fischer and E. Böcky, Z. anorg. alleg. Chem. 269, 308 (1952)].

PROPERTIES:

Orange needles; very stable; insoluble in water and dilute nonoxidizing acids; readily soluble in ethanol, ether, acetone, benzene and other similar solvents [in contrast to $\text{Fe}(\text{CO})_4\text{Hg}$]. An easily prepared compound and an excellent starting material for the preparation of other cobalt carbonyl compounds. Thus, $[\text{Co}(\text{CO})_4]_2\text{Hg}$ may be converted by alkali sulfides into alkali salts of $\text{Co}(\text{CO})_4\text{H}$, from which the hydride itself and $\text{Co}(\text{CO})_4$ may be obtained.

In a similar manner, other heavy metal derivatives of $\text{Fe}(\text{CO})_4\text{H}$ and $\text{Co}(\text{CO})_4\text{H}$ may be obtained by this double decomposition. Derivatives of $\text{Co}(\text{CO})_4\text{H}$ and Zn, Cd, Hg, In, Tl are obtained directly from the metals and CO in high-pressure syntheses.

REFERENCES:

- W. Hieber and H. Schulten. Z. anorg. allg. Chem. 232, 24 (1937);
 W. Hieber and E. Fack. Ibid. 236, 101 (1938); W. Hieber and
 U. Teller. Ibid. 249, 43 (1942).

Ethylenediamine Iron Carbonyl



This and the next compound are complex salts of polynuclear iron carbonyl hydrides.

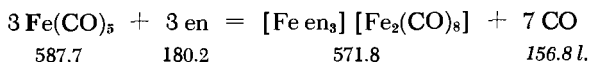

This compound can be successfully prepared only under completely anhydrous conditions. The ethylenediamine (*not* ethylene-

diamine hydrate) and the solvent pyridine must be completely free of water. The presence of pyridine is essential to the reaction. The apparatus shown in Fig. 346, consisting of the reaction vessel *a*, fritted-glass filter attachment *g*, and dropping funnel and adapter *t*, is recommended.

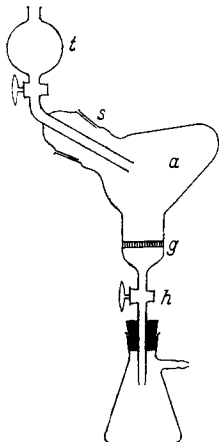

Fig. 346. Preparation of ethylenediamine iron carbonyl. *a* reaction vessel; *g* fritted-glass filter; *h* stopcock; *s* ground joint adapter; *t* dropping funnel attachment.

With vessel *a* pointed downward, a solution of 1.4 g. of the diamine in 20 ml. of pyridine is mixed with 8 g. of $\text{Fe}(\text{CO})_5$; vessel *a* is closed with a ground-glass stopper at *s* and connected to the atmosphere via the stopcock *h* and a wash bottle filled with conc. H_2SO_4 . The reaction mixture is then heated on a water bath to 80°C for four to five hours. After about one hour of heating the (now red) solution starts evolving gas bubbles and continues to do so until the reaction is finished. At end of the reaction, the solution is cooled, the dropping funnel *t* is connected to *s*, and the product, which forms in copious quantities, is filtered through *g*. It is washed on *g* with pyridine and anhydrous ether; for a final purification, it is again triturated with ether and refiltered. Yield: 2.6 g. (60% on the basis of the diamine).

SYNONYM:

Triethylenediamine iron (II) octacarbonyl diferrate (II).

PROPERTIES:

Brick-red monoclinic (or triclinic) and very shiny prisms; quite stable; insoluble in organic solvents, including pyridine.

REFERENCES:

- W. Hieber and F. Sonnekalb. Ber. dtsch. chem. Ges. 61, 563 (1928); W. Hieber, J. Sedlmeier and R. Werner. Chem. Ber. 90, 278 (1957).

Pyridine Iron Carbonyl

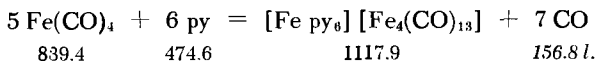
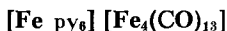

This substance must be prepared in complete absence of air and under nitrogen; this is best done in the apparatus shown in Fig. 346.

The bulb is charged with 5 g. of $\text{Fe}(\text{CO})_4$; the latter is then freed of the always present traces of Fe_3O_4 . This is done by pouring over it some methanol and then heating with 20% HCl on a water bath for four to six hours (no oxygen may be present). The solution is suction-filtered through the fritted glass and washed with dilute HCl, dry methanol and dry ether; the residue is dried in a high vacuum. For this final drying, the dropping funnel is replaced by a stopper at *s* and the apparatus connected at *h* to a cooled trap and the vacuum pump.

The purified $\text{Fe}(\text{CO})_4$ is then reacted at 0°C with 6 ml. of dry and air-free pyridine, the reaction taking place in the evacuated apparatus. The reaction is accompanied by foaming and evolution of CO, and ends in a short while, the green color of the $\text{Fe}(\text{CO})_4$ solution turning intense red.

After 0.5 hour the product is collected by filtration, washed briefly with pyridine, then with dry petroleum ether and absolute ether, and dried in a high vacuum. Yield: 2.3 g. (70%), the remainder being retained in the mother liquor.

Alternate method: Direct synthesis from $\text{Fe}(\text{CO})_5$ and pyridine in a sealed tube at $120\text{--}140^\circ\text{C}$.

SYNONYM:

Hexapyridine iron (II) tridecacarbonyl tetraferate (II).

PROPERTIES:

Nearly black or deep-red crystals, extremely pyrophoric.

REFERENCES:

- W. Hieber and E. Becker. Ber. dtsch. chem. Ges. 63, 1414 (1930); W. Hieber and F. Mühlbauer. Ibid. 65, 1088 (1932); W. Hieber and R. Werner. Chem. Ber. 90, 286 (1957).

Potassium Nitrosyl Tricarbonyl Ferrate

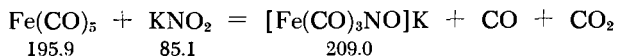
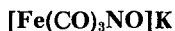

The reactor in this case is a one-liter, three-neck flask fitted with stirrer, reflux condenser and gas inlet tube. To start with, the air is completely displaced with very pure nitrogen; then, 45 g. of KNO_2 is dissolved in 400 ml. of methanol with vigorous stirring (the KNO_2 is premelted and then cooled on a cold porcelain surface to give small droplets). Following this, 67 ml. (0.5 moles) of freshly distilled $\text{Fe}(\text{CO})_5$ is added via the condenser and the mixture is cautiously heated to 30-35°C. The reaction starts in a short while and is accompanied by vigorous evolution of gas; since the reaction is highly exothermic, it must occasionally be moderated by cooling in cold water. The gas evolution slows down in about three hours; the mixture is heated at 60°C for 30 minutes and then cooled. Finally, the stirrer and the reflux condenser are replaced by stoppers, and the solvent and unreacted carbonyl compound are distilled off in aspirator vacuum. To shorten this distillation somewhat, it is permissible to heat slightly (but very carefully).

The dry crude product can be used immediately for the preparation of $\text{Fe}(\text{NO})_2(\text{CO})_2$. However, there may arise a need to purify it, especially to remove excess nitrite and decomposition products. In this case, the crude product is extracted (in the absence of air and light) in a Soxhlet apparatus with 200 ml. of ether until the reflux is colorless. Evaporation of the extract under reduced pressure yields a bright-orange mass. Addition of toluene or xylene to the ether solution gives the salt as fine crystals. Yield: 60 g. of crude product, which on careful workup yields 45 g. of pure substance.

PROPERTIES:

Orange-yellow salt, very sensitive to light and air, especially when in solution. All operations, including the purification, should be conducted in a darkroom under red light. The product is kept in a vacuum desiccator lined with black paper; the desiccator is preflushed several times with nitrogen, and is then evacuated. When stored under such conditions, the preparation is stable for some time.

The sodium salt is obtained in nearly quantitative yield by reaction of $\text{Fe}(\text{CO})_5$ with NaNO_2 in absolute methanol in the presence of 2 molar equivalents of NaOCH_3 per mole of $\text{Fe}(\text{CO})_5$.

REFERENCES:

- W. Hieber and H. Beutner. *Z. Naturforschg.* 15b, 323 (1960);
M. J. Hogsed. *C.A.* 53, 9592 (1959), U. S. Pat. 2,865,707
(1957).

Iron Dinitrosyl Dicarbonyl

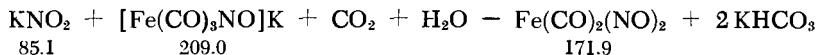
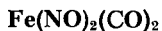

This compound is prepared in the same apparatus as nickel carbonyl (p. 1747 ff.; Figs. 344 and 345). First, the shaking vessel, which in this case is used as a dropping funnel, is charged with 42 g. (0.2 moles) of $[\text{Fe}(\text{CO})_3\text{NO}]\text{K}$; after evacuation, a solution of 17 g. of KNO_2 or 14 g. of NaNO_2 in 150 ml. of water is added. Then, the shaking bulb is attached to the gas-liquid mixing vessel and the entire apparatus flushed with a moderately fast stream of air-free CO_2 .

The brown nitrosyl carbonyl vapor appears the moment the solution is allowed to flow into the mixing vessel; the vapor is condensed in the Dry Ice-cooled traps, where it deposits as a bright orange coating. To speed up the transfer of the vapor to the traps, the reaction flask is heated in a water bath. However, the flask temperature should not exceed 35°C . If, as may happen (especially at the start of the experiment), some of the vapor condenses in the connecting tubes, it is driven into the cold traps by gentle heating with a hair dryer. The brown vapor disappears after a while, the preparation is stopped, and the CO_2 in the apparatus is displaced with pure nitrogen. The produce may be re-sublimed onto P_2O_5 in high vacuum; from there, it may be driven into ampoules, which are then stored in a freezer and protected from light to avoid decomposition. The yield is approximately 20-25 g. (60-70%).

PROPERTIES:

Beautiful deep-red crystals. M.p. 18.5°C . The liquid has a tendency to supercool; decomposes at 50°C . Insoluble in water, soluble in organic solvents; readily oxidized by air. Can be distilled without extensive decomposition only at temperatures below 15°C .

REFERENCES:

- W. Hieber and J. St. Anderson. *Z. anorg. allg. Chem.* 208, 238 (1932); 221, 132 (1933); F. Seel. *Ibid.* 269, 40 (1952).

Cobalt Nitrosyl Tricarbonyl

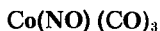

Prepared in the same way as $\text{Fe(NO)}_2(\text{CO})_2$, that is, by reaction of the solution of $\text{Co(CO)}_4\text{K}$ obtained in the cyanide process with nitrite and CO_2 .

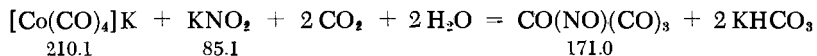

PROPERTIES:

Cherry-red, very volatile liquid; m.p. -1.05°C , b.p. 48.6°C , decomposition temperature 55°C . Insoluble in water and very stable if kept under water; miscible in all proportions with ethanol, ether, acetone, benzene and other organic solvents,

REFERENCES:

- W. Hieber and J. St. Anderson. *Z. anorg. allg. Chem.* **208**, 238 (1932); **221**, 132 (1933); F. Seel. *Ibid.* **269**, 40 (1952).

Dinitrosyl Cobalt Halides

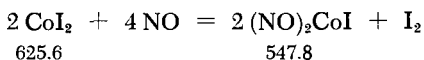
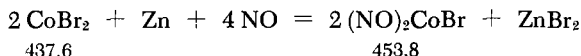
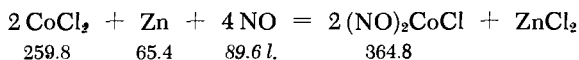
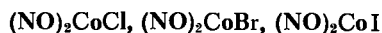

The apparatus consists of a 70-cm.-long, 2-cm.-O.D. glass tube surrounded by a 15-cm.-long metal block with a thermometer well. The block is heated with a gas burner, the temperature being controlled automatically by means of a relay-actuated valve in the gas line, which in turn is tripped by a bimetallic element in the thermowell. The reactor tube is connected to a tee so that either dry N_2 or NO_2 may be passed through. The NO is generated from NaNO_2 and 20% H_2SO_4 , washed free of NO_2 with 50% KOH , and dried in a train consisting of flask filled with conc. H_2SO_4 , CaCl_2 , NaOH and P_2O_5 (in that order). All parts

of the apparatus are either connected with ground joints or fused together.

The raw material for the iodine compound consists of about 2 g. of anhydrous CoI_2 placed in a porcelain boat, which is then inserted into the front part of the glass tube; the latter is then closed off with a wash bottle containing conc. H_2SO_4 . The traces of moisture carried in with the CoI_2 are then removed by heating to 130°C (by means of the metal block) while passing through a stream of N_2 . After cooling, the N_2 is displaced with NO and the temperature is again raised to $70\text{--}80^\circ\text{C}$. At this point, the reaction of NO with CoI_2 is so rapid that the pressure in the apparatus drops to below atmospheric; at the same time copious amounts of iodine are given off. The substance sinters and takes on a violet sheen. The temperature is now raised to 105°C and maintained at that level for 15-20 hours, that is, until the iodine vapors are displaced by brown vapors of the nascent $(\text{NO})_2\text{CoI}$. The final residue in the porcelain boat is a viscous, blackish-brown mass.

The product must be sublimed. Thus, the boat is transferred, in a countercurrent stream of N_2 , to the other end of the reactor tube and the temperature is raised to 115°C . The beginning of the sublimation is noticeable by a brown deposit; at a later stage, beautiful, flexible, deep brown-black, glittering crystals, up to 15 mm. long, are formed.

The chlorine and bromine compounds are prepared in the same way, except that a halogen-trapping metal (such as Zn dust or Co powder) must be added in 20% excess.

PROPERTIES:

Formula weight of $(\text{NO})_2\text{CoCl}$: 182.4; $(\text{NO})_2\text{Br}$: 226.9; $(\text{NO})_2\text{CoI}$: 273.9. After sublimation, these compounds form beautiful black-brown needles with a diamondlike glitter; these are often 1 cm. long. Melting points: $(\text{NO})_2\text{CoCl}$: 101°C ; $(\text{NO})_2\text{CoBr}$: 116°C ; $(\text{NO})_2\text{CoI}$: 131°C . The freshly prepared compounds are stable for some time in air; however, the crystals lose their surface sheen in several hours and then decompose over a period of days with loss of NO . The solubility in water increases in the sequence I-Br-Cl (partial decomposition).

In an analogous fashion iron (II) halides yields the dinitrosyl iron halides, $(\text{NO})_2\text{FeX}$, upon which Roussin's salts are based.

REFERENCES:

- W. Hieber and R. Marin. *Z. anorg. allg. Chem.* **240**, 241 (1939);
W. Hieber and R. Nast. *Ibid.* **244**, 23 (1940).

Sodium Dinitrosyl Thioferrate*

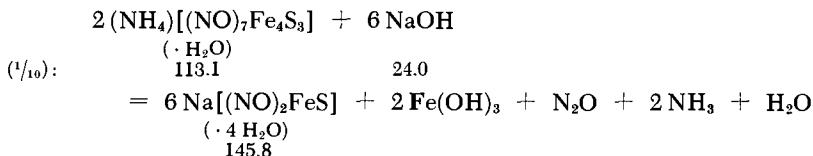

A mixture of 10 ml. of 10% NaOH with 3 g. of Roussin's black ammonium salt is prepared and heated on the water bath at 80°C; the heating is continued until the ammonia odor disappears (in about 15 minutes). The Fe(OH)₃ precipitate is removed by suction filtration through a fritted-glass funnel and the reddish-brown solution is evaporated over CaCl₂ under reduced pressure. It is left standing for one day; beautiful black-red crystals separate. These are collected on a fritted-glass funnel, washed with 0.1% sodium hydroxide solution, and dried between filter papers.

SYNONYM:

Roussin's red sodium salt.

PROPERTIES:

Formula weight of Na[(NO)₂FeS] 170.92; of Na[(NO)₂FeS] · 4 H₂O 242.99. Reddish-black crystals or reddish-brown powder, soluble in water and ethanol; insoluble in ether. Upon removal of excess base, the compound is converted in a short time to the black Roussin's salt.

REFERENCES:

O. Pawel. Ber. dtsch. chem. Ges. 12, 1953 (1879); 15, 2607 (1882).

*The nomenclature used here and in the following preparations is justified by the nature of these complex salts, in which the NO group is bound in the same way as in the nitrosyl carbonyls. See F. Seel, Z. anorg. allg. Chem. 249, 308 (1942).

Ammonium Heptanitrosyl Trithiotetraferate

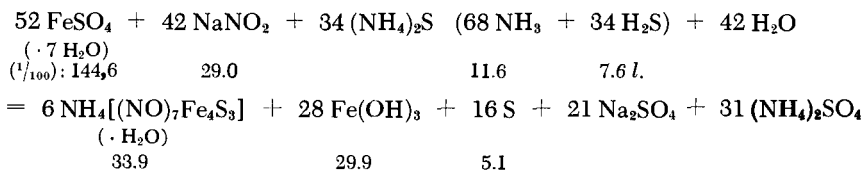
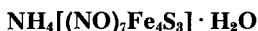

A solution of 8 g. of NaNO_2^* in 40 ml. of water is mixed with a solution of $(\text{NH}_4)_2\text{S}$, prepared by saturating 5 ml. of 22% ammonium hydroxide with H_2S adding 5 ml. of ammonium hydroxide of the same concentration, and siluting with 30 ml. of water. The final mixture is heated to the boil and thus becomes a dark-brown. Now, a solution of 20 g. of $\text{FeSO}_4 \cdot 7 \text{ H}_2\text{O}$ in 160 ml. of water is added at once and the mixture is quickly reheated to a vigorous boil. The reaction starts even before the boiling point is reached [precipitation of $\text{Fe}(\text{OH})_3$ and S is evident from the color change to black and brown]. Almost simultaneously the mixture starts evolving nitrous fumes. If a good yield is desired, it is essential that the gas evolution be suppressed by addition of 25 ml. of ammonium hydroxide (in small portions) during the entire boiling operation. After boiling for 15 minutes, the hot solution is filtered as quickly as possible through two Buchner funnels (moderate vacuum). The small crystals of Roussin's black ammonium salt already begin to precipitate in the filtrate during the filtration. To obtain larger crystals, the filtrate is placed in a hot water bath, heated until the salt is completely dissolved, and allowed to cool in the bath. Yield: about 1.7 g.

SYNONYM:

Roussin's black ammonium salt.

PROPERTIES:

Formula weight of $\text{NH}_4[(\text{NO})_7\text{Fe}_4\text{S}_3] \cdot \text{H}_2\text{O}$: 565.7. Hard, monoclinic crystals with a diamondlike glitter; soluble in water, giving dark-brown solutions; stable to 80°C .

The corresponding alkali salts are obtained by a similar procedure; however no excess of nitrite is necessary in this case.

*This is about double the theoretical amount; this compensates for the decomposition of the NH_4NO_2 present in the solution.

REFERENCES:

- O. Pawel. Ber. dtsh. chem. Ges. 12, 1953 (1879); 15, 2607 (1882).

Ethyl Dinitrosyl Thioferrate

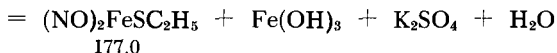
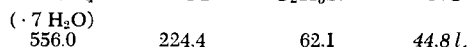
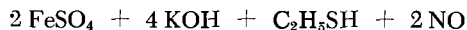

The shaking vessel shown in Fig. 344 is charged with 27.8 g. (0.1 moles) of $\text{FeSO}_4 \cdot 7 \text{H}_2\text{O}$ and evacuated. Then, 140 ml. of boiled water is aspirated in, the salt is dissolved by shaking, and finally a solution of 11.2 g. of KOH and 3.1 g. of $\text{C}_2\text{H}_5\text{SH}$ (3.7 ml., 0.05 moles) in 25 ml. of water is added. The apparatus is now connected to a calibrated gas-measuring flask containing 2.5 liters of NO stored over some solid KOH; the gasometer is then shaken on a machine. The initially sirupy, off-color slurry of $\text{Fe}(\text{OH})_2$ and $\text{Fe}(\text{SC}_2\text{H}_5)_2$ becomes a deep olive-green liquid. Toward the very end of the NO absorption (which goes very fast at the beginning and takes about 1.5 hours), the color changes to a light brown. A small amount of deep-black crystals are evident at the bottom of the flask and sometimes at the surface of the liquid. The NO is displaced with N_2 and the flask is opened. The black crystals can be separated from the $\text{Fe}(\text{OH})_3$, which has a lower specific gravity, by decantation and slurring; however, better yields (up to 80%) are obtained by centrifugation, washing in the centrifuge tube (once with absolute ethanol and 3-4 times with ether), and recrystallization of the substance from hot absolute ethanol with slow cooling.

PROPERTIES:

Glittering black monoclinic crystals, m.p. 78°C . Insoluble in water; soluble with difficulty in ethanol; more readily soluble in ether; readily soluble in CS_2 , CHCl_3 and C_6H_6 , giving yellowish-red solutions.

REFERENCES:

- K. A. Hofmann and O. F. Wiede. Z. anorg. Chem. 9, 300 (1895); H. Reihlen and A. von Friedolsheim. Liebigs Ann. 457, 71 (1927).

Potassium Dinitrosyl Thiosulfatoferrate

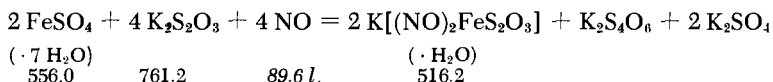

This derivative of Roussin's red salt is prepared by shaking a mixture of the concentrated aqueous solutions of 28 g. (0.1 moles) of $\text{FeSO}_4 \cdot 7 \text{H}_2\text{O}$ and 40 g. of $\text{K}_2\text{S}_2\text{O}_3$ under NO , as described in the previous preparation. During the first hour, the gas is absorbed especially rapidly and the solution turns intensely brown. Later, $\text{K}[(\text{NO})_2\text{FeS}_2\text{O}_3] \cdot \text{H}_2\text{O}$ separates out in leaflets of brass-like glitter. The substance is collected by filtration, washed with ethanol, and dried in vacuum over conc. sulfuric acid.

PROPERTIES:

Formula weight of $\text{K}[(\text{NO})_2\text{FeS}_2\text{O}_3] \cdot \text{H}_2\text{O}$: 258.1. Only slightly soluble in cold and warm water; decomposes in boiling water.

The same procedure is used to prepare the sodium salt, $\text{Na}[(\text{NO})_2\text{FeS}_2\text{O}_3]$. In this case, crystallization is slower due to the greater solubility of the product.

Finally, the same method may be used for the preparation of the corresponding cobalt and nickel compounds $\text{K}_3[(\text{NO})_2\text{Co}(\text{S}_2\text{O}_3)_2]$, and $\text{K}_3[(\text{NO})\text{Ni}(\text{S}_2\text{O}_3)_2]$.

REFERENCES:

- K. A. Hofmann and O. F. Wiede. *Z. anorg. Chem.* 8, 319 (1895);
W. Manchot. *Ber. dtsch. chem. Ges.* 59, 2445 (1926).

Potassium Nitrosyl Cyanomolybdate

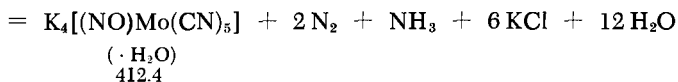
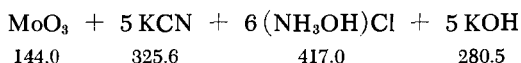
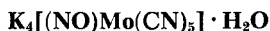

The reaction is based on reduction with NH_2OH and disproportionation of the latter into NOH and NH_3 . Thus, 5 g. of

acid (d 1.24) is added (stirring). The mixture is digested on a water bath at moderate temperature until a test drop of the brown solution reacts with FeSO_4 solution to give a dark green (rather than blue) precipitate. After standing for 1-2 days, the mixture is just neutralized with Na_2CO_3 (an excess must be avoided). The neutralized solution is heated to the boil, filtered and quickly concentrated to a small volume. After cooling, an equal volume of ethanol is added to precipitate most of the KNO_3 . This is separated by filtration, and the solution is quickly reconcentrated to remove the ethanol. The dark-red solution yields crystals on standing; these are suction-filtered and washed with some cold water. Further crystalline material is obtained by repeating the evaporation of the mother liquors.

SYNONYM:

Sodium nitroprusside.

PROPERTIES:

Ruby-red orthorhombic-bipyramidic crystals. One part is soluble in 2.5 parts of water at 16°C .

REFERENCES:

- L. Vanino. *Handb. d. präp. Chem.* [Handbook of Preparative Chemistry], Inorganic Part, Stuttgart, 1925, p. 355; R. Wild. *Arch. Pharm.* 131, 26 (1855).

Sodium Carbonyl Cyanoferrate



Easily prepared via reaction of CO with $\text{Na}_3[\text{Fe}(\text{OH}_2)(\text{CN})_5]$, which in turn is obtained from sodium nitroprusside.

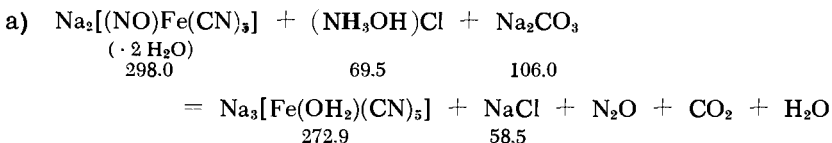

A solution of 20 g. of sodium nitroprusside and 10 g. of Na_2CO_3 in 80 ml. of water is prepared; the reaction flask is placed in ice and 7 g. of $(\text{NH}_3\text{OH})\text{Cl}$ in some water is added. Gas evolution begins immediately and the solution turns a greenish brown. After one

hour, the product is precipitated as a brown tar with three volumes of ethanol. By repeated solution in water and reprecipitation with methanol, $\text{Na}_3[\text{Fe}(\text{OH})_2(\text{CN})_5]$ is obtained as a yellow powder. It is important to keep the temperature below 5°C to avoid formation of $\text{Na}_4[\text{Fe}(\text{CN})_6]$ and iron hydroxides.

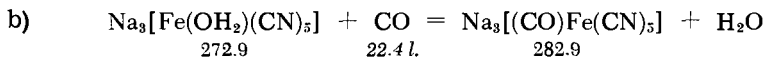

The freshly prepared aquo complex (13 g.) is dissolved in 35 ml. of boiled water and introduced into an evacuated three-neck flask fitted with a vacuum-tight mercury-seal stirrer, a dropping funnel, and gas inlet and outlet tubes. By repeated flushing and evacuation, the flask is filled with carbon monoxide (prewashed with an alkaline pyrogallol solution). When vigorously stirred, the solution starts to absorb CO at a fast rate; after 24 hours and absorption of 98% of the stoichiometric quantity of CO, the reaction is complete. The flask must be protected from light during the reaction. The product is precipitated from the greenish-blue solution by addition of 200 ml. of ethanol containing 0.5 g. of NaOH; it is filtered in air. After washing with some absolute ethanol, the complex is obtained in analytical purity.

Since $\text{Na}_3[(\text{CO})\text{Fe}(\text{CN})_5]$ is somewhat soluble in ethanol, it is recommended to work up the aqueous-alcoholic filtrate. To this end the filtrate is evaporated to dryness at 12 mm. and $40\text{--}50^\circ\text{C}$ (bath temperature), the residue dissolved in the minimum amount of water, and all $\text{Fe}(\text{OH})_3$ filtered out. The filtrate is concentrated to crystallization in a vacuum desiccator over conc. H_2SO_4 ; a very small quantity of mother liquor should remain. The crystals are collected by filtration, washed with some ethanol, and dried at 110°C . Yield: up to 90%.

PROPERTIES:

Pale-yellow needles, surprising stable.

REFERENCE:

W. Hieber, R. Nast and C. Bartenstein. *Z. anorg. allg. Chem.* **272**, 32 (1953).

Alloys and Intermetallic Compounds

G. BRAUER

General Remarks

The usual laboratory preparation of alloys consists of fusion of the metallic components. This method allows a simple control over the quantities of reagents so as to reach the desired composition. If the changes of the phase diagram of the metal system are known as a function of the temperature, this method also allows, in most cases, the preparation of definite intermetallic compounds. Occasionally, however, it is difficult to obtain the required homogeneity in the product because some of the reagents may burn, evaporate or react with the fusion vessel.

By comparison, other methods for the preparation of alloys are less used in the laboratory, although in special cases the optimum methods may involve reduction (chemical or electrolytic) of metallic compounds. In addition, some intermetallic compounds are best obtained as residues remaining after the corresponding basic alloys are dissolved. However, a knowledge of the temperature-induced transformations of the phase diagram is of the greatest importance in all cases; thus, the literature references below must be consulted, if at all possible.

Due to the enormous number of possible and known alloys and intermetallic compounds, a full description of all preparative methods is, of course, impossible. It is even less feasible to cite all the most important compounds separately. This section therefore contains only a selection of typical laboratory procedures; these are examples which may be adapted to other cases, even if the latter are unrelated. Only a few individual preparations are given in detail.

Further, it should be pointed out that preparative methods for metallic compounds overlap those for semimetals and non-metallic compounds. For this reason, many of the methods cited here are derived from those for nonmetallic compounds; others, which stem from metallurgy, may also be applied to other substances.

REFERENCES:

Collected phase diagrams of metallic systems:

- M. Hansen and K. Anderko. Constitution of Binary Alloys, New York-Toronto-London, 1958; Landolt-Börnstein. Zahlenwerte und Funktionen [Numerical Values and Functions], Vol. II, Part 3, 6th Ed., Berlin-Göttingen-Heidelberg, 1956; W. Hume-Rothery et al. Metallurgical Equilibrium Diagrams, London, 1952; E. Jánecke. Kurzgefasstes Handbuch aller Legierungen [Short Handbook of Alloys], Heidelberg, 1949; T. Lyman (Amer. Soc. Metals). Metals Handbook, Cleveland, 1948 (Binary and Ternary Alloys); J. L. Haughton. Bibliography of the Literature Relating to Constitutional Diagrams of Alloys, London, 1942; M. von Schwarz. Metall- und Legierungskunde [Metals and Alloys], Stuttgart, 1929 (Binary, Ternary and Quaternary Alloys).

Preparation of Alloys by the Use of Heat

Purity of the Starting Materials

Except for special cases where some purification is achieved by the vaporization that occurs at relatively high temperatures, one should not expect that the product alloys will be purer than the starting metals. Therefore, the latter should be as pure as possible and should contain a minimum of dissolved impurities ("internal" impurities). The "external" impurities also cannot be neglected. Thus, oxide layers must be removed by scraping or grinding, or by chemical etching with suitable acids. Industrial metals comminuted by mechanical means (powders, shavings) are frequently contaminated by traces of lubricants. These must be removed by extraction with organic solvents; otherwise, they tend to interfere with the alloy formation and form carbides. Water and all organic solvents must be removed by careful drying.

The optimum methods sometimes involve metal hydrides rather than pure metals. The procedure is useful mainly in the case of metals that form stable hydrides (alkali and alkaline earth metals, Ti to Th, V to Ta, Pd). The hydrides are readily reduced to powders and the contact of the latter with the other components of the alloy is much better than it would be otherwise. The thermal decomposition of the hydrides proceeds so easily that the formation of alloys is not only not slower than in the case of pure metals, but is faster due to the small particle size of the material. In addition, the hydrogen liberated from the hydride may reduce the oxide impurities. One disadvantage inherent in the use of hydrides is that the commercial materials are usually less pure than the corresponding metals.

Form of the Starting Materials

The starting material may consist of chunks, ingots, shavings or powders. Large chunks have relatively small surface areas, thus introducing fewer "external" impurities; they usually leave less material on the container walls. On the other hand, mixtures of large chunks may sometimes be difficult to reduce to a homogeneous melt, especially if the components of the alloy differ greatly in density or melting points. While homogeneous mixtures of powders already in the solid state can be prepared, the oxide skin frequently prevents junction of the particles even when sufficient heat is applied; in addition, powders have a greater tendency to cling to the container walls, again because of surface oxides. The metal hydrides may be found advantageous in this case, as mentioned above. The formation of alloy from powders, shavings or thin wires is greatly improved by pressing the mixture into pellets prior to heating (suitable dies are described in Part I, p. 103). (They are made from shape-retaining "oil-tempered" steel and are hardened only after machining and careful fitting of the die and the matrix.)

Metals which readily acquire a surface oxide layer may be cut into a potlike shape on a lathe. The other alloy components can then be hammered into the hollow to assure an intimate contact from the very start.

When two components with widely differing melting points are fused, the fusion pot should be arranged so that the lower-melting metal must run through the higher-melting one.

Preparation of Starting Mixtures

It is desired to obtain the desired alloy composition by weighing out theoretical quantities of the components but, for various reasons, this composition cannot always be achieved that simply. Frequently a number of successive preliminary experiments must be carried out, whereby one gains the necessary experience.

The most important causes of deviation of the product from the desired composition are losses of metal by vaporization, oxidation or side reactions with the material of the fusion pot. In such cases the expected losses of a component are balanced by adding an extra quantity of that component to the starting mixture. A rough approximation of the extra quantity required is obtained from the fact that when the preparation is conducted properly and in closed crucibles (see below), not even the very reactive mixtures of alkali metals lose more than 5% of the starting weight.

An especially clean way to measure out **alkali metals** consists in melting the latter in small, sealed glass ampoules, from which they can easily be removed by remelting (see the section on Alkali Metals, pp. 961-967).

Crucible and Ampoule Methods

The alloy components, weighed out with the above considerations in mind, are combined by fusion in crucibles or ampoules. Some method must always be devised to minimize losses due to burning or vaporization. In simple cases, where open vessels are used, this is achieved by covering the charge with a protective layer of a salt or salt mixture which also melts in the process. Alternatively, the mixture may be protected by a blanket of an inert gas; crucibles may be closed by a lid and ampoules by fusing the constricted neck. If the closure is gas-tight, some inert or reducing gases may be included and a vacuum may even be maintained.

Several **low-melting salts and salt mixtures** suitable for laboratory use are given in Tables 1-3 (for further references, see Guertler [1]). Many such protective agents are commercially available for industrial use and they can also be employed.

Table 1

Melting Points of Some Salts Suitable for Use in Protective Layers

Salt	M.p., °C	Salt	M.p., °C
LiNO ₃	255	LiF	870
NaNO ₃	307	Na ₂ SO ₄	884
KNO ₃	334	KBO ₂	947
LiCl	613	BaCl ₂	962
MgCl ₂	708	NaBO ₂	966
Na ₂ B ₄ O ₇	741	K ₂ SiO ₃	976
CaCl ₂	772	NaF	988
KCl	776	Na ₂ SiO ₃	1088
NaCl	801	CaF ₂	1360
KF	880		

Hygroscopic salt mixtures sometimes react with the molten alloys, evolving hydrogen and interfering in the reaction. This effect can be reduced by adding KOH.

The type of **protective atmosphere** depends on the metals of the alloy. Hydrogen is frequently used, except when large quantities of hydride-forming alkali, alkaline earth or rare earth

Table 2

Melting Points of Some Binary Salt Mixtures with Uniform Melting Points

Wt. %	Salt I	Wt. %	Salt II	M.p., °C	Wt. %	Salt I	Wt. %	Salt II	M.p., °C
73	KNO ₃	27	LiNO ₃	132	32.8	KCl	67.2	BaCl ₂	645
55.3	NaNO ₃	44.7	LiNO ₃	208	51	LiBO ₂	49	NaBO ₂	648
46	LiCl	54	KCl	352	77.8	NaCl	22.2	BaCl ₂	654
57	LiCl	43	KCl	580	45	NaCl	55	KCl	660
61.4	KCl	38.6	MgCl ₂	426	35.8	LiF	64.2	MgF ₂	669
44	NaCl	56	MgCl ₂	430	72	NaCl	28	NaF	675
12	LiF	88	LiCl	485	51	KCl	49	K ₂ SO ₄	690
32.8	NaCl	67.2	CaCl ₂	500	50	Na ₂ CO ₃	50	K ₂ CO ₃	690
33.7	NaCl	66.3	LiCl	552	32.4	NaF	67.6	KF	700
45.8	KF	54.2	AlF ₃	565	35.4	LiF	64.6	AlF ₃	710
73.5	KCl	26.5	CaCl ₂	600	63.7	LiF	36.3	AlF ₃	715
44.2	Na ₂ SO ₄	55.8	Li ₂ SO ₄	601	52.8	NaF	47.2	CaF ₂	810
63	KCl	37	KF	605	61	NaF	39	MgF ₂	815
35	NaCl	65	Na ₂ CO ₃	620	21.5	NaF	78.5	MgF ₂	985
46.6	NaCl	53.4	Na ₄ P ₂ O ₇	620	90.4	KF	9.6	AlF ₃	835
32.8	NaCl	67.2	Na ₂ SO ₄	623	87.8	BaF ₂	12.2	MgF ₂	890
26	KCl	74	CaCl ₂	640	78.8	BaF ₂	21.2	MgF ₂	930
85	CaCl ₂	15	CaF ₂	644					

metals are present; in other cases, nitrogen is used, except when nitride-forming Li, Be, Mg, Ca, Sr and Ba, or the rare earth metals, Ti, Zr, Hf, Th, V, Nb and Ta are present. If no carbides can form, CO may be used to advantage; however, CO₂ and SO₂ may occasionally oxidize the metals at high temperatures. Noble gases, especially argon, which is commercially available in cylinders at 150-200 atmospheres pressure, are the best but also the most expensive protective agents. For real protection the gas should be very pure: oxygen is undesirable even in traces. Gas purification methods are given in various sections of this handbook (H₂: p. 111 ff.; N₂: p. 457 ff.; noble gases: p. 82 ff.). Occasionally, H₂, N₂ and Ar are available in high purity (99.99%) from commercial sources, sometimes on special order.

High, narrow crucibles are preferred. Useful crucible materials are a) metals, b) ceramics and c) glasses (for ampoules).

A) METALS:

For obvious reasons, only high-melting metals which do not tend to form alloys are suitable for crucibles. Iron and various types of steel, as well as molybdenum and tantalum, are frequently used. Molybdenum is very serviceable but also much more expensive and less easily worked than Fe. These metals are preferentially used for smelting alloys of the "B" group of

elements and for the extremely reactive alkali and alkaline earth metals (see Table 4).

Table 3

Melting Points of Some Ternary Salt Mixtures
with Uniform Melting Points

Wt. %	Salt I	Wt. %	Salt II	Wt. %	Salt III	M.p., °C.
16.4	NaCl	24.6	KCl	59.0	BaCl ₂	540
76.4	BaCl ₂	14.0	KCl	9.6	Na ₂ CO ₃	542
24	NaCl	37	KCl	39	Na ₂ CO ₃	580
5	NaCl	9	KCl	86	Na ₂ B ₄ O ₇	640
53.3	AlF ₃	13.2	CaF ₂	33.2	NaF	705
10.1	AlF ₃	34.4	CaF ₂	55.5	NaF	780
15.9	AlF ₃	26.7	CaF ₂	57.4	NaF	825
20.5	AlF ₃	51.7	CaF ₂	27.8	NaF	1095

Table 4

Metallurgical Classification of Elements

																	H	He
Li												Be	B	C	N	O	F	Ne
Na												Mg	Al	Si	P	S	Cl	Ar
K	Ca	Sc	Ti	V	Cr	Mn	Fe	Co	Ni	Cu	Zn	Ga	Ge	As	Se	Br	Kr	
Rb	Sr	Y	Zr	Nb	Mo	Tc	Ru	Rh	Pd	Ag	Cd	In	Sn	Sb	Te	I	X	
Cs	Ba	R.E.	Hf	Ta	W	Re	Os	Ir	Pt	Au	Hg	Tl	Pb	Bi	Po	At	Em (Rn)	
Fr	Ra	Ac	Th	Pa	U													
Alkali- and al- kaline earth metals	Transition metals									B Elements								

Metallic Pt, Ag and Ni, which are normally chemically inert and thus are used as vessel materials under corrosive conditions, cannot be used in crucibles because of their intrinsic and pronounced tendency to form alloys.

The preparation of alloys of the so-called transition metals virtually always requires ceramic crucibles (see also below).

A gas-tight seal for an iron crucible can be obtained in a number of ways. An iron lid may, for instance, be put on and sealed in place by means of flanges; the lid may also be in the form of a threaded cap or plug, which yield a firmly closed circular seal. Two types of screw caps are shown in Fig. 273, p. 990. Tubular crucibles with fitting lids (or plugs) can frequently be welded shut for a gas-tight seal. In this case, the plug closely fits the I.D. of the crucible and has the shape of a tube with one end closed. Examples of this are given in Fig. 347. Even though the crucible may contain a protective gas blanket, the gas-filled space above the material to be alloyed should be kept at a minimum. With this in mind, the inner cylinder serving as a plug in the crucible of Fig. 352b should be hammered down (after charging) as far as possible, sawed off near the rim of the outer crucible and then welded to the outer rim. A plug shaped as a hollow cylinder is easier to weld at the rim than a solid plug. The hollow plug should be slightly tapered (into a cone) near its upper rim. Alternately, its rim should be turned down slightly after it is driven in (it thus forms a flange surface). In either case, the aim is to close off the seam and prevent welding gases from penetrating into the crucible. If generation of a large amount of heat is expected on welding and if it is undesirable to trigger the reaction until the crucible is tightly sealed, its lower section may be cooled in water during welding. This would have to be done, for instance, in welding crucibles containing the very volatile alkali and alkaline earth metals when they are to be alloyed with "B" metals.

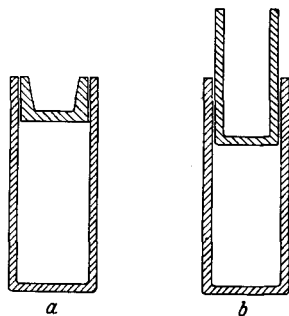

Fig. 347. Tubular steel crucible. When small quantities of alloy are needed (for instance, in crystal structure studies) the following dimensions have proved useful: O.D. 20-25 mm., wall thickness 1-2 mm., height 70-90 mm.

Prior to closure of the crucible, the protective gas may be introduced through a narrow tube. A better method is to put the charged crucible, with the lid loosely in place, into a large-diameter glass tube, which is closed at one end and fitted with a ground glass joint and stopcock (Fig. 348). The tube is then alternately evacuated and filled with the protective gas. This arrangement displaces the air very efficiently.

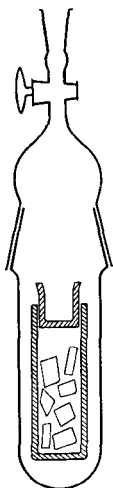

Fig. 348. A method for evacuating a metal crucible and filling it with a protective gas blanket.

ingot adheres firmly to the crucible walls because of local welding.

Alloys which are extremely sensitive to air, especially those with high concentrations of alkali and alkaline earth metals, require special methods for the removal of the ingot from the iron crucible [2]. In the device of Zintl and Harder (Fig. 349) a tubular iron crucible can be opened while completely surrounded by a protective gas.

The iron tube r is connected via the standard-taper joint s to a source of pure N_2 as well as to other devices for further treatment of the alloy. The tubular crucible t , whose wall has already been machined down on a lathe (see above) so that it is now thin, is positioned in r by means of the screws a in such a way that its bottom may be sawed off through the slit c while still under N_2 (the length of the circumferential slit c is equal to only $2/3$ of the diameter of tube r). After the crucible bottom is sawed off, the crucible is pushed to the right by means of a thick wire (which passes through an axial hole in the cover plate e) and repositioned by means of screws a . The top of the crucible (that is, the plug) is now sawed off; the cover plate e is taken off for

After fusion and cooling, the iron crucibles are opened by sawing off the top and bottom, and the alloy is then punched out of the open cylinder. In another method, the crucible is placed on a lathe, clamped at the stopper end, and its wall turned down to 0.1-0.3 mm. This thin wall can then be stripped off with a pair of pliers in the same manner as the top of a can of sardines. Since this can be done very rapidly, even those alloys which are very sensitive to air can be isolated without too much damage and can be rapidly transferred to a storage vessel filled with a protective gas. The method is also useful in cases where the alloy

a moment and the debris removed. The alloy is now contained in an iron tube (casing) which is open at both ends. The iron filings still adhering to the tube and ingot are tapped out. The alloy can now be pushed out of the casing by a steel rod passed through the hole in *e*. In certain cases the casing tube (including the alloy inside) may be used directly in further workup, e.g., an extraction. The protective gas should escape through only one hole at a time; the slit *c* for the saw can be closed off by collar *d*, the hole in *e* by means of a rubber stopper. This apparatus was originally used for the preparation of Na-Pb and Na-Sn alloys.

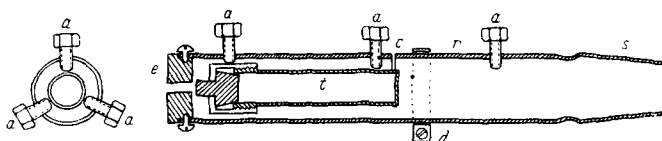

Fig. 349. Opening of a tubular iron crucible in the absence of air. *r* iron tube with standard-taper joint *s*; *t* crucible; *a* screws to fasten the crucible in place (nine such screws are arranged, in groups of three, along the circumference of *r*, the angles between the screw axes being 120° , as indicated in the insert); *c* slit for the introduction of a hacksaw; *d* collar for closing the slit when not in use; *e* cover plate for the tube *r*.

In the arrangement of Klemm and Dinkelacker, described in greater detail in Fig. 353 and on p. 1788 f., complete removal of the ingot from the tube is unnecessary; only quantities needed for immediate use need to be drilled out.

B) CERAMIC MATERIALS

Crucibles made of various kinds of ceramic materials can be used. The reader is referred to the text and tables in Part I, p. 12 ff., especially Table 7. Recently, crucibles of Ce and Th sulfides have proved advantageous for the fusion of nearly all metals, the exception being Pt. They can be used up to 1800°C [3].

Crucible shapes frequently used in the study of alloys are the conical (the so-called high shape) and the long, cylindrical (Tammann tubular crucible), both with a rounded or, less frequently, a flat bottom. Ceramic crucibles may be fitted with lids of the same material, but these can usually not provide a gas-tight seal by themselves (some sealing compound must be provided). Only alumina (Al_2O_3) can be fused and then only in the case of very small tubular crucibles (about 15 mm. O.D.). In this case a well-fitting plug may be fused to the crucible wall with an

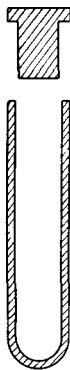

acetylene-oxygen flame (welding torch) [4]. Thus, a crucible of the type illustrated in Fig. 350 is charged to a quarter of its height with the metal, closed off with the loosely fitting plug, and evacuated and filled with a suitable inert gas in the apparatus of Fig. 347. The crucible is then surrounded by moist sand to one half of its height, and the top section, including the plug, is carefully heated, using first a city gas-air mixture, then the acetylene-oxygen flame. The flange of the plug eventually fuses to the rim of the crucible (m.p. of $\text{Al}_2\text{O}_3 = 2050^\circ\text{C}$). The entire closed crucible is then cooled carefully and uniformly. Some experience is necessary to avoid cracking during the fusion and, especially, during the cooling.

Fig. 350. Tubular alumina crucible. O.D. about 15 mm., length 65 mm.

Tubular crucibles made of Pythagoras mass* may be closed off in the same way as an ampoule, that is, by pulling to a small diameter and sealing the top end in a hydrogen-oxygen or acetylene-oxygen flame

(see ampoule methods, p. 1782).

In another method, the crucible is lined with other materials. This method allows using, in the preparation of alloys, chemically resistant materials that cannot be shaped like a ceramic when unsupported.

Thus, CaO linings are suitable for work with Ca alloys and, in general, with calcium metal, which is extremely corrosive when hot. The Jander method of lining iron crucibles with CaO (already mentioned in Part I, p. 13) consists of the following.

The crucibles are 12 cm. high and 2.5 cm. I.D., with a wall 1 mm. thick. A thick paste of freshly prepared quicklime (from precipitated CaCO_3) and water is partly poured in and partly painted on the inside of the crucible so that there is a layer 1-2 cm. thick at the bottom and a wall lining 0.3-0.4 cm. thick. Rotating the crucible and careful pressing with a spatula produce a good and even coat. The crucible is then very slowly dried at room temperature or at $30-40^\circ\text{C}$; any cracks that appear are filled by pressing with a spatula (this can be done as long as the cake is

*Pythagoras mass is a low-melting porcelain used for laboratory ware and electrical resistor casings, useful for temperatures not exceeding 1500°C . Its melting point is about 1730°C (Houben-Weyl, Allgemeine Laboratoriumspraxis [General Laboratory Practice], 4th ed., part 2, Georg Thieme Verlag, Stuttgart, 1959, p. 634).

still moist). Cracks that appear after this cannot be remedied; very fine cracks do no harm, as experiments with cracked CaO linings have shown. After the initial drying the temperature is increased to dark red heat, which transforms the $\text{Ca}(\text{OH})_2$ to CaO. Dry CaO does not adhere well to iron. Since its coefficient of expansion differs from that of iron, the crucible must be heated very carefully and treated very gingerly even after the lining process. The crucible is charged with the reactants, and an iron lid, also coated with CaO, is welded on.

Coatings of LiF are suitable for work with lithium alloys and metallic lithium at temperatures below 800°C . These coatings adhere relatively well to zirconia (ZrO_2) crucibles [6]. Thus, several grams of LiF (m.p. 870°C) are placed in a ZrO_2 crucible which is positioned in a small, movable electric furnace. The crucible is firmly seated in the furnace by means of asbestos wool. A clear melt is produced on heating; the current is then shut off and the melted LiF evenly distributed over the crucible walls by tilting the furnace. This is continued until the crucible cools sufficiently for the material to set. Afterward, the furnace is allowed to cool slowly at a low current (from 700°C to 300°C in one hour). The lithium fluoride lining thus formed has a thickness of 1-2 mm. If the cooling is too rapid, it will have large cracks; small cracks are nearly unavoidable, but are not deleterious because of the high surface tension of most metals.

Other lining materials, such as Nucelite, which can be directly bonded to metals, under certain conditions withstands temperatures up to 650°C , and is resistant to many gases, are also on the market. In addition, such materials as Pyroceram will be quite useful in the high-temperature laboratory.

Of late, many new ceramic materials have been developed for use in the various military and space programs. It is not possible to list them in this short section. Besides, this field is undergoing very rapid changes and new materials appear almost monthly. The reader is therefore advised to spend some time consulting the pertinent trade literature before proceeding with the experiment. He may find such investment of time very worthwhile, because it may result in a simpler, better, more convenient and cheaper experimental arrangement.

Ceramic crucibles may also be placed in glass, quartz or ceramic combustion tubes (one end open) so that the material may be in a vacuum or an inert gas atmosphere during the heating. Such an arrangement is shown in Fig. 272, p. 984.

Ceramic crucibles are frequently enclosed in slightly larger iron crucibles, which are then hermetically sealed with a welded-on plug; this arrangement combines the chemical resistance of ceramics, especially the oxides of Be, Mg, Al, Zr and Th, with the ease of sealing of iron crucibles.

Finally, all the crucible types mentioned above may be sealed into glass ampoules: this permits maintaining a vacuum or a desired gas atmosphere during the fusion.

C) AMPOULES

All types of glass, especially the high-melting glasses (see Part I, p. 5 ff.) and quartz, as well as tubes of Pythagoras mass, can be formed into ampoules (bomb tubes) and used for alloying of metals by fusion. The glass type used depends on the maximum working temperature. Pyrex can be used up to 560°C, Vycor up to 800°C under normal conditions and 1100°C for a short time, fused silica up to 1150°C, and Pythagoras mass up to 1400°C without danger of deforming. The metal reactants are changed into a long combustion tube of the appropriate ampoule material. The tube will normally have an I.D. of 10-20 mm., a wall thickness of 1.5-2 mm., and a round bottom of uniform thickness. The tube must be thoroughly cleaned and dried. It is then constricted just above the charge, but not so close to the latter that a reaction will be set off by the heat applied during sealing. The wall must be fairly thick at the constriction. The tube is evacuated and sealed at the constriction, thus forming an ampoule containing the metals under vacuum. The constricting and sealing are done with suitable torches (city gas-air, H_2-O_2 , etc.), depending on the softening temperature of the ampoule material.

The ampoule can also be filled with a protective gas. However, the thermal expansion of the gas must be taken into account in this case. For this reason, the ampoule is filled with the requisite gas at less than atmospheric pressure at room temperature.

After fusion and resolidification, the ampoule is broken up and the metal ingot isolated. The composition of the alloy may then be calculated (approximately) from the weights of the reactants and the product. However, only careful chemical analysis can give the true composition.

Heating and Cooling

The required reaction or fusion temperature is determined from the phase diagram. As a minimum, this temperature must be higher than the liquidus point of the alloy product. Preferably, however, it should exceed the melting points of all the reacting metals. The best temperature is one which exceeds the liquidus point by 30-50°C over the entire range of compositions of the system. Such a temperature will certainly ensure proper reaction conditions.

Heat sources may be furnaces of various types (see Part I, pp. 32-42). In general, the materials may be heated up as

rapidly as desired. The temperature increase due to the heat of reaction may be neglected. The heating time should be as short as possible to avoid reactions between the metal and walls of the reactor, and should in no case be longer than the time absolutely necessary to achieve a uniform composition. For this reason, the furnace should be preheated to approximately the desired temperature prior to the introduction of the vessel with the reactants. This vessel must, of course, be heated slowly enough to avoid stresses which would produce breakage. This applies particularly to glass ampoules and ceramics of low thermal conductivity. In any case, well-designed protective glasses or goggles must be worn during these operations.

When the desired melting temperature is reached, the homogenization of the mixture is promoted by mechanical means. Open crucibles are stirred with a rod of suitable material; tightly closed vessels (crucibles with a screwed-on or welded-on lid, ampoules) are taken out of the furnace and shaken or tumbled a few times; in the case of crucibles which are open but surrounded by a second protective vessel and which thus cannot be shaken or tumbled, at least some motion of the melt can be induced by external tapping or vibrating. All such agitation procedures must be followed by a short reheating to the maximum desired temperature.

Cooling also depends on the phase diagram as well as the intended use of the alloy. If there is no danger of separation of mixed crystals (with subsequent alteration of the composition of the alloy) and no peritectic reactions are expected, or if the composition achieved at the high temperature is the one desired in the solid, the material is quickly cooled in air. Materials in metal or quartz vessels may also be quenched in water or oil.

On the other hand, when a reaction must be completed at a lower temperature or it is desired to produce single crystals for studies on structure, then a slow, controlled reduction of the temperature is required. The type of cooling procedure thus depends on the application.

The formation of large single crystals from the melt may be favored by quiet, vibrationless cooling. Sometimes, however, motion of the melt during crystallization is desirable. The heating and cooling methods used for single crystals of pure metals are also applicable to single crystals of intermetallic compounds that exhibit congruent melting (see Part I, p. 94 ff., and [7]).

REFERENCES:

General: Personal communications from K. Schubert, Stuttgart, P. Ehrlich, Giessen, and H. Nowotny, Vienna.

1. W. Guertler. Metalltechnisches Taschenbuch [Short Handbook of Metal Technology], Leipzig, 1939.
2. E. Zintl and A. Harder. Z. phys. Chem. (B) 34, 238 (1936).
3. E. D. Eastman, L. Brewer, L. A. Bromley, P. W. Gilles and N. L. Lofgren. J. Amer. Ceram. Soc. 34, 128 (1950).
4. E. Zintl and A. Harder. Z. Elektrochem. 41, 767 (1935).
5. W. Jander. Z. anorg. allg. Chem. 138, 321 (1924).
6. E. Zintl and G. Woltersdorf. Z. Elektrochem. 41, 876 (1935); E. Zintl and G. Brauer. Ibid. 41, 102 (1935).
7. O. Buckley. Crystal Growth, New York-London, 1951; W. D. Lawson and S. Nielsen. Preparation of Single Crystals, London, 1958; W. G. Pfann. Zone Melting, New York, 1958; R. O. Grubel. Metallurgy of Elemental and Compound Semiconductors, New York-London, 1960.

Alloy Synthesis under Pressure

Special methods are required when one of the constituent metals of the alloy has a very low boiling point (Zn, Cd, Hg; see also p. 1789) while the other constituent has a high melting point (platinum metals and other transition metals; see Table 4, p. 1776). In this case, if the pressure is atmospheric pressure, one metal tends to vaporize before the other liquefies. Nowotny et al. have designed a special furnace which allows heating such metal combinations in a protective gas at high pressures. The apparatus is essentially a closed iron bomb containing a resistance-heated tube which encloses the crucible (Fig. 351). The furnace mantle *m* is a thick-wall seamless steel tube whose lower section is threaded for 50 mm. and carries a screw cap *v*. This cap in turn carries a threaded adapter which is connected to the compressed gas cylinder, the pressure gage and one of the two electrical terminals. All screw connections are also sealed with lead gaskets *b*. The other end of mantle *m* is closed off by cover plate *d* (a 35-mm.-thick circular steel plate) held in place by flange *f* and connected to the second electrical terminal. The gasket ring *r* is made of insulation-grade asbestos, and the six flange screws are of high-strength nickel-chromium steel (the screws must also be insulated from the flange by sleeves and washers of electrically insulating asbestos or similar material). The inner walls of plate *d* and the cap *v* are threaded so as to support the brass collars *h*₁ and *h*₂. The latter make the electrical connection between the plate and cap and the carbon resistance element which they support. To obtain good electrical contact between the brass collars and the carbon sleeve conductors *g*₁ and *g*₂, the I.D. of the collars is made 0.1 mm. smaller than the O.D. of the corresponding section of the carbon sleeve. The collar is then heated and slipped over the

sleeve while still hot. The heating tube k is made from electrographitized carbon and has a wall thickness of 1.5-1.8 mm. in the long middle section and 4 mm. at the ends. Its ends fit tightly into sleeves g_1 and g_2 .

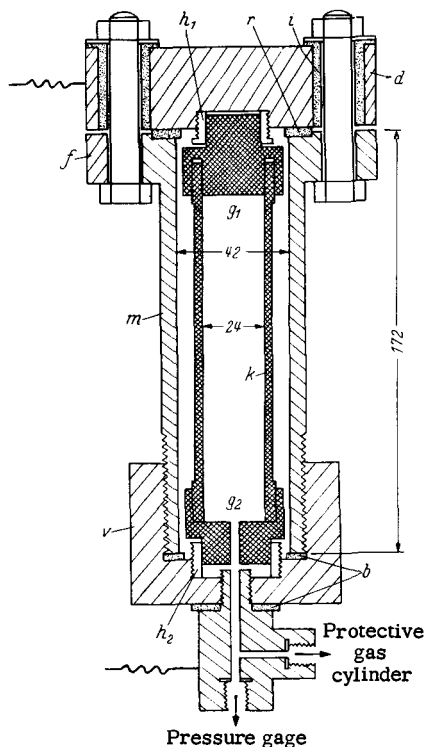

Fig. 351. Tubular furnace for high temperature pressure synthesis. k carbon tube; g_1 , g_2 special carbon sleeve conductors; h_1 , h_2 brass collars; m outer steel tube (mantle); f flange; d cover plate; v screwed-on cap; b lead gaskets; r , i asbestos gas-keting rings and sleeves. Dimensions in mm.

The narrow, high tubular crucible containing the charge is centered in k . The furnace is connected to a low-voltage transformer capable of delivering 600-900 amp. at 12 volts. The apparatus is filled with a protective gas (N_2 or Ar) to 60-70 atm.; the pressure increases rapidly to about 150-200 atm. during heat-up but then decreases again during the actual fusion (it drops to about 70-100 atm. in 10 min.). The temperature cannot be measured directly;

it can only be estimated from the current consumption, assuming otherwise constant conditions (preliminary experiments are helpful). During the run, the furnace is immersed in running water up to the flange while the lid is cooled by spraying water from above.

Electrographitized carbon is a useful crucible material for preparation of alloys of Zn and Cd with Pt or Pd. Alumina crucibles do not last. The volatile-metal loss may approach 25%. The carbon tube and sleeves may last for 40-70 fusions (10 minutes each). Obviously, this furnace is not suitable for metals which readily form stable carbides.

REFERENCE:

H. Nowotny, E. Bauer and A. Stempf. "Alfons-Leon-Gedenkschrift" der Allg. Bau-Zeitung, Vienna, 1951, p. 63.

Melting Without a Container

Under certain conditions it is possible to melt small quantities of metals, alloys and related compounds in such a way that they do not make or barely make contact with the wall of the container. Such a procedure becomes very desirable when one deals with corrosive elements or when products of very high purity are required. However, "containerless" fusion is possible only in special cases. For example, the sample may be heated to melting by means of an electric arc or a directional electron beam; in this case the sample rests in a shallow depression in a cooled copper plate. The molten sample contracts due to surface tension to form an oblate spheroid whose area of contact with the copper support is so small that no contamination occurs during the short fusion process. The resolidified sample is turned over and remelted on the other side. This procedure is called button melting. For heat sources, see Part I, p. 42.

Another melting method is the so-called levitation melting in which the sample is freely suspended in vacuum or in an inert atmosphere by a field developed by means of induction coils, which also supply the heat. This promising method is, however, still in the experimental stage, [E. C. Ocress, D. M. Wroughton, G. Comnetz, P. H. Brace and J. C. R. Kelly, *J. Appl. Phys.* **23**, 545 (1952); *J. Electrochem. Soc.* **99**, 205 (1952)].

Comminution in the Absence of Air

Special precautions must be taken while studying alloys that are extremely sensitive to air, hygroscopic or readily oxidized. This

is especially true of operations in which one is trying to obtain comminuted material, shavings, etc., for density determinations or x-ray powder diagrams, where such material must be completely free of decomposition products. Devices for producing such comminuted alloys have been developed by Zintl et al. (I) and Klemm and Dinkelacker (II).

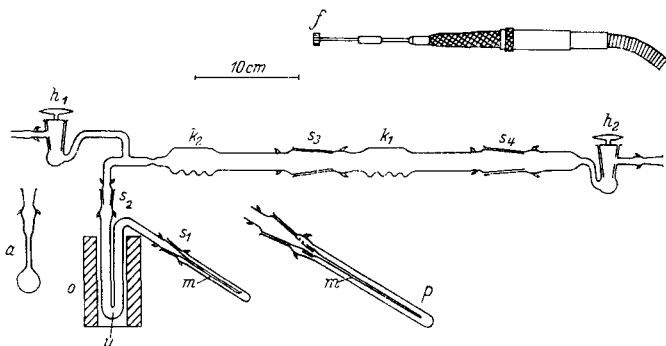

Fig. 352. Comminution of sensitive alloys in the absence of air. k_1 , k_2 working chambers for handling the alloy; h_1 , h_2 high-vacuum stopcocks; m capillary for x-ray sample; u glass tube for annealing the alloy powder; o electric furnace; a adapter with the analysis and sample storage bulb; f rotary milling tool.

I. The apparatus in Fig. 352 consists of several glass parts connected by ground joints s_1 - s_4 . The assembly is connected via Schiff stopcocks h_1 and h_2 (see Part I, p. 59 f.) to a high-vacuum pump and a supply of pure, anhydrous inert gas.

The major constituent parts of the apparatus are two slightly oblate chambers k_1 and k_2 made of medium-wall glass tubing. The underside of each chamber carries three to four corrugations impressed with a carbon rod on the hot, soft tube. These corrugations prevent the alloy from slipping out of the chamber during workup. Depending on need, devices for annealing the comminuted material, for charging the glass capillaries which are used to hold the sample while examining its x-ray powder pattern, or for removal of analytical samples (analysis bulbs) may be added.

Before use, the entire apparatus is thoroughly evacuated over a period of several hours. At the same time, it is carefully heated (to promote removal of moisture) and then connected via stopcock h_1 to the protective gas supply. The blanketing gas is allowed to escape at h_2 . A small piece of the solid alloy is then introduced into chamber k_1 via the ground joint s_4 . A fast stream of the

protective gas is maintained while introducing the sample, following which a loosely fitting rubber cap is put over joint s_4 . This permits the gas to escape while preventing air penetration into k_2 . The surface of the alloy in k_1 is cleaned by means of a small rotary milling tool f (5 mm. O.D.), set on a 12-cm.-long rigid shaft and introduced via s_4 . The rigid shaft is attached to the chuck of a flexible shaft driven by a dental drilling machine. The alloy piece is cleaned on all sides and is then pushed into the chamber k_2 by means of a thick wire or a thin glass rod. The powdered waste material removed from the metal surface must not be entrained from k_1 into k_2 (it can be dislodged from the metal surface by tapping).

When the material is safely in k_2 , k_1 is disconnected at s_3 . The required quantity of clean shavings is then produced from the alloy in k_2 (a new, clean milling tool should be used). After this, s_3 is reconnected to h_2 . Turning and tapping the assembly transfers the fresh alloy shavings (or powder) to tube u (this tube must be prebaked and degassed in high vacuum). The alloy powder in u may then be annealed in the heat produced by furnace o . This treatment removes stresses and is frequently necessary in order to obtain good powder patterns with sharp interference peaks. If very sensitive alloys are handled, the temperature maintained during degassing of tube u must be higher than during the succeeding annealing of the sample. After the annealing, the required quantity of powder is transferred to the capillary tubes m , which are then melt-sealed prior to introduction into the x-ray powder pattern analyzer (the wide end of tube m is cemented to the adapter at s_1 , and a small side opening serves to equilibrate its pressure with that in the protective tube p).

If desired, tube u may be replaced by a bulb for sealing off analytical samples. The net weight of the empty bulb and its adapter (to s_2) is first established. The bulb is then filled with alloy powder and sealed off. It is then reweighed, and the total weight of the oxide-free metal powder can thus be accurately determined.

II. The arrangement of Klemm and Dinkelacker also utilizes a small rotary milling tool for cleaning of the surface and comminution of the alloy chunk. In this method, however, the alloy is not removed from the crucible but is powdered while still in the crucible. The apparatus is shown in Fig. 353.

The thick-wall brass shell a houses vessel b , which can be rotated on axis t . The top of the crucible containing the freshly prepared alloy is sawed off, and the crucible is introduced via the ground-joint adapter c , which slopes upward. The crucible is then firmly fastened in b by means of a small screw r . Vessel b can be turned into any desired position by means of handle d . It is then fixed in that position by turning down screw s , which thus

immobilizes axis *t*. Housing *a* can be evacuated via the ground-metal joint *f*, while additional vessels for further treatment of the alloy (analysis, powder pattern, density determination, etc.) can be attached at a similar joint *e*. The apparatus can be completely sealed and evacuated if handle *d* is taken off and a standard taper cap pushed over the ground joint *g*.

The surface of the alloy in the crucible is cleaned by means of a small, rapidly rotating steel milling tool (5 mm. diameter), driven from a dental drill via a flexible shaft and introduced through joint *c*. The impurities removed from the surface of the alloy are dumped into *e* by turning *b* on axis *t*. A disposable rubber wiper blade *w* cleans off all waste powder from the walls of *a* and pushes it into *e*. The waste is then removed from *e*, the joint is cleaned by blowing through it inert gas, and a new cutting tool is introduced through *c*. The clean alloy shavings (see the previous method) thus produced are removed through *e*.

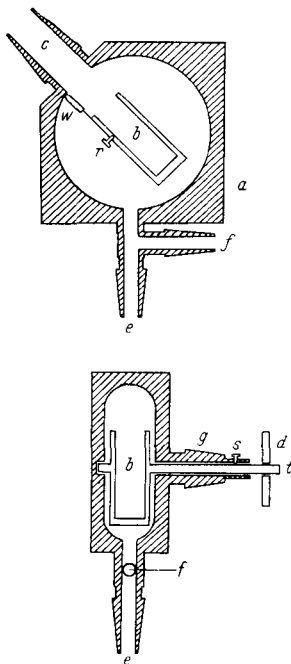

REFERENCES:

- I. E. Zintl, A. Harder and S. Neumayr. *Z. phys. Chem. (A)* **154**, 92 (1931).
- II. W. Klemm and F. Dinkelacker. *Z. anorg. Chem.* **255**, 2 (1947).

Distillation Method

If one component of a desired binary alloy is more volatile than the other and if the decomposition vapor pressure of the alloy is not too high, the alloy can be prepared by distilling or subliming the volatile component onto the other.

However, apart from a few exceptional cases this method is, for obvious technical reasons, restricted to alloys made of relatively volatile metals and metalloids, that is, those boiling below 1000-1100°C at 760 mm. This is because distillation at higher temperatures is quite difficult in practice. (However, much less volatile

Fig. 353. Comminution of alloys in the absence of air without removing the alloy from the crucible. *a* brass housing; *b* vessel housing the crucible and able to rotate; *t* axis on which *b* rotates; *d* handle; *w* rubber wiper blade for scraping off loose particles.

metals can be distilled in small amounts in high vacuum.) The method is therefore suitable for:

Na, b.p. 880°C,	Mg, b.p. 1107°C,	P, b.p. 280°C,
K, b.p. 760°C,	Zn, b.p. 907°C,	As, b.p. 615°C,
Rb, b.p. 700°C,	Cd, b.p. 767°C,	Se, b.p. 688°C.
Cs, b.p. 670°C,	Hg, b.p. 357°C,	

The special advantages of the distillation method are as follows:

a) The volatile component is repurified by the distillation just prior to the reaction (this is important in the case of very reactive metals).

b) The reaction between the vapor of one component and the powder of the other proceeds quietly and smoothly (because of the limited amount of vapor present at any time).

c) Any excess of the volatile component can be distilled off after the reaction.

Each of the components is placed in a separate boat and the boats are positioned one behind the other in a horizontal tube. The choice of boat and tube materials is governed by the same considerations of thermal stability and chemical resistance as were discussed in the case of crucibles (see p. 1775 ff.). The tube must be gas-tight. For this reason, it is usually closed at one end and carries a ground joint on the other (the latter is for evacuation and filling with inert gas); alternatively, it may carry high-vacuum valves or stopcocks on both ends (see Fig. 354). To protect the glass, quartz or ceramic tube *a* against corrosion by the volatile metal, a liner tube *b* (made of glass, ceramic material or metal such as Fe or Ni) may be inserted. Boat *s*₁ contains an excess of the volatile component, while boat *s*₂ is filled with the finest possible powder of the relatively nonvolatile reagent. Boat *s*₁ is also surrounded by a test-tubelike cylinder *c* which acts as a vapor deflector.

At the start of the run, a high vacuum is created in tube *a*. Then the two short, tubular electric heaters are switched on and regulated in such a way that a temperature sufficiently high to maintain a reasonable rate of distillation exists in *s*₁, while a slightly lower temperature exists in *s*₂. The temperature in *s*₂ should be sufficiently high to induce and maintain the reaction between the metal powder and the vapor arriving from *s*₁. At the end of the run, the excess of the volatile component is distilled off and condensed in the cooler section of the tube. Finally, the product is removed from boat *s*₂.

The above method is also useful for purifying a crude product obtained from two components by the crucible or ampoule fusion methods. The excess of the volatile component may thus be removed by vacuum distillation. In this case the vapor pressure of

the free volatile component must, of course, be much higher than its pressure in the residual intermetallic phase. Examples of application of this method are preparations of silicides and germanides of alkali metals, and of Na_3As and K_3Sb .

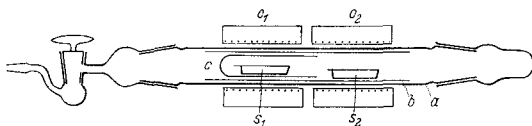

Fig. 354. Preparation of alloys by distillation. *a* reactor tube; *b* liner tube; *c* vapor deflecting cylinder; *s*₁, *s*₂ boats; *o*₁, *o*₂ tubular electric heaters.

The same principle can also be applied to the Faraday sealed-tube system described in Part I, p. 76 f. This system is completely closed and the only external influence consists of the temperature gradient; direct handling is not possible in this case. However, if the reactor tube material is resistant to corrosion by the reagents involved, the Faraday system produces an extremely pure reaction environment.

REFERENCES:

- E. Hohmann. *Z. anorg. Chem.* **257**, 113 (1948); see also this handbook, p. 989 ff.; G. Brauer and E. Zintl. *Z. phys. Chem. (B)* **37**, 323 (1937); G. Brauer and V. Stein. *Z. Naturforsch.* **2** b, 323 (1947).

Residue Methods

Occasionally, a pure component (α) phase may exhibit properties markedly different from those of the intermetallic phase which is vicinal to it on the constitutional diagram. Thus, the α -phase may dissolve more readily in a solvent or it may be attacked more readily by a reagent. In such cases it may be possible to use an excess of the pure component during the high-temperature synthesis and then liberate the intermetallic product by leaching out the matrix phase. Occasionally, also, slow cooling of the alloy melt may yield well-formed crystals of the intermetallic phase embedded in the pure component matrix, which may then be removed by some solvent. Depending on circumstances, the matrix phase may be removed by electrolytic oxidation, by aqueous acids, by bases, or by liquid NH_3 . For example:

- I. Electrolytic solution processes may be used to isolate semi-metallic compounds from the matrix in which they are produced.

Thus, for instance, Fe_3C may be isolated by electrolytic oxidation of the surrounding carbon-rich steel (see p. 1503). Other carbides such as $(\text{Fe}, \text{Cr})_3\text{C}$, $(\text{Cr}, \text{Fe})_7\text{C}_3$, $(\text{Fe}, \text{Mn})_3\text{C}$, $(\text{V}, \text{Fe})_4\text{C}_3$ and $\text{Fe}_3\text{Mo}_3\text{C}$ are prepared in a similar manner. A procedure and an especially elegant apparatus have been developed by Klinger and Koch. This procedure has been employed primarily for the study of steels containing non-metallic admixtures, but should be usable for a more general study of alloys.

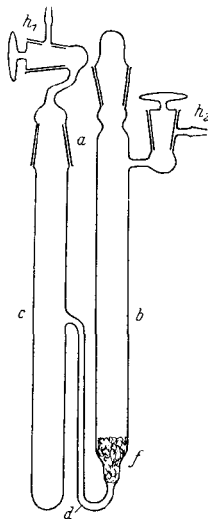

Fig. 355. Extraction of alkali metal alloys with liquid ammonia.

II. Aluminum compounds such as Al_3Ti , Al_3Zr , Al_3Th , Al_3V , Al_3Nb , Al_3Ta , Al_4Ce , Al_4La , AlB_2 , etc., may be isolated from the Al-rich (matrix) products of the corresponding aluminothermic reactions, the solvents being dilute acids or bases. In a similar way, some silicides such as ZrSi_2 , ThSi_2 , VSi_2 , NbSi_2 , TaSi_2 , MoSi_2 , WSi_2 and USi_2 may be produced in molten aluminum "solvent" and then isolated as residues from treatment of the respective aluminum alloys with acids or bases (see p. 1794).

III. A special case is the isolation of intermetallic compounds of alkali or alkaline earth metals (except Be and Mg) by extraction with liquid ammonia. The alkali or alkaline earth metal, in considerable excess, is fused with the alloying component, the mixture is slowly cooled to obtain large crystals, and the solidified melt is then transferred without being exposed to air (the apparatus in Fig. 349 is quite appropriate here) into an extraction apparatus such as the one shown in Fig. 355. This device was developed on the basis of the arrangement of Biltz and Rahlfs (see Part I, Fig. 71). The alloy to be extracted is introduced through *a* and placed on top of the dense glass-wool filter *f*. The stopcocks h_1 and h_2 are both connected to a single vessel so that one can establish a high vacuum in the system, introduce NH_3 to one (or both) tubes, or establish a connection between tubes *b* and *c*. Some NH_3 is condensed in *b*, where it contacts the alloy on *f*; the blue solution of the alkali metal is then allowed to pass via the interconnecting tube *d* into tube *c*. There NH_3 is evaporated, leaving behind the free alkali metal. The NH_3 vapor is recycled to *b* for recondensation. Several repetitions of this operation allow exhaustive extraction of the alloy on *f*. The desired compound, which

is completely resistant to or attacked only slightly by the NH_3 , remains as a residue on *f*.

The apparatus shown in Part I, Fig. 73 may also be used for the extraction of alloys with liquid ammonia.

The above method was used to produce Na_3As , Na_3Sb , Na_3Bi , $\text{Na}_{15}\text{Pb}_4$, $\text{Na}_{15}\text{Sn}_4$, NaZn_{13} and Na_2Au . Pure, well formed single crystals were obtained.

REFERENCES:

- I. P. Klinger and W. Koch in: Handb. f. d. Eisenhüttenlaboratorium [Handbook for Steel Mill Laboratories], Vol. II, Düsseldorf, 1941, p. 441; E. P. Houdremont, P. Klinger and G. Blaschczyk. Arch. Eisenhüttenwesen 15, 257 (1941-42); W. Koch. Stahl und Eisen 69, 1 (1949); P. Klinger and W. Koch. Beiträge zur metallkundlichen Analyse [Analysis of Metals], Düsseldorf, 1950, p. 49.
- II. M. Hansen and K. Anderko. Constitution of Binary Alloys, New York-Toronto-London, 1958; G. Brauer. Z. anorg. allg. Chem. 242, 1 (1939).
- III. F. Weibke. Thesis, Univ. of Hannover, 1928; E. Zintl and H. Kaiser. Z. anorg. allg. Chem. 211, 113 (1933); E. Zintl and A. Harder. Z. Elektrochem. 41, 767 (1935); W. Haucke. Ibid. 43, 712 (1937); E. Zintl and W. Haucke. Ibid. 44, 104 (1938).

Special Processes

Intermetallic and metalloid compounds may also be prepared by methods other than those described in the preceding sections. However, these other processes have so far been used only in special cases, since the necessary conditions tend to limit their general applicability.

I. SIMULTANEOUS CHEMICAL REDUCTION OF NONMETALLIC COMPOUNDS AND ALLOYING OF NASCENT FREE METALS

For instance, reduction of niobium oxide and nickel mixtures by means of hydrogen leads to Ni-Nb alloys [1]. Thermal decomposition of isomorphous mixtures of Fe, Co or Ni formates or oxalates, conducted under reducing conditions, gives fine, crystalline alloy powders. These alloys correspond to phase equilibria at comparatively low temperatures [2].

II. SYNTHESIS OF BINARY ALLOYS AND INTERMETALLIC COMPOUNDS BY COMBINING SOLUTIONS OF BOTH COMPONENTS

The solvent may be a third, more or less inert metal, usually with a low melting point (Hg, Al or Mg). The process temperatures

thus range between ambient and several hundred degrees. For basic data on the precipitation of intermetallic compounds, see [3].

The Hg solution method may be used for the preparation of many intermetallic compounds, as well as very reactive metals. This is because the Hg solvent can be distilled off at a comparatively low temperature. The method can thus be used for preparation of alloys which cannot be obtained by fusing or sintering at high temperatures (see Amalgam Metallurgy [4]).

Aluminum compounds (silicides, borides, and so forth) can be prepared in liquid Al (see p. 1797 ff.). Special silicides may be obtained in liquid Cu (see p. 1796).

Liquid NH_3 may also be used as a solvent, especially in the synthesis of alloys of alkali and alkaline earth metals. However, this method has so far been used mostly for nonmetallic or metalloid alkali compounds [5].

III. ELECTROLYTIC DEPOSITION OF ALLOYS FROM AQUEOUS SOLUTIONS.

The composition of the alloy depends on the composition of the electrolyte, the reaction conditions, and special additives which favor the precipitation. Just as in the case of solidification of melts, alloys precipitated by the electrolytic method consist of heterogeneous crystallizates, solid solutions, or some intermediate phases. They may differ from the alloys produced at high temperatures. The differences may show up in phase boundaries and in some physical and engineering properties [6].

The following binary alloy systems have so far been prepared in this way: Cu-Zn, Cu-Sb, Cu-Bi, Cu-Pb, Ag-Zn, Ag-Cd, Ag-Au, Ag-Bi, Ag-Pb, Au-Cu, Au-Ni, Ni-Zn, Ni-Cd, Ni-Fe, Zn-Cd, Pb-Sn, W-Ni, W-Co and W-Fe.

Some intermetallic or metalloid compounds may also be obtained by high-temperature electrolysis of liquid melts of the corresponding metal compounds. Secondary reactions sometimes play an important role in this case. This method, developed mainly by Andrieux and Doderio [7], has so far been used for borides (see p. 1798), silicides (see p. 1796 f.), phosphides, arsenides and carbides.

REFERENCES:

1. G. Grube, O. Kubaschewski and K. Zwiauer. *Z. Elektrochem.* 45, 881 (1939).
2. F. Lihl. *Metall* 5, 183 (1951); F. Hund. *Z. Elektrochem.* 56, 609 (1952); F. Lihl, H. Wagner and P. Zemsch. *Ibid.* 56, 619 (1952).
3. A. Schneider and J. Stendel. *Z. anorg. allg. Chem.* 303, 227 (1960).

4. G. Jangg and H. Bach. Quecksilber und Amalgamm Metallurgie, Handb. d. techn. Elektrochem. [Mercury and Amalgam Metallurgy, Handbook of Engineering Electrochemistry], Vol. I, Leipzig, 1961. F. Lihl et al. Metall 5, 183 (1951); Z. Metallkunde 43, 307, 310 (1952); 44, 392 (1953); 45, 686 (1954); 46, 434, 579, 787 (1955); 48, 9, 61 (1957); Z. Elektrochem. 58, 431 (1954); Arch. Eisenhüttenw. 25, 475 (1954); Monatsh. Chem. 86, 747, 1031 (1955).
5. Papers of P. Lebeau, A. Joannis and C. Hugot. Comptes Rendus Hebd. Séances Acad. Sci. 114-134 (1892-1902); Papers of E. Zintl et al. Z. phys. Chem. (A) 154, 1, 47 (1931); Z. Elektrochem. 40, 588 (1934); Z. phys. Chem. (B) 37, 323 (1937).
6. Reviews: E. Raub. Metalloberfläche 7, 17 (1953); E. Raub. Feinwerktechnik 53, 205 (1949); 54, 288 (1950).
7. Reviews: L. Andrieux. Ann. Chimie [10] 12, 423 (1929); Chim. et Ind. 27, Special Issue 3, 411 (1932); Rev. Métallurgie 32, 487 (1935); Congr. Chim. Ind. Nancy 18, I, 124; L. Andrieux and G. Weiss. Bull. Soc. Chim. France, Mém, [5] 15, 598 (1948); L. Andrieux and M. Dodero. Comptes Rendus Hebd. Séances Acad. Sci. 198, 753 (1934); M. Dodero. Bull. Soc. Chim. France, Mém. [5] 17, 545 (1950).

Silicides

A summary of processes for the preparation of metal silicides is given in Table 5.

I. MOISSAN'S CLASSICAL PROCESS (FUSION OF THE ELEMENTS)

These reactions are usually highly exothermic; the charge thus heats up far above its melting point, and a closely controlled reaction becomes impossible due to interaction with the walls of the vessel and gases, as well as volatilization of reagents; product purity and the yield are usually poor.

a) Silicides of transition metals, especially those of metals of Groups IV to VII, may be successfully prepared by sintering mixtures of powders of the constituents at comparatively low temperatures (< 1500°C). In this case, external heating must be discontinued promptly at the beginning of the exothermic reaction to avoid melting of the charge. The starting materials must be extremely pure and have a particle size < 0.06 mm. The powder mixtures are either tableted or pressed into alumina or graphite crucibles. They are heated in argon or in vacuum. Under these conditions, side reactions with the crucible materials are usually negligible.

Table 5
Preparation of Metal Silicides

Process	Reactions involved
I. Synthesis from the elements	
a) By fusion	$M + Si \rightarrow MSi$, $MH + Si \rightarrow MSi + H_2$
b) By sintering or sintering under pressure	
II. Reaction of metal oxides with Si or SiO_2 (silicates) and C	$MO + Si \rightarrow MSi + SiO$ $MO + SiO_2 + C \rightarrow MSi + CO$ $M \text{ silicate} + C \rightarrow MSi + CO$ (unfavorable: $MO + Si \rightarrow MSi + SiO_2$) $MO + SiC \rightarrow MSi + CO$)
III. a) Aluminothermic and magnesothermic processes	$MO + Al(Mg) + SiO_2 + S \rightarrow MSi \text{ (in Al)} + Al(Mg)\text{-S-containing slags}$
b) Aluminum silicide process	$Al\text{-}Si + M \rightarrow MSi \text{ (in Al)}$ $Al\text{-}Si + MF_2 \rightarrow MSi \text{ (in Al)} + AlF_3$ $Al\text{-}Si + MO + NaF \rightarrow MSi \text{ (in Al)} + Na_3AlF_6 + Al_2O_3$
c) Copper silicide process	$Cu\text{-}Si + M \rightarrow MSi \text{ (in Cu)}$ $Cu\text{-}Si + MO \rightarrow MSi \text{ (in Cu)} + CuO \cdot SiO_2$
IV. Electrolysis of a melt	$K_2SiF_6 + MO \rightarrow MSi + KF$
V. Vapor-deposition process	$M + SiCl_4 + H_2 \rightarrow MSi + HCl$

b) According to Kieffer and Cerwenka, the density of the material can be increased even during the heating process, the result being a better product. A Tammann furnace (see Part I, p. 39) is used. The powder mixture is pressed into strong, 15-mm.-I.D. graphite molds and heated at 200 kg./cm.² and 1100-1500°C. After cooling, the surfaces of the samples thus obtained are ground, yielding a material containing only 0.02-0.05% C.

II. REDUCTION OF METAL OXIDES WITH Si, SiC OR SiO_2 (SILICATES) IN THE PRESENCE OF CARBON

In general, this process requires very high temperatures and yields fused products from which it is difficult to isolate well-defined

silicides. For this reason, this method is largely of historical interest. However, a modern variant is of some importance. In this variant, very pure Si is added to the metal oxide in the stoichiometric ratio. If the stoichiometric ratio is maintained exactly, all of the oxygen from the metal oxide will be bound to the Si, which then volatilizes as SiO. This method, which requires a vacuum but only relatively modest temperatures, yields very pure silicides.

The above process is applicable in all those cases in which both the metal and its oxide (which is reduced) have low vapor pressures at the reaction temperature (this is true of transition metals of Groups III to VIII). For instance, the process yields pure rare earth silicides, which are otherwise difficult to obtain. In this case the optimum reaction pressure is approximately 0.1 mm.

III. ALUMINOTHERMIC OR MAGNESOTHERMIC PROCESSES

The general method was invented by Hönigschmidt. It starts from metal oxides and SiO₂ and gives pure products if the nascent silicide is embedded in an excess of the reducing metal (preferably Al). This is achieved by using an excess of SiO₂ and of the embedding Al in the reaction mixture. Of course, the embedding aluminum metal becomes alloyed to some extent with the Si and the other metal of the mixture. The object of the embedding process is to form an ingot or nugget which can be easily separated from the surrounding nonmetallic slag. This separation is facilitated by the addition of fluxes (CaF₂, cryolite or CaO) to the reaction mixture (Al₂S₃, which was used by Hönigschmidt, is not recommended). The silicide can then be isolated from the nugget by reaction with dilute acid or alkali. It is obtained in the form of a crystalline powder.

Some processes for silicides start from the metal itself rather than its oxide. The metal is thus reacted with Si in the presence of a melt of a third metal which serves as the solvent. Aluminum is usually the optimum solvent. Another method employs components initially prealloyed with Al (for instance, ThSi₂ is made from Th-Al and Si-Al alloys). Still another process proceeds by stages, whereby the components of the silicide are prepared *in situ* from other compounds, primarily a metal fluoride or oxide and an alkali fluoride. The nascent components then form the silicide.

In all the above variants of the basic process, the silicide is always embedded in excess Al. The process has been used for NbSi₂, TaSi₂, ThSi₂, MoSi₂ and WSi₂.

The Lebeau process, which uses copper as a solvent and an Si carrier, is no longer of any importance.

Alternate methods:

IV. ELECTROLYSIS

Silicides of Ti, Zr and Cr as well as those of the rare earth metals may be obtained by electrolysis of melts of the metals with silicates or fluorosilicates of suitable composition.

V. VAPOR DEPOSITION

Silicide layers may be obtained from H_2 - $SiCl_4$ mixtures by deposition of an incandescent filament.

Procedures for the preparation of silicides are also found in other sections of this book (see Alkali Silicides p. 989 f., magnesium silicide p. 921 f., calcium silicide p. 946 f., silicides of Ti, Zr and Th, p. 1249 f.).

REFERENCES:

- General: R. Kieffer and F. Benesovsky. *Hartstoffe* [Hard Materials], Vienna, 1962; R. Kieffer and F. Benesovsky. *Metall* 6, 171, 243 (1952).
- Ia. H. J. Wallbaum. *Z. Metallkunde* 33, 378 (1941); G. Brauer and W. Scheele. Unpublished experiments, cited in *Naturforschung und Medizin in Deutschland 1939-1946* (FIAT Review) 24, II, p. 106; L. Brewer, A. W. Searcy, D. H. Templeton and C. H. Dauben. *J. Amer. Ceram. Soc.* 33, 291 (1950).
- b. R. Kieffer and E. Cerwenka. *Z. Metallkunde* 43, 101 (1952); G. V. Samsonov, M. S. Kovalchenko and T. S. Verchoglyadova. *Zh. Neorg. Khimii* 4, 2759 (1959).
- II. G. Brauer and H. Haag. *Z. anorg. allg. Chem.* 267, 198 (1952).
- III. O. Hönigschmid. *Monatsh. Chem.* 27, 205 (1906); 28, 1017 (1907); E. Defacqz. *Comptes Rendus Hebd. Séances Acad. Sci.* 147, 1050 (1908); G. Brauer and A. Mitius. *Z. anorg. allg. Chem.* 249, 325 (1942); G. Brauer and H. Haag. *Z. anorg. Chem.* 259, 197 (1949); P. Lebeau. *Comptes Rendus Hebd. Séances Acad. Sci.* 136, 89, 231 (1903); P. Lebeau and J. Figueras. *Ibid.* 136, 1329 (1903).
- IV. M. Doderò. Thesis, Univ. of Grenoble, 1937; *Comptes Rendus Hebd. Séances Acad. Sci.* 199, 566 (1934); *Bull. Soc. Chim. France* 1950, 545.
- V. I. E. Campbell, C. F. Powell, D. Nowicki and B. W. Gonser. *J. Electrochem. Soc.* 96, 318 (1949).

Borides

Table 6 lists the most important processes for the preparation of borides, especially those of the transition metals.

Table 6

Preparation of Metal Borides

Process	Reactions involved
I. Synthesis from the elements	
a) Fusion	$M + B \rightarrow MB, MH + B \rightarrow MB + H_2$
b) Sintering or sintering under pressure	
II. Aluminothermic and magnesothermic processes	$MO + B_2O_3 + Al(Mg) \rightarrow MB + Al(Mg) \text{ oxide}$
III. Reduction of oxides with carbon	$MO + B_2O_3 + C \rightarrow MB + CO$
IV. Boron carbide process	$MO(M, MH) + B_4C(C, B_2O_3) \rightarrow MB + CO$
V. Electrolysis of a melt	$MO + \text{alkali (alkaline earth) borate} + \text{alkali (alkaline earth) fluoride} \rightarrow MB + \text{alkali (alkaline earth) borate-fluoride}$
VI. Vapor-deposition processes	$M \text{ (M halide)} + B \text{ halide} + H_2 \rightarrow MB + \text{hydrogen halide}$

I. Synthesis via fusion of the elements entails such high heats of formation that the reaction temperatures become very high. As a result, there is interaction with the material of the vessel and the product boride becomes contaminated. On the other hand, all borides may be prepared by sintering the appropriate metal with amorphous boron powder, which should be as pure as possible (commercial grades now available contain 97-99% B). The reaction mixtures should be heated in alumina crucibles (W or Mo crucibles or boats may also be used) in vacuum (an argon atmosphere is occasionally also used). The reaction, which is always exothermic, starts at temperatures of 700-1200°C; the highest temperature may lie above 2000°C. In some cases, sintering under pressure in carbon tubes (mentioned as a possible method of synthesis for silicides—see p. 1796) can be used.

II. Reduction with Al or Mg allows the use of oxides as starting materials and eliminates the preparation of pure boron. On the

other hand, this method involves inconvenience of chemical separation of the product boride crystals from by-products. This separation becomes especially difficult in the case of products of the aluminothermic preparation of high-melting borides (those of transition metals of Groups III to VI). No solid ingot or nugget is formed in this case; the fine boride powder is occluded in Al_2O_3 slag. According to Andrieux and Peffen, an excess of B_2O_3 , CaO and Na_2O should be added to the reaction mixture. The alumina slag thus becomes soluble in acids and may be separated more easily from the boride powder.

III. Originally the preparation of borides of metals such as Ti and Zr from B_4C involved a reaction in hydrogen:

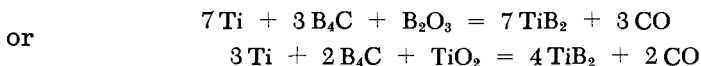

Recently, however, a simpler process has been devised:

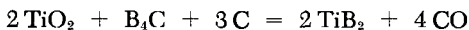

The mixture of starting materials is pressed into pellets and heated in a tubular carbon furnace under high vacuum. Maximum temperatures of 1400-1900°C are required to produce the metal boride within a reasonable time. The method has been tested for borides of Ti, Zr, V, Nb, Ta and W.

Alternate methods:

IV. Small quantities of pure boron compounds can be prepared by electrolysis of melts. Boron, which is evolved on the cathode from alkali and alkaline earth borates, combines with the simultaneously precipitated metal.

V. Passage of gaseous mixtures consisting of a metal halide, BBr_3 and H_2 over incandescent carrier metals on the average yields only boride layers inhomogeneous, and solid products.

REFERENCES:

- General: R. Kieffer and F. Benesovsky. Hartstoffe [Hard Materials], Vienna, 1962; R. Kieffer and F. Benesovsky. Metall 6, 171, 243 (1952).
- Ia. H. Moissan. Der elektrische Ofen [Electrical Furnace], Berlin, 1900; F. Wedekind. Ber. dtsh. chem. Ges. 46, 1198 (1913); Binet du Jassonneix. Comptes Rendus Hebd. Séances Acad. Sci. 143, 169, 897, 1149 (1906).
- b. R. Kiessling. Acta Chem. Scand. 4, 209 (1950); P. Ehrlich. Z. anorg. Chem. 259, 1 (1949); L. Brewer, D. L. Sawyer,

- D. H. Templeton and C. H. Dauben. *J. Amer. Ceram. Soc.* **34**, 173 (1951); H. Nowotny, F. Benesovsky and R. Kieffer. *Z. Metallkunde* **50**, 258, 417 (1959).
- II. E. Wedekind. *Ber. dtsh. chem. Ges.* **46**, 1198 (1913); J. T. Norton, H. Blumenthal and S. J. Sindeband. *Trans. AIME* **185**, 749 (1949); S. J. Sindeband. *Ibid.* **185**, 198 (1949); J.-L. Andrieux and R. Peffen. *French Patent* 1,123,861 (1956).
- III. P. M. McKenna. *Ind. Eng. Chem.* **28**, 767 (1936).
- IV. R. Kieffer, F. Benesovsky and E. R. Honak. *Z. anorg. allg. Chem.* **268**, 191 (1952); G. A. Meyerson and G. V. Samsonov. *Zh. Prikl. Khimii* **27**, 1115 (1954); C. T. Baroch and T. E. Evans. *J. Metals* **7**, 908 (1955).
- V. L. Andrieux. Thesis, Univ. of Paris, 1929; *Rev. Métallurg.* **45**, 49 (1948); G. Weiss. Thesis, Univ. of Grenoble, 1946; *Ann. Chimie* **1**, 446 (1946); J. T. Norton, H. Blumenthal and S. J. Sindeband. *Trans. AIME* **185**, 749 (1949).
- VI. M. Moers. *Z. anorg. Chem.* **198**, 243 (1946); J. E. Campbell, C. F. Powell, D. Nowicki and B. W. Gonser. *J. Electrochem. Soc.* **96**, 318 (1949).

Amalgams

While some low-melting (< 1000°C) metals fail to form alloys with mercury, the majority may be amalgamated simply by heating

Table 7

Solubility of Metals in Mercury at about 20°C
(after Jangg and Bach)

Metal	Solubility in weight %	Metal	Solubility in weight %	Metal	Solubility in weight %
Ag	0.03	In	57	Ru	0.35
Al	$2.3 \cdot 10^{-3}$	K	0.38	Sb	$2.9 \cdot 10^{-5}$
As	0.24	La	0.013	Si	$1 \cdot 10^{-3}$
Au	0.13	Li	0.036	Sn	0.87
Ba	0.33	Mg	0.31	Sr	1.0
Be	$1 \cdot 10^{-3}$	Mn	$1.7 \cdot 10^{-3}$	Ta	0.01
Bi	1.4	Mo	$< 2 \cdot 10^{-6}$	Th	0.016
Ca	0.3	Na	0.62	Ti	$1 \cdot 10^{-5}$
Cd	~ 5.0	Ni	$2 \cdot 10^{-6}$	U	$1 \cdot 10^{-5}$
Co	$< 1 \cdot 10^{-6}$	Pb	1.5	V	$1 \cdot 10^{-5}$
Cr	$< 4 \cdot 10^{-7}$	Pd	0.06	W	$1 \cdot 10^{-5}$
Cu	$2 \cdot 10^{-3}$	Pt	$2 \cdot 10^{-3}$	Zn	2.0
Fe	$< 5 \cdot 10^{-7}$	Rb	1.4	Zr	$3 \cdot 10^{-3}$
Ge	$1 \cdot 10^{-3}$	Rh	0.16		

with mercury in closed iron crucibles or glass ampoules. Under special circumstances, these vessels may also contain special insert crucibles (see p. 1774 ff.). This simple process applies to all permissible amalgam compositions.

Another general method for preparation of amalgams consists of the electrolysis of solutions of the respective metal salts in cells comprising an Hg cathode. The concentrations of the respective metals in the amalgam reach very high levels so that solid phases may separate. The method is applicable even to metals with extremely low solubility in Hg (for example, Fe); in this case, the method gives suspensions of the metal in Hg which exhibit behavior very similar to that of "true" amalgams (see Table 7).

REFERENCE:

- G. Jangg and H. Bach. Quecksilber- und Amalgamm Metallurgie, Handbuch d. techn. Elektrochemie [Mercury and Amalgam Metallurgy, Handbook of Engineering Electrochemistry], Vol. I, Leipzig, 1961.

It is sometimes desired to prepare liquid or semisolid amalgams of base metals for special purposes, especially for use as laboratory reducing agents. The following simple methods apply in these cases:

SODIUM AMALGAM (LIQUID; ABOUT 1% Na)

I. Clean sodium metal (11.5 g.) is cut into 5-mm. cubes. The cubes are speared with a pointed glass rod and rapidly introduced below the surface of warm (30-40°C) pure mercury (1150 g. = 85 ml.) contained in a 500-ml. wide-neck Erlenmeyer flask. The flask is covered with cardboard to prevent spattering during the rather vigorous amalgam formation reaction.

II. In another method, 3.5 g. of Na protected by a layer of toluene (10-15 ml.) is melted in a 250-ml. Erlenmeyer flask placed on a hot plate. Then, 340 g. (25 ml.) of Hg is added in drops (stirring or shaking). The first few drops of mercury cause a vigorous reaction, but then the amalgam formation becomes less violent. The toluene boils during the entire addition; at the end, it is decanted or displaced with other liquids.

The following method for solid amalgams may be modified and adapted to other ratios of reagents.

SODIUM AMALGAM (SOLID; ABOUT 2-3% Na)

I. The Fieser procedure gives especially pure material: Clean sodium pieces (6.9 g. for an amalgam containing 2% Na, 10 g. for one containing 3% Na) are placed in a 250-ml. three-neck

round-bottom flask. The two side necks carry nitrogen inlet and outlet tubes, while the center neck carries a dropping funnel containing 340 g. (25 ml.) of Hg. The flask is thoroughly flushed with N_2 , and 10 ml. of Hg is then added. The flask is heated on an open flame until the start of the reaction. Additional Hg is then slowly added, with minimum additional heating. After the addition, the hot molten amalgam is poured onto a clean plate and broken up into pieces while still hot and brittle.

II. Another method is useful for preparation of larger quantities of amalgam. Thus, for example, 51 g. of clean, freshly cut sodium is heated in an enameled pot (about 18 cm. I.D.) under paraffin oil until molten (the thickness of the protective oil layer should be 1 cm.). Then, 1650 g. (122 ml.) of Hg is added slowly (constant stirring) from a dropping funnel. This reaction ends within 3-4 minutes, and most of the paraffin is decanted. The amalgam solidifies at about 250°C. During cooling, it is comminuted with a heavy pestle to form small beads. Alternatively, the hot liquid amalgam may be poured (together with the adhering oil) into a porcelain dish and allowed to solidify; the cake is then broken up to the desired particle size in a mortar. After complete cooling the oil is removed by washing with petroleum ether or benzene. The solvent is then evaporated, and the product stored in an air-free atmosphere.

PROPERTIES:

Amalgams containing less than 3% Na are not too sensitive to air; however they must be stored in an air-free atmosphere. Complete liquefaction occurs at the following (liquidus) temperatures: 0.5% Na, 0°C; 1.0% Na, 50°C; 1.5% Na, 100°C; 2.0% Na, 130°C; 2.5% Na, 156°C; 3% Na, 250°C; 4.0% Na, 320°C.

REFERENCES:

Organic Syntheses, Collective Volume 1, New York-London, 1941, p. 539; W. R. Renfrow, Jr., and C. R. Hauser in: Organic Syntheses, Collective Volume 2, New York-London, 1950, p. 609; V. Deulofeu and T. H. Guerrero in: Organic Syntheses, Vol. 22, New York-London, 1947, p. 92; S. H. Babcock in: H. S. Booth. Inorganic Syntheses, Vol. 1, New York-London, 1939, p. 10; L. F. Fieser. Experiments in Organic Chemistry, New York, 1941, p. 419,

POTASSIUM AMALGAM

For preparation, see A. Roeder and W. Morawietz, Z. Elektrochem. 60, 431 (1956).

CALCIUM AMALGAM

The reactor is a small steel bomb *b* (Fig. 356). The vertical part of the top opening carries a flat thread into which is screwed the steel head *k*. While the two parts should fit each other well, one should be to unscrew *k* without too much difficulty. The conical extended surface above the thread provides additional sealing area. The seal should hold at better than 70 atm. The head *k* carries a pressure-reducing valve *r* connected to pressure gage *m* and pressure tubing *d*, which leads to a compressed nitrogen cylinder.

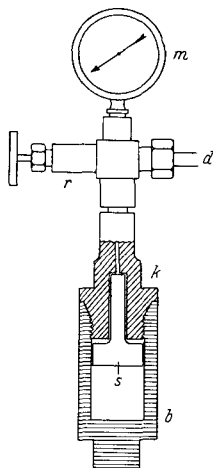

Fig. 356. Preparation of calcium amalgam. *b* steel bomb, 19 cm. long, 5.5 cm. I.D., 9 mm. wall thickness; capacity 45 ml. up to the screw thread; *s* movable piston; *k* steel head; *r* pressure-reducing valve; *m* pressure gage; *d* copper pressure tubing for introduction of N_2 .

A piston *s*, located inside the bomb and actuated by the gas from the cylinder, fits the walls fairly tightly.

To start with, the bomb is charged with 35 ml. of pure Hg. Then, 7-10 g. of shavings of commercial Ca are added and the piston set in place. The bomb is tightly closed and nitrogen injected to a pressure of 60-70 atm. above the piston. The formation of the amalgam starts immediately, heat of reaction is evolved, and the bottom of the bomb becomes hot; the reaction ends in no more than 10-15 minutes. The pressure is released and the bomb is opened. The amalgam is rapidly transferred to a dry, wide-neck flask of about 60-ml. capacity, which is then tightly closed. The steel bomb is rinsed with some pure Hg. This material is added to the flask, which is then filled with Hg to just below the stopper (the amalgam in the flask heats up considerably on dilution with the Hg). The mixture is shaken well and allowed to cool.

PROPERTIES:

This amalgam contains about 1% Ca; sometimes solidifies in the cold; can be stored indefinitely in containers completely filled with mercury. According to data in M. Hansen and K. Anderko, Constitution of Binary Alloys, the liquidus curve in the Ca-Hg system rises to about 260°C at 2% Ca, 140°C at 1% Ca, and 25°C at 0.3% Ca; most of this amalgam solidifies at the peritectic point of -39°C.

REFERENCE:

A. Brukl. *Angew. Chem.* **52**, 151 (1939).

STRONTIUM AND BARIUM AMALGAMS

Strontium and barium amalgams are prepared by electrolysis of solutions of the corresponding chlorides on mercury cathodes. The directions for the compound are each applicable to the other.

STRONTIUM AMALGAM

The cell *a* of the apparatus shown in Fig. 357 contains about 300 ml. of a saturated solution of pure SrCl_2 , made weakly acidic with HCl (if contaminated with traces of Na and Fe the salt must be prepurified). The cathode *b* consists of 600 g. (45 ml.) of pure, distilled Hg . The thick Pt wire *c*, which dips into the mercury pool, is the current lead. The anode is a graphite rod *e* (10 mm. O.D.) suspended in a porous clay cell *d* which dips into the liquid. The electrolysis proceeds at a current of 6.5 amp. (that is, at 1.7 amp./in.², considering the 24 cm.² of cathode surface). The passage of the current causes a sharp temperature rise and the electrolyte is maintained at the optimum temperature of 38–40°C by means of cooling coils *g* and *f* wound on the outer surface of cell *a* and immersed in the solution. The liquid in the anode space is replaced every 15 minutes to prevent accumulation of Cl_2 and its penetration into the cathode space. The Sr content in the Hg reaches 1.3% in 90 minutes; at this point the amalgam becomes a slurry because the liquidus point for this composition is reached. The current is shut off and the electrolyte is poured out from the cell. The amalgam is then removed, washed several times with water, and dried with filter paper.

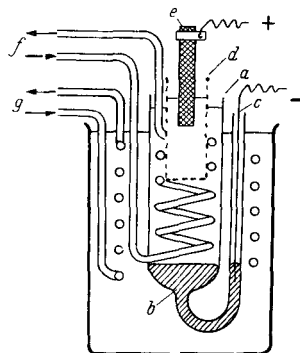

Fig. 357. Preparation of strontium amalgam. *a* electrolysis cell; *b* mercury cathode; *c* current lead (Pt wire); *d* porous clay cell; *e* anode (graphite rod); *f*, *g* water-cooled coils.

PROPERTIES:

Silvery, shiny, solid at room temperature. Must be stored in air-free atmosphere.

REFERENCE:

L. Holleck and W. Noddack. *Angew. Chem.* 50, 819 (1937).

BARIUM AMALGAM (APPLICABLE ALSO TO STRONTIUM AMALGAM)

The cell consists of a 250-ml. beaker. The cathode is a pool of 250 g. (18 ml.) of pure mercury. A Pt wire, all of it except for the tip sealed in glass to prevent contact with the electrolyte, dips into the mercury pool and serves as the current lead. The anode is a horizontal sheet of Pt, 5-10 cm.² in area.

The cell is filled with 100 ml. of saturated BaCl₂ solution. The electrolysis proceeds at a current of 1.75-2.5 amp. and 6-7 v. The current should be shut off after 2.5 hours, since beyond that time there occurs a sharp voltage rise, evolution of gas at the cathode and decomposition of the amalgam. Sometimes, crystalline amalgam particles deposit on the mercury surface and interfere with the electrolysis. This deposition may be prevented by slow agitation with a stirrer, or the crystals may be pushed into the body of the mercury with a glass rod.

At the end of the run the solution is decanted and the amalgam is thoroughly washed with distilled water, followed by ethanol and ether. It contains about 3% Ba. It is stored in an air-free atmosphere.

REFERENCES:

G. McPhail Smith and A. C. Bennett. *J. Amer. Chem. Soc.* 31, 804 (1909); B. C. Marklein, D. H. West and L. F. Audrieth in: H. S. Booth. *Inorg. Syntheses*, Vol. 1, New York-London, 1939, p. 11.

ZINC, CADMIUM, TIN, LEAD AND BISMUTH AMALGAMS (LIQUID)

The liquid zinc amalgam (2-3% Zn) is prepared from 4 g. of zinc (granules, shavings; preferably, however, foil). The zinc is degreased with ether, thoroughly washed with dilute H₂SO₄, placed in a 100 ml. flask, and heated on a water bath together with 200 g. (14.8 ml.) of Hg and 2 ml. of 1N H₂SO₄. The Zn dissolves completely in about 20 minutes. The liquid amalgam is repeatedly washed with very dilute H₂SO₄, cooled and separated in a dropping funnel from solid particles (β or γ phase, composition approx. HgZn₂). These solids may be used to enhance the Zn concentration of amalgams that have lost some Zn during use. The liquid Cd and Bi amalgams (each containing about 3% of the respective metal)

are prepared in an analogous fashion. However, the Bi amalgam is prepared with hydrochloric rather than sulfuric acid. The Sn amalgam (8% Sn) is prepared by heating Sn granules with Hg under hydrochloric acid. The liquid Pb amalgam (3% Pb) by heating dry Pb with the stoichiometric quantity of Hg (the starting Pb must be freed of surface oxide by treatment with conc. HCl). The amalgam product is washed with water.

PROPERTIES:

The above liquid amalgams are very stable and may be stored for a long time under weakly acidic water, with which they react extremely slowly.

Used as reducing agents in volumetric analyses.

REFERENCES:

- E. Brennecke. Flüssige Amalgame als Reduktionsmittel in der Massanalyse [Liquid Amalgams as Reducing Agents in Volumetric Analysis], in: Brennecke, Fajans, Furmann, Lang and Stamm. Neuere Massanalytische Methoden [New Methods of Volumetric Analysis], Stuttgart, 1951; also contains references to original publications. C. Winterstein. Z. anal. Chem. 117, 81 (1939).

AMALGAMS OF RARE EARTH METALS

Amalgams of rare earth metals (3% of the metal) are readily obtained by electrolysis of alcoholic solutions of the corresponding anhydrous chlorides at an Hg cathode and a graphite anode. These amalgams may be then further concentrated by distilling off the excess Hg.

REFERENCES:

- E. E. Jukkola, L. F. Audrieth and B. S. Hopkins in: H. S. Booth. Inorg. Syntheses, Vol. 1, New York-London, 1939, p. 15.

ALUMINUM AMALGAM

The normal procedure is to deposit only a surface layer of amalgam on the metal, in order to activate it for use in some specific reaction [H. Adkins, J. Amer. Chem. Soc. 44, 2175 (1922)].

Potassium-Sodium Alloy (liquid)

The constitutional diagram of the K-Na system shows a liquidus curve minimum at -12.5°C corresponding to 77.3 wt. % K. All alloys with compositions near this point (45-90 wt. % K) are liquids at room temperature and are much more reactive than the pure metals.

Alloys such as these are prepared by carefully heating, for instance, 3 g. of clean pieces of K and 1 g. of clean pieces of Na (or other required quantities of these metals) under anhydrous toluene or xylene, while kneading the two metals with a flat-end glass rod.

According to Lecher, the metals may be combined even at room temperature provided some ethanol is added to the protective fluid in order to activate the metal surface. The vessel is a Schlenk flask, which consists of a two-neck glass bulb (one of these necks is narrow and vertically centered, the other is inclined and somewhat to the side of the flask). An alloy useful in organic reactions may be obtained from 0.35 g. of Na and 1.6 g. of K, which are combined under weakly alcoholic ligroin while a stream of nitrogen is introduced via the side neck (the metals are kneaded by means of a flat-end glass rod introduced through the vertical neck). After a liquid alloy has been obtained, the nitrogen purge is continued while the alcoholic ligroin (including the impurities suspended in it) is replaced by clean, anhydrous ligroin.

The Schlenk flask may, of course, be replaced by other devices which allow work in the absence of air. The liquid alloy ignites spontaneously and must always be protected by an inert fluid and an inert gas (N_2 , CO_2).

REFERENCES:

- H. Lecher. *Ber. dtsh. chem. Ges.* **48**, 524 (1915). For constitutional diagrams and crystal structures of the K-Na and other binary systems of alkali metals, see also A. Helms and W. Klemm. *Z. anorg. allg. Chem.* **242**, 201 (1939).

Low-Melting Alloys

Low-melting alloys are often required for special purposes such as for heating baths or manometers, sealing in other liquids or gases, cementing, and for flowout devices. Some of these alloys, all of which are reasonably stable in air at their melting points and somewhat above, are listed below.

Designation	M.p., °C	Composition, wt. %
Bi-Cd-Pb-Sn eutectic (Wood's Lipowitz metal)	71	49.5 Bi/10.1 Cd/27.3 Pb/13.1 Sn
Bi-Cd-Pd eutectic	91.5	51.7 Bi/8.1 Cd/40.2 Pb
Bi-Pb-Sn eutectic (Newton's Rose metal)	96	50 Bi/31.2 Pb/18.8 Sn
Bi-Cd-Sn eutectic	103	54 Bi/20 Cd/26 Sn
Bi-Pb eutectic	125	56.5 Bi/43.5 Pb
Bi-Sn eutectic	139	58 Bi/42 Sn
Cd-Pb-Sn eutectic	145	18.2 Cd/32 Pb/49.8 Sn
Pb-Sn eutectic	183	37.7 Pb/62.3 Sn
Sn-Zn eutectic	198.6	91.1 Sn/8.9 Zn
Cd-Zn eutectic	266	82.6 Cd/17.4 Zn
Ag-Pb eutectic	304	2.5 Ag/97.5 Pb

Further special alloys can be obtained with Ga and In:

Designation	M.p., °C	Composition, wt. %
Ga-In-Sn-Zn eutectic	3	61 Ga/25 In/13 Sn/1 Zn
Ga-In-Sn eutectic	5	62 Ga/25 In/13 Sn
Ga-In-Zn eutectic	13	67 Ga/29 In/4 Zn
Ga-In eutectic	16	76 Ga/24 In
Ga-Sn eutectic	20	92 Ga/8 Sn
Ga-Zn eutectic	25	95 Ga/5 Zn
L 46	46.5	40.6 Bi/8.2 Cd/18 In/22.4 Pb/ 10.8 Sn
L 58	58	49 Bi/21 In/18 Pb/12 Sn
In-Sn eutectic	117	52 In/48 Sn

An exhaustive review of alloys melting between -39°C and $+419^{\circ}\text{C}$ is given by Spengler. If the low-melting alloys are used as cements or solders for nonmetallic objects, or if they are melted in nonmetallic vessels, then the thermal expansion coefficients must be carefully considered. For instance, Wood's metal may, on cooling and resolidification, burst glass vessels in which it is contained for use as a bath liquid.

REFERENCES:

- H. Spengler. Metall 9, 682 (1955); Z. Metallkunde 46, 464 (1955);
J. D'Ans and E. Lax. Taschenbuch f. Chemiker and Physiker

[Handbook for Chemists and Physicists], Berlin-Göttingen-Heidelberg, 1959; M. Hansen and K. Anderko. Constitution of Binary Alloys, New York-Toronto-London, 1958; C. J. S. Smithells. Metals Reference Book, London, 1949; M. T. Ludwig (The Indium Corp. of Amer.), Indium etc., New York, 1950; W. Kroll. Metallwirtschaft 11, 435 (1932).

Formula Index

pp 1-992: Vol. 1; pp 1003-1810: Vol. 2

NOTE: Rare earth elements (lanthanides) are designated by the common symbol Ln (except in special cases where R.E. has been used). Thus, for their compounds see under Ln.

<p>A</p> <p>Ag 1029, 279, 1028</p> <p>Ag₂C₂ 1047</p> <p>Ag(CF₃COO) 205</p> <p>Ag₂C₄H₄O₆ 1049</p> <p>AgCN 661</p> <p>Ag₂CN₂ 1047</p> <p>Ag₂CO₃ 1048</p> <p>AgClO₃ 1037</p> <p>[Ag(dipyr)₃](ClO₄)₂ 1050</p> <p>[Ag(dipyr)₂]NO₃ 1050</p> <p>[Ag(dipyr)₃](NO₃)₂ 1051</p> <p>[Ag(dipyr)₂]S₂O₈ 1051</p> <p>AgF 240</p> <p>AgF₂ 241</p> <p>Ag₂F 239</p> <p>AgI 1035</p> <p>AgMnO₄ 1463</p> <p>AgN₃ 1045</p> <p>Ag₃N 1046</p> <p>AgNCS 671</p> <p>AgNH₂ 1043</p> <p>AgNO₂ 1048</p> <p>Ag₂N₂O₂ 493, 514</p> <p>Ag₂O 1037</p> <p>Ag₂O₂ 1038</p> <p>Ag₂O·4WO₃·aq 1728</p> <p>AgPO₂(NH₂)₂ 582</p> <p>[Agphen₂]S₂O₈ 1050</p> <p>Ag₂S 1039</p> <p>Ag₂SO₃ 1043</p> <p>Ag₂SO₄ 1042</p>	<p>Ag₂Se 1041</p> <p>Ag₂SiO₃ 705</p> <p>Ag₂Te 1042</p> <p>AlAs 831</p> <p>AlAsO₄ 831</p> <p>AlB₂ 772, 1792</p> <p>AlB₁₂ 772</p> <p>AlBr₃ 806, 813</p> <p>AlBr₃·H₂S 819</p> <p>Al₄C₃ 832</p> <p>Al(C₂H₅)₃ 810</p> <p>Al(C₂H₅)₂Br 809</p> <p>Al(CH₃COO)₃ 835</p> <p>Al(C₂H₅)₂Cl·O(C₂H₅)₂ 811</p> <p>Al(C₂H₅)₂H 811</p> <p>Al(C₅H₇O₂)₃ 836</p> <p>Al(C₂H₅)₃·O(C₂H₅)₂ 811</p> <p>Al(CN)₃·O(C₂H₅)₂ 834</p> <p>Al₄Ce 1792</p> <p>AlCl₃ 680, 805, 812</p> <p>Al₂Cl₃H₃ 808</p> <p>AlCl₃·6H₂O 815</p> <p>AlCl₃·NH₃ 817</p> <p>AlCl₃·PCl₅ 818</p> <p>AlCl₃·SO₂ 817</p> <p>Al₂Cl₆·SOCl₂ 818</p> <p>AlF₃ 225</p> <p>AlF₃·3H₂O 225</p> <p>AlH₃·N(CH₃)₃ 809</p> <p>AlH₃·2N(CH₃)₃ 809</p> <p>(AlH₃)_n·xO(C₂H₅)₂ 807</p> <p>AlI₃ 814</p>	<p>AlI₃·6NH₃ 819</p> <p>Al₄La 1792</p> <p>AlN 827</p> <p>Al(N₃)₃ 829</p> <p>Al₃Nb 1792</p> <p>Al₂O₃ 824, 1660</p> <p>Al(OCH₃)₃ 833</p> <p>Al(OC₂H₅)₃ 834, 835</p> <p>Al(OC₂H₄)₃N 835</p> <p>Al(OD)₃ 134</p> <p>Al(OH)₃ 676, 810, 820</p> <p>AlOOH 820</p> <p>Al₂O₃·2SO₂·H₂O 824</p> <p>Al₂O₃·3SO₂·xH₂O 824</p> <p>AlP 829</p> <p>AlPO₄ 831</p> <p>Al₂S₃ 134, 700, 823</p> <p>AlSb 831</p> <p>Al₂Se₃ 825</p> <p>Al₃Ta 1792</p> <p>Al₂Te₃ 826</p> <p>Al₃Th 1792</p> <p>Al₃V 1792</p> <p>Al₃Zr 1792</p> <p>Ar 82</p> <p>As 591</p> <p>AsBr₃ 597</p> <p>AsCl₃ 596</p> <p>AsF₃ 179, 197</p> <p>AsF₅ 198</p> <p>AsH₃ 593</p> <p>As₂H₄ 594</p> <p>AsI₂ 598</p> <p>AsI₃ 597</p>
---	---	---

pp 1-992: Vol. 1; pp 1003-1810: Vol. 2

- As_2O_3 600
 As_2O_5 601
 $\text{As}_2\text{O}_5 \cdot \frac{5}{2}\text{H}_2\text{O}$ 601
 $\text{As}_2\text{O}_5 \cdot 6\text{MoO}_3 \cdot aq$ 1736
 $\text{As}_2\text{O}_5 \cdot 18\text{MoO}_3 \cdot aq$
 1735
 As_2S_5 603
 As_4S_4 603
 As_2Zn_3 594
 Au 1052
 Au_2C_2 1063
 AuCN 1064
 AuCl 1055
 AuCl_3 1056
 Au_2O_3 1059
 Au(OH)_3 1060
 AuS 1062
 Au_2S 1061
 Au_2S_3 1063
- B**
- B 770
 B_2Al 772
 B_{12}Al 772
 BaSO_4 797
 BBr_3 770, 781
 $\text{B(CH}_3)_3$ 798
 $\text{B(C}_2\text{H}_5)_3$ 799
 $\text{B(C}_n\text{H}_{2n+1})_3$ 800
 BCl_3 780
 $\text{BCl}_2(\text{C}_n\text{H}_{2n+1})$ 803
 BF_3 219
 $\text{BF}_2(\text{n-C}_4\text{H}_9)$ 802
 $\text{BF}_3 \cdot 2\text{H}_2\text{O}$ 784
 $\text{BF}_3 \cdot \text{NH}_3$ 785
 $\text{BF}_3 \cdot \text{O(C}_2\text{H}_5)_2$ 786
 B_2H_6 773
 $\text{BH}_3 \cdot \text{N(CH}_3)_3$ 778
 BI_3 782
 BN 789
 $\text{B(N}_3)_3$ 476
 $\text{B}_3\text{N}_3\text{Cl}_3\text{H}_3$ 779
 $\text{B}_3\text{N}_3\text{H}_6$ 779
 B_2O_3 787
 $\text{B(OCH}_3)_3$ 797
 $\text{B}_3\text{O}_3(\text{CH}_3)_3$ 800
 $\text{B}_3\text{O}_3(\text{n-C}_4\text{H}_9)_3$ 801
 $\text{B(OH)}_2\text{CH}_3$ 800
 $\text{B(OH)}_2(\text{n-C}_4\text{H}_9)$ 801
 $\text{B}_2\text{O}_3 \cdot 24\text{WO}_3 \cdot aq$ 1716
 BPO_4 796
 B_2S_3 788
 Ba 922
 BaBr_2 930
 $\text{Ba(BrO}_3)_2 \cdot \text{H}_2\text{O}$ 316
 BaCO_3 933
 BaCS_3 674
 BaCl_2 930
 $\text{Ba(ClO}_3)_2 \cdot \text{H}_2\text{O}$ 314
 $\text{Ba(ClO}_4)_2$ 320
 $\text{Ba(ClO}_4)_2 \cdot 3\text{H}_2\text{O}$ 320
 Ba_2CrO_4 1393
 $\text{Ba}_3(\text{CrO}_4)_2$ 1394
 $\text{Ba}_2[\text{Cu(OH)}_6]$ 1685
 BaF_2 234
 $\text{Ba}_3[\text{Fe(OH)}_6]_2$ 1691
 $\text{Ba}_2[\text{Fe(OH)}_7] \cdot \frac{1}{2}\text{H}_2\text{O}$ 1691
 BaGeF_6 215
 BaH_2 929
 $\text{Ba}_3\text{H}_4(\text{IO}_6)_2$ 326
 $\text{Ba(H}_2\text{PO}_4)_2 \cdot \text{H}_2\text{O}$ 557
 $\text{BaH}_2\text{P}_2\text{O}_6 \cdot 2\text{H}_2\text{O}$ 562
 BaI_2 930
 $\text{Ba(MnO}_4)_2$ 1462
 $\text{Ba(N}_3)_2$ 942
 $\text{Ba(N}_3)_2 \cdot \text{H}_2\text{O}$ 942
 Ba_3N_2 940
 BaO 933
 BaO_2 937
 $\text{BaO}_2 \cdot 8\text{H}_2\text{O}$ 936
 $3\text{BaO} \cdot \text{P}_2\text{O}_5 \cdot 24\text{MoO}_3 \cdot aq$
 1732
 $10\text{BaO} \cdot \text{P}_2\text{O}_5 \cdot 24\text{V}_2\text{O}_5 \cdot aq$
 1740
 $3\text{BaO} \cdot \text{P}_2\text{O}_5 \cdot 24\text{WO}_3 \cdot aq$
 1721
 $\text{Ba}_3(\text{PO}_2\text{S}_2)_2 \cdot 8\text{H}_2\text{O}$ 572
 $\text{BaPt(CN)}_4 \cdot 4\text{H}_2\text{O}$ 1576
 BaReO_4 1485
 $\text{Ba(ReO}_4)_2$ 1485
 $\text{Ba}_3(\text{ReO}_5)_2$ 1487
 BaS 938
 $\text{Ba(SO}_3\text{F)}_2$ 173
 $\text{BaS}_2\text{O}_6 \cdot 2\text{H}_2\text{O}$ 397
 $\text{BaSO}_4 \text{--KMnO}_4$ 1463
 BaSe 939
 BaSeO_4 939
 BaSi 947
 BaSiO_3 706
 BaSi_2O_5 706
 $\text{Ba[Sn}_2\text{O(OH)}_4]$ 1696
 BaTe 940
 Be 887
 BeBr_2 891
 BeC_2 899, 900
 Be_2C 899
 $\text{Be(CH}_3\text{COO)}_2$ 901
 BeCO_3 893
 BeCl_2 889
 BeF_2 231
 BeI_2 892
 $\text{Be(N}_3)_2$ 899
 Be_3N_2 898
 BeO 893
 $\text{Be}_4\text{O(CH}_3\text{COO)}_6$ 901
 $\text{Be}_4\text{O(C}_2\text{H}_5\text{COO)}_6$ 902
 Be(OH)_2 894
 $\text{Be}_4\text{O(HCOO)}_6$ 902
 BeS 895
 BeSe 897
 BeTe 897
 Bi 620
 $\text{BiBO}_3 \cdot 2\text{H}_2\text{O}$ 627
 BiBr_3 623
 BiCl_2 622
 BiCl_3 621
 BiF_3 201
 BiF_5 202
 BiI_3 624
 BiICl_2 622
 Bi_2O_3 620
 $\text{Bi}_2\text{O}_4 \cdot aq$ 629
 BiOBr 624
 BiOCl 622
 BiOI 625
 BiONO_2 626
 $\text{BiONO}_2 \cdot \frac{1}{2}\text{H}_2\text{O}$ 626
 BiONO_3 620

pp 1-992: Vol. 1; pp 1003-1810: Vol. 2

- BiPO₄ 626
 BiPO₄·3H₂O 626
 Br₂ 275
 BrCN 665
 BrF₃ 156
 BrF₅ 158
 Br₂·8H₂O 276
 BrN₃ 476
 Br(NO₃)₃ 328
 BrO₂ 306
 Br₂O 307
 [BrPy_x]ClO₄ 328
 [BrPy₂]F 328
 [BrPy_x]NO₃ 328
- C
- C 630
 C₃₀AlCl₄·2AlCl₃ 644
 C₈Br 643
 CClF₃ 205
 CCl₂F₂ 151, 205
 C₂Cl₂F₄ 205
 C₂Cl₃F₃ 205
 C₈Cs 635
 C₂₄Cs 635
 C₃₆Cs 635
 C₄₈Cs 635
 C₁₂Cs(NH₃)₂ 637
 CF 640
 CF₄ 203, 207
 C₄F 641
 C₂HCl₃F₂ 205
 CHF₃ 204
 C₂₄HSO₄·2H₂SO₄ 642
 CIF₃ 205
 C₈K 635
 C₂₄K 635
 C₃₆K 636
 C₄₈K 636
 C₁₂K(NH₃)₂ 637
 C₁₂Li(NH₃)₂ 637
 (CN)₂ 661
 CNBr 665
 CNCl 662
- CNI 666
 C₁₂Na(NH₃)₂ 637
 CO 645
 CO₂ 647
 C₃O₂ 648
 COBrF 210
 COCl₂ 650
 COCIF 208
 COF₂ 206, 210
 COIF 211
 (CONH)₃ 668
 COS 654
 COSe 655
 C₈Rb 635
 C₂₄Rb 635
 C₃₆Rb 635
 C₄₈Rb 635
 C₁₂Rb(NH₃)₂ 637
 CS₂ 652
 C₃S₂ 653
 C₃S₂Br₆ 653
 CSe₂ 656
 Ca 922
 Ca(AlH₄)₂ 806
 CaBr₂ 930
 CaC₂ 943
 CaCN₂ 946
 CaCO₃ 931
 CaCl₂ 930
 Ca(ClO₄)₂ 320
 Ca(ClO₄)₂·4H₂O 320
 CaF₂ 233
 CaGe 948
 CaH₂ 929
 CaI₂ 930
 Ca₃N₂ 940
 CaO 931
 CaO₂ 936
 CaO₂·8H₂O 936
 Ca(OH)₂ 934
 Ca₃P₂ 942
 Ca₁₀(PO₄)₆(OH)₂ 545
 Ca₂PbO₄ 760
 CaS 938
 CaSe 939
 CaSeO₄ 939
- CaSi 946
 CaSi₂ 946
 CaTe 940
 Cd 1042
 CdAs₂ 1103
 Cd₃As₂ 1103
 CdBr₂ 1096
 Cd(C₂H₅)₂ 1103
 Cd(CH₃COO)₂ 1105
 Cd(CN)₂ 1105
 CdCO₃ 1104
 CdCl₂ 1093
 CdCl₂·KCl·H₂O 1095
 CdF₂ 243
 CdFe₂O₄ 1107
 CdI₂ 1096
 Cd₃N₂ 1100
 Cd(NH₂)₂ 1100
 Cd(OH)₂ 1097
 Cd(OH)Cl 1094
 CdP₂ 1101
 CdP₄ 1101
 Cd₃P₂ 1101
 CdS 1098
 Cd(SCN)₂ 1106
 CdSe 1099
 Cd₂SiO₄ 1107
 CeF₃ 247
 CeF₄ 247
 CeO₂ 1132
 Ce₂O₃ 1151
 CeS 1155
 Cl₂ 272
 (ClBNH)₃ 779
 ClCN 662
 ClF 153
 ClF₃ 155
 Cl₂·6H₂O 274
 ClN₃ 476
 ClNO₃ 326
 ClN(SO₃K)₂ 508
 ClO₂ 301
 Cl₂O 299
 Cl₂O₆ 303
 Cl₂O₇ 304
 ClO₂F 165

pp 1-992: Vol. 1; pp 1003-1810: Vol. 2

- ClO_3F 166
 ClO_4F 167
 $[\text{ClPy}_x]\text{NO}_3$ 328
 Co 1513
 CoAl_2O_4 1525
 CoBr_2 1517
 $\text{CoBr}_2 \cdot 6\text{H}_2\text{O}$ 1517
 Co_2C 1531
 $[\text{Co}(\text{CO})_3]_4$ 1746
 $[\text{Co}(\text{CO})_4]_2$ 1746
 $\text{Co}(\text{CO})_4\text{H}$ 1753
 CoCl_2 267, 1515
 $[\text{Co en}_3]\text{Br}_3$ 1538
 $[\text{Co en}_3]\text{Br}_3 \cdot 2\text{H}_2\text{O}$ 1539
 $[\text{Co en}_3]\text{Br}_3 \cdot 3\text{H}_2\text{O}$ 1538
 CoF_2 267
 CoF_3 268
 CoI_2 1518
 $\text{CoI}_2 \cdot 6\text{H}_2\text{O}$ 1518
 CoN 1529
 Co_2N 1529
 $\text{Co}(\text{NH}_2)_3$ 1526
 $[\text{Co}(\text{NH}_3)_4\text{CO}_3]_2\text{SO}_4 \cdot 3\text{H}_2\text{O}$ 1535
 $[\text{Co}(\text{NH}_3)_6]\text{Cl}_2$ 1516
 $[\text{Co}(\text{NH}_3)_6]\text{Cl}_3$ 1531
 $[\text{Co}(\text{NH}_3)_5\text{Cl}]\text{Cl}_2$ 1532
 $[\text{Co}(\text{NH}_3)_4\text{Cl}]\text{Cl}_2$ 1536
 $[\text{Co}(\text{NH}_3)_4\text{Cl}_2]\text{Cl} \cdot \frac{1}{2}\text{H}_2\text{O}$ 1536
 $[\text{Co}(\text{NH}_3)_4\text{Cl}_2]\text{Cl} \cdot \text{H}_2\text{O}$ 1537
 $[\text{Co}(\text{NH}_3)_5(\text{H}_2\text{O})]_2$
 $(\text{C}_2\text{O}_4)_3 \cdot 4\text{H}_2\text{O}$ 1532
 $[\text{Co}(\text{NH}_3)_4(\text{H}_2\text{O})_2]_2$
 $(\text{SO}_4)_3 \cdot 3\text{H}_2\text{O}$ 1537
 $[\text{Co}(\text{NH}_3)_6](\text{NO}_3)_3$ 1526
 $[\text{Co}(\text{NH}_3)_5\text{NO}_2]\text{Cl}_2$ 1534
 $[\text{Co}^{\text{III}}(\text{NH}_3)_5(\text{O}_2)\text{Co}^{\text{IV}}(\text{NH}_3)_5](\text{SO}_4)_2 \cdot \text{SO}_4\text{H} \cdot 3\text{H}_2\text{O}$ 1540
 $[\text{Co}(\text{NH}_3)_5\text{ONO}]\text{Cl}_2$ 1535
 $\text{Co}(\text{NO})_2\text{Br}$ 1761
 $\text{Co}(\text{NO})(\text{CO})_3$ 1761
 $\text{Co}(\text{NO})_2\text{Cl}$ 1761
 $\text{Co}(\text{NO})_2\text{I}$ 1761
 $[\text{Co}(\text{NO}_2)_6]\text{Na}_3$ 1541
 $[\text{Co}(\text{NO})_2(\text{S}_2\text{O}_3)_2]\text{K}_3$ 1766
 CoO 1514, 1519
 Co_3O_4 1520
 $\text{Co}(\text{OH})_2$ 1521
 $\text{CoO}(\text{OH})$ 1520
 CoP 1530
 CoP_3 1530
 Co_2P 1530
 CoS 1523
 CoS_2 1523
 Co_3S_4 1523
 Co_9S_8 1523
 $\text{CoSO}_2 \cdot 3\text{H}_2\text{O}$ 393
 $\text{Co}_2(\text{SO}_4)_3 \cdot 18\text{H}_2\text{O}$ 1524
 Cr 1334
 CrBr_2 1340
 CrBr_3 1341
 $\text{Cr}(\text{C}_6\text{H}_6)_2$ 1397
 $\text{Cr}(\text{C}_{12}\text{H}_{10})_2$ 1397
 $[\text{Cr}(\text{C}_{12}\text{H}_{10})(\text{C}_6\text{H}_6)]\text{I}$ 1398
 $\text{Cr}_2(\text{CH}_3\text{COO})_4 \cdot 2\text{H}_2\text{O}$ 1368
 $[\text{Cr}(\text{C}_6\text{H}_6)_2]\text{I}$ 1395
 $[\text{Cr}(\text{C}_{12}\text{H}_{10})_2]\text{I}$ 1396
 $[\text{Cr}(\text{C}_6\text{H}_5\text{NC})_6]$ 1363
 $\text{Cr}(\text{C}_5\text{H}_7\text{O}_2)_3$ 1383
 $\text{Cr}(\text{C}_2\text{H}_5\text{OCS}_2)_3$ 1383
 $\text{Cr}(\text{CO})_6$ 1741
 $\text{CrC}_2\text{O}_4 \cdot 2\text{H}_2\text{O}$ 1370
 $\text{Cr}(\text{CO})_3\text{Py}_3$ 1749
 $\text{Cr}(\text{CO})_4\text{Py}_2$ 1749
 CrCl_2 1336
 CrCl_3 1338
 $[\text{CrCl}_3(\text{C}_2\text{H}_5\text{OH})_3]$ 1380
 $[\text{CrCl en}_2]\text{Cl}$ 1357
 $[\text{CrCl}_2 \text{ en}_2]\text{Cl} \cdot \text{H}_2\text{O}$ 1356
 $[\text{CrCl}_3(\text{NH}_3)_3]$ 1381
 $[\text{CrCl}(\text{NH}_3)_5]\text{Cl}_2$ 1352
 $[\text{CrCl}_3(\text{OH}_2)_3]$ 1380
 $[\text{CrCl}(\text{OH}_2)_5]\text{Cl}_2 \cdot \text{H}_2\text{O}$ 1350
 $[\text{CrCl}_2(\text{OH}_2)(\text{NH}_3)_3]\text{Cl}$ 1358
 $[\text{CrCl}_3\text{Py}_3]$ 1381
 $[\text{Cr}(\text{Dipy})_3]$ 1363
 $[\text{Cr}(\text{Dipy})_3]\text{ClO}_4$ 1362
 $[\text{Cr}(\text{Dipy})_3](\text{ClO}_4)_2$ 1361
 $[\text{Cr en}_3]\text{Cl}_3 \cdot 3.5\text{H}_2\text{O}$ 1354
 $[\text{Cr en}_3](\text{SCN})_3 \cdot \text{H}_2\text{O}$ 1354
 $[\text{Cr en}_3]_2(\text{SO}_4)_3$ 1354
 CrF_2 256
 CrF_3 258
 $\text{CrF} \cdot 3\text{H}_2\text{O}$ 258
 CrF_4 258
 CrI_2 1341
 CrI_3 1344
 CrN 1347
 $\text{Cr}(\text{NH}_2\text{CH}_2\text{COO})_3$ 1382
 $[\text{Cr}(\text{NH}_3)_6]\text{Cl}_3$ 1351
 $[\text{Cr}(\text{NH}_3)_6](\text{NO}_3)_3$ 1351
 $[\text{Cr}(\text{NH}_3)_5(\text{OH})\text{Cr}(\text{NH}_3)_5\text{Cl}_5]$ 1359
 $[\text{Cr}(\text{NH}_3)_5(\text{OH})\text{Cr}(\text{NH}_3)_4(\text{OH}_2)]\text{Cl}_5$ 1360
 $[\text{Cr}(\text{OCN}_2\text{H}_4)_6]\text{Cl}_3 \cdot 3\text{H}_2\text{O}$ 1359
 CrO_2Cl_2 1384
 $\text{CrO}_2(\text{ClO}_4)_2$ 1387
 CrO_2F_2 258
 $\text{Cr}(\text{OH})_3 \cdot n\text{H}_2\text{O}$ 1345
 $[\text{Cr}(\text{OH}_2)_6](\text{CH}_3\text{COO})_3$ 1371
 $[\text{Cr}_3(\text{OH})_2(\text{CH}_3\text{COO})_6](\text{CH}_3\text{COO}) \cdot n\text{H}_2\text{O}$ 1371
 $[\text{Cr}_3(\text{OH})_2(\text{CH}_3\text{COO})_6]\text{Cl} \cdot 8\text{H}_2\text{O}$ 1371
 $[\text{Cr}(\text{OH}_2)_6]\text{Cl}_3$ 1348
 $[\text{Cr}(\text{OH})_6]\text{Na}_3$ 1688
 $\text{CrO}_2(\text{NO}_3)_2$ 1386
 $\text{CrO}_3 \cdot 2\text{Py}$ 1385
 CrPO_4 1364

pp 1-992: Vol. 1; pp 1003-1810: Vol. 2

CrS 1346	CuF ₂ 238	EuO 1156
Cr ₂ S ₃ 1346	CuF ₂ ·5H ₂ O·5HF 238	EuS 1155
[Cr(SCN) ₄ (C ₆ H ₅ NH ₂) ₂] NH ₄ ·½H ₂ O 1378	CuH 1004	EuSO ₄ 1137
[Cr(SCN) ₂ en ₂]SCN 1357	Cu ₂ HgI ₄ 1110	EuSe 1155
CrSO ₄ ·5H ₂ O 1365	CuI 1007	EuTe 1155
Cs 958	Cu(N ₃) ₂ 1022	
CsAl(SO ₄) ₂ ·12H ₂ O 956	Cu ₃ N 1021	
CsBrCl ₂ 294	[Cu(NH ₃) ₄]SO ₄ ·H ₂ O 1021	F
CsC ₈ 635	CuO 1012	F ₂ 143
CsC ₂₄ 635	Cu ₂ O 1011	F ₂ O 163
CsC ₃₆ 636	Cu(OH) ₂ 1013	F ₂ O ₂ 162
CsC ₄₈ 636	[Cu(OH) ₄]Na ₂ 1684	FSO ₂ NO 186
Cs ₂ CO ₃ 987	CuP ₂ 1024	Fe 1490
CsCl 951, 955	Cu ₃ P 1023	FeBr ₂ 1493
Cs ₂ CrO ₄ 1389	Cu ₂ P ₄ O ₁₂ 553	FeBr ₃ 1494
Cs ₂ Cr ₂ O ₇ 1389	CuS 1017	Fe ₃ C 1503,1792
CsGe 989	Cu ₂ S 1016	[Fe ₃ (CH ₃ COO) ₆ (OH) ₂] CH ₃ COO·H ₂ O 1508
CsH 971	Cu ₂ SO ₄ 1020	[Fe(CN) ₅ (CO)]Na ₃ 1769
CsIBr ₂ 297	Cu ₂ Se 1019	[Fe(CN) ₅ NH ₃]Na ₂ ·H ₂ O 1512
CsICl ₂ 296	Cu ₂ Te 1019	[Fe(CN) ₅ NH ₃]Na ₃ ·3H ₂ O 1511
CsMn(SO ₄) ₂ ·12H ₂ O 1468		[Fe(CN) ₅ (NO)]Na ₂ ·2H ₂ O 1768
CsN ₃ 476	D	[Fe(CN) ₅ (OH) ₂]Na ₃ 1769
Cs(NH ₃) ₂ C ₁₂ 637	D ₂ 121	[Fe(CO) ₄] ₃ 1745
CsO ₂ 981	DBr 131	Fe(CO) ₅ 1743
Cs ₂ O 974	DCI 129	Fe ₂ (CO) ₉ 1744
CsOH 983	DF 127	Fe(CO) ₄ Br ₂ 1751
Cs ₂ S ₂ 369	DH 126	Fe(CO) ₄ Cl ₂ 1751
Cs ₂ S ₃ 369	DI 133	Fe(CO) ₄ H ₂ 1752
Cs ₂ S ₅ 369	D ₂ O 119	Fe(CO) ₄ Hg 1755
Cs ₂ S ₆ 369	D ₃ PO ₃ 132	Fe(CO) ₄ I ₂ 1751
Cs ₂ SeCl ₆ 425	D ₃ PO ₄ 138	[Fe(CO) ₃ NO]K 1759
CsSi 989	D ₂ S 134	FeCl ₂ 1491
2Cs ₂ O·SiO ₂ ·12MoO ₃ ·aq 1730	D ₂ SO ₄ 135	FeCl ₃ 1492
Cs ₂ TeCl ₆ 444		[Fe en ₃][Fe ₂ (CO) ₈] 1756
Cs ₃ (Tl ₂ Cl ₉) 874	E	FeF ₂ 266
Cu 1003, 1633	EuBr ₂ 1149	FeF ₃ 266
CuBr 1006	EuCO ₃ 1137	FeI ₂ 1495
CuBr ₂ 1009	EuCl ₂ 1150	Fe ₂ N 1502
Cu ₂ C ₂ ·H ₂ O 1026	EuCl ₂ ·2H ₂ O 1136	Fe ₄ N 1502
CuCO ₃ ·Cu(OH) ₂ 1024	EuF ₂ 248	
2CuCO ₃ ·Cu(OH) ₂ 1025	EuI ₂ 1150	
CuCl 1005		
CuCl ₂ 1008		
CuCl ₂ ·Cu(OH) ₂ 1010		

pp 1-992: Vol. 1; pp 1003-1810: Vol. 2

- $\text{Fe}(\text{NO})_2(\text{CO})_2$ 1760
 $[\text{Fe}(\text{NO})_2\text{SC}_2\text{H}_5]_2$ 1765
 $[\text{Fe}(\text{NO})_2\text{S}]\text{Na}\cdot 4\text{H}_2\text{O}$
 1763
 $[\text{Fe}(\text{NO})_2\text{S}_2\text{O}_3]\text{K}\cdot \text{H}_2\text{O}$
 1766
 $[\text{Fe}(\text{NO})_2\text{S}_2\text{O}_3]\text{Na}$ 1766
 FeO 1497
 Fe_2O_3 1661
 Fe_3O_4 1499
 FeOCl 1501
 $\text{Fe}(\text{OH})_2$ 1498
 $[\text{Fe}(\text{OH})_4]\text{Na}_2$ 1686
 $[\text{Fe}(\text{OH})_7]\text{Na}_4\cdot 2\text{H}_2\text{O}$
 1689
 $[\text{Fe}(\text{OH})_8]\text{Na}_5\cdot 5\text{H}_2\text{O}$
 1690
 $\text{FeO}(\text{OH})$ 1499
 $3\text{Fe}_2\text{O}_3\cdot 4\text{SO}_3\cdot 9\text{H}_2\text{O}$
 1507
 $[\text{FePy}_6][\text{Fe}_4(\text{CO})_{13}]$
 1758
 FeS 1502
 $[\text{Fe}(\text{SCN})_6]\text{Na}_3\cdot 12\text{H}_2\text{O}$
 1511
 $\text{Fe}_3(\text{SO}_4)_2(\text{OH})_5\cdot 2\text{H}_2\text{O}$
 1507
- G
- Ga 837
 GaAs 857
 GaBr_2 846
 GaBr_3 845
 $\text{Ga}(\text{CH}_3)_3$ 840
 $\text{Ga}(\text{CH}_3)_3\cdot \text{N}(\text{C}_2\text{H}_5)_3$ 841
 GaCl_2 846
 GaCl_3 843
 $\text{Ga}(\text{ClO}_4)_3\cdot 6\text{H}_2\text{O}$ 839
 GaF_3 227
 Ga_2H_6 840
 $\text{Ga}_2\text{H}_2(\text{CH}_3)_4$ 840
 GaI_3 846
 GaN 855
 $\text{Ga}(\text{N}_3)_3$ 476
- $\text{Ga}(\text{NO}_3)_3$ 856
 Ga_2O 849
 Ga_2O_3 848
 $\text{Ga}(\text{OH})_3$ 847
 $\text{GaO}(\text{OH})$ 847
 GaP 857
 GaS 851
 Ga_2S 852
 Ga_2S_3 850
 GaSb 857
 GaSe 854
 Ga_2Se 854
 Ga_2Se_3 854
 GaTe 855
 Ga_2Te_3 855
 Ge 712
 GeBr_4 718
 $\text{Ge}(\text{CH}_3\text{COO})_4$ 726
 GeCH_3I_3 722
 GeCl_2 716
 GeCl_4 707, 715
 GeF_4 215
 GeH_4 713
 Ge_2H_6 713
 Ge_3H_8 713
 GeHCl_3 717, 721
 GeI_2 720
 GeI_4 719
 Ge_3N_4 722
 $\text{Ge}(\text{NH})_2$ 723
 $\text{Ge}_2\text{N}_3\text{H}$ 723
 GeO 711
 GeO_2 706
 $\text{Ge}(\text{OC}_2\text{H}_5)_4$ 725
 GeS 723, 724
 GeS_2 723
- H
- H_2 111
 $\text{HAlBr}_4\cdot 2\text{O}(\text{C}_2\text{H}_5)_2$ 817
 $\text{HAlCl}_4\cdot 2\text{O}(\text{C}_2\text{H}_5)_2$ 816
 H_3AsO_4 601
 $\text{H}_3\text{AsO}_4\cdot \frac{1}{2}\text{H}_2\text{O}$ 601
 H_7AsO_6 601
- $\text{HAuCl}_4\cdot 4\text{H}_2\text{O}$ 1057
 HBF_4 221
 $\text{H}[\text{BF}_2(\text{OH})_2]$ 784
 HBO_2 791
 HBr 282
 HBrO_3 315
 HCN 658, 668
 H_2CS_3 674
 HCl 280
 HClO 308
 HClO_3 312
 HClO_4 318
 $\text{H}_3\text{Co}(\text{CN})_6$ 1542
 $\text{H}_3\text{Co}(\text{CN})_6\cdot 5\text{H}_2\text{O}$ 1543
 $\text{H}[\text{Cr}(\text{SCN})_4(\text{NH}_3)_2]$
 1377
 HD 126
 HF 145
 $\text{H}_3\text{Fe}(\text{CN})_6$ 1510
 $\text{H}_4\text{Fe}(\text{CN})_6$ 1509
 H_2IrCl_6 1593
 HI 286
 $\text{HICl}_4\cdot 4\text{H}_2\text{O}$ 299
 HIO_3 316
 H_5IO_6 322
 $\text{HIO}_3\cdot \text{I}_2\text{O}_5$ 307
 $\text{H}_2\text{MoO}_4\cdot \text{H}_2\text{O}$ 1412
 HN_3 472
 HNCO 667, 668
 HNCS 669
 HNO_3 491
 $\text{H}_2\text{N}_2\text{O}_2$ 492
 $\text{HNbO}_4\cdot n\text{H}_2\text{O}$ 1324
 H_2O 117
 H_2O_2 140
 H_3PO_2 555
 H_3PO_3 554
 H_3PO_4 543
 $\text{H}_4\text{P}_2\text{O}_6$ 558
 $\text{H}_4\text{P}_2\text{O}_6\cdot 2\text{H}_2\text{O}$ 559
 $\text{H}_4\text{P}_2\text{O}_7$ 546
 HPO_2Cl_2 538
 $\text{HPO}_2(\text{NH}_2)_2$ 582
 $\text{H}_2\text{PO}_3\text{NH}_2$ 579
 $\text{H}_3\text{PO}_3\text{S}$ 568
 H_2PtCl_4 1570

pp 1-992: Vol. 1; pp 1003-1810: Vol. 2

H₂PtCl₆·6H₂O 1569
 H₂S 344
 H₂S₂ 350
 H₂S₃ 350
 H₂S₄ 353
 H₂S₅ 353
 H₂S₆ 353, 355
 H₂S₇ 353, 355
 H₂S₈ 353, 355
 H₂S_x 346
 H₂SO₅ 388
 H₂S₂O₈ 389
 H₂S_xO₃ 405
 H₂S_xO₆ 405
 HSO₃Cl 385
 HSO₃F 177
 HSO₃NH₂ 508
 HSbCl₆·4.5H₂O 611
 H₂Se 418
 H₂SeO₃ 430
 H₂SeO₄ 432
 H₂SiF₆ 214
 H₂Si₂O₃ 694, 699
 H₂Si₂O₅ 699
 H₄SiO₄ 697
 H₂SnCl₆·6H₂O 730
 HTaO₄·nH₂O 1324
 H₂Te 438
 H₂TeO₃ 449
 H₆TeO₆ 451
 H₄TiO₅ 1219
 H(TiCl₄)·3H₂O 872
 HTl(SO₄)₂·4H₂O 882
 HV(SO₄)₂·4H₂O 1282
 H_{0.5}WO₃ 1423
 H₂WO₄ 1424
 He 82
 Hf 1172
 HfBr₂ 1204
 HfBr₃ 1204
 HfBr₄ 1203
 HfC 1245
 HfCl₄ 1203
 HfN 1233
 HfO₂ 1221
 HfOCl₂·8H₂O 1213

Hg 28
 HgBr₂ 1109
 Hg(C₂H₅)₂ 1118
 Hg(CH₃COO)₂ 1120
 Hg₂(CH₃COO)₂ 1120
 Hg(CN)₂ 1121
 HgCO₃ 243
 HgCl₂·4HgO 1108
 HgCl₂·2NH₃ 1114
 HgF₂ 244
 Hg₂F₂ 243
 Hg₂(NH)Br₂ 1115
 HgNH₂Cl 1114
 [Hg(NS)₂]_x 1118
 [Hg₂(NS)₂]_x 1117
 HgO 299
 HgS 1111
 Hg(SCN)₂ 1123
 Hg₂(SCN)₂ 1122
 HgSe 1113
 HgSeF₄ 180

I

I₂ 277
 IBr 291
 [I(C₅H₅N)₂]ClO₄ 327
 ICN 666
 ICl 290
 ICl₃ 292
 I(ClO₄)₃ 330
 IF₅ 159
 IF₇ 160
 I(IO₃)₃ 331
 I(NO₃)₃ 329
 I₂O₄ 333
 I₂O₅ 307
 I₄O₉ 331
 I₂O₅·HIO₃ 307
 I₂O₇·12MoO₃·aq 1738
 (IO)₂SO₄·H₂O 342
 [IPy_x]ClO₄ 328
 [IPy₂]F 328
 [IPy_x]NO₃ 328
 I₂(SO₄)₃ 329

K

In 857
 InAs 867
 InBr 862
 InBr₂ 861
 InBr₃ 859
 InCl 862
 InCl₂ 861
 InCl₃ 858
 InF₃ 228
 InI 862
 InI₂ 861
 InI₃ 860
 InN 866
 In₂O 863
 In₂O₃ 863
 In(OH)₃ 862
 InP 867
 InS 864
 In₂S 864
 In₂S₃ 864
 InSb 867
 InSe 865
 In₂Se 865
 In₂Se₃ 865
 In₂Te 865
 In₂Te₃ 865
 Ir 1590
 IrCl₃ 1592
 IrF₄ 271
 IrF₆ 270
 IrO₂ 1590
 IrO₂·2H₂O 1591
 Ir₂O₃·xH₂O 1592

K 958
 K₂[Al₂O(OH)₆] 1693
 K₃AS 986
 KAsH₂ 595
 K[Au(CN)₂] 1065
 KAuC_l₄·½H₂O 1058
 KAuO₂·3H₂O 1061
 KBF₄ 223
 KBF₃OH 223

pp 1-992: Vol. 1; pp 1003-1810: Vol. 2

- K_3Bi 986
 $KBiO_3 \cdot \frac{1}{2}H_2O$ 628
 $KBrF_4$ 237
 $KBrO \cdot 3H_2O$ 311
 KC_8 635
 KC_{24} 635
 KC_{36} 635
 KC_{48} 635
 K_2CO_3 987
 $K_2Cd(CN)_4$ 1106
 $K_3[Co(CN)_6]$ 1541
 K_3CoF_7 269
 $K_3[Cr(CN)_6]$ 1373
 $K_3[Cr(C_2O_4)_3] \cdot 3H_2O$
 1372
 K_2CrF_6 269
 K_3CrO_8 1391
 $K[CrO_3Cl]$ 1390
 $K[CrO_3F]$ 1390
 $K_3[Cr(SCN)_6] \cdot 4H_2O$
 1374
 $K[Cr(SCN)_4Py_2] \cdot 2H_2O$
 1379
 K_3CuF_6 269
 $KCuO_2$ 1014
 KF 236
 $KF \cdot HF$ 237
 K_2FeF_6 269
 K_2FeO_4 1504
 $KFeS_2$ 1507
 KGe 989
 K_2GeF_6 216
 KH 971
 KHF_2 146
 $KHMoO_6 \cdot 2H_2O$ 1414
 $K_7[HNb_6O_{19} \cdot aq]$ 1706
 $KHPO_3NH_2$ 579
 $K_2Hg(CN)_4$ 1122
 $KHgI_3 \cdot H_2O$ 1110
 $K_2Hg(SCN)_4$ 1124
 K_2IrCl_6 1593
 $K_3IrCl_6 \cdot 3H_2O$ 1595
 KI 290
 $KIBr_2$ 296
 $KICl_2$ 295
 $KICl_4$ 298
 KIF_6 238
 $KI_3 \cdot H_2O$ 294
 KIO_4 325
 $K_3Mn(CN)_6$ 1474
 $K_5Mn(CN)_6$ 1472
 $K_4Mn(CN)_6 \cdot 3H_2O$ 1473
 $K_3[Mn(C_2O_4)_3] \cdot 3H_2O$
 1470
 $K_2[Mn(C_2O_4)_2(OH)_2] \cdot$
 $2H_2O$ 1471
 K_2MnCl_5 1464
 K_2MnCl_6 1464
 K_2MnF_6 264, 269
 K_2MnO_4 1461
 $K_4[Mo(CN)_8] \cdot 2H_2O$
 1416
 K_3MoCl_6 1408
 KN_3 476
 KNH_2 1044
 $K(NH_3)_2C_{12}$ 636
 $K_3[(NO)_2Co(S_2O_3)_2]$
 1766
 $K[(NO)_2FeS_2O_3] \cdot H_2O$
 1766
 $K_3[(NO)Mn(CN)_5]$
 1767
 $K_4[(NO)Mo(CN)_5] \cdot H_2O$
 1766
 $K_3[(NO)Ni(S_2O_3)_2]$
 1766
 K_2NbF_7 255
 K_3NbO_8 1325
 $K_3NbO_8 \cdot \frac{1}{2}H_2O$ 1325
 $K_8[Nb_6O_{19} \cdot aq]$ 1706
 $K_2[Ni(CN)_4] \cdot H_2O$ 1559
 K_2NiF_6 269
 KO_2 981
 K_2O 974
 $3K_2O \cdot As_2O_5 \cdot 24MoO_3 \cdot aq$
 1734
 $K_2O \cdot 3CrO_3$ 1709
 $K_2O \cdot 4CrO_3$ 1710
 $3K_2O \cdot P_2O_5 \cdot 18MoO_3 \cdot aq$
 1733
 $11K_2O \cdot 2P_2O_5 \cdot 24V_2O_5 \cdot$
 aq 1740
 $3K_2O \cdot P_2O_5 \cdot 21WO_3 \cdot aq$
 1722
 $3K_2O \cdot P_2O_5 \cdot 24WO_3 \cdot aq$
 1721
 $7K_2O \cdot P_2O_5 \cdot 22WO_3 \cdot aq$
 1722
 $2K_2O \cdot SiO_2 \cdot 12WO_3 \cdot aq$
 1718
 $7K_2O \cdot 2SiO_2 \cdot 20WO_3 \cdot aq$
 1719
 $K_2O \cdot 3V_2O_5$ 1704
 $K_2OsO_4 \cdot 2H_2O$ 1604
 $K(OsO_3N)$ 1605
 KPF_6 196
 $K_3PO_4 \cdot 8H_2O$ 545
 $K_4P_2O_8$ 562
 K_2PbCl_6 753
 $KPbI_3$ 754
 $KPbI_3 \cdot 2H_2O$ 754
 K_2PdCl_4 1584
 K_2PdCl_6 1584
 $K_2Pt(CN)_4 \cdot 3H_2O$ 1576
 K_2PtCl_4 1572
 K_2PtCl_6 1571
 $K_2Pt(OH)_6 \cdot xH_2O$ 1575
 K_2ReCl_6 1478
 $K_2[RhCl_5(H_2O)]$ 1588
 $K_3RhCl_6 \cdot H_2O$ 1588
 $KRuO_4$ 1600
 $K_2RuO_4 \cdot H_2O$ 1600
 K_2S 360
 K_2S_2 363
 K_2S_3 364
 K_2S_4 366
 K_2S_5 367
 K_2S_6 368
 $KSCN$ 739
 $K_2S_2O_8$ 392
 $K_2S_3O_6$ 398
 $K_2S_3O_{10}$ 1714
 $K_2S_4O_6$ 399
 $K_2S_5O_6 \cdot 1\frac{1}{2}H_2O$ 401
 $K_2S_6O_6$ 403
 KSO_2F 178
 $K_2SO_3 \cdot (NO)_2$ 504
 K_3Sb 986, 1791

pp 1-992: Vol. 1; pp 1003-1810: Vol. 2

- KSbCl₆·H₂O 612
 K₂Se 421
 K₂SeCl₆ 425
 KSi 989
 K₂SnCl₆ 731
 K₂TaF₇ 256
 K₃TaO₈ 1325
 K₃TaO₈·½H₂O 1326
 K₂Te 441
 K₂TeCl₆ 444
 K₂(TiCl₅H₂O)·H₂O
 874
 K₃(TiCl₆)·2H₂O 873
 K₄[U(C₂O₄)₄]·5H₂O
 1450
 K₂UO₄ 1445
 K₂VF₆ 269
 K₃V(SCN)₆ 1291
 KV(SO₄)₂ 1283
 K₃[W(CN)₈]·H₂O 1430
 K₄[W(CN)₈]·2H₂O
 1429
 K₃W₂Cl₉ 1427
 K₂Zn(CN)₄ 1088
- L
- LaF₃ 246
 La₂S₃ 1153
 La₂Se₃ 1154
 La₂Se₄ 1154
 Li 956
 Li₃Al 830
 Li₃AlAs₂ 831
 LiAl(CN)₄ 833
 LiAlH₄ 680, 805
 Li₃AlN₂ 828
 Li₃AlP₂ 830
 Li₃As 985
 LiBH₄ 775
 LiBH₄·O(C₂H₅)₂ 775
 Li₃Bi 985
 Li₂C₂ 987
 Li₂CO₃ 950, 987
- Li₃Cr(C₆H₅)₆·
 ·2½(C₂H₅)₂O 1375
 LiF 235
 LiFeO₂ 1504
 LiGaH₄ 842
 LiH 971, 805
 LiN₃ 475
 Li₃N 984
 LiNH₂ 463
 Li₂NH 464
 Li(NH₃)₂C₁₂ 636
 Li₂O
 Li₂O₂ 975, 979
 LiOH 983
 LiOH·H₂O 983
 Li₃P 985
 Li₃Sb 985
 Li₂Si 991
 Li₄Si 991
 Li₂SiO₃ 705
 LiUO₃ 1445
 Li₂UO₄ 1445
 LnBr₃ 1148
 Ln(C₅H₅)₃ 1159
 LnCl₃ 1146
 LnI₃ 1149
 LnN 1157
 Ln(NO₃)₃ 1158
 Ln(OH)₃ 1152
 LnS 1155
 Ln₂(SO₄)₃·nH₂O 1156
 LnSe 1155
 LnTe 1155
 LnX₂ 1150
- M
- Mg 903
 Mg₃As₂ 917
 MgBr₂ 909
 MgC₂ 920
 Mg₂C₃ 920
 MgCl₂ 905
 MgCl₂·6H₂O 906
- MgCl₂·NH₄Cl·6H₂O
 906
 Mg(ClO₄)₂ 320
 Mg(ClO₄)₂·6H₂O 320
 MgF₂ 232
 Mg₂Ge 922
 MgH₂ 905
 MgI₂ 910
 Mg(N₃)₂ 917
 Mg₃N₂ 916
 MgO 911
 Mg(OD)₂ 137
 Mg(OH)₂ 912
 [Mg(OH)₄]Na₂ 1683
 Mg₃P₂ 917
 MgS 913
 Mg₃Sb₂ 606
 MgSe 915
 Mg₂Si 921
 MgTe 915
 Mn 1454
 Mn(CH₃COO)₃ 1469
 Mn(CH₃COO)₃·2H₂O
 1469
 [Mn(CN)₅(NO)]K₃ 1767
 MnF₂ 262
 MnF₃ 263
 Mn₄N 1468
 Mn₃[(NO)Mn(CN)₅]₂
 1768
 MnO 1455
 MnO₂ 1458
 Mn₂O₃ 1457
 Mn₂O₇ 1459
 Mn(OH)₂ 1456
 MnO(OH) 1457
 MnS 1465
 Mn₂(SO₄)₃ 1467
 Mo 1401
 MoBr₃ 1407
 [MoBr₃Py₃] 1408
 Mo(C₆H₆)₂ 1401
 [Mo(CN)₅(NO)]K₄·H₂O
 1766
 Mo(CO)₆ 1741
 MoCl₃ 1404

pp 1-992: Vol. 1; pp 1003-1810: Vol. 2

- MoCl_5 1405
 Mo_3Cl_6 1403
 MoF_6 259
 MoO_2 1409
 MoO_3 1412
 Mo_4O_{11} 1410
 $[\text{MoOCl}_5](\text{NH}_4)_2$ 1413
 $12\text{MoO}_3 \cdot 5(\text{NH}_4)_2\text{O} \cdot \text{aq}$
 1711
 $24\text{MoO}_3 \cdot 3(\text{NH}_4)_2\text{O} \cdot \text{P}_2\text{O}_5 \cdot \text{aq}$ 1730
 $\text{Mo}_4\text{O}_{10}(\text{OH})_2$ 1411
 $\text{Mo}_5\text{O}_5(\text{OH})_{10}$ 1411
 $\text{MoO}_8[\text{Zn}(\text{NH}_3)_4]$ 1414
 MoS_2 1415
 $\text{MoS}_4(\text{NH}_4)_2$ 1416
 MoSi_2 1792, 1796
- N
- N_2 457
 N_3Br 477
 $\text{NBr}_3 \cdot 6\text{NH}_3$ 480
 NCl_3 479
 N_3Cl 476
 $(\text{NCl})_3(\text{SO})_3$ 412
 $\text{NCl}(\text{SO}_3\text{K})_2$ 508
 ND_3 137
 NF_3 181
 NH_3 460
 $^{15}\text{NH}_3$ 461
 N_2H_4 469
 $\text{N}_2\text{H}_4 \cdot \text{H}_2\text{O}$ 469
 NH_4AlF_4 227
 $(\text{NH}_4)_3\text{AlF}_6$ 226
 $(\text{NH}_4)_3\text{AsO}_4 \cdot 3\text{H}_2\text{O}$ 602
 $(\text{NH}_4)_3\text{AsS}_4$ 604
 $(\text{NH}_4)_2\text{BeF}_4$ 232
 NH_2Br 480
 $(\text{NH}_4)_2\text{CS}_3$ 674
 NH_2Cl 477
 NH_4ClO_3 313
 $(\text{NH}_3)_3\text{CrO}_4$ 1392
 $(\text{NH}_4)_2\text{Cr}_2\text{O}_{12} \cdot 2\text{H}_2\text{O}$
 1392
- $\text{NH}_4[\text{Cr}(\text{SCN})_4(\text{NH}_3)_2] \cdot \text{H}_2\text{O}$ 1376
 NH_4F 183
 $\text{NH}_4\text{F} \cdot \text{HF}$ 183
 $(\text{NH}_4)_4\text{Fe}(\text{CN})_6$ 1509
 $(\text{NH}_4)_3\text{GaF}_6$ 228
 $\text{NH}_4\text{Ga}(\text{SO}_4)_2 \cdot 12\text{H}_2\text{O}$
 854
 $\text{NH}_4\text{HPO}_3\text{NH}_2$ 584, 588
 $(\text{NH}_4)_2\text{HPO}_3\text{S}$ 584
 NH_4HS 357
 $(\text{NH}_4)_3\text{InF}_6$ 229
 $(\text{NH}_4)_2\text{IrCl}_6$ 1594
 NH_4I 289
 $(\text{NH}_4)_2[\text{MoOCl}_5]$ 1413
 $(\text{NH}_4)_2\text{MoS}_4$ 1416
 NH_2NO_2 496
 $\text{NH}_4[(\text{NO})_7\text{Fe}_4\text{S}_3] \cdot \text{H}_2\text{O}$
 1764
 $3(\text{NH}_4)_2\text{O} \cdot \text{As}_2\text{O}_5 \cdot 24\text{WO}_3 \cdot \text{aq}$ 1725
 $3(\text{NH}_4)_2\text{O} \cdot \text{Cr}_2\text{O}_3 \cdot 12\text{MoO}_3 \cdot \text{aq}$ 1737
 NH_2OH 501
 $(\text{NH}_3\text{OH})_3\text{AsO}_4$ 501
 $(\text{NH}_3\text{OH})_2\text{C}_2\text{O}_4$ 501
 $(\text{NH}_3\text{OH})\text{Cl}$ 498
 $(\text{NH}_3\text{OH})\text{HSO}_4$ 499
 $(\text{NH}_3\text{OH})_3\text{PO}_4$ 500
 $5(\text{NH}_4)_2\text{O} \cdot 12\text{MoO}_3 \cdot \text{aq}$
 1711
 $3(\text{NH}_4)_2\text{O} \cdot \text{P}_2\text{O}_5 \cdot 24\text{MoO}_3 \cdot \text{aq}$ 1730
 $5(\text{NH}_4)_2\text{O} \cdot 2\text{P}_2\text{O}_5 \cdot 24\text{V}_2\text{O}_5 \cdot \text{aq}$ 1740
 $3(\text{NH}_4)_2\text{O} \cdot \text{P}_2\text{O}_5 \cdot 18\text{WO}_3 \cdot \text{aq}$ 1723
 $3(\text{NH}_4)_2\text{O} \cdot \text{P}_2\text{O}_5 \cdot 24\text{WO}_3 \cdot \text{aq}$ 1721
 $5(\text{NH}_4)_2\text{O} \cdot 12\text{WO}_3 \cdot \text{aq}$
 1713
 $\text{NH}_2\text{OSO}_3\text{H}$ 511
 $(\text{NH}_4)_2\text{OsCl}_6$ 1603
 NH_4PF_6 195
 $(\text{NH}_4\text{PO}_3)_x$ 580
 $\text{NH}_4\text{PO}_2\text{F}_2$ 196
- $(\text{NH}_4)_2\text{P}_2\text{O}_5(\text{NH}_2)_2$ 588
 $(\text{NH}_4)_2\text{PbCl}_6$ 751
 $(\text{NH}_4)_2\text{PdCl}_4$ 1584
 $(\text{NH}_4)_2\text{PdCl}_6$ 1586
 $(\text{NH}_4)_2\text{PtCl}_6$ 1570
 NH_4ReO_4 1484
 $(\text{NH}_4)_2[\text{RhCl}_5(\text{H}_2\text{O})]$
 1588
 $(\text{NH}_4)_3\text{RhCl}_6 \cdot \text{H}_2\text{O}$ 1588
 $(\text{NH}_4)_3[\text{Rh}(\text{NO}_2)_6]$ 1586
 $(\text{NH}_4)_2\text{RuCl}_6$ 1599
 $(\text{NH}_4)_2\text{S}_5$ 369
 NH_3SO_4 510
 $(\text{NH}_4)_2\text{S}_2\text{O}_8$ 390
 $\text{N}_2\text{H}_4\text{SO}_4$ 468
 $\text{NH}_2\text{SO}_3\text{H}$ 508
 $\text{NH}(\text{SO}_3\text{K})_2$ 506
 $\text{NH}_2\text{SO}_3\text{K}$ 507
 $\text{N}_2\text{H}_2(\text{SO}_3\text{K})_2$ 504, 509
 $\text{N}_2\text{H}_2(\text{SO}_3\text{NH}_4)_2$ 509
 $\text{N}_2\text{H}_2(\text{SO}_3\text{Py})_2$ 510
 $(\text{NH}_4)_2\text{SbBr}_6$ 615
 $(\text{NH}_4)_2\text{SeCl}_6$ 425
 $(\text{NH}_4)_2\text{SnCl}_6$ 731
 $(\text{NH}_4)_2\text{TeCl}_6$ 444
 $(\text{NH}_4)_2\text{TiCl}_6$ 1199
 $(\text{NH}_4)_4[\text{UO}_2(\text{CO}_3)_3]$
 1449
 NH_4VO_3 1272
 $\text{NH}_4\text{V}(\text{SO}_4)_2$ 1283
 $\text{NH}_4\text{V}(\text{SO}_4)_2 \cdot 12\text{H}_2\text{O}$
 1284
 $(\text{NH}_4)_2\text{ZnCl}_4$ 1072
 $(\text{NH}_4)_2\text{Zn}(\text{SO}_4)_2 \cdot 6\text{H}_2\text{O}$
 1077
 NHg_2Br 1117
 $\text{NHg}_2\text{OH} \cdot x\text{H}_2\text{O}$ 1116
 $\text{NI}_3 \cdot \text{NH}_3$ 481
 NO 485
 NO_2 488
 N_2O 484
 N_2O_3 487
 N_2O_4 488
 N_2O_5 489
 NOBF_4 224
 $\text{NOBF}_4 \cdot \text{H}_2\text{O}$ 224

pp 1-992: Vol. 1; pp 1003-1810: Vol. 2

- $\text{NO}_2[\text{BF}_4]$ 187
 $\text{N}_2\text{O}_5 \cdot \text{BF}_3$ 187
 NOBr 513
 NOCl 511
 NO_2Cl 513
 NOClO_4 320
 NO_2ClO_4 321
 NOF 184
 NO_2F 186
 NO_3F 187
 $[(\text{NO})_2\text{FeSC}_2\text{H}_5]_2$ 1765
 $(\text{NO})\text{HSO}_4$ 406
 $\text{NOH}(\text{SO}_3\text{K})_2$ 503
 NO_2NH_2 497
 NO_2NHCOOK 497
 NOSO_2F 186
 $\text{NO}(\text{SO}_3\text{K})_2$ 504
 $\text{NO}(\text{SbCl}_6)$ 612
 $\text{NO}_2(\text{SbCl}_6)$ 612
 $\text{N}_2(\text{SO}_3\text{K})_2$ 510
 $\text{N}(\text{SO}_3\text{K})_3 \cdot 2\text{H}_2\text{O}$ 506
 Na 958
 Na_3AgO_2 1039
 NaAlCl_4 816
 $\text{Na}_4[\text{Al}(\text{OH})_7] \cdot 3\text{H}_2\text{O}$ 1692
 $\text{Na}_4[\text{Al}_4\text{O}_3(\text{OH})_{10}]$ 1693
 $\text{Na}_6[\text{Al}_6\text{O}_4(\text{OH})_{16}]$ 1693
 Na_3As 986, 1791, 1793
 NaAsH_2 595
 $\text{Na}_3\text{AsO}_2\text{S}_2 \cdot 11\text{H}_2\text{O}$ 605
 $\text{Na}_3\text{AsO}_3\text{S} \cdot 12\text{H}_2\text{O}$ 605
 $\text{Na}_3\text{AsS}_4 \cdot 8\text{H}_2\text{O}$ 604
 Na_2Au 1793
 $\text{Na}[\text{B}(\text{C}_6\text{H}_5)_4]$ 803
 NaBF_4 222
 NaBH_4 776
 $\text{NaBH}_4 \cdot 2\text{H}_2\text{O}$ 777
 NaBO_2 791, 793
 $\text{NaBO}_2 \cdot \frac{1}{2}\text{H}_2\text{O}$ 791
 $\text{NaBO}_2 \cdot 2\text{H}_2\text{O}$ 791
 $\text{NaBO}_2 \cdot 4\text{H}_2\text{O}$ 791
 $\text{NaBO}_2 \cdot \text{H}_2\text{O}_2 \cdot 3\text{H}_2\text{O}$ 796
 $\text{NaBO}_3 \cdot 4\text{H}_2\text{O}$ 795
 $\text{NaB}_5\text{O}_8 \cdot 5\text{H}_2\text{O}$ 795
 $\text{Na}_2\text{B}_4\text{O}_7$ 794
 $\text{Na}_2\text{B}_4\text{O}_7 \cdot 2\text{H}_2\text{O}$ 794
 $\text{Na}_2\text{B}_4\text{O}_7 \cdot 4\text{H}_2\text{O}$ 794
 $\text{Na}_2\text{B}_4\text{O}_7 \cdot 5\text{H}_2\text{O}$ 793
 $\text{Na}_2\text{B}_4\text{O}_7 \cdot 10\text{H}_2\text{O}$ 793
 Na_3BO_3 790
 Na_4BeO_3 895
 Na_3Bi 986, 1793
 NaBiO_3 627
 $\text{NaBiO}_3 \cdot n\text{H}_2\text{O}$ 628
 $\text{NaBrO} \cdot 5\text{H}_2\text{O}$ 310
 Na_2C_2 987
 Na_2CO_3 988
 $\text{Na}_3[(\text{CO})\text{Fe}(\text{CN})_5]$ 1769
 NaClO 309
 $\text{NaClO} \cdot 5\text{H}_2\text{O}$ 309
 $\text{NaClO}_2 \cdot 3\text{H}_2\text{O}$ 312
 $\text{Na}_3[\text{Co}(\text{NO}_2)_6]$ 1541
 $\text{Na}_3[\text{Cr}(\text{OH})_6]$ 1688
 NaCrS_2 1394
 $\text{Na}_2[\text{Cu}(\text{OH})_4]$ 1684
 NaF 235
 $\text{Na}_2[\text{Fe}(\text{CN})_5\text{NH}_3] \cdot \text{H}_2\text{O}$
 1512
 $\text{Na}_3[\text{Fe}(\text{CN})_5\text{NH}_3] \cdot 3\text{H}_2\text{O}$
 1511
 $\text{Na}_2[\text{Fe}(\text{OH})_4]$ 1686
 $\text{Na}_3[\text{Fe}(\text{OH}_2)(\text{CN})_5]$ 1770
 $\text{Na}_4[\text{Fe}(\text{OH})_7] \cdot 2\text{H}_2\text{O}$
 1689
 $\text{Na}_5[\text{Fe}(\text{OH})_8] \cdot 5\text{H}_2\text{O}$
 1690
 $\text{Na}_3\text{Fe}(\text{SCN})_6 \cdot 12\text{H}_2\text{O}$
 1511
 NaGe 989
 NaGeH_3 714
 Na_2GeH_2 714
 NaH 971
 $\text{NaH}_2\text{AsO}_4 \cdot \text{H}_2\text{O}$ 602
 $\text{Na}_3\text{H}_2\text{As}_3\text{O}_{10}$ 1709
 $\text{NaHB}(\text{OCH}_3)_3$ 777
 $\text{Na}_3\text{H}_2\text{IO}_6$ 323
 $\text{Na}_7[\text{HNb}_6\text{O}_{19} \cdot \text{aq}]$ 1706
 $\text{Na}_3\text{HP}_2\text{O}_7$ 548
 $\text{NaH}_2\text{PO}_4 \cdot 2\text{H}_2\text{O}$ 544
 $\text{Na}_2\text{H}_2\text{P}_2\text{O}_6 \cdot 6\text{H}_2\text{O}$ 560
 NaHS 357
 NaHSe 419
 $\text{Na}_2\text{H}_4\text{TeO}_6$ 453
 $\text{Na}_2\text{H}_4\text{TeO}_6 \cdot 3\text{H}_2\text{O}$ 454
 NaIO_3 323
 NaIO_4 323, 324
 $\text{NaIO}_4 \cdot 3\text{H}_2\text{O}$ 324
 $\text{Na}_2[\text{Mg}(\text{OH})_4]$ 1683
 $\text{Na}_3\text{MnO}_4 \cdot \frac{1}{4}\text{NaOH} \cdot 12\text{H}_2\text{O}$
 1460
 NaN_3 474
 Na^{15}N_3 466
 NaNH_2 465
 $\text{Na}^{15}\text{NH}_2$ 466
 $\text{Na}(\text{NH}_3)_2\text{C}_{12}$ 636
 NaNO 514
 Na_2NO_2 515
 $\text{Na}_2\text{N}_2\text{O}_3$ 517
 $\text{Na}_2\text{N}_2\text{O}_2 \cdot 9\text{H}_2\text{O}$ 495
 $\text{Na}_2[(\text{NO})\text{Fe}(\text{CN})_5] \cdot 2\text{H}_2\text{O}$
 1768
 $\text{Na}[(\text{NO})_2\text{FeS}] \cdot 4\text{H}_2\text{O}$
 1763
 $\text{Na}[(\text{NO})_2\text{FeSe}_2\text{O}_3]$ 1766
 $\text{Na}_8[\text{Nb}_6\text{O}_{19} \cdot \text{aq}]$ 1706
 NaO_2 980
 Na_2O 974
 Na_2O_2 979
 $\text{Na}_2\text{O} \cdot \text{As}_2\text{O}_5 \cdot 6\text{MoO}_3 \cdot \text{aq}$
 1736
 $3\text{Na}_2\text{O} \cdot \text{As}_2\text{O}_5 \cdot 18\text{MoO}_3 \cdot$
 $\cdot \text{aq}$ 1735
 $5\text{Na}_2\text{O} \cdot \text{B}_2\text{O}_3 \cdot 24\text{WO}_3 \cdot \text{aq}$
 1717
 NaOD 121
 $5\text{Na}_2\text{O} \cdot \text{I}_2\text{O}_7 \cdot 12\text{MoO}_3 \cdot \text{aq}$
 1738
 $\text{Na}_2\text{O} \cdot 4\text{MoO}_3 \cdot \text{aq}$ 1712
 $5\text{Na}_2\text{O} \cdot 12\text{MoO}_3 \cdot \text{aq}$ 1710
 $10\text{Na}_2\text{O} \cdot \text{P}_2\text{O}_5 \cdot 24\text{V}_2\text{O}_5 \cdot \text{aq}$
 1739
 $3\text{Na}_2\text{O} \cdot \text{P}_2\text{O}_5 \cdot 24\text{WO}_3 \cdot \text{aq}$
 1720
 $2\text{Na}_2\text{O} \cdot \text{SiO}_2 \cdot 12\text{MoO}_3 \cdot \text{aq}$
 1729
 $\text{Na}_2\text{O} \cdot \text{V}_2\text{O}_5 \cdot \text{aq}$ 1703
 $2\text{Na}_2\text{O} \cdot \text{V}_2\text{O}_5 \cdot \text{aq}$ 1702
 $3\text{Na}_2\text{O} \cdot 5\text{V}_2\text{O}_5 \cdot \text{aq}$ 1703

pp 1-992: Vol. 1; pp 1003-1810: Vol. 2

- Rh₂O₃ 1588
 Rh₂(SO₄)₃·4H₂O 1589
 Rh₂(SO₄)₃·15H₂O 1589
 Ru 1595
 RuCl₃ 1597
 RuCl₃·H₂O 1597
 RuO₂ 1599
 RuO₄ 1599
 Ru(OH)Cl₃ 1597
- S
- S 341
 S₂Br₂ 377
 S₃Br₂ 379
 S₄Br₂ 379
 S₅Br₂ 379
 S₆Br₂ 379
 S₇Br₂ 379
 S₈Br₂ 376
 (SCN)₂ 671
 SCl₂ 370
 SCl₄ 376
 S₂Cl₂ 371
 S₃Cl₂ 373
 S₄Cl₂ 372, 375
 S₅Cl₂ 372, 375
 S₆Cl₂ 372, 375
 S₇Cl₂ 372, 376
 S₈Cl₂ 372, 376
 SF₄ 168
 SF₆ 169
 S₂N₂ 409
 S₄N₂ 408
 S₄N₄ 406
 S₄(NH)₄ 411
 S₇NH 411
 S₃N₂O₂ 413
 S₃N₂O₅ 414
 SO 379
 (SO₃₋₄)_x 382
 S₂O 380
 S₂O₃ 380
 SOBr₂ 387
 SO₂BrF 176
 SOCl₂ 382
 SO₂Cl₂ 383
 S₂O₅Cl₂ 386
 SOClF 174
 SO₂ClF 175
 SOF₂ 170, 179
 SOF₄ 171
 SO₂F₂ 173
 S₃O₈F₂ 174
 (SO₂N)₃Ag₃·3H₂O 483
 SONH 480
 (SO₂NH)₃ 483
 SO₂(NH₂)₂ 482
 SO₂(NHA_g)₂ 483
 Sb 606
 SbBr₃ 613
 SbCl₃ 608
 SbCl₅ 610
 SbCl₅·H₂O 610
 SbCl₅·4H₂O 610
 SbCl₂F₃ 200
 SbF₃ 199
 SbF₅ 143, 200
 SbH₃ 606
 SbI₃ 614
 Sb₂O₃ 615
 Sb₂O₄ 618
 Sb₂O₅ 616
 Sb₂O₅·(H₂O)_x 617
 SbOCl 611
 Sb₄O₅Cl₂ 611
 (SbO)₂SO₄ 619
 Sb₂(SO₄)₃ 618
 SeF₃ 245
 Se 415
 SeBr₄ 427
 Se₂Br₂ 426
 SeCl₄ 423
 Se₂Cl₂ 422
 SeF₄ 180
 SeF₆ 179
 Se₄N₄ 435
 SeO₂ 428
 SeOCl₂ 429
 SeO(OC₂H₅)₂ 435
 SeSO₃ 435
 Si 676
 SiBr₂ 687
 SiBr₄ 686, 688
 Si₂Br₆ 688
 Si(CH₃COO)₄ 701
 SiCH₃Cl₃ 695
 Si(CH₃)₂Cl₂ 694, 695
 SiCl₄ 680, 682
 Si₂Cl₆ 680
 Si₃Cl₈ 684
 Si₄Cl₁₀ 684
 Si₅Cl₁₂ 684
 Si₆Cl₁₄ 684
 Si₁₀Cl₂₂ 684
 Si₁₀Cl₂₀H₂ 685
 SiF₄ 212
 (SiH)_x 681
 (SiH₂)_x 681
 SiH₄ 679, 680
 Si₂H₆ 679
 Si₃H₈ 679
 SiHBr₃ 692
 SiH₂Br₂ 694
 SiHCl₃ 691
 SiH₂Cl₂ 691
 SiH₃Cl 691
 SiHF₃ 214
 SiI₄ 689
 Si₂I₆ 690
 Si(N₃)₄ 476
 Si(NCO)₄ 702
 SiO 696
 Si₂O₃ 700
 Si(OCH₃)₄ 702
 Si(OC₂H₅)₄ 702
 Si(OCN)₄ 702
 Si₂OCl₆ 696
 Si₃O₂Cl₈ 696
 Si₄O₃Cl₁₀ 696
 Si₄O₄Cl₈ 695
 Si₅O₄Cl₁₂ 696
 Si₆O₅Cl₁₄ 696
 Si₇O₆Cl₁₆ 696
 SiO₂·12WO₃·aq 1718
 SiS 700
 SiS₂ 700

pp 1-992: Vol. 1; pp 1003-1810: Vol. 2

SmBr ₂ 1150	T	TiBr ₄ 1201
SmCl ₂ 1135	TaBr ₂ 1311	TiC 1245
SmI ₂ 1149	TaBr ₃ 1311	TiCl ₂ 1185
Sn 727	TaBr ₄ 1310	TiCl ₃ 1187
SnBr ₂ 732	TaBr ₅ 1311	TiCl ₃ ·6H ₂ O 1187, 1193
SnBr ₄ 733	TaC 1331	TiCl ₄ 1195
Sn(CH ₃) ₄ 744	TaCl ₄ 1301	TiF ₃ 248
Sn(C ₂ H ₅) ₄ 746	TaCl ₅ 1302, 1305	TiF ₄ 250
Sn(CH ₃ COO) ₄ 747	TaF ₅ 255	Ti-H 1184
SnCl ₂ 728	Ta-H 1296	TiH ₂ 114
SnCl ₄ 729	TaI ₅ 1316	TiI ₂ 1185
SnF ₂ 217	Ta-N 1328	TiI ₃ 1187, 1192
SnF ₄ 217	Ta ₂ O ₅ 1318	TiI ₄ 1205
SnI ₂ 734	[Ta ₅ O ₁₆ ·aq]Na ₇ 1708	TiN 1233
SnI ₄ 735	[Ta ₆ O ₁₉ ·aq]Na ₈ 1708	Ti(NO ₃) ₄ 1237
SnO 736	TaP 1330	TiO 1214
SnO ₂ 738	TaP ₂ 1330	TiO ₂ 1216
SnO ₂ ·nH ₂ O 737	Ta-S 1328	TiO ₂ ·nH ₂ O 1218
[Sn(OH) ₃]Na 1687	TaSi ₂ 1792, 1797	Ti ₂ O ₃ 1214
[Sn(OH) ₆]Na ₂ 1694	Te 437	TiOCl 1209
SnS 739	TaBr ₄ 445	TiOCl ₂ 1209
SnS ₂ 741	TeCl ₄ 442	TiO(NO ₃) ₂ 1241
Sn(SO ₄) ₂ ·2H ₂ O 744	TeF ₆ 180	TiOSO ₄ 1228
Sr 922	TeI ₄ 447	TiOSO ₄ ·2H ₂ O 1229
SrBr ₂ 930	TeO ₂ 447	TiP 1241
SrCO ₃ 931	TeO ₃ 450	TiS ₂ 1222
SrCl ₂ 930	Te ₂ O ₃ (OH)NO ₃ 437, 447	TiS _{<2} 1222, 1224
Sr(ClO ₄) ₂ 320	TeSO ₃ 455	TiS ₃ 1222
Sr(ClO ₄) ₂ ·4H ₂ O 320	Th 1174	Ti ₂ (SO ₄) ₃ 1226
SrF ₂ 234	ThBr ₄ 1203	TiSi ₂ 1249
SrH ₂ 929	ThC 1248	Tl 867
SrI ₂ 930	ThC ₂ 1248	TlBr 869
Sr(N ₃) ₂ 941	ThCl ₄ 1203	TlBr ₃ ·4H ₂ O 874
Sr ₃ N ₂ 940	ThCl ₄ ·8H ₂ O 1204	Tl ₂ CO ₃ 884
Sr ₂ [Ni(OH) ₆] 1686	Th-H 1185	TlCl 869
SrO 932	ThI ₄ 1205	TlCl ₃ 870
SrO ₂ 936	Th ₃ N ₄ 1236	TlCl ₃ ·4H ₂ O 870
SrO ₂ ·8H ₂ O 935	Th(NO ₃) ₄ 1240	TlF 230
Sr(OH) ₂ ·8H ₂ O 935	Th(NO ₃) ₄ ·nH ₂ O 1238	TlF ₃ 230
SrS 938	ThO ₂ 1221	TlI 869
SrSe 939	Th ₃ P ₄ 1241	TlI-I ₂ 876
SrSeO ₃ 939	ThSi ₂ 1249, 1792, 1797	TlI ₃ 876
SrSeO ₄ 939	Ti 1161	Tl ₃ N 883
SrSi 947	TiBr ₂ 1185	TlNO ₃ 883
SrTe 940	TiBr ₃ 1187, 1192	Tl ₂ O 877
	TiBr ₃ ·6H ₂ O 1187, 1195	Tl ₂ O ₃ 879

pp 1-992: Vol. 1; pp 1003-1810: Vol. 2

- $\text{Ti}_2\text{O}_3 \cdot x\text{H}_2\text{O}$ 879
 TiOH 877
 $\text{Ti}(\text{OH})\text{SO}_4 \cdot 2\text{H}_2\text{O}$ 882
 $\text{Ti}_2(\text{OOC})_2\text{CH}_2$ 884
 TiOOCH 884
 Ti_2S 880
 $\text{Ti}_2\text{S} \cdot \text{Ti}_2\text{S}_3$ 880
 Ti_2SO_4 881
 $\text{Ti}_2\text{Se} \cdot \text{Ti}_2\text{Se}_3$ 881
 Ti_2TeCl_6 444
 $\text{Ti}(\text{TiBr}_4)$ 875
 $\text{Ti}_3(\text{TiBr}_6)$ 875
 $\text{Ti}(\text{TiCl}_4)$ 872
 $\text{Ti}_3(\text{TiCl}_6)$ 873
- U
- U 1431
 UBr_4 1440
 $\text{U}(\text{C}_2\text{O}_4)_2 \cdot 6\text{H}_2\text{O}$ 1449
 UCl_3 1435
 UCl_4 1436
 UCl_5 1438
 UD_3 123
 UF_4 261
 UF_6 262
 UH_3 113, 1434
 UO_2 1442
 UO_3 1442
 $\text{U}(\text{OC}_2\text{H}_5)_5$ 1451
 $\text{U}(\text{OC}_2\text{H}_5)_6$ 1452
 $\text{UO}_2(\text{C}_{15}\text{H}_{11}\text{O}_2)_2$ 1453
 UO_2Cl_2 1439
 $\text{UO}_4 \cdot 2\text{H}_2\text{O}$ 1446
 US_2 1446
 $\text{U}(\text{SO}_4)_2 \cdot 4\text{H}_2\text{O}$ 1447
 $\text{U}(\text{SO}_4)_2 \cdot 8\text{H}_2\text{O}$ 1447
 USi_2 1792
- V
- V 1252
 VBr_2 1260
 VBr_3 1260
- VC 1288
 V_2C 1288
 $\text{V}(\text{CH}_3\text{COO})_3$ 1283
 $\text{V}(\text{C}_6\text{H}_6)_2$ 1289
 VCl_2 1255
 VCl_3 1256
 $\text{VCl}_3 \cdot 6\text{H}_2\text{O}$ 1256
 VCl_4 1259
 VF_3 252
 VF_4 252
 VF_5 253
 V-H 1296
 VI_2 1261
 VI_3 1262
 VN 1286
 V_2N 1287
 VO 1268
 VO_2 1267
 V_2O_3 1267
 V_2O_5 1270
 V_6O_{13} 1266
 $\text{V}_n\text{O}_{2n-1}$ 1267
 VOCl 1262
 VOCl_2 1263
 VOCl_3 1264
 VO_2Cl 1265
 $\text{V}(\text{OH})_3$ 1268
 VOSO_4 1285
 $\text{VOSO}_4 \cdot 3\text{H}_2\text{O}$ 1285
 $\text{VP}_{<1}$ 1287
 VP 1287
 VP_2 1287
 VS 1274
 VS_4 1275
 V_2S_3 1275
 $\text{V}_2(\text{SO}_4)_3$ 1283
 $\text{VSO}_4 \cdot 6\text{H}_2\text{O}$ 1277
 VSi_2 1792
- W
- W 1417, 1622
 $\text{W}(\text{CO})_6$ 1741
 WCl_5 1419
 WCl_6 1420
- $\text{W}_2\text{Cl}_6\text{Py}_3$ 1429
 WF_6 260
 WO_2 1421
 WO_3 1423
 $\text{WO}_3 \cdot \text{aq}$ 1728
 $\text{W}_{18}\text{O}_{49}$ 1422
 $\text{W}(\text{OC}_6\text{H}_5)_6$ 1426
 WOCl_4 1425
 WS_2 1425
 WSi_2 1792, 1797
- Y
- YF_3 246
 YbBr_2 1150
 YbCl_2 1150
 YbI_2 1150
 YbSO_4 1138
- Z
- Zn 1067
 ZnAs_2 1083
 Zn_3As_2 594, 1083
 ZnBr_2 1072
 $\text{Zn}(\text{CH}_3\text{COO})_2$ 1087
 $\text{Zn}(\text{C}_2\text{H}_5)_2$ 1084
 $\text{Zn}(\text{CN})_2$ 1087
 ZnCO_3 1086
 ZnCl_2 1070
 ZnF_2 242
 ZnFe_2O_4 1090
 ZnH_2 1069
 ZnI_2 1073
 Zn_3N_2 1080
 $\text{Zn}(\text{NH}_2)_2$ 1079
 $[\text{Zn}(\text{NH}_3)_4]\text{MoO}_8$ 1414
 ZnO 1664
 $\text{Zn}(\text{OH})_2$ 1074
 $\text{Zn}(\text{OH})\text{Cl}$ 1071
 $[\text{Zn}(\text{OH})_3]\text{Na}$ 1681
 $[\text{Zn}(\text{OH})_4]\text{Na}_2$ 1682
 $\text{Zn}_2(\text{OH})\text{PO}_4$ 1082
 $5\text{ZnO} \cdot 12\text{WO}_3 \cdot \text{aq}$ 1713

pp 1-992: Vol. 1; pp 1003-1810: Vol. 2

Zn ₃ P ₂ 1080	Zr 1172	ZrOCl ₂ ·8H ₂ O 1210
Zn ₃ (PO ₄) ₂ ·4H ₂ O 1081	ZrBr ₄ 1203	ZrO(NO ₃) ₂ 1241
ZnS 1075	ZrC 1245	ZrP 1241
ZnS ₂ O ₄ 394	ZrCl ₄ 1203	ZrP ₂ 1241
Zn(SO ₂ ·CH ₂ OH) ₂ 1076	ZrF ₄ 251	ZrS ₂ 1226
Zn ₃ (SbS ₄) ₂ 1083	Zr-H 1185	ZrS ₃ 1226
ZnSe 1078	ZrI ₄ 1205	Zr(SO ₄) ₂ 1231
ZnSiF ₆ ·6H ₂ O 1090	ZrN 1233	Zr(SO ₄) ₂ ·4H ₂ O 1231
Zn ₂ SiO ₄ 1089	ZrO ₂ 1220	ZrSi ₂ 1249, 1792

Subject Index

pp 1-992: Vol. 1; pp 1003-1810: Vol. 2

This index is arranged alphabetically in terms of the major element, group or unit constituting the compound. Numerical prefixes such as mono, di, tri, etc., as well as poly are disregarded for purposes of arrangement (except that, for example, hexaphosphates follow pentaphosphates). The same applies to ortho, meta, para and pyro but not to per, sub, hypo and oxo.

Prefixes occurring at the beginning of the first word are not underlined. They are underlined within the word to help distinguish the key roots.

A

- Acetates—see parent cation
Acetylacetonate, aluminum 836
chromium 1383
Active metals 1613
Active metal oxides 1656
 α -Alaninate, chromium 1383
Alkali aluminates 1692
Alkali ammine graphite compounds 637
Alkali graphite compounds 635
Alkali hydrides 971
Alkali metal antimonides 985
arsenides 985
bismuthides 985
carbides 987
carbonates 987
germanides 989
niobates 1323
oxides 974
dioxides 980
phosphides 985
silicides 989
tantalates 1323
uranates (V) 1445
uranates (VI) 1445
Alkali metals, free 956
Alkyl ester of silicic acid 702
Alum, ammonium gallium (III) 854
ammonium vanadium 1284
cesium 956
cesium manganese 1468
cesium vanadium (III) 1284
potassium vanadium (III) 1284
rubidium vanadium (III) 1284
Aluminate, ammonium tetrafluoro- 227
hexafluoro- 226
cobalt 1525
monopotassium oxohydroxo- 1693
Aluminate, sodium tetrachloro- 816
monosodium oxohydroxo-(I) 1693
oxohydroxo-(II) 1693
tetrasodium heptahydroxo- 1692
Aluminum acetate 835
acetylacetonate 836
amalgam 1807
arsenide 831
azide 476, 829
boride 772
bromide 813
bromide-hydrogen sulfide adduct 819
calcium hydride 806
carbide 832
chloride 812
chloride ammoniate 817
chloride graphite 644
chloride hydrate 815
chloride-phosphorus pentachloride adduct 818
chloride-sulfur dioxide adduct 817
chloride-thionyl chloride adduct 818
tetrachloroaluminic acid dietherate 816
chlorohydride 808
triethanolamine 835
triethyl- 810
diethyl-, bromide 809
triethyl-, etherate 811
diethyl-, hydride 811
ethoxide 834
fluoride 225
hydride trimethylamine 809
hydride, polymeric 807
hydroxide 820
hydroxide gel 1652
iodide 814
iodide-hexaammoniate 819
lithium cyanide 833
lithium hydride 805

pp 1-992: Vol. 1; pp 1003-1810: Vol. 2

- Aluminum lithium nitride 828
 lithium phosphide 830
 methoxide 833
 nitride 827
 oxide 822, 1660
 orthophosphate 831
 phosphide 829
 selenide 825
 sulfide 823
 basic 824
 neutral 824
 telluride 826
 Amalgams 1801
 Amalgam, aluminum 1807
 barium 1805, 1806
 bismuth 1806
 cadmium 1806
 calcium 1804
 lead 1806
 potassium 1803
 rare earth 1807
 sodium 1802
 strontium 1805
 tin 1806
 zinc 1806
 Amide, lithium 463
 sodium 465
 tetraAmide, pyrophosphoryl 588
 triAmide, phosphoryl 584
 thiophosphoryl 587
 monoAmidophosphate, disodium 581
 diAmidophosphoric acid 582
 monoAmidophosphoric acid 579
 Amidosulfonate, potassium 507
 Amidosulfonic acid 508
 Aminate, borine trimethyl- 778
 trans-diAmminedichloroplatinum (II) 1578
 hexaAmminechromium (III) chloride 1351
 nitrate 1351
 triAmminechromium tetroxide 1392
 hexaAmminecobalt (II) chloride 1516
 (III) chloride 1516
 (II) nitrate 1526
 Ammine complexes of platinum (II) 1577
 decaAmmine- μ -peroxocobalt (III) cobalt
 (IV) sulfate 1540
 tetraAmminecopper (II) sulfate 1021
 diAmminemercury (II) dichloride 1114
 hexaAmminenickel (II) chloride 1545
 diAmminepalladium (II) salts 1585
 tetraAmminezinc tetraperoxomolybdate (VI)
 1414
 Ammonia 460
 from labeled NH_4Cl 461
 solutions of 463
 Ammoniate, boron trifluoride 785
 Ammoniated mercuric chloride 1114
 Ammonium aluminum fluoride 226
 orthoarsenate 602
 hexabromoantimonate 615
 carnallite 908, 951
 Ammonium chlorate 313
 hexachloroiridate (IV) 1594
 -osmate (IV) 1603
 tetrachloropalladate (II) 1584
 chloroplatinate 1570
 hexachloroplatinate (IV) 1570
 -plumbate 751
 -rhodate (III) 1588
 -ruthenate (IV) 1599
 -selenate 425
 -stannate 731
 -tellurate 444
 -titanate 1199
 tetrachlorozincate 1072
 cryolite 226
 hexacyanoferrate (II) 1509
 fluoride 183
 tetrafluoroaluminate 227
 hexafluoroaluminate 226
 tetrafluoroberyllate 232
 hexafluorogallate 228
 hexafluoroindate 229
 difluorophosphate 196
 hexafluorophosphate 195
 gallium alum 854
 gallium (III) sulfate 854
 hydrogen fluoride 183
 hydrogen sulfide 357
 iodide 289
 iridium (IV) chloride 1594
 lead (IV) chloride 751
 luteophosphotungstate 1723
 hexanitrorhodate (III) 1586
 heptanitrosyltrithioferrate 1764
 oxopentachloromolybdate (V) 1413
 palladium (IV) chloride 1584
 palladochloride 1584
 pentaperoxodichromate 1392
 peroxydisulfate 390
 perrhenate 1484
 persulfate 390
 platinichloride 1570
 plumbic chloride 751
 rhodanilate 1378
 ruthenium (IV) chloride 1599
 salt of rhodanilic acid 1378
 diAmmonium pentasulfane 369
 Ammonium disulfatovanadate (III) 1283
 pentasulfide 369
 thioarsenate 604
 trithiocarbonate 674
 tetrathiocyanatodiamminechromate (III)
 1376
 -dianilinochromate (III)
 1378
 tetrathiomolybdate 1416
 paratungstate 1713
 uranyl carbonate 1449
 metavanadate 1272
 vanadium (III) alum 1284
 zinc sulfate 1077

pp 1-992: Vol. 1; pp 1003-1810: Vol. 2

- Anhydrous sodium tetraborate 793
 Antimonate, ammonium hexabromo- 615
 sodium thio- 619
 Antimonic acid, hexachloro- 611
 Antimonide, gallium 857
 indium 867
 lithium 985
 potassium 986
 sodium 986
 Antimony 606
 explosive 1638
 Antimony bromide (III) 613
 chloride (III) 608
 chloride (V) 610
 dichloride trifluoride 200
 fluoride (III) 199
 fluoride (V) 200
 hydrated oxide (V) 617
 hydride (stibine) 606
 iodide (III) 614
 (III) oxide 615
 (V) oxide 616
 diAntimony tetroxide 618
 Antimony (III) oxide chloride 611
 oxide sulfate 619
 (III) sulfate 618
 Aquopentaamminecobalt (III) oxalate 1533
 diAquotetraamminecobalt (III) sulfate 1537
 hexaAquochromium (III) acetate 1371
 (III) chloride 1348
 orthoArgentite, sodium 1039
 Argentous sulfide 1039
 Arsenate, ammonium ortho- 602
 boron 797
 hydroxylammonium 501
 sodium dihydrogen ortho- 602
 triArsenate, sodium hydrogen 1709
 Arsenates, isopoly- 1709
 1-Arsenates, 12-molybdic acid- 1734
 12-tungstic acid- 1724
 2-Arsenates, 6-molybdic acid- 1736
 18 molybdic acid- 1734
 18-tungstic acid- 1725
 Arsenic 591
 yellow 592
 orthoArsenic acid 601
 Arsenic tribromide 597
 trichloride 596
 fluoride (III) 197
 fluoride (V) 198
 diiodide 598
 triiodide 597
 diArsenic pentasulfide 603
 trioxide 600
 tetraArsenic tetrasulfide 603
 Arsenide, gallium 857
 indium 867
 lithium 985
 magnesium 917
 potassium 986
 sodium 986
 Arsenide, sodium dihydrogen 595
 Arsenic 593
 Aurate (III), hydrogen tetrachloro- 1057
 Aurate, potassium 1061
 potassium tetrachloro- 1058
 Aurate (I), potassium dicyno- 1065
 Auric chloride 1056
 hydroxide 1060
 oxide 1059
 potassium chloride 1058
 Aurochlorohydric acid 1057
 Aurous chloride 1055
 s-triAzaborane 779
 Azide 474, 959
 aluminum 829
 barium 942
 beryllium 899
 lead 763
 magnesium 917
 Azodisulfonate, potassium 510

B

- Barium 922, 928
 amalgam 1805, 1806
 azide 942
 bromide 930
 chlorate 314
 chloride 930
 chromate 316
 chromate (V) 1394
 orthochromate (IV) 1393
tetracyanoplatinate (II) 1576
 fluoride 234
 hydride 929
 dihydrogen hypophosphite 562
hexahydroxocuprate (II) 1685
hexahydroxoferrate (III) 1690
heptahydroxoferrate (III) 1690
 hypophosphite 557
 iodide 930
 manganate (VII) 1462
 nitride 941
 oxohydroxostannate (II) 1696
 oxide 933
 perchlorate 320
 periodate 326
 permanganate 1462
 peroxide 937
 peroxide octahydrate 937
 perrhenate 1487
 mesoperrhenate 1487
platinocyanide 1576
 rhenate (VI) 1485
 purification of salts of 933
 selenide 939
disilicate 706
metasilicate 706
 silicide 947
 sulfate-potassium permanganate solid
 solution 1463

pp 1-992: Vol. 1; pp 1003-1810: Vol. 2

- Barium sulfide 938
 telluride 940
 trithiocarbonate 674
 dithionate 397
 dithiophosphate 571
 Bayerite 821
 diBenzenechromium (0) 1395
 (1) iodide 1397
 diBenzenemolybdenum (0) 1402
 diBenzenevanadium (0) 1289
 (Berthollet's) fulminating or detonating
 silver 1046
 Beryllate, ammonium tetrafluoro- 232
 sodium 895
 Beryllium 887
 acetate 901
 acetate, basic 901
 azide 899
 bromide 891
 carbide 899
 carbonate 893
 chloride 889
 formate, basic 902
 fluoride 231
 hydroxide 894
 iodide 892
 nitride 898
 oxide 893
 propionate, basic 902
 selenide 897
 sulfide 895
 telluride 897
 Bismuth 620
 amalgam 1806
 borate 627
 (III) bromide 623
 chloride 621
 dichloride 622
 fluoride 201
 (V) fluoride 202
 (III) iodide 624
 diBismuth tetraoxide 629
 Bismuth oxide bromide 624
 oxide chloride 622
 oxide iodide 625
 oxide nitrite 626
 (III) phosphate 626
 Bismuthate, potassium 628
 sodium 627
 anhydrous 627
 hydrous 628
 Bismuthide, lithium 985
 potassium 986
 sodium 986
 Bisulfide, carbon 652
 Boehmite 821
 diBorane 773
 Borate, bismuth 627
 lithium aluminum 796
 nitrosyl fluoro- 224
 potassium fluoro- 223
 Borate, potassium hydroxyfluoro- 224
 metaBorate, sodium 791
 orthoBorate, sodium 790
 tetraBorate, sodium 793
 pentaBorate, sodium 795
 Borate, sodium fluoro- 222
 sodium tetraphenyl- 803
 1-Borates, 12-tungstic acid- 1716
 Borax 793
 Borazole 779
 s-trichloro- 779
 metaBoric acid 791
 Borides 1798
 aluminum 772
 Borine trimethylamine 778
 Borofluoride, sodium 222
 Borohydride, lithium 775
 sodium 776
 sodium trimethoxy 777
 Boron 770
 tetragonal 772
 Boron trialkyls 800
 arsenate 797
 azide 476
 tribromide 781
 trichloride 780
 triethyl- 799
 trifluoride 219
 trifluoride ammoniate 785
 etherate 786
 difluoride, n-butyl- 802
 trifluoride dihydrate 784
 triiodide 782
 methoxide 797
 trimethyl- 798
 nitride 789
 oxide 787
 phosphate 796
 (III) sulfide 788
 Boronic acid, n-butyl- 801
 Boroxine, trimethyl- 800
 tri-n-butyl- 801
 monoBromamine 480
 Bromate, barium 316
 potassium tetrafluoro (III)- 237
 Bromic acid 315
 Bromide--See parent cation
 Bromine 275
 purification of 275
 Bromine trifluoride 156
 pentafluoride 158
 graphite 643
 hydrate 276
 (III) nitrate 328
 dioxide 306
 diBromine monoxide 307
 hexaBromoantimonate, ammonium 615
 Bromofluorophosgene 210
 diBromiodide, cesium 297
 potassium 296
 triBromotripyridinemolybdenum 1408

pp 1-992: Vol. 1; pp 1003-1810: Vol. 2

triBromosilane 692
 diBromodisulfane 377
 -trisulfane 379
 -tetrasulfane 379
 -pentasulfane 379
 -hexasulfane 379
 -heptasulfane 379
 -octasulfane 379
 hexaBromothallate (III), rubidium 876
 thallium (I) 875
 tetraBromothallate (III), thallium (I) 875

C

Cadmate, potassium tetracyano- 1106
 Cadmium (needles) 1092
 Cadmium acetate 1105
 amalgam 1806
 amide 1100
 arsenide 1103
 bromide 1096
 carbonate 1104
 chloride 1093
 chloride hydroxide 1094
 cyanide 1105
 diethyl- 1103
 ferrate (III) 1107
 fluoride 243
 hydroxide 1097
 hydroxychloride 1094
 iodide 1096
 nitride 1100
 phosphides 1101
 potassium chloride 1095
 cyanide 1106
 rhodanide 1106
 selenide 1099
 silicate 1107
 orthosilicate 1107
 sulfide 1098
 thiocyanate 1106
 Calcium 922
 aluminum hydride 806
 amalgam 1801
 bromide 930
 carbide 943
 chloride 930
 cyanamide 946
 fluoride 233
 germanide 948
 hydride 929
 hydroxide 934
 iodide 930
 nitride 940
 oxide 931
 perchlorate 320
 peroxide 936
 peroxide hydrate 937
 phosphide 527, 942
 Calcium orthoplumbate 760
 Calcium salts, purification of 931
 selenide 939
 silicide 946
 sulfide 938
 telluride 940
 Carbide, aluminum 832
 beryllium 899
 calcium 943
 lithium 987
 magnesium 920
 sodium 987
 Carbon 630
 adsorptive (activated) 633
 black, graphitized 631
 lustrous 632
 monoxide black 631
 oxygen compounds reacting as acids 634
 oxygen compounds reacting as bases 634
 preparations, special 631
 sulfur compounds 634
 surface compounds of 633
 Carbon monofluoride 640
 tetrafluoride 203
 tetraCarbon monofluoride 641
 Carbon monoxide 645
 purification of tank CO 646
 Carbon dioxide 647
 purification of tank CO₂ 647
 triCarbon dioxide 648
 Carbon selenide 656
 diselenide 656
 suboxide 648
 subsulfide 653
 disulfide 652
 triCarbon disulfide 653
 Carbonate—see under parent cation
 Carbonatotetraamminecobalt (III) sulfate 1535
 Carbonyl bromofluoride 210
 chloride 650
 chlorofluoride 209
 fluoride 206
 difluoride 206
 iodofluoride 211
 iron 1636
 selenide 655
 sulfide 654
 Caro's acid 389
 Cementite 1503
 Cerium metal, solid 1142, 1145
 Cerium monochalcogenide 1155
 compounds, pure 1132
 earths, purification of 1131
 (III) fluoride 247
 (IV) fluoride 247
 (III) oxide 1151
 Cesium 957
 alum 956
 azide 959

pp 1-992: Vol. 1; pp 1003-1810: Vol. 2

- Cesium dibromiodide 297
 carbonate 988
 chloride 961
 from carnallite 951
 from dollucite 955
dichlorobromide 294
dichloriodide 296
hexachloroselenate 425
hexachlorotellurate 444
nonachlorodithallate (III) 874
 chromate 1389
dichromate 1389
dioxide 981
 germanide 989
 graphite 635
 hydride 971
 hydroxide 983
 manganese alum 1468
 manganese (III) sulfate 1468
 oxide 978
 silicide 989
 vanadium (III) alum 1284
- Cesium, purification by vacuum distillation 963
- Chalcogenides, europium (II) 1155
 monoChalcogenides, cerium 1155
 lanthanum 1155
 neodymium 1155
 praseodymium 1155
- Chinese red 1112
 monoChloramine 477
 Chlorate—see parent cation
 Chloric acid 312
 Chlorides—see parent cation
 Chlorine 272
 azide 476
 monofluoride
 trifluoride 155
 hydrate 274
 nitrate 326
 dioxide 301
 diChlorine oxide 299
 hexoxide 303
 heptoxide 304
 Chlorine dioxide fluoride 165
 trioxide fluoride 166
 tetroxide fluoride 167
- Chlorite, sodium 312
 tetraChloroaluminate, sodium 816
 tetraChloroaluminic acid dietherate 816
 triChlorotriamminechromium 1381
 -pyridinechromium 1381
- Chloropentaamminecobalt (III) chloride 1532
 -chromium (III) chloride 1352
- diChlorotetraamminecobalt (III) chloride 1536
- 1,2-diChlorotetraamminecobalt (III) chlor-
 ide (cis) 1536
- 1,6-diChlorotetraamminecobalt (III)
 chloride (trans) 1537
- Chloropentaamminerhodium salts 1590
 chloride 1590
 nitrate 1590
- Chloroantimonate (V), nitrosyl 612
 hexaChloroantimonic acid (V) 611
 diChloroaquotriamminechromium (III)
 chloride 1358
- triChlorotriaquochromium 1380
 Chloropentaaquochromium (III) chloride 1350
 sulfate 1350
 pentaChloroaquothallate (III), potassium 874
- tetraChloroaurate (III), potassium 1058
 Chloroauric acid 1057
 s-triChloroborazole 779
 Chlorochromate, potassium 1390
 triChlorodialane 808
 triChlorotriethanolochromium 1380
 cis-diChlorodiethylenediaminechromium
 (III) chloride 1356
- trans-diChlorodiethylenediaminechromium
 (III) chloride 1357
- diChlorotetrafluoroethane 205
 triChlorodifluoroethane 205
 -trifluoroethane 205
 monoChlorotrifluoromethane 205
 diChlorodifluoromethane 205
 Chlorofluorophosgene 208
 diChlorofluorophosphine 191
 triChlorogermene 721
 Chlorohydride, aluminum 808
 Chloroimidiosulfonate, potassium 508
 tetraChloroiodic acid 299
 diChloroiodide, cesium 296
 potassium 295
- tetraChloroiodide, potassium 298
 hexaChloroiridate (IV), ammonium 1594
 (III), potassium 1595
 (IV), potassium 1593
- hexaChloroiridium (IV) acid 1593
 -manganate (IV), potassium 1464
 -molybdate (III), potassium 1408
 -osmate (IV), ammonium 1603
 sodium 1602
- tetraChloropalladate (II), ammonium 1584
 potassium 1584
 sodium 1584
- hexaChloropalladate (IV), ammonium 1584
 potassium 1584
- Chlorophosgene 209
 tetraChlorophosphonium hexafluorophos-
 phate (V) 193
- Chloroplatinate (IV), ammonium 1570
 tetraChloroplatinate (II), potassium 1572
 hexaChloroplatinate (IV), ammonium 1570
 potassium 1571
 sodium 1571
- Chloroplatinic acid 1569
 tetraChloroplatinic (II) acid 1570
 hexaChloroplatinic (IV) acid 1569

pp 1-992: Vol. 1; pp 1003-1810: Vol. 2

- hexaChloroplumbate, ammonium 751
 potassium 753
 Chloropraseocobalt chloride 1537
 Chloropurpleocobalt chloride 1533
 triChlorotripyridinechromium 1381
 hexaChlorotripyridineditungstate (III) 1429
 hexaChlororhodate (III), ammonium 1588
 potassium 1588
 sodium 1587
 hexaChlororuthenate (IV), ammonium 1599
 hexaChloroselenates 425
 ammonium 425
 cesium 425
 potassium 425
 rubidium 425
 thallium 425
 Chlorosilane 691
 diChlorosilane, dimethyl 694
 Chlorosiloxanes 695
 hexaChlorostannate, ammonium 731
 potassium 731
 hexaChlorostannic acid 730
 diChloromonosulfane 370
 -disulfane 371
 -trisulfane 372
 -tetrasulfane 372
 -pentasulfane 372
 -hexasulfane 372
 -heptasulfane 372
 -octasulfane 372
 Chlorosulfonic acid 385
 hexaChlorotellurates 444
 ammonium 444
 cesium 444
 potassium 444
 rubidium 444
 thallium 444
 tetraChlorothallate (III), thallium (I) 872
 hexaChlorothallate (III), potassium 873
 thallium (I) 873
 nonaChlorodithallate (III), cesium 874
 tetraChlorothallium (III) acid 872
 enneaChloroditungstate (III), potassium 1427
 Chlorovioleocobalt chloride 1537
 Chloryl fluoride 165
 oxyfluoride 166
 diChlorylphosphoric acid anhydride 536
 Chromate, cesium 1389
 potassium chloro- 1390
 potassium fluoro- 1390
 rubidium 1388
 Chromate (II), potassium hexathiocyanato- 1374
 Chromate (III), ammonium tetrathiocyanato-
dianilino- 1378
 ammonium tetracyanatodiammine- 1376
trilithium hexaphenyl- 1375
 potassium trioxalato- 1372
 potassium tetrathiocyanatodipyridino- 1379
 Chromate (III), sodium hexahydroxo- 1688
 Chromate (IV), barium ortho- 1393
 Chromate (V), barium 1394
 potassium tetraperoxo- 1391
 diChromate, ammonium pentaperoxo- 1392
 cesium 1389
 rubidium 1388
 triChromate, potassium 1709
 tetraChromate, potassium 1710
 Chromates, isopoly- 1709
 Chromic (III) acid, tetrathiocyanatodiam-
mine- 1377
 chloride, luteo- 1351
 nitrate, luteo- 1351
 -2-Chromites, 12-molybdic acid- 1737
 Chromite, sodium thio- 1394
 Chromium 1334
 Chromium (II) acetate 1368
 (III) acetate, hexaaquo- 1371
 triChromium (III) acetate, dihydroxohexa-
acetato- 1371
 Chromium (III) acetylacetonate 1383
 (0) dibenzene- 1395
 (II) bromide 1340
 (III) bromide 1341
 carbonyl 1741
tricarbonyl, tripyridine 1749
 tetracarbonyl, dipyridine 1749
 (II) chloride 1336
 (III) chloride 1338
hexaammine- 1351
hexaaquo- 1348
 chloropentaammine- 1352
 chloropentaaquo- 1350
dichloroquatuortriammine- 1358
 chloride, erythro- 1360
 (III) chloride, cis-dichlorodiethylenedi-
 amine- 1356
 trans-dichlorodiethylenediamine- 1357
triethylenediamine 1354
 triChromium (III) chloride, dihydroxohexa-
acetato- 1371
 Chromium (III) chloride, hexaaurea- 1359
trichlorotriammine- 1381
 -triaquo- 1380
 -triethanolo- 1380
 -tripyridino- 1381
 (II) fluoride 256
 (III) fluoride 257
 (IV) fluoride 258
 (III) glycinate 1382
 (III) hydroxide 1345
 (II) iodide 1344
 (III) iodide 1344
 (I) iodide, dibenzene- 1397
bis(diphenyl)- 1397
(diphenyl)(benzene)- 1398
 (III) nitrate, hexaammine- 1351
 nitride 1347
 (II) oxalate 1370
tetroxide triammine 1392

pp 1-992: Vol. 1; pp 1003-1810: Vol. 2

- Cuprous selenide 1019
 sulfate 1020
 sulfide 1016
 telluride 1019
 Cyanamide, calcium 946
 silver 1047
 Cyanate, silicon 702
 Cyanic acid 667
 Cyanide, hydrogen 658
 lithium aluminum 833
 Cyanoamminoferrate (II), sodium penta-
 1511
 (III), sodium penta- 1512
 Cyanoaurate (I), potassium di- 1065
 tetraCyanocadmiate, potassium 1106
 Cyanochromate (III), potassium hexa- 1373
 Cyanocobaltate (III), potassium hexa- 1541
 hexaCyanocobaltic (III) acid 1542
 hexaCyanoferrate (II), ammonium 1509
 sodium carbonyl 1769
 sodium nitrosyl 1768
 hexaCyanoferric acid, (II) 1509
 (III) 1510
 Cyanogen 660
 diCyanogen 660
 Cyanogen bromide 665
 chloride 662
 iodide 666
 Cyanomanganate (I), potassium hexa- 1472
 (II), potassium hexa- 1473
 (III), potassium hexa- 1474
 potassium nitrosyl 1767
 Cyanomercurate (II), potassium tetra-
 1122
 Cyanomolybdate (IV), potassium octa-
 1416
 potassium nitrosyl 1766
 Cyanonickelate (II), potassium tetra-
 1559
 Cyanoplatinate (II), barium tetra- 1576
 potassium tetra- 1576
 Cyanotungstate (IV), potassium octa- 1429
 (V), potassium octa- 1430
 Cyanozincate, potassium tetra- 1088
 Cyanuric acid 668

D

- Deuteride, hydrogen 126
 Deuterium 121
 Deuterium bromide 131
 chloride 129
 fluoride 127
 iodide 133
 sulfide 134
 Deuteroammonia 137
 -phosphoric acid 138
 -sulfuric acid 135
 (Diphenyl)(benzene)chromium (I) iodide
 1398

E

- Erythrochromium chloride 1360
 triEthanolaminiate, aluminum 835
 Etherate, boron trifluoride 786
 Ethiop's mineral 1111
 Ethoxide, aluminum 834
 tetraEthoxygermane 725
 -silane 702
 triEthylaluminum 810
 diEthylaluminum bromide 809
 triEthylaluminum etherate 811
 diEthylaluminum hydride 811
 diEthylcadmium 1103
 triEthylenediaminecobalt (III) bromide
 1538
 optical antipodes of 1538
 triEthylenediaminechromium (III) chloride
 1354
 sulfate 1354
 thiocyanate 1354
 Ethylenediamine iron carbonyl 1756
 triEthylenediamine iron (II) octacarbonyl
diferrate (II) 1756
 diEthylmercury 1118
 Ethyl dinitrosyl thioferrate 1765
 diEthylzinc 1084
 Europium compounds, pure 1136
 Europium (II) bromide 1150
 (II) carbonate 1137
 (II) chloride 1136
 (II) fluoride 248
 (II) iodide 1150
 (II) oxide 1156
 (III) oxide 1156
 (II) selenide 1155
 (II) sulfate 1137
 (II) sulfide 1155
 (II) telluride 1155

F

- Fehling's solution 1027
 Ferrate (II), ammonium hexacyno- 1509
 Ferrate, ammonium heptanitrosyl trithio-
tetra- 1764
 Ferrate (III), barium hexahydroxo- 1691
 (III), barium heptahydroxo- 1691
 (III), lithium 1504
 (VI), potassium 1504
 (IV), potassium hexafluoro- 269
 potassium nitrosyl tricarbonyl 1759
 potassium dinitrosyl thiosulfato- 1766
 sodium carbonyl cyano- 1769
 (II), sodium pentacynoammino 1511
 (III), sodium pentacynoammino 1512
 (II), sodium pentacynoquo- 1769
 (II), sodium tetrahydroxo- 1686
 (III), sodium heptahydroxo- 1689
 (III), sodium octahydroxo- 1690

pp 1-992: Vol. 1; pp 1003-1810: Vol. 2

Ferrate (III), sodium nitrosyl cyano- 1768

(III), sodium hexathiocyno- 1511
 Ferric (II) acid, hexacyano- 1509
 (III) acid, hexacyano- 1510
 Ferric bromide 1494
 chloride 1492
 Ferricyanic acid 1510
 Ferrocyanic acid 1509
 Ferrous bromide 1493
 chloride 1491
 iodide 1495
 oxide 1497
 sulfide 1502
 Fluorides—see parent cations
 Fluorine 143
 Fluorine nitrate 187
 hexaFluoroaluminate, ammonium 226
 tetraFluoroaluminate, ammonium 227
 tetraFluoroberyllate, ammonium 232
 Fluoroborate, nitrosyl 224
 potassium 223
 potassium hydroxy- 223
 sodium 222
 Fluorochromate, potassium 1390
 Fluoroboric acid 221
 Fluoroboric acid, dihydroxy- 784
 tetraFluorobromate (III), potassium 237
 Fluoroform 204
 Fluoroformyl fluoride 206
 hexaFluorogallate, ammonium 228
 -germanate, potassium 216
 -indate, ammonium 229
 heptaFluorocobaltate (IV), potassium 269
 hexaFluoroiodate (V), potassium 238
 triFluoroiodomethane 205
 hexaFluoromanganate (IV), potassium 264
 triFluoromethane 204
 hexaFluoronickelate (IV), potassium 269
 heptaFluoroniobate (V), potassium 255
 diFluorophosphate (V), ammonium 196
 hexaFluorophosphate (V), ammonium 195
 tetrachlorophosphonium 193
 potassium 196
 triFluorosilane 214
 tetraFluorosilane 212
 Fluorosilicate, zinc 1090
 Fluorosilicic acid 214
 hexaFluorosilicic acid 214
 Fluorosulfinate, potassium 178
 Fluorosulfonic acid 177
 heptaFluorotantalate, potassium 256
 pentaFluorothorate, potassium 1177
 hexaFluorotitanate, potassium 1163
 sodium 1163
 Fluosilicic acid 214
 Formyl nitrile 658
 Free alkali metals 956
 Fremys salt 504

G

Gadolinite, treatment of 1129
 diGallane 840
 tetramethyl 840
 Gallate, ammonium hexafluoro- 228
 lithium tetrahydro- 842
 Gallium 837
 dissolving in acids 839
 electrolytic separation of 837
 Gallium alum, ammonium 854
 antimonide 857
 arsenide 857
 azide 476
 (II) bromide 847
 (III) bromide 845
 (II) chloride 846
 (III) chloride 843
 (III) fluoride 227
 hydroxide 847
 metahydroxide 847
 (III) iodide 846
 trimethyl- 840
 nitrate 856
 nitride 855
 (I) oxide 849
 (III) oxide 848
 (III) perchlorate 839
 phosphide 857
 selenide 854
 (III) sulfate, ammonium 854
 (I) sulfide 852
 (II) sulfide 851
 (III) sulfide 850
 telluride 855
 Gel, aluminum hydroxide 1652
 hydrated chromium oxide 1648
 hydrated oxide 1646
 silica 1648
 Germanate, potassium hexafluoro- 216
 Germane, trichloro- 721
 tetraethoxy- 725
 Germanide, calcium 948
 cesium 989
 magnesium 922
 potassium 989
 rubidium 989
 sodium 989
 Germanium 706
 metallic 712
 Germanium tetraacetate 726
 (IV) bromide 718
 (IV) chloride 715
 dichloride 716
 tetrafluoride 215
 hydrides 713
 (IV) iodide 719
 diiodide 720
 triiodide, methyl- 722
 nitride 722
 (II) oxide 711

pp 1-992: Vol. 1; pp 1003-1810: Vol. 2

- Germanium (IV) oxide 706
 purification of 709
 via acid decomposition 706
 via alkaline decomposition 708
disulfide 723
monosulfide 724
 Glycinate, chromium 1382
 Gold, very pure 1052
 colloidal 1053
 from residues 1054
 (I) acetylide 1063
 (I) chloride 1055
 (III) chloride 1056
 monochloride 1055
trichloride 1056
trichloride acid 1057
 (I) cyanide 933
 (III) hydroxide 1060
 (III) oxide 1059
sesquioxide 1059
trioxide 1059
 (I) sulfide 1061
 (II) sulfide 1062
 (III) sulfide 1063
 Gold potassium cyanide 1065
 See also aurous, auric, etc.
 Graham's salt 550
 Graphite, alkali compounds 635
 See also carbon
 Graphite, alkali ammine compounds 637
 aluminum chloride 644
 bisulfate 642
 bromine 643
 cesium 635
 fluoride 640
 foils and films 632
 iron (III) chloride 644
 metal halides 644
 nitrate 643
 oxide 638
 oxide black 631
 oxyhydroxide 638
 perchlorate 643
 potassium 637
 rubidium 637
 salts 642
 sodium 637
 Graphitic acid 638

H

- Hafnium 1172
 separation from zirconium 1179
 (IV) bromide 1203
 carbide 1245
 (IV) chloride 1203
 nitride 1233, 1236
 (IV) oxide 1221
 oxychloride 1213
 phosphate 1244
 Halides, poly- 293
 Heavy hydrogen and compounds—see Deuterium
 Heteropoly acids 1698
 Heteropoly compounds 1699, 1716
 Hittorf's phosphorus 520
 Hopkalite (Hopcalite) 1674
 Hydrargillite 820
 Hydrate, bromine 276
 chlorine 274
 diHydrate, boron trifluoride 784
 octaHydrates of alkaline earth metal peroxides 937
 Hydrated chromium oxide gel 1648
 Hydrated oxide gels 1646
 Hydrazine 469
 hydrate 469
disulfonate, potassium 509
 Hydrazinium sulfate 468
 Hydrazoic acid 472
 Hydrides—see parent metal
 Hydrochloroauric acid 1057
 Hydrocyanic acid 658
 Hydrogen 111
 aluminum chloride 815
 bromide 282
 chloride 280
tetrachloroaurate (III) 1057
hexacyanocobaltate (III) 1542
hexacyanoferrate (II) 1509
 (III) 1510
 deuteride 126
 fluoride 145
 fluoride, ammonium 183
 potassium 237
 diHydrogen hypophosphate, disodium 560
 diHydrogen hypophosphate, barium 562
 Hydrogen iodide 286
 peroxide 140
 diHydrogen phosphate, sodium 544
 Hydrogen phosphide (gaseous) 525
 diHydrogen phosphide, sodium 530
 Hydrogen selenide 418
 selenide, sodium 419
disulfatovanadate (III) 1282
 sulfide, ammonium 357
 sulfide, sodium 357
 tetraHydrogentellurate, sodium 453
 Hydrogen telluride 438
 thiocyanate 669
 Hydroxides—see parent metal
 diHydroxohexaacetatotrichromium (III) acetate 1371
 chloride 1371
 hexaHydroxochromate (III), sodium 1688
 tetraHydroxocuprate (II), sodium 1684
 hexaHydroxocuprate (II), barium 1685
 Hydroxoferrates (III), barium 1690
 sodium 1689
 tetraHydroxoferrate (II), sodium 1686
 tetraHydroxomagnesate, sodium 1683
 hexaHydroxonickelate (II), strontium 1686
 hexaHydroxoplumbate, sodium 1694

pp 1-992: Vol. 1; pp 1003-1810: Vol. 2

- Hydroxo salts 1677
 triHydroxostannate (II), sodium 1687
 hexaHydroxostannate (IV), sodium 1694
 Hydroxozincates, sodium 1681
 Hydroxyapatite 545
 Hydroxyfluoroborate, potassium 223
 diHydroxyfluoroboric acid 784
 Hydroxylamine 501
 disulfonate, potassium 503
 isomonsulfonic acid 510
 Hydroxylammonium arsenate 501
 chloride 498, 500
 oxalate 501
 phosphate 500
 hexaHydroxyplatinate (IV) 1575
 Hypersulfuric acid 388, 389
 Hypobromite, potassium 311
 sodium 310
 Hypochlorite, sodium 309
 Hypochlorous acid 308
 Hyponitrate—see parent cation
 Hyponitrite—see parent cation
 Hyponitrous acid 492
 Hypophosphate, di-sodium dihydrogen 560
 tetrasodium 561
 Hypophosphite, barium 557
 barium dihydrogen 557
 Hypophosphoric acid 558
 Hypophosphorous acid 555
- |
- Imide, lithium 464
 heptasulfur 411
 thionyl 480
 Imidophosphate, tetrasodium 589
 Imidosulfonate, potassium 506
 potassium chloro- 508
 Indate, ammonium hexafluoro- 229
 Indium 857
 electrolytic refining of 858
 prerrefining of crude 857
 antimonide 867
 arsenide 867
 (I) bromide 862
 (II) bromide 861
 (III) bromide 859
 (I) chloride 862
 (II) chloride 861
 (III) chloride 858
 (III) fluoride 228
 hydroxide 862
 (I) iodide 862
 (II) iodide 861
 (III) iodide 860
 nitride 866
 (I) oxide 863
 (III) oxide 863
 phosphide 867
 selenides 865
 sulfides 864
 tellurides 865
 Intermetallic compounds 1771
 Iodate, iodine (III) 331
 Iodic acid 316
 tetracloro- 299
 Iodine 277
 recovery from laboratory waste solutions 278
 Iodine monobromide 291
 monochloride 290
 trichloride 292
 pentafluoride 159
 heptafluoride 160
 (III) iodate 331
 (III) nitrate 329
 (III) perchlorate 330
 (III) sulfate 329
 Iodine (I) perchlorate, dipyridine- 327
 diiodine tetroxide 333
 pentoxide 307
 Iodine (III) sulfate, oxo- 332
 Iodo fluorophosgene 211
 Iodohydrargyrate, potassium 1110
 Iodoplumbite, potassium 754
 trilodomercurate (II), potassium 1110
 tetralodomercurate (II), copper (I) 1110
 silver 1110
 Iridate (IV), ammonium hexachloro- 1594
 (III), potassium hexachloro- 1595
 (IV), potassium hexachloro- 1593
 Iridium, pure 1590
 (IV) acid, hexachloro- 1593
 (III) chloride 1592
 (IV) chloride, ammonium 1594
 (III) chloride, potassium 1595
 (VI) fluoride 270
 (IV) oxide 1590
 (III) oxide, hydrated 1592
 (IV) oxide, hydrated 1591
 Iron, metallic 1490
 carbonyl 1636
 Iron (III) acetate, basic 1508
 triIron (III) hexaacetatodihydroxomono-
 acetate 1508
 Iron (II) bromide 1493
 (III) bromide 1494
 carbide 1503
 tetracarbonyl 1745
 pentacarbonyl 1743
 carbonyl, ethylenediamine 756
 tetracarbonyl halides 1751
 dihydride 1752
 carbonyl mercury 1755
 carbonyl, pyridine 1758
 (II) chloride 1491
 (III) chloride 1492
 (III) chloride graphite 644
 (II) fluoride 266
 (III) fluoride 266
 (II) hydroxide 1498

pp 1-992: Vol. 1; pp 1003-1810: Vol. 2

- Iron (III) hydroxide 1499
 (II) iodide 1495
 nitrides 1502
 dinitrosyl dicarbonyl 1760
 dinitrosyl halides 1762
 (II) oxide 1497
 (III) oxide, α - 1661
 (II, III) oxide 1499
 (III) oxide, "glimmering" hydrated 1654
 (III) oxychloride 1501
 (III) sulfate, basic 1507
 (II) sulfide 1502
 (III) sulfide, potassium 1507
 (III) thiocyanate, sodium 1511
 dilron enneacarbonyl 1744
nonacarbonyl 1744
 trilron dodecacarbonyl 1745
 Isocyanate, silicon 702
 Isopoly compounds 1702
 arsenates 1709
 chromates 1709
 molybdates 1710
 niobates 1705
 sulfates 1714
 tantalates 1707
 tungstates 1712
 vanadates 1702
- K
- Kernite, synthetic 794
 Kurrol's sodium polyphosphate 551
- L
- Lanthanum metal, powder 1141
 solid 1144
 Lanthanum tribromide 1148
trichloride 1146
 cyclopentadienides 1159
 fluoride 246
 hydroxide 1152
triiodides 1149
 nitrate 1158
 nitride 1157
nonaselenide 1155
 selenides 1154
 sulfate 1156
monosulfide 1155
 sulfide 1153
monotelluride 1155
 Lead 748
 purest form 748
 See also plumbate, plumbous, etc.
 Lead (IV) acetate 767
tetraacetate 767
 amalgam 1806
 azide 763
- Lead carbonate 766
 Lead chamber crystals 406
 Lead (IV) chloride 750
tetrachloride 750
tetraethyl- 765
 (II) fluoride 218
 (IV) fluoride 219
tetramethyl- 763
 (II, IV) oxide 755
 (IV) oxide 757, 1668
dioxide 757
 "superoxide" 757
 red 755
metasilicate 705
 (IV) sulfate 761
disulfate 761
 sulfide 760
 thiocyanate 769
 Lepidolite 950
 Lindemann glass 796
 Lithium 956
 aluminum cyanide 833
 aluminum hydride 805
 aluminum nitride 828
 aluminum phosphide 830
 amide 463
 antimonide 985
 arsenide 985
 azide 475
 beryllium borate 796
 bismuthide 985
 borohydride 775
 carbide 987
 carbonate 950, 987
 chromate 958
 ferrate (III) 1504
 fluoride 235
 hydride 971
 tetrahydrogallate 842
 hydroxide 982
 imide 464
 nitride 984
 oxide 974
 peroxide 979
 trilithium hexaphenylchromate (III) 1375
 Lithium phosphide 985
metasilicate 705
 silicide 991
 Lustrous carbon 632
 Luteochromic chloride 1351
 nitrate 1351
 Luteocobalt chloride 1531
 Luteophosphomolybdic acid 1732
 Luteophosphotungstic acid 1724
- M
- Madrell's salt, sodium polyphosphate 549
 Magnesate, sodium tetrahydroxo- 1683
 Magnesium 903

pp 1-992: Vol. 1; pp 1003-1810: Vol. 2

- Magnesium arsenide 917
 azide 917
 bromide 909
 carbides 920
 carbonate 232
 chloride 905
 fluoride 232
 germanide 922
 hydride 905
 hydroxide 912
 iodide 910
 -nickel mixed oxalate catalyst 1615
 nitride 912
 oxide 911, 1663
 perchlorate 320
 phosphide 917
 selenide 915
 silicide 921
 sulfide 913
 telluride 915
 Magnus's salt 1577
 Malachite 1025
 Manganate (VII), barium 1462
 (VI), potassium 1461
 (IV), potassium hexachloro- 1464
 (I), potassium hexacyano- 1472
 (II), potassium hexacyano- 1473
 (III), potassium hexacyano- 1474
 (IV), potassium hexafluoro- 264
 potassium nitrosyl cyano- 1767
 (III), potassium trioxalato- 1470
 (IV), potassium dioxalatodihydroxy- 1471
 (VII), silver 1463
 (V), sodium 1460
 Manganese 1454
 (III) acetate 1469
 cesium alum 1468
 (III) chloride, potassium 1464
 (II) cyanide 1473
 (III) cyanide 1474
 (II) fluoride 262
 (III) fluoride 263
hexafluoride 264
 (II) hydroxide 1456
 nitride 1468
 (II) oxide 1455
 (III) oxide 1457
 (IV) oxide 1458
 (VII) oxide 1459
dioxide 1458
 heptoxide 1459
 (III) sulfate 1467
 (III) sulfate, cesium 1468
 (II) sulfide 1465
 Mercurate (II), copper (I) tetraiodo- 1110
 (II), potassium tetracyano- 1122
 (II), potassium triiodo- 1110
 (II), potassium tetrathiocyno- 1124
 (II), silver tetraiodo- 1111
 Mercuric acetate 1120
 Mercuric cyanide 1121
 iminobromide 1115
 oxychloride 1108
 selenide 1113
 sulfide, black 1111
 sulfocyanate 1123
 thiocyanate 1123
 thionitrosylate 1118
 Mercuric precipitate (infusible), white 1114
 (fusible), white 1114
 Mercurous acetate 1120
 thiocyanate 1122
 thionitrosylate 1117
 Mercury 27
 (I) acetate 1120
 (II) acetate 1120
 (II) amide chloride 1114
 (II) bromide 1109
 (II) dichloride, diammine- 1114
 cobalt carbonyl 1755
 cyanide 1121
 diethyl- 1118
 (I) fluoride 243
 (II) fluoride 244
 (II) iminobromide 1115
 iron carbonyl 1755
 (II) oxychloride 1108
 potassium iodide 1110
 (I) rhodanide 1122
 (II) selenide 1113
 (II) sulfide 1111
 (I) thiocyanate 1122
 (II) thiocyanate 1123
 (I) thionitrosylate 1117
 (II) thionitrosylate 1118
 Methoxide, aluminum 833
 boron 797
 tetraMethoxysilane 702
 triMethylboroxine 800
 diMethyldichlorosilane 694
 tetraMethyldigallane 840
 triMethylgallium 840
 Methylgermanium triiodide 722
 Millon's base 1116
 bromide of 1117
 Molybdate (VI), tetraamminezinc tetrapero-
oxo- 1414
 (V), ammonium oxopentachloro- 1413
 ammonium tetrathio- 1416
 (III), potassium hexachloro- 1408
 (IV), potassium octacyano- 1416
 potassium hydrogen diperoxo mono- 1414
 potassium nitrosyl cyano- 1766
 Molybdates, isopoly 1710
 ammonium 1711
 sodium 1710, 1712
 Molybdenum 1401
 Molybdenum (0), dibenzene- 1402
 Molybdenum blue 1411

pp 1-992: Vol. 1; pp 1003-1810: Vol. 2

Molybdenum (III) bromide 1407
tribromotripyridine- 1408
 carbonyl 1741
 (II) chloride 1403
 (III) chloride 1404
 (IV) chloride 1405
 (VI) fluoride 259
 hydroxides, lower 1411
 γ -oxide 1410
 (IV) oxide 1409
 (VI) oxide 1412
trioxide 1412
 (IV) sulfide 1415
 disulfide 1415
 Molybdic acid 1412
 6-Molybdic acid-2-arsenates 1736
 12-Molybdic acid-1-arsenates 1734
 18-Molybdic acid-2-arsenates 1734
 12-Molybdic acid-2-chromites 1737
 6-Molybdic acid-1-periodates 1738
 12-Molybdic acid-1-phosphates 1730
 18-Molybdic acid-2-phosphates 1732
 12-Molybdic acid-1-silicates 1729
 Molybdic anhydride 1412
 Monazite sand, extraction of 1127
 Mosaic gold 741

N

Neodymium monochalcogenides 1155
 compounds from cerium earths 1131
 Nickel 1543
 (II) amide 1554
 (II) bromide 1545
 carbide 1556
 (II) carbonate 1556
 carbonyl 1747
dicarbonyl o-phenanthroline 1750
 (II) chloride 1544
 (II) chloride, hexamine- 1545
 (II) cyanide hydrate, potassium 1559
 (II) fluoride 269
 formate-paraffin catalyst 1631
 (II) hydroxide 1549
 (II, III) hydroxide 1551
 (III) hydroxide 1551
 β - 1549
 γ - 1550
 (II) iodide 1547
 -magnesium mixed oxalate catalyst 1615
 triNickel nitride 1555
 dinitride 1555
 Nickel (II) oxide 1548
 (II) sulfide 1551
 (IV) sulfide 1554
 diNickel (IV), di- μ -sulfido-tetrakis (dithio-
 benzoato)- 1558
 Nickel (II) thiocyanate 1558
 Nickelate (II), potassium tetracyano- 1559
 (IV), potassium hexafluoro- 269

Nickelate (II), strontium hexahydroxo 1686

Niobates, alkali 1323
 isopoly 1705
 Niobate, potassium 1323
 (V), potassium heptafluoro- 255
 potassium peroxy- 1325
 sodium 1323
 Niobic acid, peroxy- 1324
 Niobium 1292
 (III) bromide 1309
 (V) bromide 1311
 carbides 1331
 (II) chloride 1296
 (III) chloride 1297
 (IV) chloride 1299
 (V) chlorides 1302
 deuteride 1296
 (V) fluoride 254
heptafluoride, potassium 255
 hydride 1295
 (II) iodide 1314
 (III) iodide 1314
 (IV) iodide 1314
 (V) iodide 1315
 nitrides 1328
 (II) oxide 1317
 (IV) oxide 1318
 (V) oxide 1318
 oxytribromide 1313
 oxytrichloride 1307
 phosphides 1330
 sulfides 1327
 Nitramide 496
 Nitrates—see under parent cation
 Nitrates, hypo—see hyponitrates
 Nitric acid 491
 anhydrous 491
 Nitric oxide 485
 Nitride tetrahydride, sulfur 411
 pentaNitride, triphosphorus 574
 diNitride, disulfur 409
 tetrasulfur 408
 tetraNitride, tetrasulfur 406
 Nitrides—see parent metal
 Nitriulosulfonate, potassium 506
 Nitrite, bismuth oxide 626
 Nitrites, hypo—see Hyponitrates
 Nitritopentaamine cobalt (III) chloride 1535
 hexaNitritocobaltate (III), sodium 1541
 hexaNitritorhodate (III), ammonium 1586
 Nitropentaamminecobalt (III) chloride 1534
 cis-diNitrodiammineplatinum (II) 1579
 Nitrocarbamate, potassium 496
 Nitrogen 457
 from azides 457
 purification of commercial 458
 tribromide 480
 trichloride 479

pp 1-992: Vol. 1; pp 1003-1810: Vol. 2

- diPeroxomonomolybdate, potassium hydro-
gen 1414
- Peroxyoniobate, potassium 1325
-niobic acid 1324
-diphosphate, potassium 562
-disulfate, ammonium 390
-disulfate, potassium 392
-monosulfuric acid 388
-disulfuric acid 389
-tantalate, potassium 1325
-tantalic acid 1324
-titanic acid 1219
- Perrhenate, ammonium 1484
barium 1485
mesoPerrhenate, barium 1487
Perruthenate, potassium 1600
Persulfuric acid 389
Persulfate, ammonium 390
potassium 392
- Peyrone's chloride 1578
- o-Phenanthroline nickel dicarbonyl 1750
silver (II) persulfate 1050
- tetraPhenylborate, sodium 803
- Phosgene 650
- orthoPhosphate, aluminum 831
- Phosphate, ammonium difluoro- 196
ammonium hexafluoro- 195
barium dithio- 571
bismuth (II) 626
boron 796
potassium 545
- trimetaPhosphate, sodium 552
- tetrametaPhosphate, sodium 553
- triPhosphate, pentasodium 547
- tetraPhosphate, hexasodium 548
- Phosphate, sodium dihydrogen 544
sodium monothio- 569
sodium dithio- 570
sodium trithio- 571
sodium tetrathio- 572
- polyPhosphates, sodium 549
Graham's salt 550
Kurrul's sodium polyphosphate 551
Madrell's salt 549
- 1-Phosphates, 12-molybdic acid- 1730
2-Phosphate, 18-molybdic acid- 1732
1-Phosphate, 12-tungstic acid- 1720
2-Phosphate, 18-tungstic acid- 1723
21-tungstic acid- 1722
22-tungstic acid- 1722
24-vanadic acid- 1739
48-vanadic acid- 1739
- Phosphides—see parent element
- Phosphine 525
- diPhosphine 525
- Phosphomolybdic acid, luteo- 1732
- Phosphonitrilic bromides 578
chlorides 575
fluoride 194
- Phosphonium iodide 529, 531
- Phosphoric acid 543
- diPhosphoric acid 546
orthoPhosphoric acid 543
pyroPhosphoric acid 546
Phosphoric acid, monoamido- 579
diamido 582
- diPhosphoric acid tetrachloride 536
- Phosphoric acid, deutero- 138
orthoPhosphorous acid 544
- Phosphorus, black 522
bright red 519, 521
colloidal 524
Hittorf's 520
red 519
white 518
dichloride fluoride 191
dichloride trifluoride 192
(III) fluoride 189
(V) fluoride 190
(III) iodide 540
diiodide 539
- diPhosphorus tetraiodide 539
- triPhosphorus pentanitride 574
- Phosphorus (V) oxide 541
oxide trifluoride 193
- tetraPhosphorus decaoxide 541
triselenide 573
- Phosphorus trisulfide 563
pentasulfide 565
heptasulfide 566
- diPhosphorus pentasulfide 567
- Phosphorus sulfochloride 532
- Phosphoryl triamide 584
(V) bromide 534
- pyroPhosphoryl tetramide 588
chloride 536
- Phosphotungstic acid, luteo- 1724
- Pink salt 731
- Platinate (IV), ammonium hexachloro- 1570
(II), barium tetracyano- 1576
(II), potassium tetrachloro- 1572
(IV), potassium hexachloro- 1571
(II), potassium tetracyano- 1576
(IV), potassium hexahydroxy- 1575
(IV), sodium hexachloro- 1571
(IV), sodium hexahydroxy- 1575
- Platinic (II) acid, tetrachloro- 1570
(IV) acid, hexachloro- 1569
- Platinichloride, ammonium 1570
potassium 1571
sodium 1571
- Platinic chloride 1569
salammoniac 1570
- Platinized asbestos 1563
- Platinocyanide, barium 1576
potassium 1576
- Platinum, pure 1560
reclaimed 1561
- Platinum amines 1577
Magnus's salt 1577
Reiset's first chloride 1577
second chloride 1578

pp 1-992: Vol. 1; pp 1003-1810: Vol. 2

- Platinum amines, Peyrone's chloride 1578
- cis-dinitrodiammine platinum (II) 1579
- Platinum black 1562
- chlorides 1567
- (II) chloride, diammine- 1578
- (II) chloride, tetraammine- 1577
- electroplating 1565
- (II), cis-dinitrodiammine- 1579
- (II) oxide 1573
- (IV) oxide 1574
- sponge 1562
- (II) sulfide 1575
- (IV) sulfide 1576
- Plumbate, ammonium hexachloro- 751
- orthoPlumbate, calcium 760
- Plumbate, potassium hexachloro- 753
- metaPlumbate, sodium 758
- orthoPlumbate, sodium 759
- Plumbate, plumbous 755
- (IV), sodium hexahydroxo- 1694
- Plumbic acetate 767
- chloride 750
- chloride, ammonium 751
- chloride, potassium 753
- sulfate 761
- Plumbite, potassium iodo- 754
- Plumbous plumbate 755
- Potassium 958
- amide 1043
- amidosulfinate 507
- antimonide 986
- arsenide 986
- aurate 1061
- azide 475
- azodi-sulfonate 510
- bismuthate 628
- bismuthide 986
- dibromiodide 296
- cadmium chloride 1095
- cyanide 1106
- carbonate 987
- chloroimidisulfonate 508
- dichloriodide 295
- tetrachloriodide 298
- pentachloromonoaquochromate (III) 1334
- pentachloroaquothallate (III) 874
- tetrachloroaurate (III) 1058
- chlorochromate 1390
- hexachloroiridate (III) 1595
- (IV) 1593
- hexachloromanganate (IV) 1464
- hexachloromolybdate (III) 1408
- tetrachloropalladate (II) 1584
- hexachloropalladate (IV) 1584
- tetrachloroplatinate (II) 1572
- hexachloroplatinate (IV) 1571
- hexachloroplumbate 753
- hexachlororhodate (III) 1588
- hexachloroselenate 425
- hexachlorostannate 731
- Potassium hexachlorotellurate 444
- hexachlorothallate (III) 873
- enneachloroditungstate (III) 1427
- nonachloroditungstate (III) 1427
- trichromate 1709
- tetrachromate 1710
- chromium oxalate 1372
- thiocyanate 1374
- cobalt (III) hexacyanide 1541
- cuprate (III) 1014
- dicyanoaurate (I) 1065
- tetracyanocadmiate 1106
- hexacyanochromate (III) 1373
- cobaltate (III) 1541
- manganate (I) 1472
- (II) 1473
- (III) 1474
- tetracyanomercurate (II) 1122
- octacyanomolybdate (IV) 1416
- tetracyanonickelate (II) 1559
- platinate (II) 1576
- octacyanotungstate (IV) 1429
- (V) 1429
- tetracyanozincate 1088
- ferrate (VI) 1504
- fluoride 236
- bifluoride 237
- fluoroborate 222
- tetrafluorobromate (III) 237
- fluorochromate 1390
- hexafluorochromate (IV) 269
- cuprate (III) 269
- ferrate 269
- germanate 216
- iodate (V) 238
- manganate (IV) 264
- nickelate (IV) 269
- heptafluoroniobate (V) 255
- hexafluorophosphate (V) 196
- fluorosulfinate 178
- heptafluorotantalate (V) 256
- pentafluorothorate 1177
- hexafluorotitanate 1163
- vanadate 270
- germanide 989
- hydrazinedisulfonate 509
- hydride 971
- dihydrogen arsenide 595
- hydrogen fluoride 237
- diperoxomonomolybdate 1414
- hydroxide 525, 529
- hydroxyfluoroborate 223
- hydroxylamine disulfonate 503
- hexahydroxyplatinate 1575
- hypobromite 311
- imidisulfonate 506
- iodide 290
- triiodide 294
- iodohydrargyrate 1110
- triiodomercurate (II) 1110
- iodoplumbite 754

pp 1-992: Vol. 1; pp 1003-1810: Vol. 2

Nitrogen trifluoride 181
triiodide 480
dioxide 488
trioxide 487
pentoxide 489
oxyfluoride 184
diNitrososulfide, potassium 504
Nitrosodisulfonate, potassium 504
Nitrososulfuryl fluoride 186
Nitrosyl compounds 1741
Nitrosyl bromide 513
chloride 511
chloroantimonate (V) 612
diNitrosyl cobalt halides 1761
Nitrosyl cyanoferrate, sodium 1768
cyanomanganate, potassium 1767
cyanomolybdate, potassium 1766
fluoride 184
fluoroborate 224
hydrogen sulfate 406
perchlorate 320
sodium 514
sulfuric acid 406
heptaNitrosyltrithiotetraferrate, ammonium 1764
diNitrosyl thioferrate, ethyl 1765
thioferrate, sodium 1763
thiosulfatocobaltite, potassium 1766
thiosulfatoferrate, potassium 1766
thiosulfatonickelate, potassium 1766
Nitrous oxide 484
Nitroxylate, sodium 515
Nitryl chloride 513
fluoride 186
perchlorate 321
Noble gases 82

O

Osmate (IV), ammonium hexachloro- 1603
(VI), potassium 1604
(IV), sodium hexachloro- 1602
Orthophosphates, condensed 546
Osmiamate, potassium 1605
Osmium 1601
(IV) chloride 1601
(IV) oxide 1603
(VIII) oxide 1603
triOxalatochromate (III), potassium 1372
-dihydroxymanganate (IV), potassium 1471
-manganate (III), potassium 1470
tetraOxalatouranate (IV), potassium 1450
Oxalic acid dinitrite 660
Oxide—see parent element
Oxide chloride, antimony (III) 611
chloride, bismuth 622
Oxides in gases 1669
Oxohydroxostannate (II), barium 1696
Oxygen difluoride 163

diOxygen difluoride 162
Oxyhydride, silicon 699
Ozone 337

P

Palladate (II), ammonium tetrachloro- 1584
(IV), ammonium hexachloro- 1584
(II), potassium tetrachloro- 1584
(IV), potassium hexachloro- 1584
(II), sodium tetrachloro- 1584
Palladium, pure 1580
colloidal 1581
black 1581
Palladium (II) tetraamminetetrabromopal-l_{adate} (II) 1585
(II) tetraamminetetrachloropalladate (II)
(II) bromide, diammine- 1585
(II) chloride 1582
chloride for detection of CO 1582
(II) chloride, diammine- 1585
(IV) chloride, ammonium 1584
(IV) chloride, potassium 1584
(II) oxide 1583
Palladized asbestos 1582
Palladochloride, ammonium 1584
potassium 1584
sodium 1584
Paris green 1027
Perborate, sodium 795
Perchlorate, alkaline earth 320
gallium (III) 839
graphite 643
iodine (III) 330
nitrosyl 320
nitryl 321
dipyridineiodine (I) 327
Perchloric acid 318
Periodate, barium 326
potassium 325
sodium 323
1-Periodates, 6-molybdic acid- 1738
Periodic acid 322
Permanganate, barium 1462
silver 1463
Permanganic acid anhydride 1459
Peroxide, barium 936
calcium 936
hydrogen 140
lithium 979
sodium 980
strontium 936
polysulfur 382
diPeroxotriamminechromium (IV) 1392
pentaPeroxodichromate, ammonium 1392
tetraPeroxochromate (V), potassium 1391
tetraPeroxomolybdate (VI), tetraammine-zinc 1414

pp 1-992: Vol. 1; pp 1003-1810: Vol. 2

- Potassium imidosulfonate 506
 iridium (III) chloride 1595
 iron (III) sulfide 1507
 lead (IV) chloride 753
 (II) iodide 754
 manganate (VI) 1461
 manganese (III) chloride 1464
 (II) cyanide 1473
 (III) cyanide 1474
 hexafluoride 264
 mercuricyanide 1122
 -iodide 1110
 -thiocyanate 1124
 nickel (II) cyanide hydrate 1559
 niobate 1323
 niobium heptafluoride 255
 nitrilosulfonate 506
 nitrocarbamate 496
 dinitrosulfite 504
 nitrosodisulfonate 504
 nitrosyl tricarbonyl ferrate 1759
 cyanomanganate 1767
 cyanomolybdate 1766
 dinitrosyl thiosulfatocobaltate 1766
 thiosulfatoferrate 1766
 thiosulfatonickelate 1766
 osmate (VI) 1604
 osmiumate 1605
 trioxalatochromate (III) 1372
 dioxalato-dihydroxymanganate (IV) 1471
 trioxalatomanganate (III) 1470
 tetraoxalatoauramate (IV) 1470
 monooxohydroxoaluminate 1693
 oxide 977
 dioxide 981
 palladium (IV) chloride 1584
 palladochloride 1584
 periodate 325
 permanganate-barium sulfate solid
 solution 1463
 tetraperoxochromate (V) 1391
 peroxy niobate 1325
 -diphosphate 562
 -disulfate 392
 -tantalate 1325
 perruthenate 1600
 persulfate 392
 phosphate 545
 phosphide 986
 platinumchloride 1571
 platinocyanide 1576
 plumbic chloride 753
 plumbous iodide 754
 rhenium (IV) chloride 1478
 ruthenate 1600
 selenide 421
 silicide 989
 -sodium alloy 1808
 diPotassium disulfane 363
 trisulfane 364
 tetrasulfane 366
 diPotassium pentasulfane 367
 hexasulfane 368
 Potassium trisulfate 1714
 disulfatovanadate (III) 1283
 sulfide 360
 disulfide 363
 trisulfide 364
 tetrasulfide 366
 pentasulfide 367
 hexasulfide 368
 tantalum heptafluoride 256
 telluride 441
 hexathiocyanatochromate (II) 1374
 tetrathiocyanatodipyridinochromate (III)
 1379
 hexathiocyanatovanadate (III) 1291
 tetrathiocyanomercurate (II) 1124
 trithionate 398
 tetrathionate 399
 pentathionate 401
 hexathionate 403
 vanadium (III) alum 1284
 zinc cyanide 1088
 Praseodymium compounds from cerium
 earths 1131
 monochalcogenides 1155
 (IV) oxide 1155
 Primary zinc oxymethanesulfinate 1076
 Prussic acid 658
 Purpureochromic chloride 1352
 diPyridine chromium tetracarbonyl 1749
 triPyridine chromium tricarbonyl 1749
 diPyridine iodine (I) perchlorate 327
 Pyridine iron carbonyl 1758
 hexaPyridine iron (II) tridecacarbonyl tetra-
 ferrate (II) 1758
 Tris(2,2'-dipyridyl)chromium (0) 1363
 (I) perchlorate 1362
 (II) perchlorate 1361
 Bis- α,α' -dipyridylsilver nitrate 1051
 (II) persulfate 1051
 Tris- α,α' -dipyridylsilver (II) perchlorate
 1050
 nitrate 1051

R

- Raney nickel 1625
 Rare earths, metallic 1141
 Rare earth amalgams 1807
 tribromides 1148
 monochalcogenides 1155
 trichlorides 1146
 cyclopentadienides 1159
 dihalides 1150
 hydroxides 1152
 triiodides 1149
 nitrates 1158
 nitrides 1157
 sulfates 1156

pp 1-992: Vol. 1; pp 1003-1810: Vol. 2

Reinecke acid 1377
 salt 1376
 Reiser's first chloride 1577
 second chloride 1578
 Rhenate (VI), barium 1485
 sodium 1483
 Rhenite, sodium 1483
 Rhenium metal 1476
 residues, workup of 1488
 Rhenium (III) chloride 1476
 (V) chloride 1477
 (IV) chloride, potassium 1478
 (VI) fluoride 264
 (IV) oxide 1480
 (VI) oxide 1481
 (VII) oxide 1482
 (VI) oxychloride 1479
 (VII) oxychloride 1480
 (IV) sulfide 1486
 (VII) sulfide 1487
 Rhodanilate, ammonium 1378
 Rhodanilic acid, ammonium salt of 1378
 Rhodate (III), ammonium hexachloro- 1588
 (III), ammonium pentachloro- 1588
 (III), potassium hexachloro- 1588
 (III), potassium pentachloro- 1588
 (III), sodium hexachloro- 1587
 Rhodium 1585
 (III) chloride 1587
 (III) chloride, chloropentaammine- 1585,
 1590
 hydroxide 1588
 (III) nitrate, chloropentaammine- 1586,
 1590
 (III) oxide 1588
 sulfate 1589
 Rhodochromium chloride 1359
 Rinmann's green 1092
 Roseocobalt oxalate 1533
 Roussin's black ammonium salt 1764
 red sodium salt 1763
 Rubidium 957
 azide 475
hexabromothallate (III) 876
 carbonate 987
 chloride 951, 961
 hexachloroselenate 425
hexachlorotellurate 444
 chromate 1388
dichromate 1388
 germanide 989
 graphite 637
 hydride 971
 hydroxide 983
 oxide 977
 dioxide 981
 silicide 989
 vanadium (III) alum 1284
 Ruthenate (IV), ammonium hexachloro-
 1599
 potassium 1600

Ruthenium 1595
 (III) chloride 1597
 (IV) chloride, ammonium 1599
 (IV) hydroxychloride 1597
 (IV) oxide 1599
 (VIII) oxide 1599

S

Samarium, pure compounds of 1135
 purification of 1140
 solid metal 1143
 dibromide 1150
tribromide 1148
dichloride 1150
trichloride 1146
diiodide 1150
triiodide 1149
 Scandium compounds, pure 1125
 fluoride 245
 Schlippe's salt 619
 Schweizer's reagent 1016
 Selenate, ammonium hexachloro- 425
 cesium hexachloro- 425
 potassium hexachloro- 425
 rubidium hexachloro- 425
 sodium 433
 thallium hexachloro- 425
 Selenic acid 432
 Selenide, aluminum 825
 barium 939
 beryllium 897
 calcium 939
 diSelenide, carbon 656
 Selenide, gallium 854
 hydrogen 418
 indium 865
 magnesium 915
 triSelenide, tetraphosphorus 573
 Selenide, potassium 421
 sodium 421
 sodium hydrogen 419
 diSelenide, sodium 421
 Selenide, strontium 939
 Selenite, sodium 431
 Selenium, pure 415
 amorphous 416
 amorphous vitreous 416
 colloidal 417
 hexagonal 417
 monoclinic α - and β - 416
 Selenium monobromide 426
 diSelenium dibromide 426
 Selenium tetrabromide 427
 monochloride 422
 diSelenium dichloride 422
 Selenium tetrachloride 423
 tetrafluoride 180
 hexafluoride 179
 nitride 435

pp 1-992: Vol. 1; pp 1003-1810: Vol. 2

- Selenium dioxide 428
 oxychloride 429
 sulfur trioxide 435
 Selenopentathionate, sodium 434
 Selenous acid (anhydrous) 430
 bromide 426
 chloride 422
 Selenyl chloride 429
 Silane, tribromo- 692
 tetraethoxy- 702
 tetramethoxy- 702
 dimethyldichloro- 694
 Silanes 679
 chloro- 691
 poly- 681
 Silica gel 698, 1648
 metaSilicate, barium 706
 diSilicate, barium 706
 metaSilicate, lead 705
 lithium 705
 silver 705
 sodium 704
 diSilicate, sodium 704
 1-Silicates, 12-molybdcid- 1729
 10-tungstic acid- 1719
 12-tungstic acid- 1717
 Silicic acids 697
 aqueous molecular dispersions of 698
 colloidal 698
 crystalline disilicic acid 699
 Silicides of alkali metals 989
 Silicide, calcium 946
 cesium 989
 lithium 991
 magnesium 921
 potassium 989
 rubidium 989
 sodium 989
 Silicides 1795
 Silicochloroform 691
 Silicofluoric acid 214
 Silicofluoroform 214
 Silicon 676
 tetraacetate 701
 azide 476
 (II) bromide 687
 tetrabromide 686
 tetrachloride 682
 chlorides, higher 684
 cyanate 702
 tetrafluoride 212
 tetraiodide 689
 isocyanate 702
 monoxide 696
 oxyhydride 699
 disulfide 700
 Siloxane, chloro- 695
 Silver, very pure 1028
 active agent for reductors 1641
 colloidal 1034
 mirrors 1031
- Silver, "molecular" 1623
 from photographic solutions 1030
 powder 1029
 from residues 1029
 (Berthollet's) fulminating or detonating 1046
 acetylide 1047
 amide 1043
 orthoargentite 1039
 azide 1045
 carbonate 1048
 chlorate 1037
 cyanamide 1047
 fluoride 240
 (II) fluoride 241
 subfluoride 239
 hyponitrite 493
 iodide 1035
 manganate (VII) 1463
 (I) nitrate, bis- α, α' -dipyridyl- 1051
 (II) nitrate, tris- α, α' -dipyridyl 1051
 nitride 1046
 nitrite 1048
 oxide 1037
 (II) perchlorate, tris- α, α' -dipyridyl- 1050
 permanganate 1463
 peroxide 1038
 (II) persulfate, bis- α, α' -dipyridyl- 1051
 (II) persulfate, o-phenanthroline- 1050
 (I) selenide 1041
 metasilicate 705
 sulfate 1042
 (I) sulfide 1039
 trisulfimide 483
 sulfite 1043
 tartrate 1049
 (I) telluride 1042
 Sodium 957
 dispersions of, in inert liquids 967
 finely subdivided, on inert solids 969
 Sodium amalgam 1802
 amide 465
 diSodium monoamidophosphate 581
 Sodium antimonide 986
 orthoargentite 1039
 arsenide 986
 azide 474
 beryllates 895
 bismuthate 627
 bismuthide 986
 metaborate 791
 orthoborate 790
 tetraborate 793
 pentaborate 795
 borofluoride 222
 borohydride 776
 carbide 987
 carbonate 987
 carbonyl cyanoferrate 1769
 chlorite 312

pp 1-992: Vol. 1; pp 1003-1810: Vol. 2

- Sodium tetrachloroaluminate 816
hexachloroosmate (IV) 1602
tetrachloropalladate (II) 1584
hexachloroplatinate (IV) 1571
 -rhodate (III) 1587
 cobaltinitrite 1541
pentacyanoamminoferrate (II) 1511
 (III) 1512
 fluoborate 222
 fluoride 235
 fluoroborate 222
hexafluorotitanate 1163
 germanide 989
 hydride 971
 hydrogen triarsenate 1709
dihydrogen orthoarsenate 602
 arsenide 595
 phosphate 544
 phosphide 530
 hydrogen selenide 419
 diSodium dihydrogen hypophosphate 560
 Sodium hydrogen sulfide 357
tetrahydrogen tellurate (VI) 453
 hydrosulfide 393
 tetraSodium heptahydroxoaluminate 1692
 Sodium hexahydroxochromate (III) 1688
tetrahydroxocuprate (II) 1684
 -ferrate (II) 1686
heptahydroxoferrate (III) 1689
octahydroxoferrate (II) 1690
tetrahydroxomagnesate 1683
hexahydroxoplumbate (IV) 1694
trihydroxostannate (II) 1687
hexahydroxostannate (IV) 1694
trihydroxozincate 1681
tetrahydroxozincate 1682
 hypobromite 310
 hypochlorite 309
 hyponitrate 517
 hyponitrite 495
 tetraSodium hypophosphate 561
 Sodium hyposulfite 393
 tetraSodium imidodiphosphate 589
 Sodium iron (III) thiocyanate 1511
 manganese (V) 1460
trimethoxyborohydride 777
metamolybdate 1712
paramolybdate 1710
 niobate 1323
hexanitritocobaltate (III) 1541
 nitroprusside 1768
 nitrosyl 514
 cyanoferrate 1768
 dinitrosyl thioferrate 1763
 thiosulfatoferrate 1766
 nitroxylate 515
 monoSodium oxohydroxoaluminate (I) 1693
 (II) 1693
 Sodium oxide 975
dioxide 980
 palladochloride 1584
 Sodium perborate 795
 periodates 323
 peroxide 980
tetraphenylborate 803
trimetaphosphate 547
tetrametaphosphate 548
 pentaSodium triphosphate 547
 hexaSodium tetraphosphate 548
 Sodium tripolyphosphate 547
 polyphosphates 549
 phosphide 986
 platinichloride 1571
metaplumbate 758
orthoplumbate 759
 rhenate (IV) 1483
 rhenite 1483
 selenate 433
 selenide 421
 diselenide 421
 selenite 431
 selenopentathionate 434
metasilicate 704
disilicate 704
 silicide 989
orthostannate 739
 diSodium disulfane 361
tetrasulfane 365
pentasulfane 367
 Sodium sulfide 358
disulfide 361
tetrasulfide 365
pentasulfide 367
 orthotellurate 453
 telluride 441
ditelluride 442
 tellurite 449
 telluropentathionate 454
 thioantimonate (V) 619
 thioarsenate 604
monothioorthoarsenate 605
dithioorthoarsenate 605
 thiochromite 1394
hexathiocyanoferrate (III) 1511
dithionate 395
dithionite 393
monothiothiophosphate 569
dithiophosphate 570
trithiophosphate 571
tetrathiophosphate 572
metathioannate 742
tetrathiostannate 743
dithiosulfatoaurate 1063
metatungstate 1727
paratungstate 1712
metavanadate 1703
pyrovanadate 1702
 Stannate, ammonium hexachloro- 731
 (II) barium oxohydroxo- 1696
 potassium hexachloro- 731
 orthoStannate, sodium 739
 Stannate (II), sodium trihydroxo- 1687

pp 1-992: Vol. 1; pp 1003-1810: Vol. 2

Stannate (IV), sodium hexahydroxo 1694

Stannic acids, α - and β - 737, 738

Stannic acid, hexachloro- 730

Stannous oxide 736

Stibine 606

Strontium 926

amalgam 1805

azide 941

fluoride 234

halides 930

hydrides 929

hydroxide 935

hexahydroxonicelate (II) 1686

nitride 940

oxide 932

perchlorate 320

peroxide 936

peroxide octahydrate 937

selenide 939

silicide 947

sulfide 938

telluride 940

Sulfamide 482

Sulfane, crude 346

Sulfanes, pure 349

diSulfane 350

triSulfane 350

tetraSulfane 353

pentaSulfane 353

hexaSulfane 353

heptaSulfane 353

octaSulfane 353

diSulfane, dibromo- 377

triSulfane, dibromo- 379

tetraSulfane, dibromo- 379

pentaSulfane, dibromo- 379

hexaSulfane, dibromo- 379

heptaSulfane, dibromo- 379

octaSulfane, dibromo- 379

monoSulfane, dichloro- 370

diSulfane, dichloro- 371

triSulfane, dichloro- 372

tetraSulfane, dichloro- 372

pentaSulfane, dichloro- 372

hexaSulfane, dichloro- 372

heptaSulfane, dichloro- 372

octaSulfane, dichloro- 372

α -Sulfanuric chloride 412

Sulfate, ammonium gallium (III) 854

antimony (III) 618

antimony (III) oxide 619

lead (IV) 761

nitrosyl hydrogen 406

tin (IV) 744

Sulfates, isopoly- 1714

diSulfatothallic (III) acid 882

-vanadic (III) acid 1282

Sulfides-see parent element

di- μ -Sulfido-tetrakis(dithiobenzoato)di-
nickel (IV) 1558

triSulfimide 483

triSulfimide, silver 483

Sulfite, aluminum 824

Sulfocyanic acid 669

Sulfonate, potassium amido- 507

diSulfonate, potassium azo- 510

Sulfonate, potassium chloroimido- 508

diSulfonate, potassium hydrazine- 509

Sulfonate, potassium imido- 506

potassium nitrilo- 506

diSulfonate, potassium nitroso- 504

Sulfoxylate, cobalt 393

Sulfur, pure 341

colloidal solution 343

plastic 342

Sulfur monobromide 377

diSulfur dibromide 377

Sulfur monochloride 371

dichloride 370

diSulfur dichloride 371

Sulfur tetrachloride 376

tetrafluoride 168

hexafluoride 169

heptaSulfur imide 411

Sulfur nitride tetrahydride 411

diSulfur dinitride 409

tetraSulfur dinitride 408

terranitride 406

triSulfur dinitrogen dioxide 413

dinitrogen pentoxide 414

Lower sulfur oxides 379

diSulfur trioxide 380

Sulfur trioxide, selenium 435

tellurium 455

Sulfur peroxide, poly- 382

Sulfuric acid, deutero- 135

monoSulfuric acid, peroxy- 388

Sulfurous bromide 377

chloride 371

Sulfuryl bromide fluoride 176

chloride 383

chloride fluoride 175

pyroSulfuryl chloride 386

Sulfuryl fluoride 173

triSulfuryl fluoride 174

T

Tantalates, alkali 1323

isopoly- 1707

Tantalate (V), potassium heptafluoro- 256

potassium peroxy- 1325

Peroxytantallic acid 1324

Tantalum metal 1292

(IV) bromide 1310

(V) bromide 1311

carbide 1331

(IV) chloride 1301

(II) chloride 1302

deuteride 1296

(V) fluoride 255

pp 1-992: Vol. 1; pp 1003-1810: Vol. 2

- Tantalum heptafluoride, potassium 256
 hydride 1295
 (V) iodide 1316
 nitride 1328
 (V) oxide 1318
 oxytribromide 1314
 phosphide 1330
 sulfides 1327
- Tellurate, ammonium hexachloro- 444
 cesium hexachloro- 444
 potassium hexachloro- 444
 rubidium hexachloro- 444
 sodium tetrahydrogen 453
- orthoTellurate, sodium 453
- Tellurate, thallium hexachloro- 444
- l-Tellurates, 6-tungstic acid- 1726
- Telluric acid 451
- Telluride, aluminum 826
 beryllium 897
 gallium 855
 hydrogen 438
 indium 865
 magnesium 915
 potassium 441
 sodium 441
- diTelluride, sodium 442
- Tellurite, sodium 449
- Tellurium 437
 solution, colloidal 438
- Tellurium tetrabromide 445
 tetrachloride 442
hexafluoride 180
tetraiodide 447
 dioxide 447
 trioxide 450
 sulfur trioxide 455
- Telluropentathionate, sodium 454
- Tellurous acid 449
- diThallate (III), cesium nonachloro- 874
- Thallate, potassium hexachloro- 873
 potassium pentachloroquo- 874
 (III), rubidium hexabromo- 876
 (III), thallium (I) tetrabromo- 875
hexabromo- 875
tetrachloro- 873
hexachloro- 872
- Thallic (III) acid, disulfato- 882
- Thallium 867
 (III) acid, tetrachloro- 872
 (I) bromide 869
 (III) bromide 874
 (I) tetrabromothallate (III) 875
 (I) hexabromothallate (III) 875
 (I) carbonate 884
 (I) chloride 869
 (III) chloride 870
hexachlorotellurate 444
 (I) tetrachlorothallate (III) 872
 (I) hexachlorothallate (III) 873
 (I) fluoride 230
- Thallium (III) fluoride 230
 (I) formate 884
 (I) hydroxide 887
 (III) hydroxide sulfate 882
 (I) iodide 869
triiodide 876
 (I) malonate 884
 (I) nitrate 883
 (I) nitride 883
 (I) oxide 887
 (III) oxide 879
 (I, III) selenide 881
 (I) sulfate 881
 (III) sulfate 881
 (I) sulfide 880
 (I, III) sulfide 880
- Thenard's blue 1525
- Thioantimonate, sodium 619
 zinc 1083
- Thioarsenate, ammonium 604
 sodium 604
- triThiocarbonate, ammonium 674
 barium 674
- diThiocarbonic anhydride 652
- Thiochromite, sodium 1394
- Thiocyanate, hydrogen 669
 lead 769
- tetraThiocyanatodiamminechromate (III),
 ammonium 1376
 -diamminechromic (III)
 acid 1377
 -dianilinochromate (III),
 ammonium 1378
- hexaThiocyanatochromate (II), potassium
 1374
- trans-diThiocyanatodi(ethylenediamine)
 chromium (III) thiocyanate 1357
- tetraThiocyanatodipyridinochromate (III),
 potassium 1379
- hexaThiocyanatovanadate (II), potassium
 1291
- Thiocyanic acid 669
- hexaThiocyanoferrate (III), sodium 1511
- Thiocyanogen 671
- tetraThiocyanomercurate (II), potassium
 1124
- triThioferrate, ammonium heptanitrosyl
 1764
- Thioferrate, ethyl dinitrosyl 1765
 sodium dinitrosyl 1763
- tetraThiomolybdate, ammonium 1416
- diThionate, barium 397
- triThionate, potassium 398
- tetraThionate, potassium 399
- pentaThionate, potassium 401
- hexaThionate, potassium 403
- diThionate, sodium 395
- Thionic acids, poly- 405
- diThionite, sodium 393
 zinc 394

pp 1-992: Vol. I; pp 1003-1810: Vol. 2

- Thionyl bromide 387
 chloride 382
 chloride fluoride 174
 fluoride 170
tetrafluoride 171
 imide 480
 monoThioorthoarsenate, sodium 605
 diThioorthoarsenate, sodium 605
 diThiophosphate, barium 571
 monoThiophosphate, sodium 569
 diThiophosphate, sodium 570
 triThiophosphate, sodium 571
 tetraThiophosphate, sodium 572
 monoThiophosphoric acid 568
 Thiophosphoryl triamide 587
 (V) bromide 535
 chloride 532
 metaThioannate, sodium 742
 tetraThioannate, sodium 743
 Thiosulfatoferrate, potassium dinitrosyl 1766
- Thorium 1174
 (IV) bromide 1203
 carbides 1248
 chloride 1204
 (IV) chloride 1203
 hydride 1184
 (IV) iodide 1205
 nitrate 1238
 nitride 1236
 (IV) oxide 1221
 phosphide 1241, 1243
 silicide 1249
 sulfide 1222, 1226
- Tin 727
 gray, α - 727
 powder 727
 see also stannate, stannous, etc.
- Tin (IV) acetate 747
 amalgam 1806
 (II) bromide 732
 (IV) bromide 733
 bronze 741
 (II) chloride 728
 (IV) chloride 729
tetraethyl- 746
 (II) fluoride 217
 (IV) fluoride 217
 (II) iodide 734
 (IV) iodide 735
tetraiodide 735
tetramethyl- 744
 (II) oxide 736
 (IV) sulfate 744
 (II) sulfide 739
 (IV) sulfide 741
- Tungstate (III), hexachlorotripyridinedi- 1429
 potassium ennechlorodi- 1427
 (IV), potassium octacyano- 1429
 (V), potassium octacyano- 1430
- Tungstates, isopoly- 1712
 Tungsten 1417, 1622
 blue 1423
 carbonyl 1741
 (V) chloride 1419
 (VI) chloride 1420
 (VI) fluoride 260
 (IV) oxide 1421
 (VI) oxide 1423
 γ -Tungsten oxide 1422
 Tungsten oxytetrachloride 1425
hexaphenolate 1426
hexaphenoxide 1426
 (IV) sulfide 1425
 Titanate, ammonium hexachloro- 1199
 potassium hexafluoro- 1163
 sodium hexafluoro- 1163
 Titanic acid, peroxy- 1219
 Titanium 1161
 (II) bromide 1185
 (III) bromide 1187
 (IV) bromide 1201
 carbide 1245
 (II) chloride 1185
 (III) chloride 1187
 (IV) chloride 1195
 (III) fluoride 248
 (IV) fluoride 250
 hydride 1184
 (II) iodide 1185
 (III) iodide 1187
 (IV) iodide 1205
tetranitrate 1237
 nitride 1233
 (IV) oxide 1216
 (IV) oxide hydrate 1218
 oxides, lower 1214
dioxide 1216
 (III) oxychloride 1209
 (IV) oxychloride 1209
 oxynitrate 1241
 phosphide 1241
 silicide 1249
 (III) sulfate 1226
 sulfide 1222
- Titanoxy sulfate 1228
 Titanyl sulfate 1228
 metaTungstates 1727
 dodecaTungstates 1727
 12-Tungstic acid-1-arsenates 1724
 18-Tungstic acid-2-arsenates 1725
 12-Tungstic acid-1-borates 1716
 1-phosphates 1720
 18-Tungstic acid-2-phosphates 1723
 21-Tungstic acid-2-phosphates 1722
 22-Tungstic acid-2-phosphates 1722
 10-Tungstic acid-1-silicates 1719
 12-Tungstic acid-1-silicates 1717
 6-Tungstic acid-1-tellurates 1726
 guanidinium salt 1726
 Tungstic acid, yellow 1424
 Turquoise green 1092

pp 1-992: Vol. 1; pp 1003-1810: Vol. 2

U

- Uranates (V), alkali 1445
 (VI), alkali 1445
 (IV), potassium tetraoxalato- 1450
 Uranium 1431
 (IV) bromide 1440
 (III) chloride 1435
 (IV) chloride 1436
 (V) chloride 1438
 (V) ethoxide 1451
 (VI) ethoxide 1452
 (V) ethylate 1451
 (VI) ethylate 1452
 (IV) fluoride 261
 (VI) fluoride 262
 hydride 1434
 (IV) oxalate 1449
 (IV) oxide 1442
 (VI) oxide 1442
 peroxide 1446
 (IV) sulfate 1447
 (IV) sulfide 1446
 Uranyldibenzoylmethane 1453
 Uranyl carbonate, ammonium 1449
 Uranyl chloride 1439
 hexaUrechromium (III) chloride 1359

V

- Vanadates, alkali 1273
 metaVanadate, ammonium 1272
 Vanadate, ammonium disulfato- 1283
 hydrogen disulfato- 1282
 potassium hexafluoro- 270
 potassium disulfato- 1283
 potassium hexathiocyanato- 1291
 Vanadates, isopoly- 1702
 24-Vanadic acid-2-phosphates 1739
 48-Vanadic acid-2-phosphates 1739
 Vanadic (III) acid, disulfato- 1282
 Vanadium 1252
 acetate 1283
 (III) alum, ammonium 1284
 (III) alum, cesium 1284
 (III) alum, potassium 1284
 (III) alum, rubidium 1284
 (0), dibenzene- 1289
 (II) bromide 1260
 (III) bromide 1260
 carbides 1288
 (II) chloride 1255
 (III) chloride 1256
 (IV) chloride 1259
 (III) fluoride 252
 (IV) fluoride 252
 (V) fluoride 253
 hydride 1295
 (III) hydroxide 1268
 (II) iodide 1261

- Vanadium (III) iodide 1262
 nitrides 1286
 (V) oxide 1270
 oxides, lower 1266
 oxychloride 1262
 oxydichloride 1263
 oxytrichloride 1264
dioxychloride 1265
 (IV) oxysulfate 1285
 phosphides 1287
 selenides 1276
 (II) sulfate 1277
 sulfides 1274
 Vanadyl dichloride 1263
trichloride 1264
 sulfate 1285
 Vermilion 1112

W

- Wackenroder liquid 405
 Water, pure 117
 "conductivity" 118
 heavy 119
 pH-pure 119
 Wolfram--see Tungsten

X

- Xanthocobalt chloride 1534

Y

- Ytterbium, pure compounds 1138
 solid metal 1142
dibromide 1150
dichloride 1150
diiodide 1150
 sulfate 1138
 Yttrium fluoride 246

Z

- Zinc 1067
 very pure 1067
 Zinc acetate 1087
 amalgam 1806
 amide 1079
 arsenides 1083
 bromide 1072
 carbonate 1086
 chloride 1070
 chloride hydroxide 1071
 cyanide 1087
 diethyl- 1084
 ferrate (III) 1090
 fluoride 242

pp 1-992: Vol. 1; pp 1003-1810: Vol. 2.

- Zinc fluorosilicate 1090
fluosilicate 1090
formaldehyde sulfoxylate 1076
monoZinc formaldehyde sulfoxylate 1076
Zinc hydride 1069
hydrosulfite 394
hydroxide 1074
hydroxychloride 1071
hydroxyphosphate 1082
hyposulfide 394
iodide 1073
nitride 1080
oxide 1664
oxymethanesulfinate, primary 1076
phosphate 1081
orthophosphate 1081
phosphides 1080
potassium cyanide 1088
selenide 1078
silicate 1089
orthosilicate 1089
sulfate, ammonium 1077
sulfide 1075
thioantimonate 1083
dithionite 394
- Zinc paratungstate 1713
Zincate, ammonium tetrachloro- 1070
potassium tetracyano- 1088
sodium trihydroxo- 1681
sodium tetrahydroxo- 1682
Zirconium 957, 1172
salts, purification of 1232
separation of hafnium and 1179
Zirconium (IV) bromide 1203
carbide 1245
(IV) chloride 1203
(IV) fluoride 251
hydride 1184
(IV) iodide 1205
nitride 1233, 1236
(IV) oxide 1220
oxychloride 1210
oxynitrate 1241
phosphate 1244
phosphides 1241, 1243
silicide 1249
sulfate 1231
sulfide 1222, 1226
Zirconyl chloride 1210

Index of Procedures, Materials and Devices

pp 1-992: Vol. 1; pp 1003-1810: Vol. 2

A

Active copper 458, 1633
metals 613
Agitation in the absence of air 1748
Air-sensitive substances, storage of 75
Alcohol, dehydration of 26
Alkali hydroxides, handling of concentrated 1679
Alloys 1771
Amalgams 1801
Ammonia, extraction with liquid 86,
1100, 1526, 1792
Ampoules, removal of contents of 119
for alloys 1782
breaking of, in the absence of air 120,
135
Anshütz flask 1271
Apiezon grease 29
Apparatus, assembly of 4
Arc furnace 42

B

Ball mill 1127, 1129, 1167, 1195
vacuum-type 76
Bodenstein valve 62, 481
Bomb tube 1303, 1304, 1306
Break-seal valves 63, 133, 136, 137,
1168, 1197, 1206

C

Calcium fluoride lining 152
Carbon 13, 20
electrodes 181
tube furnaces 39
vessels made of 15
Catalyst carriers (supports) 1270,
1611
Catalysts 1270, 1563, 1574, 1580, 1583,
1609
Cathode, commercial, for electrolytic
reduction 1277, 1366, 1427
Cements
for glass tubes 10
glycerol-litharge 31
phenol-formaldehyde 32
silver chloride 31
waterglass 31
zinc oxide 31
Ceramics 12, 1779

Cleaning of glassware 7, 9
Coating with silver 1031
Cold baths 45
Commercial electrodes 1277, 1366,
1427
Commercial gases, purification of 78,
111, 272, 334, 458, 460, 646, 647
Comminution in the absence of air 74,
1786
Condensation traps 66
"Containerless" fusion 1786
Controller for power supply 47
Cooling 42
Copper cylinder, revolving 244
tower 459
Cristobalite 8
Crucible for wetting of alloys 1774
Tammann 1214
Cryostats 42, 46
Crystal-growing processes 94, 1294

D

Dehydration of organic liquids 26
Devitrification 8
Diaphragm valve 65
Differential manometers 85
Distillation, general discussion of 91
in the absence of air 65, 1198
of metals 887, 903, 923, 960, 1068,
1455, 1789
of very pure water 117
vacuum 92, 1198
Dropping funnels for corrosive media
131
Dry bag 70
box 70
Ice 43
Drying agents 80
pistol 1291

E

Electrical comminution (size reduction)
524
Electrical discharge in gases 90, 162,
265, 337
sputtering 524
Electrode carbon 13
Electrolysis, cell 1269, 1557
of fused salts 143, 169, 180, 956,
1143, 1170, 1177, 1250, 1433

pp 1-992: Vol. 1; pp 1003-1810: Vol. 2

Electrolysis

- gas evolution in 116, 123, 274, 334, 439, 607
 - metal deposition (separation) from
 - 837, 858, 867, 956, 1028, 1068, 1092, 1143, 1169, 1177, 1335, 1433, 1454, 1490, 1638, 1805
 - separation of substances by means of
 - 520, 1503, 1791
 - of very small quantities of liquids 124
 - Electrolytic oxidation 390, 392, 562, 751, 761, 1556, 1694
 - reduction 239, 439, 498, 607, 1138, 1193, 1268, 1277, 1291, 1366, 1413, 1427, 1447
- Epoxy resins 32
- Ether, dehydration of 27
- Evaporation in vacuum 543, 559
- Extraction with liquid ammonia 86, 1100, 1526, 1792

F

- Faraday system (apparatus) 76, 1241, 1287, 1330
- Fermentation cap 1199
- Filling (of vessels) in the absence of air 70, 74, 918, 960, 963, 966, 1280, 1304, 1343, 1786
- Filtering in the absence of air 72, 598, 1276, 1456, 1551, 1756
- Fire clay 13, 18
- Float valves 61
- Fluidized bed 1616
- Fluorine compounds, general 150
- Fluorine-resistant vessels 143, 149
- Fluorspar apparatus 152
- Fractionation at low temperatures 66
- Freezing baths 42
 - mixtures 42
- Frit valves 61
- Furnaces 32, 1784
 - arc and electronic radiation 42
 - Globar 38
 - induction 44
 - with internal heating coils 36
 - Nernst 39
 - molybdenum wire 37
 - solar 42
 - Tamman 39, 1215
 - tubular tungsten 40
 - wire-wound 34
- Fusing glass to ceramics 10
 - glass to metals 11, 25
- Fusion in the absence of air 984, 1483, 1774
 - (melting) of alloys 1772, 1782, 1784, 1786

G

- Gas discharge, electrical 90, 162, 265, 337
 - traps 66

- Gases, collector for 69
 - drying of 80
 - general discussion of 77
 - generators for 77
 - liquefaction of 86
 - liquid, as reaction media 86
 - measuring the pressure of 55
 - purification of commercial 78, 111, 272, 334, 458, 460, 646, 647
 - rate of flow of (control and measurement) 84, 853
 - receivers for 69, 84
- Gasometer 84
- Glass 5
 - chemical 5
 - common types of 6
 - joins to ceramics 10
 - joins to metal 11, 25
 - Pyrex 6
 - Vycor 6
- Gold shield, movable 1483
- Graded seals 9
- Graphite 13, 17, 22
 - clay-bonded 13
 - electrodes 181
 - retort 13
- Gravity separation 97
- Greases 28
- Grignard reaction 744, 763, 1084, 1103, 1118, 1398

H

- Heat-induced synthesis of alloys 1772
- Heating, combustion 32
 - electrical 32
- High-surface materials 1609
- High vacuum 53, 66
- Hostaflon 1265

I

- Igniting cherry 1334, 1402
- Induction furnaces 41
- Ion exchangers 555, 1179, 1701
- Ion-exchange resins 55, 1179, 1701
- Isoteniscope 101

J

- Joints, glass 9
 - glass to ceramics 10
 - glass to metal 11, 25
 - standard taper 9

K

- K-Mass 18
- Kel-F 25
- Kipp generator 77

pp 1-992: Vol. 1; pp 1003-1810: Vol. 2

L

Lead cathode for electrolytic reduction
1277, 1366, 1427
Leaks, testing for 69
Liquefied gases 65, 86
Liquid air, handling of 44
Liquid ammonia as a reaction medium
86, 358, 360, 463, 585, 593, 1043,
1100, 1526, 1794
Liquid-filled thermometers 50
Low-melting alloys 1808
Lubricants 28

M

Manometers 55, 84
McLeod 39, 57, 1158
mercury 55
Moser 58
Null 56
with quartz spiral 56
Marquardt mass 18
McLeod gauge 39, 57, 1158
Melting point, determination of 69, 100
Melts, electrolysis of 143, 181, 956,
1144, 1170, 1177, 1250, 1433
Mercury, purification of 27
Metals, as materials for vessels 17,
1776
fusion to glass 11, 25
Microelectrolysis 124
Mirrors 1031, 1644
Movable gold shield 1483
Mullite 13

N

Nernst furnace 39
Null manometer 56

O

Observation port 75
Ovens 32, 1784
Ozonizer 337

P

Picein 30
Platinized asbestos 1565
Platinum coating, electrolytic 1565
by thermal means 1565
Platinum electrodes 1566
Platinum equipment, handling of 1564
Platinum, reclamation of 1564
Plexiglas 25
Pneumatolytic-hydrothermal synthesis
1089

Podbelniak distillation column 93
Polyethylene 25, 31
Polytrifluorochloroethylene 25
Polytetrafluoroethylene 25
Polyvinyl acetates 30
Polyvinyl chloride 25
Porcelain 12, 18
Ports, flat and parallel 73
Powder reactions 103
Precipitation in the absence of air 72,
1276, 1456, 1551, 1747, 1756
Pressure gauges 55, 84
measurement 55, 101
synthesis 76, 989, 1151, 1223, 1242,
1274, 1287, 1330, 1443, 1527, 1741,
1784, 1804
Protective melts for alloys 1774
Pyrex glass 5
Purification of substances 91
Purity, analysis of 100
Pyrometer, radiation 53
Pyrophoric tendency 1614
Pythagoras mass 18, 1780

Q

Quartz, fused (glass) 5, 8, 18

R

Radiation pyrometer 53
Raschig rings 92
Reactions in arc furnaces 653, 1248,
1669
Reaction lamp 1332
Recrystallization 71, 94
Refining processes 1168, 1173, 1178,
1332
Residue methods for alloys 1791
Resistance thermometer 50
Rose's metal 31
Rotameters 84, 853

S

Schlenk tube 75
Seals, graded 9
Sealing materials 28
wax 30
Shatter valves 63, 133, 136, 137, 1168,
1197, 1206
Silica gel 1648
Silicon carbide 22
grease 30
Sillimanite 13, 18
Sillimantium 13, 18
Silver mirrors, deposition of 1031
Single crystals, growth of 94
Sintered alumina 13, 20
oxides 13, 18
Sintering 103, 1234, 1245, 1795, 1799

pp 1-992: Vol. 1; pp 1003-1810: Vol. 2

Smokes 1669
 Solders for metals 24
 Solvents, organic 26
 pure 25
 Splash shield 1483
 Sputtering (electrical atomization)
 1035
 Standard taper and ball joints, glass
 9
 Steel cylinders for gas storage 77
 Stock's apparatus for work in vacuum
 66
 Stock's mercury valve 61, 69
 Stopcocks (see also valves) 59
 for corrosive media 131
 Sublimation (see also distillation) 92,
 249, 903, 923, 1302
 Synthesis under pressure 76, 989, 1151,
 1223, 1242, 1274, 1287, 1330, 1443,
 1527, 1741, 1784, 1804
 Synthetic resins—Plastics 25

T

Tablets 103, 1795, 1799
 Tammann crucible 1214
 Tammann furnace 39, 1215
 Teflon 25, 149, 1266
 Temperature, constant 45
 gradient 76
 high 32
 low 42
 measurement of 49
 Thermocouples 51
 Thermometers 49
 Thermoplastic materials 25
 Thermostats 46
 Toepler pump 66
 Tombac tube valve 65
 Tungsten furnace, tubular 40
 Two-arm tube 1044

U

Universal reaction system 66

V

Vacuum apparatus 65
 ball mill 76
 distillation 92, 1198
 gauge 39, 57
 systems, special 66
 Vakuscope 58
 Valves 61
 Bodenstein 62, 481
 diaphragm 65
 float 61
 frit 61
 needle 64
 shatter 63, 133, 136-7, 1168, 1197,
 1206
 Stock (mercury-filled) 61, 69
 Vapor-deposition processes 1234,
 1245, 1254, 1289, 1294, 1328, 1332,
 1645, 1798, 1799
 Vaporization of metals 18, 1643
 Vapor pressure measurements 55, 101
 eudiometer 102, 1100, 1115
 thermometer 49, 67
 Vessels resistant to fluorine 143, 149
 Vitreosil 18
 Vycor glass 5
 tubes 1068, 1083, 1096, 1191, 1255,
 1294, 1297, 1315, 1420

W

Wash bottles, fritted-disk 79
 Washing in the absence of air 1626
 Wax 30
 Welding of metals 24
 Wood's metal 31, 62, 1809
 Work in the absence of air 53, 66, 119,
 598, 916, 961, 1198, 1278, 1303,
 1456, 1483, 1551, 1626, 1747, 1756,
 1774, 1779, 1786

Z

Zone-melting process 97
 Zinc reductor 1368
 Zündgemisch 1334, 1402
 Zündkirsche 1334, 1402

Errata for Volume I

Page	Line	Should read
218	3 from bottom	. . . b.p. 1293°C; d 8.24 . . .
505	1	. . . a drop of KI-starch solution, i.e., whether the desired large excess of nitrite is present. If this is not the case, one must either wait a while or add some more nitrite. Then 25 ml. of 10N . . .