

Unit 1

The Atmospheric Filter

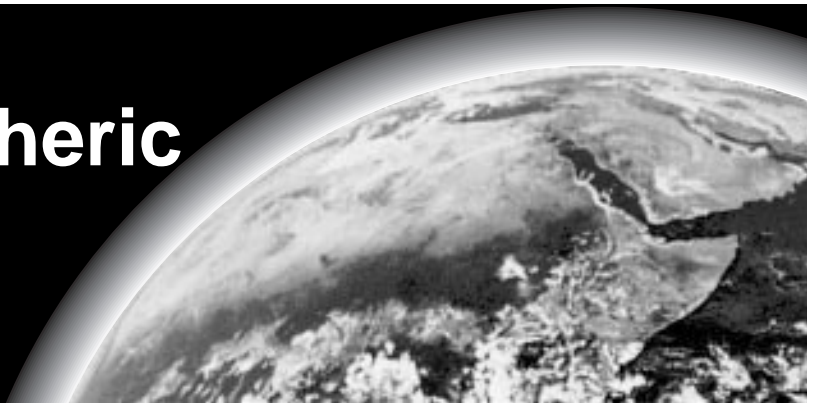

Introduction

Earth's atmosphere is essential to life. This ocean of fluids and suspended particles surrounds Earth and protects it from the hazards of outer space. It insulates the inhabitants of Earth from the extreme temperatures of space and stops all but the largest meteoroids from reaching the surface. Furthermore, it filters out most radiation dangerous to life. Without the atmosphere, life would not be possible on Earth. The atmosphere contains the oxygen we breathe. It also has enough pressure so that water remains liquid at moderate temperatures.

Yet the same atmosphere that makes life possible hinders our understanding of Earth's place in the universe. Virtually our only means for investigating distant stars, nebulae, and galaxies is to collect and analyze the electromagnetic radiation these objects emit into space. But most of this radiation is absorbed or distorted by the atmosphere before it can reach a ground-based telescope. Only visible light, some radio waves, and limited amounts of infrared and ultraviolet light survive the passage from space to the ground. That limited amount of radiation has given astronomers enough information to estimate the general shape and size of the universe and categorize its basic components, but there is much left to learn. It is essential to study the entire spectrum rather than just limited

regions of it. Relying on the radiation that reaches Earth's surface is like listening to a piano recital with only a few of the piano's keys working.

Unit Goals

- To demonstrate how the components of Earth's atmosphere absorb or distort incoming electromagnetic radiation.
- To illustrate how important observations above Earth's atmosphere are to astronomy.

Teaching Strategy

The following activities use demonstrations to show how the components of Earth's atmosphere filter or distort electromagnetic radiation. Since we cannot produce all of the different wavelengths of electromagnetic radiation in a classroom, the light from a slide or filmstrip projector in a darkened room will represent the complete electromagnetic spectrum. A projection screen represents Earth's surface and objects placed between the projector and the screen represent the effects of Earth's atmosphere. With the exception of a take-home project, all the demonstrations can be conducted in a single class period. Place the projector in the back of the classroom and aim it towards the screen at the front. Try to get the room as dark as possible before doing the demonstrations.

Activity Titles

Clear Air

Activity Objective: To demonstrate that gas molecules in the atmosphere absorb some of the visible light that passes through them.

Application: Astronomy, Physical Science

Water In The Air

Activity Objective: To show that moisture is present in the atmosphere and demonstrate how it absorbs visible light.

Application: Astronomy, Meteorology, Physical Science

Red Sky, Blue Sky

Activity Objective: To illustrate how the gases in the atmosphere scatter some wavelengths of visible light more than others.

Application: Astronomy, Meteorology, Physical Science

Ultraviolet Absorption

Activity Objective: To show that the atmosphere is transparent to low-energy ultraviolet light but not to high-energy ultraviolet light.

Application: Astronomy, Environmental Science, Physical Science

Particle Pollution

Activity Objective: To observe the effects suspended particles of pollution have on the transmission of visible light.

Application: Astronomy, Environmental Science, Meteorology

Particulate Sampler

Activity Objective: To obtain a quantitative measurement of the particulate pollution present in the neighborhood of the students and school.

Application: Astronomy, Environmental Science, Meteorology

Heat Currents

Activity Objective: To show how visible light appears to shimmer, when seen through rising heat currents.

Application: Astronomy, Meteorology, Physical Science

Day and Night

Activity Objective: To demonstrate the effects of day and night cycles on astronomical observations.

Application: Astronomy

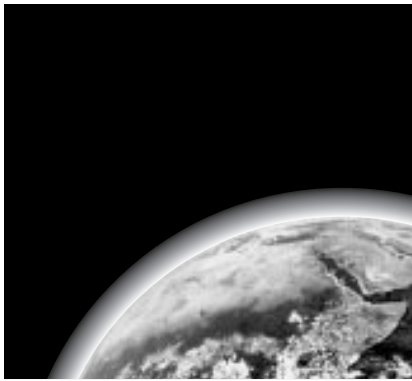

Clear Air

Description: Sheets of clear glass are held between a projector and a screen to show that not all light is transmitted by apparently clear materials.

Objective: To demonstrate that gas molecules in the atmosphere absorb some of the visible light that passes through them.

Materials:

Several small sheets of clear glass or Plexiglass
Emery paper (fine)—Use on glass.
Projector
Screen
Dark room

Procedures:

1. Before handling the glass sheets, smooth sharp edges with emery paper. Skip to the next step if using plexiglass.
2. Hold up one of the sheets so that the students can examine it. Ask them to describe what they see. At some point, one student will say that the glass is clear. Ask the other students if they agree that the glass is clear.
3. Darken the room and turn on the projector.
4. Hold the clear glass between the light and screen. Observe the distinct shadow cast by the edges of the glass and the slight dimness of the light that has passed through the glass. Place an additional sheet of glass on top of the first and observe any difference in the light as it passes through double-thick glass. Add a third sheet of glass and repeat.
5. While holding the glass in the projector beam, observe if there are any reflections of the light around the room.
6. With the room lights back on, observe the edge of the glass. Does light pass through the edge? What color is the edge? What causes this color?

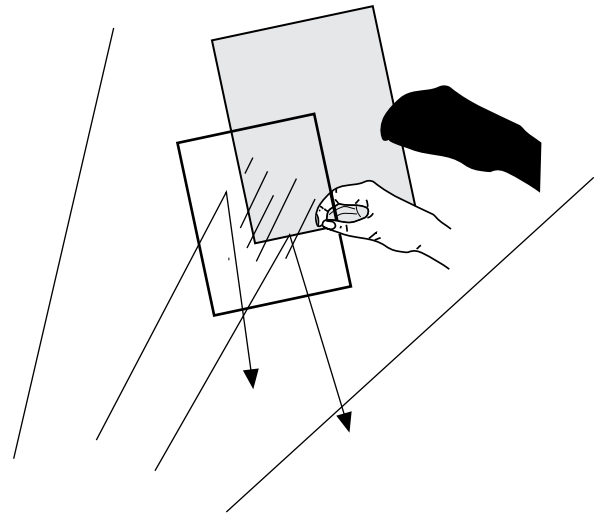

Discussion:

This demonstration provides an analogy for the light-filtering effects of the atmosphere. The shadow cast by the glass shows that although the glass appears to be clear, it prevents some of the light from reaching the screen. The glass reflects some light off its front surface and absorbs some of the light that attempts to pass through it. The effect is similar to what happens with Earth's atmosphere. Part of the visible radiation attempting to reach Earth is reflected by the atmosphere, particularly by clouds, and part is absorbed and scattered by the gases in the atmosphere.

For Further Research:

- Why do the edges of a sheet of glass usually appear green?
- Compare this demonstration with the following activities: Red Sky, Blue Sky? (page 14) and Resonance Rings (page 44).

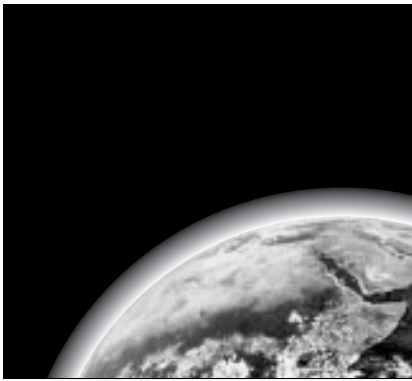

Water In The Air

Description: The presence of water in the atmosphere is demonstrated and its light-filtering effects are shown.

Objective: To show that moisture is present in the atmosphere and demonstrate how it absorbs visible light.

Materials:

Shallow dish or an aluminum pie plate
Empty coffee can
Ice water
Water spray bottle
Cloud cutout (white cardboard or foamcore)
Projector
Projection screen
Dark room

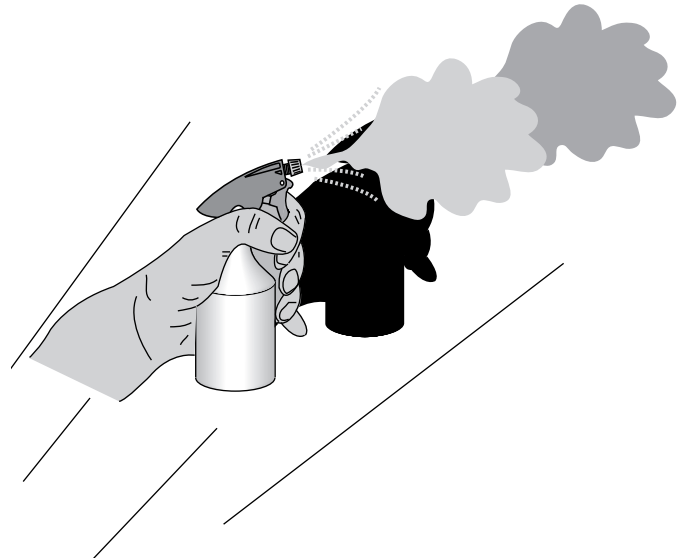

Procedure:

Part 1. Fill the coffee can with ice water and place it in the shallow dish or pie plate. Observe the outside of the can every minute or two. Water droplets from the air will begin to condense on the outside of the can.

Part 2. Darken the room and turn on the projector. Place some clean water in the spray bottle. Adjust the spray to a fine mist. Hold the bottle between the

projector and screen and spray.

Observe the shadows on the screen cast by the fine water droplets.

Part 3. Simulate how clouds block visible radiation by holding up a cutout of a cloud between the projector and the screen.

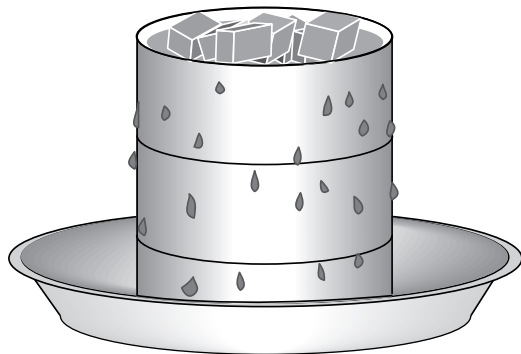

Discussion:

The first demonstration shows that water is present in the atmosphere. The capacity to hold water is determined by the atmospheric temperature. Warm air can hold more water than cold air. Because the can is chilled by the ice water, the air immediately surrounding the can cools. Lowering air temperature reduces its capacity to hold water, and so the excess water condenses on the outside of the can. The amount of water in the atmosphere at any one time, expressed as a percentage of complete saturation, is called the *relative humidity*. Humid air filters out

much of the infrared portion of the electromagnetic spectrum. Since air's capacity to hold moisture drops with temperature, astronomers build infrared telescopes on high mountain tops where the air is much cooler and therefore drier than at lower elevations. Infrared telescopes are also carried on airplanes like NASA's Gerard P. Kuiper Airborne Observatory from which observations can be taken at altitudes above 12,000 meters. Another good location for viewing is Antarctica because of its dry air. Telescopes in space gain an even better view of infrared radiation.

The second demonstration illustrates the effect of small water droplets on light passage. The third demonstration shows that clouds are very effective filters of visible light.

For Further Research:

- Use a sling psychrometer or other humidity measuring device to determine the relative humidity of the atmosphere. Does the absolute humidity in the atmosphere change with the air temperature? Is there a difference in the clarity of the atmosphere between warm and cold nights?
- Design an experiment to compare the water capacity of warm and cold air.
- Obtain black and white pictures of Earth from space and estimate the total cloud coverage visible.
- Is it better to locate an observatory on a high or low point above sea level? Why?
- Take your class to a science museum that has exhibits on atmospheric phenomena.

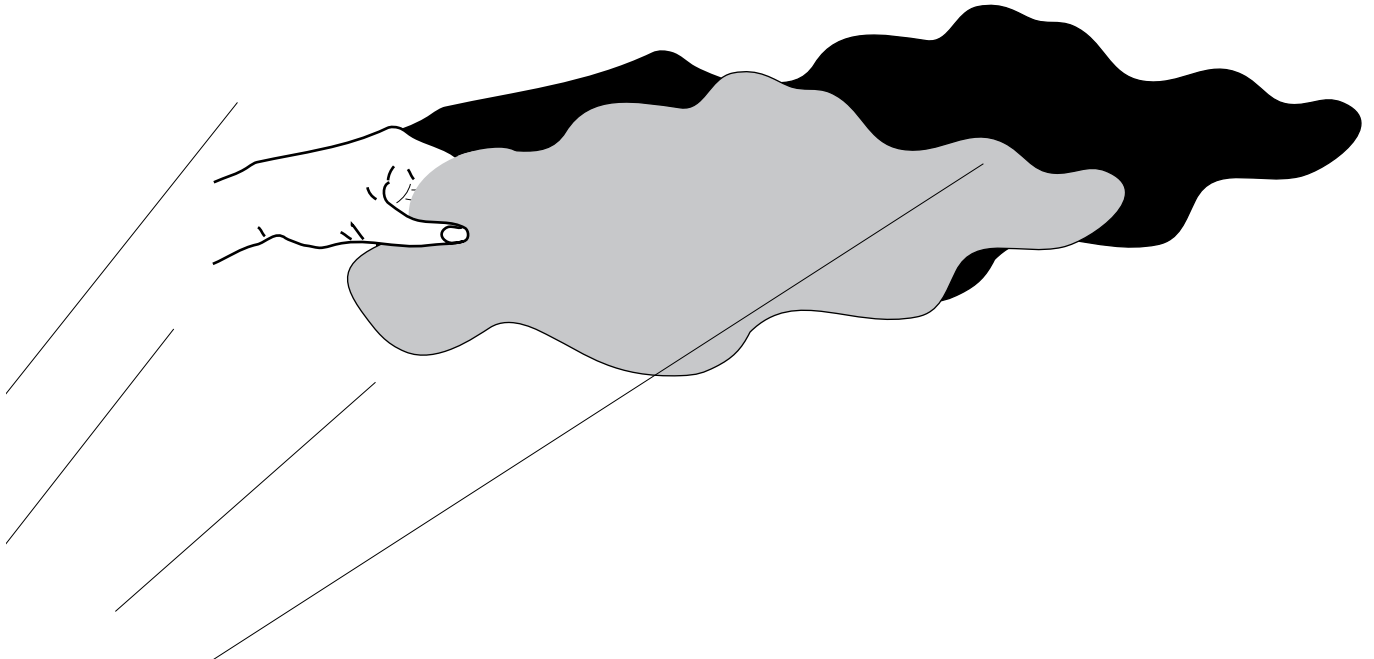

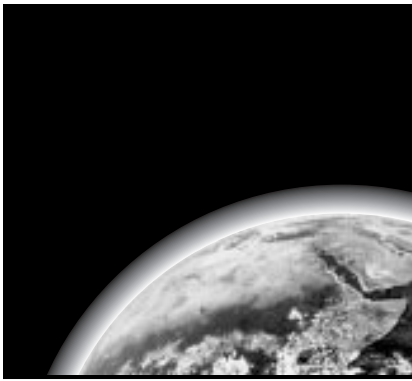

Red Sky, Blue Sky

Description: Milky water is used to simulate a sunset and the blue sky.

Objective: To illustrate how the gases in the atmosphere scatter some wavelengths of visible light more than others.

Materials:

Aquarium
Stirrer
Flashlight
Opaque card with hole
Water
Milk
Eye dropper
Dark room

Procedure:

1. Fill the aquarium with water and set up the demonstration as shown in the illustration.
2. Add a few drops of milk to the water and stir the water to mix the two liquids. You may have to add more drops to achieve the desired color change effect. Refer to the discussion for more information.
3. Darken the room and turn on the flashlight.
4. Observe the color of the light coming from the flashlight. Next, observe the color of the light as it comes directly through the aquarium. Observe the color of the liquid from the side of the aquarium.

Discussion:

One of the standard "why" questions children ask is, "Why is the sky blue?" Sunlight has all of the rainbow colors: red, orange, yellow, green, blue, and violet. Earth's atmosphere contains molecules of gas that scatter the blue

colors out of the direct path of sunlight and leave the other colors to travel straight through. This makes the Sun look yellow-white and the rest of the sky blue. This effect is accentuated when the Sun is low in the sky. At sunrise and sunset, sunlight has to penetrate a much greater thickness of atmosphere than it does when it is overhead. The molecules and dust particles scatter almost all of the light at sunrise and sunset—blue, green, yellow, and orange—with only the red light coming directly through to your eyes; so, the Sun looks red.

Caution: Never stare directly at the Sun.

In this demonstration, the suspended particles of milk scatter the light like the molecules in Earth's atmosphere. When the flashlight beam is viewed directly through the water, the blue wavelengths of light are scattered away from the beam of light, leaving it yellowish. Increasing the amount of milk simulates smog and the Sun will look red. Viewing the water from the

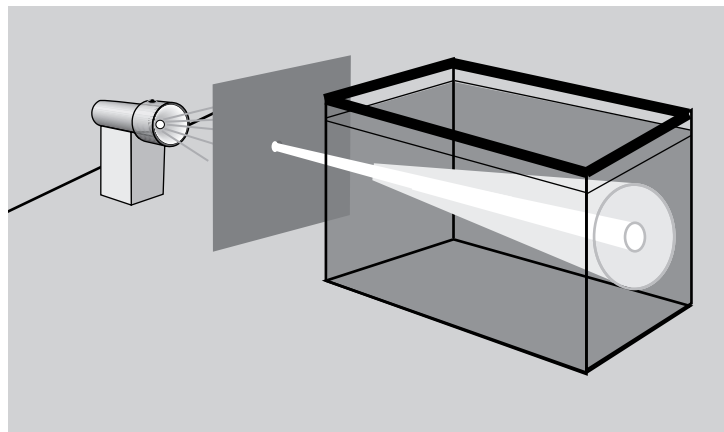

side reveals a very subtle grey-blue hue.

Note: Because of individual color sensitivity, some people may not be able to see the bluish hue.

For Further Research: When energized by sunlight, oxygen and nitrogen atoms in the atmosphere re-emit (scatter) light in all directions, causing the entire atmosphere above us to be lighted by sunlight. Violet light is

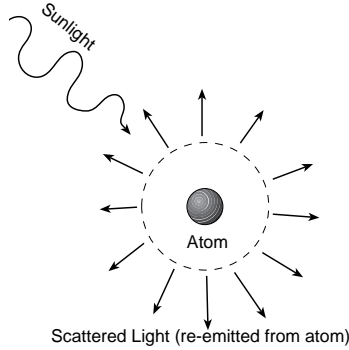

scattered the most and red light the least (1/10th as much). Because our eyes are not very sensitive to violet light, the sky appears blue.

- Draw a diagram on a chalkboard or overhead transparency like the one shown below in which you are looking down at Earth from a position far above the North Pole. Measure the difference in atmospheric thickness the Sun's rays must penetrate to reach each location on Earth's surface in the diagram below. Which ray has the greatest distance to travel through the atmosphere to reach Earth's surface?
- Pretend you are standing at each location looking toward the Sun. What color should the Sun be?
- What is the approximate local time for each location?

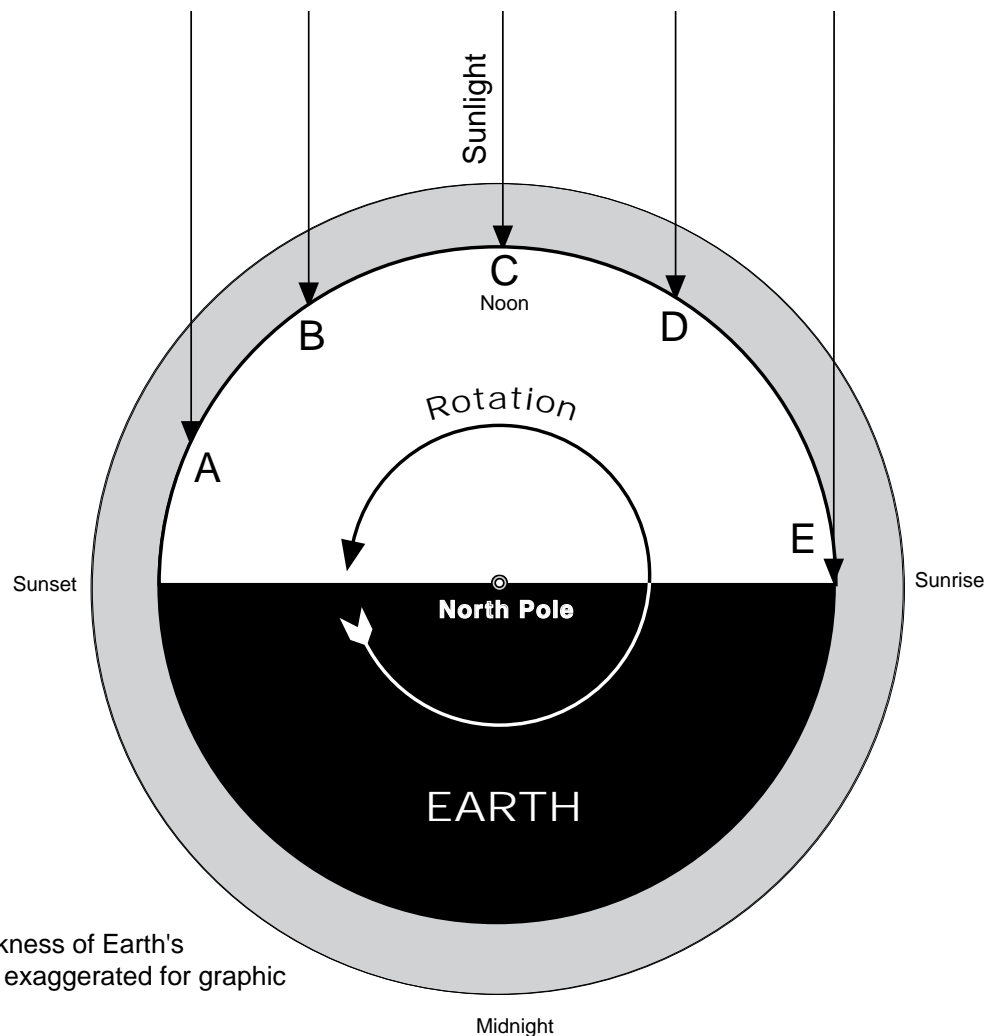

Note: The thickness of Earth's atmosphere is exaggerated for graphic purposes.

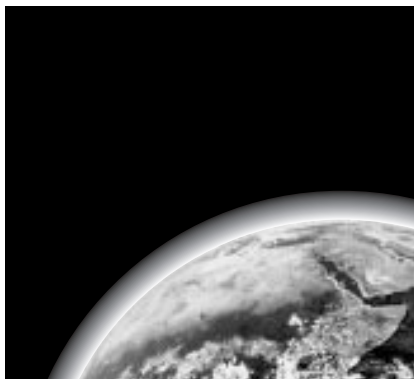

Ultraviolet Absorption

Description: A piece of glass or clear plastic blocks shortwave ultraviolet light.

Objective: To show that the atmosphere is transparent to low-energy ultraviolet light but not to high-energy ultraviolet light.

Materials:

Ultraviolet light ("black light") - broad spectrum (may be available from a high school science laboratory or a rock and mineral collector)
Fluorescent mineral (See note in the discussion section.)
Window glass
Dark room

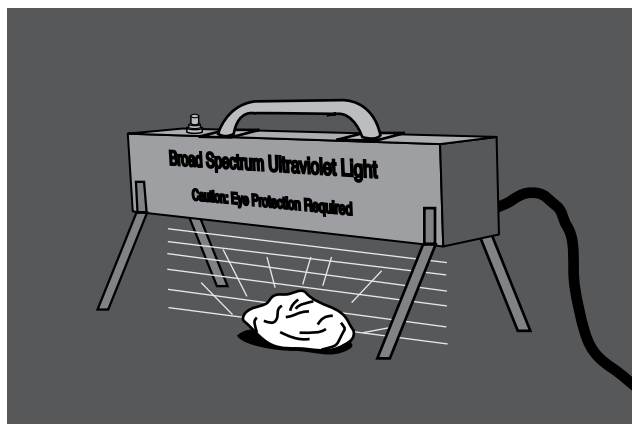

Procedure:

1. Darken the room and turn on the ultraviolet (UV) light. (See **Caution** at the end of the discussion section.) Direct the UV light's beam onto the fluorescent minerals. Observe the color of the emitted light.
2. Place the glass between the light and the mineral and again observe the emitted light.

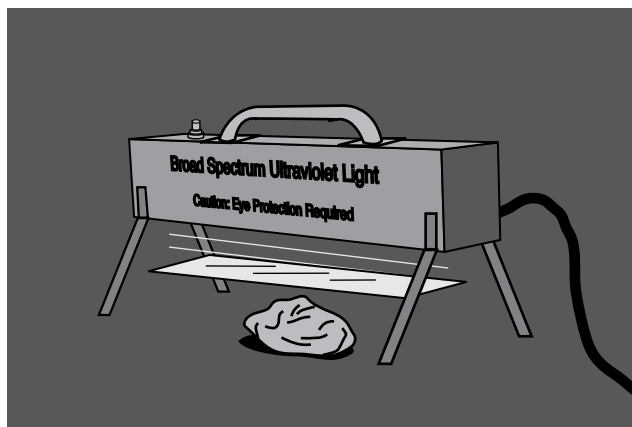

Discussion:

Certain minerals and a variety of other substances fluoresce or emit visible light when illuminated by ultraviolet light. *Fluorescence* is a process that exchanges ultraviolet-light energy for visible-light energy. Photons of ultraviolet light are captured by electrons orbiting the nuclei of atoms within those materials. The electrons, gaining energy, are boosted to excited energy states. The electrons eventually release this captured energy as visible light as they return to lower energy states.

Low-energy ultraviolet light—sometimes called long-wave UV—penetrates to Earth's surface. This low-energy ultraviolet light causes Day-Glo paints to give off spectacular colors and white clothing to glow brightly when washed in detergents that contain fluorescent dyes (advertised as making clothes "whiter than white"). Most of the high-energy ultraviolet light—sometimes called short-wave UV—is blocked by the ozone layer in Earth's upper atmosphere. Higher-energy ultraviolet light causes skin

tanning. Extended exposure can lead to eye damage and skin cancer in light-skinned people. Skin cancer is rare in dark-skinned people.

Although transparent to lower-energy ultraviolet light, glass blocks higher energy ultraviolet light. Lotions that are advertised as Sun blockers also block higher energy ultraviolet light. When the glass is inserted between the lamp and the fluorescing material in this demonstration, the fluorescence diminishes or stops. Some materials fluoresce with lower energy ultraviolet waves as well as the higher energy waves, and any continued fluorescence is the result of the lower energy waves.

Ultraviolet light tells astronomers several things. For example, the local neighborhood of our Sun—within 50 light years—contains many thousands of low-mass stars that glow in the ultraviolet. When low-mass stars use up all their fuel, they begin to cool. Over billions of years, the internal heat left over from stellar fusion reactions radiates into space. This leftover heat contains a great deal of energy. These stars, called *white dwarfs*, radiate mostly ultraviolet light. Until astronomers could make observations with ultraviolet telescopes in space, they had very little information about this phase of a star's evolution.

Caution: Do not look into the light emitted by the broad spectrum ultraviolet lamp.

Avoid directing the light to reflective surfaces. Everyone should wear eye protection such as laboratory safety glasses or ordinary eye glasses.

Where to Obtain Ultraviolet Lights and Minerals:

Many science-supply catalogs sell ultraviolet lights and fluorescent minerals. If you purchase a light, be sure to obtain a broad spectrum light because it will emit both long and short wave ultraviolet light. Order minerals, such as calcite, fluorite, and franklinite, that fluoresce at short wavelengths, long wavelengths, and both long and short wavelengths. If you do not wish to purchase a lamp and minerals, check with other schools to see if they have equipment you can borrow. Also check with local rock and mineral clubs. Many collectors have lights and fluorescent minerals and may be willing to come to your school to give a demonstration. If ultraviolet minerals are not available, experiment with ultraviolet-sensitive paints or paper.

For Further Research:

- Check recent magazine articles about problems with Earth's ozone layer and ultraviolet radiation at Earth's surface. Learn what can be done to help protect Earth's ozone layer.
- Take a field trip to a science museum that has displays of fluorescent minerals or arrange for a rock and mineral collector to bring a fluorescent mineral display to your school.

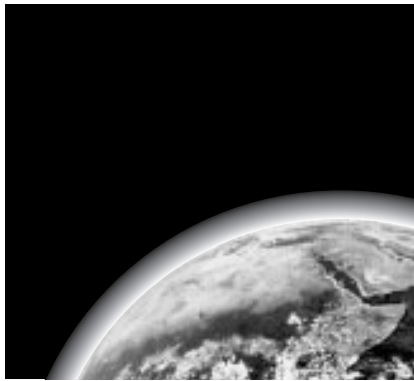

Particulate Pollution

Description: Particulate matter from both natural and human made sources obscures the sky.

Objective: To observe the effects of suspended particles of pollution on the transmission of visible light.

Materials:

Stick or book matches
Two dusty chalk erasers
Flashlight
Projector
Projection screen
Dark room

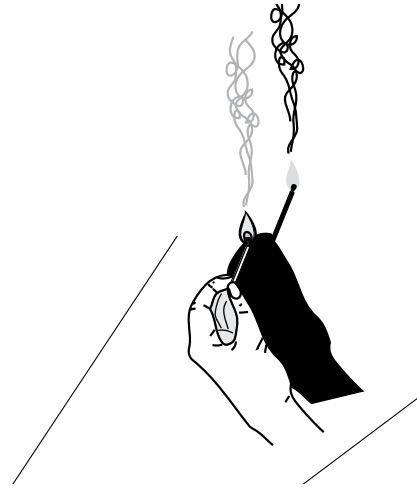

Procedure:

1. Darken the room and turn on the projector.
2. While standing in the projector beam, strike a match. Observe the shadows on the screen that are created by the smoke released by the combustion process.
3. Smack two dusty chalk erasers together and observe the shadows caused by the chalk dust.
4. Turn off the projector and turn on the flashlight. Stand against a dark background and stir up more chalk dust by slapping erasers together. Shine the flashlight's beam on the dust before it settles. Observe the brightness of the dust particles that are in the beam.

Discussion:

Dust and dirt in the atmosphere darken the sky during the daytime. These *particulates* come from both human and natural activities. Exhaust from internal combustion engines makes carbon monoxide gas, nitrogen oxide gas, and carbon (soot) particles. Industrial and home heating and forest fires, such as slash and burn agriculture, also contribute to the dust and dirt in the sky. Natural processes, like lightning-caused forest fires

and volcanic eruptions, add large amounts of dust and ash to the air. All these extra particles in the air not only filter out sunlight, causing redder sunsets and sunrises, but also increase "light pollution." Street, residential, and industrial night lighting reflect off particles and water vapor in the atmosphere to prevent the night sky from being really dark. However, many urban areas have begun to choose street lighting that interferes less with astronomical observations. Because of light pollution, observatories are usually located as far from urban areas as possible. Survey teams spend several months on candidate mountain tops observing weather patterns. They study particulates, wind, humidity, and temperature extensively before committing to the construction of an observatory.

For Further Research:

- Check reference books to learn about the effects of volcanic eruptions on the clarity of Earth's atmosphere.
- How could street light fixtures be modified to reduce light pollution?

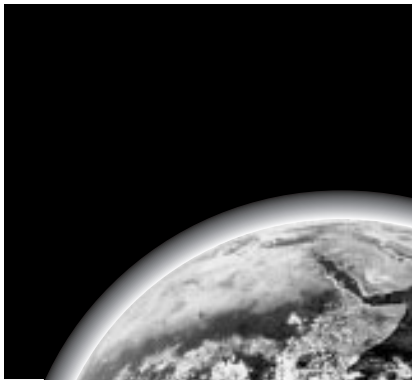

Particulate Sampler

Description: A simple adhesive sampler is taken home by each student to estimate the extent of particulate air pollution present in their neighborhoods.

Objective: To obtain a quantitative measurement of the particulate pollution present in the neighborhood of the students and school.

Materials:

- Clear contact paper (14 centimeters square)
- Graph paper (reproduce copies of the graph paper provided with the activity)
- Cardboard or 1/4 inch plywood (40 centimeters square)
- Cellophane tape
- Magnifying glass
- Dice

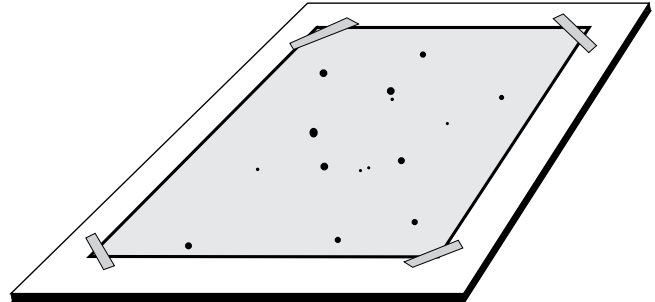

Procedure:

1. Tape the graph paper to the center of the cardboard. Tape the contact paper on top of the graph paper with sticky side up. Keep the protective backing on the contact paper.
2. Place the pollution sampler outside on a flat surface, preferably a meter or two above the ground. You may have to anchor the sampler if the air is windy. Remove the protective backing. Make sure the contact paper is firmly taped down on the cardboard.
3. After exposing the sampler to the outside for twenty-four hours, place the graph paper over the collecting surface, grid side down, and return the sampler to school.*
4. Remove sampler from the cardboard and observe the particles from the back side of the clear Contact Paper. Using the magnifier, count the number of particles found in each of ten randomly selected squares on the graph paper grid. Select
5. Compare the average particle counts to the locations where the collectors were placed (proximity to farms, factories, freeways, etc.). Add the average particle count for all samplers together and divide by the total number of collectors to obtain a regional average for the two-centimeter square. Using this average, calculate the total number of particles for one square kilometer of area centering on the school. What would the count be for ten square kilometers?

* Depending upon local conditions, a longer sampling period may be required.

Discussion:

Even on a clear night, many small particles are present in the atmosphere. Dust particles are lofted into the air by wind and other particles are produced as combustion products from cars, fire places, industry,

volcanic eruptions, and a variety of other sources including meteorites and comets. Every day, about 100 tons of meteorite and comet dust falls to Earth from space. Overall, dust particles scatter some of the light that comes through the atmosphere from space. **Note:** Due to wide variations in air quality, it is recommended that this experiment be pre-tested in the school neighborhood to learn how long to expose the sampler. The time period may have to be extended to several days to show measureable results. Although the collector will probably collect particles of extraterrestrial origin, telling which particles

are extraterrestrial will require analytical techniques beyond the scope of this guide.

For Further Research:

- Contact your local air pollution authority or the U.S. Environmental Protection Agency for additional information about the air quality in your community.

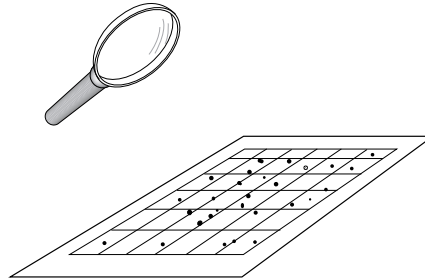

Completed particulate sampler. The grid has been placed over the sticky side of the contact paper.

Particulate Sampler Grid

	1	2	3	4	5	6
1						
2						
3						
4						
5						
6						

Each square is two centimeters on a side.

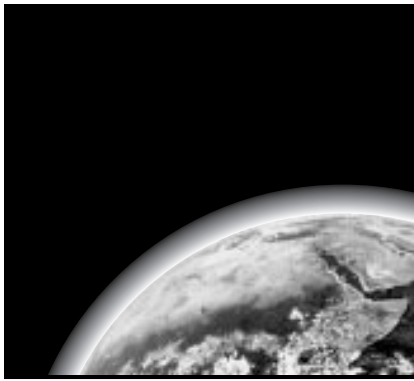

Heat Currents

Description: Twinkling starlight is simulated by placing a heat source in the beam of a slide projector.

Objective: To show how visible light appears to shimmer, when seen through rising heat currents.

Materials:

Food warmer fuel (e.g. Sterno) or hotplate
Matches (if using fuel)
Slide projector
"Star" slide (See instructions below.)
35 mm slide frame
Aluminum foil
Pin
Scissors
Projection screen
Dark room

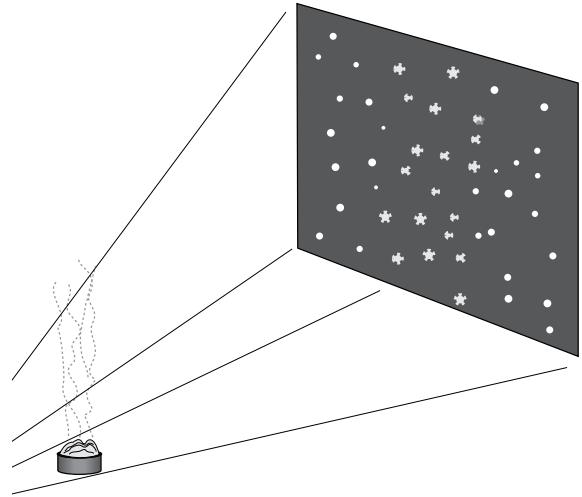

3. Stand back and observe the optical effects on the screen.

Procedure: Making a Star Slide

1. Obtain a 35 mm slide mount from a camera store.
2. Cut a small square of aluminum foil to fit the slide frame.
3. Using the pin, make about 20 or 30 pin prick holes in the foil. The slide is ready to be used. **Note:** An overhead projector can also be used. Make the aluminum foil slide large enough to cover the projector stage.

Procedure: Heat Currents

1. Darken the room and turn on the projector with the star slide. Observe the appearance of the stars.
2. Light the food warmer fuel can and place it near the projector lens between the projector and the screen.

Caution: The alcohol fuel in the warmer can is ideal for this activity because it produces heat with little light. Be careful when handling the can in the darkness.

Discussion:

Heat currents in the atmosphere cause the twinkling of starlight. Light rays from stars are refracted or bent as they pass through cells (masses) of warm, less dense air into cells of cooler, more dense air. This causes the path of the light rays to bend slightly many times each second, producing the twinkling effect. Heat currents cause focusing problems for astronomical telescopes used for photography; the star images dance around on the film and create fuzzy disks. The use of image-sensing and computer processing can negate the twinkling effect somewhat, but the best way to minimize the problem is to place telescopes at high altitudes, such as on mountain tops, or in orbit above Earth's atmosphere.

For Further Research:

- Observe the effects of heat currents rising from asphalt on hot summer days or from hot water radiators on winter days.

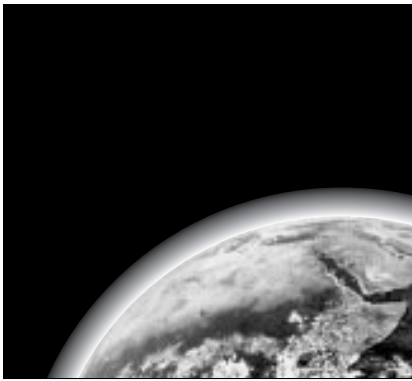

Day and Night

Description: A bright light bulb simulates the effect that scattered sunlight has on astronomical observations in the visible region of the electromagnetic spectrum.

Objective: To demonstrate the effects of day and night cycles on astronomical observations.

Materials:

Projector
"Star" slide (See Heat Currents activity.)
150 or 200 watt light bulb and uncovered light fixture
Projection screen
Dark room

Procedure:

1. Place the light bulb and fixture near the projection screen.
2. Turn out the room lights and project the star slide on to the screen.
3. When everyone's eyes adjust to the dark light, turn on the light bulb.
4. Observe what happens to the star images on the screen.

Discussion

In this demonstration, the light bulb represents the Sun. Turning on the bulb causes many of the star images on the screen to disappear. Images toward the outside of the screen will probably still be visible. **Note:** You can also do this demonstration by simply turning on the room lights. Using a bright light bulb, however, more closely simulates what happens in the sky.

This demonstration shows that stars do not go away during the daylight. Instead, light from the Sun is scattered by the gas molecules, water, and dust particles in our atmosphere. This scattered light masks the far dimmer light of stars more distant than our Sun.

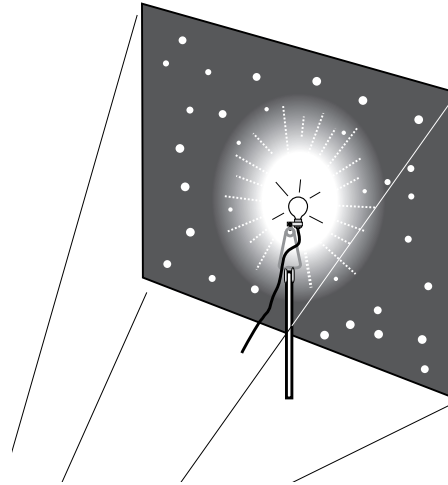

Day/night cycles greatly reduce the observing time available to astronomers employing optical telescopes based on Earth. Furthermore, on nights when the Moon is full or near full, the Moon's scattered light greatly interferes with the quality of pictures terrestrial telescopes can gather. You can simulate the Moon's effect on nighttime observation with a dimmer switch set to a low setting.

For Further Research:

- Are there any regions of the electromagnetic spectrum that are not affected by day/night cycles?
- Compare the number of stars visible on a clear moonless night with the number visible when the Moon is full. One way to do this would be to hold up a hoop, such as an embroidery hoop, at arms length in the direction of a familiar constellation. Count the stars visible in this location on a moonless night and on a night when the Moon is full.

Unit 2

The Electromagnetic Spectrum

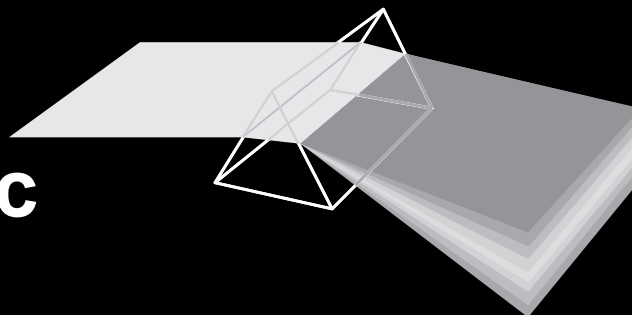

Introduction

Contrary to popular belief, outer space is not empty. It is filled with electromagnetic radiation that crisscrosses the universe. This radiation comprises the spectrum of energy ranging from radio waves on one end to gamma rays on the other. It is called the *electromagnetic spectrum* because this radiation is associated with electric and magnetic fields that transfer energy as they travel through space. Because humans can see it, the most familiar part of the electromagnetic spectrum is visible light—red, orange, yellow, green, blue, and violet.

Like expanding ripples in a pond after a pebble has been tossed in, electromagnetic radiation travels across space in the form of waves. These waves travel at the *speed of light*—300,000 kilometers per second. Their wavelengths, the distance from wave crest to wave crest, vary from thousands of kilometers across, in the case of the longest radio waves, to smaller than the diameter of an atom, in the cases of the smallest x-rays and gamma rays.

Electromagnetic radiation has properties of both waves and particles. What we detect depends on the method we use to study it. The beautiful colors that appear in a soap film or in the dispersion of light from a diamond are best described as waves. The light that strikes a solar cell to produce an

electric current is best described as a particle. When described as particles, individual packets of electromagnetic energy are called *photons*. The amount of energy a photon of light contains depends upon its wavelength. Electromagnetic radiation with long wavelengths contains little energy. Electromagnetic radiation with short wavelengths contains a great amount of energy.

Scientists name the different regions of the electromagnetic spectrum according to their wavelengths. (See figure 1.) *Radio waves* have the longest wavelengths, ranging from a few centimeters from crest to crest to thousands of kilometers. *Microwaves* range from a few centimeters to about 0.1 cm. *Infrared* radiation falls between 700 nanometers and 0.1 cm. (Nano means one billionth. Thus 700 nanometers is a distance equal to 700 billionths or 7×10^{-7} meter.) *Visible light* is a very narrow band of radiation ranging from 400 to 700 nanometers. For comparison, the thickness of a sheet of household plastic wrap could contain about 50 visible light waves arranged end to end. Below visible light is the slightly broader band of *ultraviolet light* that lies between 10 and 300 nanometers. *X-rays* follow ultraviolet light and diminish into the hundred-billionth of a meter range. *Gamma rays* fall in the trillionth of a meter range.

The wavelengths of x-rays and gamma rays

Ångstroms and Nanometers

Astronomers still use an old unit of measurement for the wavelengths of electromagnetic radiation. The unit is the angstrom, or Å, named after the Swedish astronomer who first named these wavelengths. One nanometer is equal to 10 angstroms. Therefore, green light has a wavelength of about 5000 Å, 500 nanometers, or 5×10^{-7} meters.

are so tiny that scientists use another unit, the *electron volt*, to describe them. This is the energy that an electron gains when it falls through a potential difference, or voltage, of one volt. It works out that one electron volt has a wavelength of about 0.0001 centimeters. X-rays range from 100 electron volts (100 eV) to thousands of electron volts. Gamma rays range from thousands of electron volts to billions of electron volts.

Using The Electromagnetic Spectrum

All objects in space are very distant and difficult for humans to visit. Only the Moon has been visited so far. Instead of visiting

stars and planets, astronomers collect electromagnetic radiation from them using a variety of tools. Radio dishes capture radio signals from space. Big telescopes on Earth gather visible and infrared light. Interplanetary spacecraft have traveled to all the planets in our solar system except Pluto and have landed on two. No spacecraft has ever brought back planetary material for study. They send back all their information by radio waves.

Virtually everything astronomers have learned about the universe beyond Earth depends on the information contained in the electromagnetic radiation that has traveled to Earth. For example, when a star explodes as in a supernova, it emits energy in all wavelengths of the electromagnetic spectrum. The most famous supernova is the stellar explosion that became visible in 1054 and produced the Crab Nebula. Electromagnetic radiation from radio to gamma rays has been detected from this object, and each section of the spectrum tells a different piece of the story.

For most of history, humans used only visible light to explore the skies. With basic tools and the human eye, we developed sophisticated methods of time keeping and

Figure 1. Electromagnetic Spectrum

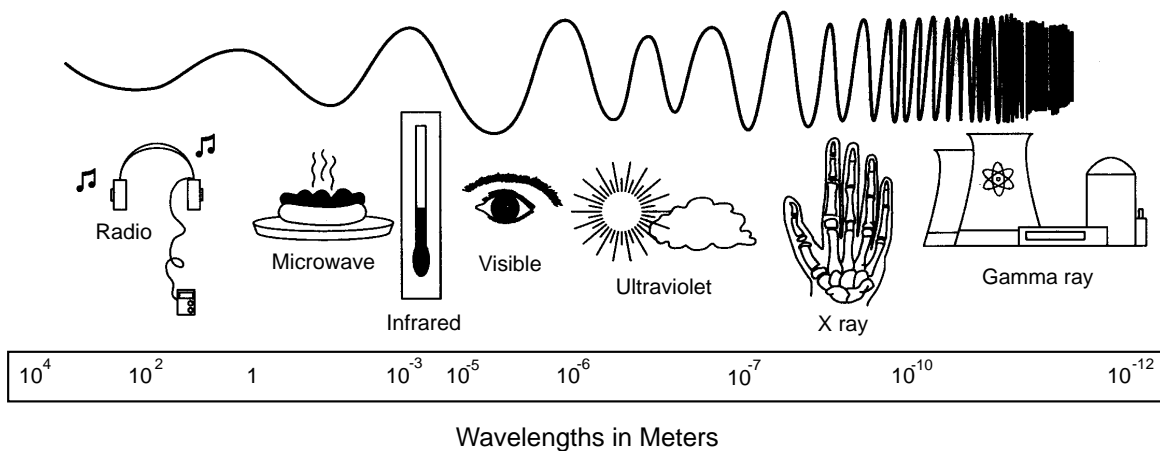
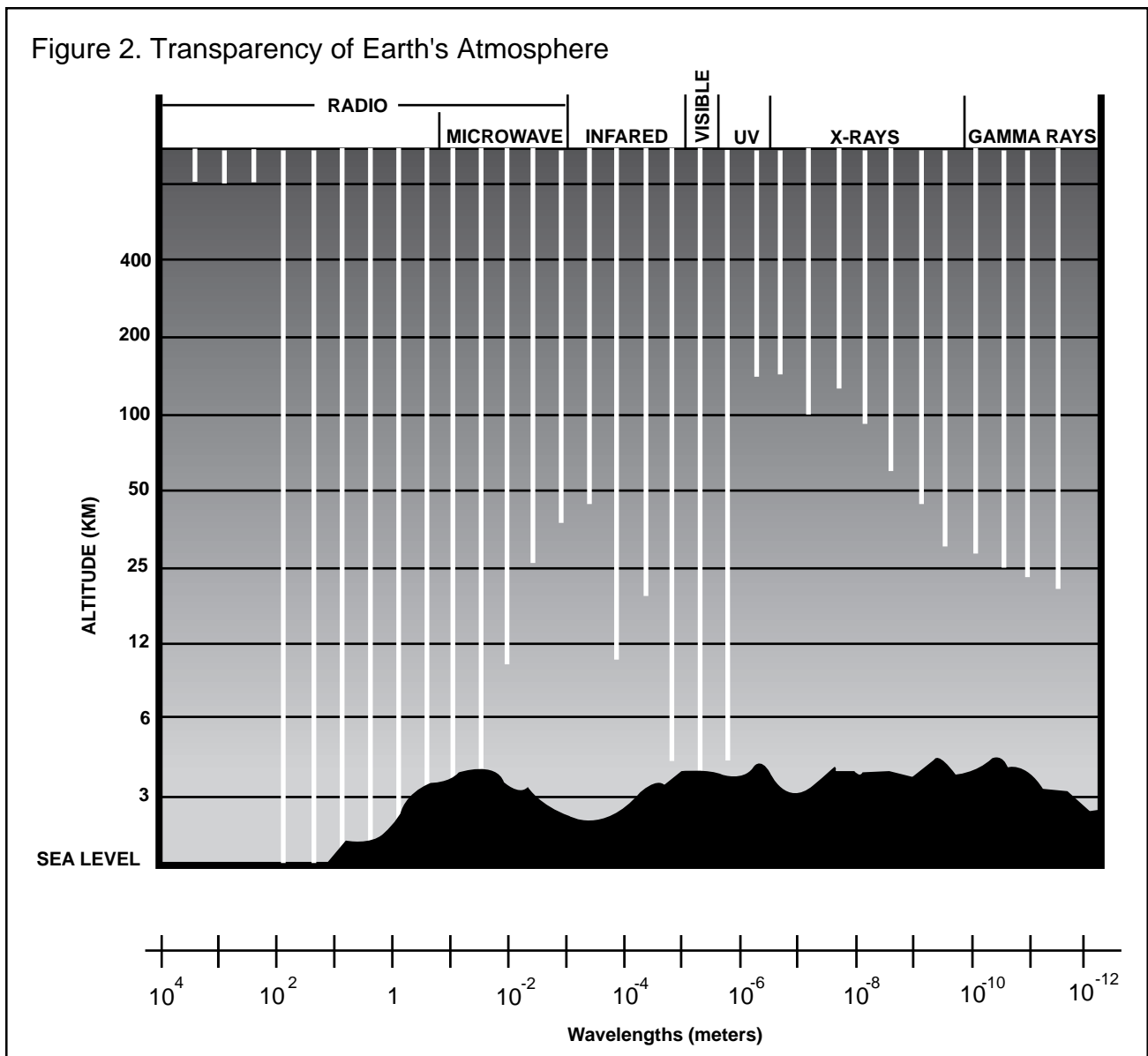

Figure 2. Transparency of Earth's Atmosphere



calendars. Telescopes were invented in the 17th century. Astronomers then mapped the sky in greater detail—still with visible light. They learned about the temperature, constituents, distribution, and the motions of stars.

In the 20th century, scientists began to explore the other regions of the spectrum. Each region provided new evidence about the universe. Radio waves tell scientists about many things: the distribution of gases in our Milky Way Galaxy, the power in the great jets of material spewing from the centers of some other galaxies, and details about magnetic fields in space. The first

radio astronomers unexpectedly found cool hydrogen gas distributed throughout the Milky Way. Hydrogen atoms are the building blocks for all matter. The remnant radiation from the Big Bang, the beginning of the universe, shows up in the microwave spectrum.

Infrared studies (also radio studies) tell us about molecules in space. For example, an infrared search reveals huge clouds of formaldehyde in space, each more than a million times more massive than the Sun. Some ultraviolet light comes from powerful galaxies very far away. Astronomers have yet to understand the highly energetic

engines in the centers of these strange objects.

Ultraviolet light studies have mapped the hot gas near our Sun (within about 50 light years). The high energy end of the spectrum—x-rays and gamma rays—provide scientists with information about processes they cannot reproduce here on Earth because they lack the required power. So nuclear physicists use strange stars and galaxies as a laboratory. These objects are pulsars, neutron stars, black holes, and active galaxies. Their study helps scientists better understand the behavior of matter at extremely high densities and temperatures in the presence of intense electric and magnetic fields.

Each region of the electromagnetic spectrum provides a piece of the puzzle. Using more than one region of the electromagnetic spectrum at a time gives scientists a more complete picture. For example, relatively cool objects, such as star-forming clouds of gas and dust, show up best in the radio and infrared spectral region. Hotter objects, such as stars, emit most of their energy at visible and ultraviolet wavelengths. The most energetic objects, such as supernova explosions, radiate intensely in the x-ray and gamma ray regions.

There are two main techniques for analyzing starlight. One is called *spectroscopy* and the other *photometry*. Spectroscopy spreads out the light into a spectrum for study. Photometry measures the quantity of light in specific wavelengths or by combining all wavelengths. Astronomers use many filters in their work. Filters help astronomers analyze particular components of the spectrum. For example, a red filter blocks out all visible light wavelengths except those that fall around 600 nanometers.

Unfortunately for astronomical research, Earth's atmosphere acts as a filter to block most wavelengths in the electromagnetic spectrum. (See Unit 1.) Only small portions of the spectrum actually reach the surface. (See figure 2.) More pieces of the puzzle are gathered by putting observatories at high altitudes (on mountain tops) where the air is thin and dry, and by flying instruments on planes and balloons. By far the best viewing location is outer space.

Unit Goals

- To investigate the visible light spectrum and the near infrared and ultraviolet spectral regions.
- To demonstrate the relationship between energy and wavelength in the electromagnetic spectrum.

Teaching Strategy

Because of the complex apparatus required to study some of the wavelengths of the electromagnetic spectrum, the visible light spectrum will be studied in the activities that follow. Several different methods for displaying the visible spectrum will be presented. Some of the demonstrations will involve sunlight, but a flood or spotlight may be substituted. For best results, some of these activities should be conducted in a room where there is good control of light.

Activity Titles

Water Prism

Activity Objective: To display the colors of the visible spectrum contained in sunlight.
Application: Art, Astronomy, Physical Science

Projecting Spectra

Activity Objective: To study the range of color hues in the visible spectrum.
Application: Art, Astronomy, Physical Science

Simple Spectroscope

Activity Objective: To construct a simple spectroscope with a diffraction grating.
Application: Astronomy, Physical Science

Analytical Spectroscope

Activity Objective: To construct an analytical spectroscope to analyze the spectrum produced when various substances are heated or excited with electricity.
Application: Astronomy, Chemistry, Physical Science

Red Shift, Blue Shift

Activity Objective: To demonstrate how stellar spectra can be used to measure a star's motion relative to Earth along the line of sight.
Application: Astronomy, Chemistry, Mathematics, Physical Science

Wavelength and Energy

Activity Objective: To demonstrate the relationship between wavelength, frequency, and energy in the electromagnetic spectrum.
Application: Astronomy, Mathematics, Physical Science

Resonance Rings

Activity Objective: To show how atoms and molecules in Earth's atmosphere absorb energy through resonance.
Application: Astronomy, Environmental Science, Meteorology, Physical Science

Water Prism

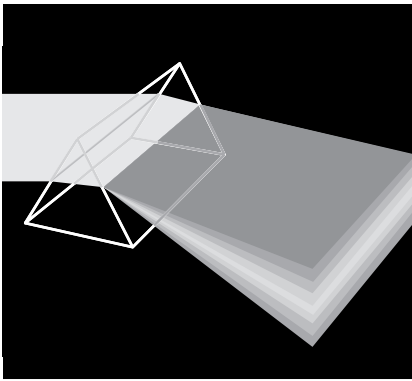

Description: Five glass panes are cemented together and filled with water to form a water prism that disperses sunlight into its rainbow of colors.

Objective: To display the colors of the visible spectrum contained in sunlight.

Materials:

Glass panes (five) 15x25 cm in size
Silicone cement (clear)
Emery paper (fine)
Cellophane tape
Water

Procedure:

1. Obtain the glass panes at a hardware or window store. Have them cut to size.
2. Use the emery paper to smooth out the glass edges to avoid cutting fingers during handling. (This can be done at the hardware store.)
3. Temporarily assemble the glass panes as shown in the diagram with cellophane tape. Glue the glass panes together by smearing each inside joint with silicone cement. This is how aquariums are made.
4. After the cement dries, remove the tape and fill the water prism with water. Check for leaks. If leaks are present, empty the water and dry the inside. Cement the leaks and allow the cement to dry.
5. Set the water prism in a window with a sunlit exposure. Cover the prism with the fifth pane to help keep the water clean. Sunlight will enter the prism and be dispersed into its rainbow colors. Observe the colors that appear on the floor or wall.

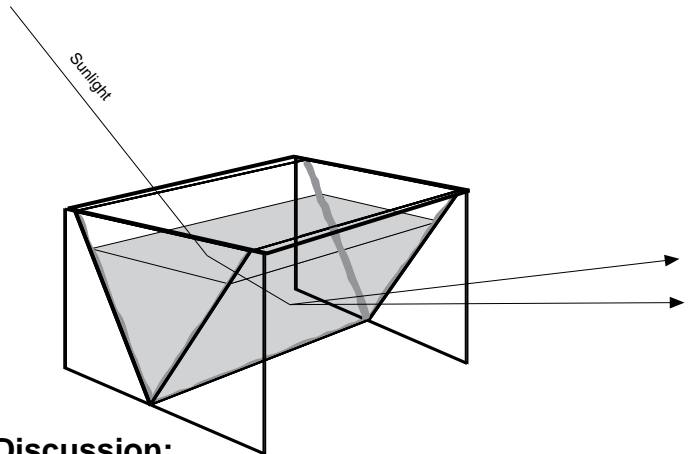

Discussion:

The water in the water prism bends sunlight the same way glass does in a glass prism. Sunlight, entering the prism, is bent (refracted). Visible light rays (like sunlight) bend according to their wavelengths. Shorter wavelengths are bent more than longer wavelengths. This variable bending of the light causes its dispersion into the colors of red, orange, yellow, green, blue, and violet.

The water prism is a good starting point for capturing student interest in the electromagnetic spectrum. Not only will it disperse a broad swath of color across a classroom when sunlight enters it at the proper angle, it is also interesting to look through. The water prism disperses narrow bands of color along the edges of dark objects.

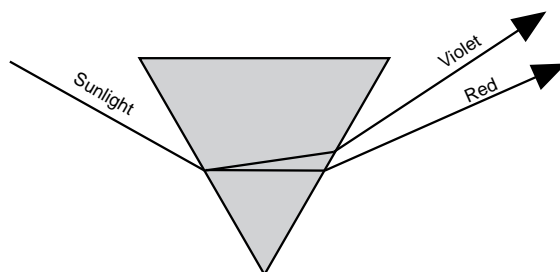

Notes:

- Because the altitude of the Sun over the horizon changes daily, the water prism will work better at some times of the year than others. Sunlight will enter the prism directly in the winter when the Sun angle is low in the sky. In the summer, the Sun angle is very high and its light may not enter the prism at the proper angle for dispersion to take place. This problem can be corrected by using a mirror to reflect the light at the proper angle.
- Commercial versions of water prisms are available from science-supply catalogs.

For Further Research:

- What scientist first used the light dispersing properties of the prism to analyze visible light and color?
- Compare the light dispersion of a glass or plastic prism to the water prism.
- A simpler water prism can be made with a shallow pan of water and a pocket mirror. Refer to the diagram below for set up guidance.
- Learn about rainbows. How is sunlight dispersed by water droplets? What other human-made and natural things disperse sunlight?

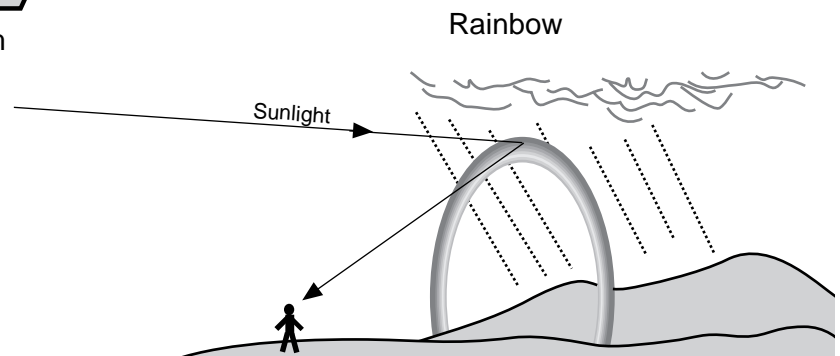
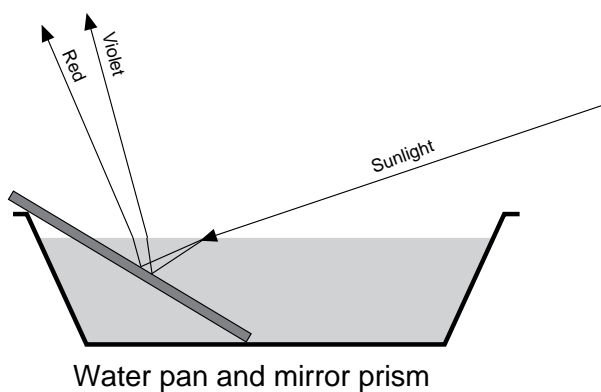
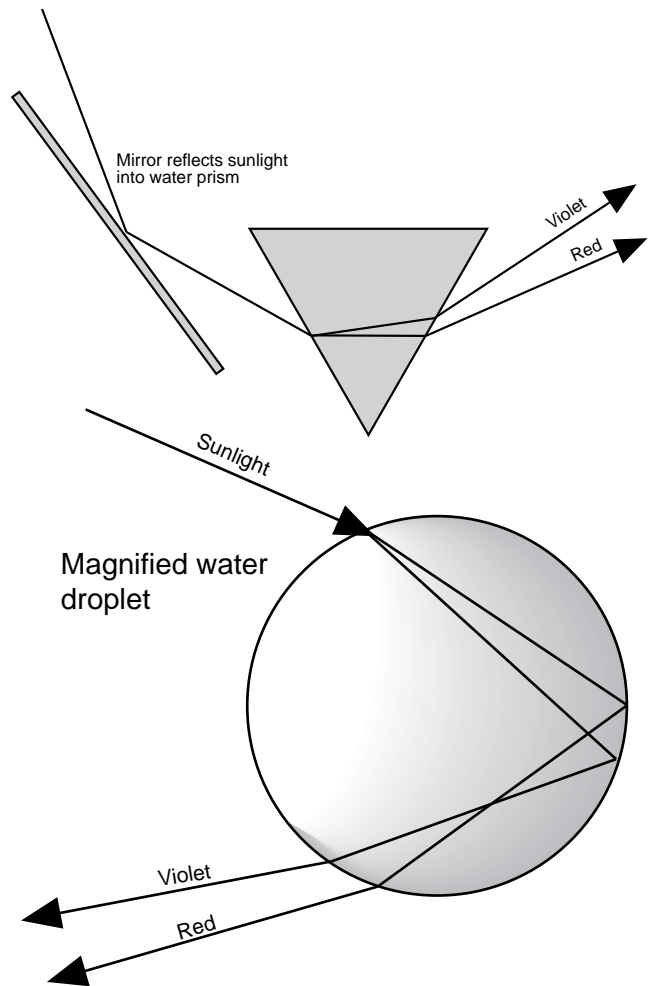

Projecting Spectra

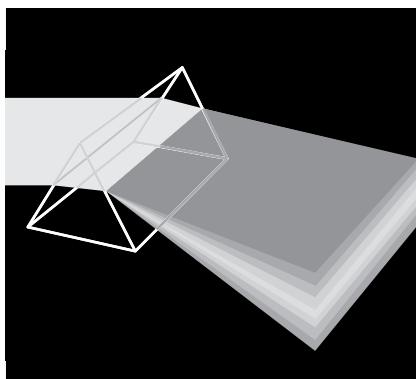

Description: Two methods for projecting the visible spectrum are explained.

Objective: To study the range of colors in the visible spectrum.

Materials:

Method 1

Slide projector
Opaque screen (See instructions.)
Glass prism
Several books
Projection screen

Method 2

Overhead projector
Holographic diffraction grating
(See next page for sources.)
Opaque screen (See instructions.)
Several books
Tape
Projection screen

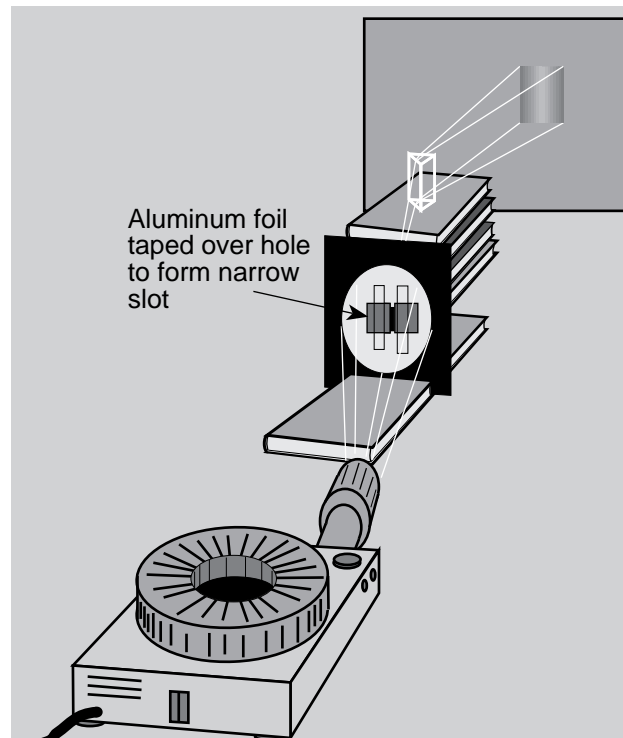

Procedure: Method 1

1. Make an opaque screen approximately 25 cm square from a piece of cardboard, poster board, or wood. Cut a 5 cm-diameter hole out of the middle. Tape two pieces of opaque paper or aluminum foil over the hole so that there is a vertical gap between them that is no wider than 1 mm. Stand the screen upright between two books.
2. Arrange the slide projector, opaque screen, prism, and projection screen as shown in the diagram. Darken the room. Aim the projector's beam at the slot in the opaque screen and adjust the projector so that the light does not extend around the edges of the opaque screen.
3. Slowly rotate the prism until the narrow slot of light disperses the visible

spectrum. Depending upon the exact alignment, the spectrum may fall on a wall rather than on the screen. Adjust the setup so that the spectrum is displayed on the projection screen.

Procedure: Method 2.

1. For this method, you must obtain a piece of holographic diffraction grating — a grating produced by accurate holographic techniques. See page 31 for the source of the grating. **Note:** Method 2 will not work well with a standard transmission grating.
2. Make an opaque screen from two pieces of dark paper or other opaque material. Place the pieces on the overhead projector stage so that there is a narrow slot no wider than 2 mm where light can come through.

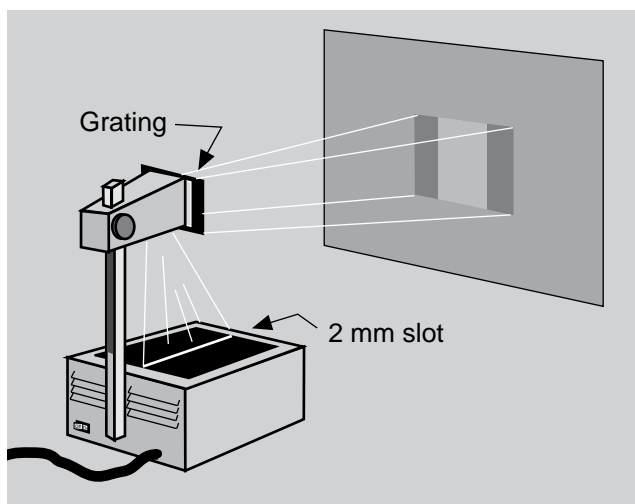

of visible light are bent different amounts and this causes them to be dispersed into a continuum of colors. (See diagram.)

Diffraction gratings also disperse light. There are two main kinds of gratings. One transmits light directly. The other is a mirror-like reflection grating. In either case, diffraction gratings have thousands of tiny lines cut into their surfaces. In both kinds of gratings, the visible colors are created by constructive and destructive interference. Additional information on how diffraction gratings work is found in the Analytical Spectroscope activity and in many physics and physical science textbooks.

3. Darken the room and turn on the projector. Using tape, hang a piece of holographic diffraction grating over the upper lens of the projector. Before taping, rotate the grating until the best spectra is displayed. Two brilliant visible spectra appear on opposite sides of a line running from the projector perpendicular to the screen. The size of the display can be changed by moving the projector closer or farther away from the screen. Refer to the Analytical Spectroscope activity for more information on how the diffraction grating works.

For Further Research:

- Use crayons or colored pencils to sketch the spectra displayed by either projection method. What colors are visible?
- Who discovered the visible spectrum? How many colors did the scientist see?
- A compact audio disk acts like a reflection diffraction grating. Darken the room and shine a strong beam of white light from a flashlight on the disk. The beam will be dispersed by the grating and be visible on a wall.

Discussion:

Visible light, passing through a prism at a suitable angle, is dispersed into its component colors. This happens because of *refraction*. When visible light waves cross an interface between two media of different densities (such as from air into glass) at an angle other than 90 degrees, the light waves are bent (refracted). Different wavelengths

Sources:

Holographic diffraction gratings are available from:

Arbor Scientific
P.O. Box 2750
Ann Arbor, MI 48106-2750
Phone: 1-800-367-6695

Flinn Scientific
P.O. Box 219
131 Flinn Street
Batavia, IL 60510
Phone: 1-800-452-1261

Learning Technologies, Inc.
59 Walden Street
Cambridge, MA 02140
Phone: 1-800-537-8703.

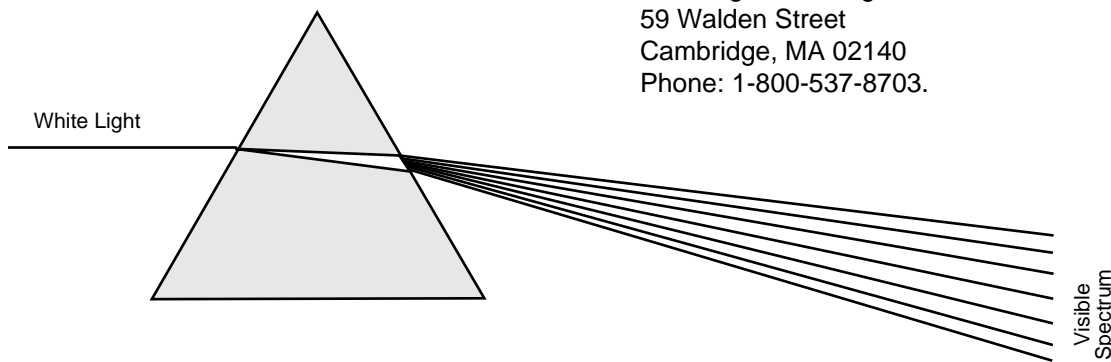

Simple Spectroscope

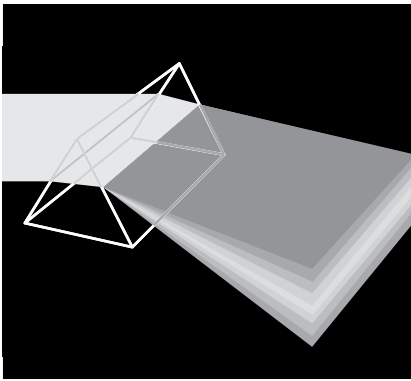

Description: A basic hand-held spectroscope is made from a diffraction grating and a paper tube.

Objective: To construct a simple spectroscope with a diffraction grating.

Materials:

Diffraction grating 2 cm square
(See note.)*
Paper tube (tube from toilet paper roll)*
Poster board square (5x10cm)*
Masking tape
Scissors
Razor blade knife
2 single edge razor blades
Spectrum tubes and power supply
(See note.)
Pencil

* per spectroscope

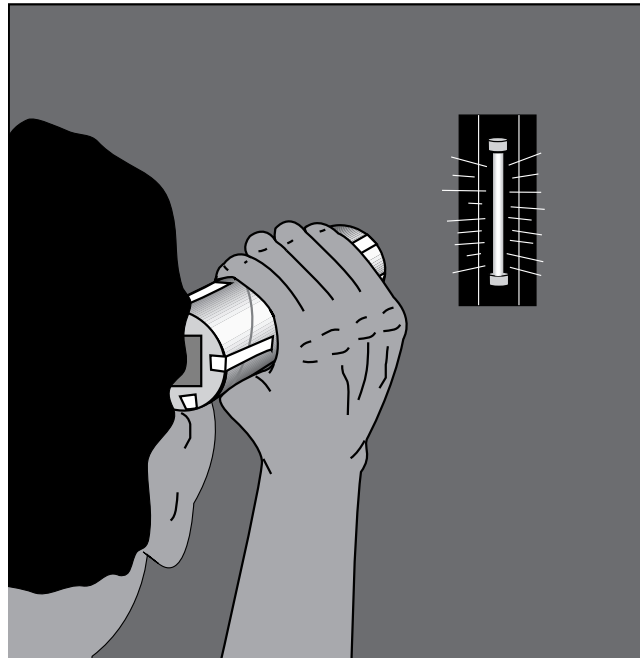

Procedure:

1. Using the pencil, trace around the end of the paper tube on the poster board. Make two circles and cut them out. The circles should be just larger than the tube's opening.
2. Cut a 2 centimeter square hole in the center of one circle. Tape the diffraction grating square over the hole. If students are making their own spectroscopes, it may be better if an adult cuts the squares and the slot in step 4 below.
3. Tape the circle with the grating inward to one end of the tube.
4. Make a slot cutter tool by taping two single edge razor blades together with a piece of poster board between. Use the tool to make parallel cuts about 2 centimeters long across the middle of the
- second circle. Use the razor blade knife to cut across the ends of the cuts to form a narrow slot across the middle of the circle.
5. Place the circle with the slot against the other end of the tube. While holding it in place, observe a light source such as a fluorescent tube. Be sure to look through the grating end of the spectroscope. The spectrum will appear off to the side from the slot. Rotate the circle with the slot until the spectrum is as wide as possible. Tape the circle to the end of the tube in this position. The spectroscope is complete.
6. Examine various light sources with the spectroscope. If possible examine nighttime street lighting. Use particular

caution when examining sunlight; **do not look directly into the Sun.**

Discussion:

Refer to the discussion on Analytical Spectroscopes for information on how diffraction gratings produce spectra.

Glass prisms are heavy. The more separation one wants for the wavelengths, the thicker the glass needs to be. Grating spectroscopes can do the same job but are much lighter. A diffraction grating can spread out the spectrum more than a prism can. This ability is called dispersion. Because gratings are smaller and lighter, they are well suited for spacecraft where size and weight are important considerations. Most research telescopes have some kind of grating *spectrograph* attached. Spectrographs are spectroscopes that provide a record, photographic or digital, of the spectrum observed.

Notes:

- Most science supply houses sell diffraction grating material in sheets or rolls. One sheet is usually enough for every student in a class to have a piece of grating to build his or her own spectroscope. Holographic diffraction gratings work best for this activity. Refer to the note on sources in the previous activity.
- Many light sources can be used for this activity, including fluorescent and incandescent lights and spectra tubes with power supplies. Spectra tubes and the power supplies to run them are expensive. It may be possible to borrow tubes and supplies from another school if your school does not have them. The advantage of spectrum tubes is that they provide spectra from different gases such as hydrogen and helium.

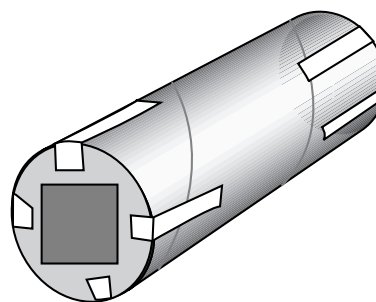
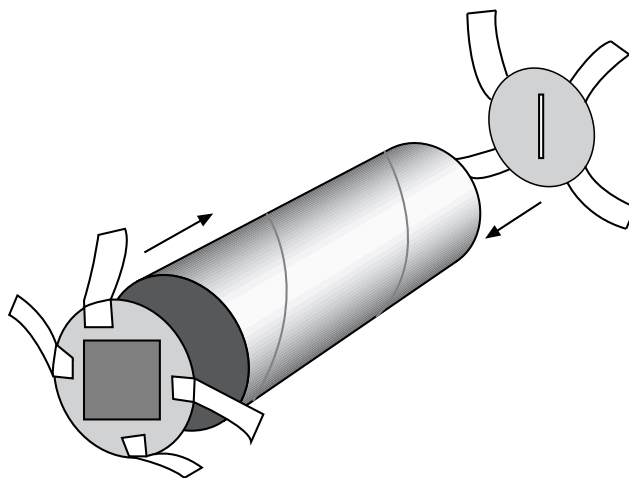

For Further Research:

- Using colored pencils or crayons, make sketches of the spectrum emitted by different light sources. Try incandescent and fluorescent lamps, bug lights, street lights (mercury, low-pressure sodium, and high-pressure sodium), neon signs, and candle flames. How do these spectra differ?
- How do astronomers measure the spectra of objects in space? What do those spectra tell us about these objects?
- Relate this activity to the Analytical Spectroscope activity that follows (page 34).

Analytical Spectroscope

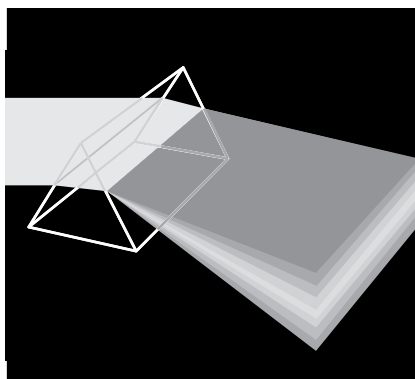

Description: A spectroscope is constructed that permits the analysis of visible light.

Objective: To construct an analytical spectroscope to analyze the spectrum produced when various substances are heated or excited with electricity.

Materials:

Heavy poster board (any color, but the inside surface should be dark)
Holographic diffraction grating (See the Projecting Spectra activity for the source.)
Aluminum foil
Patterns (See pages 38 and 39.)
Pencil
Black tape
Scissors
Razor blade knife
Straight edge
Cutting surface
Spectrum tubes and power supply (See the discussion section for source.)

Procedure:

1. Cut out the patterns for the spectroscope housing. Trace them on to the heavy poster board. The patterns should be arranged like the sample shown on page 39.
2. Cut out the housing from the poster board. Lightly score the fold lines with the razor blade knife. (If you should cut all the way through, just tape the pieces together.)
3. Fold the housing to look like a pie shaped-box and tape the corresponding edges together.
4. Using the razor blade knife, straight edge, and cutting

- surface, cut out the slit adjustment and measurement scale rectangles from the front end piece. Also cut out the small square for the diffraction grating holder.
5. Cut a piece of diffraction grating large enough to cover the hole in the eyepiece rectangle. Handle the grating by the edges if possible; skin oils will damage it. Look at a fluorescent light through the grating. Turn the grating so that the rainbow colors you see appear in fat vertical bars to the right and left of the light. Tape the grating to the back side of the eyepiece rectangle in this same orientation. Refer to the pattern page for more information on the alignment of the grating.
6. Tape the eyepiece rectangle to the narrow end of the spectroscope housing.
7. Cut out the black measurement grid from the paper. Tape this grid to the inside of the narrow rectangle cut out in step 4. Carefully align the grid with the hole so that when you hold the front end piece to the light, the grid will be illuminated by the

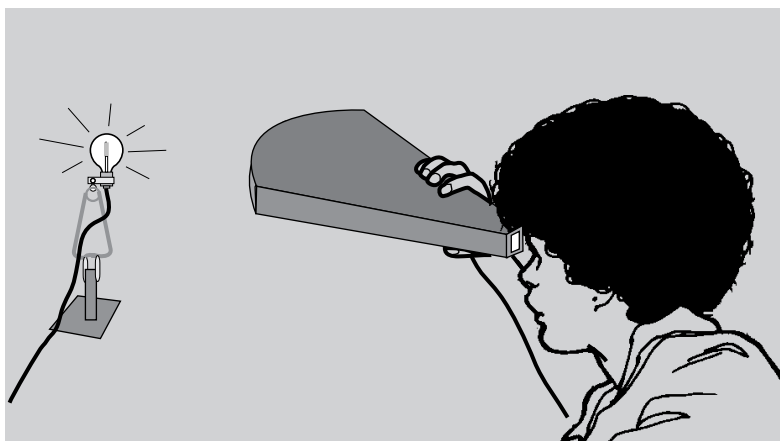

light passing through the paper. Trim any excess tape.

8. Tape the front end panel to the wide opening of the spectroscope housing. Make sure the seams are closed so that no light escapes through them.
9. The final step in making the spectroscope is to close off the other open rectangle except for a very narrow vertical slot. The slit can be cut from aluminum foil. It should be about one millimeter wide. Use a razor knife to make this cut. Any roughness in the cut will show up as dark streaks in the spectrum perpendicular to the slot. Cover the open rectangle on the front piece with the foil. The slit should be vertical. Temporarily hold the paper in place with tape.

Calibrating the Spectroscope:

1. To obtain accurate wavelength readings with the spectroscope, it must be calibrated. This is accomplished by looking at a standard fluorescent light (Do not use a broad-spectrum fluorescent light.)
2. Lift the tape holding the slit and move the slit to the right or left until the bright green line in the display is located at 546 nanometers. Retape the slit in place. The spectroscope is calibrated.

Discussion:

Unlike a prism, which disperses white light into the rainbow colors through refraction, the diffraction grating used in this spectroscope disperses white light through a process called *interference*. The grating used in this activity consists of a transparent piece of plastic with many thousands of microscopic parallel grooves. Light passing between these grooves is dispersed into its component wavelengths and appears as parallel bands of color on the retina of the eye of the observer.

Spectroscopes are important tools for astronomy. They enable astronomers to analyze starlight by providing a measure of

the relative amounts of red and blue light a star gives out. Knowing this, astronomers can determine the star's temperature. They also can deduce its chemical composition, estimate its size, and even measure its motion toward or away from Earth (See the activity Red Shift, Blue Shift.)

Starlight (photons) originates from the interior of a star. There, pressures are enormous and nuclear fusion is triggered. Intense radiation is produced as atoms, consisting of a nucleus surrounded by one or more electrons, collide with each other millions of times each second. The number of collisions depends upon the temperature of the gas. The higher the temperature, the greater the rate of collisions.

Because of these collisions, many electrons are boosted to higher energy levels, a process called *excitation*. The electrons spontaneously drop back to their original energy level. In doing so, they release energy as photons. This is what happens to the filament of an electric light bulb or to an iron bar when it is heated in a furnace. As the temperature of the filament rises, it begins to radiate reddish light. When the filament becomes much hotter, it radiates bluish light. Thus, the color it radiates is an indicator of the filament's temperature. Stars that radiate a great amount of red light are much cooler than stars that radiate a great amount of blue light. Stellar spectra therefore serve as star thermometers.

Excitation of electrons can also occur if they absorb a photon of the right wavelength. This is what happens when certain materials are exposed to ultraviolet light. These materials then release new photons at different wavelengths. This is called fluorescence.

One of the important applications of spectroscopes is their use for identifying chemical elements. Each element radiates light in specific wavelength combinations that are as distinctive as fingerprints. Knowing the

"spectral signatures" of each element enables astronomers to identify the elements present in distant stars by analyzing their spectra.

There are three kinds of spectra: continuous, absorption, and emission. The *continuous spectrum* appears as a continuous band of color ranging from red to violet when observed through a spectroscope. An *absorption spectrum* occurs when the light from a star passes through a cloud of gas, hydrogen for example, before reaching the spectroscope. As a result, some wavelengths of light are absorbed by the hydrogen atoms. This selective absorption produces a spectrum that is a broad band of color interrupted by dark lines representing certain wavelengths of light that were absorbed by the hydrogen cloud. Such a situation occurs when a star is located inside or behind a gas cloud or *nebula*. An *emission spectrum* is observed when energy is absorbed by the gas atoms in a nebula and is reradiated by those atoms at specific wavelengths. This spectrum consists of bright lines against a black background. The light from fluorescent tubes and neon lights produce emission spectra.

Stellar spectra allow astronomers to determine star temperature, chemical composition, and motion along the line of sight. This enables astronomers to classify stars into spectral categories and estimate their age, reconstruct their histories, and postulate their future evolution. When available, astronomers prefer stellar spectra collected by orbiting spacecraft over spectra collected by Earth-based telescopes since they are not affected by atmospheric filtering and are therefore more accurate. Included in the spectra collected by spacecraft are infrared, ultraviolet, x-ray, and gamma ray bands that simply do not reach ground-based spectroscopes.

Notes:

- This spectroscope works better with a holographic diffraction grating than with standard diffraction gratings. Refer to the source for holographic gratings listed in the Projecting Spectrums activity.
- This spectroscope can be used to analyze the wavelengths of light from many light sources. Compare incandescent light, fluorescent light, and sunlight. If you have spectrum tubes and a power supply (available from science supply houses), examine the wavelengths of light produced by the different gases in the tubes. Many high school physics departments have this equipment and it may be possible to borrow it if your school does not. Use the spectroscope to examine neon signs and street lights. Science supply houses sell spectrum flame kits consisting of various salts that are heated in the flame of a Bunsen burner. These kits are much less expensive than spectrum tubes but are more difficult to work with because the flames do not last very long.

For Further Research:

- Compare the solar spectrum at midday and at sunset. Are there any differences?
Caution: Be careful not to look directly at the Sun.
- What do spectra tell us about the nature of stars and other objects in space?
- Show how temperature and radiation are related by connecting a clear light bulb to a dimmer switch. Gradually increase the current passing through the filament by turning up the dimmer. Observe the color and brightness of the filament as the temperature of the filament climbs with increasing current.
- Ask students to identify what elements are present in the object that produced the "Spectra of Unknown Composition" on page 37, and to explain their method. How does this activity relate to the way astronomers use spectra to identify the composition of a star?

Spectra of Various Elements

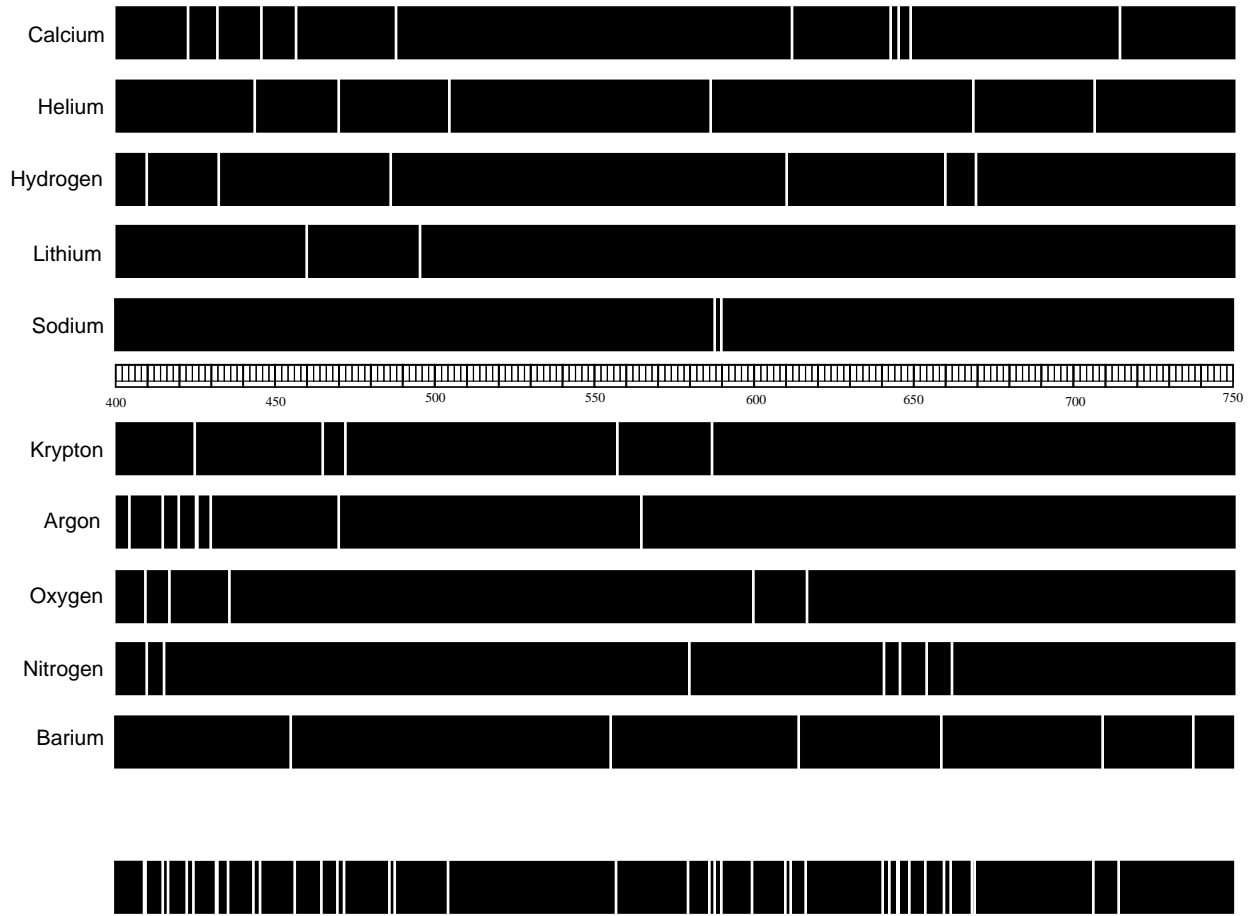

Spectra of Unknown Composition

Partial Spectra of an O Type Star

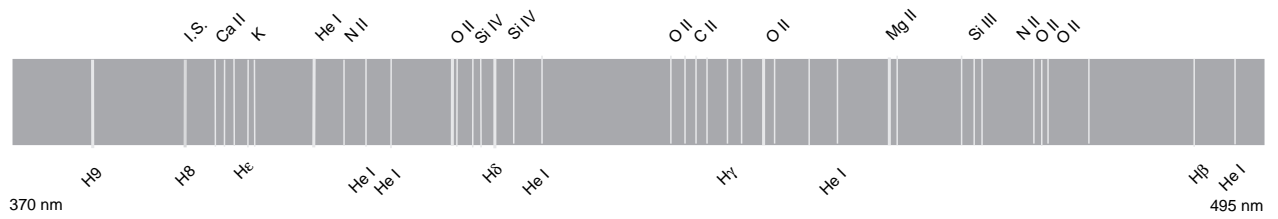



Housing top and bottom panels (Cut two.)

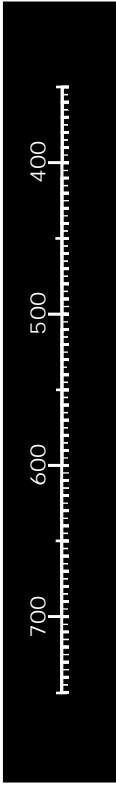

Eyepiece Rectangle

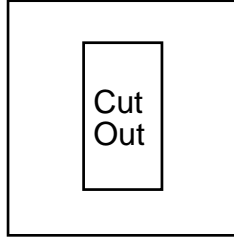

Mount diffraction grating over hole so that the light disperses in fat bars to the right and left.

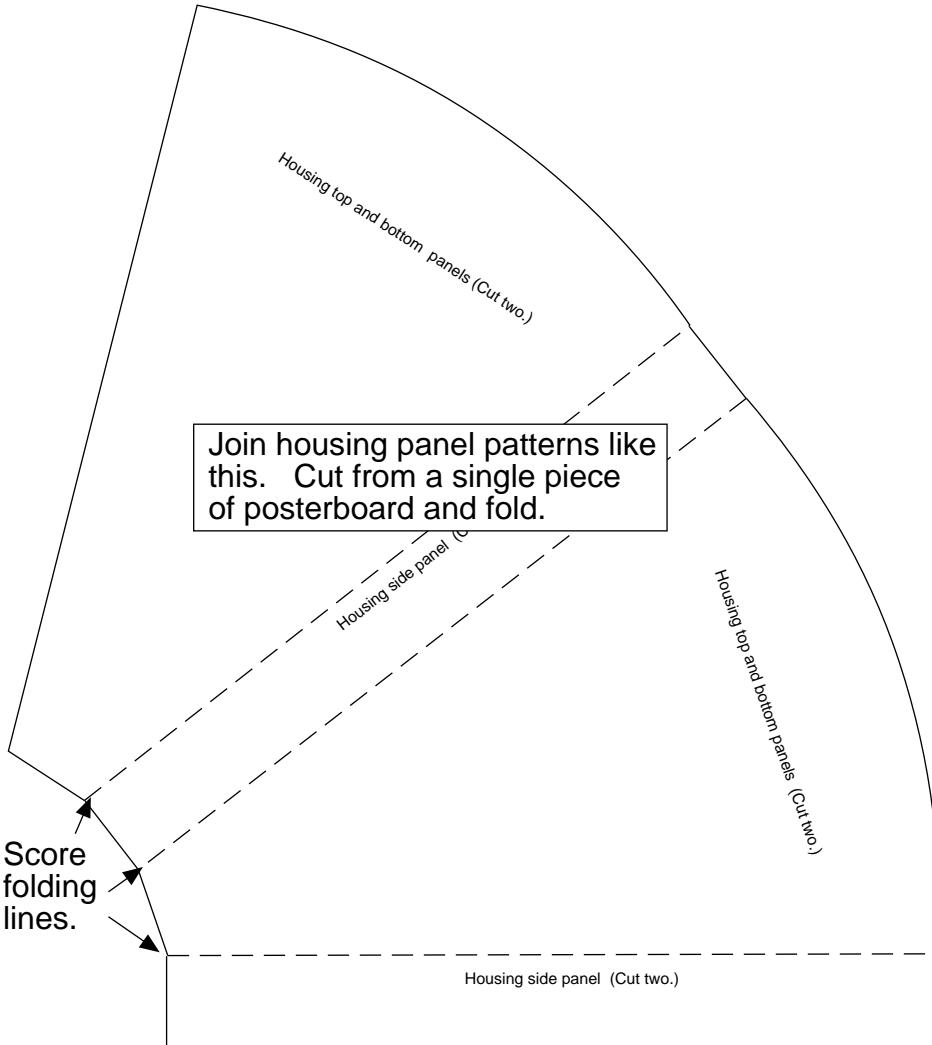

Join housing panel patterns like this. Cut from a single piece of posterboard and fold.

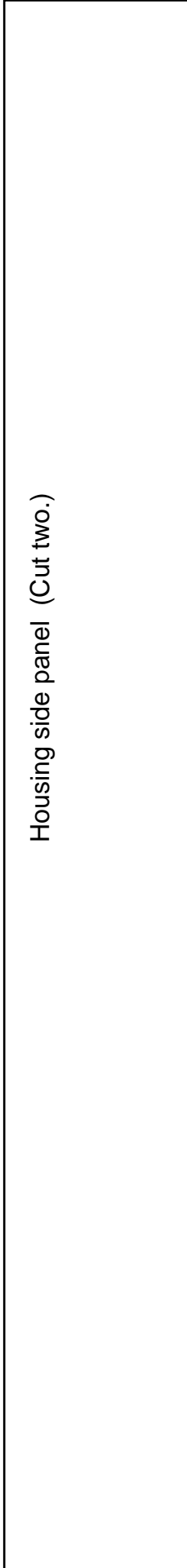

Front panel. This edge up.

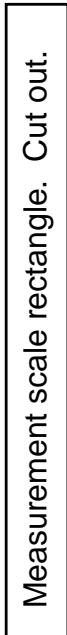

Red Shift, Blue Shift

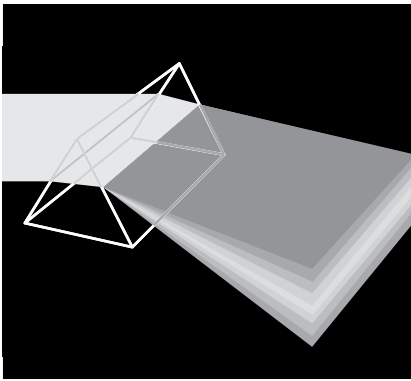

Description: A whiffle ball containing a battery operated buzzer is twirled in a circle to demonstrate the Doppler effect. This same effect causes starlight to shift to the blue or red end of the spectrum if a star is moving towards or away from us.

Objective: To demonstrate how stellar spectra can be used to measure a star's motion relative to Earth along the line of sight.

Materials:

Plastic whiffle ball (12-15 cm in diameter)
Microswitch*
Small buzzer*
9 volt battery*
9 volt battery clip*
Cord (3 meters long)
Solder and soldering iron
Sharp knife or hacksaw blade
Masking tape

*See note about electronic parts.

Procedure:

1. Splice and solder the buzzer, battery clip, and microswitch in a simple series circuit. See the wiring diagram on page 42. Be sure to test the circuit before soldering. Many small buzzers require the electric current to flow in one direction and will not work if the current flows in the other direction.
2. Split the whiffle ball in half along the seam with the knife or saw blade.
3. Remove the nut from the microswitch and insert the threaded shaft through one of the holes as shown in the diagram. If a hole is not present in the location shown, use a drill to make one the correct diameter. Place the nut back over the threaded shaft on the microswitch and tighten.
4. Join the two halves of the ball together with the switch, buzzer, and battery in-

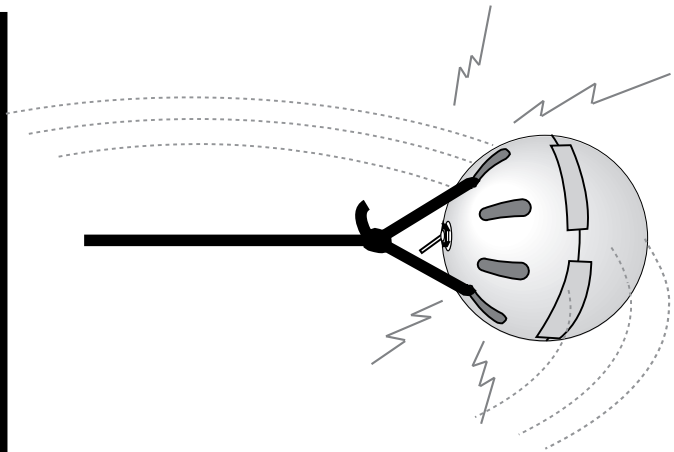

5. side. Tape the halves securely together.
5. Tie one end of the cord to the ball as shown.
6. Station students in a circle about 6 meters in diameter. Stand in the middle of the students, turn on the buzzer, and twirl the ball in a circle. Play out two to three meters of cord.
7. Ask the students to describe what they hear as the ball moves towards and away from them.
8. Let different students try twirling the ball. Ask them to describe what they hear.

As an alternate suggestion to the whiffle ball, cut a cavity inside a foam rubber ball and insert the battery and buzzer. The ball can then be tossed from student to student while demonstrating the Doppler effect.

Discussion

This is a demonstration of the phenomenon called the *Doppler effect*. It results from the motion of a source (star) relative to the observer and causes its spectra to be shifted toward the red (going away) or toward the blue (coming towards) end of the spectra.

Like light, sound travels in waves and therefore provides an excellent model of the wave behavior of light. The number of waves reaching an observer in one second is called the *frequency*. For a given speed, frequency depends upon the length of the wave. Long waves have a lower frequency than short waves. As long as the distance between the source of the waves and the observer remains constant, the frequency remains constant. However, if the distance between the observer and the source is increasing, the frequency will decrease. If the distance is decreasing, the frequency will decrease.

Imagine that you are at a railroad crossing and a train is approaching. The train is blowing its horn. The sound waves coming from the horn are squeezed closer together

than they would be if the train were still, because of the train's movement in your direction. This squeezing of the waves increases the number of waves (increases the frequency) that reach your ear every second. But after the train's engine passes the crossing, the frequency diminishes and the pitch lowers. In effect, the sound waves are stretched apart by the train's movement in the opposite direction. As the observer, you perceive these frequency changes as changes in the pitch of the sound. The sound's pitch is higher as the train approaches and lower as it travels away. The illustration below provides a graphical representation of what happens.

A similar situation takes place with stars. If the distance between a star and Earth is increasing, the lines in the absorption or emission spectrum will shift slightly to the lower frequency, red end of the spectrum. If the distance is decreasing, the lines will shift toward the blue end. The amount of that shift can be measured and used to calculate the relative velocity using the following formula.

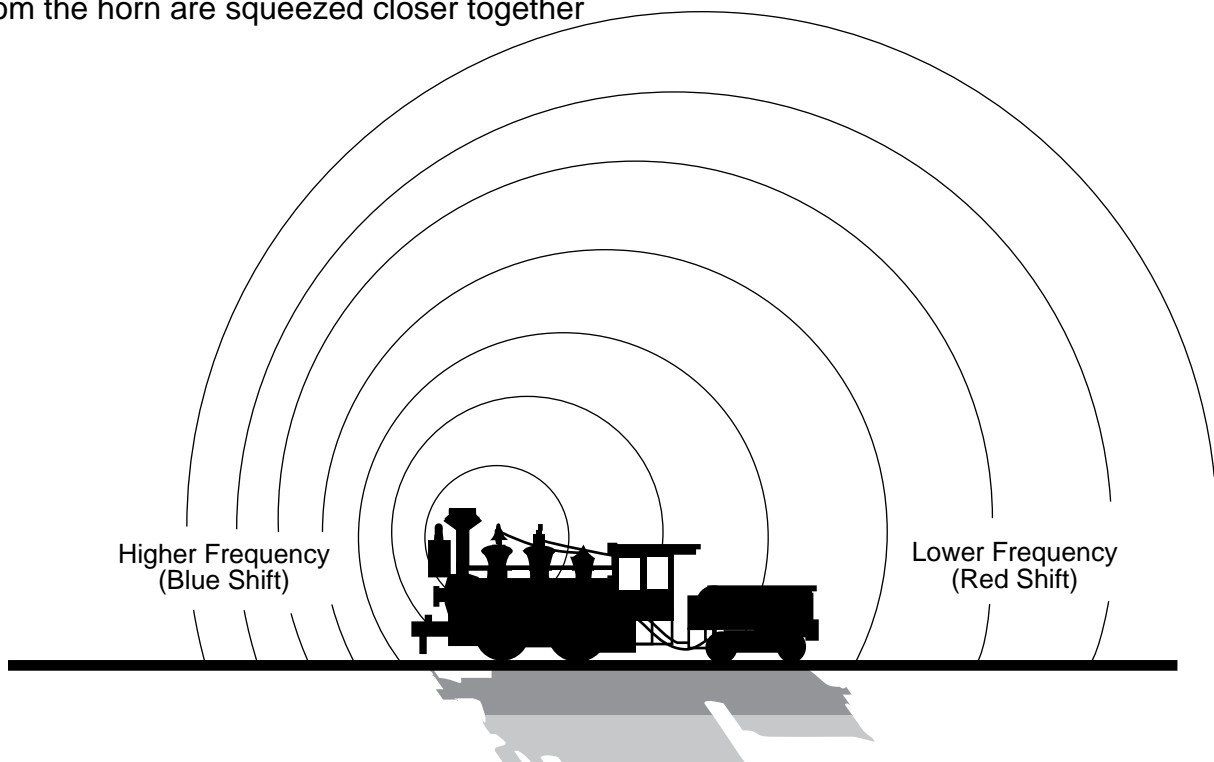

Note: A single line of the emission spectra is used for the calculation.

$$\frac{V_r}{c} = \frac{\Delta\lambda}{\lambda_0}$$

V_r - radial velocity of the source with respect to the observer.

c - speed of light (3×10^5 km/sec)

$\Delta\lambda$ - the amount of the shift in nanometers

λ_0 - unshifted wavelength in nanometers

For example, if a line in a spectrum should fall at 600 nanometers but instead lies at 600.1, what would the radial velocity be?

$$V_r = \frac{0.1nm \times 3 \times 10^5 / sec}{600nm} = 50km / sec$$

The solution to this equation only tells us the velocity of the source relative to the spectroscope. Whether the distance is increasing or decreasing is revealed by the direction of the shift to the red or blue end of the visible spectrum. It does not tell, however, if one or both objects are moving relative to some external reference point.

For Further Research

- Does the person twirling the whiffle ball hear the Doppler shift? Why or why not?
- Can the red/blue shift technique be used

for objects other than stars? Can you tell which way an emergency vehicle is traveling by the pitch of its siren?

- Transverse velocity is a motion that is perpendicular to radial velocity. Can this motion be detected by the Doppler effect?
- What has Doppler shift told astronomers about the size of the universe?

Note about Electronic Parts:

The electronic parts for this device are not specified exactly since there are many combinations that will work. Go to an electronic parts store and select a buzzer, battery holder, battery, and switch from what is available. Remember to purchase parts that will fit in a whiffle ball. The store clerk should be able to help you make a workable selection if you need assistance. If possible, test the buzzer before purchasing it to determine if it is loud enough. Test the buzzer and battery before soldering connections. The buzzer may be polarized. Reverse the connections if you do not hear a sound the first time.

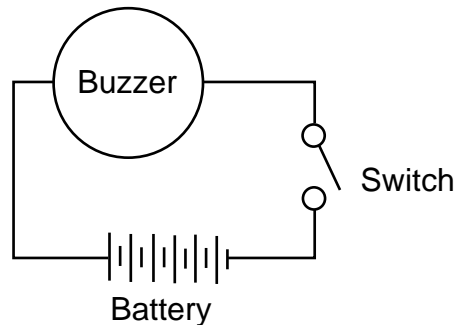

Simplified Star Spectrum

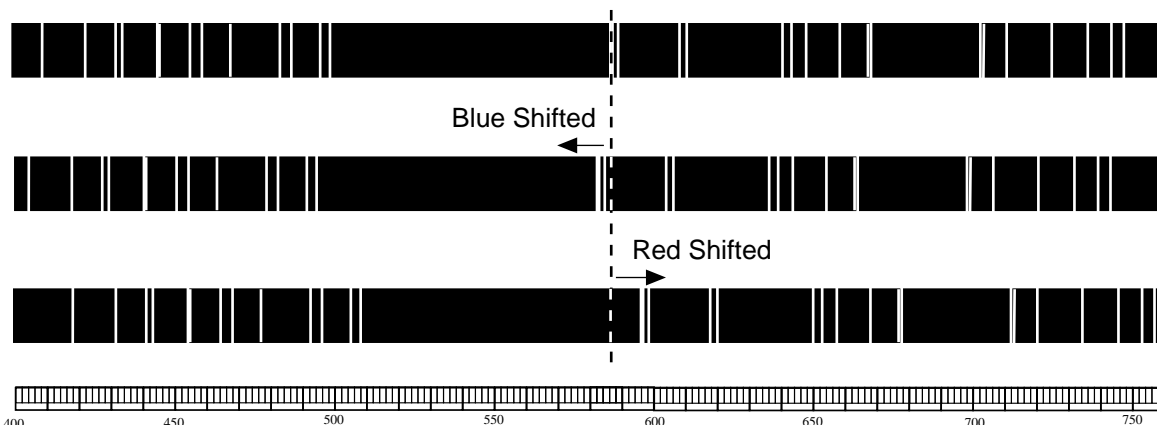

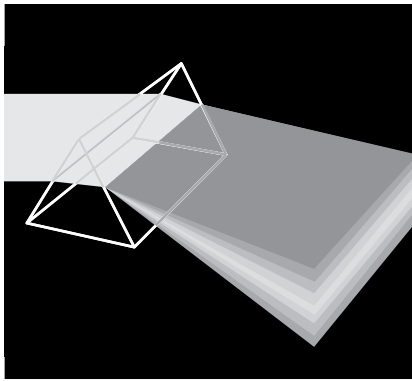

Wavelength and Energy

Description: Shaking a rope permits students to feel the relationship between wavelength, frequency, and energy.

Objective: To demonstrate the relationship between wave frequency and energy in the electromagnetic spectrum.

Materials:

Rope (50 ft. length of cotton clothes line)

Procedure:

1. Select two students to hold the rope. Have each student stand in an aisle or in opposite corners so that the rope is stretched between them.
2. While one end of the rope is held still, have the other student shake the opposite end up and down at a moderate but steady rate.
3. Ask the remaining students to observe the wave patterns created in the rope. Point out wave crests. Ask the students to estimate the *wavelength* and *frequency* of waves reaching the other student. The wavelength is the distance from wave crest to wave crest. Frequency is the number of waves reaching the far end of the rope each second.
4. Tell the student shaking the rope to shake it faster. Again estimate the wavelength and frequency.
5. Tell the student shaking the rope to shake the rope as fast as he or she can. Again, estimate the wavelength and frequency.

6. Stop the demonstration and ask the student shaking the rope if it is easier to produce low frequency (long wavelength) or high frequency (short wavelength) waves.

Discussion:

This activity provides a graphic demonstration of the relationship between energy and wavelength. High-frequency waves (short wavelength) represent more energy than low-frequency (long wavelength) waves.

For Further Research:

- As time permits, let the remaining students try the rope demonstration.
- A similar demonstration can be conducted with a coiled spring (Slinky).
- Invite a hospital medical imaging specialist to talk to the class about the use of high-frequency electromagnetic waves in medical diagnosis.
- Make an overhead projector transparency of the spectrum chart on page 24. Ask the students to relate energy to the electromagnetic wavelengths depicted.

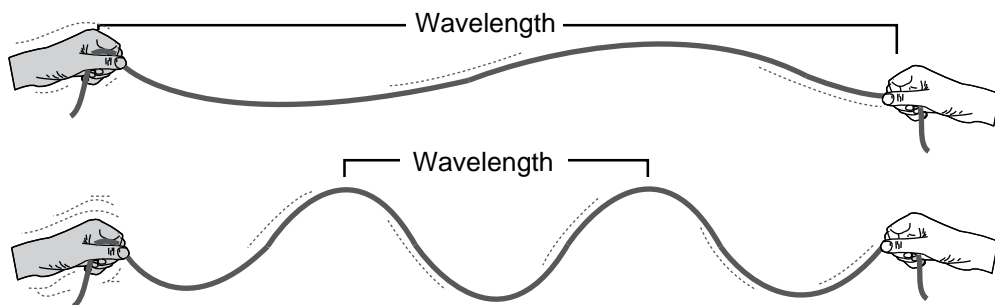

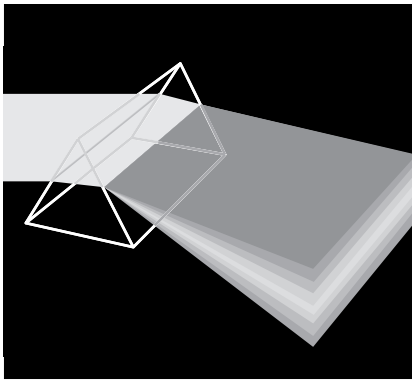

Resonance Rings

Description: Different sized rings demonstrate the relationship between the frequency of electromagnetic radiation and atmospheric absorption.

Objective: To show how atoms and molecules in Earth's atmosphere absorb energy through resonance.

Materials:

Used lightweight file folders
Cardboard sheet about 20 by 30 cm
Masking tape
Scissors

Procedure:

1. Cut two strips of paper from used file folders. Each strip should be 3 cm wide. Make the strips approximately 30 and 35 cm long.
2. Curl each strip into a cylinder and tape the ends together.
3. Tape the cylinders to the cardboard as shown in the diagram. If the ring has a crease from the file folder, the crease should be at the bottom.
4. Holding the cardboard, slowly shake it back and forth and observe what happens when you gradually increase the frequency of the shaking.

Discussion:

All objects have a natural frequency at which they vibrate. When the frequency of the shaking matches the frequency of one of the rings in this activity, it begins to vibrate more than the rest. In other words, some of the energy in the shaking is absorbed by that ring. This effect is called *resonance*. Resonance takes place when energy of the right frequency (or multiples of the right frequency) is added to an object causing it to vibrate. When electromagnetic radiation enters Earth's atmosphere, certain wavelengths match the natural frequencies of atoms and molecules of various atmospheric gases such as nitrogen

and ozone. When this happens, the energy in those wavelengths is absorbed by those atoms or molecules,

intercepting this energy before it reaches Earth's surface. Wavelengths that do not match the natural frequencies of these atmospheric constituents pass through. (See figure 2 on page 25.)

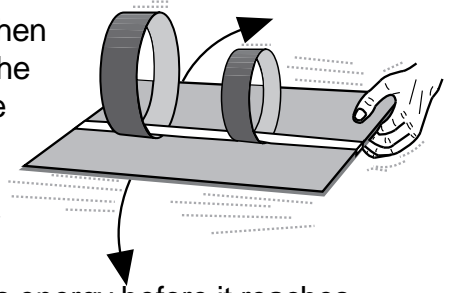

Resonance is important to astronomy for another reason. All starlight begins in the center of the star as a product of nuclear fusion. As the radiation emerges from the photosphere or surface of the star, some wavelengths of radiation may be missing. The missing components produce dark lines, called *absorption lines*, in the star's spectra. The lines are created as the radiation passes through the outer gaseous layers of the star. Some of that radiation will be absorbed as various gas atoms present there resonate. Absorption lines tell what elements are present in the outer gaseous layers of the star.

For Further Research:

- Investigate the natural frequencies of various objects such as bells, wine goblets, and tuning forks. If you have an oscilloscope, use it to convert the sounds to wave forms.
- Why has the playing of the song "Louie, Louie" been banned at several college football stadiums? Why do marching soldiers crossing a bridge "break cadence"?
- What gas in Earth's upper atmosphere blocks ultraviolet radiation? Why is it important?

Unit 3

Collecting Electromagnetic Radiation

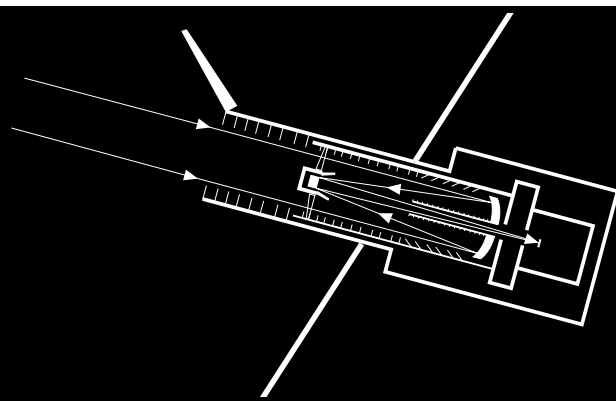

Introduction

Except for rock samples brought back from the Moon by Apollo astronauts, cosmic ray particles that reach the atmosphere, and meteorites that fall to Earth, the only information about objects in space comes to Earth in the form of electromagnetic radiation. How astronomers collect this radiation determines what they learn from it. The most basic collector is the human eye. The retina at the back of the eye is covered with tiny antennae, called rods and cones, that resonate with incoming light. Resonance with visible electromagnetic radiation stimulates nerve endings, which send messages to the brain that are interpreted as visual images. Cones in the retina are sensitive to the colors of the visible spectrum, while the rods are most sensitive to black and white.

Until the early 1600s, astronomers had only their eyes and a collection of geometric devices to observe the universe and measure locations of stellar objects. They concentrated on the movements of planets and transient objects such as comets and meteors. However, when Galileo Galilei used the newly invented telescope to study the Moon, planets, and the Sun, our knowledge of the universe changed dramatically. He was able to observe moons circling Jupiter, craters on the Moon, phases of

Venus, and spots on the Sun. **Note:** Galileo did his solar observations by projecting light through his telescope on to a white surface—a technique that is very effective even today. **Never look at the Sun directly with a telescope!**

Galileo's telescope and all optical telescopes that have been constructed since are collectors of electromagnetic radiation. The *objective* or front lens of Galileo's telescope was only a few centimeters in diameter. Light rays falling on that lens were bent and concentrated into a narrow beam that emerged through a second lens, entered his eye, and landed on his retina. The lens diameter was much larger than the diameter of the pupil of Galileo's eye, so it collected much more light than Galileo's unaided eye could gather. The telescope's lenses magnified the images of distant objects three times.

Since Galileo's time, many huge telescopes have been constructed. Most have employed big mirrors as the light collector. The bigger the mirror or lens, the more light could be gathered and the fainter the source that the astronomer can detect. The famous 5-meter-diameter Hale Telescope on Mt. Palomar is able to gather 640,000 times the amount of light a typical eye could receive. The amount of light one telescope receives compared to the human eye is its *light*

gathering power (LGP). Much larger even than the Hale Telescope is the Keck Telescope that has an effective diameter of 10 meters. Its light gathering power is two and a half million times the amount a typical eye can receive. Although NASA's *Hubble Space Telescope*, in orbit above Earth's atmosphere, has only a LGP of 144,000, it has the advantage of an unfiltered view of the universe. Furthermore, its sensitivity extends into infrared and ultraviolet wavelengths.

Once the telescope collects the photons, the detection method becomes important. Telescopes are collectors, not detectors. Like all other telescopes, the mirror of the *Hubble Space Telescope* is a photon collector that gathers the photons to a focus so a detector can pick them up. It has several filters that move in front of the detector so that images can be made at specific wavelengths.

In the early days, astronomers recorded what they saw through telescopes by drawing pictures and taking notes. When photography was invented, astronomers replaced their eyes with photographic plates. A photographic plate is similar to the film used in a modern camera except that the emulsion was mounted on glass plates instead of plastic. The glass plate collected photons to build images and spectra. Astronomers also employed the photomultiplier tube, an electronic device for counting photons.

The second half of this century saw the development of the *Charge Coupled Device* (CCD), a computer-run system that collects photons on a small computer chip. CCDs have now replaced the photographic plate for most astronomical observations. If astronomers require spectra, they insert a spectrograph between the telescope and the CCD. This arrangement provides digital spectral data.

Driving each of these advances is the need for greater sensitivity and accuracy of the data. Photographic plates, still used for wide-field studies, collect up to about 5 percent of the photons that fall on them. A CCD collects 85 to 95 percent of the photons. Because CCDs are small and can only observe a small part of the sky at a time, they are especially suited for deep space observations.

Because the entire electromagnetic spectrum represents a broad range of wavelengths and energies (See figure 1, page 24.), no one detector can record all types of radiation. Antennas are used to collect radio and microwave energies. To collect very faint signals, astronomers use large parabolic radio antennas that reflect incoming radiation to a focus much in the same way reflector telescopes collect and concentrate light. Radio receivers at the focus convert the radiation into electric currents that can be studied.

Sensitive solid state heat detectors measure infrared radiation, higher in energy and shorter in wavelength than radio and microwave radiation. Mirrors in aircraft, balloons, and orbiting spacecraft can concentrate infrared radiation onto the detectors that work like CCDs in the infrared range. Because infrared radiation is associated with heat, infrared detectors must be kept at very low temperatures lest the telescope's own stored heat energy interferes with the radiation coming from distant objects.

Grazing-incidence mirrors that consist of a mirrored cone collect ultraviolet radiation reflected at a small "grazing" angle to the mirror surface and direct it to detectors placed at the mirror's apex. Different mirror coatings are used to enhance the reflectivity of the mirrors to specific wavelengths.

X-ray spacecraft also use grazing-incidence mirrors and solid state detectors while gamma ray spacecraft use a detector of an entirely different kind. The *Compton Gamma-Ray Observatory* has eight 1-meter-sized crystals of sodium iodide that detect incoming gamma rays as the observatory orbits Earth. Sodium iodide is sensitive to gamma rays, but not to optical and radio wavelengths. The big crystal is simply a detector of photons—it does not focus them.

Today, astronomers can choose to collect and count photons, focus the photons to build up an image, or disperse the photons into their various wavelengths. High energy photons are usually detected with counting techniques. The other wavelengths are detected with counting (photometry), focusing methods (imaging), or dispersion methods (spectroscopy). The particular instrument or combination of instruments astronomers choose depends not only on the spectral region to be observed, but also on the object under observation. Stars are point sources in the sky. Galaxies are not. So the astronomer must select a combination that provides good stellar images or good galaxy images.

Another important property of astronomical instruments is *resolution*. This is the ability to separate two closely-spaced objects from each other. For example, a pair of automobile headlights appear to be one bright light when seen in the distance along a straight highway. Close up, the headlights

resolve into two. Since telescopes, for example, have the effect of increasing the power of our vision, they improve our resolution of distant objects as well. The design and diameter of astronomical instruments determines whether the resolution is high or low. For stellar work, high resolution is important so the astronomer can study one star at a time. For galaxy work the individual stars in a galaxy may often not be as important as the whole ensemble of stars.

Unit Goals

- To demonstrate how electromagnetic radiation can be collected and detected through the use of mirrors, lenses, infrared detectors, and radio antennas.
- To illustrate how the use of large instruments for collecting electromagnetic radiation increases the quantity and quality of data collected.

Teaching Strategy

Because many of the wavelengths in the electromagnetic spectrum are difficult or dangerous to work with, activities in this section concentrate on the visible spectrum, the near infrared, and radio wavelengths. Several of the activities involve lenses and mirrors. The *Lenses and Mirrors* activity provides many tips for obtaining a variety of lenses and mirrors at little or no cost.

Activity Titles

Pinhole Viewer

Activity Objective: To demonstrate how a pinhole viewer inverts light passing through it.

Application: Physical Science, Photography

Build Your Own Telescope

Activity Objective: To build a simple astronomical telescope from two lenses and some tubes.

Application: Astronomy, Physical Science

Reflecting Telescopes

Activity Objective: To illustrate how a reflecting telescope works and how it inverts an image.

Application: Astronomy, Physical Science

Lenses and Mirrors

Activity Objective: To show how lenses and mirrors can bend and reflect light waves.

Application: Astronomy, Mathematics, Physical Science

Light Gathering Power

Activity Objective: To determine the ability of various lenses and mirrors to gather light.

Application: Astronomy, Mathematics

Liquid Crystal IR Detector

Activity Objective: To experiment with one method of detecting infrared radiation.

Application: Astronomy, Chemistry, Physical Science

Pinhole Viewer

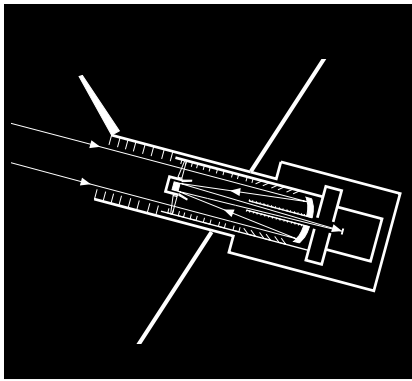

Description: A pinhole viewer demonstrates how inverted images are produced.

Objective: To demonstrate how a pinhole viewer inverts light passing through it.

Materials:

Cylindrical cereal box
Tracing paper
Rubber band
Candle
Sharp knife
Pin
Aluminum foil
Cellophane tape
Double convex lens (magnifying glass)
Dark room

Procedure:

1. Using the knife, cut a one centimeter square hole in the center of the bottom of the cereal box.
2. Cover the hole with a small piece of aluminum foil and tape in place. Poke the center of the foil with the pin to make a hole directly over the hole made in step 1.
3. Cover the open end of the box with tracing paper and fasten with a rubber band.
4. Light the candle and darken the room.
5. Aim the pinhole viewer so that the pinhole is pointed at the candle. Observe the image on the tracing paper.
6. Compare the image produced by the pinhole viewer with the image seen through a double convex lens.

Discussion:

Convex lenses invert images. Light rays converge behind these lenses and cross at the focal point. At that point, the image

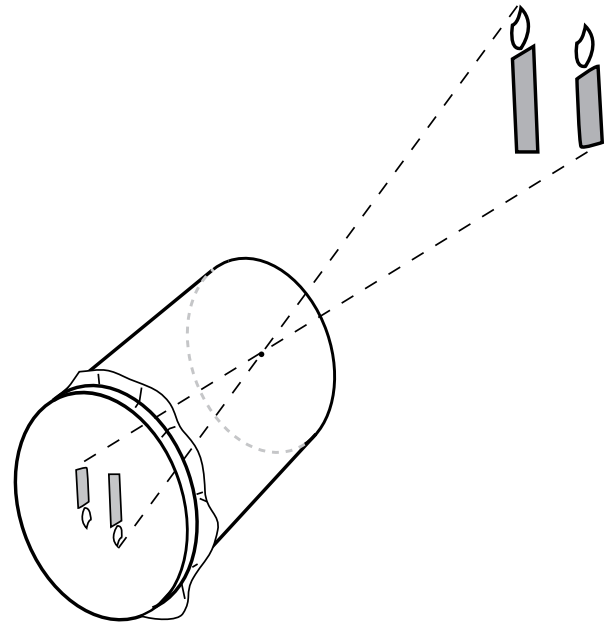

becomes inverted. (See diagram on next page.) With the pinhole viewer, the change takes place at the pinhole.

Astronomical telescopes produce images like those of the pinhole viewer. Because the big lens or mirror of astronomical telescopes are large, a great amount of light is focused on the detector, producing a much brighter image than the pinhole camera. Although additional lenses or mirrors can be used to "right" the image, astronomers prefer not to use them. Each added lens or mirror removes a small amount of light. Astronomers want their images as bright as possible and do not mind if the images of stars and planets are inverted. Since most large astronomical telescopes use photographic film or CCDs as detectors, righting the image, if necessary, is merely a matter of inverting

the negative before making a print or commanding the computer to right the image.

For Further Research:

- The pinhole viewer can be converted into a simple camera by placing a piece of unexposed black and white print film where the tracing paper screen is located. This must be done in a darkroom. Reduce light leaks by covering the film end of the viewer and the pinhole. Point the camera at an object to be photographed and

uncover the pinhole for several seconds. Recover the pinhole and develop the film in a dark room. Take several pictures with different exposure lengths until a suitable exposure is found. Show how the negative is inverted to correct the image before printing.

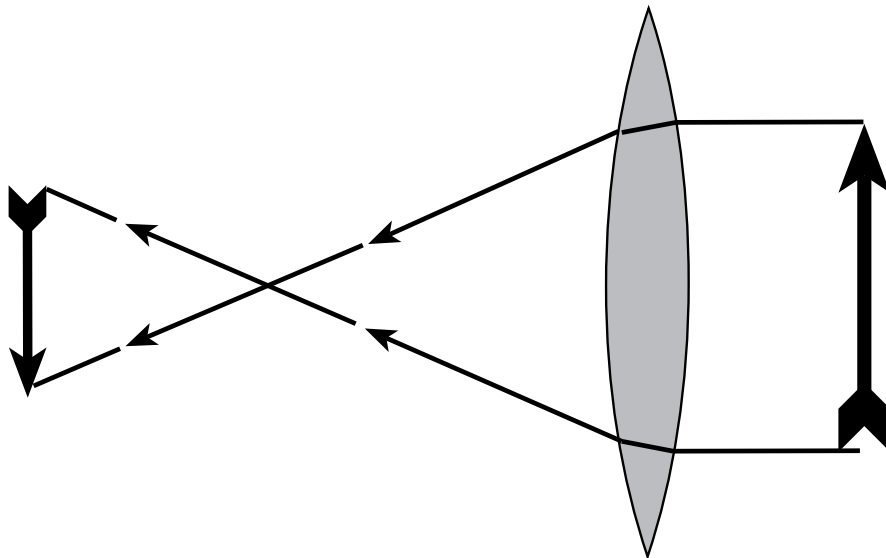

Images seen through lenses, such as this double convex lens, are inverted. This is similar to the function of the pinhole in the pinhole viewer.

Build Your Own Telescope

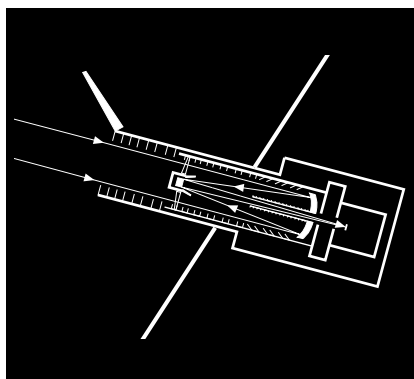

Description: A simple refractor telescope is made from a mailing tube, styrofoam tray, rubber cement, and some lenses.

Objective: To build a simple astronomical telescope from two lenses and some tubes.

Materials:

Paper mailing tube (telescoping - 1 inside tube and 1 outside tube)
Styrofoam trays (1 large and 1 small)
Lenses (1 large and 1 small. See note about lenses.)
Metric ruler
Razor blade knife
Cutting surface
Marker pen
Rubber cement
Fine grade sandpaper

Procedure:

1. Cut a short segment from the end of the outside tube. This circle will be used for tracing only. Place the circle from the larger tube on the large tray. Using a marker pen, trace the inside of the circle on to the bottom of the tray three times.
2. Lay the large (objective) lens in the center of one of the three large circles. Trace the lens' outline on the circle.
3. Cut the circle with the lens tracing from the tray using the razor blade knife. Be sure to place the styrofoam on a safe cutting surface. Cut out the lens tracing, but when doing so, cut inside the line so that the hole is slightly smaller than the diameter of the lens.
4. Before cutting out the other two large circles, draw smaller circles inside them approximately equal to 7/8ths of the

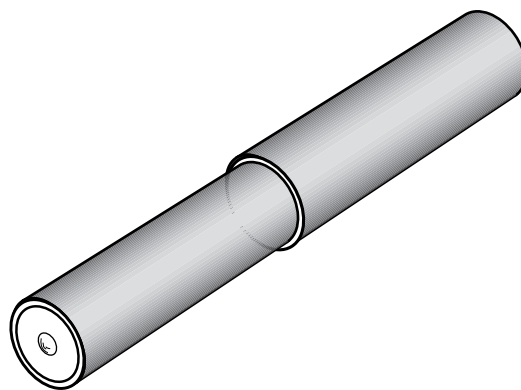

diameter of the large lens. Cut out both circles inside and out.

5. Coat both sides of the inner circle (the one that holds the lens) with rubber cement and let dry. Coat just one side each of the other two circles with cement and let dry. For a better bond, coat again with glue and let dry.
6. Insert the lens into the inner circle and press the other circles to either side. Be careful to align the circles properly. Because the outside circles have smaller diameters than the lens, the lens is firmly held

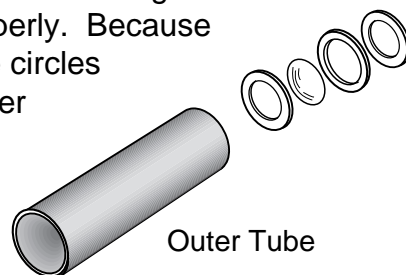

- in place. You have completed the objective lens mounting assembly.
7. Repeat steps 1- 6 for the inside tube and use the smaller lens for tracing. However, because the eyepiece lens is thinner than the objective lens, cut the inner circle from the small tray. The foam of this tray is thinner and better matches the thickness of the lens.
8. After both lens mounting assemblies are

complete, lay the fine sandpaper on a flat surface and gradually sand the edges of each lens completed mounting assembly to make them smooth. Stop sanding when the assemblies are just larger than the diameter of the corresponding tube. (Do not insert them yet.) Friction will hold them in place. If the lens assemblies get too loose, they can be held firmly with glue or tape.

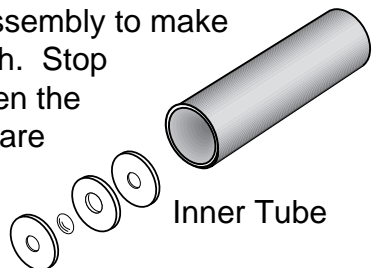

With a small amount of effort, the assembly will compress slightly and slip inside the tube. (Do not insert them yet.) Friction will hold them in place. If the lens assemblies get too loose, they can be held firmly with glue or tape.

9. Hold the two lens assemblies up and look through the lenses. Adjust their distances apart and the distance to your eye until an image comes into focus. Look at how far the two lenses are from each other. Cut a segment from the outside and the inside tube that together equal $1 \frac{1}{2}$ times the distance you just determined when holding up the lenses. Use the sandpaper to smooth any rough edges on the tubes after cutting.
10. Carefully, so as not to smudge the lenses, insert the objective lens assembly into one end of the outside tube and the eyepiece lens assembly into the end of the inside tube. Slip the inside tube into the outside tube so that the lenses are at opposite ends. Look through the eyepiece towards some distant object and slide the small tube in and out of the large tube until the image comes into focus.
11. (Optional) Decorate the outside tube with marker pens or glue a picture to it.

Discussion:

You just constructed a type of telescope known as a *refractor*. Refractor means that light passing through the objective lens is bent (refracted) before reaching the

eyepiece. Passing through the eyepiece, the light is refracted again.

This refraction inverts the image. To have an upright image, an additional correcting lens or prism is placed in the optical path. Astronomers rarely care if images are right-side-up or up-side-down. A star looks the same regardless of orientation. However,

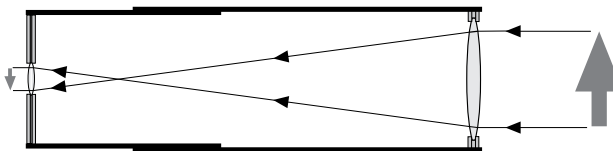

correcting images requires the use of extra optics that diminish the amount of light collected. Astronomers would rather have bright, clear images than right-side-up images. Furthermore, images can be corrected by inverting and reversing photographic negatives or correcting the image in a computer.

Notes About Lenses and Tubes:

Refer to the Lenses and Mirrors activity for information on how to obtain suitable lenses for this activity. PVC plumbing pipes can be used for the telescoping tubes. Purchase tube cutoffs of different diameters at a hardware store.

For Further Research:

- If the focal lengths of the two lenses used for the telescope are known, calculate the power of the telescope. Magnification equals the focal length of the objective lens divided by the focal length of the eyepiece. Refer to the Light Gathering Power activity on page 56 for more details.
- Bring commercially-made telescopes, spyglasses, and binoculars into the classroom. Compare magnification, resolution, and light gathering power to that of the telescope made here. Learn how these optical instruments function.
- Invite local amateur astronomy clubs to host "star parties" for your students.

Reflecting Telescopes

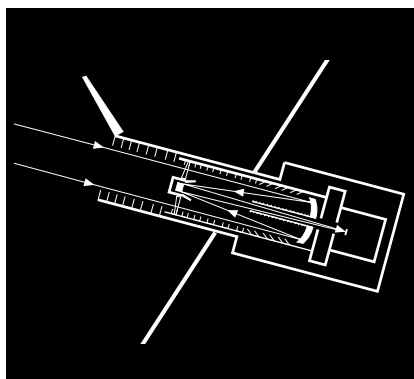

Description: The principle of a reflector telescope is demonstrated with a concave makeup mirror.

Objective: To illustrate how a reflector telescope works and how it inverts an image.

Materials:

Concave makeup mirror
Candle and matches or electric holiday "candle"
Dark room
Sheet of white paper
Assorted convex lenses

Procedure:

1. Light the candle and darken the room.
2. Bring the concave makeup mirror near the candle flame and tilt and turn it so that reflected light from the candle flame focuses on a sheet of white paper.
3. Experiment with different lenses to find one suitable for turning the makeup mirror into a simple reflector telescope. Hold the lens near your eye and move it until the reflected light from the mirror comes into focus.

Discussion:

Many reflecting telescopes gather light from distant objects with a large parabolic mirror that directs the light toward a secondary mirror which then focuses the light onto a detector. The concave mirror used in this demonstration shows how a concave mirror can concentrate light to form a recognizable image. The image produced with a makeup mirror is not well focused because the mirror is inexpensively produced from molded glass rather than from carefully shaped and polished glass.

The light gathering power of a telescope goes up with the area of the lens or mirror used as the primary light collector. (See Light Gathering Power activity on page 56.) The

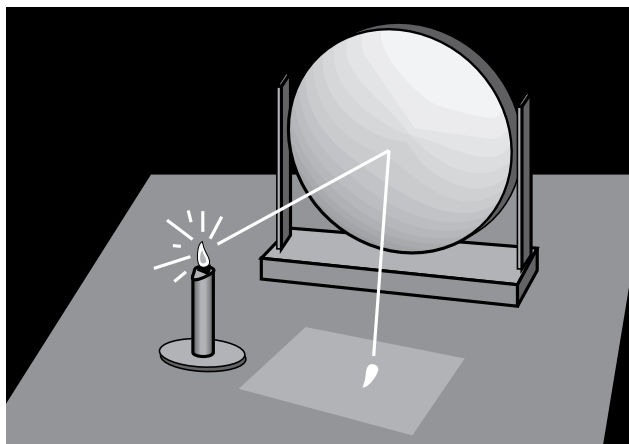

bigger the telescope lens or mirror, the more light and the fainter the object the astronomer can collect. Small telescopes can only detect bright stars. Large telescopes (over 4 meters in diameter) can detect objects several billion times fainter than the brightest stars.

Large astronomical telescopes do not use eyepieces. Light falls on photographic film, photometers, or CCDs. This demonstration shows how an image forms on a flat surface. Covering the surface with photographic film will produce a crude picture. Although astronomers have converted to CCDs for most observations, photography is still employed for some applications. Rather than film, astronomers usually prefer photographic emulsions on sheets of glass, which are more stable over time.

For Further Research:

- Why are the largest astronomical telescopes made with big objective mirrors rather than big objective lenses?
- Find out how different kinds of reflecting telescopes such as the Newtonian, Cassegranian, and Coude work.

Lenses and Mirrors

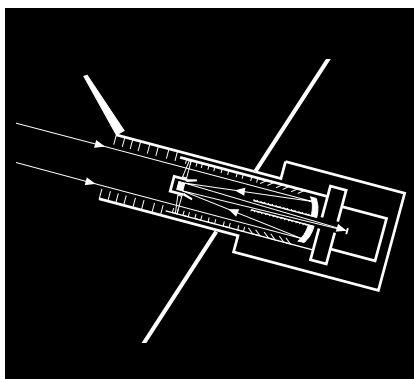

Description: A variety of objects are used to investigate lenses and mirrors.

Objective: To show how lenses and mirrors can bend and reflect light waves.

Materials:

Old eye glass lenses
Projector lenses
Christmas tree ornament
"Baby moon" hubcap
Soft drink can bottom
Broken optical instruments
Glass flask and water
Clear plastic rods
Narrow olive jar and water
Styrofoam food trays
Rubber cement
Etc.



Procedure:

1. Have students experiment with the optical properties of old lenses and mirrors and other objects that reflect or bend light. (See the discussion below for ideas on obtaining materials.)
2. Make a simple and nearly indestructible magnifier glass out of styrofoam food trays, rubber cement, and old eye glasses. Cut a three piece "sandwich" from the styrofoam tray. The pieces should look like ping pong paddles. Lay a lens in the center of one of the pieces. Cut a hole in the styrofoam exactly the size of the lens. Cut slightly smaller holes in the other two pieces. Glue the three pieces together with rubber cement. Refer to the Build Your Own Telescope activity for more information on the construction technique using rubber cement.
3. Make a concave mirror by polishing the bottom of an aluminum soft drink can. Obtain polishing compounds from a hardware store. Use the compound and a damp rag to achieve a mirror finish.
4. Make crude telescopes by aligning old camera and projector lenses inside a paper tube.
5. Observe the images produced with a silver glass Christmas ornament or a Baby Moon hubcap (available for a few dollars from an auto supply store)

Discussion:

An amazing collection of lenses and mirrors can be obtained at little or no cost through creative scrounging. Ask an optometrist or eyewear store if they will save damaged

eyeglass lenses for you. Although not of a quality useful for eyewear, these lenses are very suitable for classroom use.

Bifocals and trifocals make fascinating magnifying lenses. Fill a spherical glass flask with water to make a lens. Water-filled cylindrical glass or plastic bottles make magnifiers that magnify in one direction only. Aluminized mylar plastic stretched across a wooden frame makes a good front surface plane mirror. A Plexiglas mirror can be bent to make a "funhouse" mirror. Low-reflectivity plane mirrors can be made from a sheet glass backed with black paper. Ask the person in charge of audiovisual equipment at the school to save the lenses from any broken or old projectors that are being discarded. Projector and camera lenses are actually made up of many lenses sandwiched together. Dismantle the lens mounts to obtain several usable lenses. Check rummage sales and flea markets for binoculars and old camera lenses. A wide assortment of lenses and mirrors are also available for sale from school science supply catalogs and from the following organization:

Optical Society of America
2010 Massachusetts Avenue, NW
Washington, DC 20036
(202) 223-8130

For Further Research:

- Fill a long olive jar with water and place it above a sign reading "CARBON DIOXIDE." Use black ink to write "CARBON" and red ink to write "DIOXIDE." Support the jar with a rack cut from a couple of small pieces of cardboard. When the words are viewed through the lens at the right distance, carbon is inverted while dioxide is not. Ask the students why this is so. **Hint:** Both words are actually inverted.
- Use a baby moon hubcap as a convex mirror. Aim a camera at the reflections on the hubcap to take "fish-eye" pictures.
- A grazing-incidence mirror of the kind used for infrared, ultraviolet, and x-ray spacecraft can be simulated with a piece of flexible reflective plastic such as a thin mylar plastic mirror. Roll the plastic, with its reflective surface inward, into a cone. The small end of the cone should be open so that you can look through it. Point the cone like a telescope and look at a light bulb several meters away. Adjust the shape of the cone to increase the amount of light that reaches your eye.
- Ask students to try to locate old lenses for study as well as different objects that work like lenses.
- Try to make a reflector telescope out of the polished soft drink can in step 3. Compare the curvature of the can's mirror with that of a commercial reflector telescope. Why is there a difference?

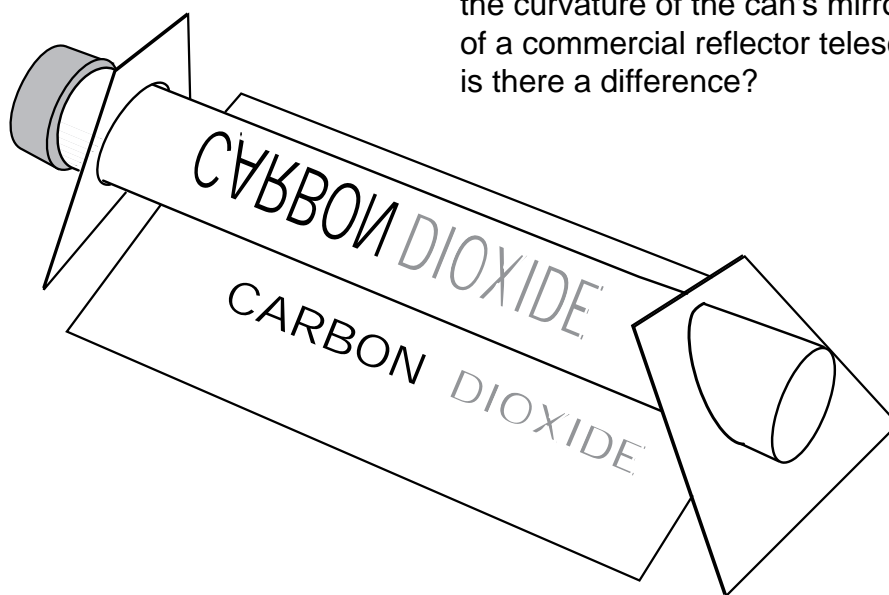

Light Gathering Power

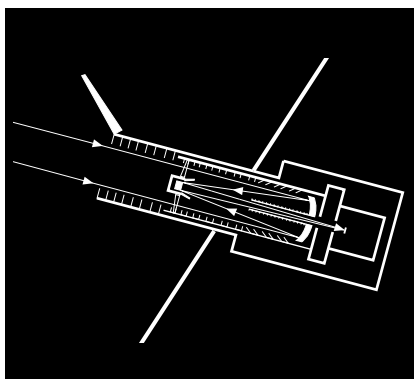

Description: Students compare and calculate the light gathering power of lenses.

Objective: To determine the ability of various lenses and mirrors to gather light.

Materials:

- Gray circles (See master page.)*
 - White paper punchouts from a three hole paper punch*
 - White paper
 - Double convex lenses of different diameters
 - Metric ruler
 - Astronomical telescope (optional)
- *per student

Procedure:

1. Have students examine several different double convex lenses.
2. Compare the ability of each lens to gather light by focusing the light from overhead fixtures onto a piece of white paper. Which lens produces a brighter image? Be sure to hold the lenses parallel to the paper.
3. Compare the light gathering power of five imaginary lenses (gray circles) by placing small white paper circles (punchouts) on each. The number of punchouts represent the number of photons collected at a moment of time. Students may draw their own circles with compasses for this step.
4. What is the mathematical relationship between the number of punchouts that a circle can hold and the circle's diameter? How did you arrive at this conclusion?

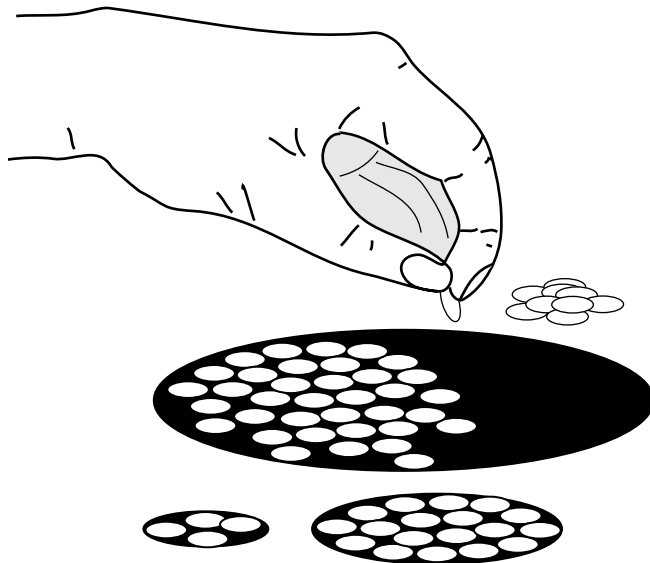

Discussion:

In a dark room, the pupil of the eye gets bigger to collect more of the dim light. In bright sunlight the pupil gets smaller so that too much light is not let into the eye. A telescope is a device that effectively makes the pupil as large as the objective lens or mirror.

A telescope with a larger objective lens (front lens) or objective mirror collects and concentrates more light than a telescope with a smaller lens or mirror. Therefore, the larger telescope has a greater light gathering power than the smaller one. The mathematical relationship that expresses *light gathering power* (LGP) follows:

$$\frac{LGP_A}{LGP_B} = \left(\frac{D_A}{D_B} \right)^2$$

In this equation, A represents the larger telescope and B the smaller telescope or human eye. The diameter of the objective lens or mirror for each telescope is represented by D. Solving this equation yields how much greater the light gathering power (LGP) of the bigger telescope is over the smaller one. For example, if the diameter of the large telescope is 100 cm and the smaller telescope is 10 cm, the light gathering power of the larger telescope will be 100 times greater than that of the smaller scope.

$$\frac{LGP_A}{LGP_B} = \left(\frac{100cm_A}{10cm_B} \right)^2 = \frac{10,000}{100} = 100$$

Light gathering power is an important measure of the potential performance of a telescope. If an astronomer is studying faint objects, the telescope used must have a sufficient light gathering power to collect enough light to make those objects visible. Even with the very largest telescopes, some distant space objects appear so faint that the only way they become visible is through long-exposure photography or by using CCDs. A photographic plate at the focus of a telescope may require several hours of exposure before enough light collects to form an image for an astronomer to study. Unfortunately, very large ground-based telescopes also detect extremely faint atmospheric glow, which interferes with the image. Not having to look through the atmosphere to see faint objects is one of the advantages space-based telescopes have over ground-based instruments.

Teacher Notes:

- In this activity younger students can use larger objects such as pennies, washers, or poker chips in place of the paper punchouts. Enlarge the black circles accordingly. Discs can be eliminated entirely by using graph paper and a

compass. Draw several circles on the graph paper and count the squares to estimate light gathering power of different sized lenses and mirrors.

- If students notice that the punchouts do not entirely cover the black circles, ask them what they should do to compensate for the leftover black space.

For Further Research:

- Compare the light gathering power of the various lenses you collected with the human eye. Have students measure the diameters, in centimeters, of each lens. Hold a small plastic ruler in front of each student's eye in the class and derive an average pupil diameter for all students. Be careful not to touch eyes with the ruler. If you have an astronomical telescope, determine its light gathering power over the unaided human eye.
- Does the light gathering power formula work for mirror type telescopes?
- Use the following formulas to determine other important measures of telescope performance:

Magnification (M) $M = \frac{F_o}{F_e}$

F_o is the focal length of the objective lens or mirror.

F_e is the focal length of the eyepiece lens.

Resolving Power (α) $\alpha = \frac{11.6}{D}$

Resolving power is the ability of a telescope to distinguish between two objects.

α is the resolving power in arc seconds

D is the diameter of the objective lens or mirror in centimeters.

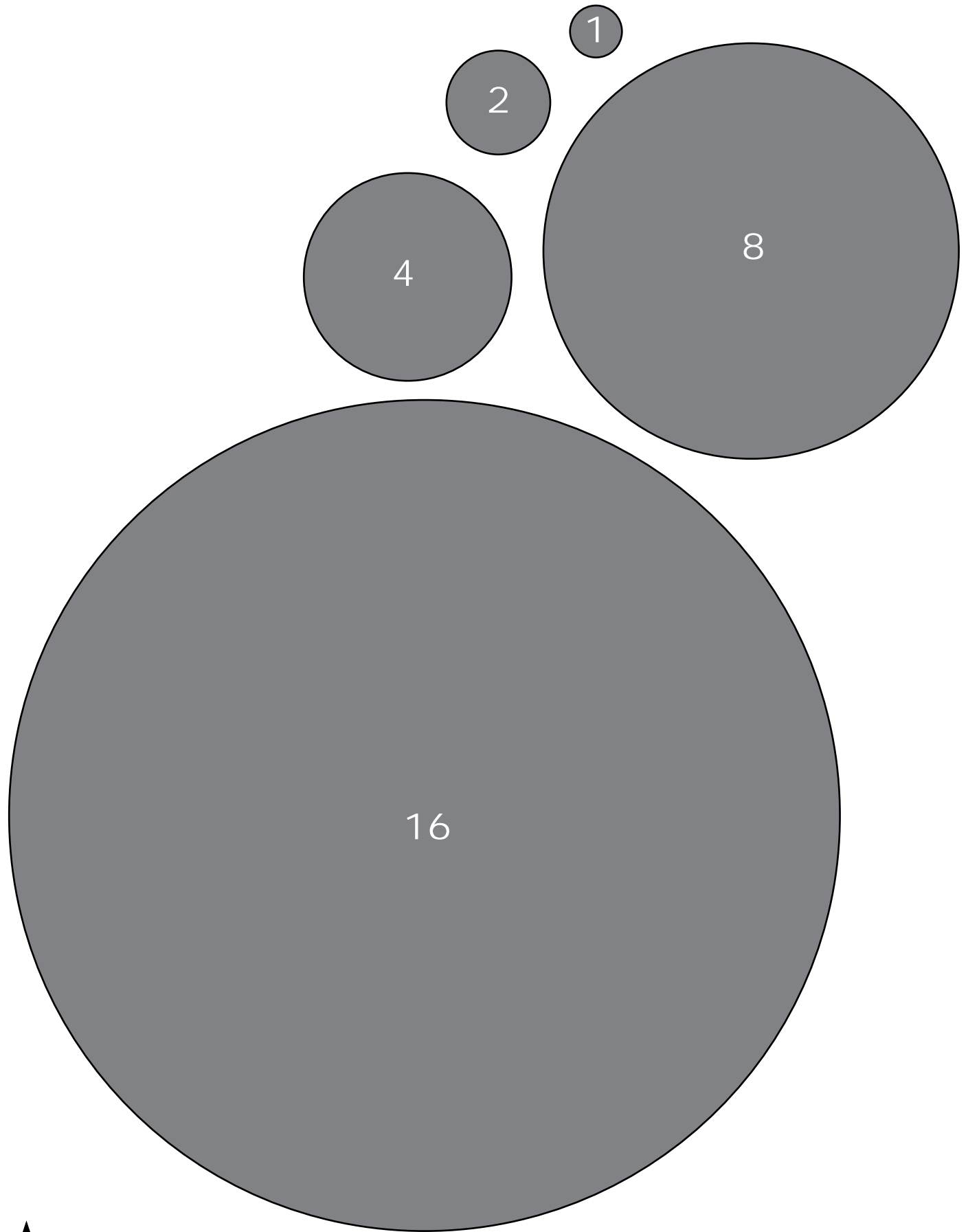

Liquid Crystal IR Detector

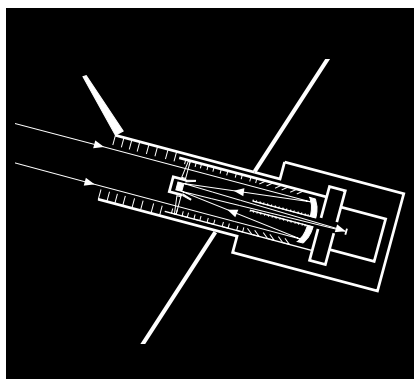

Description: Students simulate the detection of infrared radiation using a liquid crystal sheet.

Objective: To experiment with one method of detecting infrared radiation.

Materials:

Liquid crystal sheet (available at museum, nature stores, and science supply catalogs)
Table top

Procedure:

1. Have a student touch his or her fingertips on a table top for 30 seconds. Make sure the student has warm hands.
2. While handling the liquid crystal sheet only by its edges, place it where the fingertips touched the table. Observe what happens over the next several seconds.

Discussion:

Infrared telescopes have a detector sensitive to infrared light. The telescope is placed as high up in the atmosphere as possible on a mountain top, in an aircraft or balloon, or flown in space because water vapor in the atmosphere absorbs some of the infrared radiation from space. The human eye is not sensitive to infrared light, but our bodies are. We sense infrared radiation as heat. Because of this association with heat, telescopes and infrared detectors must be kept as cool as possible. Any heat from the surroundings will create lots of extra infrared signals that interfere with the real signal from space. Astronomers use cryogenics such as liquid nitrogen, liquid helium, or dry ice to cool infrared instruments.

This activity uses a liquid crystal detector that senses heat. Also known as cholesteric liquid crystals, the liquid inside the sheet

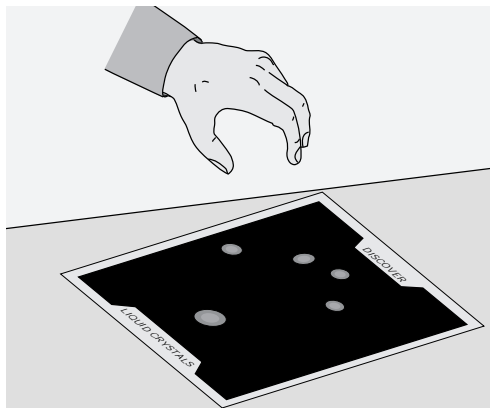

exhibits dramatic changes in colors when exposed to slight differences in temperature within the range of 25 to 32 degrees Celsius. When a student placed his or her fingers on a table top, heat from the fingertips transferred to the table's surface. The liquid crystal sheet detects the slight heat remaining after the student's hand is removed. A visible image of the placement of the fingertips emerges on the sheet. In the case of an infrared telescope in space, the energy is detected directly by instruments sensitive to infrared radiation. Usually, the data is recorded on computers and transmitted to Earth as a radio signal. Ground-based computers reassemble the image.

For Further Research:

- How was infrared radiation discovered?
- Why do infrared detectors have to be kept cold?
- Learn about cholesteric liquid crystals. An Austrian botanist Friedrich Reinitzer discovered them in 1888.

Down To Earth

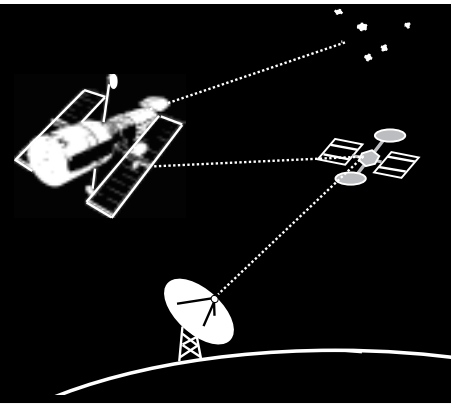

Introduction:

Although astronomers who work with ground-based telescopes have to deal with bad weather and atmospheric filtering, they do have one advantage over astronomers working with instruments in space. The ground-based astronomers can work directly with their instruments. That means that they can constantly check and adjust their instruments first-hand. Astronomers working with satellite-based instruments must do everything remotely. With the exception of telescopes mounted in the Space Shuttle's payload bay and the *Hubble Space Telescope*, which was serviced by Shuttle astronauts in 1993, astronomers can only interact with their instruments via radio transmissions. That means that the instruments have to be mounted on a satellite that provides radio receivers and transmitters, electric power, pointing control, data storage, and a variety of computer-run subsystems.

Data collection, transmission, and analysis is of primary importance to astronomers. The development of photomultiplier tubes and CCDs or charged coupled devices (See introduction in Unit 3.) provides astronomers with an efficient means of collecting data in a digital form, transmitting it via radio, and analyzing it by computer processing. CCDs, for example, convert photons falling on their light sensitive elements into electric signals which are assigned numeric values

representing their strength. Spacecraft subsystems convert numeric values into a data stream of binary numbers that are transmitted to Earth. Once received, computers reconvert the data stream to the original numbers that can be processed into images or spectra.

If the satellite is in a geostationary orbit, which permits it to remain above one location on Earth, these data may be continuously transmitted to ground receiving stations consisting of one or more radio antennas and support equipment. Geostationary satellites orbit in an easterly direction over Earth's equator at an elevation of approximately 40,000 kilometers. They orbit Earth in one day, the same time it takes Earth to rotate, so the satellite remains over the same part of Earth at all times.

Satellites at other altitudes and orbital paths do not stay above one point on Earth. As a result, they remain visible to a particular ground station for a short time and then move out of range. This requires many widely-spaced ground stations to collect the satellite's data. In spite of this, the satellite still spends much of its time over parts of Earth where no stations exist (oceans, polar regions, etc.). For this reason, one of the subsystems on astronomical satellites are tape recorders that store data until they can transmit it to ground stations.

In the mid 1980s NASA began deploying the Tracking and Data Relay Satellite System (TDRSS) into geostationary orbit. The purpose of these satellites is to relay data to ground stations. Because of their high orbits and their widely spaced station points over Earth's equator, the TDRSS satellites serve as relay points for lower satellites and the Space Shuttle. The system provides nearly continuous contact with spacecraft as they orbit Earth. TDRSS satellites relay data to a receiver at White Sands, New Mexico. From there, the data travel via telephone lines, fiber optic cable, or commercial communications satellites to its destination. Most astrophysics data travels from White Sands to the NASA Goddard Space Flight Center in Maryland for distribution to scientists.

Unit Objective

- To demonstrate how astronomical satellites use technology to collect optical data, transmit that data to Earth, and reassemble it into images.

Teaching Strategy

The activities in this unit demonstrate the imaging process of astronomical satellites such as the *Hubble Space Telescope*. Use the Magic Wand and Persistence of Vision activities together or as alternates. The Magic Wand activity shows how images can be divided and reassembled. The Persistence of Vision activity does the same thing, but lets students actively participate by making their own tubes. The two activities on color—Color Recognition and Colored Shadows—show how astronomy satellites collect color data and how that data can be reassembled on the ground. The Binary Number and Paint By The Number activities familiarize students with the process of data transmission to Earth and its reassembly into images.

Activity Titles

Magic Wand

Activity Objective: To demonstrate, through the property of persistence of vision, how an image falling on a CCD array is divided into individual pieces.

Application: Astronomy, Physical Science, Technology Education

Persistence of Vision Tube

Activity Objective: To demonstrate how individual pieces of data combine to produce complete images.

Application: Astronomy, Physical Science, Technology Education

Color Recognition

Activity Objective: To show how space observatories make use of monochromatic filters to collect data on the color of objects in space.

Application: Art, Astronomy, Physical Science, Technology Education

Colored Shadows

Activity Objective: To demonstrate how three colored lights can be combined to produce a wide range of secondary colors.

Application: Art, Astronomy, Physical Science, Technology Education

Binary Numbers

Activity Objective: To use the binary number system to transmit data as astronomical spacecraft do to Earth.

Application: Astronomy, Mathematics, Technology Education

Paint By The Numbers

Activity Objective: To simulate how light collected from a space object converts into binary data and reconverts into an image of the object.

Application: Art, Astronomy, Mathematics, Technology Education

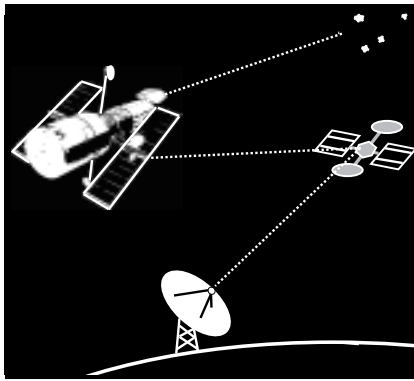

Magic Wand

Description: A recognizable image from a slide projector appears while a white rod moves rapidly across the projector's beam.

Objective: To demonstrate, through the property of persistence of vision, how an image falling on a CCD array is divided into individual pieces.

Materials:

Slide projector
 Color slide of clearly defined objects such as Saturn, a building, etc.
 1/2 inch dowel, 3 feet long
 Sheet of white paper
 White paint (flat finish)
 Dark room

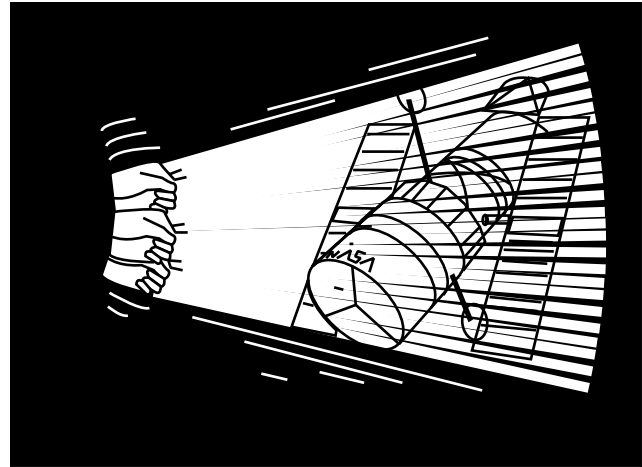

Procedure:

1. Paint the dowel white and permit it to dry. (A piece of 3/4 inch pvc water pipe from a hardware store can substitute for the dowel and white paint, and so can a meter stick.)
2. Set up the slide projector in the back of the classroom and focus the image of the slide at a distance of about 4 meters away from the projector. Hold up the sheet of paper in the beam at the proper distance for easy focusing. Be sure the focus point you selected is in the middle of the room and not near a wall.
3. Arrange the students between the focus point and the projector. Darken the room. Hold the dowel in one hand and slowly move it up and down through the projector beam at the focal point. Ask the students to try to identify the image that appears on the dowel.
4. Gradually, increase the speed of the dowel's movement.
5. When the dowel moves very fast, the image becomes clear.

Discussion:

Because astronomy spacecraft operate in space for many years, the data they collect cannot be recorded on camera film. There is simply no easy way to deliver the film to Earth for processing. Rather, the satellite instruments collect light from objects and divide it into discrete bits of information and radio them to Earth as a series of binary numbers. This activity demonstrates how images can be divided into many parts and then reassembled into a recognizable picture. By slowly moving the dowel across the slide projector's beam, small fragments of the image are captured and reflected ("radioed") towards the students. Because more and more fragments are sent as the dowel is moved, the image quickly becomes confused in the student's minds. However, as the rod is moved more rapidly, an important property of the eye and brain connection comes into play; light images are momentarily retained. This property is called *persistence of vision*. As the dowel's

movement increases, single lines of the image remain just long enough to combine with the others to form a recognizable image. In this manner, the rapidly moving rod simulates the CCD and the eye/brain interaction simulates the final imaging computer that receives the radioed data and reassembles it for use.

For Further Research:

- How do television studios create and transmit pictures to home receivers?
- How does a CCD work?
- Project some of the slides contained in the Astrophysics Division Slide Set described on page 82 of this guide. Magnify them as much as possible on a projection screen to see how the complete image consists of many discrete parts.

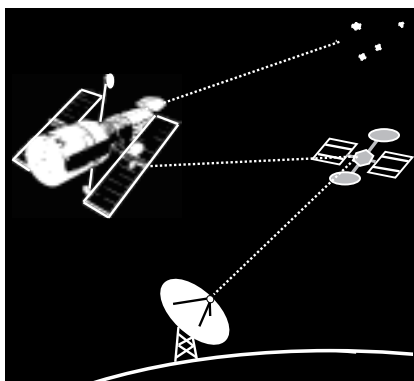

Persistence of Vision Tube

Description: Students can see a complete image by looking through a tube with a narrow slit at one end and moving it rapidly.

Objective: To demonstrate how individual pieces of data combine to produce complete images.

Materials:

Paper tube (mailing tube, tube from a roll of wrapping paper, a paper towel roll center, etc.)
 Opaque paper
 Pencil
 Ruler
 Scissors
 Tape

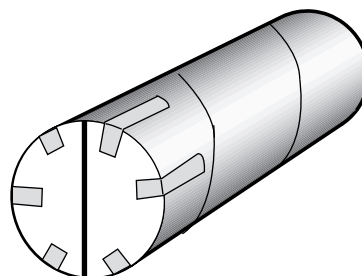

Procedure:

1. Trace one end of the tube on the opaque paper and cut out the circle.
2. Use the ruler to draw a straight line directly across the circle.
3. Cut out the circle and cut it in half along the straight line.
4. Tape each half of the circle on to one end of the tube leaving only a narrow slit about 2 mm wide.
5. Look through the other end of the tube. Try to make out the image of what you see. Slowly move the tube from side to side. Gradually increase the speed of the tube's movement.

Discussion:

This activity is a companion to the Magic Wand activity. By slowly moving the tube from side to side, small fragments of the outside world appear through the narrow slot. Each fragment quickly blurs as the tube moves. Like in the Magic Wand activity, a more rapid movement of the tube permits the eye's property of persistence of vision to help the viewer construct a complete mental image of the outside

scene. Refer to the Magic Wand activity for more details. **Note:** The tube and paper slit used here can also be used with the Simple Spectroscope activity (Unit 2) by mounting the diffraction grating over the open end.

Note: A much simpler version of this activity requires a 10 by 10 centimeter square of black construction paper and a pair of scissors. Fold the paper in half. Using the scissors, cut a narrow slit from the middle of the fold. Open the card up and quickly pass the slit across one eye while looking at some distant objects.

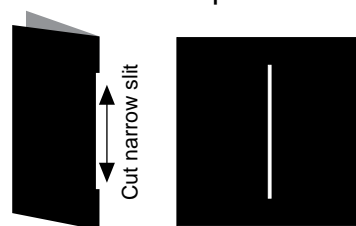

For Further Research:

- Use the tube to examine fluorescent lights. Why do slightly darker bands appear across the lights? **Hint:** Fluorescent lights do not remain on continuously. The light turns on and off with the cycling of AC current. Will using the tube to view an incandescent light have the same effect?
- Use the tube to examine the picture on a television screen. When students move the tube rapidly across the picture, why do lines appear?

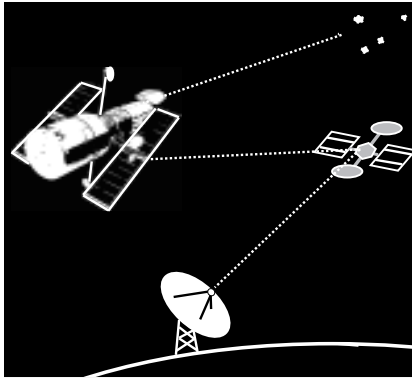

Color Recognition

Description: Students identify the actual colors of objects bathed in monochromatic light.

Objective: To show how space observatories make use of monochromatic filters to collect data on the color of objects in space.

Materials:

Indoor/outdoor colored flood lamps
(red, green, blue)
Lamp base
Various colored objects
(apple, banana, grapes, pear,
plum, etc.)
Dark room

Procedure:

1. Darken the classroom and turn on the red lamp.
2. Hold up the colored objects one at a time. Ask students to make notes as to how bright or dark the objects appear in the red light.
3. Turn off the red light and turn on the green light and repeat with the same objects. Repeat again, but this time use the blue light.
4. Turn on the room lights and show the students the actual colors of the objects.
5. Challenge the students to identify the colors of new objects. Show them the unknown objects in the red, green, and then blue lights. By using their notes, the students should be able to determine the actual colors of the objects.
6. Hold up a Granny Smith or Golden Delicious apple to see if the students can correctly judge its actual color or will instead jump to an erroneous conclusion based on shape.

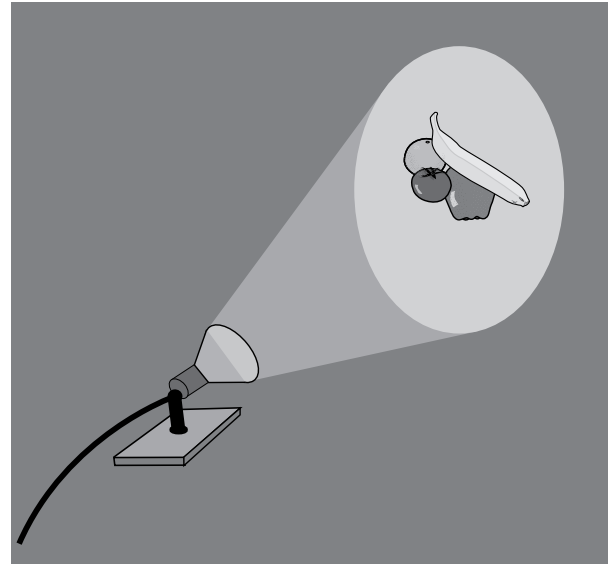

Discussion:

Astronomical spacecraft working in the visible region of the electromagnetic spectrum, such as the *Hubble Space Telescope*, collect images of stars and galaxies in various colors. Color filters rotate into the light path so that the detector sees one color at a time. The image in each of these colors is transmitted to Earth as a series of binary numbers. Image processing computers on Earth combine the data to reconstruct a multi-colored image.

Telescopes also use filters that pass only a very narrow range of wavelengths. This technique allows the astronomer to obtain an image that shows the light from just one element such as helium.

This activity demonstrates the color imaging process. By examining various objects in red, green, and then blue light, the students

note that the brightness varies with the illuminating wavelengths. Using colored lights is equivalent to observing the objects through colored filters. (See the note in the Colored Shadows activity that follows.) The way each object appears relates to its "real" colors as seen in normal light. By noting subtle differences in brightness in each of the three colored lights, the actual colors of the objects can be identified.

For Further Research:

- This activity also works using colored acetate filters taped over small windows cut into file cards. Sheets of red, green, and blue acetate can be purchased at art supply stores. Students can make their own filter cards and take them home to

look through the windows at a variety of objects. Better quality filters, that transmit "purer" colors, can be obtained from theatrical supply stores at a cost comparable to acetate filters. If your school has a theater department, you may be able to obtain filters (gels) from them.

- The following reference describes further activities with the filters:
Sneider, C., Gould, A., & Hawthorne, C. (1991), Color Analyzers Teacher's Guide, Great Explorations in Math and Science (GEMS), Lawrence Hall of Science, University of California at Berkeley. (Available from the museum or the National Science Teacher's Association.)

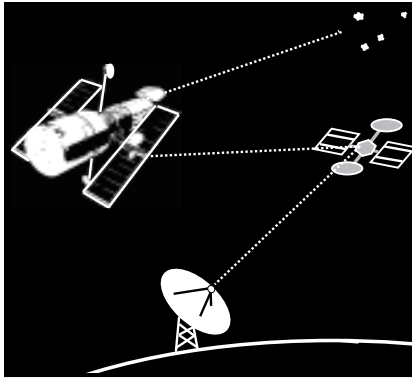

Colored Shadows

Description: Three colored floodlights (red, green, and blue) directed towards a screen produce colors ranging from black to white.

Objective: To demonstrate how three colored lights can be combined to produce a wide range of secondary colors.

Materials:

Indoor/outdoor floodlights (red, green, and blue)
Adjustable fixtures to hold the lights
Projection screen
Dark room

Procedure:

1. Prior to class, set up the three floodlights in a row at a distance of about 4 meters from the projection screen so that they each point to the center of the screen. The lights should be spaced about 1 meter apart. When properly aimed, the three lights should blend to produce a nearly white light falling on the screen. Move one or more lights closer to or farther away from the screen to achieve a proper balance.
2. With the room dark and the floodlights turned on, hold up your hand between the lights and the screen. Three colored shadows appear—yellow, cyan (a shade of blue), and magenta.
3. Move your hand closer to the screen. The shadows will overlap and produce additional colors—red, blue, and green. When all the shadows overlap, there is no color (light) left and the shadow on the screen becomes black.
4. Invite your students to try their "hand" at making shadows.

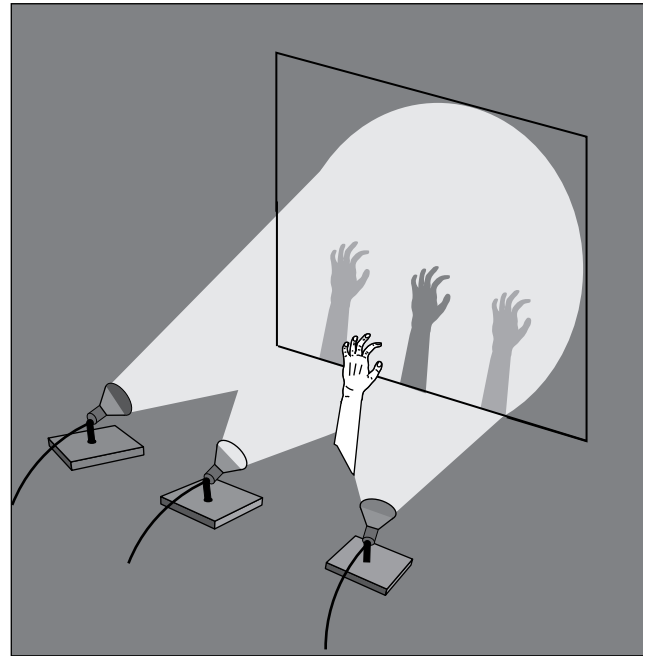

Discussion:

This activity extends the Color Recognition activity. It demonstrates how a few basic colors can produce a wide range of colors and hues. When the three lamps are set up properly, the screen appears whitish. When all shadows overlap, the shadows become black; black is the absence of light. In between white and black are the colors red, green, blue, cyan, yellow, and magenta. By moving the floodlights forward and back, a wide range of hues appear.

Astronomical satellites that collect images in the optical range often use colored filters to take multiple pictures of the same object. Combining the different colored images approximates what we think the true colors are. Usually, though, astronomers use

artificial colors to enhance the color differences. The colored shadow demonstration shows how a few colors can combine to make many colors or white, which is all colors combined.

Note: It is difficult to get a completely white screen with indoor/outdoor floodlights. The colors produced by them are not entirely monochromatic. Using much more expensive lamps produces a better white but the whiteness is not significantly enhanced. An alternative to the colored lamps is to obtain red, green, and blue theatrical gels (filters) and place them (one each) on the stage of three overhead projectors. Aiming each of the three projectors to the same place on

the screen produces the same effect as the lamps, but the colors are more intense.

For Further Research:

- Look at color magazine pictures. How many colors do you see? Examine the pictures with a magnifying glass. How many colors do you see? Also examine the picture on a color television screen.
- What common devices use red, green, and blue to produce colored pictures?
- Is there any difference in the additive color process between using lights and using paints?
- Punch a 2 cm hole in an opaque piece of paper. Adjusting the distance of the paper to the screen may help students investigate the color additive process.

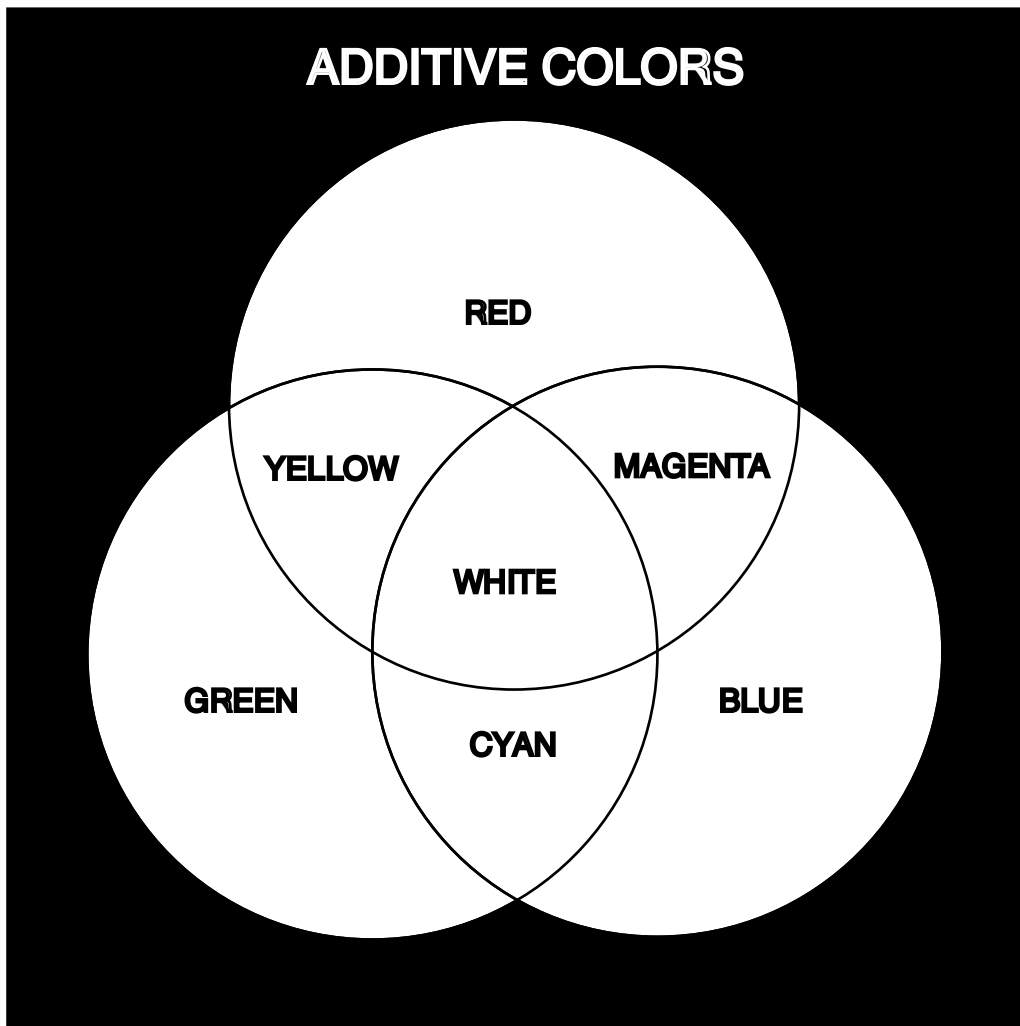

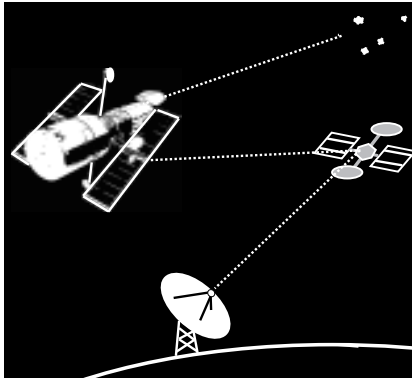

Binary Numbers

Description: A simple battery-powered light box demonstrates how to transmit images and other scientific data collected by astronomical spacecraft.

Objective: To use the binary number system to transmit data as astronomical spacecraft do to Earth.

Materials:

- Project box
- Battery holder (4 D or C-cells)
- 2 Push button switches (momentary on)
- 2 Flashlight bulb sockets
- 2 Flashlight bulbs
- Bell wire
- Wire cutter/stripper
- Drill and bits (size depends upon specifications for buttons and light sockets)
- Screwdriver (to tighten screws for project box lid)
- Binary code and data sheets*
- Pencils*

* One per student

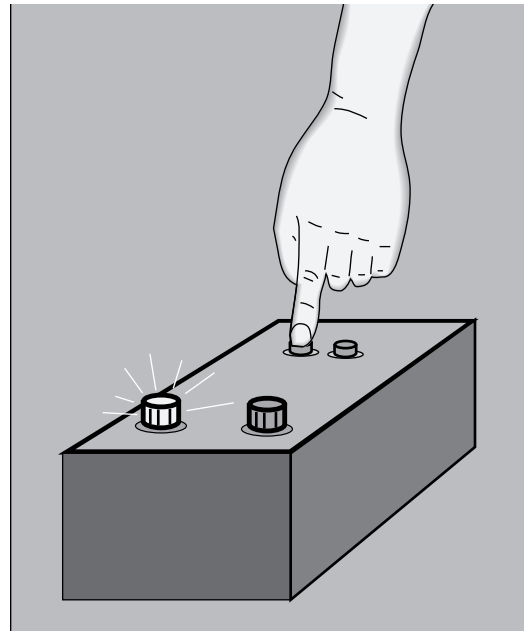

Procedure:

1. Following the wiring diagram on the next page, assemble the binary light box. If you do not have time to construct the box yourself, ask a student volunteer to assemble the box at home or ask a technology education teacher to have one of his or her students assemble it as a project.
2. Explain how astronomical spacecraft use the binary system to transmit, via radio waves, images and other scientific data from spacecraft to Earth. Refer to the discussion section for details on how the system works.
3. Distribute the data sheet and substitution code page to every student. Tap out a six number sequence of the push buttons on the binary light box. It may be necessary to dim the classroom lights. As the lights flash, each student should check off the appropriate box in the practice column. To make sense later, the students must check off the boxes representing green or red flashes in the exact sequence of the flashing lights. Refer to the sample on the next page to see how to make the checks. **Note:** If you have students who are color blind, be sure to identify which light is which. Substitute two solid state

buzzers of different pitch for the lights in the binary light box for use with visually impaired students.

4. For the practice columns, total up the numbers each sequential flash represents. For example, if all flashes are red, the value is $0+0+0+0+0+0 = 0$. If six green lights flash in a row, the value of the binary number is 63. The first green flash represents a 1, the second is 2, the third is 4, the fourth is 8, the fifth is 16, and the sixth is 32 ($1+2+4+8+16+32=63$). The following sequence of flashes is 37: Green, Red, Green, Red, Red, Green.
5. After the students become familiar with the method, transmit a message to the them. Create the message by referring to the substitution code in the following pages. Replace each word in your message with the corresponding code number. For example, "Hello!" would convert to 7, 4, 11, 11, 24, 38. Next, convert each code number into a binary number. Seven, for example, becomes Green, Green, Green, Red, Red, Red and 24 becomes Red, Red, Red, Green, Green, Red. As you will note in the substitution code, only the first 40 of the 64 possible numbers are used. The remaining numbers can be assigned to common words of your choosing such as "the" and "but," and to short sentences such as "How are you?" Transmit the message by flashing the lights in the proper sequence. Every six flashes represents a binary number that can be converted into a letter or word through the code. Students receive the message by checking the flashes on the data sheet, determining the binary numbers they represent, and then changing the numbers into letters or words.
6. Discuss how a picture could be translated through binary code. (Refer to the activity Paint By The Number.)

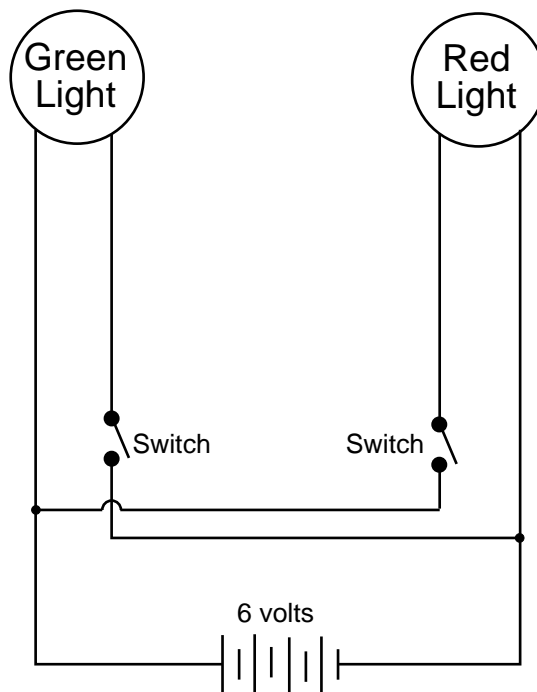

Binary Light Box Wiring Diagram

Discussion:

Because astronomical spacecraft operate in orbit around Earth, the images they collect of objects in space have to be transmitted to the ground by radio signals. To make this possible, the light from distant objects is concentrated on a light sensitive charged coupled device (CCD). The *Hubble Space Telescope* uses four CCD's arranged in a square. The surface of each CCD is a grid consisting of 800 vertical and 800 horizontal lines that create a total of 640,000 light sensitive squares called *pixels* for picture elements. With four CCDs, the total number of pixels in the *Hubble Space Telescope* CCD array is 2,360,000.

Photons of light, coming from a distant object, fall on the CCD array and are converted into digital computer data. A numerical value is assigned to the number of photons received on each of the more than two million pixels. This number represents the brightness of the light falling on each pixel. The numbers range from 0 to

255. This range yields 256 shades of grey ranging from black (0) to white (255).

These numbers are translated into a binary computer code on board the spacecraft. A binary number is a simple numeric code consisting of a specific sequence of on and off radio signals. They are the same codes that are used in computers. A binary number radio transmission can be compared to a flashing light. When the light is on, the value of the signal is a specific number. When the light is off, the value is 0.

A binary number usually consists of 8 bits (1 byte). The first bit in the sequence represents a 1. The second bit represents a 2. The remaining 6 bits represent 4, 8, 16, 32, 64, and 128 respectively. If all bits are "on" the value of the binary number is the sum of each bit value—255. If all bits are "off," the value is 0. A sequence of on, off, on, on, off, off, on, and off represents the numbers $1+0+4+8+0+64+0$, or 77. To save classroom time, the binary system has been simplified in this activity by using a 6-bit binary code. The total value of a 6-bit code is 64, or $1+2+4+8+16+32$.

After the image of the space object is encoded, the binary bits are transmitted by radio waves to a receiving station on the ground. The photons of light that fall on each of the 2,360,000 pixels are now represented by a data set consisting of 18,880,000 binary bits. They will be converted by a computer to a black and white image of the space object. If a colored image is desired, at least two more images are collected, each one taken through a different colored filter. The data from the three images

are combined by a computer into a composite image that shows the actual colors of the object being observed.

Because images collected by the HST and other astronomy spacecraft are digital, astronomers can use computers to manipulate images. This manipulation is roughly analogous to the manipulation of color, brightness, and contrast controls on a television set. The manipulation process is called *enhancement* and it provides astronomers with a powerful tool for analyzing the light from space objects.

To learn more about the imaging process, refer to the following activities in this guide: Paint By The Number, Colored Shadows, and Color Recognition.

For Further Research:

- Can binary numbers be used to transmit other scientific data besides images?
- How are binary numbers used in computers?
- How high can you count with a binary number consisting of 10 bits? 12?

Samples

	Green Light 1 0	Green Light 1 0
1	X	X
2	X	X
4	X	X
8	X	X
16	X	X
32	X	X
+		
Total:	0	37

	Green Light 1 0	Green Light 1 0
1	X	X
2	X	X
4	X	X
8	X	X
16	X	X
32	X	X
+		
Total:	63	63

Data Sheet

Practice

Green Light
Red Light

1	0
2	
4	
8	
16	
32	
+	
Total: ____	

1	0	1	0	1	0	1	0	1	0	1	0	1	0
2		2		2		2		2		2		2	
4		4		4		4		4		4		4	
8		8		8		8		8		8		8	
16		16		16		16		16		16		16	
32		32		32		32		32		32		32	
+		+		+		+		+		+		+	
Total: ____		Total: ____		Total: ____		Total: ____		Total: ____		Total: ____		Total: ____	

Practice

Green Light
Red Light

1	0
2	
4	
8	
16	
32	
+	
Total: ____	

1	0	1	0	1	0	1	0	1	0	1	0	1	0
2		2		2		2		2		2		2	
4		4		4		4		4		4		4	
8		8		8		8		8		8		8	
16		16		16		16		16		16		16	
32		32		32		32		32		32		32	
+		+		+		+		+		+		+	
Total: ____		Total: ____		Total: ____		Total: ____		Total: ____		Total: ____		Total: ____	

1	0	1	0	1	0	1	0	1	0	1	0	1	0
2		2		2		2		2		2		2	
4		4		4		4		4		4		4	
8		8		8		8		8		8		8	
16		16		16		16		16		16		16	
32		32		32		32		32		32		32	
+		+		+		+		+		+		+	
Total: ____		Total: ____		Total: ____		Total: ____		Total: ____		Total: ____		Total: ____	

1	0	1	0	1	0	1	0	1	0	1	0	1	0
2		2		2		2		2		2		2	
4		4		4		4		4		4		4	
8		8		8		8		8		8		8	
16		16		16		16		16		16		16	
32		32		32		32		32		32		32	
+		+		+		+		+		+		+	
Total: ____		Total: ____		Total: ____		Total: ____		Total: ____		Total: ____		Total: ____	

Substitution Code

0 1 2 3 4 5 6 7 8 9	A B C D E F G H I J	10 11 12 13 14 15 16 17 18 19	K L M N O P Q R S T	20 21 22 23 24 25 26 27 28 29	U V W X Y Z 0 1 2 3	30 31 32 33 34 35 36 37 38 39	4 5 6 7 8 9 . , ! ?
40 41 42 43 44 45 46 47 48 49		50 51 52 53 54 55 56 57 58 59		60 61 62 63			

Message

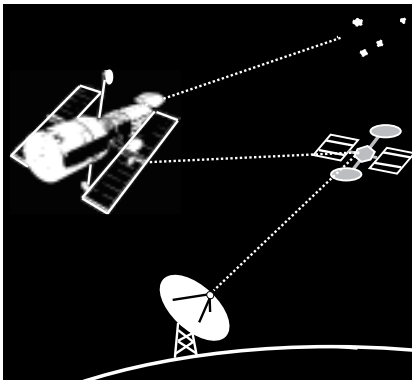

Paint By The Numbers

Description: A pencil and paper activity demonstrates how astronomical spacecraft and computers create images of objects in space.

Objective: To simulate how light collected from a space object converts into binary data and reconverts into an image of the object.

Materials: (per group of two students)

Transparent grid
Paper grid
Picture of house
Pencil

Procedure:

1. Divide students into pairs.
2. Give one student (A) in each pair the paper copy of the grid on the next page. Give the other student (B) in each pair the picture of the house on the next page. Instruct student B not to reveal the picture to student A. Also give student B a copy of the transparent grid. (See notes about making student copies of the picture and grids on the next page.)
3. Explain that the picture is an object being observed at a great distance. It will be scanned by an optical device like those found on some astronomical satellites and an image will be created on the paper.
4. Have student B place the grid over the picture. Student B should look at the brightness of each square defined by the grid lines and assign it a number according to the chart above the picture. Student B will then call out the number to student A. If a particular square covers an area of the picture that is both light and dark, student B should estimate its total brightness and assign an

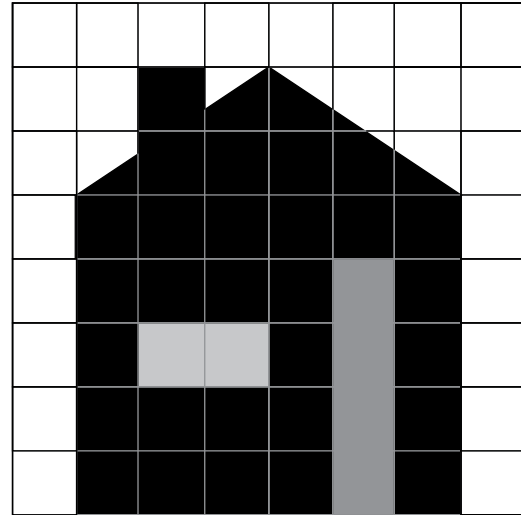

- intermediate value to the square such as a 1 or a 2. **Note:** The letters and numbers on two sides of the grid can assist the receiving student in finding the location of each square to be shaded.
5. After receiving a number from student B, student A will shade the corresponding square on the grid. If the number is 0, the square should be shaded black. If it is 3, the square should be left as it is.
 6. Compare the original picture with the image sketched on the paper.

Discussion:

In this activity, the student with the transparent grid represents an astronomical spacecraft. The picture is the object the spacecraft is trying to image. The student with the paper grid represents the radio receiver on the ground and the image processing computer that will assemble the image of the object.

The image created with this activity is a crude representation of the original picture. The reason for this is that the initial grid contains only 64 squares. If there were many more squares, each square would be smaller and the image would show finer detail. You may wish to repeat this activity with a grid consisting of 256 squares. However, increasing the number of squares will require more class time.

This activity shows how astronomical satellites such as the *Hubble Space Telescope* produce simple black and white images. With the HST, the grid consists of more than 2.5 million pixels and they are shaded in 256 steps from black to white instead of just the 4 shades used here.

Color images of an object are created by the HST with color filters. The spacecraft



Sample Picture

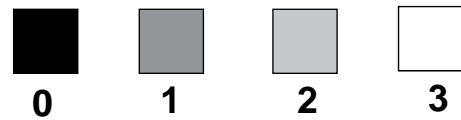

Shading Values

	1	2	3	4	5	6	7	8
A								
B								
C								
D								
E								
F								
G								
H								

Grid

Make a copy of this picture on white paper and a copy of the grid to the right on overhead projector transparency plastic for student B in each group.

Make a copy of the grid on white paper for student A in each group. Make a transparency of this grid for student B in each group.

observes the object through a red filter, a blue filter, and then a green one. Each filter creates a separate image, containing different information. These images are then colored and combined in a process similar to color separations used for printing colored magazine pictures. Refer to the Color Recognition and Colored Shadows activities for more details on how color filters work and how to combine colors.

For Further Research:

- Transmit and reconstruct the image on the next page. This more advanced picture uses six shades and smaller grid squares.
- Examine printed copies of drawings made with a computer art program. Notice how the pictures are constructed of individual points. Also notice how the size of the points contributes to the fineness of detail in the picture.
- Examine pictures drawn on a computer. Use the magnifying tool to move to the maximum magnification possible. Compare the two views.
- Obtain the *Astrophysics Division Slide Set*. Project the slides on a screen and examine them closely for details on picture construction. (See page 82.)

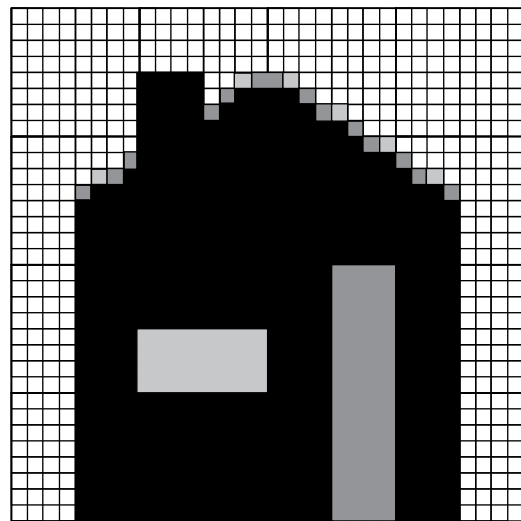
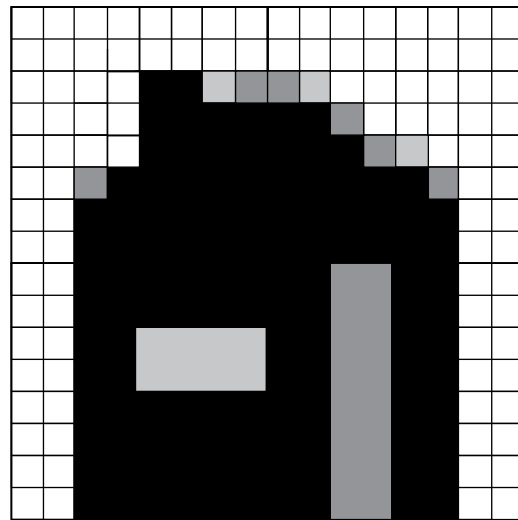
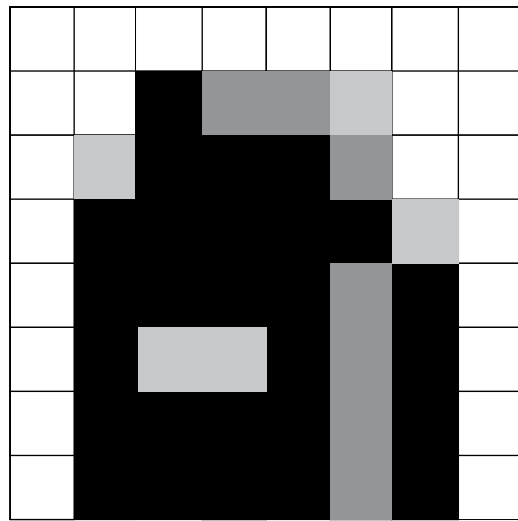

Effects of Increasing the Number of Pixels

