

Cold Fusion and the Future

Jed Rothwell

LENR-CANR.org

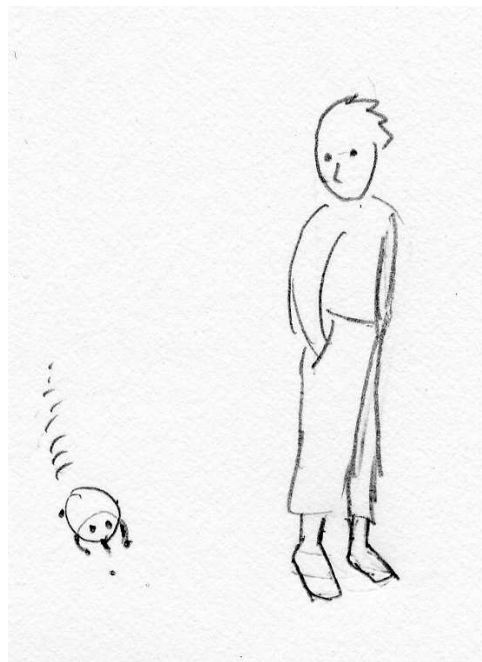

Cold Fusion and the Future

Jed Rothwell

Published by LENR-CANR.org, December 2004.
Second Edition, February 2005
Third Edition, March 2006
Fourth Edition, April 2007

Edited by Susan Seddon
Cover illustration by Aya Rothwell

This book is not copyright. You are free to give a copy to a friend, but we ask that instead of doing so, you refer other readers to the web site and ask them to download a copy directly. That will allow us to gauge how many people have looked at the book, and the extent of public interest.

Two versions of this document are available. This one is suitable for viewing on the screen:

<http://lenr-canr.org/acrobat/RothwellJcoldfusiona.pdf> (6 MB)

If you wish to print a copy, we recommend the high-resolution version:

<http://lenr-canr.org/ColdFusionAndTheFuturehires.pdf> (15 MB)

Table of Contents

Introduction.....	1
Part I: What Is Cold Fusion?.....	7
1. A Brief Description of Cold Fusion.....	8
2. The Ideal Source of Energy	23
3. How We Can Make Some Predictions Now.....	38
Part II: How Cold Fusion Will Change Society and Technology.....	41
4. Ordinary Technology, Everyday Goods and Services.....	42
5. Revolutionary Technology.....	52
6. Synergy: Cold Fusion Combined With Other Breakthroughs	56
7. Patterns of Transformation	60
Part III: Some Technologies That Will Be Changed	75
8. Desalination Megaproject	76
9. Global Warming.....	80
10. Robot Chickens and Other Prodigies.....	85
11. Mischievous Military Gadgets.....	96
12. Terror Weapons, And Weapons of Mass Destruction	103
13. The Oil Industry Has No Future	107
14. The Electric Power Industry Has No Future.....	110
15. At Home with Cold Fusion.....	120
16. Population, Pollution, Problems with Land and Agriculture.....	126
17. The Future of Automobiles.....	139
18. The Future of Aircraft, Spacecraft and Personal Flying Machines	149
Part IV: The Future	159
19. Making Things Worse, and What Some Pessimists Fear	160
20. Unemployment.....	165
21. My Vision of Life In The Distant Future.....	169
Appendix A: Glossary.....	175
Appendix B: Potential Cold Fusion Applications.....	183
Appendix C: Approximate SI (Metric System) Equivalents	185
Sources.....	187
Index	188

Introduction

The purpose of this book is to show that with cold fusion we can accomplish marvelous things. This is not a review or history of the field. It is not meant to convince the reader that cold fusion exists. If you doubt that, please read original sources: the scientific papers published in peer-reviewed journals and conference proceedings. You will find a bibliography of over 3,500 papers at <http://lenr-canr.org>, along with a collection of over 500 full-text papers.

Cold fusion has been successfully replicated in hundreds of university and national laboratories. These experiments prove that cold fusion does exist. In some instances it has produced temperatures and concentrated energy high enough for practical applications. If cold fusion can be commercialized it will eliminate most pollution and save billions of dollars a day now spent on fossil fuel. It will be a godsend to the billions of people living in abject poverty. In wealthy nations it will offer a renewed sense of wonder, and hope for the future.

Unfortunately, this research has been suppressed in the United States. Papers cannot be published; experiments are not funded. The Department of Energy reviewed the subject 2004. The official summation was a farce,^{1,2} but some of the reviewer's comments were thoughtful,³ so perhaps there is a ray of hope. Even so, the fight to allow a modicum of research is likely to continue for years. The purpose of this book, then, is to inspire the reader, and, perhaps, to enlist him in this political battle.

Most cold fusion researchers are interested in the science, rather than potential benefits. They want to know what the phenomenon reveals about nature, and how it might be explained theoretically. The public, on the other hand, generally wants to know: What can cold fusion do for me? Can it really end the energy crisis? Or will it be another disappointment, the way conventional nuclear energy has turned out to be. This is not self-serving. The public is right to be worried about energy, and to put people's needs first. The energy crisis grows worse year by year. Destructive global warming may finally be upon us: in 2004, unprecedented, out-of-season typhoons repeatedly struck Japan, and the water level in the Inland Sea has risen dramatically. Many of our worst political crises are mixed up with energy, especially oil. The Iraq war may not be "a war for oil" as some critics charge, but oil is surely a proximate cause. If the Middle East did not have oil, the U.S. would not be embroiled there. Energy is often the story behind the headlines. Energy production causes most air pollution. The lack of energy in the third world is the single largest preventable cause of disease, misery, and death.

In this book, rather than talk about the present status of research, I would like to look far ahead, dream, and speculate. I hope the reader has as much fun reading this as I have had writing it. This book is not a serious technical analysis of near term R&D or market opportunities. Please consider it nonfiction science fiction, along the lines of Arthur C. Clarke's masterpiece *Profiles of the Future*.^{4,5} Alert readers will note that I have shamelessly plagiarized many of the ideas in

¹ DOE, *Report of the Review of Low Energy Nuclear Reactions*. 2004, Department of Energy, Office of Science, <http://lenr-canr.org/acrobat/DOEreportofth.pdf>

² LENR-CANR.org, Special Collection, 2004 DoE Review of Cold Fusion, <http://lenr-canr.org/Collections/DoeReview.htm>

³ DOE, 2004 *U.S. Department of Energy Cold Fusion Review Reviewer Comments*. 2004, Department of Energy, Office of Science, <http://lenr-canr.org/acrobat/DOEusdepartme.pdf>

⁴ Clarke, A.C., *Profiles of the Future*. 1963: Harper & Row.

Profiles, such as desalination megaprojects, mining the sea, hovercraft, and autonomous (self-driving) automobiles.

While some of the predictions in this book are far-fetched, and some are whimsical, in every case I have based them on actual cold fusion experimental results, and upon likely improvements in other technology such as parallel processing, thin-film diamonds and carbon fiber. As far as I know, even the most far-fetched predictions here are physically possible. To take an outrageous example, I suppose it will someday be possible to build a giant carbon-fiber geodesic dome covering downtown Las Vegas, and to air-condition the city. That does not mean it will be practical, or desirable. The cost of equipment would probably make this project too expensive, even with zero-cost cold fusion energy. The citizens of Las Vegas may not wish to air-condition their city. But in any case, it could be done with cold fusion, whereas it would be out of the question with any other source of energy.

Some cold fusion findings are more solid than others. The high temperature tungsten glow discharge (plasma) experiments have only been replicated by Ohmori, Mizuno,⁶ Cirillo,⁷ and two other researchers as far as I know. I am not aware of any error in this work. Mizuno has replicated the effect hundreds of times over many years, and he uses the best instruments money can buy. However, until the experiment is more widely replicated, we cannot be sure it is real, and predictions based upon it are tentative. On the other hand, moderate temperatures between 50 and 150°C have been replicated by hundreds of researchers, and they are real beyond any question. Rejecting them is tantamount to rejecting the experimental method itself. If cold fusion can be commercialized, we surely will see moderate-temperature space heating and steam turbines, but we may not see intense, high temperature cold fusion plasma.

Cold fusion will change the way we make countless future products: everything from space heaters to factory kilns, municipal street lighting, and airplanes. In this book, however, I have only considered how it will affect a handful of machines: mainly automobiles, power generators, and autonomous robots. I have ignored most of the incremental changes it will give rise to. As if cold fusion itself were not controversial enough for one book, I have concentrated on provocative, problematic, and downright unbelievable technology that would have a profound impact on society. For example, I propose we scrap the interstate highway system and rebuild it underground. I trust the reader will find this scheme more interesting than a discussion of swimming pool heaters, and will forgive me for blithely ignoring the cost of this fantastic megaproject. The cost would be astronomical with today's technology, perhaps a hundred times greater than our present aboveground highway system. I am assuming that over decades or centuries the project will become thinkable, and then gradually, in stages, the cost will fall and our wealth will increase until it becomes feasible. Small-scale underground highway construction such as the Big Dig project in Boston will demonstrate the benefits of putting roads underground, and encourage society to invest in new excavation technology and construction techniques. Costs will decline, and sometime in the next few centuries I hope the project will begin in earnest.

⁵ Clarke, A.C., *Profiles of the Future, Millennium Edition*. 1999: Indigo. This edition includes some discussions of cold fusion.

⁶ Mizuno, T., et al., *Production of Heat During Plasma Electrolysis*. Jpn. J. Appl. Phys. A, 2000. **39**: p. 6055.

⁷ Cirillo, D. and V. Iorio. *Transmutation of metal at low energy in a confined plasma in water*. in *Eleventh International Conference on Condensed Matter Nuclear Science*. 2004. Marseille, France. <http://www.lenr-canr.org/acrobat/CirilloDtransmutat.pdf>

I have thrown in some absurd and outrageous ideas because I find them amusing. Above all, I am interested in big ideas that can fix big, intractable problems.

The *New York Times* recently declared, “energy independence” is “an unattainable goal, largely because the United States, which uses one-quarter of the world’s oil production, owns less than 3 percent of the world’s oil reserves.”⁸ In other words, the *Times* thinks that we will never discover alternative sources of energy large enough to replace oil. They said “unattainable,” not “unattainable in the short run” or “unattainable for at least 20 years without vigorous research.” Cold fusion would almost instantly hand us this “unattainable” goal. It could give us ten times more energy than we now use, or a thousand times more. The only practical limitation will be how much waste heat we can generate without harming the environment. Combined with other technologies and used wisely, cold fusion can solve many nightmare problems that seem beyond our ability to deal with, such as global warming, clean drinking water and sanitation for billions of poor people, pollution, invasive beetles and other species that threaten land and sea, and finding terrorists and criminals who hide in inaccessible wilderness. It may seem strange that a new source of energy can help fix such disparate problems, but I hope to show that cold fusion has that capability.

This is a book of predictions, not engineering specifications. If, in the future, these problems are fixed with cold fusion powered machinery, the machines will be far different from anything I have portrayed here, or indeed, anything I can imagine. I am only suggesting what might be done in principle, to show that solutions are possible.

I doubt that anyone now living can grasp all the ramifications of cold fusion, or imagine more than a small number of ways it will be used. We have no experience working with it, and no feel for it. Someday, product engineers who have dealt with cold fusion all their lives will take its capabilities for granted, and they will instinctively know how to apply it in ways that would never occur to us. In 1970, the most forward thinking computer engineer or futurist probably did not imagine that people in 1990 would be stuffing microscopic computers into automobile fuel injection systems, kitchen blenders, hotel guest room door locks, Jacuzzi bathtubs, cameras, “fuzzy logic” rice cookers,⁹ handheld radio-telephones, and thousands of other machines. Computer experts were masters of arcane hardware and software, but they knew nothing about cooking rice. They thought of computers as accounting machines, or handy tools in the laboratory, not as gadgets to cook rice with. When microprocessors came along, the people who make rice cookers saw how to use them. Product engineers everywhere went to work, putting computers in new places and using them in new ways. In retrospect, most of these improvements were predictable. Any hotel manager or guest can see the advantages of computerized doors and access cards. What makes the future difficult to imagine is not any particular incremental improvement, but rather what happens when all sorts of different machines are improved simultaneously. When cold fusion power supplies become available in every size from a hearing aid battery to an aerospace engine, product designers everywhere will find novel ways to use them, and the cumulative changes will affect our lives and societies more profoundly than the microcomputer revolution did.

⁸ *New York Times*, lead editorial, September 13, 2004, “CAMPAIGN 2004: THE BIG ISSUES Looking for Energy in the Campaign”

⁹ Such as the Zojirishi *Neuro Fuzzy*®, Model No. NSBC-E10

Some readers may feel it is pointless to discuss how cold fusion may shape the future when the research is struggling against harsh political opposition, when most researchers are discouraged, retired professors in their seventies and eighties, and when cold fusion cells have seldom produced more than a few watts of power. Cold fusion powered cars are but a distant dream today. But I think we must have hope and a compelling vision of a brighter future to sustain us in this long, bitter, unequal fight.

While I would like to avoid politics, nothing about this subject makes sense until you realize that it is mired in rivalry, hostility, and the suppression of academic freedom. Distinguished, tenured professors and Institute Fellows are supposed to be free to study any topic they choose, but when they have tried to publish positive cold fusion results, they have been ordered not to publish or give lectures, and they have been harassed and reassigned to menial jobs as stock clerks.

The American Physical Society (APS) told Nobel laureate Julian Schwinger he would not be allowed to publish papers or even letters on cold fusion in APS journals, even though normally a Nobel laureate is allowed to publish anything he wishes. Schwinger resigned in protest, saying:

The pressure for conformity is enormous. I have experienced it in editors' rejection of submitted papers, based on venomous criticism of anonymous referees. The replacement of impartial reviewing by censorship will be the death of science.¹⁰

Years later I asked a high-ranking member of the APS about this. He told me they considered Schwinger insane because he believed in cold fusion, and they wanted to protect his dignity, so they refused to publish his papers.

It must be noted that most scientists have remained neutral. Some are uninterested, but most appear to be open-minded and favorably disposed toward cold fusion. Hundreds of thousands of people have downloaded technical papers from LENR-CANR.org. We assume most readers are scientists, because these papers are technical, difficult, and would not interest anyone else. The problem is that researchers do not have time to explore every new idea, so they usually accept evaluations in journals such as *Nature* and *Scientific American*, or in the newspapers. Unfortunately, a small clique of influential opponents has outsized influence over the mass media, and they have prejudiced both the public and scientists against the subject. They include John Maddox, the former editor of *Nature*, Jonathon Piel and John Rennie, the previous and present editors of the *Scientific American*,¹¹ and John Huizenga, the head of the Department of Energy ERAB panel that was charged with investigating cold fusion in 1989.¹² Other prominent opponents are at the Department of Energy, many in the plasma fusion program. Robert Park, spokesman for the APS, is particularly vituperative and closed-minded. In 1991 he denounced cold fusion in the *Washington Post* as the result of "foolishness or mendacity" and he repeated that charge in 2002.^{13,14} Leading cold fusion researchers have offered him copies of papers, but he refuses to read them. In 1999, when I met him in person at an APS conference, I tried to hand

¹⁰ Schwinger, J., *Cold fusion: Does it have a future?* Evol. Trends Phys. Sci., Proc. Yoshio Nishina Centen. Symp., Tokyo 1990, 1991. **57**: p. 171. <http://lenr-canr.org/acrobat/SchwingerJcoldfusiona.pdf>

¹¹ Appeal to Readers, LENR-CANR.org, <http://lenr-canr.org/AppealandSciAm.pdf>

¹² Cold Fusion Research, November 1989, A Report of the Energy Research Advisory Board to the United States Department of Energy, <http://www.ncas.org/erab/>, <http://lenr-canr.org/acrobat/ERABreportofth.pdf>

¹³ Park, R., *The Fizzle in the Fusion*, in *Washington Post*. 1991. p. B4.

¹⁴ Park, R., Letter to Frank Znidarsic, 2002.

him printed copies of papers by McKubre and others. Not only did he refuse to read them, he would not touch them. He let them fall to the floor.

This book is predicated on the hope — not the prediction! — that cold fusion will overcome rabid political opposition and excruciating technical difficulties, and the effect will eventually be developed and commercialized. While I am quite sure the experiments are correct and the effect is real, I am not confident the opposition can be pushed aside. It depends upon two things:

First, as Max Planck put it, progress in science occurs “funeral by funeral.” He explained: “A new scientific truth does not triumph by convincing its opponents and making them see the light, but rather because its opponents eventually die, and a new generation grows up that is familiar with it.”¹⁵ Many powerful establishment scientists oppose cold fusion with such irrational vehemence they will probably never admit they are wrong, and the research will have to wait until they die. Unfortunately, most cold fusion researchers are elderly retired scientists and they are dying off faster than the opposition.

Second, nothing will happen until the public demands action. Samuel Florman wrote:

Sir Hugh E. C. Beaver, addressing the First International Congress on Air Pollution in 1955, traced the seven hundred year long campaign against air pollution in England. Complaint after complaint, committee after committee, report after report — all were ineffectual, as the centuries passed, and conditions grew progressively worse. Finally the London Smog of 1952, with its horrendous 4,000 deaths, set the scene for a new investigating committee, which was chaired by Sir Hugh. The committee’s report was well received, said Beaver, and led to effective action, not because the report was exceptional in any way, but because the public was, at long last, receptive. The lesson to be learned, according to Beaver, is that “on public opinion, and on it alone, finally rests the issue.”¹⁶

The public will not act until we convince it that cold fusion is worth funding.

Cold fusion may not pan out, so we must forge ahead and deal with the energy crisis using tried-and-true conservation, good engineering, social reform, and proven alternative energy sources such as wind power. We should give uranium fission a second chance. I would never advocate a pie-in-the-sky, \$100 billion crash program to develop cold fusion. That is far too great a sum to risk on cold fusion in its present state. On the other hand, we should take a calculated risk, and fund research to investigate solid, replicated, promising cold fusion experiments, because the stakes are so high. Every day, worldwide, people spend \$3.7 billion on fossil fuel, to generate 0.9 quads of energy. Cold fusion would generate that much energy from 15 tons of heavy water, which would cost approximately \$3.5 million. Imagine what \$3.7 billion per day could do for society! Imagine the benefits that would flow if this money were spent on housing, education, food and infrastructure, instead of oil and coal. Every week, roughly 42,000 children¹⁷ die from waterborne infectious disease their parents could easily prevent if only they had enough fuel to boil drinking water, cook food properly, and stay warm in winter.

Cold fusion research is a risk worth taking, and a cause worth fighting for, no matter how high the odds against it may be.

¹⁵ Planck, M., *A Scientific Autobiography*, 1948: Philosophical Library, p. 33 (translated by E. Gaynor)

¹⁶ Florman, S., *The Existential Pleasures of Engineering*. 1996: St. Martin’s Griffin, p. 40.

¹⁷ Pruss, A., et al., *Estimating the Burden of Disease from Water, Sanitation, and hygiene at a Global Level*. Environmental Health Perspectives, 2002. **110**(5).

Even the cold fusion researchers do not realize how vast the consequences of their work may turn out to be. Cold fusion will be far more than a clean “replacement” for present-day energy systems. Calling it a replacement is like saying that a Pentium computer connected to the Internet is a replacement for a slide rule and a typewriter. Cold fusion will be orders of magnitude cheaper, more abundant and less polluting. It will be qualitatively better in ways we can hardly imagine.

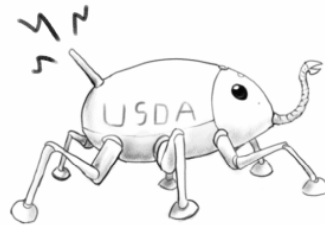

Acknowledgements

Many of the themes in this book are compiled and updated from articles I wrote in *Infinite Energy* magazine. I am indebted to the late editor and cold fusion pioneer Eugene Mallove. The editor Susan Seddon made many helpful suggestions, and her rewrites give the book a hint of British English diction. In the Japanese edition, Tadahiko Mizuno and Junko Ono assisted with the translation and made many helpful suggestions. Thanks to Sergio Bacchi for translating the book into Brazilian Portuguese.

Part I: What Is Cold Fusion?

1. A Brief Description of Cold Fusion

In a university library or the LENR-CANR.org online library, readers will find hundreds of papers describing cold fusion from an experimentalist's point of view, and many papers describing theory. Since this book is about potential technology, rather than detailing specific experiments, this section is a brief, simplified FAQ (a set of Frequently Asked Questions). For a more comprehensive technical review of the field, we recommend *A Student's Guide to Cold Fusion*.¹⁸

Who discovered cold fusion?

Cold fusion was discovered by Professors Martin Fleischmann and Stanley Pons, and announced in March 1989. Other researchers had earlier observed fleeting evidence for it. In the 1920s Paneth and Peters thought they had measured helium from a metal hydride room temperature fusion reaction, but they later retracted the claim.¹⁹ Y. E. Kim believes that P. I. Dee may have seen evidence for cold fusion in 1934.²⁰ In 1981, around the time Fleischmann and Pons were beginning their experiments, Mizuno observed strange charged particles from palladium deuterides, but after puzzling over them for some time, he dismissed them as instrument error.²¹ Unlike these early researchers, Fleischmann and Pons observed a clear signal, which they repeated many times, and after years of effort in the 1980s they developed fairly reliable techniques to reproduce the effect.

What is cold fusion?

It is a reaction that occurs under certain conditions in metal hydrides (metals with hydrogen or heavy hydrogen dissolved in them). It produces excess heat, helium, charged particles, and occasionally a very low level of neutrons. In some experiments the host metal has been transmuted into other elements. The cold fusion reaction has been seen with palladium, titanium, nickel, and with some superconducting ceramics.

What is excess heat?

Many chemical and nuclear processes are exothermic, meaning they release heat. For example, when you strike a match, you heat it with friction. It catches on fire and burns until the fuel is exhausted. It releases stored energy; overall it produces much more output than the input heat from friction. Some gas-loaded cold fusion cells are similar: once the reaction gets underway, no energy is input, and a stream of heat comes out. Other devices require an external source of electrical energy to maintain the conditions that keep the reaction going. The input electricity produces some heat, and the cold fusion reaction produces additional or "excess" heat. When you input 2 watts of electrolytic power and the cell produces 3 watts, 1 watt is excess.

¹⁸ Storms, E., *A Student's Guide to Cold Fusion*. 2003, LENR-CANR.org, <http://lenr-canr.org/acrobat/StormsEastudentsg.pdf>

¹⁹ Mallove, E., *Fire From Ice*. 1991, NY: John Wiley, p. 104

²⁰ Kim, Y.E., *Possible Evidence of Cold D(D,p)T Fusion from Dee's 1934 Experiment*. Trans. Fusion Technol., 1994. **26**(4T): p. 519. ICCF-4 version: <http://lenr-canr.org/acrobat/KimYEpossibleeva.pdf>

²¹ Mizuno, T., *Nuclear Transmutation: The Reality of Cold Fusion*. 1998, Concord, NH: Infinite Energy Press, p. 35

From a practical point of view, heat is the most important aspect of cold fusion. Some researchers, including Fleischmann, feel it is also the best proof that the reaction is nuclear, not chemical. This aspect of cold fusion has been widely misunderstood. It is discussed in detail in the next section.

Is cold fusion chemical, nuclear or something else?

This is explained in detail in the next section. To summarize briefly: Cold fusion cannot be a chemical process because it consumes no chemical fuel and it produces no chemical ash. Cold fusion cells contain mostly water, which is an inert substance that cannot burn or undergo any other exothermic chemical reaction. Cells also contain metal hydrides, which can produce small amounts of chemical heat, but cold fusion cells have produced hundreds of thousands of times more energy than a chemical cell of the same size could. In some cases, this large energy output is the product of a very low level of power integrated over a long time, which means it could be an error. A researcher might mistakenly think he is measuring 50 milliwatts excess, when there is actually zero excess. But several experiments have produced much higher power, ranging from 500 to 10,000 milliwatts (0.5 to 10 watts), and this much heat can be measured with great confidence.

Cold fusion does produce nuclear as opposed to chemical ash, including: helium, a small number of neutrons, and in some cases tritium and transmutations in the host metal. It sometimes produces gross physical changes, such as melted or vaporized metal. (See Chapter 2, Section 6.)

If cold fusion cells are nuclear, why aren't they extremely hot?

Some people think that because nuclear reactions produce gigantic amounts of energy, they must be very hot, like the inside of a fission reactor or the photosphere of the sun. This is not necessarily so. A sample of impure radium or uranium that is undergoing fission might be cold to the touch, or barely warm. The individual fission reactions that occur atom by atom inside them produce millions of electron volts (eV) of energy, whereas the atoms in a chemical reaction release at most 3 or 4 electron volts.

A chemical reaction might produce much more power over a short period of time than a nuclear reaction: a burning match is hotter than impure radium. The atoms undergoing a nuclear reaction in the radium are few and far between, whereas trillions of atoms in the chemical sample simultaneously participate in the chemical reaction. The radium remains warm for thousands of years, whereas the match briefly gives off intense heat, and burns out a half-minute later.

Is cold fusion an easy, cheap desktop experiment?

Richard Oriani, one of the world's leading electrochemists, said that in his 50-year career cold fusion experiments were the most difficult he ever performed. Cold fusion experiments can range in cost from \$50,000 to \$20 million. They vary in complexity from the isoperibolic half-silvered test-tube used by Fleischmann and Pons up the sophisticated custom-designed mass spectrometers at the Italian National Nuclear Laboratories (ENEA) and Mitsubishi heavy industry. Experiments usually take between six months and two years to perform. When Fleischmann and Pons announced the experiment, Fleischmann called this a "relatively simple" method of achieving nuclear fusion. He meant that it was simple compared with building a billion dollar tokamak reactor.

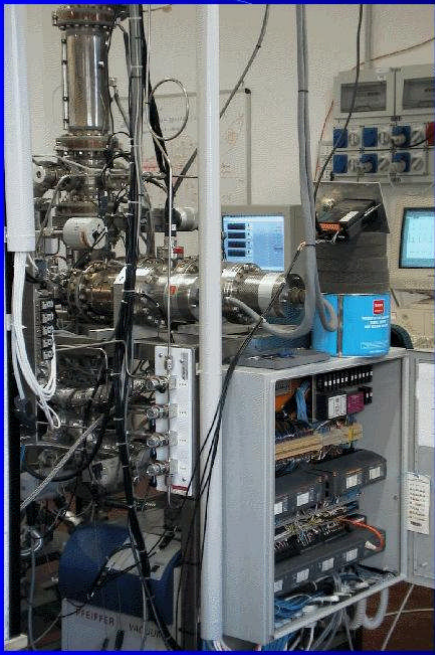

Main features

- ✓ High resolution Mass Spectrometer (Balzers QMA 410).
- ✓ Two NEG pumps are used:
 - SAES Capacitorr B 1300 (600 g of ST185 TiV alloy) operating at high temperature (300 - 400°C)
 - SAES GP200 MK4 W (170 g of ST707 alloy) operating at RT.
- ✓ Dynamic pumping:
 - Main pump: Pfeiffer TMU 261 turbo molecular drag pump
 - Backing pump: Pfeiffer TMU 071 + MD4
- ✓ No cryosorption pumps are used.
- ✓ Automatic operation (Field-Point + LabView).
- ✓ Pressure stabilized storage circuit.

Figure. 1.1. Part of an expensive cold fusion experiment. A high resolution mass spectrometer used for on-line helium detection during a cold fusion experiment at C. R. ENEA Frascati. (<http://www.frascati.enea.it/nhe/>)

Cold fusion is difficult to replicate, and the reaction is often unstable. The heat flares up and gutters out, like burning wet green firewood. Poorly understood physical reactions in potentially groundbreaking experiments are often like this. From 1948 to 1952, transistors existed only as rare, delicate, expensive laboratory devices that were difficult to replicate. One scientist recalled that, “in the very early days the performance of a transistor was apt to change if someone slammed a door.”²² By 1955, millions of transistors were in use, and any of these later mass produced devices was far more reliable than the best laboratory prototype of 1952.

Is cold fusion too good to be true?

Some skeptics feel that cold fusion must be too good to be true. They suspect that cold fusion researchers are guilty of wishful thinking. They should remember Michael Faraday’s dictum: “Nothing is too wonderful to be true if it be consistent with the laws of nature.” Mankind has discovered countless wonderful things that ancient people would have thought miraculous.

Modern physicists think it is too good to be true because they cannot comprehend how it could possibly work. They do not fully understand how high temperature superconductivity works either, but they accept that it exists. Before 1939, no one understood how fusion in the sun worked, and before the discovery of DNA in 1952 no one understood how living cells reproduced, yet people had never claimed that the sun does not exist, nor that cells cannot reproduce.

Many people have a sneaking suspicion that cold fusion must be too good to be true, because nature never does something for nothing. They think everything is difficult, and there is always a price to pay for the bounty of nature. Resources are now and always will be in short supply, and

²² Riordan, M. and L. Hoddeson, *Crystal Fire, the Birth of the Information Age*. 1997: W. W. Norton & Company.

we must therefore compete with others to get our share. Such people are mired in a stone-age mentality. The only resources we lack are knowledge and science. Knowledge is power, and with it we can unlock the unthinkably vast material and energy resources of the earth, and ultimately of the entire solar system. In the distant future when interplanetary travel becomes routine, every person may have a thousand hectares of living space: a vast estate on Mars, or in multilevel towers here on Earth. Someday robots will be improved enough to understand speech and perform domestic labor such as cleaning and cooking. They will gradually fall in price until anyone who wants can have a dozen robot servants waiting on them hand and foot. Energy is the most abundant natural resource of all; we need only find ways to harvest it. The sun produces 2.8×10^{26} watts, which is enough to vaporize the Earth in about a day. It is enough to give every individual on earth four-thousand times more energy than the entire human race now consumes.

²³

Does the high cost of experiments mean that fusion-powered machinery will be expensive?

No. Most of the expense of an experiment is for the instruments used to measure heat, charged particles, transmutations and neutrons. Cold fusion devices do not require extraordinary precision or ultra-pure materials. They are assembled by hand, like jewelry, with tolerances of a millimeter or so. Some of these crude, handmade devices have produced palpable, potentially useful levels of heat. Mass produced cold fusion devices in the future should cost roughly as much as alkaline or NiCad batteries, which they resemble in some ways.

What will it take to commercialize cold fusion?

It will take the support of you, the informed public. See the Introduction. Until people put pressure on the government and the scientific establishment, research will not be allowed in the United States, and it will continue to be actively discouraged in Europe and Japan.

After research begins in earnest, it may be many years before a theory is discovered and the reaction can be fully controlled. It seems unlikely that people will embrace commercial cold fusion devices if the reaction is not fully controllable, and if we cannot ensure it will never produce penetrating radiation or other dangerous side effects.

What will it cost to replace all conventionally powered automobiles, generators and other equipment with cold fusion powered models?

It will not cost anything. All equipment gradually wears out and must be replaced anyway, so it might as well be replaced with cold fusion models. Cars last five to 10 years, so the transition to cold fusion will probably take about 10 years, although it may accelerate in the last stages when people find it inconvenient to operate a gasoline powered car. (See Chapter 7, Section 2.) Setting up cold fusion equipment production lines will be expensive at first, but cold fusion powered models will be simpler and cheaper than fossil fuel models, and they will cost virtually nothing to operate, so overall we will save tremendous amounts of money.

²³ Computed as follows: the Sun's output is 2.8×10^{26} W, world annual energy production is $12 \sim 13$ TW = 1.2×10^{13} W. The world population is 6×10^9 people. The Sun's power divided by the world's energy production converted to power equals 2.3×10^{13} . Divide this by population, and we see that the per-capita output is 3,888 times world production.

1. Heat Is the Principal Signature of the Reaction

Soon after Fleischmann and Pons announced cold fusion, Fleischmann said, “heat is the principal signature of the reaction.” He meant heat is the easiest effect to measure, and the most reliable indication cold fusion is a nuclear process. This is quite unlike most other nuclear reactions, which emit intense radioactivity. (A few do not; see Chapter 2, Section 1.) Radioactivity is usually much easier to detect than heat. If an ordinary nuclear reaction were to produce a watt or two of heat the way cold fusion does, it would also generate such intense radiation anyone standing near the unshielded cell would be killed.

This is one of the most important issues in the field, and it is widely misunderstood, even by scientists.

Heat is heat; whether it originates from a chemical reaction, a nuclear reaction or friction, it produces the same effects and can be measured the same way, with a calorimeter. A calorimeter cannot distinguish between any of these sources of heat.

A wooden kitchen match weighs 0.2 grams. It burns for 25 seconds, producing about 40 watts of power, so it produces about 1,000 joules of energy, or 1 Btu. A small paraffin candle of the same weight would produce 8,400 joules. But you need free oxygen to burn a match or paraffin, and there is little free oxygen in a cold fusion cell. When you have to supply fuel plus oxygen, your best choice is to burn 0.02 grams of hydrogen plus 0.18 grams of oxygen. This forms 0.2 grams of water, yielding 3,133 joules. No fuel in a closed cell, without an air supply, can produce more energy than this.

Most cold fusion cathodes are about the same size as a match or coin. Suppose a palladium cold fusion cathode weighing 0.2 grams begins to produce one watt of heat. After 50 minutes it has produced 3,000 joules, which is still, theoretically, within the limits of chemistry (3,133 joules) although as a practical matter there is no way palladium can produce this much chemical energy. If the reaction is still going strong after two hours, you can definitely rule out chemistry. Some cold fusion cathodes weighing about this much have produced a watt or two continuously for weeks. They have produced in total *millions* of joules (megajoules). A few have produced between 50 and 300 megajoules.

Cold fusion cathodes do have a little chemical fuel in them. A cathode is a hydride: a metal that has absorbed hydrogen or heavy hydrogen (deuterium). As the hydrogen is absorbed into the metal, it leaves behind a little free oxygen in the headspace above the water in the cell. When electrolysis is turned off, the hydrogen in the metal gradually emerges. It is ignited by the recombiner in the headspace, so it does produce a little heat. (See Figure 1.5.) Palladium absorbs and then gives up hydrogen more easily than any other metal. In the 19th century palladium hydrides were used as cigarette lighters. However, a 0.2-gram palladium cathode when fully saturated with hydrogen holds only about 286 joules worth of fuel²⁴

In many experiments, the heat has been marginal and difficult to measure, but in others it has been dramatic, sometimes up to three times input (300% excess). With gas-loaded cathodes,

²⁴ Computed as follows: 0.2 grams = 0.002 moles of Pd. Fully loaded at a 1:1 ratio with hydrogen, 0.002 moles of Pd hold 0.002 moles of H (0.002 grams) which converts to 0.001 moles H₂O. The heat of formation of water is 285,800 joules per mole. It is very difficult to load as high as 1:1, except at very low temperature. The palladium cigarette lighters would have achieved no more than a 1:0.5 ratio in a mixture of alpha and beta loaded Pd-H. In other words, a 1 ounce (28 gram) palladium lighter would hold roughly as much energy as 20 wooden matches.

there is no input power. If the cell produces any heat, and it becomes measurably warmer than the surroundings, it is producing cold fusion excess heat.

In one of the most dramatic instances thus far, reported by T. Mizuno, a palladium cathode weighing a hundred grams generated an excess heat of several watts for a month, producing 12 megajoules excess in total. It grew hotter and hotter, until it was generating well over 100 watts. Mizuno naturally became alarmed. The cell was palpably hot, and it would not cool off even after it was disconnected from the power supply. It was producing what is called “heat after death.” Mizuno placed the cell in a bucket of water to cool it down. The first bucketful of water evaporated overnight, and was replenished the next morning. It evaporated again, and was replenished once more. In all, 37.5 liters of water were evaporated over an 11-day period, before the cell finally cooled to room temperature. It takes 85 megajoules of energy to vaporize that much water. During the experiment before electrolysis was terminated the cell produced 12 megajoules, so over the entire experiment the cathode produced at least 97 megajoules. This is equivalent to the energy released by 2.8 liters of gasoline (0.74 gallons). Actually, it produced far more than this; this estimate assumes the plastic bucket was perfectly insulated, which is absurd, and it ignores the fact that the cell was left exposed to air for hours at a time, before the water could be replenished in the morning. The actual total was probably hundreds of megajoules.

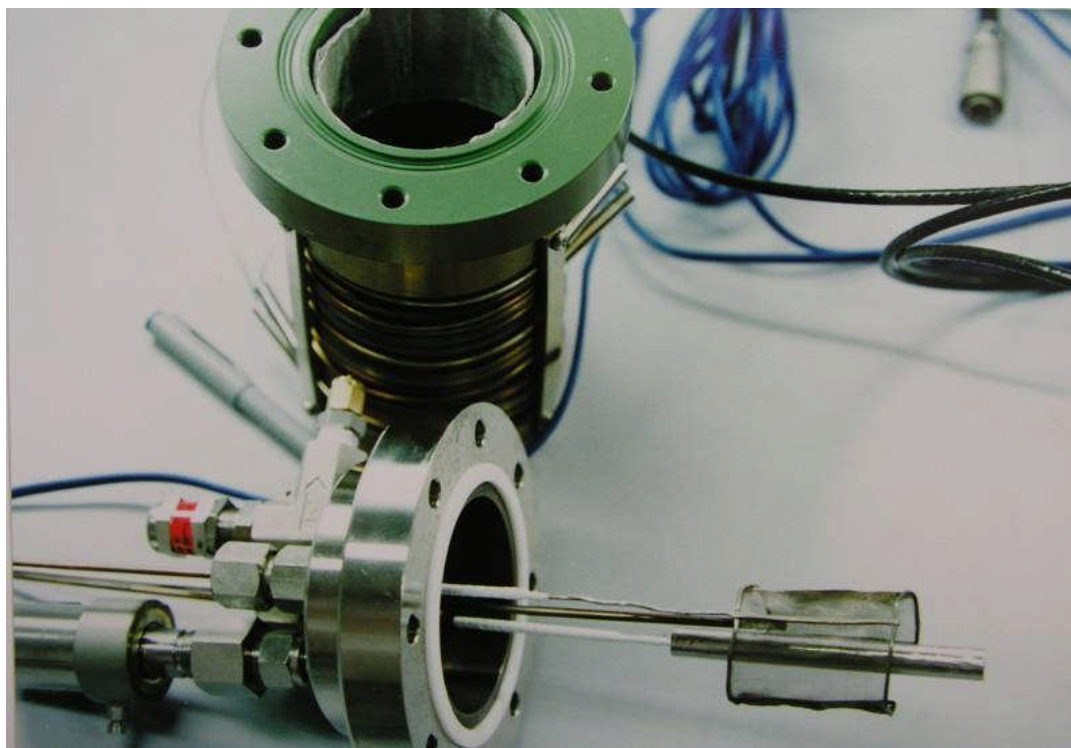

Figure 1.2. A cell from T. Mizuno. The cathode (bottom right) is a 100 gram cylinder. This cathode produced 85 megajoules of heat after death, and at least 97 megajoules during the experiment, which is enough to drive an average U.S. automobile 27 kilometers (16 miles at 22.4 mpg).

This cell, like all others, had only negligible quantities of chemical fuel in it, and it did not produce any detectable chemical ash. The cell was the size of a soft drink can, filled with heavy water. The cathode was a 100-gram palladium tube. A sample of matchwood, coal, gasoline, or any other fuel capable of producing 97 megajoules would fill the cell several times over, and they would all, after producing this much energy, turn to ash, of course.

A cold fusion cathode, therefore, acts like an everlasting match that does not burn out and never consumes any visible amount of fuel. It stays hot for weeks. Cold fusion cells are usually turned off after a month or so, because the researchers are anxious to examine the cathode and other materials inside the cell. If a cell producing excess heat was not turned off, there is every reason to assume it would go on generating energy for weeks, months or years.

Scientists know of only one phenomenon that can act like this: a nuclear reaction — radioactive decay, fission, or fusion. Cold fusion cannot be any form of chemical energy. That is completely out of the question. It must be either nuclear energy, or some source of energy unknown to science that has never previously been observed or studied.

So far, most indications are that cold fusion is, in fact, nuclear fusion. It produces nuclear ash: varying levels of tritium, neutrons and helium. It has been known to transmute the atoms in the cathode, converting them into other elements. When deuterium undergoes nuclear fusion, it produces a fixed amount of energy: each D-D fusion event produces 24 MeV of energy; each gram of deuterium releases 345,000 megajoules.²⁵ Mizuno’s cell that generated 97 megajoules presumably converted 0.3 milligrams of deuterium into helium. Unfortunately, this cell was not set up to capture or measure helium emission, so that could not be confirmed, but in other experiments helium has been measured in this proportion. These other experiments produced much less energy than Mizuno’s did, so they generated minute quantities of helium, but modern instruments are capable of measuring minute quantities with confidence. The helium ratio was first confirmed by M. Miles *et al.* at the China Lake Naval Weapons Laboratory, and later confirmed at several other laboratories. Figure 1.3 shows the ratio of helium to energy in a cold fusion experiment at SRI was close to what is expected with deuterium plasma fusion.

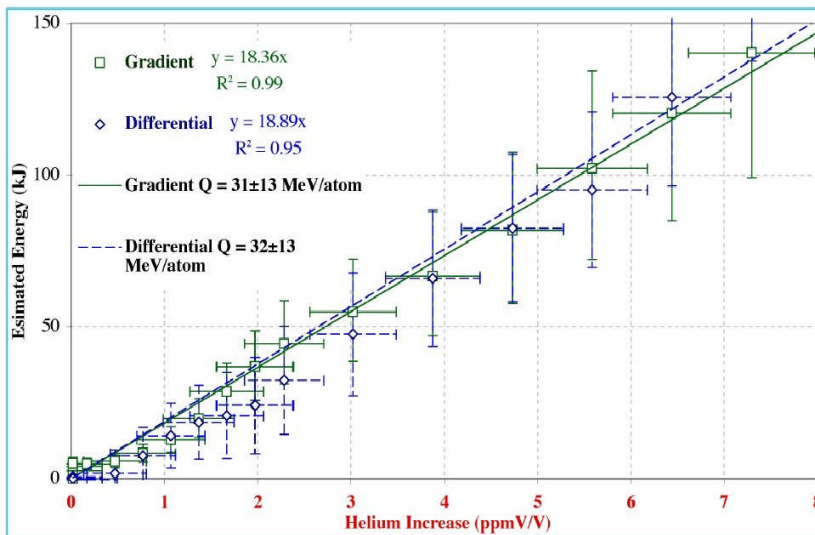

Figure 1.3. Results of helium measurements from the Case experiment at SRI. From: Hagelstein, P.L., et al., *New Physical Effects in Metal Deuterides*. 2004, Massachusetts Institute of Technology: Cambridge, MA. <http://lenr-canr.org/acrobat/Hagelsteinnewphysica.pdf>

We know that a cell has the potential to go on generating energy indefinitely because the deuterium is converted to helium so gradually that the amount present in the cell would last for

²⁵ S. K. Borowski, NASA Technical Memorandum 107030 AIAA-87-1814, “Comparison of Fusion/Antiproton Propulsion Systems for Interplanetary Travel,” Table 1, “Cat-DD” data, <http://gltrs.grc.nasa.gov/reports/1996/TM-107030.pdf>

years — or centuries. The cathode does undergo minute nuclear changes (transmutation), but again, the rate of change is so small, it would last for years. Only physical changes might interrupt long-term operation: occasionally, cathodes become so hot, they vaporize or melt, which brings the reaction to an abrupt halt. (See Chapter 2, Section 6). Researchers will have to learn how to prevent this from happening before commercial cells can be made.

Cold fusion produces nuclear reaction byproducts such as tritium and neutrons in amounts 11 orders of magnitude too small to be explained by conventional plasma fusion theory. Presumably, this is because conditions inside a metal lattice at room temperature are totally and utterly unlike conditions inside the sun. As Schwinger put it, “The circumstances of cold fusion are not those of hot fusion.”²⁶

2. A Quick Look at an Experiment

A wide variety of calorimeters have been used in cold fusion research. The ones that are most fun to watch are called flow calorimeters. They resemble coffeemakers. The water flows in one end cool, and it comes out the other end hot. The temperature difference multiplied by the amount of water flowing through tells you how much heat the sample is producing.

Calorimeters are simple in principle, but complicated in actual operation. Figure 1.4 shows a photograph of a flow calorimeter.

²⁶ Schwinger, J., *Cold fusion: Does it have a future?* Evol. Trends Phys. Sci., Proc. Yoshio Nishina Centen. Symp., Tokyo 1990, 1991. **57**: p. 171. <http://lenr-canr.org/acrobat/SchwingerJcoldfusiona.pdf>

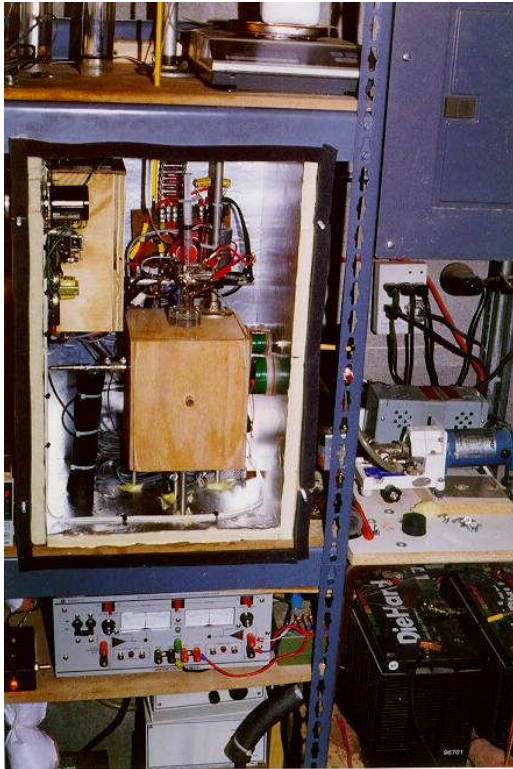

Figure 1.4. A calorimeter constructed by Edmund Storms, courtesy E. Storms. Note the DieHard® battery, lower right, that serves as an uninterruptible power supply. A power failure can ruin an experiment. Whenever possible, inexpensive, ordinary materials and instruments are used. However, experiments are never cheap, and they cannot be done on a shoestring.

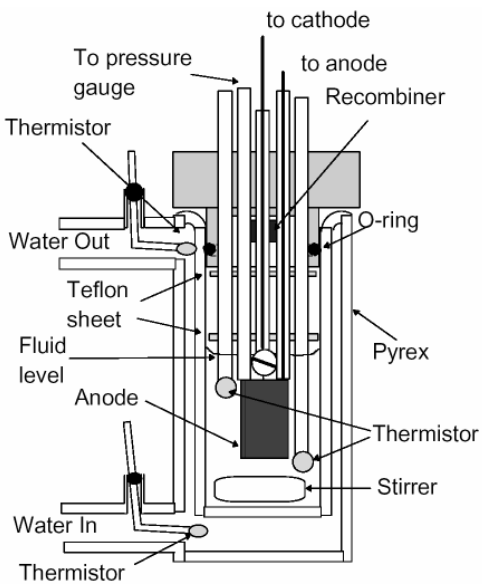

Figure 1.5. Cell and flow cooling water jacket from the calorimeter shown in Figure 1.4.

Figure 1.5 shows a schematic of the cell mounted inside the inner wooden box. It is a Pyrex bottle with two walls: a vessel contained within another vessel. The inner vessel holds electrolyte, and the outer vessel or jacket surrounding it holds cooling water. The cold fusion cathode and anode are on the inside, immersed in the electrolyte, along with a number of gadgets and sensors such as the magnetic stirrer on the bottom, which ensures the electrolyte temperature is uniform; thermistors to measure the electrolyte temperature; a pair of thermistors to measure the cooling water temperature where it enters and leaves the outer vessel; and the recombiner in the air space on the top, which keeps the cell from exploding, by converting the oxygen and hydrogen produced by electrolysis back into water.

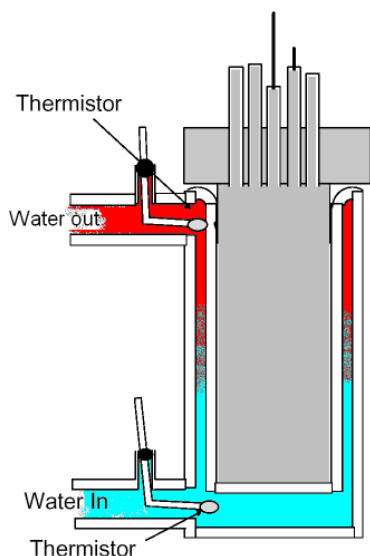

Figure 1.6. A simplified calorimeter schematic showing only the cooling water in the outer jacket.

Figure 1.6 is a simplified version of the schematic, showing only the outer vessel, or jacket, with the cooling water being pumped through it. The water is cool on the bottom where it enters the jacket, and warmer on the top where it flows out. The bottom thermistor measures the inlet temperature; the top thermistor measures the outlet temperature. Suppose:

The power meters show 2.3 watts of electrolysis going into the cell

The cooling water is flowing through the jacket at 30 milliliters per minute

The inlet thermistor measures 24.31°C, and the outlet thermistor measures 26.60°C

The difference (outlet minus inlet) is 1.29°C

30 milliliters of water \times 1.29°C = 38.7 calories of heat, or 162.5 joules

Divide 162.5 joules by 60 seconds per minute, to get the output power level, 2.7 watts

2.7 watts output - 2.3 watts input = 0.4 watts excess heat

As shown in the photo (Figure 1.4), the entire cell is nested inside a wooden box, which is inside another wooden box, which is held at a constant air temperature, plus or minus 0.1°C. It

resembles a Russian matryoshka nested wooden doll: a cell inside a flowing water jacket, inside a thermos bottle, inside a box, inside another box.

Additional apparatus not shown here include the pump, and the siphon and weight scale used to measure the water flow on a digital scale to within 20 milligrams per minute. Various power meters and computers record the flow rate, the input power, the inlet and outlet temperatures, and so on.

The whole thing works beautifully when it works, but it resembles an HO Scale model electric railroad: something often goes wrong.²⁷ You have to keep an eye on it, and calibrate it often. That is why researchers prefer more modern, fully electronic Seebeck calorimeters.

A skeptic might suspect that something has gone wrong in our example, and the researcher is measuring the flow of water incorrectly. Suppose the actual flow is 26 milliliters per minute, not 30. That would make the balance of input and output power zero; there would be no excess. Or the skeptic might suspect the power meter is not working, and input power is actually 2.7 watts, not 2.3. The inlet thermistor might be registering 0.19°C too low, or on the outlet side, the water may not be mixed properly, and the outlet thermistor may be measuring a warm streamline of water. These problems would produce a false reading of 0.4 watts excess. They would also, with equal probability, show a false reading of negative 0.4 watts, which the researcher would instantly recognize as an instrument error, because such a strong, continued endothermic reaction is impossible. (There is a brief heat-absorbing endothermic reaction when the cathode first loads. This shows up quite clearly with most calorimeters. But with a typical small cathode it would be far smaller than -0.4 Watts, and no cathode could absorb energy for long.) A sloppy experimenter might indeed make these mistakes, or some combination of them. This is why experiments must be repeated again and again, in many different laboratories, using equipment that has been carefully tested and calibrated.

With the actual equipment attached to this particular calorimeter, a mistake on this scale would be unlikely. The flow of water, for example, is measured on the electronic weight scale to the nearest 10 milligrams. The operator can measure the difference between 30.01 milliliters and 30.02 milliliters, and he often tests to be sure the weight scale is working properly, so it is exceedingly unlikely he will mistake 30 milliliters for 26. Similarly, he does not actually measure 2.3 watts; he uses a computer board based power meter to measure direct current to the nearest milliwatt. Researchers who measure more complex waveforms rely upon professional grade meters that are calibrated and certified by the manufacturer, and that cost as much as \$16,000. With most calorimeters, even a fraction of a watt can be measured with confidence. Furthermore, the effect has been measured repeatedly, in many different laboratories, using many different calorimeter types. Even if our skeptic has doubts about the operation of a flow calorimeter, which is admittedly somewhat complicated, his doubts would not apply to other types, such as static and Seebeck calorimeters. These have also registered excess heat in cold fusion experiments. In other words, the heat cannot be an artifact of the flow calorimeter design, and it cannot be a mistake made by one researcher only.

Setting up this calorimeter is the easy part of the experiment. A skilled person can do it in a few months. The hard part is selecting, preparing, and later evaluating the cathode with electron microscopes and mass spectrometers. This stage can take months or years. Cold fusion

²⁷ If you do not know what an HO Scale model railroad is, you were probably born after 1980.

experiments are often described by skeptics as simple, or as “something any high school kid could do.” (In fact there is a group of high school students who do experiments, but they are very talented. They live in Oregon, and they work in a summer honors program at a local university.)²⁸ Critics have repeatedly described cold fusion cells as “jars” with palladium “shoved” into them.²⁹ A *Newsweek* reporter in 2001 assembled several myths and mischaracterizations into one short article:³⁰

The cold-fusion scientists, by contrast [to plasma fusion], used a breathtakingly simple setup: a glass jar filled with water, wired like a battery with two electrodes . . .

And since cold fusionists have claimed only to produce minute amounts of energy, they can rationalize their ambiguous results by reflecting that many valid experiments also ride on tiny measurements . . .

First, as we have seen, even the calorimeter itself is not “breathtakingly simple,” it is not a “jar,” and the cold fusion cathode sometimes takes months to fabricate and analyze. Just because an object is small does not mean it is simple. A cathode is at least as complicated as a semiconductor or high-temperature superconductor. Second, cold fusion researchers (not “fusionists”) do not claim they have produced minute amounts of energy; they claim they have produced large, easily measured levels of power. In fact the power in many cold fusion experiments could have been detected with confidence in 1850, and in a few cases there is no input power and the cold fusion heat has been palpable. McKubre observed persistent excess heat up to 300%, with a Sigma 90 signal, and he declared that, “the effect is thus neither small nor fleeting.”³¹

3. A Quick Working Comparison between Plasma Fusion (Hot Fusion) and Cold Fusion

Plasma fusion, or hot fusion as it is often called nowadays, is the reaction that occurs in the sun. As noted above, cold fusion appears to fuse deuterium to produce helium, releasing heat in the same ratio as hot fusion does. The comparison ends there. A hot fusion reaction that produces a watt of heat will also generate a deadly flux of neutrons, killing all observers, unless it is shielded behind steel or lead. A tokamak power reactor would irradiate the surroundings and create as much dangerous radioactive waste as today’s uranium fission reactors do, and more than advanced light water fission reactors would.³² The upcoming experimental ITER tokamak reactor will cost approximately \$5 billion. No one can guess how much an actual working power reactor would cost, but it would probably be tens to hundreds of billions of dollars, making this the most expensive method of generating electricity ever devised. Tokamak reactors would be so expensive that only a few could be built, and they would be so radioactive it would be prudent to

²⁸ *High School Students Do Cold Fusion*, <http://lenr-canr.org/Experiments.htm#HighSchoolStudents>

²⁹ Chang, K., “U.S. Will Give Cold Fusion Second Look, After 15 Years,” *New York Times*, March 25, 2004. This reporter tried to write a balanced, fair description of the experiments, but the reporter uses pejorative terms such as “jar” without meaning to insult researchers, because such absurd characterizations are so common.

³⁰ Beals, G., “Science: Pining for a Breakthrough,” *Newsweek*, October 15, 2001

³¹ McKubre, M. C. H., et al., *Development of Advanced Concepts for Nuclear Processes in Deuterated Metals*, EPRI TR-104195, Research Project 3170-01, August 1994

³² Krakowski, R.A., et al., *Lessons Learned from the Tokamak Advanced Reactor Innovation and Evaluation Study (ARIES)*. 1993, Los Alamos National Laboratory.

place them far from cities, so the electricity would have to be transmitted over long distances, or converted into hydrogen and shipped by pipelines.³³

Research into hot fusion has been going on for nearly 60 years and it has cost roughly \$1 billion per year, with thousands of scientists working full-time, but little progress toward practical devices has been made. All hot fusion research funding comes from national governments; corporations and investors have shown no interest in this technology. Cold fusion research has continued for 16 years, at a cost of approximately \$100,000 per year. It is conducted by a few dozen volunteer scientists and retired professors, who pay most expenses out of pocket. Yet tremendous progress has been made, and it is already closer to a practical, commercial product than plasma fusion is — or likely ever will be.

The largest plasma fusion reaction in history produced 10.7 megawatts, which is much more power than any cold fusion reaction has produced, but it only lasted for a fraction of a second, so it generated roughly 6 megajoules of energy.³⁴ Dozens of cold fusion experiments have done better. As noted earlier, some have produced hundreds of megajoules. The heat flux is far smaller — no more than a few watts in most cases — but it goes on for weeks or months, until the cold fusion tortoise overtakes the hot fusion hare. Perhaps this comparison is unfair, because plasma fusion researchers have not tried to produce large amounts of energy, but they have tried to accomplish two other goals: breakeven, and a self-sustaining reaction. Breakeven means the output from the machine is equal to the input energy required to sustain the reaction. In a self-sustaining or “fully ignited” reaction the machine keeps itself running with no further input power. Breakeven has been the Holy Grail of hot fusion for nearly 50 years. Most observers say the goal is still remote. One compared plasma fusion research to trying to reach outer space by building ever-larger hot air balloons. Cold fusion achieved both goals a few years after it was announced. Cold fusion cells have often output more energy than the electrochemical input, and gas-loaded cold fusion cells have no external energy input, only output, so they are self-sustaining.

Plasma fusion reactors cost far more than cold fusion reactors. For both technical and economic reasons, a plasma fusion power generator would probably only work as an extremely large-scale machine, to serve an entire city. Some observers have suggested they may have to be built so large, a handful will serve the entire U.S. Cold fusion devices can be any size. A plasma fusion power generator would be much larger and more complicated than conventional power generators of similar capacity. The reactor shown in Figure 1.7 is only experimental, and it was not intended to produce high power density, but still, 10.7 megawatts is not much for such a gigantic machine. Most experimental devices are scaled down, not up, but even an experimental tokamak does not work unless it is gigantic. This is not a pilot generator plant. There is no electric power generator here, only the tokamak and the instruments used to measure the reaction. Indeed, no one has even begun work on practical ways to capture tokamak radiation and convert it into useful heat. A locomotive or helicopter engine produces 15 megawatts of raw heat, and it is far smaller than this. Cold fusion power density is high, so a cold fusion engine should be as compact as a combustion engine.

³³ U.S. Department of Energy, NREL, *Wind Energy Resource Atlas of the United States*, <http://rredc.nrel.gov/wind/pubs/atlas/>

³⁴ Strachan, J.D., et al., *Fusion Power Production From TFTR Plasma Fueled with Deuterium and Tritium*, PPPL-2978, 1994, Princeton University Plasma Physics Laboratory

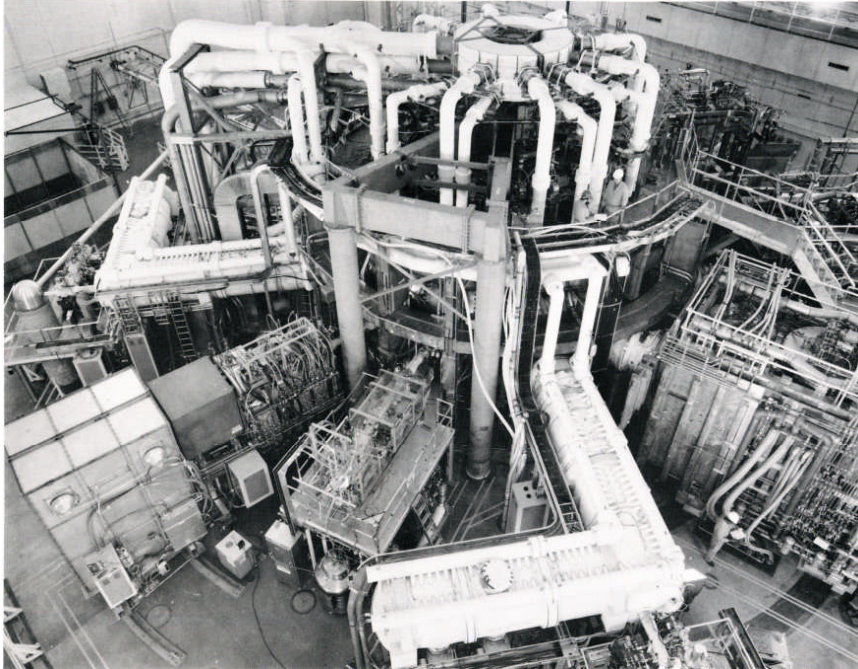

Figure 1.7. The Tokamak Fusion Test Reactor (TFTR) at the Princeton University Plasma Physics Laboratory, U.S. Department of Energy. Note the people on the top right. This instrument cost “about a billion dollars” to construct and \$70 million a year to operate. It produced 6 megajoules in one experiment, the world record run for hot fusion. From *PPPL: An Overview*, 1991: Princeton University Plasma Physics Laboratory.

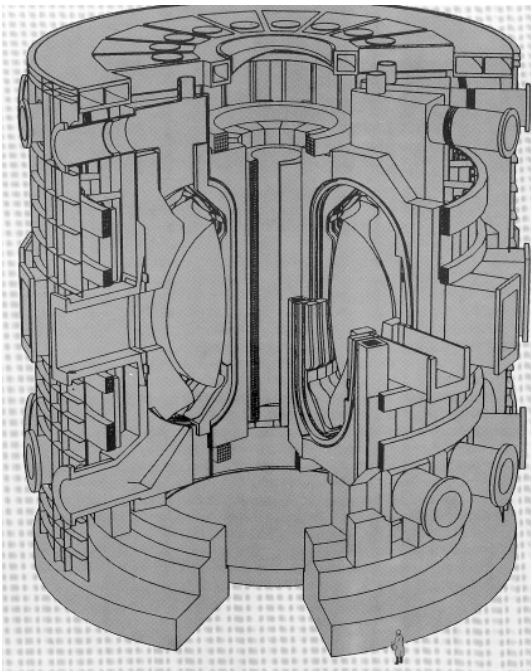

Figure 1.8. The upcoming International Thermonuclear Experimental Reactor (ITER) tokamak, as envisioned in 1991. Note the person on the lower right. ITER is expected to cost roughly \$5 billion. From *PPPL: An Overview*, 1991: Princeton University Plasma Physics Laboratory.



Figure 1.9. A typical cold fusion experiment, in the blue Seebeck calorimeter on the left. From J. Dash, Portland State University. Photographs by Dan Chicea, provided courtesy B. Zimmerman. This calorimeter costs \$6,000. Most experiments cost roughly \$50,000 including all equipment, and they are run by volunteers and retired professors. Some have produced 50 to 300 megajoules in one run. They have achieved the two goals hot fusion has failed to reach for 60 years: breakeven and full ignition.

2. The Ideal Source of Energy

Cold fusion has been called the ideal source of energy: it does not pollute; the fuel is inexhaustible; it is potentially thousands of times cheaper than conventional energy; and it is compact. “Compact” means both energy and power density are high. Gram for gram, energy density appears to be about a million times better than oil, coal or other chemical fuel; a single, small charge of heavy water fuel will last for decades. Power density is at least as good as a uranium fission reactor core, but fission requires gigantic, heavily shielded, centralized reactors, whereas cold fusion engines will probably be as small and light as gasoline engines.

These advantages are so remarkable they give people a sense that cold fusion must be “too good to be true.” Yet, cold fusion has no unique virtues. Every advantage on this list is shared by other energy sources.

Table 2.1. Comparison chart for different energy sources

	Pollution free	Very safe	In-exhaustible	Unlimited	Low fuel cost	Low reactor cost	Compact	Locate anywhere	Works 24/7 (4)	Ready now
Fossil fuel						✓	✓	✓	✓	✓
Hydro-electric	✓	✓	✓		✓	✓	✓			✓
Wind	✓	✓	✓		✓					✓
Solar	✓	✓	✓		✓					✓
Uranium fission	(1)		✓	✓	✓		✓	(3)	✓	✓
Plasma fusion	(2)		✓	✓	✓		✓	(3)	✓	
Cold fusion	✓	✓	✓	✓	✓	✓	✓	✓	✓	

(1) Fission reactors produce no pollution during operation, but uranium mining does, and the disposal of radioactive waste (radwaste) and spent fuel are serious and expensive problems. High level radwaste and spent fuel might be used in a terrorist attack.

(2) According to a Los Alamos study, plasma fusion reactors would produce about the same amount of nuclear waste that conventional, present-day fission reactors do, they would not be commercially competitive with advanced fission reactors, and they would not have significant environmental, safety and health (ES&H) advantages over advanced fission.³⁵

(3) Fission reactors are located far from cities because there is some risk they will fail catastrophically, and plasma fusion reactors would probably produce large amounts of dangerous radwaste, so it would not be prudent to locate them near population centers.

(4) “Works 24/7” means the energy source is available on demand, and it is available at night, unlike solar energy. Solar or wind energy might be converted to hydrogen and stored for times when they are not available, but this would increase cost. Hydroelectric power has to be reduced during droughts. Any energy system must be turned off periodically for maintenance.

³⁵ Krakowski, R.A., et al., *Lessons Learned from the Tokamak Advanced Reactor Innovation and Evaluation Study (ARIES)*. 1993, Los Alamos National Laboratory.

Wind, solar and hydroelectric generators do not pollute significantly, and they all derive their energy from the sun, which is inexhaustible. However, the power from these sources is limited, and they can only be built in fixed locations, which are often far from where we need the energy. Rivers will continue to flow for billions of years, so the hydroelectric power we have now is inexhaustible, but we have already tapped out this resource: there are few suitable rivers left to dam in developed countries. Solar power is intermittent, unavailable at night or bad weather, and the power density is low. The wind energy in North and South Dakota and Texas could theoretically supply all the electricity in the U.S.^{36,37} Unfortunately, North and South Dakota are far from population centers, and electricity cannot be transmitted thousands of kilometers. Wind might be used to generate hydrogen gas, which could then be sent long distances in pipelines, and used to generate electricity in fuel cells. This would have the added advantage that the gas can be stored up on site at the generator plant, and used on demand. But this would be expensive, it would take a long time to implement, and it would require hundreds of thousands of wind turbines; roughly as many as the number of commercial long-haul trucks in the U.S. Wind energy in Europe is more promising. Offshore wind from the North Sea could supply four times more electricity than Europe now uses.³⁸

Putting aside theoretical objections, strictly from an engineering point of view, cold fusion has no single unique aspect that makes it unlike any other heat source. It is no hotter or more intense than fire. The fuel is available in unlimited quantities and it costs nothing, but the same can be said for sunlight. It lasts a million times longer than chemical fuel, but so does uranium. It is perfectly safe, but the same can be said for sunlight, wind or hydroelectricity. No other single source of energy combines all of the advantages of cold fusion. Cold fusion has no eerie science fiction-like properties. It does not produce deadly radiation, the way a fission reactor core does. It probably cannot produce an immense explosion like a thermonuclear bomb, although as shown in chapter 12, there are some concerns about runaway reactions.

1. An Example of a Benign Nuclear Power Source

One aspect of cold fusion may seem impossible at first glance. It is a nuclear power source, yet it does not produce dangerous penetrating radiation, or radioactive byproducts. Many people assume that all nuclear power sources necessarily produce dangerous radiation, the way conventional fission and tokamak fusion reactors do. But plutonium-238 nuclear devices generate only heat, without dangerous radiation or harmful byproducts. They do produce alpha radiation, but it can easily be shielded with a barrier as thin as aluminum foil or a piece of paper. Cold fusion also produces alpha particles (helium nuclei), which can also be easily shielded. Plutonium-238 generates palpable, useful levels of heat that lasts for decades. NASA uses it to power spacecraft, using radioisotope thermoelectric generators (RTG).³⁹ RTG are very rugged. One was onboard a rocket that malfunctioned and was destroyed moments after launching. The RTG was retrieved from the ocean floor in mint condition, and later used in another rocket payload.

³⁶ U.S. Department of Energy, NREL, *Wind Energy Resource Atlas of the United States*, <http://redc.nrel.gov/wind/pubs/atlas/>

³⁷ American Wind Energy Association, <http://www.awea.org/>

³⁸ Danish wind industry Association, <http://www.windpower.org/en/core.htm>

³⁹ NASA, Space Radioisotope Power Systems, *Multimission Radioisotope Thermoelectric Generator*, April 2002, <http://spacescience.nasa.gov/missions/MMRTG.pdf>

Although the RTG itself is benign and reasonably safe to handle, the plutonium-238 isotope is so rare and difficult to separate out it costs millions of dollars per kilogram, and this relatively benign isotope has to be separated from tons of other plutonium and uranium, which are extremely dangerous.⁴⁰ The RTG does not reduce overall radioactive material or risk; it employs a tiny fraction of all the metal that happens to be safe to work with, leaving the rest to be dealt with.

Figure 2.1 shows the RTG used in the Cassini space mission. The half-life of plutonium-238 is 88 years, and unlike cold fusion, radioactive decay cannot be turned off, so the reactor in this photograph is already hot and will remain hot for hundreds of years. A conventional nuclear reactor would require heavy shielding; the woman on the right would never be able to stand next to one. Cassini has three of these RTG generators. Each holds 8 kilograms of plutonium, which produces 0.56 watts of heat per gram, so thermal output is 4,480 watts. Conversion efficiency is low, and electric power output is only 285 watts.^{41,42} Palladium in cold fusion cells has produced considerably better power density, and heat engines with better efficiency are available, so a 285-watt cold fusion generator would be much smaller and more compact than this.

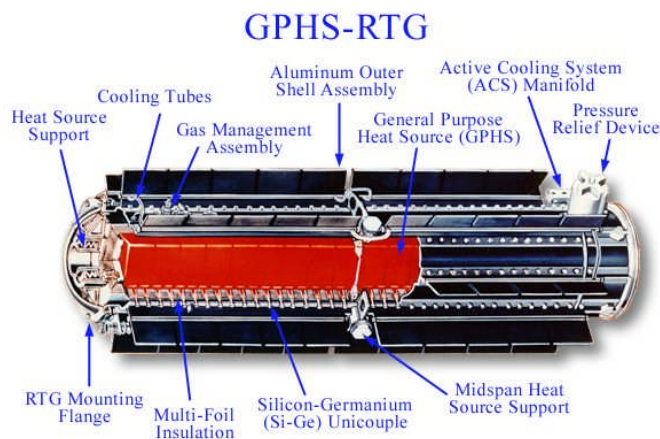

Figure 2.1. NASA Cassini mission General Purpose Heat Source Radioisotope Thermoelectric Generator (GPHS-RTG).

Small RTGs have been used as pacemaker batteries (Figure 2.2). They have been successfully implanted in hundreds of patients. They last much longer than chemical batteries: about 20 years. There is no risk the patient will ingest the plutonium, unless he deliberately grinds up the metal pacemaker and breathes in the dust.^{43,44} However, they were taken off the market because of

⁴⁰ Estimates of the cost range from about \$1 million to \$10 million per kilogram. The U.S. DoE is constructing a new plant to separate out ²³⁸Pu. This will cost \$1.5 billion, and over the life of the plant it will produce 150 kg of ²³⁸Pu, as well as 50,000 drums of hazardous nuclear waste. Source: Broad, W., *U.S. Has Plans To Again Make Own Plutonium*, in *New York Times*. 2005.

⁴¹ Uranium Information Centre, Melbourne, Australia, Plutonium, Nuclear Issues Briefing Paper 18, <http://www.uic.com.au/nip18.htm>

⁴² NASA Vision Missions, Nuclear Systems Program Office, "Project Prometheus," <http://spacescience.nasa.gov/missions/npsfactsheet.pdf>

⁴³ NASA, Environmental Effects of Plutonium Dioxide, <http://saturn.jpl.nasa.gov/spacecraft/safety/appendc.pdf>

fears of what may happen after the patient dies. If the pacemaker is not removed and carefully disposed of, it might be a health hazard.



Figure 2.2. A plutonium powered pacemaker. The plutonium has been removed; it fit into the slot on the top left. Hundreds of these were implanted in patients with no ill effects. Cold fusion will also scale down to devices this size or smaller, and it will scale up to any size you like.
<http://www.orau.org/ptp/collection/Miscellaneous/pacemaker.htm>

The performance of a cold fusion device would be similar to that of a NASA RTG or plutonium pacemaker, but the materials used in its construction would be common, safe metals instead of rare isotopes. All of the metal used in cold fusion is benign to start with. In a few experiments it has become mildly radioactive after extensive use, and some cells have generated tritium, but experts are confident both can be avoided in a commercial cell. Even if a tiny amount of tritium were produced, it would not be a public health concern. Consumer devices such as exit signs in office buildings contain more tritium than a cold fusion cell will. There are minute quantities of radioactive material in other household and workplace devices, such as the americium in smoke detectors. There are also naturally occurring radioactive materials in buildings, such as radon gas that collects in some basements. Coal is by far the largest source of radioactive pollution. Burning coal releases roughly 8,960 tons of radioactive thorium and 3,640 tons of uranium, worldwide.⁴⁵ Cold fusion would never release this much radioactive garbage into the environment! It will only consume 1,200 tons of deuterium. Even if all 1,200 tons could turn into tritium, which is impossible, it would still not be as bad as coal. Very little radioactive material would escape in any case, because cells will be tightly sealed like today's automobile batteries. Batteries are filled with dangerous caustic acid, but they seldom leak or cause harm. Cold fusion cells should be equally reliable. It will not be difficult to isolate and recycle any mildly radioactive material from scrapped cells. If there is any lingering concern about radiation, cells could be equipped with alarms, which would be similar to smoke detectors. (A smoke detector is an alpha particle detector that triggers an alarm when the particles are absorbed by smoke. It is simple, cheap, sensitive and reliable.)

Plutonium-238 is a health risk when ingested because the alpha particles gradually damage tissue immediately adjacent to the metal. If you breath in a fragment of plutonium and it becomes lodged in your lungs, it may cause cancer after several years. Radioactive decay cannot be turned off, whereas after a cold fusion reaction stops, alpha particle emission also stops, so

⁴⁴ Sutcliffe, W. G., *et al.*, *A Perspective on the Dangers of Plutonium*, Lawrence Livermore National Laboratory, April 14, 1995, UCRL-JC-118825, <http://www.llnl.gov/csts/publications/sutcliffe/118825.html>

⁴⁵ Gabbard, A., *Coal Combustion: Nuclear Resource or Danger*. Oak Ridge National Laboratory Review, 1993. 26(3 & 4), <http://www.ornl.gov/info/ornlreview/rev26-34/text/colmain.html>

even if a person ingested a tiny amount of cold fusion cathode (in a severe accident, let us say), it would not gradually damage the tissue the way a fragment of plutonium would.

2. Other Advanced Heat Engines That Might Be Used With Cold Fusion

The Cassini mission thermoelectric generator is extremely reliable. One of the first NASA RTGs was placed aboard Pioneer 10 in 1972, and it continued to operate flawlessly for 30 years, generating power in deep space. Thermoelectric devices are reliable because they have no moving parts. Different kinds have been developed, including old-fashioned plasma state radio tubes, but the most reliable type is solid state. In the distant future, all electricity will probably come from cold fusion powered thermoelectric generators. The problem with them today is that efficiency is low, and cost is high. They convert only 5 to 10% percent of the heat into electric power, throwing away the rest as waste heat. Some experimental prototypes convert 20%. A few scientists, including cold fusion researcher Peter Hagelstein, say they may have discovered much more efficient devices, that may reach 50 to 80%. These would be ideal for cold fusion. For that matter, they would be far better than high-performance gas turbines and other heat engines, and they could save tremendous amounts of fossil fuel.

While we are waiting for these ideal devices to arrive, we can use conventional small generators with cold fusion, which have moving parts. Even though the heat from cold fusion will cost nothing, it would be best to use generators with reasonable efficiency, because they will be smaller, more compact, cooler and quieter. The Cassini RTG costs millions of dollars, but even if you could purchase one for \$500 it would not be a practical way to generate electricity at home. It produces only 285 watts, which is not enough to run a microwave oven. It weighs 75 kilograms, and it produces 4,000 watts of waste heat. You would need 10 or 20 of them to power your house, and they would produce so much waste heat it would be like having an open-hearth furnace in your backyard or basement.

Two kinds of advanced heat engines with moving parts might be used with cold fusion to produce electricity: small turbines and Stirling engines.

Small turbine generators, or “MicroTurbines” are being developed for houses and buildings. They generate 30 to 60 kilowatts of electricity. They have many fewer parts than traditional turbines, with the generator, compressor and turbine wheels all on a single shaft. The turbine rides on a stream of forced air instead of conventional bearings, so there is no need for lubricating oil, and wear and tear and maintenance are reduced. One company has installed 3,000 of these machines.⁴⁶ They are about the size of a refrigerator. Unlike ordinary engines, they work with a wide variety of fuels including natural gas, propane, biogas or kerosene. With cold fusion, steam would be used instead of burning gas or liquid fuel.

NASA is developing Stirling Radioisotope Generators (SRG) to replace the RTG shown above. Even though they have moving parts and will not last as long as the RTG, they will be smaller and lighter, which is a critical factor in a spaceship. Larger, 25 kilowatt Stirling electric generators are also being developed.⁴⁷ They are used with concentrated sunlight for solar-thermal power generation, or with external combustion for small, free-standing generators. These

⁴⁶ Capstone Turbine Corporation, <http://www.microturbine.com/index.cfm>

⁴⁷ Stirling Energy Systems, Inc., <http://www.stirlingenergy.com/>

are sealed, self-contained, low-maintenance machines, also about the size of a refrigerator. They use a permanent supply of hydrogen gas as the working fluid. They have four cylinders and pistons and the electric generator all built into the unit. They are much more efficient than photovoltaic solar cells. They would be ideal for cold fusion because they use heat generated outside the unit (sunlight or external combustion). Cold fusion heat would replace the external combustion.

3. What Cold Fusion Cells May Be Like

What would commercial cold fusion devices look like? At first glance, a water heater would look just like today's gas-fired or electric models: it would be a large white insulated tank. In the lower portion, where gas burners are now located, there would be a 12-kilowatt cold fusion cell. Cold fusion cells have already achieved power density high enough fit into this space.

Cold fusion researcher Tom Benson describes what a heavy duty cold fusion cell may be like:

The unit would be a box, like a large truck battery or a small copy machine. It will be small enough to fit through doors, and be handled by a couple of people or a small forklift. The working material inside the unit would consist of 10 or more slices of solid activated electrolyte — perhaps a ceramic or complex nano-structured metal hydride. Each slice would be bounded by high surface area platinum electrodes, with gaps that are filled with deuterium gas controlled by a pressure management system. Sensors would monitor temperature, pressure, chemical composition of electrolyte, or whatever other control variables are appropriate. From this information the control system extrapolates (based on internally stored tables or formulae) the cold fusion reaction taking place and varies electrical power to the grid, gas pressure, chemicals added to the electrolyte, and other variables, so as to maintain a constant fusion heat reaction. If the control mechanism malfunctions, or anything else goes wrong, then the reactions stop and the unit simply cools down. It is inherently safe because the reactions only occur in a narrow range of conditions, which can only be maintained with constant control.

The entire unit will be in a steel enclosure, with a heat exchanger to boil water for a steam turbine. Or it will be surrounded by thermoelectric panels, in a solid-state thermoelectric generator.

This module is designed to be used with many types of machines, ranging in size from a home generator up to one of a suitable size to power a small factory. Each box generates 10 kilowatts of heat, to be converted into electricity, or used directly in an industrial process, or for space heating. Modules can plug into the cavity in a steam generator or thermoelectric generator. One or two of these boxes would be enough for a home generator, 10 would be enough for a kiln to cure wood, and 50 might be needed at a sewage treatment plant.

The cell would function on demand for five or 10 years before the electrolyte or matrix is degraded to the point where the unit loses about half of its effective power. The deuterium gas may gradually leak, so the storage tank might have to be recharged every few years.

Think of this as a large plug-replaceable battery — except that instead of electricity, it produces heat at a guaranteed temperature, depending on the model. Some will be engineered for moderate temperatures ranging from 80 to 200°C. Others will be designed for higher temperatures, 500 to 1,000°C. Temperature will be controlled to within plus or minus 50°C (as specified by manufacturer), by changing the power flux. These boxes will be made by GE,

Westinghouse, Mitsubishi, and other industrial manufacturers. Underwriters Laboratory will certify them, and performance would be specified and controlled by a standards board. They will be licensed and safety-checked by health and regulatory agencies, just like any other electrical or chemical equipment we use daily.

This unit could produce process steam, heat, or electricity via steam turbines or thermoelectric panels, all of which would be relentlessly engineered by the massive, motivated, competitive resources of the Japanese, U.S., European, and Chinese industrial corporations. Millions of engineers all over the world, once they realize that cold fusion is real, would smell money and fame. They would immediately begin work on the generating and control equipment. We need not speculate much about it. We can safely assume that if a primitive prototype cold fusion cell is demonstrated, the engineers will figure out the rest.

After 10 years of mass production, the cold fusion cells, thermoelectric panels and other components will drop in price dramatically in response to the mass market, just as automobiles did in the 1920s, and computers did in the 1980s. Efficiency would increase until it approaches the theoretical maximum.

4. How Cells May Be Manufactured

Cold fusion cells should be roughly as difficult to manufacture as electric batteries, which they resemble in some ways. Thousands of corporations throughout the world have enough capital and expertise to make batteries. Once the physical science is understood and standard product designs emerge, many of these corporations will compete, quickly driving down prices. To be sure, batteries do need high-tech, carefully controlled production lines, but the capital investment and expertise needed is far smaller than, say, an automobile factory or a 1,000-megawatt power plant. Battery production lines must be clean and free of contamination, but they do not need to meet the extraordinary, expensive, clean room standards of a semiconductor production line. A battery production line can be set up in a matter of months. You can purchase an alkaline battery production line off-the-shelf, over the Internet, from the United Power Enterprises Co., Ltd., in Hong Kong. In the not too distant future I hope this company and many others will be selling cold fusion cell production lines, and thousands of companies will be operating them.

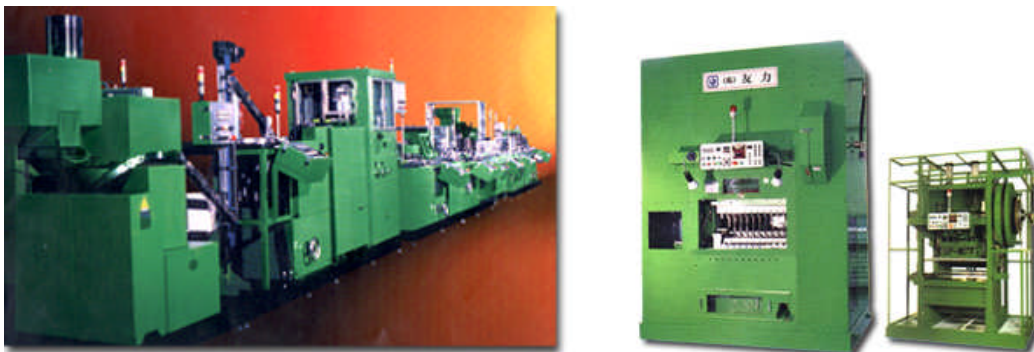

Figure 2.3. An alkaline battery production line available for sale over the Internet, from the United Power Enterprises Co., Ltd. <http://www.unitedpower.com.hk/> Cold fusion production lines should be about as large and complex as this. Most cold fusion cells will range in size from a D-cell to an automobile battery.

Most early cold fusion cells will probably be no larger or more powerful than D cell batteries, because small devices are the most profitable per watt of capacity.

We know that cold fusion does not require specialized, difficult, or precise manufacturing because a few experimental cells, such as the one made by Mizuno (Chapter 1) have already generated commercially useful levels heat at high temperatures. Professional electrochemists made these cells by hand. To be sure, these people are skilled, methodical, and careful to avoid contamination. They use Milli-Q ultra clean water and certified 99.9 percent pure reagents. But their workbenches and tools are not extraordinarily clean, and the cells fit together about as well as any handmade object such as a necklace.



Figure 2.4. A typical crowded laboratory, that of Tadahiko Mizuno, Hokkaido National University. Top: Mizuno's assistant Tomoko Kawasaki (left) and Mizuno. Photo by J. Rothwell.

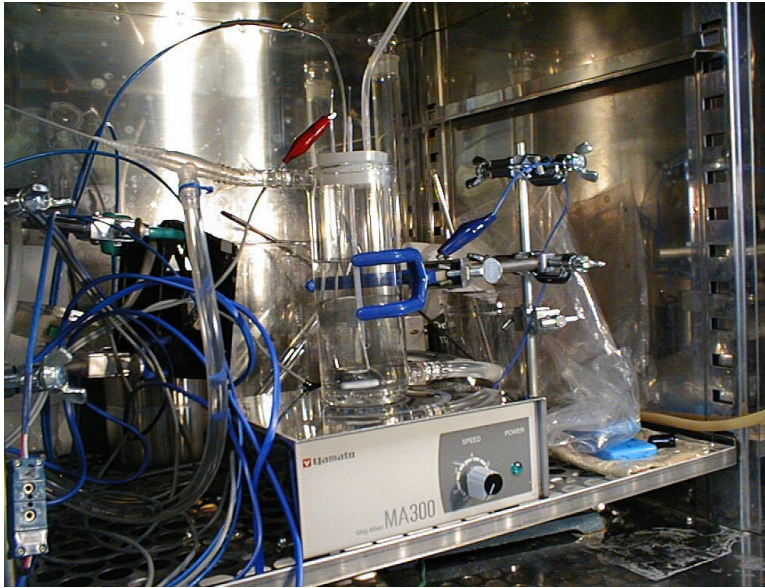

Figure 2.5. A glow discharge cell in climate-controlled cabinet in Mizuno's laboratory. Photo by J. Rothwell.

5. Cost Comparison With Fossil Fuels

This section is based on the assumption that cold fusion consumes heavy water, and it produces as much energy from the heavy water as plasma fusion does. There is considerable experimental evidence pointing to this,⁴⁸ but it has not been proved to everyone's satisfaction yet. While it fuses deuterium, cold fusion probably also transmutes the metal in the cathode. The deuterium reaction produces millions of times more energy than chemical fuel does. The secondary reaction with the host cathode metal probably does not produce much energy. In some cases it may absorb energy.

As mentioned in the Introduction, people spend approximately \$3.7 billion on fossil fuel per day worldwide, and this fuel generates ~0.9 quads (quadrillion Btu) of energy. This is a large underestimate of the cost. It includes only the initial, wellhead price of the fuel. With oil, for example, it is the number of barrels produced daily multiplied by \$40, the present world market price of oil. It does not include the additional cost of refining crude oil into gasoline and delivering it to gas stations, which doubles the price. At \$2 per gallon, gasoline costs \$84 per barrel. This estimate also ignores the cost of pollution, and the inevitable oil spills and accidents which arise from working with volatile fossil fuels. Some experts have estimated that the hidden social and economic cost of oil brings the price up to roughly \$5 per gallon of gasoline. To put it another way, drivers pay \$2 per gallon, and they force the rest of us to pony up another \$3 to cover pollution, ill-health, and so on.

Table 2.2 shows the three principal fossil fuels: coal, oil and dry natural gas. The data comes from the *Annual Energy Review 2002*,⁴⁹ and EIA "quick facts" web pages.⁵⁰

⁴⁸ Miles, M., B.F. Bush, and J.J. Lagowski, *Anomalous effects involving excess power, radiation, and helium production during D2O electrolysis using palladium cathodes*. Fusion Technol., 1994. **25**: p. 478.

⁴⁹ *Annual Energy Review 2002*. 2003, Energy Information Administration, U.S. Department Of Energy. Quads are from Table 11.1, p. 281. This table shows annual totals, which I divided by 365. Some of this coal and oil is used to

Table 2.2. World fossil fuel consumption

Fuel	Amount used per year	Amount used per day	Cost	Cost per day	Quads per day
Coal	5,252 million short tons	14 million tons	\$18 per ton (in U.S.)	\$0.3 billion	0.26
Oil	24 billion barrels	67 million barrels	\$40 per barrel	\$2.7 billion	0.39
Gas	92 trillion cubic feet	252 billion cubic feet	\$2.95 per thousand cubic feet, wellhead in U.S.	\$0.7 billion	0.25

Total annual production from these three main fossil fuels is 335 quads. Other major sources of energy — including natural gas plant liquids, nuclear electric power, hydroelectric power, geothermal and other (such as wind power) — add another 68 quads, bringing total world energy production to 403 quads (2001 data).

If cold fusion is used to generate the 0.9 quads of energy we get from fossil fuel daily, it will consume roughly 15 tons of heavy water. This will cost about \$1.5 million. (The estimated cost of \$100 per kilogram is explained below.) Plus we will need another \$2 million for recycled heavy water, or \$3.5 million total. In other words, the fuel itself will be roughly a thousand times cheaper than the fossil fuels it replaces. As the technology improves the cost will drop even more.

Cold fusion will also be far cheaper than hydroelectricity or uranium nuclear power.

The bottom line is that the energy sector, which is the largest industry in the world — a \$2.8 trillion behemoth — will shrink to \$1.3 billion, one-fourth the size of the bubblegum business.⁵¹ To put it another way, energy will cost the average person on Earth 22 cents per year. Because Americans use more energy than other people, energy will cost each American about a dollar per year, compared to \$2,499 today. Total expenditures for the entire U.S. will fall from \$703 billion to roughly \$280 million.⁵²

Here is the basis for the estimate that we will need 15 tons of virgin heavy water per day, plus recycled heavy water, costing \$3.5 million.

make plastic or for other nonenergy applications. However, the quads shown here are for the fuel that is actually burned.

⁵⁰ <http://www.eia.doe.gov/neic/quickfacts/quickcoal.htm>,

<http://www.eia.doe.gov/neic/quickfacts/quickoil.html>,

<http://www.eia.doe.gov/neic/quickfacts/quickgas.htm>

⁵¹ Wm. Wrigley Jr. Company, the largest bubblegum manufacturer, reports total sales of \$3.6 billion per year. This includes other food products. They sell \$2.7 billion worth of bubblegum, about half of the world total.

⁵² *Annual Energy Review 2002*. 2003, Energy Information Administration, U.S. Department Of Energy.

<http://www.eia.doe.gov/emeu/aer/>, p. 13, year 2000 data

Deuterium fusion yields 3.45×10^{14} joules per kilogram (345 million megajoules).⁵³ Gasoline has 45 megajoules per kilogram (or 132 megajoules per gallon), so a kilogram of deuterium gas has roughly as much energy as 7.6 million kilograms of gasoline (2.6 million gallons).

One mole of heavy water consists of 16 grams of oxygen and 4 grams of deuterium, so deuterium gas has five times more energy per kilogram than heavy water. One kilogram of heavy water produces 69 million megajoules, as much energy as 1,533,000 kilograms of gasoline (523,000 gallons).

One kilogram of ordinary water contains 0.015 at% deuterium, or 1 deuterium atom for 6,700 hydrogen atoms. (Some sources say 1 in 5400.)⁵⁴ When fused the deuterium in ordinary water yields 13,000 megajoules (98 gallons of gasoline).

The entire world consumes 403 quads, or 4.3×10^{14} megajoules. If all of this energy came from cold fusion or plasma fusion, it would consume 6,162 tons of heavy water per year. This could be produced in eight large industrial plants.

Fossil fuel produces 335 quads; the remaining 68 quads come from nuclear power, hydroelectricity, and other sources. To replace the fossil fuel alone we would need 5,000 tons of heavy water annually, or about 15 tons per day. Only a tiny fraction of the heavy water in a sealed cold fusion cell will actually be consumed over the life of the cell. When the cell is scrapped, the remaining heavy water might be thrown away. In that case the world would need thousands of tons of heavy water per day. However, heavy water is expensive. The heavy water used as a moderator in Candu nuclear reactors is not thrown away; it is carefully purified and recycled. As long as heavy water remains expensive, it will probably be recycled from scrapped cold fusion cells.



Figure 2.6. The Ontario Hydro International Bruce Point Heavy Water Plant had the capacity to produce 800 tons of per year. It was shut down in 1997. Eight plants of this size could supply enough heavy water to generate all of the energy now consumed in the world.

⁵³ Borowski, S.K., *Comparison of Fusion/Antiproton Propulsion Systems for Interplanetary Travel*. 1996, NASA, Table 1, “Cat-DD” data, <http://gltrs.grc.nasa.gov/reports/1996/TM-107030.pdf>

⁵⁴ Hamer, W., Peiser, H., *A Hydrogen Isotope of Mass 2*, NIST, <http://nvl.nist.gov/pub/nistpubs/sp958-lide/043-045.pdf>. Quote: “The modern best estimate of the ratio is 5433.78 in unaltered terrestrial hydrogen.”



Figure 2.7. Atomic Energy of Canada Ltd. advanced heavy water pilot plant, Hamilton, ON. Photo courtesy Atomic Energy of Canada Ltd. This plant produced about 1 ton of heavy water per year. A scaled up version of it would be more efficient and cleaner than the old Bruce Point plant, shown above.

Heavy water now costs as much as \$1,000 per kilogram retail for high purity grades, although a Chinese company recently sent out spam offering 99.85% pure heavy water for \$460 per kilogram. In bulk, it costs about \$300.⁵⁵ A factory assembling cold fusion cells will have its own on-site machinery to extract deuterium from ordinary water, so it will pay the bulk price. With cold fusion, the price should drop by 50% to 80% or more, because most of the production cost today is for energy. In other words, a tiny fraction of a heavy water production machinery output will be diverted to power the machinery itself — roughly 0.05%. This is how much would have to be diverted with today's extraction techniques, which are inefficient and have not been improved since the 1940s. Mitsubishi and other corporations have proposed modern, efficient, cleaner, environmentally friendly methods of extracting heavy water, and Atomic Energy of Canada Ltd. tested one of these methods in a pilot plant in Hamilton, ON.⁵⁶ Even with today's inefficient methods, cold fusion would reduce the cost of heavy water to about \$100. With advanced techniques, the cost may fall below \$50. Recycled heavy water from scrapped cells will be cheaper, perhaps a few dollars per kilogram. To replace all fossil fuel we would need 15 tons of virgin heavy water and perhaps 2,000 tons of recycled heavy water per day.

Practical cold fusion cells are likely to use deuterium gas instead of heavy water, but this does not change the estimates of cost or the tons of heavy water required. All of the deuterium on Earth is in heavy water, which is mixed in with ordinary water. Deuterium gas costs more than heavy water when purchased retail, but in a factory assembling cold fusion cells it will cost less, because advanced extraction techniques produce deuterium gas instead of water.

The 6,162 tons of heavy water we would use for worldwide energy production would be converted into 4,930 tons of free oxygen, 1,227 tons of helium, and 5 tons of the mass would be annihilated, converting into energy, according to Einstein's special relativity formula $E = mc^2$. The same 5 tons of mass is annihilated now, with chemical and solar energy. All sources and forms of energy convert mass to energy.

⁵⁵ Miller, A.I. (Atomic Energy of Canada Ltd.), *Heavy Water: A Manufacturers' Guide for the Hydrogen Century*. Canadian Nuclear Society Bulletin, 2001. 22(1), http://www.cns-snc.ca/Bulletin/A_Miller_Heavy_Water.pdf

⁵⁶ Miller, A.I., *ibid*.

There are 2×10^{13} tons of heavy water on earth, enough to last 3.2 billion years at present energy consumption rates. This should suffice for nearly as long as the planet exists; the sun is expected to last 4 or 5 billion years before becoming a white dwarf. There is a great deal more heavy water elsewhere in the solar system, and it is more concentrated on some planets. On Earth it is 0.015% of water; on Mars it is 0.1%, and on Venus it is 2.2%.⁵⁷

Incidentally, the average automobile will consume about a gram of heavy water per year. This is assuming that first generation cold fusion heat engines will be only as efficient as today's gasoline engines, converting 20% of the heat into vehicle propulsion. (It is hard to imagine they would be less efficient. It would take a perverse genius to devise a modern vehicle more wasteful than today's conventional automobile.) The average U.S. passenger car travels 11,766 miles per year (18,936 kilometers), burning 532 gallons of gasoline (2,014 liters).⁵⁸ The burning fuel generates 70,000 megajoules of raw heat. It converts 14,000 megajoules of this heat into vehicle propulsion. Propulsion ends up heating the surrounding air. All energy finally degrades to waste heat, or entropy.

To put it another way, the average U.S. car would go 48 million miles with one gallon of heavy water.

6. Platinum Group Problem

It may be that cold fusion only works effectively with platinum group precious metals (iridium, osmium, palladium, platinum, rhodium and ruthenium). If so, this will severely limit its usefulness. Platinum is currently worth more than gold, and palladium reached \$1,090 per ounce in 2001. Demand for palladium outruns production, so precious metal companies already make every effort to find it, using the latest technology, but they can only mine and recycle 171 metric tons per year.⁵⁹ It is not likely they can improve this much, even if cold fusion creates tremendous demand. So, if cold fusion only works with palladium, we will have to make maximum use of the palladium we have, by generating power from it 24 hours a day in large, centralized, baseline power company plants. We will not have enough metal left over for individual home generators or automobiles, because these machines are idle most hours a day. Our automobiles and houses will use electricity or hydrogen produced by the central plants.

It is ironic that half the world's palladium now goes into automobile catalytic converters. Fortunately, we will not need these catalytic converters with cold fusion. Probably, the best plan would be to take the palladium out of the automobiles, put it into the large, central generators, and use pollution-free hydrogen powered internal combustion engines in hybrid electric vehicles. Most hydrogen-power advocates want to use fuel cells, but we could not do that because, as it happens, fuel cells also require platinum group metals. This is no coincidence. Fuel cells and cold fusion both employ surface catalysis effects, and platinum group metals make the best catalysts. The wet electrochemical cells pioneered by Fleischmann and Pons resemble fuel cells. A cold fusion electrochemical cell uses electricity to convert water into hydrogen and oxygen; a fuel cell is an electrochemical cell run in reverse, converting hydrogen and oxygen into electricity.

⁵⁷ Miller, A.I., *ibid*.

⁵⁸ *Annual Energy Review 2002*. 2003, Energy Information Administration, U.S. Department Of Energy. <http://www.eia.doe.gov/emeu/aer/>, p. 61.

⁵⁹ U.S. Geological Survey <http://minerals.usgs.gov>. For other years some sources put the numbers closer to 220 metric tons. About 100 tons are mined.

There is one more twist to this problem. Cold fusion can transmute the cathode metal into some other metal. This was definitively proved in experiments at Texas A&M, Hokkaido University, Mitsubishi Corporation and elsewhere. In other words, a cold fusion reactor might gradually convert the palladium into other metals, especially chromium and iron.⁶⁰ It is not clear whether this always happens. Perhaps we can find a way to prevent it. If we cannot, the 171 metric tons of palladium we mine every year will rapidly be converted into cheap, useless chromium and iron, before we can generate much energy from it. The scenario described above, with the 24-hour baseline generators, would only work if we can recycle the palladium and use the same cathode metal again and again for decades. If the palladium turns into iron in a few years, cold fusion will never be a practical source of energy.

Fortunately, there are good indications that cold fusion works well with abundant metals including nickel and titanium, although experiments with these materials have not yet been widely replicated, so I have lingering doubts about them. Cold fusion probably transmutes these metals too, but that may be an advantage. Suppose the process can be “tuned” to output any element we choose. After a cold fusion automobile engine has run for a few years, the cells inside it will be swapped out, and the metal recycled. A sizeable fraction of the nickel or titanium may be turned into gold or some other valuable element.

Cathodes may gradually self-destruct after years of use for other reasons. The heat from the nuclear reaction is intense and concentrated in a microscopic area, and it causes the metal to melt or vaporize, and form craters on the surface. The elements around these craters are often transmuted. This will not be a problem, because the metal can be melted and remanufactured, unless it is all transmuted into some other element. Of course this destruction will probably degrade performance and limit the lifetime of the cell. After a few years, if much of the surface has been vaporized or melted, the cathode is not likely to work. However, the melting can probably be kept to a minimum with good engineering, and ordinary wear and tear on the machinery limits the lifetime in any case. In early model cold fusion devices, thermal destruction plus contamination seeping in from outside the cell may limit useful life to a few years. Cathodes will have to be replaced during routine maintenance. Later, with better engineering and improved seals, cathodes and cells should last for the life of the machine.

⁶⁰ Mizuno, T., T. Ohmori, and M. Enyo, *Anomalous Isotopic Distribution in Palladium Cathode After Electrolysis*. J. New Energy, 1996. 1(2): p. 37.

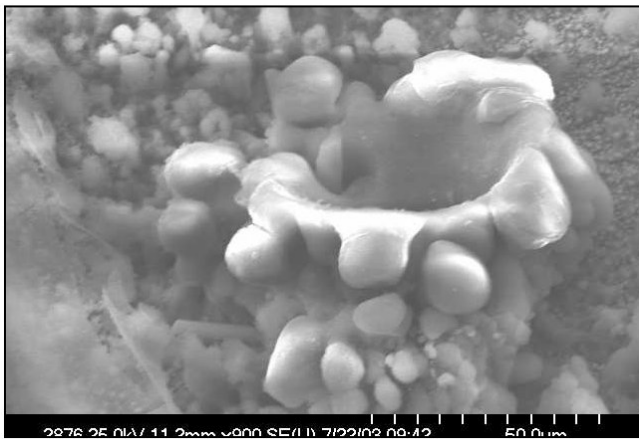
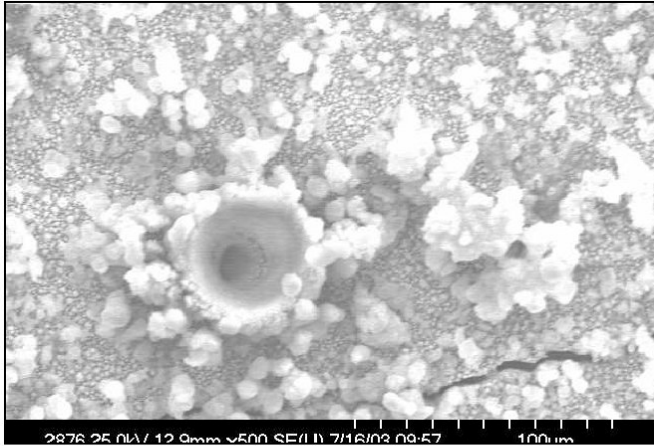

Figure 2.8. Features suggestive of the solidification of molten metal occurring under a liquid. From Szpak, S., P.A. Mosier-Boss, and F. Gordon. *Precursors And The Fusion Reactions In Polarised Pd/D-D₂O System: Effect Of An External Electric Field.* in *ICCF-11.* 2004.

3. How We Can Make Some Predictions Now

Before cold fusion can be commercialized, it must overcome many hurdles, starting with the political opposition that has prevented funding. That achieved, large-scale research can begin. Progress may be slow until a comprehensive theory emerges, and no one can say when that will happen. Once we have a theory and we learn how to completely control the reaction, engineering development can begin. Products such as space heaters and engines will have to be redesigned, and rigorous tests will have to be performed to ensure that they cause no harm to living creatures or the environment. It seems unlikely there will be any safety issues, because cold fusion emits few particles, and the ones it does emit can be shielded with a sheet of paper or aluminum foil. Indeed, they emerge from cells so rarely it is difficult to detect them, even with sensitive instruments. Hundreds of researchers have worked with active, unshielded cold fusion cells, with no signs of ill health.

Experiments have shown that cold fusion has the following physical characteristics, which mean it can become a practical source of energy with revolutionary potential:

- In a few experiments it has produced temperatures and power density high enough to generate electricity or mechanical power in a reasonably compact engine.
- Unlike a gasoline engine, a cold fusion cell does not need oxygen, and it does not produce carbon monoxide or other exhaust gas, so it can be used indoors as easily as outdoors, or for that matter, underwater, or in outer space.
- It does not produce dangerous penetrating radioactivity or radioactive waste, so it can be used safely anywhere, even in a pacemaker implanted within the human body.
- While we do not yet know whether the nuclear fuel is the deuterium, the palladium, or a combination of the two, it is clear that a small amount of either fuel will last for decades. Cold fusion cells have generated thousands of times more heat than a chemical cell of the same size possibly could.
- It may work well with some common metals such as nickel or titanium, not just the platinum group metals. (See Chapter 2, Section 6.)
- It works equally well on a large or small scale.

We know that cold fusion can be scaled down, because it already has been. Most cold fusion cathodes are plates or wires about a centimeter long. Eventually a cold fusion thermoelectric battery, like the plutonium pacemaker battery shown in Chapter 2, will fit into cell phones, wristwatches and countless other small, low power devices. It might even work as nano-scale power supplies. It would be a more promising choice than, say, a microscopic internal combustion engine. We know cold fusion can be scaled up, because any energy source can be. It seems likely that individual cathodes or gas loaded metal plates will remain smaller than, say, the pistons in a gasoline engine, but with today's automated manufacturing techniques it would not be difficult to assemble thousands or even millions of small mass produced cells to form a megawatt reactor. A conventional 1,000-megawatt fission reactor is powered by thousands of small uranium fuel pellets (Fig. 3.1). The pellets are black uranium cylinders, 1.7 centimeters long and 0.7 centimeters in diameter. They are packed into fuel rods. Similar sealed units may eventually power cold fusion engines of all sizes, each containing electrodes and a permanent supply of heavy water or deuterium gas, packed into a rod or box.

SOURCE ENERGY EQUIVALENTS

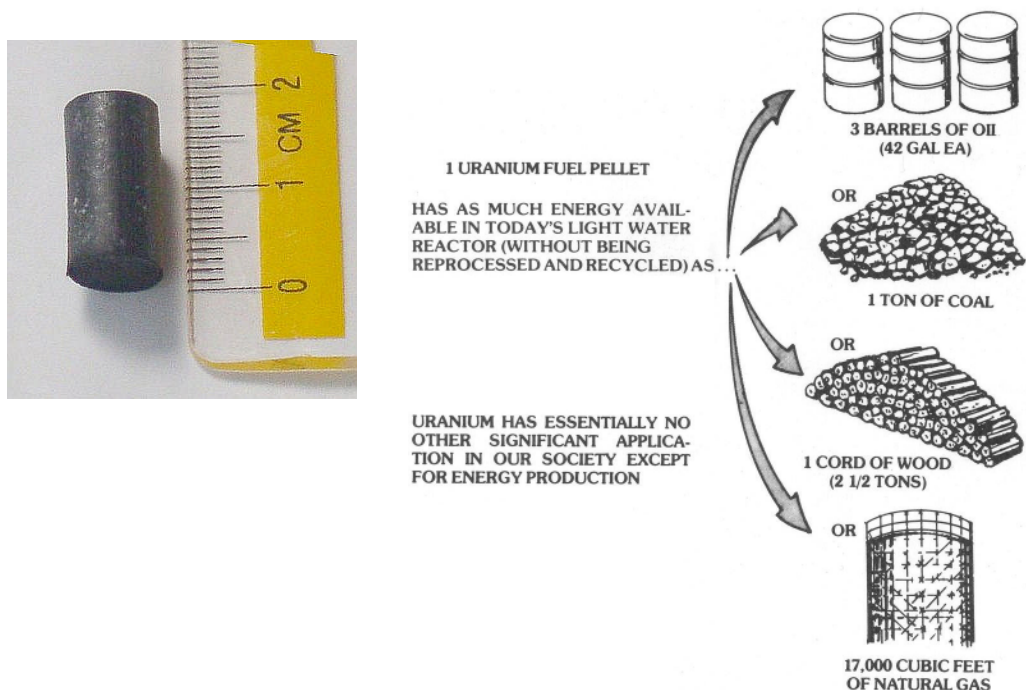

Figure 3.1. A simulated pellet of uranium nuclear fuel (which is actually made of rubber), from the American Nuclear Society, 555 North Kensington Avenue, La Grange Park, Illinois 60526

Some potential limitations of cold fusion are also becoming clear. There may be a high-temperature variation of the effect, called glow discharge or plasma electrolysis cold fusion,⁶¹ but it seems unlikely that cold fusion can be made hot enough for a blast furnace or an earth-to-orbit rocket engine. This does not mean we will need other primary sources of energy. Cold fusion can generate electricity for a blast furnace, or separate water into hydrogen and oxygen, the fuel that powers the Space Shuttle.

Even though cold fusion is still in the experimental stage, we can already draw some conclusions about product engineering. The previous list described some physical parameters. Here are some additional assumptions about product engineering:

- Different devices will be developed to work across a wide range of temperatures, from lukewarm to the melting point of the palladium, nickel or titanium cathode. Since the effect has vaporized cathodes, we know it can reach these extreme temperatures. It is just a matter of engineering the cells to remove the heat quickly and keep damage to a minimum.
- A variety of heat engines will be developed to work with it on any scale, to make cold fusion fits a wide range of applications; more than are served by any single conventional energy source such as gasoline engines, AC electric power, or battery power.

⁶¹ Mizuno, T., et al., *Production of Heat During Plasma Electrolysis*. Jpn. J. Appl. Phys. A, 2000. **39**: p. 6055.

- At first, cold fusion will mainly be used as small technology, to produce heat or electricity between one watt and one kilowatt. Small machines are easier to engineer, cheaper to make, and more profitable per watt of capacity.
- Heat engines and batteries can be designed to contain any radiation or short-lived dangerous radioactive byproducts such as tritium.

Part II: How Cold Fusion Will Change Society and Technology

4. Ordinary Technology, Everyday Goods and Services

If cold fusion can be commercialized it will eventually revolutionize every aspect of life. Not because it possesses any unique attributes. On the contrary, it is an unremarkable heat source. It is the very ordinariness of cold fusion which, coupled with its safety, makes it so desirable.

Very ordinary cold fusion will bring about ordinary changes, at first. The new energy revolution will not be heralded by amazing and futuristic applications, but rather by basic changes to daily life. More people will have unlimited clean power, pure water, pollution-free living space. Decades later, cold fusion may usher in futuristic applications such as underground maglev trains and orbiting zero gravity hotels for the millions, but at first it will change the world by giving clean water to billions of poor people.

The first cold fusion machines will be those we need most: pumps, motors, electric lights, space heaters, water heaters, air conditioners and automobiles. These are the obvious targets for three reasons:

1. These are the most widely used and indispensable machines.
2. In the aggregate they use most of the energy we consume. Giant machines such as railroad locomotives, airplanes and blast furnaces are impressive looking, but overall they use less energy than small machines do.
3. Small machines are cheap, and people buy them in their local stores, so the pace of change will be governed by consumers. (See Section 2, below, and Chapter 7, section 5.)

One Sunday morning at church during the 1930s Rural Electrification project, a Georgia farmer said there are two great miracles in life: “Jesus in your heart, and electricity in your house.” Today we have electricity, clean water, and other necessities in such abundance, we take them for granted and we cannot imagine life without them. Unfortunately, a third of the human race — two billion people — does not have them, and this causes appalling human suffering and ecological damage. Unsanitary water kills 2.2 million people per year, 5.3% of all deaths. Most of the victims are children under five.⁶² Poor people are forced to spend a large fraction of their income on kerosene. They must deforest the hills in India and Haiti to gather firewood, causing disastrous floods that destroy farms and villages and ruin the land. With cold fusion, at first these people will simply boil water for tea or baby formula. They know they should do this, but they often cannot afford the fuel. Later, small cold fusion powered water purifiers will provide enough clean water for cooking, bathing, animal feed and so on. Cold fusion will bring electricity, light to read books at night, power for televisions, cell phones and computers. In remote Chinese villages, small hydroelectric generators (most the size of a coffee pot) and low power LCD televisions are already bringing vital information and change; this trend will accelerate. Cold fusion will provide power for farm equipment, motorcycles, and cars.

⁶² Pruss, A., et al., *Estimating the Burden of Disease from Water, Sanitation, and hygiene at a Global Level*. Environmental Health Perspectives, 2002. **110**(5).

Poor Americans will also have reason to celebrate. In Atlanta, during a typical winter 50,000 families have their gas cut off because they cannot afford to pay the bill. Many Americans have trouble paying for gasoline at \$2 per gallon.

If cold fusion only succeeds in bringing 19th century Western levels of sanitation and illumination to the rest of humanity, it will be the most beneficial breakthrough in history. But it promises far more than that. Even though we have abundant pumps, motors, and lights in the first world, our machines are handicapped because our energy sources are inflexible, dangerous, filthy, and far too expensive. They may be causing catastrophic global climate change. They could be improved in countless ways, but we do not even see how bad they are, because we are used to the status quo. We lack inspiration and imagination; we cannot even envision how much better things might be. Cold fusion will bring many wonderful things to humanity, but perhaps the most valuable gift will be a renewed sense of hope, dynamic change, progress and the possibility of a brighter, expansive, better future.

1. Today's Energy Sources Are Not Good Enough

It is obvious that some energy sources are not up to the demands we make of them. The batteries in portable computers and cell phones are a nuisance. They are underpowered and they run out too quickly. Dead batteries in smoke detectors cause thousands of deaths and injuries. Many companies are developing fuel cells for cell phones, which will run weeks before recharging. The problems with some medical devices are even more dramatic. Consider implanted auxiliary heart pumps, also known as Ventricle Assist Devices (VAD). These are like artificial hearts, but they do not replace the heart; they help it, by boosting the flow of blood. Unlike replacement artificial hearts, they have successfully prolonged patients' lives. Some have worked for years. By reducing the workload of the heart, they can help it heal from a heart attack, or recover after surgery. Today's heart pumps have batteries that are recharged by electromagnetic induction through the skin. They have to be recharged frequently, since they use far more power than other implanted devices such as pacemakers. One of the first heart pumps, the AbioCor, was introduced in 2001. It weighs 3 pounds and it runs for only 30 minutes when the recharger is removed — or during a power failure. A cold fusion powered version would be smaller and it would last a lifetime. Not at first, though. With present day technology, the pump itself would probably wear out after five or 10 years. But cold fusion will encourage the development of longer lasting pumps, perhaps with artificial muscles (electroactive polymers - EAP). A heart does only about 2 watts of mechanical work, so the waste heat from an advanced thermoelectric converter implanted in the body would not be a problem.⁶³

Other medical devices are much needed, but simply cannot be made with present energy sources. Examples include powered prosthetic limbs, especially legs, and powered wheel chairs that can go long distances at high speed. Most wheelchairs are made for old people who do not wish to travel faster than a walking pace, but there are many disabled young people who might prefer to drive a motorized wheelchair at 15 kilometers per hour (running speed) for a distance of 10 or 20 kilometers. Wheelchairs invented by Dean Kamen can climb stairs, steep grades and uneven surfaces. Kamen also developed the Segway "Human Transporter." The wheelchairs and the Segways would both be improved with cold fusion. So would the electric bicycle — my favorite form of urban transport.

⁶³ Pinkerton, G., *Miniaturized Electronics: Driving Medical Innovation*, Medical Device & Diagnostic Industry

You should not imagine that people would never allow a nuclear powered pacemaker, prosthetic device or heart pump. They would not think it too risky or futuristic. As we saw in Chapter 2, patients already accepted plutonium-powered pacemakers. A conventional chemical pacemaker battery lasts about six years before it must be replaced, in a painful and somewhat risky procedure. Patients will be happy to accept devices that last a lifetime.

While everyone sees that present day batteries are not good enough for cell phones and heart pumps, we fail to see that all energy sources are similarly impaired, short-lived, and expensive. They were good enough for the 19th and 20th centuries, but our standards have risen. Consider the small gasoline engines used in garden tools such as leaf blowers and lawnmowers. These are infuriating and dangerous. They are heavy to carry around. They are inefficient, converting only about 10% of the heat from the burning fuel into mechanical energy. They make such a racket, they can be heard a mile away and they will damage your hearing if you use them often without protective earmuffs. They are difficult to start. When the mechanical load is too large, they stall, and you have to go through the rigmarole of starting them up again. They spew out stinking, poisonous smoke, so they cannot be used indoors. After a few minutes of use, the engine block grows so hot it can severely scald a person or ignite a fire. People who use these tools must store containers of toxic, explosive gasoline in houses and garages, which cause thousands of spills and serious accidents every year.

In the future, when people have grown used to the freedom and convenience of cold fusion, they will suppose we must have been continually frustrated and enraged by these wretched machines. We feel the same sense of pity when we look back at the people in 1600, who could not travel faster than 13 kilometers per hour on horseback over rough roads. We suppose they must have felt isolated and frustrated. But they probably did not feel that way. They did not think of themselves as having a transportation problem, because they did not realize that improvements were possible. This was a failure of imagination. Things began to change in the mid-1600s in France, when canal construction got underway and roads were improved for the first time since the fall of the Roman Empire. People really woke up to the possibilities when railroads were developed, beginning in the 1820s. After railroads reached every major city in Europe and America, some people were again lulled into a sense that transportation was perfected and no further progress could be expected — or was needed. Hiram Maxim was a brilliant inventor but he failed to see that automobiles had important advantages over railroads. His failure of imagination shows that having the tools and the technical ability to accomplish a goal is not enough. You must see the necessity, sense that it is worth the trouble, and feel there is profit potential. Maxim wrote:

It has been the habit to give the gasoline engine all the credit for bringing in the automobile — in my opinion this is the wrong explanation. We have had the steam engine for over a century. We could have built steam vehicles in 1880, or indeed in 1870. But we did not. We waited until 1895.

The reason why we did not build road vehicles before this, in my opinion, was because the bicycle had not yet come in numbers and had not directed men's minds to the possibilities of long distance travel over the ordinary highway. We thought the railroad was good enough. The bicycle created a new demand which went beyond the ability of the railroad to supply. Then it came about that the bicycle could not satisfy the demand it had created. A

mechanically propelled vehicle was wanted instead of a foot propelled one, and we know now that the automobile was the answer.⁶⁴

We will not begin the transformation to cold fusion — or to conventional alternative energy systems such as wind power and hybrid automobiles — until many people realize how bad our present energy systems are, and how much better they might be. Progress begins with discontent.

2. The Machines Themselves Will Be Cheaper

Cold fusion powered equipment will be expensive when it is introduced, but once the novelty wears off and competition picks up, the cost should fall to be about the same as conventional fossil fuel models, because a cold fusion cell will be no more expensive than a battery, and the rest of the hot water heater or automobile will cost about as much as a conventional model. After years of intense competition, when dozens of competing brands become available, cold fusion models will be cheaper than fossil fuel ones. They will be simpler, with fewer components. Automobiles, for example, will not need a muffler, a catalytic converter to reduce pollution, or a gas tank.

Given a choice between a fossil fuel machine that costs hundreds of dollars a year to operate, or a cold fusion one for the same price that costs nothing to operate and causes no pollution, all consumers will select the cold fusion model. The fossil fuel models will soon go out of production.

Cold fusion heaters and automobiles may not seem very revolutionary to Americans, except in one obvious respect: the fuel will cost nothing, and it will only need to be refilled during regular maintenance. You will be able to heat or cool your house all year long, or drive tens of thousands of miles with one charge of fuel. But Americans are used to keeping their houses as hot or cool as they like, and they already drive as much as they need to. Driving is constrained already by heavy traffic. Most people would not drive 200 miles a week extra even if someone else paid for the gas. Middle-class Americans use all the energy they want.

Middle class Americans will be thrilled that poor people's lives are improved, and relieved to see the nightmare of global warming gradually recede, but cold fusion may not save them much money at first. It will not affect them directly, unless they work for the electric company or an oil company, in which case they will soon be unemployed. (I hope this unemployment will be offset by new opportunities created by cold fusion.) Still, small changes will begin immediately, and there will be so many stealthy changes they may soon have a large impact. Change will permeate through society more quickly than most businessmen and economic experts predict, because cold fusion is small technology. It fits under your arm; you will be able to carry a typical cold fusion powered gadget out of the store. Or drive it off the parking lot. When millions of people decide to buy something new, and when they find it easy to incorporate into their lives, it soon has a major impact. In 1908, cheap, mass-produced automobiles appeared on the market. They quietly but quickly began to affect people's lives, even though they were purchased one at a time, and at first only a few people in a town owned one. In 1980, few people imagined that personal computers would soon have a major impact on people's lifestyles, jobs, entertainment, dating, marriage, childrearing, and other aspects of their personal lives. The changes came unnoticed, one person at a time.

⁶⁴ Rae, J., *The American Automobile Industry*. 1984, Boston, Mass.: Twayne Publishers, quoted in Cardwell, D., *The Norton History of Technology*. 1995: W. W. Norton & Company, p. 368.

Some experts have predicted that even if cold fusion were perfected today, it would take 50 years for it to replace other sources of energy and to become deeply embedded in most people's daily life. It took roughly 50 years for telephones, electricity, and electric lights to reach most houses. Gasoline powered automobiles were first made in the 1880s, but they did not go into mass production until 1908, and there were not huge numbers of them blocking traffic in towns and cities until the 1920s. They could not be widely used until a giant infrastructure of roads and gas stations could be built, but cold fusion cars can use the roads we already have, and they will not need gas stations. Computers were invented in 1945, but they did not become ubiquitous until 45 years later. I do not think cold fusion will follow this pattern. Electrification, the telephone network, automobile manufacturing, and the development of microprocessor fabrication plants took decades to pan out because these are gigantic, capital-intensive, complex industrial processes. Cold fusion will be much simpler.

3. Energy Is Integral To Everything

All machines use energy. Energy is the one commodity that affects the economics and engineering of every industry and trade. When you change the cost and availability of energy, the rest of the spreadsheet changes.

Cold fusion will lower the cost of raw materials, by lowering the cost of mining, transportation, process heating, sawing, milling and so on. Everything from wood and stone to the latest high-tech carbon fiber materials will be cheaper. Cold fusion will dramatically lower the cost of materials with high energy content (also called embodied energy), such as aluminum, steel, copper, brass and cotton.⁶⁵

In today's world, the fossil fuel industry itself is by far the largest user of energy. Oil companies burn oil to run their wells, supertankers, refineries, pipelines and gasoline delivery trucks. A North Sea drilling platform has so much equipment, such as drills, helicopters, living quarters, power generators and heaters, that the platform itself consumes as much fuel as a small oil well produces. Energy used to produce fuel is called overhead. Oil companies use between 10% and 20% of the oil they produce to keep their own machinery going. (Pimentel⁶⁶ estimates 20%. Informal sources list 10%. Apparently, it depends on where the oil is extracted, the type of well, how far the oil is shipped, and what grade of fuel the refinery produces.) Coal is more efficient; the overhead is around 8%. Wind turbine overhead is roughly 2%. After a wind turbine is erected, it takes three or four months for it to produce enough electricity to "pay back," with enough energy to manufacture another wind turbine. The machinery lasts about 20 years, after which blades and turbines must be replaced. The tower lasts much longer. The only significant energy overhead with cold fusion is the energy used to extract heavy water from ordinary water. This is 0.05% with today's heavy water extraction techniques, and it will probably be less in the future, because the techniques should improve. (See Chapter 2.)

Cold fusion will free up vast amounts of materials, skilled labor, and capital now used by the energy sector. The materials include such things as the steel and concrete in the power distribution infrastructure, and oil tankers. About a quarter of all ships are oil tankers, and they

⁶⁵ Centre for Building Performance Research, Victoria University of Wellington, New Zealand, <http://www.vuw.ac.nz/cbpr/documents/pdfs/ee-coefficients.pdf>

⁶⁶ Pimentel, D. and M. Pimentel, *Food, Energy, and Society, Revised Edition*. 1996: University Press of Colorado, p. 17.

carry 34% of all cargo. That is to say, they have 385 million DWT (deadweight tons of capacity), and the total capacity of all ships is 850 million DWT.⁶⁷

Cold fusion will free up the land used for coal strip mines, oil refineries and power lines.

Conventional energy overhead is high because energy production requires a vast infrastructure of oil wells, pipelines, refineries, seaports, gas stations, natural gas pipelines, electric power generator plants, hydroelectric dams, coal mines, thousands of miles of coal trains, high-voltage power lines, distribution power wires on every street, and on and on. When you drive along a highway or fly over a city, much of the man-made landscape you see is devoted to energy production, storage and distribution. With cold fusion, all of this infrastructure will be eliminated. A dozen factories could supply enough heavy water fuel to meet the entire world demand for energy.

The embodied energy cost of food is high. Note that “embodied energy” does not mean caloric content — the energy you get from eating the food. The embodied energy in a steak is the energy needed to run the tractors to grow the corn that is fed to the cows, and the energy used to transport the cows, butcher them, and then refrigerate, transport and cook the meat. The embodied energy in food has increased tremendously in recent years, especially when fresh fruit is carried from South America or Australia halfway around the world to the U.S. and Europe. A can of sweet corn has 375 kilocalories (kcal) of nutrition, but it requires 3,065 kcal to manufacture, including 450 for production — mainly farm machinery fuel — and 1,006 kcal for the packaging. Primitive techniques used to grow and process food took much less energy. If it takes 3,065 kcal of work to make a serving of corn, but the corn yields only 375 kcal of nutrition, you would starve to death growing corn if you did all the work yourself. You do not starve because machines do the work for you, and they end up burning 10 calories of fossil fuel for each calorie of food energy they make.

Modern methods of food preservation, such as refrigeration and freezing, take much more energy than old methods such as drying and canning. To freeze a package of corn takes 1,270 kcal, and to run the freezer and keep it frozen takes another 265 kcal per month.⁶⁸

Meat is by far the most extravagant food. It takes a tremendous amount of fossil fuel to grow the plant food we feed to the animals we eat. It takes roughly 13,000 kcal of fossil fuel energy, mainly oil, to produce a 140 g serving of beef, which has only 375 kcal of food energy. To put it another way, a quarter-pound hamburger comes with a half-gallon side order of gasoline. We depend on oil much more than we realize. If it runs out, not only will we be unable to commute to work; we will starve. The good news is that when cold fusion replaces oil, it will immediately and drastically reduce the production cost of food.

4. Efficiency Will Still Be Important

Some people have suggested that once we have cold fusion, we will stop worrying about energy efficiency altogether. For example one person said, “efficiency will not save money anymore, so buildings will not need insulation to save money.”

⁶⁷ Organisation for Economic Co-operation and Development, <http://www.oecd.org/dataoecd/39/20/2751848.pdf>

⁶⁸ Pimentel, *ibid.*, p. 192, 195. Note: 1 kcal = 4,184 joules; the can of corn takes 12.9 megajoules, which is the energy in 307 grams of gasoline.

It is true that in some cases we will find it economical to trade off efficiency for lower cost. For example, with most heat engines, you can trade off energy efficiency for low equipment cost. Cool, low-pressure steam causes less wear and tear on pipes and turbines. (See Chapter 14)

However, in many other cases energy efficiency will remain essential, not because it saves money, but because inefficient machines simply would not work. They would be too bulky or they would become dangerously hot. In Chapter 2 we imagined trying to run a house with the NASA Cassini RTG (radioisotope thermoelectric generator). Since these devices are only about 10% efficient, to achieve usable power levels you would need 30 or 40 of them, each the size of a person, and they would be hot enough to heat your whole neighborhood.

A car that has only 5% or 10% efficient would have a huge engine, like a 19th-century steam tractor. A building with no insulation would require a large, noisy heating system, and even then it would be drafty and uncomfortable. To take an extreme example, a traditional Japanese farmhouse is as drafty as any structure can be: the walls are literally made of paper. (They also use thin wood slats in bad weather and at night, which are not much warmer than paper.) When you live in such a house in winter, you are only warm once a day, when you take a bath. The toothpaste freezes. Rooms are heated with small braziers, and with a kotatsu, which is an electric or charcoal heater under a blanket under a table.



Figure 4.1. A Japanese family in a modern house eating a meal under a kotatsu. In a traditional farmhouse in winter, they would be wearing coats, and milk left on the table overnight would freeze. Source: The Japan Forum, TJF Photo Data Bank, <http://www.tjf.or.jp>

A kotatsu in a farmhouse is cozy and warm, and it has wonderful romantic possibilities, but few Japanese people today would put up with the cold long enough to experience it. You might put a 5-kilowatt cold fusion space heater in every room, but it would not really help. It would be like having a roaring fire in the fireplace of a medieval castle; you would end up too hot on one side and far too cold on the other.

There is another reason efficiency will remain important. In the distant future, the human race might increase its energy consumption by a factor of 10 or 100, to carry out some of megaprojects described in this book. If we increase the work done by machines by such a huge factor, the waste heat from them may harm the biosphere, adversely affecting humans and other

species. Even now, in large cities where automobiles are concentrated, the local temperature is one or two degrees warmer than the surroundings and snow melts more quickly. This cannot be good for trees and plants. To reduce the waste heat from future machines we will have to keep them reasonably efficient.

In the near term, before we launch any megaprojects, cold fusion is likely to increase overall efficiency, and substantially reduce the total amount of energy expended by the human race, mainly because it will allow the use of electric power cogenerators, as described in Chapters 14 and 15.

5. Machines That Will Be Particularly Enhanced by Cold Fusion

Cold fusion will make all machines cheaper. It will enhance the performance of some more than others. It will not improve a large television set or a sewing machine. There is no advantage to making a sewing machine portable; it is no trouble to plug one in, and they use only a little electricity in any case. Other machines will become cheaper to operate, more convenient, and less polluting. Here is a list of some ordinary machines that will most benefit from cold fusion. The ones that will be the easiest and most profitable to convert are listed first:

- Portable computers, telephone repeaters, cellular phones, aircraft black box recorders and other electronic devices will operate continuously for decades without recharging, by utilizing thermoelectric batteries.
- Electric lights. Especially stand-alone, rugged, low powered white LED types, also powered by thermoelectric batteries. These would be ideal for emergency lighting, camping, or for use in third-world villages.
- Small room heaters. Larger centralized space heaters (furnaces). Water heaters.
- Pumps and other small motors, perhaps powered directly by steam turbines or Stirling engines, or by thermoelectric batteries.
- Thermal refrigerators, such as the gas-fired refrigerators sold today. Thermally activated absorption chillers for air-conditioning. These work well at temperatures just above the boiling point.⁶⁹
- Automobiles, motorcycles, tractors and other small vehicles.
- Large but relatively simple industrial equipment, such as furnaces to cure materials at temperatures below boiling.
- Large furnaces for process heating above boiling temperatures.
- Larger vehicle engines for trucks and heavy equipment.
- Megawatt scale generators and industrial equipment.
- Large-scale desalination plants.
- Railroad locomotives, marine engines.
- Thermal depolymerization plants to treat sewage, garbage and plastic. These produce synthetic oil, and fertilizer. Oil will not be needed as fuel, but it will still be useful for industrial feedstock and lubrication. Someday these plants may be fully automatic and enclosed, and reduced in size until they fit on the back of a truck. They might be mass-

⁶⁹ U.S. Department of Energy, *Thermally-Activated Absorption Chillers*, http://uschpa.admgt.com/TB_TAchillers.pdf

produced and then delivered to thousands of villages and towns for local sewage treatment. See Chapter 13.

- Aerospace engines

6. Small Machines First

Let us assume the cold fusion effect will become fully reproducible and controllable, and someday — call it Time Zero — the physicists and chemists will hand over prototypes to engineers. Basic research will continue, and improved devices will soon follow. The first practical transistors were developed in 1952 and quickly released to product engineers for mass production, but basic research to improve transistors continues to the present day.

It will be a few years before the engineers do their jobs, and production lines are set up. In the meanwhile, regulatory, health and safety agencies will make sure the devices are safe. I suppose small commercial products will emerge three years after Time Zero. Small machines are easier to develop and cheaper to manufacture than big ones, so they will come first: water heaters, space heaters, heat engines for pumps, and thermal refrigerators and air-conditioners. A few expensive and complex machines will also be produced quickly. NASA, the military, and the telephone companies will want cold fusion thermoelectric generators for critical applications in hard-to-reach places.

Oil is the most expensive fuel per megajoule. Most oil is used in transportation, mainly in cars and trucks, so these will be the prime targets for conversion. Of all the things you can power with cold fusion, an automobile will be the most desirable from the consumers' point of view, and it will have the largest beneficial impact on pollution, global warming and the economy. Manufacturers will realize this, and they will make every effort to develop cold fusion models, but it takes a long time to engineer a new automobile, and prepare new production lines. Ten years after Time Zero automobiles should arrive. Toyota and Honda took about five years to design and begin selling hybrid gasoline automobiles. Cold fusion models will probably be hybrids, with a cold fusion steam turbine or Stirling engine replacing the gasoline motor. Since the Japanese manufacturers are far ahead in this technology, and American manufacturers are only now beginning to license hybrid engines from them, the Japanese can be expected to take the lead in cold fusion automobiles.

At about the same time automobiles arrive in the showrooms, we can expect electric power cogenerators, suitable for houses or apartments.

Many machines that we now assume require electricity may work well with cold fusion heat, or heat engines, instead. We are so used to electricity, we tend to forget that other motive power is almost as convenient. Automobile mechanics and carpenters use tools powered by compressed air, because they are cooler and they do not spark, so they are safer. In the late 19th century, small automatic steam engines performed many jobs that are now done with electric motors. A cold fusion powered clothes dryer would use cold fusion heat directly to dry the clothes, and it might even use a handheld heat engine, perhaps a Stirling engine, to spin the tumbler. The direct use of heat in place of electricity is discussed in Chapter 15.

It may turn out that large generators work better with some form of high temperature cold fusion, rather than thousands of small cells harnessed together. In that case, megawatt reactors and large truck engines may take a few years longer to bring to market, and perhaps cold fusion will not sweep through society quite as rapidly as I predict. However, small machines, such as

light bulbs and air conditioners, consume almost all energy. Once we reach the kilowatt level, the transformation will be rapid and profound, and it will begin to alter the lives of individuals, societies and nations. In the next phase, dramatic new machines will be invented that take advantage of cold fusion to do things that are today almost unimaginable, and that could never be done with fossil fuel, solar or wind power. The first item in that category is the desalination plant. This is still in familiar territory. Millions of people already get their drinking water from desalination plants. Although the desalination plant itself is unexciting, it will be one of the first cold fusion powered machines with the potential to make planet-wide, dramatic improvements that few people have anticipated or dared to hope for until now: it will make the deserts bloom.

5. Revolutionary Technology

Beyond the ordinary, workaday machines described in the previous chapter, cold fusion will enable many new technologies that would be impossible or impractical with fossil fuel. One of the most dramatic and beneficial will be large-scale desalination. Desalination plants convert seawater into potable freshwater. In arid but energy-rich nations, mainly in the Middle East, they supply millions of people with drinking water. But they could not possibly supply enough water for large-scale agriculture, because they require fossil fuel or nuclear power, and the cost and resultant pollution would be prohibitive. With cold fusion, desalination plant output can be scaled up a hundred times, and eventually thousands of times, until they produce a man-made river of freshwater for continent-scale irrigation and reforestation. Eventually so many new trees and plants will grow, they will have a positive impact on the climate, converting parts of the Sahara and Gobi deserts into farmland.

It would be a terrible idea to convert all deserts into farmland. This would drive desert species into extinction, reduce biodiversity and cultural diversity, and destroy some of the world's most spectacular scenery. But the Sahara and the Gobi deserts have probably expanded because of human activity, and it would not hurt the ecology to shrink them back down. The increased farmland in Africa will be ideally placed to feed some of the world's most impoverished nations, and oil-producing nations such as Saudi Arabia that will soon be joining their ranks. In the United States, deserts and arid areas should be preserved, but it would be of inestimable value to produce a great deal more freshwater for cities such as Los Angeles and Las Vegas, and if verdant suburban lawns and farmland in these places increased by a million hectares it would not damage the ecology. In Haiti, the use of cold fusion energy instead of wood fuel, plus the dual introduction of desalination plants and a program of reforestation might reverse the catastrophic deforestation that has ruined the ecology, the economy, and that has killed thousands of people in floods. In India, when the monsoon fails and drought ensues, large-scale desalination plants will prevent widespread crop failures.

There have been news reports that in the near future, freshwater may replace oil as the most sought-after, and hence contentious resource. Wars may be fought over freshwater. Cold fusion will avert this nightmare scenario.

A desalination megaproject to transform the deserts is described in detail in Chapter 8.

Desalination is only one example of what can be accomplished with unlimited amounts of pollution-free energy. Desalination plants already exist. When we couple cold fusion to things already invented and commercialized, such as desalination, we will have the power to remake the face of the earth, eliminate shortages, starvation and pollution, and to vastly reduce the cost of industrial raw materials, fertilizer, food and other goods. Here are some other commercial technologies that can be combined with cold fusion to produce revolutionary changes:

The use of indoor farming will increase. Indoor farms range from simple greenhouses to computer-controlled, high-tech hydroponic farms, with plants growing in a water medium instead of soil. These are already common in Japan for crops such as tomatoes. Compared with conventional outdoor farms, they use less land, water and pesticide, resulting in reduced ecological damage. They are described in Chapter 16.

Communications will be improved. The cost of setting up cell phone service in undeveloped nations and areas with low population density may be reduced drastically, by deploying cold fusion powered high-altitude pilotless aircraft instead of cell phone towers. These will be much lower than satellites. They will easily reach ordinary cell phones. (Cell phones that can reach low orbit satellites exist, but they require extra power, the handsets are large, and bandwidth is limited.) Aircraft will cover a much wider area than most cell phone towers do, except for those atop high mountains. The aircraft will stay on station for months at a time, circling over a narrow area, or perhaps hovering like a helicopter. They will fly above storms and commercial air traffic. From time to time, a replacement aircraft will be dispatched, and the first one will return to the ground for routine maintenance. They will also serve as radio and television transmitters. They will be deployed in northern latitudes that cannot be reached with geosynchronous satellites. NASA is trying to develop solar powered airplanes for these purposes, but they are delicate and could carry only a small payload, so they are not practical.

High altitude airborne cell phone towers will be helpful during search and rescue missions, particularly in rural areas where service is often spotty or undependable. A lost hiker is often unable to place a cell phone call, especially from a ravine where hills block the cell phone tower. This will not be a problem when the receiver is overhead in an airplane. In the future, nearly everyone will carry a cell phone. But if the hiker does not have one, or if something has gone wrong with his, high-altitude unmanned aircraft with cameras may be used to search for him. Chapter 10 describes a more radical approach: small, autonomous, semi-intelligent “birdbrain-class” computerized robots that will be dispatched to fly through the woods looking for people from treetop heights.

Dramatic new types of aircraft and spacecraft will be developed. Some will have much greater capacity than today’s vehicles, and some civilian aircraft will travel much faster. (See Chapter 18.)

Many energy-intensive, automated, advanced recycling techniques have been developed. Some have been held back by the high cost of energy. Cold fusion would ensure their success. For example, toxic chemical compounds can be destroyed by exposing them to molten steel in a tightly sealed container. The compounds break down into individual elements, which can then be sorted out and collected. Nothing is emitted into the atmosphere; this is not like a trash incinerator. Toxic waste from a “superfund” site could be converted into its base elements. A toxic element such as arsenic is still dangerous even after it is broken out of a compound, but the arsenic can be automatically separated, purified, packed in certified containers, and shipped to factories that use it as a raw material. Poisonous or carcinogenic compounds composed of nontoxic elements, such as dioxin, are instantly broken down into their constituent, harmless elements. (In the case of dioxin these are carbon, hydrogen, oxygen and chlorine.) Organic chemicals, sewage, and medical waste convert to water, carbon, and a few trace elements. Molten Metals Technology, Inc., a company in Massachusetts, which unfortunately went out of business, pioneered this approach.⁷⁰

1. A flood of new products

After the basic scientific research is finished and fundamental patents are granted, dozens (and later hundreds) of corporations will begin manufacturing cells. Thousands of other corporations

⁷⁰ Holusha, J., *BUSINESS TECHNOLOGY; No-Smoke Ways to 'Burn' Wastes*, in *New York Times*. 1993.

will then find ways to use these cells to enhance their products. There will be an explosion of product development. This happened with electricity, transistors, computers and other fundamental breakthroughs: first one company developed the core idea, then a larger group began manufacturing the core product, and a much larger group of companies used the core product for various applications. The number of people involved, the amount of money spent, and the level of enthusiasm is likely to be tremendous.

There is an interesting parallel in the history of aviation. Until 1908, most experts and nearly all newspaper editors did not believe that airplanes could exist. The Wright brothers flew in 1903, and demonstrated flights lasting up to 40 minutes to the public in 1904 and 1905, but the newspapers, journals, and experts denounced them and did not bother to take a trip to Dayton, Ohio. In August 1908, Wilbur Wright flew before a crowd of experts in France, who were astonished. The European press went wild, and all of Europe was at Wilbur's feet. One of their noisiest critics and rivals, Archdeacon, wrote: "For a long time, for too long a time, the Wright brothers have been accused in Europe of bluff — perhaps even in the land of their birth. They are today hallowed in France, and I feel an intense pleasure in counting myself among the first to make amends for that flagrant injustice."⁷¹ Back in the U.S., in the meanwhile, the event was ignored until Orville Wright performed a demonstration flight in Washington, D.C. a few weeks later. Aviation fever then swept the world. In 1911, a special issue of *Scientific American* devoted to aviation reported that: "more than half a million men are now actively engaged in some industrial enterprise that has to do with navigation of the air."

Soon after the commercialization of cold fusion begins in earnest, a half-million product engineers will be frantically working. When they hit their stride we can expect a flood of innovations. I expect that every major industrial corporation will develop products that use cold fusion. They will work frantically because General Motors will know that if it does not introduce a cold fusion powered car quickly, Ford or Toyota will bankrupt it.

Cold fusion will give rise to countless second-order effects. It will lower the cost of many goods and services, and allow new goods that would not have been cost-effective previously. It will make products lighter, stronger and safer.

I can only think of a few obvious uses for cold fusion. No doubt there will be millions of beneficial changes to machines of all types, but since I know little about most industries, I cannot guess what they may be. Engineers and product designers will soon learn how to use cold fusion, just as they learned how to use microprocessors when they became available in the 1980s. Designers soon put them into kitchen blenders, hotel guest room door locks, Jacuzzi bathtubs, and all sorts of other things people never imagined might work better with a computer inside. They became ubiquitous and invisible. Imagine telling someone in 1965 that his bathtub would soon be controlled by a computer more sophisticated than the one aboard an Apollo rocket. Your listener would be bemused rather than amazed. He might ask: "Why on earth does a bathtub need a computer? What is there to 'control' in a bathtub?" An engineer today might say: "Cold fusion would be a fine way to generate electricity, but why would anyone install it directly into a light fixture? We have all the power we need in the AC wiring already." It might not occur to the engineer, at first, that we have too much power in AC wires. Wires cause fires and electrocute

⁷¹ Archdeacon, E., *L'Auto*, August 9, 1908. I doubt the critics of cold fusion will ever make so gracious a concession, and the cold fusion researchers will never forgive their critics as gracefully as the Wrights did. The antagonism on both sides runs too deep for such amends.

people. It would be better to do away with them and have light fixtures and other machinery power itself. Electric wires today not only provide power, they control overhead light fixtures, turning them on and off, and dimming them. It would be better to run a network to control all light fixtures. That way, the lighting could be controlled from any room, or from outside the front door when you arrive home. The era of the simple on/off control is passing, in any case. The latest LED lighting fixtures require sophisticated computerized controls. They can be tuned to produce any color, shade or intensity you like, to fit your mood or the time of day. You can make a room deep red one moment, yellow the next, and daylight white the next.⁷² In the future we will have to devote much time to such vital decisions, just as we must now choose among thousands of different ring tones for our cell phones.

⁷² Yunis, J., *TRADE SECRETS, Light That Swings Quick as a Mood*, in *New York Times*. 2004. See also the photos at <http://www.colorkinetics.com/>, described in the article. The color can be varied because the lights are made up of discrete red blue and green LEDs. Actually, the lights produce just about any shade but *not quite* pure white, yet. It is telling that this article appeared in the “Home & Garden” section rather “Technology” or “Science.”

6. Synergy: Cold Fusion Combined With Other Breakthroughs

Cold fusion will spur progress in many other technologies. They will range from well-established and commercialized ones, to those that exist only as awkward prototypes. Still others do not yet exist, and may even be impossible to achieve, but if they can be made at all, coupled with cold fusion, they would be wonderful to have, and incredibly profitable. So if there is any way to make the really far out machines, people will be motivated to get on with the job.

Many technologies will become much more cost-effective and more valuable with cold fusion. This is synergy: “the interaction of two or more agents or forces so that their combined effect is greater than the sum of their individual effects.” (*American Heritage* dictionary). Here are some examples:

Thermoelectricity

Cold fusion produces heat. Most machines need electricity, so we must convert heat into electricity. We could use a large, noisy, spinning steam turbine generator, but a thermoelectric chip would be a more elegant solution and would achieve the same goal. A thermoelectric chip converts heat into electricity without moving parts, similar to the way a photovoltaic chip on a calculator converts light into electricity. Cold fusion thermoelectric generators will open up a broad range of applications that cannot be served by conventional turbine generators, such as the power supplies in a cell phone or wristwatch.

Thermoelectric chips will be an essential “peripheral” to cold fusion. They will open up a huge range of applications that cold fusion alone cannot reach, since most machines use mechanical power or electricity, and not heat. The chips in common use today are not up to the job, being only 5% to 10% efficient. There is scope for improving them, and progress has been made already. Some prototypes have approached 20% efficiency, and a few experts believe 50 to 80% efficiency is possible. The realization of cold fusion technology will crack the whip over this and other developments which, at present, lack any real impetus for improvement.

Industrial-scale Production of Pure Isotopes

Cold fusion may, in many cases, trigger multiple effects within just on one industry or even on an individual product. For example, it will not only make cars cheaper to operate, it will probably make them safer too. The multiple interactions of new and pre-existing technologies will be complicated and difficult to anticipate. For example, cold fusion will lower the price of many materials that take a lot of energy to make, such as copper. It may also lower the cost of separating the isotopes of copper and other elements. Today, pure isotopes are only prepared in minute quantities, mainly at national laboratories, and the samples are sold to researchers in gram or milligram lots. It is not widely known, but research has shown that different isotopes of copper may have radically different properties, such as better electrical or heat conductivity.

Many isotope separation techniques are expensive because they require a great deal of energy. Cold fusion would reduce this cost, which might spur the development of entirely new industries. Not only will cold fusion make ordinary copper cheaper, it might make special-purpose copper more effective, by allowing industrial-scale separation of copper-63 from copper-65.

Selected isotopes of silicon might make faster semiconductors. In the Star Wars missile defense program, the government produced samples of lead-207, hoping that isotope would make a space-borne rocket-killing laser work. (It did not work, but fortunately the government spent only \$250 million on that particular experiment before it abandoning it.)⁷³ However, outside of the nuclear power and nuclear weapons industries, no one thinks of using pure isotopes on an industrial scale because they are so expensive.

Tin is a common element, and costs about a dollar per kilogram. But a sample of tin-112 costs \$100 per gram, and tin-115 costs \$1,700 per gram.⁷⁴ Tin may be common, but tin-115 is only 0.34% of the naturally occurring metal, and it is difficult to separate out from the other nine isotopes. If inexpensive, macroscopic samples of pure tin-115 were made widely available, researchers might find they have remarkable and valuable properties. There would be no point to investigating tin-115 today, because even if you found it has a valuable property, the cost of manufacture would prohibit its widespread use.

Artificial Muscles

So-called “artificial muscles” or electroactive polymers (EAP) are under development. They mimic biological muscles. When electric power is applied to them, they contract. When the power goes off, they relax. They will replace motors, gears, bearings and other trouble prone moving parts. Compared to these mechanical devices, EAP are quieter, stronger, and last longer. Someday they may be used for prosthetic devices, artificial hearts, robots, ornithopters (wing flapping flying machines) and many other futuristic devices. The availability of a cold fusion power supply would spur their development. There is not much point in developing a versatile, lifelike, prosthetic leg with artificial muscles if the patient has to lug around a 10-kilogram (20-pound) battery pack to keep the leg going, which he then has to recharge every four hours.

Artificial Diamonds and Excavation

A great deal of research has been done on artificial diamonds, especially thin-film diamond applied to make eyeglasses scratch-proof, and cutting tools sharper and longer-lasting. This technique has not panned out yet, but if such blades are perfected and commercialized, in harness with cold fusion they would bring about huge improvements in excavation equipment. By combining diamond blades, cold fusion, and improved robots, we could to make automatic excavation machines with revolutionary capabilities. They will take advantage of cold fusion’s high power density and portability, plus its ability to operate without oxygen. They will lower the cost of mining raw materials, and make underground construction works much less expensive. Eventually, vast projects may be undertaken to put highways, shopping malls, warehouse storage space, factories, sewage treatment plants and other facilities underground. Some experts have speculated that even with today’s excavation machines, it may soon be cheaper to build underground than aboveground. Putting an industrial complex underground, or even under a shallow ocean would certainly be an aesthetic improvement. Cold fusion represents ‘green’ technology at its finest.

If diamond cutting tools do not pan out, we may find some other way to lower the cost of excavation with massive amounts of zero-cost energy, perhaps with power lasers or intense heat.

⁷³ Theodore Gray, *The Wooden Periodic Table*,
<http://www.theodoregray.com/PeriodicTable/Elements/082/index.html#sample14>

⁷⁴ Price quotes from TASC Corporation in Japan, 1999.

The move toward large-scale underground infrastructure has already begun in the U.S. with the Central Artery/Tunnel Project (or “Big Dig”) in Boston, Massachusetts.⁷⁵ Unfortunately, this proved to be a fiasco. The cost ballooned from \$2 billion to \$15 billion for only seven miles of roadway, and the tunnels are now leaking and will require extensive repair. Like the Channel Tunnel, it was an engineering tour de force but an economic disaster.⁷⁶ Still, it proves that extensive subterranean engineering is possible. Eventually the cost of such projects may become more predictable, and far lower.

In Switzerland, where roads and railroads are crowded, serious attention is being paid to a proposal to construct a massive underground maglev train system that will run in partially evacuated tubes at 500 kilometers per hour. This Swissmetro project would eventually be expanded all over Europe.⁷⁷ The project is speculative and futuristic, but in Japan, extensive excavation for railway and highway tunnels is already common, and with cold fusion robot excavation, the country will begin to look like a Swiss cheese. In Japan tracts of level open land are rare, and small, steep mountains are common, so there are many tunnels along highways and railways, and underground shopping complexes are often built as part of railway stations. Commuters avoid the dense downtown auto and bus traffic that converges on the station. They stay out of the rain for several blocks, and they can do the grocery shopping on the way home. They are also safe from earthquakes, which are common in Japan. It seems paradoxical, but the surface seismic waves from earthquakes do not affect underground construction. When a magnitude 7.1 earthquake struck San Francisco in 1989, some of the people riding the BART subway and waiting in stations reportedly did not even notice. With cold fusion eight lane highways might be built underground, four north lanes on the top level, four south lanes below that.

The biggest problem will be to dispose of the excavated dirt and rock. The Japanese do this by filling in the ocean and Tokyo bay, which is destructive. They leveled hills and small mountains outside of Osaka to build a new international airport in the middle of the bay. Japanese leaders have proposed maniacal schemes to level 20% of Japan’s mountains, over 75,000 square kilometers, to “dump them into the sea to create a fifth island about the size of Shikoku.”⁷⁸ Unfortunately, the limitless energy provided by cold fusion will enhance our ability to make colossal mistakes and wreak environmental havoc.

Automobile tunnels are described in detail in Chapter 17.

Artificial intelligence

Despite enormous investment, many aspects of modern computer science applications — particularly robotics — have not made much progress. Artificial intelligence has never been convincingly developed and hence neither has a truly autonomous robot. The Defense Department’s DARPA held a widely ballyhooed “Grand Challenge 2004” 300 mile race of autonomous unmanned vehicles (automobiles and motorcycles). The roadway was cleared of all other traffic. The robots did not have to deal with other vehicles, rain, or darkness. DARPA reported laconically: “No team entry successfully completed the designated route for the

⁷⁵ Central Artery/Tunnel Project, <http://www.bigdig.com/>

⁷⁶ Pym, H., *BBC Analysis: Eurotunnel’s money troubles*, <http://news.bbc.co.uk/1/hi/business/3472955.stm>

⁷⁷ The Swissmetro/Eurometro transport system, <http://www.swissmetro.com/>

⁷⁸ Kerr, A., *Dogs and Demons: Tales from the Dark Side of Modern Japan*. 2001: Hill and Wang, p. 234.

DARPA Grand Challenge 2004.”⁷⁹ Actually, no vehicle managed to go more than 11 kilometers without blundering off the road or mistaking a shadow for an object blocking the way and hence refusing to go any further. After 40 years of intense research into artificial intelligence and robotics, this was still the best we could do.

A year later, the 2005 Grand Challenge was a dramatic improvement.⁸⁰ The Stanford vehicle completed the course in 6 hours and 53 minutes. Four of the five other teams finished the course in less than 10 hours. Overall artificial intelligence may not have improved much in one year, but engineers solved specific problems to win this race.

Even if general-purpose intelligence does not emerge in the coming decades, it seems likely that we will learn to make robots that can recognize, grasp and carry objects, walk around on their own, understand simple voice commands, and perform housework. General-purpose intelligence would presumably let a robot learn to do these things on its own, instead of waiting for engineers to develop these capabilities one at a time.

Other forms of computer intelligence and robots have been successful. Computers can beat the world’s top chess champions. Small, autonomous robot airplanes have flown from Australia to the U.S., but no one is in a rush to buy a ticket to ride on one. Remote controlled aircraft are more common and reliable, and have been used successfully for military surveillance.

With or without general-purpose intelligence, major breakthroughs in robotics are inevitable and will one day be commercialized. Furthermore, we should bear in mind that it does not take much intelligence to navigate the real world and perform simple tasks. Animals such as bees, mice, bats and chickens can do this. However amazing and complex their brains may be, eventually we will learn enough about biology and computing to emulate them to make “birdbrain”-class computers. They are described in Chapter 10.

⁷⁹ The Defense Advanced Research Projects Agency (DARPA), <http://www.darpa.mil/>

⁸⁰ DARPA Grand Challenge, <http://www.darpa.mil/GRANDCHALLENGE/index.html>

7. Patterns of Transformation

Cold fusion will trigger unprecedented changes. I believe the only comparable breakthroughs were the prehistoric inventions of fire, language, or agriculture. The 19th century was the greatest era of change and innovation in recorded history. It brought forth steam engines, railroads, telegraphs, telephones, sanitation, anesthetics, electric lighting, motors, automobiles and much else. (In my opinion these had a more profound impact on people's lives than the inventions of the 20th century.) Because energy is fundamental to every aspect of technology, and all machines use energy, ultimately cold fusion will, by itself, trigger as much social change as the great inventions of the 19th century did.

Even though cold fusion will have a larger impact than previous technological revolutions, the history of those revolutions still has much to teach us. People react to change in predictable ways. Although no innovation in modern history has been opposed as ferociously by educated persons as cold fusion, previous breakthroughs and reforms did challenge society, they caused disruption and opposition, and they required tremendous investments of money and manpower. History offers useful clues about how the transformation from fossil fuel to cold fusion may occur. This chapter describes some of these patterns of transformation.

1. *The New Imitates the Old at First*

The first automobiles looked like horseless carriages. The first cold fusion automobiles will look like today's gasoline models. They will have the same body, tires, controls and electronics. Years ago, automobiles came in many different shapes and sizes, but thanks to safety regulations and aerodynamics, they all look about the same now.

The first cold fusion generators will also resemble today's combustion models. The designer will take out the coal-fired boiler, put in a cold fusion heat source, and leave other components unchanged. Engineers prefer tried-and-true designs; they only innovate when they have to.

Cold fusion space heaters will attach to the same hot air ducts or radiators that today's gas fired models do. They will be subject to the same safety laws. Electric generators will be connected to the fuse box where the power company line comes in.

New technology often starts out as a one-for-one replacement for the old. New materials are sometimes literally interwoven with the old, like the iron in 19th century wooden ships:

Early practice was to have an iron part similar to every wooden part . . . Many shipowners were prejudiced against iron, and so before it could be fully adopted there was an interim phase of the composite ship, in which iron framing and tie plates were used with wood planking and decking . . . ⁸¹

⁸¹ Baker, W., *The Lore of Ships*. 1963: Holt, Rinehart and Winston, "The Hull," p. 19.

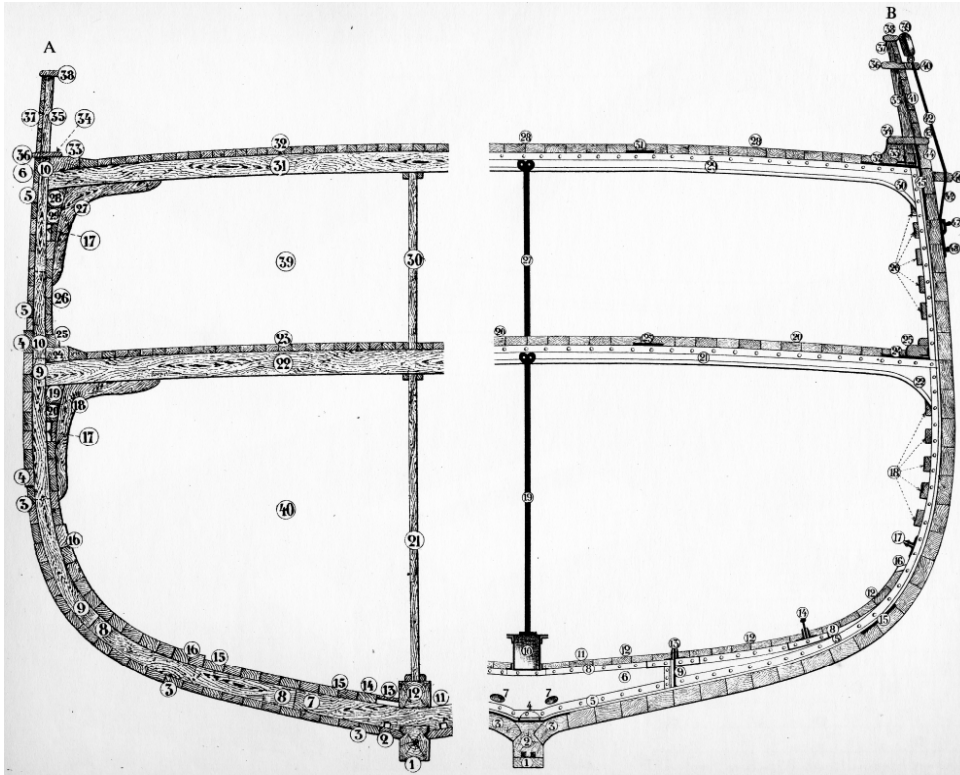

Figure 7.1. Cross section of a wooden hull (left), and a 19th century hull incorporating some iron parts (right). From Baker, W., *The Lore of Ships*. 1963: Holt, Rinehart and Winston, “The Hull,” p. 27.

New technology often imitates older forms, even when it would work better if it did not. Early Chinese clay pots were modeled to look like woven baskets, even though it was much easier to make smooth clay pots look like clay. The first plastic household objects and furniture were made to look like wood, wicker, and other traditional materials. Finally, in the 1960s plastic chairs began to look like plastic. In the 1970s I saw a demonstration of an early word processor. The screen was designed to make it look like a typewriter. New text appeared only on the bottom line of the screen; the cursor did not move around. To change a line you had to “roll” the text down, like an imaginary sheet of paper. With ingenuity and extra effort, the limitations of the old were imposed on the new. The salesman explained that this would make secretaries feel at home with the machine. Electric power plant control rooms have unnecessarily large controls built like old-fashioned J-handle (“pistol-grip”) switches to press small electric contacts. In older plants these controls had to be large because they were mechanically connected to the equipment they actuated. An official study concluded that this was one of the contributing factors to the Three Mile Island accident. “Valuable control space is wasted — and other controls are put out of the operators’ reach — by the failure to scale down control size.”⁸²

Early cold fusion devices will probably seem awkward and obsolete after a few years. Nothing ages faster than the first-generation models of new machines, such the personal computer shown in Fig. 7.3.

Early model machines are sometimes based on assumptions about how life works, ought to work, or used to work, but these assumptions make no sense in the context of the new machine.

⁸² Ford, D., *Three Mile Island*. 1982: Penguin Books, p. 115

Some of the first luxury automobiles had an enclosed compartment for the passengers in the back, but the front section where the chauffeur rode was protected only by a canvas cover, which exposed the chauffeur and the steering wheel and other controls to dust, cold and bad weather. I suppose this was done because traditionally a coachman rode outside, and designers apparently felt that was how things should be. Again, they took trouble to impose the limitations and problems of the old on the new. Luxury automobiles were soon made (as they are today) with a single enclosed compartment for both the chauffeur and the passengers, with a glass window between them.

Engineers devising brand-new technology often go to a lot of trouble to solve problems that do not need solving. An early railroad locomotive design featured large spikes on the driving wheels, with holes carefully spaced in the rails below. The designers thought that smooth steel wheels would spin on the tracks, instead of pushing the locomotive along, so they added the spikes to grapple with the rails. They did not realize that the tremendous weight of the locomotive would create enough friction to prevent spinning, usually. These designers were not completely wrong; the problem does occur, although their solution was impractical. Locomotive drive wheels sometime fail to gain traction, especially when the rails are coated with ice or wet leaves, or a swarm of locusts. Locomotives carry sand, which is dropped onto slippery rails to improve traction. Modern locomotives are equipped with complex control electronics and sensors that impart just the right amount of torque to each drive wheel axle to prevent spinning and ensure the most economical operation. After designers gain experience using a machine in the real world, they drop superfluous “features” that address nonexistent problems. Second generation machines tend to be more elegant and spare.

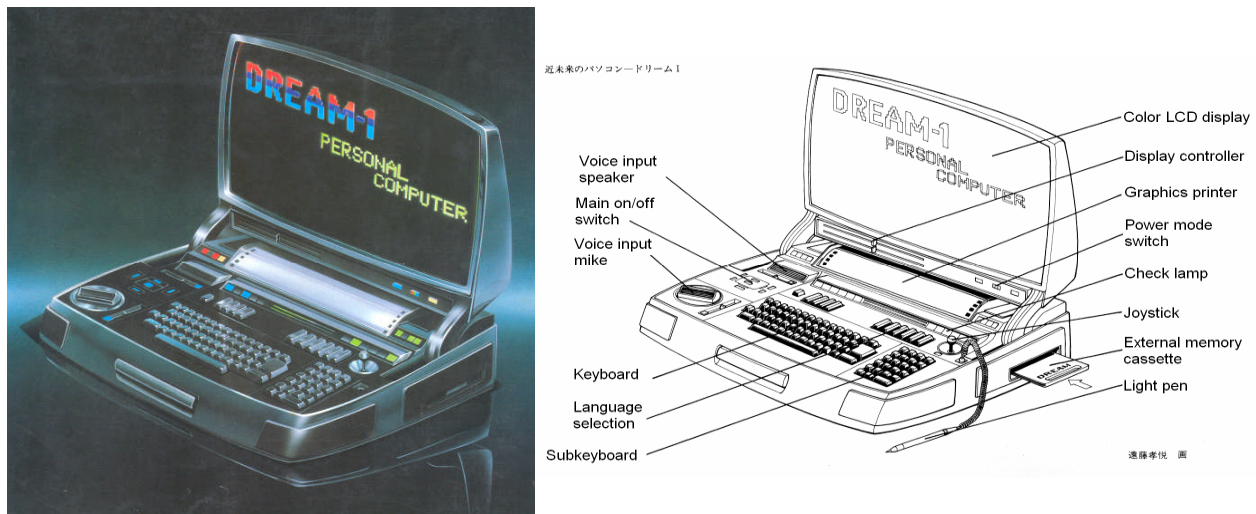

Figure 7.2. The Dream-1 imaginary computer from *Nikkei Saensu* (*Scientific American*, Japanese edition), special issue devoted to personal computers, June 1981; cover art and page 2 (translated).

Figure 7.2 shows a “Dream 1 model” “near future personal computer” as imagined by the editors of the Japanese edition of the *Scientific American* in 1981. They made a wish list of features, and came up with an omnibus portable computer that included a large set of obscure control keys, a giant rotating voice input mode microphone (left), a joystick, a light pen, an external memory cassette, and to top it off, a built-in graphics printer. Like the locomotive designer who put spikes on the driving wheel, they did not know what would work, what would be needed, or what method of input would prove popular, so they threw in everything. It did not

occur to them that people with portable computers might not use printers much, or if they did need to print something while on the road, they might use the hotel computer or drop into a copy shop and have a computer file printed. (This article was published long before hotels began offering computer services to guests.) The Dream 1 computer also has many extraneous and oversized controls, such as the two “Display control” slider switches under the screen (probably for brightness and contrast), and a “Power mode switch,” which probably selects between battery power and external alternating current. Screen controls can be much smaller, and the computer can decide for itself that it has been plugged into the wall, and it should stop using the internal battery.

Although the Japanese editors piled many useless features into their imaginary computer, in a roundtable discussion they left out a critical feature that was introduced a few years after this magazine was published. The editors and assembled experts decided that computers would never be able to display Japanese kanji characters, because the characters take up too much RAM and disk space, and they are too difficult and subtle to be handled by computers. By 1985, all Japanese computers displayed the full set of Japanese characters, and input was largely automatic. The computer translates Romanized keyboard input into the correct selection of characters. By 1995 all computers running Microsoft Windows could not only input and display Japanese, they could also handle Chinese (which has many more characters than modern Japanese), Arabic, Hebrew, Russian and dozens of other languages. In retrospect it is odd that the editors did not consider the ability to display their own writing system an essential feature, because every professional person in Japan today uses word processing. A few years after cold fusion becomes common, people will consider many of its features essential to daily life, including ones that did not exist previously. They will wonder how they ever managed to survive without it, just as we wonder how we managed without e-mail and the Internet.

Early model cold fusion equipment will probably have many inelegant solutions to new problems, and many extraneous features that are only needed with today’s dangerous and inconvenient gasoline and electric equipment.

2. Gould’s Punctuated Equilibrium

Sometimes, the solutions to ancient, long-gone problems linger on in modern technology. The typewriter QWERTY keyboard was invented to keep the typewriter keys from tangling together when people typed quickly. It has been obsolete for over a century, and other layouts would make typing faster and easier. Stephen J. Gould described QWERTY as “drastically suboptimal.”⁸³ He ascribed its survival to two basic evolutionary mechanisms: contingency and incumbency. Contingency is the chance outcome of “a long string of unpredictable antecedents.” Incumbency simply means getting there first. Being the first to occupy a niche, where there is no competition. Incumbency “reinforces the stability of a pathway once little quirks of early flexibility push a sequence into a firm channel.” Gould gives an example: “suboptimal politicians often prevail nearly forever once they gain office and grab the reins of privilege, patronage, and visibility.” This leads to the premise for Gould’s punctuated equilibrium theory: “Stasis is the norm for complex systems; change, when provoked at all, is usually rapid and episodic.” It seems likely that the changeover to cold fusion will follow this pattern: nothing will happen for a long time, and then the change will occur rapidly worldwide.

⁸³ Gould, S. *Bully for Brontosaurus*. 1991: W. W. Norton & Company, p. 69

The transition from gasoline cars to cold fusion cars will be a particularly clear example of punctuated equilibrium. It takes a long time to gear up to manufacture a new car (stasis is the norm). Cars are part of a much larger system of refineries, gas stations, roads, traffic signals and so on (a complex system). But once cold fusion models do go on sale, there will be great pressure on consumers to buy them (it will be a rapid and episodic event). After a quarter of the cars on the road are fusion powered, gas stations will begin going out of business in droves, because they operate on thin profit margins. In the oil price shocks of the 1970s, when consumption dropped a few percent, many gas stations went out of business. It will become more and more inconvenient to own a gasoline car. They will soon go out of production, and spare parts will become hard to find. Young mechanics will not know how to fix gasoline engines. In California, the antipollution laws will be amended to ban gasoline cars. Atlanta, New York and other large cities will follow. The holdout motorists will soon be forced to replace the rest of the automobile fleet prematurely, before it wears out. After ten years only a handful of people will want to buy gasoline. There will be roughly as many gas stations open for business in major cities as there are horses' stables today.

3. First A Toy, Then A Luxury, Then A Necessity

When a machine is first introduced, it is often a high-tech toy for hobbyists and people who enjoy playing with frivolous, novel, unstable and useless gadgets, such as the automobile in 1900 or the personal computer in 1977. The first personal computers were overpriced gadgets, without disks or even video monitors in some cases. The first automobiles were toys for wealthy young men with a talent for roadside repair.

Later, the machine becomes a luxury item. It is still inordinately expensive, but more reliable. It no longer requires an expert to operate. It has advantages over the older technology. By 1905, automobiles could be operated by untrained people. They were faster than horses, reasonably comfortable to ride in, and weather proof.

The machine is then improved, mass produced, and made safe and idiot-proof. It becomes a necessity to many people. The automobile entered this stage on August 12, 1908 when Ford introduced the Model T for \$850.⁸⁴ Personal computers gradually entered this stage in the late 1980s.

Finally, the cost of the machine falls dramatically, and it becomes so reliable that it replaces the older version. The U.S. horse population peaked in 1929 and declined rapidly after that.⁸⁵ Sometime around 1992, computers spread to every business. Manual bookkeeping with handwritten ledgers became a lost art. As a machine passes these stages, social attitudes toward it change in predictable ways. In the beginning people attack it as elitist or belittle it as impractical. (At the turn of the 20th century, people would taunt passing automobile drivers by yelling: "Get a horse!") Later, after people got used to owning cars themselves they could not imagine how they lived without them. Frederick Lewis Allen described the transformation. In 1906, Woodrow Wilson said, "Nothing has spread socialistic feeling in this country more than the automobile." He said it offered, "a picture of the arrogance of wealth." By 1925, a low-income woman in

⁸⁴ Microsoft Bookshelf CD, *The People's Chronology*, 1992: Henry Holt and Company.

⁸⁵ My only source for this is my mother's recollection of an undergraduate course in economics at Cornell University in 1939. The professor's main thesis, which he frequently repeated during the semester, was that the changeover from horses to automobiles had caused massive unemployment. He thought this was the main cause of the Great Depression.

Muncie, Indiana, told a social science researcher: “We’d rather do without clothes than give up the car.” Another said, “I’ll go without food before I’ll see us give up the car.” The interviewer asked a farmer’s wife asked why her family had a Model T Ford but no bathtub. She replied, “You can’t go to town in a bathtub!” Allen called this “a fitting theme song for the automobile revolution.”⁸⁶

Cold fusion resembles other fundamental breakthroughs such as railroads, automobiles and microprocessors, but the comparison should not be pushed too far. It would be a mistake for a venture capitalist to assume that the cold fusion revolution will resemble the computer boom. There are many practical differences between them that will make business strategies quite different, such as the fact that cold fusion will need extensive testing for safety, and cold fusion water heaters from different companies can look and function quite differently, whereas computers have no value unless they tightly adhere to one, or at most two, technical standards. (They must be PC or Mac compatible.)

There are historically unique aspects to cold fusion that set it apart from previous breakthroughs. It is so utterly novel, surprising and inexplicable, most scientists and engineers still refuse to believe it can exist. Most previous breakthroughs did not surprise the experts. Only the x-ray surprised everyone, expert and layman alike. Railroads, for example, were a straightforward extension of canals and mining trucks, which had used wooden rails since the 16th century.⁸⁷ Before the first railroad was constructed, canal builders already knew how to make a good railroad bed. A personal computer is essentially a 1979 minicomputer with a flashy but unreliable operating system grafted onto it. Programmers in 1979 were able to master personal computers in a few hours, and to this day personal computers have no functions or capabilities that would baffle a programmer from that era. He would be impressed by them mainly because they have so much memory, and so much intricate software, which is clearly the product of thousands of man-years of painstaking labor. But such intricacy is not unusual. The buildings of New York City, the farmland of Iowa, and the books arrayed in the Library of Congress also reflect immense complexity and the efforts of many people.

My guess is that these unique characteristics mean that corporations and institutions outside the mainstream will be the first to develop cold fusion. Today’s energy corporations will probably have little or no role. The novelty of the effect will create a kind of psychological barrier: large, established companies will find it difficult to come to grips with the scale of the change. They may not be able shift their methods of engineering and marketing quickly enough to meet the challenge. The established fossil fuel energy companies will have difficulty entering the market for cold fusion products for a simple and strictly practical reason: they have no relevant qualifications. Cold fusion energy will be built into the machinery itself. The fuel will be incorporated in the device just as it is in a dry cell battery. Companies that have experience building heat engines, furnaces and batteries will have the kinds of skills needed to make cold fusion cells. Fossil fuel companies that drill oil wells or mine coal will not.

Microprocessors are one of the most versatile devices ever invented. They are used in cash registers, automobile engines, elevators and spacecraft, and countless other machines. They are now so ubiquitous, we hardly notice when they show up in an electric toothbrush or a throwaway

⁸⁶ Allen, F., *The Big Change: America Transforms Itself: 1900-1950*. 1952: Harper & Brothers. Chapter 8, “The Automobile Revolution”

⁸⁷ Cardwell, D., *The Norton History of Technology*. 1995: W. W. Norton & Company, p. 65

musical Christmas card. Despite this, microprocessors have not created as many astounding new categories of machines as cold fusion will, and most of the functions they have taken over, such as controlling elevators, were previously done reasonably well with analog devices. Our houses, automobiles, kitchens and other work-a-day artifacts of daily life look much the same as they did in 1970. (Granted, offices look different, and you would hardly recognize the inside of a telephone central office or an observatory.) Cold fusion will probably have more direct impact on people's daily lives, especially in the Third World.

4. Lingerin^g Obsolete Technology

The COBOL programming language is obsolete, but it may linger another 20 years. It is an example of a technology with a long "tail."

Steam locomotives have been obsolete since the 1930s, but they are still used in China. They are low-tech, and easy to repair. But they burn three times more fuel than diesel or electric engines, they require far more maintenance for each hour they are on the road, and they emit a great deal of pollution. It would be better for everyone if they were replaced with electric trains, driven by coal or nuclear power, which is why the Chinese government recently purchased Japanese Shinkansen high-speed electric trains.

The basic steam locomotive engine layout was perfected by 1840, and it did not change much after that. The pistons were in front; the steam and smoke were forced through the smokestack. By 1910, designers might have developed a coal-fired steam turbine for locomotives similar to the marine engines then becoming popular. This would have been more efficient. But they went on to diesel engines instead. This is the distinguishing mark of obsolescent technology: it is not improved even when the underlying science improves. It is left behind. Apparently, in 1910, designers felt that a turbine locomotive was not worth the development cost.

Oceangoing sailing ships were obsolescent by 1850. They were built in large numbers until the 1870s. Many were still in use before the First World War, and there were still a few in the Atlantic trade in the 1930s. But by 1910 their overall contribution to the economy was small. The tonnage of freight they moved was probably negligible, and they did not carry passengers. A few still plied the Atlantic trade routes in the 1930s when my father was a sailor in the merchant marine. One day they passed a sailing ship mid-ocean, and the captain, in a nostalgic mood, hailed it and ordered the ship to circle around it slowly. In 1951, there were still two commercially operated full-rigged sailing ships in the world.⁸⁸

Steam locomotives, sailing ships and COBOL mainframe computers share a common characteristic that explains their longevity. They are expensive. They are long-term investments. You cannot throw one away just because something better comes along. They are "big iron" slow-changing technology.

Lingerin^g obsolete technology often sputters out abruptly when a crisis or sudden change in the market occurs. World War I was the final blow for sailing ships. They could not keep up with convoys. The U.S. and Britain frantically manufactured hundreds of cheap steamships, so there was a glut in the shipping market after the war. The economically marginal sailing ships no longer had a role. Many COBOL programs were replaced during the Year-2000 2-digit date crisis. Some were patched up with "windowing," meaning the programs will keep working for

⁸⁸ Tunis, E., *Oars, Sails and Steam*. 1952: The World Publishing Company.

another 10 or 20 years before a second overhaul will be needed. Eventually, the last remaining COBOL applications will sputter out when another crisis or drastic shift in computers occurs, such as a big improvement in massively parallel processors, or artificial intelligence.

The final crisis for the oil industry may be an oil tanker spill or an explosion. Once the industry enters a decline, companies will probably skimp on maintenance, and they will not buy new equipment, so an accident from dilapidated equipment will become more likely. After a serious accident, the public will demand the corporation cease activities, and all remaining applications for oil, such as plastics feedstock, will be replaced with on-site cold fusion powered machinery that converts carbon and hydrogen into hydrocarbons. The final crisis for the power company will probably be a hurricane that destroys a high-voltage power line. Large central gas-fired generators, hydroelectric dams, and wind turbines with decades of useful life left in them will be scrapped, because it will not be worth the money to repair the grid and reconnect them to customers, and because most customers will have their own generators anyway. The biggest problem will be dealing with abandoned uranium fission reactors left by bankrupt power companies.

At the household level, an automobile is major “big iron” expense. Even though the price of gasoline has gone above two dollars, families with SUVs cannot afford to replace them overnight. They must wait until the cars wear out, which takes five or 10 years. Durable household appliances such as water heaters and refrigerators usually last around 15 years. The space heaters and escalators in a shopping mall last for 30 years, and many of them will still be cranking long after cold fusion begins. The Shinkansen railroad trains last about 20 years, and it will take a long time to design new ones powered by cold fusion, so it may be that 40 years after the introduction of cold fusion a few of the old-fashioned externally powered electric Shinkansen trains will still be operating, and a few superannuated 1,000-megawatt power plants may still be needed to power them.

5. Why the Transformation Will Be Swift Once It Gets Underway

Some experts have predicted a transformation to cold fusion would take 50 years, like the spread of electrification, telephones, automobiles and computers. I believe that once commercial products become available, the transformation will be much faster. Cold fusion will not require a new infrastructure the way telephones and automobiles did, and it will be far cheaper than computers were for the first 30 years of their development. Most cold fusion powered devices will be consumer items such as hot water heaters, so the pace of change will be governed by decisions made by ordinary consumers. In other words, people shopping for things in stores will set the pace of change.

Imagine one morning you find your basement full of water from a broken hot water heater. You close the tap, mop up, and go to Sears to buy a new one. You select one quickly, then and there, because you need hot water. Your decision is not approved by a committee, and the money is not voted by an act of Congress. When an airplane or a blast furnace must be replaced, the decisions, planning, and approvals may take years.

You find three kinds for sale: electric, gas-fired, and cold fusion powered. They all cost about \$300. (As pointed out in Chapter 2, cold fusion does not require specialized materials or unusually difficult or precise manufacturing, so there is no reason why it should cost more.)

Which model will you choose? The gas or electric models will cost \$200 to \$400 per year to operate. The cold fusion model will cost nothing. All three will have the same warranty, and will be tested by government consumer safety agencies and certified by Underwriters Laboratory (an insurance company consortium — no store in the U.S. will sell products without a UL seal of approval). Perhaps at first, timid customers may hold back and hesitate to buy the new technology, but soon all customers will select cold fusion. The gas and electric models will gather dust, and they will be withdrawn from production. Selling a gas-fired water heater would be like trying to sell a wind-up Victrola record player to a customer who wants an iPod.

While you are making your selection, millions of other customers all over the world will also be choosing cold fusion models. In the past, in backward countries and rural districts, people purchased obsolete machines, but nowadays there is no lag. When you visit a small town in Pennsylvania, or a village in Japan, you should not be surprised to find a computer store and satellite dishes everywhere. As soon as the old models cease production, everyone will have to take cold fusion, whether they want it or not. The market can be a tyrant, forcing out unpopular choices and obscure brands. Major electronics stores are already phasing out VHS tape players. People will soon have millions of unplayable tapes cluttering up their shelves. A gourmet cook may want to go on using a gas-fired oven and stove. Cooking is an art, and cooks often prefer the tools they are used to. Unfortunately, the market will overrule this too, because the gas company will go bankrupt. For diehard cooks, jewelry-makers and sculptors who insist they need a gas flame to achieve just the right effect, there will probably be specialty suppliers of bottled gas, or cold fusion machines that split water into hydrogen and oxygen fuel (with a chemical added to make the flame visible). As Arthur Clarke says, mankind never completely stops using a tool. In Atlanta, you can still buy burlap sacks of coal for cooking and heating. But finding and using obsolete tools is a hassle.

The transformation to cold fusion will be swift because the pace will be set by individual consumers, not by government agencies or corporate executives. Corporate executives sometimes imagine they are the leaders and decision makers, but actually they are slaves to the whims of their customers. All power lies in the hands of consumers, especially with items as cheap and widely used as water heaters.

6. Core Technology

Cold fusion will enable many new machines and peripherals to be used with cold fusion itself, the way microprocessors enabled small hard disks, printers, thin LCD screens and other peripheral devices. Microprocessors were first used to build primitive hobbyist computers, which had no screens, keyboards, printers or hard disks, but only blinking red LEDs. Later, slightly more advanced computers had keyboards and scavenged television screens, and programs recorded on audiotape, which was about as reliable as writing in the sand on a windy day at the beach.

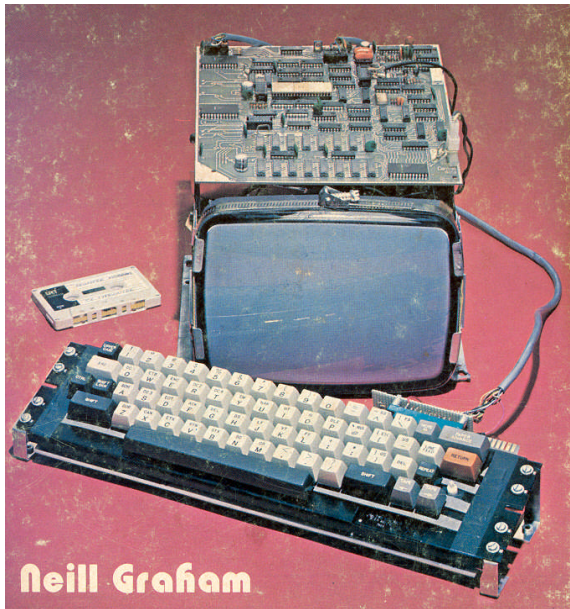

Figure 7.3. An early home computer. Note the audiotape on the left. The microprocessor is the white rectangular computer chip on right side of the computer board. From the cover of Graham, N., *Microprocessor Programming For Computer Hobbyists*, 1977: Tab Books.

An army of executives, engineers, and production line workers made incremental improvements to every aspect of computer technology, year after year. Gradually RAM and hard disks grew faster and larger, and new kinds of screens and printers emerged. Thousands of new companies were formed. The competition heated up. Product development cycles fell from five years down to six months. All this work took billions of dollars of capital and millions of talented people. But there was no single stroke of genius behind it. If one of these people had not made his contribution, someone else would have. The original, essential, or core contribution was the first one: the microprocessor. All else that makes up a personal computer would have been pointless without it.

The fact that microprocessors had to come first does not mean they were more difficult to make, or more important than hard disks or software. With many consumer products, cold fusion peripherals and components such as thermoelectric chips are likely to be as expensive — and profitable — as the cold fusion cell itself.

There was a market for printers and other computer peripherals before microcomputers were developed, but it was tiny. In the 1970s approximately 40,000 computers and printers were sold per year, whereas today 19,000 computers are sold every hour.⁸⁹ No one would have invested huge sums to develop a \$100 printer back when so few printers were sold. In the same way, the market for thermoelectric chips today is small, and there are many competing generator types, so there is little incentive to improve the chips.

⁸⁹ Sources for this estimate: Sanders, D., *Computers in Business, An Introduction*, 1968: McGraw-Hill, p. 512. “The number of computer installations is expected to increase from 90,000 in 1970 to 200,000 in 1975.” Assuming that all old computers were retired and all 200,000 in place by 1975 were sold between 1970 and 1975, the annual total sold was approximately 40,000. Actually, many computers in this era were kept longer than five years. Approximately 170,000,000 IBM PC type PCs and servers are now sold per year. This does not include mainframes and Apple computers. *Systems-world* http://www.systems-world.de/id/6556/CMEntries_ID/25586

7. Stages of Development

Fundamental breakthrough such as the automobile and the microprocessor trigger a cascade of new products in four stages. First come peripherals that the new machine itself requires. Second, improvements that everyone anticipates: the new product does a better job than the older one. Large computers were used for accounting, so everyone understood that the new personal computers would also be used for accounting, only it would be cheaper. In the third phase, the new machine goes beyond the limits of the old one, and it starts to displace other technology, often in ways that people did not anticipate. Computerized CD players replaced long playing analog record players. In 1970, few people (other than experts such as Claude Shannon) imagined that computers had anything to do with record players. Finally, in the last stage, the breakthrough creates new applications that were previously impossible or impractical.

For the microprocessor these stages were:

1. **PERIPHERALS.** Small hard disks and printers. The microprocessor itself was little more than a toy until these came along.
2. **IMPROVEMENTS.** Improved and expanded versions of existing data processing applications, such as accounting systems for small businesses that could not previously afford them, and had to keep the books by hand.
3. **DISPLACING OTHER TECHNOLOGY.** Microprocessors displaced mechanical fuel injection, record players, and other machines that had no connection with classic data processing applications. Individual small computers replaced the large, centralized mainframes.
4. **NEW APPLICATIONS.** Everything from video games to the Internet. Without microprocessors, the Internet would have served major universities, government research institutes and large corporations, but it could not have become a form of mass media, or a way to send a video-letter to Grandma.

For automobiles:

1. **PERIPHERALS.** Better tires, and the self-starter instead of the crank.
2. **IMPROVEMENTS.** Getting around town faster than with a horse and buggy. In the early stages, the automobile was a “horseless carriage”; that is, a replacement for the privately owned vehicle. It was not a form of mass transit, and it was not suitable for long-distance travel, because it was fragile, and outside of cities and large towns there were few paved roads or gas stations.
3. **DISPLACING OTHER TECHNOLOGY.** After a while, as automobiles became more reliable, they began to displace short-range mass transit such as streetcars and commuter railroads. This resembled the change from mainframe to personal computers: individually owned small machines replaced an organized network of large, central machines.
4. **NEW APPLICATIONS.** After improved roads and gas stations became common, automobiles brought about a new kind of do-it-yourself long distance travel, giving rise to motels. Then they brought us suburban housing developments, the interstate highway system, big-box centralized shopping malls, and many other mixed blessings.

For cold fusion:

1. **PERIPHERALS.** Better thermoelectric chips and other small, automatic, maintenance-free heat engines.
2. **IMPROVEMENTS.** Better versions of existing machines such as automobiles, pumps and generators.
3. **DISPLACING OTHER TECHNOLOGY.** Cold fusion will displace the electric power companies. Again, the individually owned small machine will replace an organized network of large machines, making us all energy-independent.
4. **NEW APPLICATIONS.** Many new applications that would be impossible with previous energy sources, such as implanted heart pumps, massive desalination projects, personal aircraft.

Breakthroughs also give rise to many whimsical, frivolous and fun applications –

Automobiles: drive-in movie theaters; road races; the car as status symbol and the object of fantasy and fetish (the sports car, the SUV).

Computers: on-line role-playing simulation games with thousands of people. Instant global communication via the Internet, and online discussion groups with participants from every country and every walk of life.

Cold fusion: giant hot-air zeppelins, like cruise ships that fly overland at 120 kilometers per hour. Las Vegas will be brighter, louder, gaudier. I expect the city fathers will a stately pleasure-dome decree: an air-conditioned carbon fiber geodesic dome covering the whole city, pulsating with multicolor video advertisements and megawatt loudspeakers blasting cacophonous popular music loud and long. The air conditioning in this cave of ice will be so cold it hurts your teeth, and the flashing, booming, 24-hour nonstop vulgarity will be on a scale that earlier generations could only dream of.

Finally, since people are people, new technology usually finds its way into erotica: the car is parked miles from home in a secluded spot; the Internet is used for pornography. The next generation of entrepreneurs will figure out how cold fusion will apply. Perhaps as a private means to reach orbital space and zero gravity?

Fundamental breakthroughs like the transistor are not inevitable, but once they are made, contingent, derivative or follow-up breakthroughs such as the integrated circuit are bound to follow. The discovery of cold fusion was not inevitable by any means, and cold fusion technology may never be developed because of technical difficulties and political opposition, but if it is developed, many contingent breakthroughs, such as home power generators and efficient thermoelectric chips, will surely follow.

8. Christensen's Model: Disruptive Versus Sustaining Technology

C. Christensen has written a brilliant analysis of what he calls “disruptive” versus “sustaining” technology.⁹⁰ Disruptive technology is a machine or technique that is inadequate in some ways, yet has great future potential. A disruptive technology starts out being too small, too slow, or too

⁹⁰ Christensen, C., *The Innovator's Dilemma*. 1997: Harvard Business School.

expensive for the mainstream user. It appeals to people with special needs in niche markets. It then improves more rapidly than the conventional technology, infiltrating the mainstream market from below. Finally it displaces the mainstream product.

Christensen contrasts the “disruptive” with the “sustaining” innovation. The sustaining innovation improves the state-of-the-art in ways that everyone can appreciate, making things faster, cheaper, more capable, and — what is most important from a business point of view — more appealing to existing customers. It is usually more sophisticated than the older version, and it takes more expertise to manufacture, and more expensive production lines. “Sustaining” does not mean “incremental.” A sustaining version may be quite different from previous models. It may be based on different physical principles, but it is functionally equivalent and it fills the same customer needs and market niche. Christensen describes the “radical” yet sustaining change from steam to gasoline powered cable-driven excavation equipment: “where steam shovels used steam pressure to power a set of steam engines to extend and retract the cables that actuated their buckets, gasoline shovels used a single engine and a very different system of gearing, clutches, drums and brakes . . .” Yet the established manufacturers of excavation equipment made the transition to gasoline motors, and the customers were quick to buy the new machines. Managers in established companies are trained to recognize and aggressively invest in sustaining technology, to keep up with the competition.

Established companies have difficulty dealing with disruptive technology, whereas they do well with sustaining innovations. Their skills may not be transferable to the disruptive technology. In the 1940s, when air transportation was beginning, railroad companies had few skills or organizational abilities applicable to airplanes, and they never tried to establish a presence in the airline business. By the time airplanes improved after World War II, passenger airlines were firmly established, and railroads could not have entered the business even if they had wanted to. Most early digital cameras were made by Japanese printer companies rather than established camera companies. Cold fusion devices will probably be made by companies that have little or nothing to do with today’s energy market.

When it starts out, disruptive technology is not usually as good as existing technology. It may be cheaper per unit, but it is less cost-effective, slower, less reliable, or less efficient. Established customers usually have no use for it. For example, the early digital cameras were more expensive than film cameras, and the image quality was poor. Disruptive technology is usually simpler. It is not necessarily innovative. It might be based on a new research breakthrough, or it might simply be repackaged older technology. To sell disruptive technology you must find new customers. The best place to look for them is in an emerging market. In 1981, Seagate introduced the 5.25-inch Winchester hard disk drive. Christensen compares it to the 8-inch drives that were the industry standard at the time:

	8 inch drives (minicomputer market)	5.25 inch drives (desktop computer market)
Capacity (MB)	60	10
Physical volume (cu. in.)	566	150
Weight (lbs.)	21	6
Access time (milliseconds)	30	160
Cost per megabyte	\$50	\$200
Unit cost	\$3000	\$2000

The smaller drives were less efficient, slower, and they cost more per megabyte. In 1981 the existing customers for hard disks were minicomputer manufacturers. They wanted more megabytes per dollar, more speed. They did not care how much disk drives weighed or how much space the drives took up. People in the emerging desktop computer market, on the other hand, wanted a low unit cost, compact, lightweight drive. They were willing to sacrifice speed and cost per megabyte for these advantages. If Seagate had pursued customers in the minicomputer market, it would have swiftly gone out of business. The 5.25-inch drives improved more rapidly than the 8-inch drives, because they were based on simpler technology. By 1987 the capacity of the 5.25-inch drives met the demand in the minicomputer market, although 8-inch drives were still faster and had higher capacity. Eight inch drives had gone beyond the needs of the market, and they had not improved or fallen in price as rapidly as the small drives, so they become obsolete. Companies that had served their customer needs faithfully and stuck with the old 8-inch technology went out of business. They were “held captive by their customers,” as Christensen puts it. Companies that entered the 5.25-inch market two years after Seagate also failed, because they could not compete with Seagate’s wealth of experience and its base of satisfied customers.

Cold fusion will probably be the best example of disruptive technology in history, especially in the early stages. The very first cold fusion powered machines are likely to be expensive and finicky. They will appeal to people who want cutting-edge, exciting new gadgets, and to people with critical niche applications, such as Antarctic researchers and NASA rocket scientists. Such applications bring in huge profits: NASA is willing to pay millions of dollars for small, plutonium powered radioisotope thermoelectric generators (RTG). Specialized companies making cold fusion devices will invade these niches, and quickly begin making large profits, which they will plow back into research and development, as they prepare larger, cheaper cells for mainstream applications.

Based on what we know about cold fusion performance, it seems likely that once we learn how to control the reaction, small machines will be developed quickly. Perhaps an unforeseen problem with safety will arise, or large energy companies will play politics in Congress and block the use of cold fusion by private individuals. But assuming this does not happen, you should be able to purchase a 20-kilowatt home generator many years before General Electric can develop a 400-megawatt generator suitable for a power company. Looking at the equipment cost only, ignoring fuel costs, your home generator will be more expensive per kilowatt of capacity than a fossil fuel 400-megawatt generator. Nothing will prevent General Electric from developing a gigantic cold fusion generator, but by the time they get around to doing it, so many people will have purchased small units, the price will have fallen (the way the price of 5.25-inch hard drives fell in the example above) and there will be no market left for centrally generated electricity.

Where established customers see a problem, new customers may see a feature. Hydraulic excavating machines (called “backhoes”) were introduced in the late 1940s. They were small and weak at first. They moved only 1/4 cubic yards of dirt with a narrow scoop. Cable excavators moved 1 to 4 cubic yards with each scoop, at a much lower cost per cubic yard. A workman would use a cable excavator to dig the foundations of a house, and then workers would dig a narrow trench with a pick and shovel from the house to the street, for the water and sewer lines. The cable excavator was too big to dig this narrow trench, but the hydraulic backhoe was ideal. Its small size was an advantage for this job. Hydraulic equipment improved, and by 1970 it could

be used for all jobs, large or small. The cable excavator companies went out of business. Christensen describes the situation from their point of view, starting in the 1950s:

Hydraulics was a technology that their customers didn't need—indeed, couldn't use. Each cable shovel manufacturer was one of at least twenty manufacturers doing everything they could to steal each other's customers: If they took their eyes off their customers' next-generation needs, existing business would have been put at risk. Moreover developing bigger better, and faster cable excavators to steal share from existing competitors constituted a much more obvious opportunity for profitable growth than did a venture into hydraulic backhoes, given how small the backhoe market was when it appeared in the 1950s. . . . [T]hese companies did not fail because the technology wasn't available. They did not fail because they lacked information about hydraulics or how to use it; indeed, the best of them used it as soon as it could help their customers. They did not fail because management was sleepy or arrogant. They failed because hydraulics didn't make sense—until it was too late.

Cold fusion has largely been developed by maverick scientists working within mainstream institutions, including mainstream energy industry research institutes. Amoco Production Company and the Electric Power Research Institute (EPRI) funded some of the most impressive cold fusion research, but they put the results aside and scaled back or cancelled programs, apparently because managers within these organizations are hostile toward cold fusion.^{91,92} If Christensen's hypothesis is correct, these managers are also puzzled by cold fusion. They cannot imagine what they would do with it. EPRI is a consortium of major U.S. power companies. The first cold fusion generators will be expensive novelties. They will probably produce a few thousand watts and they may cost \$50,000. They will be less cost-effective than conventional generator plants, and they will be built on a scale a million times smaller. A small cold fusion generator will be nothing like a gas or wind turbine, which works best when connected to a power grid. Even I cannot see why an electric power company would want to develop one, or what use it would have for one. Eventually, these expensive toys will evolve into cheap, reliable home generators that will put the power companies out of business.

A working cold fusion generator at any price, for any market, will be the kiss of death to the electric power industry, just as the first chattering, balky automobiles in 1895 spelled the inevitable, protracted demise of horse-drawn transport 34 years later, and the first microcomputers meant the end of most mainframe computers 10 years later. Cold fusion cannot help the energy industry. It can only strangle it. The rational response to cold fusion would be to prepare for the orderly liquidation of the electric power industry, the oil companies, and the rest of the energy sector. This would be unthinkable to managers at EPRI and Exxon. From their point of view, it is like suggesting that if Liechtenstein declares war on the U.S., the Pentagon should immediately begin negotiating surrender.

⁹¹ Hoffman, N., *A Dialogue on Chemically Induced Nuclear Effects. A Guide for the Perplexed about Cold Fusion*. 1995, La Grange Park, Ill: American Nuclear Society. (See the Foreword by Thomas Schneider of EPRI.)

⁹² Lauzenhiser, T. and D. Phelps, *Cold Fusion: Report on a Recent Amoco Experiment*. 1990: Amoco Production Company, Research Department.

Part III: Some Technologies That Will Be Changed

8. Desalination Megaproject

Clean water is the source of food, health, and sanitation. Access to clean water should be the birthright of every person on earth. Cold fusion heaters will allow poor people to boil drinking water, and this will save up to 2 million lives per year (see Chapter 4). But people need more than safe drinking water. To thrive and live a good life, they need water to bathe every day, operate flush toilets, and irrigate farmland. To bring this much water to humanity we need cold fusion powered desalination — the extraction of drinking water from the sea.

Suppose we decide to irrigate a third of the Sahara and Gobi deserts, leaving the rest of the land as a desert wildlife preserve. This would undo the damage caused by people over the centuries. We create as much farmland as there is in the U.S.: 3.9 million square kilometers.

Table 8.1. Major deserts compared to U.S. agricultural land

	Million square kilometers	Million square miles
Sahara	9.0	3.5
Gobi	3.4	1.3
U.S. agricultural land	3.9	1.5

Assume we use subsurface drip irrigation, which reduces water consumption by two-thirds. Prime U.S. agricultural land gets about 1,000 mm of rain per year (40 inches), so we need 400 mm of water. Assume there is almost no local rainfall, and we must supply the entire amount. We need 1,560 cubic kilometers of water. In Saudi Arabia (2002 data), 30 giant desalination plants produce about 1 billion cubic meters per year (1 cubic kilometer). The plants cost \$894 million each. They also produce electricity; they are cogenerators. The entire world produces roughly 5 to 10 cubic kilometers per year.⁹³ The world’s largest desalination plant is in Ashkelon, Israel, on the Mediterranean coast. It produces 100 million cubic meters per year (0.1 cubic kilometer), and it cost \$250 million. It supplies about one-sixth of Israel’s drinking water, or 5% of all water, including water used in industry and irrigation.

To irrigate the deserts we would need 312 times more desalination plants than now exist, or approximately 15,600 of the Ashkelon plants. This is not an extreme number. The plant takes up a land area of 300 meters × 250 meters (19 acres). The factories would cost \$3.9 trillion at the prices Israel pays today, but the price will fall dramatically, by a factor of 10 or more, because cold fusion will simplify the engineering, and lower the cost of construction, operation and maintenance. Cheap energy will drastically lower the cost of aluminum, steel, copper and other building materials. It will lower the cost of transporting building materials, and operating bulldozers and pipeline pumps. The desalination plants will also be cheaper because they will be standardized and mass-produced in unprecedented numbers.

⁹³ Information on the amount of water produced by desalination is murky. Most sources say Saudi Arabia produced 1 billion cubic meters in 2002, while other sources say it was 2 billion. Some claim Saudi Arabia has 20% of the world’s capacity; others say it is 30%. The Government of Saudi Arabia, Saudi Arabian Information Resource, <http://www.saudinf.com/main/y3668.htm> says: “Saudi Arabia, which accounts for 21 percent of world production of desalinated water, has 30 plants built at a total cost exceeding SR 70 billion [\$19 billion], including SR 15 billion [\$4 billion] for operation and maintenance. All run by SWCC, the stations produce over 3 million cubic meters per day of fresh water and 5,000 megawatts of electricity.” The Hydronet organization, <http://www.hydronet.org/article-print-55.html> claims the worldwide total is approximately 10 cubic kilometers. These are rough estimates.

Most modern desalination plants perform reverse osmosis (RO). The equipment is expensive but the process is energy efficient. With cold fusion it would be better to use an older method, Multi-Stage Flash (MSF), in which the water is boiled and the condensate is collected. This calls for 4 to 30 times more energy than RO, but — of course — the extra energy will not matter. We will trade-off efficiency for inexpensive, durable equipment. Water from MSF plants contains less left-over salt, 1 - 50 ppm compared to 10 - 500 ppm for RO.⁹⁴ The left-over salt from RO does not hurt the people who drink the water, but if we irrigate desert crops with it for decades, the salt may gradually build up and make the soil sterile.

If the irrigation megaproject were to cost as much as it would today, \$3.9 trillion, we would never do it. People will only spend that kind of money on war.⁹⁵ Even with cold fusion, it will probably cost hundreds of billions of dollars, and it will surely take decades. But it will begin to pay for itself soon after the first factory is built, crops begin to grow, and land values increase. Furthermore, even if it is expensive, we will have a lot more money than we do now. Cold fusion will save trillions of dollars that would otherwise be spent on oil, coal, and the electric power infrastructure, not to mention wars over the possession of oil. We will have surplus skilled laborers. The people who build oil refineries and high-voltage power lines will be unemployed, so we should give them the opportunity to build another kind of large scale infrastructure, with hundreds of factories, holding tanks, and thousands of kilometers of pipelines and irrigation networks. Cold fusion will save society money and resources. As individuals, we may pocket hundreds of dollars a month. We would be wise to devote some of those savings to larger social purposes, and to projects that serve future generations, especially people in the poorest parts of the world.

Actually, 15,600 desalination plants is probably an overestimate, because it assumes there is no rainfall in the deserts, and we will have to supply all of the water, indefinitely. As the project progresses, plants and trees will begin growing in formerly barren land. The climate will change and more rain will fall naturally, reducing the need for irrigation. It will take decades to build the first 7,000 plants, and by the time they are finished, rainfall should already be increasing, so the other 8,600 may no longer be needed.

With today's technology and materials, we can build desalination plants fired by coal, oil or gas. We have built enough plants to provide some of the drinking water to people in a few hundred of the world's thirstiest cities, such as Los Angeles. With uranium fission we could probably build enough to serve thousands of cities. But we could never produce enough water for irrigation. Not only would the plants cost trillions of dollars, they would rapidly deplete the remaining stocks of fossil fuel, producing nightmare levels of air pollution and greenhouse gases. Fission plants would produce a mountain of dangerous spent uranium fuel rods. Wind or solar power would cause negligible pollution, but they are not much cheaper than fossil fuel, and solar or wind power is thinly spread out over a large area, so the solar cells or wind turbines would take up a lot of space, and millions of tons of concrete and steel. Irrigation calls for an energy source thousands of times cheaper than these conventional choices.

⁹⁴ California Coastal Commission, *Seawater Desalination in California*, <http://www.coastal.ca.gov/desalrpt/dchap1.html>

⁹⁵ Wilson, J., *Iraq war could cost US over \$2 trillion, says Nobel prize-winning economist*, in *The Guardian*. 2006. <http://www.guardian.co.uk/Iraq/Story/0,2763,1681119,00.html>

1. Extraction Of Useful Elements From Seawater

The project may have an interesting side-benefit. In present day desalination plants, the salty water (brine) that is separated from the freshwater is dumped back into the ocean. In the future, it may be boiled down and then chemically treated to recover some of the valuable elements dissolved in seawater. This would be the brute force method. It would be better to filter the water and extract the elements using techniques developed to isolate rare nuclear isotopes. Either technique uses tremendous amounts of energy, but that would not matter with a cold fusion energy economy. There are more than 70 different elements dissolved in seawater in significant amounts. The most common valuable ones are sodium, chlorine, sulfur, magnesium, potassium, calcium, bromine and strontium. Ten cubic kilometers of seawater contains more than enough of them to supply all the world's industries. Bromine was first extracted from seawater commercially in 1924,⁹⁶ and during World War II magnesium was extracted on a large scale in the U.S. and the U.K.⁹⁷ Unfortunately, the concentration of palladium, gold and other precious metals is hundreds of millions of times lower than magnesium.

Suppose we improve the climate, increase natural rainfall, and we use more indoor farming, so that we need only 1,000 cubic kilometers of water (a trillion tons), instead of 1,560. There is so much magnesium and bromine dissolved in seawater, we would only extract a little of it, and flush the rest back into the ocean. Some other desirable elements are present at much lower concentration. After decades of building desalination plants, extraction techniques will improve until it becomes economical to selectively extract them. Table 8.2 shows some of the elements that might be extracted.

Table 8.2. Elements and compounds in 1,000 cubic kilometers of seawater

Element or compound	Present world consumption (metric tons)	Amount dissolved in seawater (metric tons)	Multiple of consumption
Salt (NaCl)	210,000,000	30,215,827,338	144
Magnesium (Mg)	3,360,000	1,280,000,000	381
Sulfur (S)	59,000,000	898,000,000	15
Potassium (K) *	23,000,000	399,000,000	17
Bromine (Br)	570,000	67,000,000	118
Iodine (I)	21,400	58,000	3
Molybdenum (Mo)	127,000	10,000	0
Vanadium (V)	60,000	2,000	0
Palladium (Pd)	171	0.06	0

* The USGS shows world production is 27,400,000 tons of potash, K₂O, which is 83% potassium by weight
Sources

Consumption: U.S. Geological Survey <http://minerals.usgs.gov/minerals>.

Elements in seawater: Y. Nozaki, *A Fresh Look at Element Distribution in the North Pacific*, Ocean Research Institute, University of Tokyo, http://www.agu.org/eos_elec/97025e-table.html

In 1,000 cubic kilometers of water there will also be 150 million tons of heavy water. We would need 6,200 tons of this to produce all of the energy we now consume.

⁹⁶ Clarke, A.C., *Profiles of the Future*. 1963: Harper & Row, chapter 12

⁹⁷ U.S. Geological Survey <http://minerals.usgs.gov/minerals/pubs/commodity/magnesium/mgcommcs04.pdf>

In the end, with improved agriculture and indoor farming we probably will not need an extra 3.9 million square kilometers of farmland. But we might create verdant land anyway, to give millions of people a nice place to live, and to restore the environment and reverse the destruction caused by earlier generations.

In Chapter 9 we will see how the desalination megaproject can help reverse the effects of global warming.

9. Global Warming

Cold fusion can eliminate global warming. I do not mean it might ameliorate the problem, or slow it down, or give us ways to cope with it. I mean that if cold fusion is used wisely and promptly, it can eliminate global warming as effectively as the Sabin vaccine eliminates polio. Cold fusion can also repair many other large-scale problems in ways that no other source of energy can do, because these other sources would either be prohibitively expensive, or they would cause more problems than they remedy.

Cold fusion can help reverse festering crises such as starvation, deforestation, insufficient drinking water and the population explosion. We can organize nation-wide and planetary scale projects and have cold fusion powered machines remove invasive species from woods, fields and oceans; clean up the mountains of trash alongside highways; and help get rid of dangerous solid waste. Of course we will have to invent new machines to apply cold fusion to agriculture, forestry, water purification plants and so on. The job will not do itself. Having the ability to do something does not always mean you actually do it.

Anytime after 1955, at a cost of a few dollars per taxpayer, the advanced nations might have joined together to completely eliminate polio from the world, the way smallpox was eliminated. Unfortunately, these nations delayed for 33 years while millions of people died, and many more were paralyzed for life.⁹⁸ If we are to solve these problems we need more than cold fusion; we will also need new laws. We must carefully plan, organize and finance these projects, with long-term commitments from national agencies and the world's largest banks. The projects will only succeed if they are launched in concert with enlightened government policies, clever product development by corporations, the provision of better health care, education, equality and other long overdue social reforms.

Suppose we use cold fusion powered tractors and farm equipment to reforest the mountains of Haiti, but we fail to give the Haitian populace cold fusion generators, heaters and water purification equipment to use in small scale, household applications to improve their standard of living. They will still be forced to cut the trees for firewood, and we will have accomplished nothing. Without social reform cold fusion might exacerbate starvation and other social scourges, and it is likely to increase unemployment.

Let us look more closely at how cold fusion can reverse global warming, which is a particularly intractable problem, and one which ultimately might cause the extinction of millions of species, including our own.

Although a few experts still question whether global warming exists, let us accept the consensus of opinion that it does. Signs of severe global warming have begun to appear. Glaciers all over the world are melting at an alarming rate. Most of the Pacific Ocean water temperature around Japan has risen one or two degrees Celsius, which has caused devastating typhoons. The weather in Japan used to be quite predictable, with monsoon rain for about a month in the early summer and typhoons and tropical storms beginning in September. Most years, two or three

⁹⁸ In 1988, 33 years after Sabin vaccine eliminated polio in first world countries, a concerted effort was finally launched to eliminate it worldwide. This was initially financed by the Rotary International Club and the Japanese government. In 2006 the number of reported cases dropped to 37,678. The disease is expected to be eradicated by 2008. <http://www.polioeradication.org/>

typhoons strike. In the spring and summer of 2004, long before the storm season normally begins, Japan was struck by seven of the worst typhoons in the history of modern meteorology.⁹⁹ Over the last 20 years, high tides in the Inland Sea have risen seven centimeters. The 2004 U.S. hurricane season was also one of the worst on record.

Most experts believe global warming is real, and it is caused by an excess of carbon dioxide in the atmosphere created by the burning of fossil fuels. There may be other contributing causes such as fluctuations in solar radiation. Whatever the cause, or combination of causes may be, cold fusion can fix the problem.

Assuming carbon dioxide is the problem, cold fusion will quickly stop it from getting worse, by eliminating the need to burn fossil fuel. This will prevent carbon dioxide and other damaging emissions. However, the carbon dioxide already in the atmosphere from the 20th century may still be a problem. We can sequester carbon by growing new forests of the Sahara and Gobi regions. (See Chapter 8.) Nature itself may gradually remove the carbon in other ways. Some experts believe ocean plant life may absorb it. If the new forests and natural mechanisms are not enough, we can tackle the problem with something like gigantic synthetic oil plants that pump hydrocarbon glop back underground, where we found it in the first place.

Alternatively, let us assume that global warming is caused by some other change in the environment (not necessarily carbon dioxide) or by some natural change in the weather or solar radiation. Controlling the sun and directly reducing solar radiation is, of course, completely beyond the sphere of man's control, but that does not mean we have to let all of the light reach the earth. If it were absolutely necessary, we might build a dozen space elevators, lift thousands of tons of material into space, and build orbiting Mylar parasols to reduce the amount of light that reaches the Earth. This sounds incredibly ambitious, but space elevators are expected to cost only \$6 billion each (only!), and a million square kilometers of Mylar would not weigh much, or cost much. It would weigh about 7 million tons and would fill roughly 50 container ships. Deploying it would be the hard part. Cold fusion would make the job easier and cheaper. (Space elevators are discussed in Chapter 18.)

It is hard to imagine any technology other than cold fusion that can attack and root out global warming directly. Or one which is so dramatically different from all previous energy sources that it will, by its very existence, inspire revolutionary thinking about where, why and how humans live on this planet and direct their lives. We cause global warming by burning approximately \$2 trillion worth of fossil fuel per year worldwide. We burn 1.8 million gallons of oil every minute. This is unimaginably large-scale activity; we are vaporizing mountains of coal and rivers of oil.¹⁰⁰ Only cold fusion can be launched on an equally large scale to counterbalance this deleterious activity.

Is a massive irrigation project to rejuvenate earth's desert areas really feasible, and would it sequester enough carbon to make a difference? As shown in Chapter 8, a project to irrigate a third of the Sahara and Gobi deserts would cost \$3.9 trillion with today's technology. That price is out of the question, but with cold fusion powered mass-produced desalination equipment, the project would be far cheaper. It should produce a large cash profit (not to mention the

⁹⁹ NHK National News, September 2004

¹⁰⁰ Energy Information Administration, International Petroleum Monthly reports that present world-wide consumption is 83,150,000 barrels of oil per day.

humanitarian benefits), starting perhaps five years after it begins, when the first factories are on-line, the pipelines are laid, and the land begins to produce crops.

Cold fusion desalination will probably not begin in the Sahara or Gobi. Although first-generation cold fusion desalination plants will be cheaper than today's fossil fuel and uranium fission models, they will still be expensive and they will still need a large staff of experts to operate them, so it would probably be best to build them in first-world cities such as Los Angeles where the payback is quick and assured. Subsurface drip irrigation will also be applied in the U.S. and in Israel. However, new trees in California or Israel will sequester as much carbon as trees in the Sahara, so this first-world development will help reverse global warming the same way the later desert reclamation projects will. As the desalination plants are standardized, the cost falls, and the equipment is made more automatic, it will be possible to construct gigantic plants that are run by a handful of people. We can then commence work on a megaproject of unprecedented scale, in remote unpopulated areas such as the Sahara, which as a consequence will soon become more populated and wealthier.

Growing forests sequester 1 to 10 tons of carbon per hectare, per year. After 30 years, when most trees reach maturity, the forest sequesters about 150 tons per hectare. Suppose that by irrigating and reforesting the deserts, Greek islands and Haiti we create 2 million square kilometers of new forest, and another 2 million square kilometers of fields and farm. The new forests would sequester 30 billion tons of carbon. Human activity presently adds about 6.5 billion tons of carbon to the atmosphere per year, so these forests would reverse the effects of 4½ years of present-day activity. By the time the forests reach maturity, cold fusion will have eliminated almost all additional man-made carbon emissions, so we will only need to clean up the old carbon dioxide from 19th and 20th century fossil fuel. We could continue removing carbon indefinitely by cutting the timber as it matures. We might use the timber for construction and paper as we now do, and then bury the old newspapers and old, torn-down timber framed houses deep underground, in anaerobic landfills. Abandoned strip mines would be good for this purpose. This would also prevent forest fires, which send the sequestered carbon straight back into the atmosphere.

If harvesting timber alone is not enough, or if we decide to devote most of the new forest to parks and suburban housing instead of timber, we could still permanently remove the carbon as the old trees die off. Cold fusion powered autonomous robots might gather up fallen trees and deadwood from both the new forests of the Sahara and old, established forests in North America and Europe, and bury the wood in deep landfills. These robots would not be giant logging machines that damage the forest and disrupt suburban households. They would be no larger than people, and possibly no larger than woodpeckers or insects. It might be a good idea to bake the wood to remove water and plant nutrients, leaving only charcoal (pure carbon). The charcoal would be compressed to save space in the landfills. In other words, we would make artificial coal mines, putting solid carbon back underground. Perhaps it would be cheaper and easier to bury the deadwood as is, along with other organic carbon such as garbage, agricultural leftovers, sawdust and old newspapers.

The idea would be to permanently dispose of the carbon based products in deep landfills where they do not naturally decompose and recycle. Decomposition usually ends up returning the carbon to the atmosphere. These landfills would gradually accumulate a huge pile of old newspapers, scrapped timber, and other junk. In recent years, people have decried the increase in solid waste, but the fact is, there is plenty of space on the Earth, and a few very large, deep holes

could hold nearly all of the trash we produce. We dig gigantic holes anyway, to extract iron, coal, and other raw materials to make products in the first place. We might as well put the used products back in the holes when we are finished with them. Future archaeologists will be thrilled to find these landfills. Future manufacturers will be pleased to find such concentrated sources of raw materials. We throw things away now because recycling is expensive. Cold fusion plus robots will eventually make it far cheaper.

If this scheme fails to remove enough carbon dioxide quickly, and serious global warming ensues, as noted above, cold fusion might be used to set up tens of thousands of gigantic chemical plants that separate carbon dioxide into carbon and oxygen, and then combine the carbon with the hydrogen from water. In other words, these plants would synthesize oil. The oil would then be permanently sequestered. It would be pumped deep underground someplace where the environmental effect would be nil, and where the geology readily holds huge amounts of hydrocarbons, such as Saudi Arabia. These industrial plants would produce synthetic oil by reversing the effects of combustion. That means they would need as much energy as the combustion originally produced, plus overhead. To remove all of the carbon mankind has added to the atmosphere, we must expend all the energy ever generated by burning coal and oil, from the beginning of the Industrial Revolution to the present. Cold fusion can easily supply this much energy, but thousands of industrial plants will be required to scavenge the carbon out of the atmosphere, and they might cost trillions of dollars. Unlike the desalination plants that create forest, farmland, and pleasant places for people to live, these carbon-fixing reverse oil wells would not pay for themselves. Aside from preventing global warming, it is hard to imagine what else they might be good for. They will produce billions of tons of oil that will have no more value than any other industrial waste, such as the slag from a blast furnace, or the brine left over at a desalination plant. We may use a tiny fraction of it for plastic feedstock or lubricating oil, but the rest will be pumped underground and thrown away. Perhaps it will be transported to the moon or other planets, if the people there find a use for it. More likely they will want solid carbon, to build space elevators.

It may seem unlikely that the human race would be willing to devote so much money to fix global warming, but I think it would.

- If global warming turns out to be as serious as some scientists fear, not fixing it would cost infinitely more, as New York City, Florida, and Venice sink under the sea.
- There will be plenty of money left over after we stop paying trillions of dollars for fossil fuel, and for the pollution, disease, wars and terrorism it causes.
- Cold fusion will make this and all megaprojects cheaper.

Mankind is already engaged in megaprojects and risky global experiments. We are injecting massive quantities of carbon dioxide into the atmosphere, and paving over 525,000 hectares per year of land in North America, mainly — it seems — to build shopping mall parking lots. We do these things for frivolous or trivial reasons, or for no reason at all. We waste about a third of the energy we use. If we were to manufacture more efficient automobiles and better houses, and use more compact fluorescent light bulbs, we would be more comfortable, healthier and safer.

In wartime, nations have rallied and done prodigious tasks in a few short years. The Second World War was a reverse megaproject: it killed 50 million people and laid waste to the work of generations, destroying tens of thousands of cities, towns and villages.

In the end, the irrigation megaproject is likely to pay for itself with increased food production and higher land values. Indeed, in the long view of history, it will probably be a fantastically profitable enterprise, like the transcontinental railroad. It will reverse global warming as a bonus. But even if reversing global warming ends up costing twice as much as World War II, it would be immeasurably cheaper than allowing cities, states and nations to be flooded.

No one should think mankind could not achieve such fantastic, ambitious goals as the megaprojects I have described here, such irrigating the desert or spreading thousands of square kilometers of Mylar in space. In the 1950s, the first serious thoughts about interstellar flight were published in journals and in the popular press. Some experts dismissed the entire notion as forever beyond human capabilities. Arthur C. Clarke wrote in 1963:¹⁰¹

Some people never learn; those who sixty years ago scoffed at the possibility of flight, and ten (even five!) years ago [in 1958] laughed at the idea of travel to the planets, are now quite sure that the stars will always be beyond our reach. And again they are wrong, for they have failed to grasp the great lesson of our age — that if something is possible in theory, and no fundamental scientific laws oppose its realization, then sooner or later it will be achieved.

Cold fusion researchers are broad minded, imaginative people, but even they sometime fail to grasp the dramatic and unprecedented power cold fusion will give us. Cold fusion researcher Edmund Storms once commented:

. . . better energy sources would increase mankind's ability to survive the consequence of global warming, whatever its cause. It will take large amounts of energy to move the cities from the coasts (or isolate them with dikes and pumping), to water land that has become too dry for normal farming, and to create local environments that would allow comfortable living.

In my opinion, Storms was not thinking on a large enough scale. We should not be preparing to accommodate global warming, or other global-scale crises such as invasive species, deforestation, or overpopulation. We should not trust that stopgap solutions or half measures will let us muddle through. We must not plan to save a few million rich people in comfort while we abandon billions of poor people to the rising waters. That would be genocide. We must think big. Much Bigger than ever before. Cold fusion will give us more power and material wealth that we have every dreamed of. We can use that power and wealth wisely to root out the problems, clean up the mess, and put things back the way they were before the warming began. Any other course of action would be suicidal.

¹⁰¹ Clarke, A.C., *Profiles of the Future*. 1963: Harper & Row.

10. Robot Chickens and Other Prodigies

NASA hopes to use artificial intelligence to create small, insect-like robots, or “robosects”

As a scenario for futuristic missions - multiple Robosects can be designed to search for evidence of former/existing life, resources, rare minerals and the presence of water, determine magnetic and other forces, reach crevices, construct miniature fixtures, examine the geophysics, carry relays for remote communication as well as perform unique experiments. Sensing options such as smelling and tasting, using chemical sensors equivalent biological ones, can be considered. Robosects can be equipped with various practical locomotion techniques, such as hopping and flying to traverse large distances, crawling to reach specific locations, as well as digging tunnels for underground operations.¹⁰²

In Chapter 6, I predicted this kind of practical artificial intelligence will come when we learn how animal brains work, and we find ways to mimic them, with “birdbrain-class” computers. Let us look more closely at such computers, and ponder their synergy with cold fusion. The two go together beautifully.

1. Robot Chickens

Unlike our best million-dollar robots, a chicken has no difficulty distinguishing between shadows and objects. Chickens have an incredible ability to navigate three-dimensional space at high speed with pinpoint accuracy. As you would expect from creatures that fly, they have sharp vision, and their reflexes are faster than a human’s. Ask anyone who keeps chickens and has had to shoo one out of the house. A chicken nesting on the living room sofa can slip past you, dash under the table, fly up, bank sharply through the kitchen door, land on the counter, instantly recognize your lunch, and eat the tastiest morsels in less time than it takes to tell. No supercomputer can rival this performance. I doubt any computer in the next 50 years will pass the Turing test, but it seems likely they will at least compete with mice and chicken brains in simple tasks such as recognizing objects, and moving around in three-dimensional space. These abilities will give them enormous new capabilities.

The key to artificial intelligence lies with the massively parallel processor (MPP) computer. A conventional desktop computer has only one processor (CPU); an MPP has thousands. Each individual MPP processor may be smaller, slower and simpler than a standard desktop computer CPU, but when all the processing units of an MPP work together on a problem they are much faster, especially at tasks such as pattern recognition. A living brain resembles an MPP computer; all of the cells work simultaneously and independently. Parallel processing has been the standard architecture for supercomputers for many years, and it is finally reaching small computers with the introduction of “multi-core” (multiple processor) personal computers. Multi-core desktop computers were common by 2005, each with 2 to 4 “cores.” Progress leaped ahead in 2007 when Intel announced a prototype processor with 80 cores. It can compute more than a trillion floating point operations per second (Teraflops), the speed of the world’s fastest

¹⁰² Bar-Cohen, Y., *Electroactive Polymers As Artificial Muscles - Capabilities, Potentials And Challenges*, Robotics 2000 and Space 2000 conference, Albuquerque, NM, USA, February 28 - March 2, 2000, <http://ndea.jpl.nasa.gov/ndea-pub/EAP/EAP-robotics-2000.pdf>. Don’t you just love it when NASA talks like this?

supercomputer in 1996.¹⁰³ The 1996 supercomputer filled a 232 square meter building, and it consumed 500,000 watts. The 80-core Intel prototype is 1 square centimeter and it consumes 60 watts. It is expected to be commercialized in about five years.

In twenty years we may see MPP microcomputers with thousands of processors on a single chip. They may operate 1,000 times faster than today's desktop computers generally, and perhaps 100,000 times faster at tasks such as vision and pattern recognition. (Today's computers are roughly 5,000 times faster than those of 1980.) Imagine a handheld model that weighs 100 grams. It can convincingly emulate a subset of a chicken's mental capabilities: it can navigate through three-dimensional space, recognize objects, and it knows that a person or an insect is a single, living body with a will and predictable patterns of behavior.

Chickens have no sense of responsibility. They do as they please. When you build a computer to emulate a chicken's brain, you would leave that part out. You take away the will, and cancel all motivations and desires. You make the computer follow orders, something a real chicken is seldom inclined to do. You take away the *joie de vivre*, leaving only dry intelligence. You put this computer into a small robot, and give it about as much physical strength as a child has, and then you order it to clear the table and put the dishes into the dishwasher. Just as the chicken has no trouble recognizing plates on a table, the robot sees the plates, and it knows how to pick them up, carry them into the kitchen at a leisurely pace, and deposit them in the washing machine, without crashing into the walls or mistaking the trash can for the washing machine. Compared to normal chicken behavior, these tasks are easy.

This robot brain would have only a few chicken-like skills that we need for the job at hand. If it is as smart as a real chicken, it will recognize and remember dozens of different people, recalling how they act, but unlike a chicken it will not play favorites, or become upset when you forget to bring it a treat. A real chicken is good at pecking order politics, defending territory, and wooing members of the opposite sex. Indeed, it spends most of its time engaged in these social activities. Our robot will not need these skills.

In addition to its chicken reflexes and vision, the robot will have a master control computer similar to today's conventional one-track-mind logical machines. The control computer will remember instructions, schedule tasks, store digital photographs and operate the internal GPS unit. It will understand traffic laws, so it will instruct the robot to walk on the sidewalk, not the street, and wait until the traffic light turns green before crossing the road. A chicken can easily recognize a traffic light or the color green, but it does not understand what the light signifies. The conventional internal computer will keep track of rules about traffic lights, but it will not recognize an actual traffic light in the real world.

¹⁰³ Intel Corporation, "Teraflops Research Chip, Advancing Multi-Core Technology into the Tera-scale Era" <http://www.intel.com/research/platform/terascale/teraflops.htm?iid=newstab+supercomputing>



Figure 10.1. A girl and her pet chicken. This chicken recognized the little girl and other members of the family. Chickens understand people’s basic emotions and intentions, such as when you are upset and determined to shoo the chicken out of the house.

A slow moving, robot-around-the-house that clears dishes and folds laundry might be battery-powered. It may have to recharge several times a day, but it could do this quickly by swapping out a battery pack. Cold fusion might not enhance this housebound robot much, but it would synergistically enhance other robots, especially independent and mobile ones, such as those sent into remote forests, hostile environments like the Antarctic, under the ocean, or to distant planets. Cold fusion would give these robots capabilities far beyond anything that could be accomplished with conventional energy.

Imagine we make a robot the same size as an actual chicken, powered by cold fusion. We give it a chicken-like job: finding and killing a particular kind of insect. We take the robot to a national park infested with invasive Asian longhorned beetles that are destroying trees.¹⁰⁴ We tell the robot to patrol a section of the park, search out these beetles, and kill them. It stays on the job day after day. Chickens are incredibly good at spotting, capturing and eating insects, even small and quick ones. They can tell species apart; they know which are tasty, which are bitter, and which ones sting. Our robot will not accidentally kill the wrong insects, or attack a person. Like a real chicken, it has wings and can fly up into trees easily, and it has a claw to root around in the leaves and dust. It methodically patrols the assigned area, covering every spot at least once a day. It tirelessly climbs trees looking for insects in every nook and cranny. It keeps track of its location with a chicken’s normal ability to recognize places, plus a built-in GPS receiver. It

¹⁰⁴ USDA Forest Service, Asian Longhorned Beetle, <http://www.na.fs.fed.us/spfo/alb/>

might be engineered to hunt at night, if the target species is nocturnal. Since it would have power to spare, it could include a night vision camera and an LED lamp. It would also employ conventional eradication techniques such as attracting the beetles with pheromones.

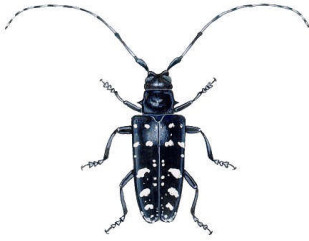

Figure 10.2. Female Asian longhorned beetle, from the USDA web site

The robot logs its kills, near misses, and other observations with a date and time stamp and GPS location. It periodically sends a progress report back to headquarters via a built in cell phone. The growing database from the robots is a treasure trove of information for the naturalists in charge of the eradication program. The project engineers periodically broadcast new software or new orders to flocks of robots, improving their performance. For instance, they might instruct the robots to look carefully for the beetles in some tree species during late summer, or after rain.

If the robot needs routine maintenance or part of it breaks, it makes its way back to the factory for repair, and then returns to its assigned area. Chickens can travel quickly, and find their way home from miles away. A GPS robot chicken will travel to any spot in North America in a few weeks, or anywhere in the world in a few months. This is not a mechanical challenge. The robot legs and wings will be driven by artificial muscles (electroactive polymers), which last as long as natural muscles. Some birds migrate annually from South America to North America, and ocean birds survive storms and voyages thousands of kilometers long.

Assume these chickens eventually become dirt cheap to mass-produce. You dispatch 10,000 of them to a National Park to eradicate the invasive beetles. You let loose a million of them in North America. They search over broad areas in an organized campaign. When one finds an infestation, it calls in others to assist. A few years later the beetles are all gone. You then recall the robots, or send them instructions for another assignment.

Robot Chicken Specifications

1 or 2 kilograms. Roughly the same mass as a real chicken, but the shape can be completely different, as needed. Resembles a large insect.

4 to 6 legs.

Driven by artificial muscles (electroactive polymers - EAP), not by mechanical motors and gears. The duty cycle and strength of EAP has already reached commercially practical levels.

The robot is an ornithopter, or flapping wing aircraft, with stiff, foldable wings. It resembles a beetle rather than a bird. A propeller would be dangerous and noisy. It might hurt a person.

Binocular vision. Night vision and low level lighting for night operation.

Cell phone, GPS, network with other robot chickens.

Sends back photos of victims. Some models collect and return victims.

Observes, photographs and videos other species as well. Data is a treasure-trove for naturalists. Can be used to establish a realistic population count for many species for the first time.

Method of killing: probably plastic pliers. Nothing that might hurt a human, or pollute the environment. No poison or sharp objects.

Pheromone dispenser to attract victims.

Made of rugged plastic, with a soft rubber outer shell. No sharp edges or protruding objects. Light enough so that if the robot collides with a vehicle or person, or falls out of a tree and hits a child, no serious injury is likely.

Quiet and unobtrusive. No noise or disruption to the natural environment. Models that cut invasive vines or collect deadwood work slowly, taking hours to cut a single vine, working more quietly than woodpeckers.

Visible but not garish. Has “USDA” and printed instructions on side.

Understands and obeys a limited number of voice commands: “stop, go away, who/what are you, help, report.”

Has a prominent red “emergency” contact button for the search and rescue function. When you press it, the robot immediately contacts police via cell phone, and transmits image of you and your voice. If the robot cannot make contact, after telling the person who pressed the button what it plans to do, the robot flies up high in the air, and tries to make contact again.

Announces presence when invading a picnic: “Hello. I am a USDA pest control robot. If you would like me to leave this area, please say: ‘Go’. If you require assistance, please say ‘Help.’ If you would like me to tell you about the USDA/Cornell pest control program, say: ‘Report’ . . .”

Appearance does not frighten or intimidate. Looks cute. Does not bother people; goes away when requested.

If someone picks up the robot and tries to take it home, it does not fight or resist, but instead says: “Please do not disturb this robot. This robot is now photographing you and contacting Park Rangers and the local police via cell phone. If this is an emergency, please press the red ‘emergency’ button located on top this robot . . .” (Emergency button flashes red.)



Figure 10.3. Robot chickens in a park, climbing an infested tree, flying. Illustrations by A. Rothwell.

Robots vacuum cleaners have already been marketed. They do a few of the things the robot chickens will do. They know how to go back and forth until they cover every spot in a room, the way the chickens will police everywhere the beetles might be hiding. Prototypes of another machine even more similar to the robot chicken are being developed. A small, slow-moving robot has been designed to patrol a field of crops, capturing slugs.¹⁰⁵ In a future version, the designers hope to have the robot dunk the slugs into a plastic vat of liquid that kills the slug and ferments it to produce biogas, to power the robot. In other words, the robots will digest their prey and use the energy to find more prey. Actual live chickens do the same thing: they eat insects and use the energy to find more insects. The prototype slug-eating predator robots are slow and they use little power. They could not capture anything that moves faster than a slug. (Slugs are

¹⁰⁵ Kelly, I., et al., *Artificial Autonomy in the Natural World: Building a Robot Predator*, <http://www.coro.caltech.edu/People/ian/publications/ecal99.pdf>

not only slow moving; they are also easy to identify, because they stand out with red LED illumination.) As these robots improve they will gradually become capable of capturing livelier pests. They will evolve into the robot chickens described here. The reader may wonder, in that case, why is cold fusion needed? Why not power robot chickens with chemical energy from the pests they destroy, or for that matter, with conventional batteries or fuel cells? The answer is that while robot chickens could be developed with these conventional energy sources, and they would gradually become useful and cost effective, cold fusion would jumpstart the development, and it would improve the product tremendously. It would give them a huge extra margin of power, which translates into extra capabilities, reliability, and an easier, more forgiving design.

Batteries would make the robot chickens heavy and bulky. They could never fly, only crawl or walk. They would have difficulty crossing busy roads to reach to their assigned location. Even though they would be waterproof, they could not cross a swiftly moving stream, or climb a steep embankment. They would not be able to search for insects high in trees, or on rock outcroppings, or other difficult to reach locations. Fuel cells would also be heavy, and although they store more energy than batteries, they would still have a limited range. Machines that depend on the chemical energy of their victims, like the slug-hunting robots or live chickens, would often “starve to death.” That is to say, they would run out of energy and be stranded in the middle of the woods. With any of these conventional energy sources they would have to husband their energy carefully. They would have to be designed with incredibly good efficiency and effective insect hunting capabilities starting with the first-generation product. They could not operate cell phones, built in GPS systems, or sophisticated, heavy computers. They could not fly hundreds of miles from the factory to their assigned location. Cold fusion would give designers latitude. To be sure, the machines will still have to be reasonably energy efficient; we would not want them to radiate hundreds of watts of waste heat. That would be dangerous. But the designers can have 10 or 20 watts of power to work with, which is much more power than a real chicken has.

The designers will probably not know how make these robots work well, at first. The early models will not capture many insects. But with cold fusion they will not “starve,” and they will stay on station, working at top speed for weeks or months. They will make the best of their limited abilities, and all the while they will communicate back to the design engineers and naturalists detailed data about their performance, which will be used to improve the next generation of machines.

An actual chicken brain is amazingly small and low-powered. It weighs about a gram. Man-made birdbrain-class control computers may eventually rival this, but the first models will surely weigh a hundred grams or more, and take several watts of power. Cold fusion will give the design engineers the opportunity to use these crude, inefficient early models in many products that would otherwise have to wait for years.

A fuel-cell version of these robots might be able to store a few low-resolution photos of the insects they had killed, along with rudimentary data about the location the insect was found. This would be stored in a memory card, like the one used in an electronic camera. The data would be gathered every week when the robot returns to base and is refueled. (A battery-powered version would have to return to base every few hours.) A cold fusion powered model will have power to spare, so it can pack an entire portable computer-style hard disk onboard. It will record high-resolution pictures, movies, mass spectrometer readings, the GPS location, the temperature, ambient light, local weather conditions, and any other information the engineers and naturalists might find useful. It will communicate this data back to headquarters at night, or hourly if the

need arises. When the robot cannot reach headquarters because it is deep in a valley, or far from a cell phone tower, it will record its location with the GPS unit, and then fly high up in the air, establish contact, transmit the information, download the latest software changes, and return to the spot on the ground where it left off.

Today's energy sources hamstring the design engineer, often confronting him with difficult choices and frustrating performance trade-offs. The researchers developing the slug-eating robot described the complex trade-offs and limitations they struggle with:

. . . animals and our robots, which are in the same free-living situation, will have several simultaneous goals. Slugs must be gathered; batteries must be recharged; it must not get lost; it must always have enough charge to be able to return to the refuelling point; it must maintain the functionality of its sensors and effectors; and so on. How can we approach the task of programming the robots in our system so that they always act to maximise expected survival time? Our strategy, as designers, must be to find a computationally feasible solution which gives adequate performance. We know that because of the inefficiency of the digestive process, our system will at best be on the borderline of survivability, and so our performance requirements may be even more severe than those which an animal living exclusively on slugs would experience.

Unfortunately, we lack the detailed information which might allow us to arrive immediately at a specific and optimal solution . . .

The engineering would be far easier if the researchers did not have to worry about batteries, refueling, and survival time. Cold fusion would give the pseudo-animal a million times more energy than a real animal, putting it light years away from the "borderline of survivability." The engineers working on this project are searching for an elegant, carefully balanced solution. Cold fusion will give them a brute force solution that shoves aside most of the design considerations they are worried about. It will do the same for most other machines, even those where engineers are so used to the trade-offs they do not notice them.

A robot chicken will make an excellent night watchman or guard. Imagine a mobile burglar alarm or robot watchdog that scurries from room to room, 24 hours a day, checking everywhere, watching everything, looking for movement, or anything out of the ordinary. Chickens have no trouble recognizing that a stranger has come to your house, and a chicken is good at raising a ruckus and evading people it fears. In Europe, geese are used as watchdogs. A burglar might smash an ordinary immobile burglar alarm. He might even shoot a watchdog, which is a large target. But I doubt many burglars could capture a chicken or hit one with a pistol. In any case, the watchman-robot will quickly dispatch a warning to the police via its built-in camera cell phone, and in the meanwhile it will be programmed to flee and hide or fly up to the rafters, while it continues to broadcast a live video of the burglar to the local police.

A watchman robot-chicken will also act as a scarecrow, periodically patrolling out to the vegetable garden to frighten away crows and deer, then to the barn, then back to the house. It will be a mobile fire alarm, checking everywhere for signs of smoke or fire. It will make a good babysitter, assigned to tag along after a small child playing in the garden, to make sure she does not wander off or fall into the pond.

A little intelligence goes a long way. Cold fusion cells will scale down to any size. Suppose you make even smaller robots, the size of sparrows or locusts. In China, cold fusion cells smaller

than a locust have already been developed. They produce far more power than a locust could. In the U.S. and the U.K. military researchers are developing “micro air vehicles” the size of birds and insects, for use in reconnaissance.¹⁰⁶ Such small robots will be too weak to take action, but they might be programmed to search for the invasive beetles and then call in squads of chicken robots. They might recognize individual people and vehicle types. The police will dispatch a million of them to find a lost hiker, a wanted criminal, or a terrorist hiding in the mountains of Afghanistan. It is quite impossible for a human army to search behind every tree, in every cave and house in a nation, but insects find their way into all of these places. A million robot insects searching at high speed during all hours of daylight could cover a tremendous area. They could take a quick look — or a close-up photo — of every person in a crowded stadium. An insect-like machine with a power supply that lasts for decades, with only as much intelligence as a live insect, would have abilities we can hardly begin to imagine.

In the service of a dictator, these locusts might hover over citizens, keeping track of their activities, the books they read, their meetings and conversations. The locusts would send a video back to police headquarters whenever a citizen does anything suspicious or unusual, or not related to his assigned tasks. There are countless other ominous possibilities. Chapter 11 describes some of the gruesome weapons people might make with robot chickens.

If we can make computers that go beyond chickens to become as smart as dogs or monkeys, they will be able to perform just about all routine physical labor now done by people. Labrador retrievers now act as seeing-eye dogs, and Capuchin monkeys take care of quadriplegic patients. They operate the patients’ computers and televisions; bring them food and water; feed them; and wash their faces. It seems to me that their reflexes and senses make them capable of doing things such as driving cars. Monkeys frolicking in trees exhibit better coordination and reflexes than an Olympic gymnast or circus acrobat. If monkeys could understand the purpose and goal of a task, and if we somehow motivate the monkeys to do the work, I expect they could handle most routine, repetitive jobs such as production line work, cooking, or brain surgery. A robot with as much intellectual capacity as a monkey could certainly perform surgery. It would work under the supervision of a doctor, naturally, but the robot would actually do most of the job, just as jumbo jets fly most of the trip on automatic pilot. Delicate laser eye surgery is already performed by computers, and could not be done any other way.

2. More about invasive species and other man-made problems

Invasive species are those brought by man from one ecosystem to another, either by accident or deliberately. The Asian longhorned beetle was brought to the United States from China by accident. The kudzu vine in the southeastern United States was brought on purpose. It is native to Japan. It was brought by railroad companies in the late 19th century to prevent erosion. Kudzu grows quickly — up to 30 centimeters a day — so it does a good job of preventing erosion. But it has no natural enemies in America, so it has taken over and destroyed 3 million hectares of land.^{107,108}

¹⁰⁶ DARPA, Micro Air Vehicle (MAV) Advanced Concept Technology Demonstration (ACTD)
<http://www.darpa.mil/tto/programs/mav.htm>

¹⁰⁷ National Park Service, *Weeds Gone Wild: Alien Plant Invaders of Natural Areas*, Kudzu, *Pueraria montana* var. *lobata*, <http://www.nps.gov/plants/alien/fact/pulo1.htm>

On the West Coast, in the Seattle area, a group called the Anti-Ivy League goes around ripping out European ivy in parks and wilderness areas. European ivy is an invasive species in that ecosystem, although of course it causes no harm in Europe.

The best way to deal with invasive species will be to make autonomous robots on the same scale as the pest you want to get rid of, or on the same scale as the pest's natural enemy. Kudzu and ivy vines should be destroyed by robots the size of woodpeckers. A robot the size of an insect would take too long, and one the size of a dog or a human would be unnecessarily large and disruptive. Most agricultural machinery today is the size of a truck or tractor, but a robot this big, for this job, would be absurd. We need insect or bird-sized robots to kill invasive insect species, and submerged fish-like robots to kill the Japanese starfish and seaweed that have invaded Australian waters.¹⁰⁹

The starfish and seaweed were brought in containership ballast water. Containership ballast water is a major threat to ocean ecosystems! Something should be done about it, with or without cold fusion. Fortunately, a simple nozzle and filter would eliminate much of the problem, by shredding and killing species larger than 1 millimeter. Using existing technology and better inspections and laws, we can do much to prevent new invasive species, but it is hard to imagine how we can use today's technology to root out species that have already invaded. Cutting millions of kudzu vines by hand would cost huge sums of money. A single starfish can lay 20 million eggs; we could never hire enough divers to kill all the starfish invaders in Australia. People have sometimes dealt with invasive species by bringing in another species from the home country. You find a natural enemy of the Japanese starfish in the waters off Japan, and transport it to Australia. Unfortunately, in Australia this natural enemy is also an alien invader, and it may end up causing new and unforeseen problems. It is like the parable of the man who cuts one leg of a chair because it is a little too long, and then he cuts another because that one sticks out, and then he must cut another and another, until the chair has no legs left.

I suppose the robot chickens would eventually eradicate the longhorned beetles. We have driven other species into extinction using cruder methods, without even trying to, or wanting to. However, even if they do not rid North America of every last longhorned beetle, the chickens would greatly reduce the number of beetles and the damage they do to trees. This would open up the ecological niche now occupied by the beetles to native species. An initial assault with a million robot chickens might take two or three years. After that, a few thousand robot chickens would continue to patrol the woods looking for signs of damage from the beetles, and making population counts and observations of other species.

Other man-made problems in ecosphere will also be addressed with small robots. There are now millions of excess white tailed deer on the East Coast of the United States. They destroy tree saplings and endangered species, they starve to death in large numbers, and they spread disease. A Washington, D.C. area naturalist called them "rats with hooves." The deer population has exploded because people killed their natural predators such as wolves and mountain lions, and people do not hunt deer much anymore, especially in suburban neighborhoods. We cannot have robot chickens go around assassinating deer. That would be too traumatic. We would not want robots wandering around the landscape carrying deadly weapons or fatal doses of poison. A

¹⁰⁸ University of Alabama, *The Amazing Story of Kudzu*, <http://www.alabamatv.org/kudzu/>

¹⁰⁹ Japanese starfish, *Asterias amurensis*. Asian kelp, *Undaria pinnatifida*. The World Conservation Union, Invasive Species Specialist Group lists these two among the top 100 worst invasive species. <http://issg.org/>

curious child or bovine person might be killed by mistake. But we could have insect-like robots find and inoculate deer with birth-control hormones. Wild animal birth control has been tried on a small scale, but it is expensive. The hormones themselves are cheap, but it costs a lot to pay experienced hunters to find the deer and shoot them with inoculation darts. Granted, these inoculations would also be dangerous to people. The method would have to be carefully field tested, and perhaps run under remote control for several years. The robots might be semiautonomous. They might send a video image of their intended patient/target back to a human operator, and request permission before administering a dose. Perhaps veterinarians can find a safer method, like the human skin patch contraceptives, or spraying the animal in the mouth, or spraying the food it is eating.

This method might also be used to control populations of feral dogs and cats. Tests are being conducted with RU-486 abortifacient mixed with animal feed. Individual doses administered by robots over a wide area would probably reach a larger share of the population.

Robot chickens will also pick up the trash and filth that people have left on streets, highways, parks and rivers. They may be equipped with radiation detectors to search for lost radwaste or radioactive debris. They will patiently locate, gather up, and safely dispose of every scrap of carcinogenic and radioactive junk.

11. Mischievous Military Gadgets

All of the equipment in the world's military establishments — everything from ships, tanks, trucks, airplanes and telecommunications satellites to flashlights and radios — will be rendered obsolete by cold fusion. If a nation the size of Australia were to emerge ten years from now equipped with cold fusion powered weapons, transport, aircraft and logistical support, it could crush the military forces of any other nation as easily as the British defeated the Chinese in the Opium Wars, or as easily as ironclad steamships defeated wooden sailing ships in the U.S. Civil War.

The most important contribution cold fusion can make to the military will probably not be with new weapons. It will be with prosaic, civilian workaday machines such as vehicle engines, electric power supplies, and transport aircraft. Such things have always had a large impact on modern warfare. Railroads played a crucial role in the U.S. Civil War and the First World War. In 1948, Gen. Eisenhower wrote: ¹¹⁰

. . . four other pieces of equipment that most senior officers came to regard as among the most vital to our success in Africa and Europe were the bulldozer, the jeep, the 2½ ton truck, and the C-47 [DC-3] airplane. Curiously, none of these is designed for combat.

Many other civilian technologies played crucial roles in World War II, including high-octane gasoline, radio, and penicillin.

High performance cold fusion engines in helicopters, tanks and trucks will change the nature of these weapons. The operating range will be extended indefinitely. A cold fusion-powered helicopter might take off anywhere on earth and fly anywhere else, nonstop. It could fly at top speed, which is about 400 kilometers per hour (250 miles per hour) for today's helicopters. ¹¹¹ There is no need for a 'cruising speed' to reduce fuel consumption. Ships, tanks, helicopters, and transport aircraft will go for months without refueling, just as fission powered aircraft carriers and submarines do today. One of the biggest headaches in tank warfare is logistics and fuel resupply. The Allied invasion of Europe was stalled in the fall of 1944 mainly because of fuel shortages. The German tank armies were stopped in the Battle of the Bulge when they ran out of gas. Setting up massive fuel depots and transporting fuel were a major part of the 1991 Gulf War. A cold fusion-powered tank will run without refueling until the treads wear out and fall off. Armored hovercraft would have unlimited range.

Radar was invented to serve the needs of the military, but it has been just as vital to civilian applications, and radar is not a weapon in the sense that it hurts anyone. Cold fusion will give rise to many new types of weapons. I hope most of them are nonlethal, like radar. I expect many will be small and cheap, looking more like toys than weapons. In any case, those are the only kind I will discuss in this chapter, because I know little about weapons, and I do not like to think about war.

Although I am no expert on weaponry, anyone with rudimentary knowledge of aircraft and other machines can think of ways to disable or destroy them by combining cold fusion with

¹¹⁰ Eisenhower, D., *Crusade in Europe*. 1948: Doubleday & Co., p. 164

¹¹¹ Cold fusion would not make helicopters fly any faster; the rotor and drive materials are the limiting factor, not the engine power.

cheap, mass-produced gadgets. Here is how a small imaginary nation, Ruritania, might pin down or destroy the U.S. Air Force. Consider:

First, the U.S. Air Force does not have many warplanes. It consists of 10 groups each with about 130 airplanes, or 1,300 total.

Second, jet engines are remarkably fragile. Before flight operations on an aircraft carrier begin, a line of crewmembers walks slowly down the flight deck looking for dropped nuts, bolts, tools or scraps of metal. This is called a “FOD walk” - Foreign Objects and Debris. If one of these objects is sucked into the engine, it can cause serious damage, even grounding an airplane. Jet engines often ingest birds, causing serious damage and accidents. The FAA records about 4,000 bird strikes and \$300 million in damage per year from striking wildlife — mainly birds but also deer and other animals on runways.¹¹²

In short, the easiest way to disable an airplane is to throw a monkey wrench into the works. The engine will probably be damaged, and it may even explode. In any case, the airplane will be out of action. So, to defeat the U.S. Air Force you need approximately 13,000 wrenches, and you need to position them close to where the airplanes are parked. You keep an eye on the airplanes. Whenever a pilot revs up an engine, you dart out and throw 10 wrenches into the engine intake. The trick is to overcome the objections of the flight crews and other military personnel, who will try to stop you. Suppose the Ruritarians mass produce 13,000 small, slow flying machines, each about the size of a crow or a remote-control model airplane. These might be propeller driven, or they might be ornithopters (with mechanical wings). They would fly 3,000 meters high at no more than 150 kilometers per hour.

Automated airplanes have already flown from the U.S. to Australia. It would not be difficult to coordinate swarms of them. Traveling long distances would not be a challenge. It can be done with ordinary materials. Birds migrate thousands of miles, and ocean birds can survive hurricanes at sea.

These mechanical crows would be equipped with rudimentary computers, cameras and short-range radio remote control. They would work in swarms of 100 each. A swarm would be controlled by a swifter, ultra-high altitude spy plane, equipped with GPS and radio communications back to headquarters, or perhaps with a distributed network of spyplanes, which would be harder to shoot down. They might communicate via satellite or via a chain of spy planes back to Ruritania. Each spyplane would fly in circles high in the atmosphere. The radio could be as powerful as you like, since the power supply would not be limited by the amount of fuel it could carry. Both the “crows” and the spy planes would loiter over U.S. Air Force bases indefinitely. Every time a jet airplane or turbine helicopter engine starts, several crows would dive bomb right into the engine intake, like miniature kamikaze airplanes. They would hang around for weeks or months, until the motors running the propellers wear out and the machines fall to earth. New swarms would be dispatched daily. As each machine on station wore out, another would take its place. These machines would cost only a tiny fraction of the cost of the U.S. aircraft they stymie.

You might suppose it would be a trivial matter to shoot these things out of the sky, and you would be right. A farmer with a shotgun can hit a crow. Air Force and Army troops could

¹¹² International Bird Strike Committee. <http://www.int-birdstrike.com/index.html> http://wildlife-mitigation.tc.faa.gov/public_html/

probably blast hundreds of the mechanical crows out of the sky, but Ruritania could send thousands more to take their place. Antiaircraft guns and Patriot missiles are not designed to hit swarms of birdlike objects flying in random patterns 3,000 meters up in the air. It would be like trying to swat mosquitoes with a battering ram. The U.S. would spend far more money on ammunition, manpower and effort to swat a crow out of the sky than the Ruritarians spend to make a new crow. This is economically asymmetrical warfare.

If the Air Force tried to dispatch a helicopter or jet airplane to strafe these pesky machines, the remote operator on duty back in Ruritania would see the helicopter start to move, and he would order five or 10 crows to stop it. Eventually, Ruritania would send its own Air Force of full-scale, manned aircraft to occupy the U.S. It might consist of a few dozen airplanes, but the U.S. would be defenseless to stop them. Since these full-scale aircraft would also be cold fusion powered, they would fly right around the world at top speed, at altitudes that no fossil-fuel airplane can reach, perhaps outside the atmosphere. They would arrive and then loiter over major cities and military bases, hovering indefinitely, dragging their coats and waiting for a response. When the U.S. tried to launch its airplanes to intercept them, the mechanical crows would dive down by the thousands to disable every airplane the moment it moves. They would zip down into the launch tubes of Patriot missiles as soon as the covers open. After a few weeks of mounting frustration, the U.S. would have no intact airplanes left, and it would be forced to negotiate surrender. If this seems unlikely, bear in mind that guerrilla tactics and innovative small weapons in the past have defeated great empires, such as England in the U.S. Revolutionary war, and the U.S. in the Vietnam War. In Vietnam, U.S. airdropped high tech munitions were supposed to detect humans and animals, and zero in on them before exploding. Vietnamese troops defeated them by hanging buckets of urine in trees.

Since range is unlimited, groups of mechanical crows could easily hide their tracks and attack from random directions. Groups might be sent thousands of kilometers in random directions, later converging on the target. Some might come from the East, while others fly all the way around the world to come in from the West. They might skim just above the waves, undetected by radar, or drop down into deep woods to hide and wait for weeks.

This is, of course, mere fantasy. In real life the U.S. would quickly devise small machines or cheap rockets to destroy the crows. The machines used knock down the crows might be conventionally powered, since they would only need to fly a short distance. Even so, cold fusion will end the era of large, manned, chemical-fuel jet propelled fighter airplanes and helicopters. They will become vulnerable to cheap, simple weapons. If large, manned military aircraft remain in use, they will have to be redesigned with cold fusion engines, without vulnerable air-intakes or explosive fuel.

One can imagine many similar weapons of mass annoyance. They would cause havoc to all branches of the military, flattening tires, cutting wires, broadcasting fake GPS signals at close range, or patiently, quietly, cutting holes in the bottom of parked fuel tanker trucks. A cold fusion powered drill can keep spinning until there is nothing left of the bit, or it might heat a steel rod to incandescence and keep it hot for weeks, gradually penetrating the material.

The path of a fiber-optic telephone line or a pipeline is marked with warning signs, to keep backhoe operators from digging it up. The crows would search for these warning signs, and then burrow underground and cut the connection. Even if a refinery can be protected, the pipelines leading to it stretch thousands of kilometers, and cannot be guarded along its full length. It is

impossible to hide this kind of vulnerable infrastructure, and no human army would be large enough to guard it.

A small, quiet, unobtrusive, remote-control cold fusion powered “crow” might fly into a military base at night, secret itself under the eaves of a building or in a pile of trash behind a loading dock, and start a fire a week later. In the words of the Disney cartoon *Lilo and Stitch*, these doomsday machines would be “irresistibly drawn to big cities where [they] will disrupt sewer systems, reverse street signs and steal everyone’s left shoe.” A few hundred Halloween trick-or-treat nuisances would not stop an army, let alone slow it down. But thousands performed automatically or by remote control, day after day, every time you turn your back on a parked vehicle or finish stringing up new electric wires, would cause so much chaos and extra work no army could cope with it for long. During the invasion of Normandy, the French resistance held up German armies with similar tactics. In the Iraq war, a few people setting off car bombs has tied up thousands of troops and demoralized the whole nation. Imagine the effect of 10,000 small incidents a day, most of them harmless, but each enough to disable a truck or cause dozens of troops to stop what they are doing to deal with the problem.

You would send flying monkey wrenches to defeat fighter airplanes. There would be no point to sending large, explosive bombs. Flying monkey wrenches are cheaper, smaller, lighter, faster, and safer for your own troops to work with. Why bother with explosives when you can use jujitsu and exploit the airplane’s own weakness to destroy it? Why hurt the enemy pilots when all you want to do is keep them on the ground and impotent? Still, conventional chemical explosives could be incorporated in cold fusion powered weapons, making them more sinister and destructive. Unmanned cold fusion powered weapons armed with explosives could probably overwhelm most powerful and sophisticated weapon systems, such as capital ships. (I do not suppose they could overcome nuclear missiles in silos.)

Consider the conventional MK-47 Torpedo. These were first deployed in the 1970s. They are six meters long and weigh 1.5 tons. They can locate a target from 1.4 kilometers away, and they run 8 kilometers before the fuel is exhausted and the torpedo stops. They cost \$2.5 million each. Now imagine a cold fusion powered version. The range would be a million kilometers; the torpedoes could run at top speed until the bearings wear out and the engine stops turning. They might have simpler and cheaper electronics because they would seldom need to acquire targets more than 100 meters away. Suppose Ruritania is on the verge of declaring war on the U.S. It dispatches flocks of these torpedoes to loiter outside of harbors and U.S. Naval bases, waiting for a capital ship to emerge. The torpedoes then tag along behind the ship, periodically sending satellite radio reports back to headquarters in Ruritania showing their location, operating status, local weather and so on. An unmanned torpedo can accelerate, turn and maneuver much faster than a manned ship. A torpedo would be at least 3,000 times cheaper than a capital ship, and probably 100,000 times cheaper with a simplified, mass-produced design. So Ruritania could afford to make large numbers of them to overwhelm the enemy, even if the U.S. Navy finds ways to destroy some of them.

The torpedoes would tag along a few meters behind a surface ship. Tracking a submarine would be a little more complicated. When the submarine submerges, they would follow in a group. Submarines are very quiet, to avoid detection; but at that range the torpedo could not miss hearing the propellers. For that matter, it could probably pick up the crewmembers’ conversations, record them, and broadcast them back to Ruritania. Radio has a short range underwater. The torpedo closest to the submerged submarine, #1 in line, could not contact

Ruritania. But it could send a short-range signal to the next in line, #2, which would be a few meters behind and 50 meters above. The #2 torpedo would pass the report on to #3, 50 meters above that, and so on up the chain to the surface of the ocean where the last torpedo would relay the position and status report to the satellite connection back to headquarters. When war is declared, a signal is sent to the last in line, and a moment later it is relayed down the chain to #1, which darts in and explodes, followed by #2, #3 and so on.

The full-sized, conventional torpedoes with warheads might be augmented with a hundred smaller torpedo-like machines, each a meter long, like a large fish. These would be far cheaper, and they would have no warhead. These might help maintain the communications link back to Ruritania, or they might simply cause trouble for the submarine crew, banging on the hull day and night, fouling the propellers, jamming themselves into diving planes, covering the periscope lens, and making rude noises into the sonar pickup microphones. When the submarine submerges, a wave of them might dart in and cling to the hull like limpets, getting a free ride. Freeman Dyson and others have suggested that a “mobile limpet mine” or “suckerfish” could be used to keep track of submarines. These robot devices would clamp onto the hull of a passing ship. A half million ordinary limpet mines were deployed in World War II, and a science-fiction story published in 1942 described cybernetic mobile versions, that travel submerged to a harbor, wait for a ship to pass, and then blow it up.¹¹³

The sailors in a submarine or surface ship might realize a limpet has attached itself to the hull. According to the late Admiral Sir Anthony Griffin, experts in the Royal Navy are trained to dive under ships stopped in mid-ocean to remove such mines.¹¹⁴ In wartime this would be a hazardous undertaking for both the diver and the ship, because the ship would be immobile and vulnerable to attack. Cold fusion would make a limpet easier to implement, and much more effective. First, the limpet would find the submarine unfailingly, because it could swim halfway around the world and wait just outside the harbor. (It would swim away or settle in the mud on the bottom whenever a ship or diver came out to investigate.) Second, it would be difficult enough to remove one or two of today’s conventional, immobile models. Imagine trying to remove a hundred mobile limpets that have power to spare, and rudimentary artificial intelligence or a remote control link back to a distant human operator. Whenever the diver approached a limpet, it would scuttle away and find a new spot on the hull, or swim away from the ship and wait patiently in the dark water, until the diver gives up and the submarine gets under way again, when the limpet would dart back in and stick to the hull again.

Submarines are equipped with anti-torpedo weapons. I do not know how many they carry, but suppose there is room for 20. In that case the Ruritaniacs would dispatch 40 full-sized tag-along torpedoes with warheads, and perhaps a hundred fishes and limpets to assist.

The main advantage of a submarine is that it is hidden. A nuclear missile submarine is a credible threat because other nations do not know where it is hiding, and they cannot destroy it in a first strike. Cold fusion tag-along torpedoes would obviate this advantage. Mythical Ruritania may not want them, but in the real world, China probably would, since it is presumably the only nuclear power that might be threatened by U.S. submarines. Once cold fusion becomes viable,

¹¹³ Leinster, M., *The Wabblers*, in *Astounding*. 1942. This is one of the early descriptions of what later became known as cybernetics.

¹¹⁴ Griffin, A., personal communication.

China could easily develop such torpedoes. Israel has a submarine equipped with nuclear missiles, so countries hostile to Israel would probably also want the torpedoes.

1. Robot Chickens as Weapons

The weapons described above could be made by combining cold fusion with existing technology. The “crows” of mass annoyance could be operated by remote control, although this job would keep a large body of Ruritanian soldiers busy day and night. The control links would often fail, disabling the weapons or letting them fall into the hands of the enemy.

Chapter 10 describes a future breakthrough in artificial intelligence that I dubbed the “birdbrain”-class process control computer. They will be combined with small autonomous machines I called “robot chickens,” and NASA calls “robosects.” Small weapons such as the “crows” would be far more potent if they had a measure of low-level artificial intelligence, with functional, rudimentary intelligence roughly at the same level as a chicken or a wasp. They will be able to fly, recognize people, and distinguish between different species. Unlike today’s artificial intelligence robots, they will have no difficulty distinguishing shadows from objects. This would make the weapons described in this chapter much easier to implement and operate, and much more likely to hit the targets.

Robot chickens will be a great boon to humanity. They will do many jobs that people cannot, such as destroying invasive species, cleaning up trash that has scattered over a huge area, or acting as mobile burglar and fire alarms. But a malignant robot chicken programmed to cause harm would be fearsome, especially when coupled with conventional weapons or the weapons of mass annoyance. A terrorist or despot might make millions of flying robots, no larger than handguns, each equipped with a 22-caliber bullet or a poison injection, like a bee sting. They would fly right up to a victim and shoot him at close range. They might hover over a city or military base, and then fly through an open door or window to assassinate someone inside a building.

Chickens have no difficulty distinguishing live human beings from other objects, other animals, decoys, and people who are already dead, and they are swifter and more agile than people, so they would be unstoppable. They recognize uniforms, weapons and people’s intentions, such as when you pick up the broom to drive the chicken out of the kitchen. When you and I both gather a handful of table scraps and go out in the yard to feed the chickens, the chickens recognize we are two people, each equipped with food. They split into two groups, and each group gathers around one of us. Even creatures as simple as bees do this. If you step on a bee’s nest while we are out feeding the chickens, the bees will swarm out, split into two groups, and attack us both. Today’s supercomputers may have difficulty recognizing two people as two separate targets, but an angry swarm of bees does this. So, each of these flying handguns would select a real person, not a shadow or a mannequin; each would select a different victim; and each would hit the target.

These flying handguns/bees would be the ultimate “smart weapons;” each shot would kill or disable one soldier. A terrorist armed with a few truckloads of flying handguns might sit comfortably anywhere in the world, risking nothing, utterly undetectable, and in a few weeks he might assassinate most of the soldiers in the U.S. military. The only antidote to such infernal weapons would be other cold fusion powered birdbrain-class devices. Fortunately, these need not be destructive or dangerous weapons. We will not have to embark on a new nuclear arms race —

one with miniature but deadly weapons. We need only machines that cost as little as the flying handguns, and that knock the handguns out of the air and disable them. A chicken can usually catch another chicken.

As I mentioned, pipelines will be vulnerable to attack by remote control crows or autonomous robot chickens. Pipelines are impossible to hide. Although no human army would be big enough to protect a pipeline against these small weapons, autonomous robot chickens can do the job at practically no cost, guarding against sabotage, and also ordinary accidents or spills.

Cold fusion and birdbrain-class computers will both be developed sooner or later. Their potential benefits far outweigh the risks. But the weapons capabilities described in this chapter will be apparent to everyone the moment the technology arrives, so it would be a good idea to keep democratic nations at the forefront of development.

12. Terror Weapons, And Weapons of Mass Destruction

Most experts say that a cold fusion nuclear bomb is physically impossible. Let us hope they are right. Cold fusion devices are cheap. If a bomb is possible, someone might assemble hundreds of devices the size of shoeboxes, each with the power of the Hiroshima bomb, each costing only a few thousand dollars. They would not be radioactive, so they could not be detected. This unlikely scenario prompted a cover story in *Popular Mechanics*, in August 2004.



Figure 12.1. The lurid cover story in *Popular Mechanics*, August 2004, was “America’s Worst Nightmare: Homebuilt H-Bombs, Cold Fusion Technology Enables Anyone to Build a Nuke from Commonly Available Materials.”

The article quoted Eugene Mallove, who worried about cold fusion bombs. It quoted unnamed Defense Department experts who appear to be concerned that cold fusion might make some aspects of conventional nuclear weapons production cheaper or easier, by simplifying the production of tritium or weapons grade uranium. But even if this happens, most aspects of nuclear bomb production and maintenance would be unchanged, and a project to make a bomb would still take billions of dollars and thousands of skilled experts. Most experts dismissed *Popular Mechanics* as lurid, sensationalist and unhelpful. Martin Fleischmann has often said he wanted to delay the announcement of cold fusion in 1989 because he had some national security concerns, but he called this magazine story “excessive,” adding:

There is, of course, a connection between “Cold Fusion” and the National Security implications but I doubt very much whether the article in “Popular Mechanics” could contribute to this topic.¹¹⁵

¹¹⁵ Fleischmann, M., personal communication, 2004

Most researchers think that a runaway reaction or explosion is impossible for three reasons:

1. Cold fusion only works with an intact metal lattice.
2. It ramps up relatively slowly, so it would destroy the lattice before it could increase to high levels.
3. It is not a chain reaction. In a uranium fission chain reaction, one event directly triggers two or more others, and the reaction can increase exponentially over a very short time (80 generations in 1 microsecond).

Cold fusion can raise the temperature of the metal, and this higher temperature often causes more cold fusion activity. This is called positive feedback. A wood fire works the same way: the heat from an open flame rapidly vaporizes and ignites more fuel, accelerating the fire. But neither a fire nor cold fusion is a chain reaction in the same sense fission is.

Despite these limitations, there have been at least five disquieting and unexplained explosions in the history of cold fusion:¹¹⁶

1. February 1985, Fleischmann and Pons, University of Utah, United States. One of the early cells exploded in the campus laboratory.
2. September 1989, T. P. Radhakrishnan *et al.*, Bhabha Atomic Research Centre (BARC), India. The electrolyte temperature “shot up” from 71°C to 80°C and the cell exploded.¹¹⁷
3. April 1991, X. Zhang *et al.*, Institute of Southwest Nuclear Physics and Chemistry, China.¹¹⁸ Three explosions occurred in cells with palladium tube cathodes. Two of these explosions destroyed the glass cells, blowing the tops 1 to 2 meters away. About a half hour after one event, the temperature of the bath surrounding the cell was found to be elevated 5°C. There was 33 ml of gas in the cell headspace, roughly 40 times less than it would take to cause these events.
4. September 2004, J-P. Biberian, Université d’Aix-Marseille II, France. A cell with a palladium tube cathode exploded. The cell had no more than 120 ml of gas in the headspace, which does not seem like enough to cause a chemical explosion of this magnitude.
5. January 2005. Mizuno *et al.*, Hokkaido University, Japan. In the first phase of a glow discharge experiment, before the plasma normally appears, the cell temperature suddenly rose to 80°C and a bright white flash surrounded the cathode. An instant later the cell was shattered, blowing off the Pyrex safety door of the cell container. Shards of glass were driven up to 6 meters away, and one of them injured Mizuno. The explosion produced roughly 132,000 joules, or 441 times more than the total input energy.¹¹⁹

¹¹⁶ There may have been many others. I revised this section in early March 2006 listing three events. Researchers soon contacted me and pointed out two other papers describing anomalous explosions. This is a vast field, and no one can be aware of everything that has been claimed. Thousands of papers have been published in English, many more in languages I cannot read, and many other results are unpublished.

¹¹⁷ Radhakrishnan, T.P., et al., *Tritium Generation during Electrolysis Experiment*, in *BARC Studies in Cold Fusion*, P.K. Iyengar and M. Srinivasan, Editors. 1989, Atomic Energy Commission: Bombay. p. A 6. <http://lenr-canr.org/acrobat/Radhakrishnitritiumgen.pdf>

¹¹⁸ Zhang, X., et al. *On the Explosion in a Deuterium/Palladium Electrolytic System*. in *Third International Conference on Cold Fusion, "Frontiers of Cold Fusion"*. 1992. Nagoya Japan: Universal Academy Press, Inc., Tokyo, Japan. <http://lenr-canr.org/acrobat/ZhangXontheeexplo.pdf>

¹¹⁹ Mizuno, T. and Y. Toriyabe. *Anomalous energy generation during conventional electrolysis*. in *The 12th International Conference on Condensed Matter Nuclear Science*. 2005. Yokohama, Japan. <http://lenr-canr.org/acrobat/MizunoTanomalouse.pdf>

Events 1, 3, 4 and 5 were anomalous. That is, they produced more energy than any chemical reaction could have. It is not clear how much energy was produced by event 2; it may have been a conventional recombination explosion. In January 1992, in a tragic accident at SRI, a cold fusion cell exploded, killing researcher Andrew Riley. However, this was caused by conventional chemical reactions. It occurred after a whole series of safety devices and precautions failed, in an incredible coincidence.¹²⁰



Figure 12.2. The remains of a cell that exploded in September 2004, Université d'Aix-Marseille II. Photo courtesy J-P. Biberian.

The first explosion at the University of Utah produced the most anomalous energy. Charles Beaudette described it in a radio interview:

They had one of their very first experiments set up in Room 1113 of the North Henry Eyring Building on the campus there at the University of Utah. They left it overnight and they came in in the morning and it was a mess. My eyewitness says that there was a [large] hole in the laboratory bench, there was a lot of particulate matter in the air, and Pons and Fleischmann had a funny look on their face like the cat that just ate the canary. They were really rather pleased with what had happened.¹²¹

While there is no doubt this reaction liberated more energy than a chemical device of the same size could, this does not prove that a large-scale device could produce a massive explosion. At

¹²⁰ Smedley, S.I., et al. *The January 2, 1992, Explosion in a Deuterium/Palladium Electrolytic System at SRI International*. in *Third International Conference on Cold Fusion, "Frontiers of Cold Fusion"*. 1992. Nagoya Japan: Universal Academy Press, Inc., Tokyo, Japan.

¹²¹ RADIO WEST, by Douglas Fubbrezio, interview with M. McKubre and C. G. Beaudette, November 27, 2002, station KUER, University of Utah, <http://lenr-canr.org/Collections/KUERinterview.htm>. The original transcript said this hole was 14 inches, but Fleischmann recalls and that it was much smaller.

worst, the reaction is probably similar to a conventional nuclear fission reactor core meltdown. A meltdown can liberate more energy than an equal mass of chemical fuel could, and it can cause catastrophic damage, such as the Chernobyl explosion. But it cannot trigger the kind of massive explosion an atomic bomb undergoes.

A uranium nuclear reactor can be reengineered to make a meltdown impossible. Next-generation prototype reactors such as the pebble bed modular reactor accomplish this. It has 300,000 round “mini-reactors,” each the size of a tennis ball. The balls are held apart at a safe distance by their shape, and can never reach criticality or go out of control. They are cooled by helium, which circulates by itself, with convection. It does not require pumps or other active devices that might break, and it will continue circulating even if the reactor plant is abandoned. A fission reactor can be made meltdown proof, and it is likely that a cold fusion reactor can, too, perhaps by similar methods. Most experts agree that once we understand the nature of the reaction, we will know how to engineer cold fusion cells that will make another 1985-style explosion or meltdown impossible.

Unfortunately we know nothing about the nature of the February 1985 explosion, because Fleischmann and Pons did not keep any physical evidence from this event, such as a piece of the burned table, or scraps of the exploded cathode. In my opinion, this was irresponsible and unprofessional. Fleischmann ruefully agrees. Unfortunately, the history of cold fusion includes many similar careless acts, and thoughtless destruction of vital experimental evidence and data. In his book,¹²² Mizuno wrote that he found some kind of black material formed on the surface of the cathode, and after puzzling over it for a while he casually scraped it off. The material might have been palladium, which is black when the particles are microscopic, or it might have been a mixture of palladium and something else. He later came to realize that this material was probably crucial evidence indicating the nature of the reaction. Casually throwing it away was one of the stupidest things he ever did. He said he realized, “I had destroyed critical evidence. It was like throwing away treasure.”

Mizuno was careful to preserve physical evidence and computer data from the 2005 explosion, and this material is still under investigation.

¹²² Mizuno, T., *Nuclear Transmutation: The Reality of Cold Fusion*. 1998, Concord, NH: Infinite Energy Press, Chapter 4.

13. The Oil Industry Has No Future

Cold fusion will make all other sources of energy obsolete. Unless something better comes along, a hundred years from now it is likely to be the only primary source of energy. Most cold fusion heat may be converted to other forms of energy, such as electricity or chemical fuel for special purposes. Other energy sources will gradually become extinct, starting with the most expensive, controversial and environmentally destructive ones, such as oil and coal.

Oil will be the most tempting target for early replacement by cold fusion, especially in the U.S., for several reasons:

- Oil is the most expensive fossil fuel, so customers will be anxious to buy a cheap replacement. There is less incentive to replace coal, which is about ten times cheaper.¹²³
- Oil itself has higher energy overhead than other sources such as coal. Ten to 20% of the energy from oil is used to extract and refine the oil itself. Oil produced in the Middle East must be transported halfway around the world to other countries via tankers that consume the equivalent of 5% of the oil they carry.
- Most oil is used for one narrow purpose: transportation, mainly in gasoline motor vehicles, but also diesel trains, ships, and aircraft. The U.S. and other countries previously had oil fired power generators, but after the 1970s oil shocks, most were phased out.¹²⁴ Because such a narrow range of machines run on oil, they can easily be targeted. Once you develop a cold fusion motor for vehicles, 45% of the oil market falls into your lap.
- The U.S. has plenty of coal and uranium, and it is nearly self-sufficient in natural gas, but it imports 60% of its oil. Oil discoveries in the U.S. peaked in the 1930s, and virtually no new oil has been discovered since the early 1970s. Production peaked in 1971, and has fallen by one third. Within a few decades it will fall to zero.¹²⁵
- Oil is politically charged. Much of it comes from the Middle East, which is plagued by wars, revolution and terrorism. Some critics charge that the war in Iraq is really “a war for oil.” This is debatable, but on the other hand, if there were no oil in the Middle East, it seems unlikely that the U.S. would be involved in the region.

¹²³ Different energy sources are conventionally measured with different units, making them difficult to compare. One ton of coal yields 25,849 megajoules, and is equivalent to 4.4 barrels of oil.¹²³ In 2002, a ton of coal cost \$17.80,¹²³ and a barrel of oil cost \$20.34, so coal was about five times cheaper. In September 2004, oil had risen to around \$40, and coal was unchanged. *Annual Energy Review 2002*. 2003, U.S. Department Of Energy. <http://www.eia.doe.gov/emeu/aer/>, p. 215

¹²⁴ *Annual Energy Report 2002*, p. 149

¹²⁵ Deffeyes, K., *Hubbert's Peak, The Impending World Oil Shortage*. 2001: Princeton University Press.

By Sector, 1949-2002

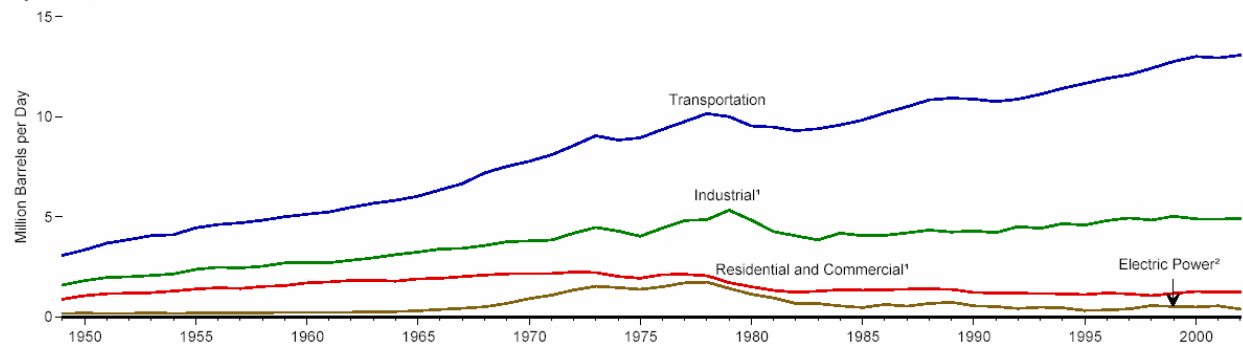

Figure 13.1. U.S. Petroleum consumption by sector. From: *Annual Energy Report 2002*, p. 148

Martin Fleischmann once said that cold fusion is like an old bicycle: you have to get used to it before you can believe it. Once you see it happen in the laboratory enough times it no longer seems so astounding. The ramifications of cold fusion also take time to sink in. It is surprising how many experts overlook them at first. I have discussed cold fusion with petroleum experts several times. They begin by saying that it will not matter in the long run if the market for oil fuel dwindles away, because oil has many other uses as an industrial raw material for things like plastic. Nineteen percent of oil is used in non-energy applications, but experts say that the market will grow in the future. When Hal Puthoff met with the presidents of Pennzoil, Texaco, Marathon, Coastal, and other oil companies, they told him they would welcome zero-cost energy. He paraphrased them: “When we take our precious resource out of the ground to make nylons, plastics, drugs, etc., we don’t use up much and we have a large profit margin. When we take it out of the ground to power automobiles and heat people’s homes, it’s like heating your home by burning van Goghs and Picassos. Please take this burden off our industry. And, by the way, let us buy some to make our refineries more efficient.” With all due respect, I think these executives were kidding, or this was false bravado. No sane executive would be so sanguine at the prospect of losing 81% of his business. Why should the oil company care what the customer does with the product? They get the same \$40 per barrel whether the customer burns the stuff or makes nylon out of it. In any case, I think these executives are wrong. They will lose 100% of their business. Oil will be worth nothing. I have asked experts: “Could you synthesize oil from raw materials? If I gave you carbon and water, could you make any hydrocarbon petrochemical you like?” They say yes, but it would take fantastic amounts of energy. It would take as much energy to synthesize oil from carbon and water as you get from burning the oil, plus some overhead. This would be the most uneconomical chemical plant on earth. It does not occur to them, at first, that the plant would be cheap to run if energy costs nothing.

A synthetic oil plant would resemble today’s oil refinery. The only major ongoing costs would be for the wear and tear of the equipment, such as pipes and pumps. The carbon might come from carbon dioxide in the air, or it might come from coal, garbage, or sewage, which cities will pay the plant to take. Oil is already being synthesized from organic waste in Japan and in Pennsylvania, in thermal depolymerization plants. “Personal computers, old tires and even turkey bones and feathers” are converted into oil. The Chief Executive at one such plant explained: “We are supercharging that process and doing in minutes what the earth would naturally do over hundreds of thousands of years.”¹²⁶ Critics charge that the resulting oil is too expensive, it may

¹²⁶ Segre, F., *Company Seeks Fortune Turning Garbage into Oil*, Reuters News Service, <http://www.planetark.com/dailynewsstory.cfm?newsid=21583&newsdate=22-Jul-2003>

not be useful for many applications, and the process itself consumes too much energy. With cold fusion, it will be much cheaper, and it will be widely developed in many different variations until it meets all applications for petrochemicals, from asphalt to lubricating oil. Smaller versions of these plants will be installed at factories that produce plastics. It will be more convenient, cheaper and safer to synthesize petrochemicals where they are needed, rather than pumping them out of the ground and transporting them over great distances.

Depolymerization machines may eventually be made fully automatic, and reduced in size until they can be delivered in a single unit that fits on the back of a truck. They might be mass-produced and used for local sewage treatment in small communities. They would be a great boon to Third World villages, where untreated sewage (human and animal waste) is used for fertilizer, and drinking water and rivers are heavily polluted. In the distant future, the plants may be miniaturized until they are as small as an air-conditioning unit or furnace, and they can be installed in the basements of houses and apartment buildings. The toilet, shower, kitchen sink and garbage disposal, and most trash will go down the drain into this box, where the garbage and sewage would be treated immediately and converted into pure water and a small volume of dry harmless organic material, mostly carbon. The solid waste would automatically be packaged in sealed plastic bags that are collected and recycled once a month.

In the far distant future, after chemical food synthesis is perfected, this household machine will be directly connected to the food synthesis machine. The water and waste will be converted back into food again, automatically.

To avoid global warming, we may someday build massive complexes to synthesize millions of tons of oil. (See Chapter 9.) These would be reverse oil wells. They would be located in desert areas such as Saudi Arabia. They would convert carbon dioxide and water into hydrocarbons, and then inject the hydrocarbons deep into underground formations.

Oil and electric company executives and energy experts on television often say the transition away from fossil fuel will take 50 to 70 years. They never discuss cold fusion in public, but when I have brought up the subject with them in private, they say it would be no different from conventional alternatives such as wind turbines or next-generation fission reactors. What they mean is, it would take *them* 70 years, because they would prefer to wait until their generators wear out and their oil wells run dry, and they would like the rest of us to operate on their schedule. They do not realize that when a consumer goes to Sears or Best Buy to purchase a small, cheap machine that will last only five or ten years anyway, and he finds a better model in the showroom, he will not dither or wait 50 years before selecting the new gadget. (See Chapter 7, Section 5.) A person buying a cold fusion powered water heater or home generator will not hesitate just because a power company generator still has 50 years of working life left in it. Consumers never stop to consider what adverse effects their purchases may have on the power company, or the oil company. On the contrary, many would select the cold fusion powered model out of spite. People do not feel friendship or loyalty toward power companies, and there is little love lost for oil companies and OPEC. Most people would be happy to stop using their products, even if they had to pay a little extra for the replacement. They would be thrilled if the replacement was far cheaper.

14. The Electric Power Industry Has No Future

In the previous chapter, we saw how cold fusion will quickly eliminate the market for oil. I predict that it will also gradually eliminate the need for the electric power industry. Generating electricity from coal causes pollution, and nuclear power produces dangerous nuclear waste, so anyone can see that it would best to eliminate them. However, even non-polluting present-day methods of generating electricity will eventually be abandoned. Alternative energy such as wind and solar cells are expensive. Even hydroelectricity will eventually be unable to compete. Hydroelectric dams are cheap to maintain, but they are far from cities and the power has to be transmitted over power lines that are expensive to maintain. Eventually, they are likely to be damaged in a storm, and it will not be worth repairing them.



Fig. 14.1. Power lines damaged by a storm, Florida 2004. Power distribution lines are the Achilles heel of the power companies.

Solar energy in space or on the surface of the moon may remain competitive, but product engineers will eventually become so used to cold fusion, and mass-produced cold fusion power supplies will become so cheap and reliable, the engineers may not bother with alternatives, even on the moon.

To understand why power companies are so vulnerable to cold fusion, let us look at the history of electric power companies. In the 19th century and for most of the 20th century, it made sense to generate electricity in large central power plants. The plants had to be located far from cities, so

the power had to be transmitted long distances, and distributed via a gigantic, complex grid. Plants had to be far from cities because most were coal-fired and they emitted billowing clouds of smoke. Others were hydroelectric dams, which must be constructed where rivers fall through steep drops. Such rivers are not navigable so cities were seldom located nearby. Later, nuclear plants were also placed far from cities because people felt they might be dangerous. This turned out to be a sensible precaution. U.S. commercial reactors have not killed anyone in operation, although the mining and refining of uranium has probably killed thousands of people from cancer. However, there have been extremely serious accidents such as Brown's Ferry (1975), Rancho Seco (1978), Three Mile Island (1979), and Connecticut Yankee (1996).¹²⁷ Some of these accidents were dangerous, and they were the most expensive industrial accidents in U.S. history by far, costing billions of dollars to clean up, and nearly bankrupting the power companies.

Historically, centralized plants were safer, cheaper, cleaner, and more energy efficient, since there were economies of scale with the old technology. It was easier to monitor one large central plant to reduce pollution and ensure safety. The equipment was hazardous to work with, and it required hundreds of people to monitor it and perform maintenance.

These advantages have faded as the technology has evolved over the last 80 years. Modern gas-fired generators do not pollute much. Compared to the old coal-fired plants, they are safe and automated, and they need only a small staff and much less maintenance. Economies of scale have been reduced or eliminated. A medium-sized 100-megawatt gas turbine plant is as efficient as a giant 1,000-megawatt plant. Central generators and the power grid are maintained because they are "incumbent"; they are paid for, and we know how to use them. (See Steven J. Gould's comments and definition of "incumbent" in Chapter 7, Section 2.) With or without cold fusion, power companies are likely to get into trouble in the coming decades, and become mired in economic stasis. They are gradually being supplanted by privately owned generators at factories and business parks, especially private cogeneration (explained below). Cold fusion will accelerate this trend. It will supply electricity and heat directly to individual houses, shopping malls, factories and farms.

Table 14.1 shows some of the major advantages of central power generation. Most of these advantages have been marginalized by improved conventional generators, and the rest will be obviated by cold fusion.

¹²⁷ Connecticut Attorney General's Office News Release, September 16, 1997, "What we have here is a nuclear management nightmare of Northeast Utilities' own making. The goal is no longer to decommission a nuclear power plant, but rather to decontaminate a nuclear waste dump." <http://www.ct.gov/ag/cwp/view.asp?A=1772&Q=282568>.

Table 14.1. Advantages of centralized generation and power companies

Advantages of large, central generators	Modern generators	Cold fusion
Pollution moved to less populated places, so it hurts fewer people	x	x
Remaining pollution reduced	✓	✓
Economies of scale	✓	x
Efficient use of fuel	✓	x
Safety enhanced	✓	✓
Cogeneration	✓	✓
Advantages of power companies		
Experts maintain equipment	✓	x
Experts monitor the network		x
Quickly repair network after storms and other disasters		x
Distribute power so that capacity and the cost of equipment is shared		x
Synchronize alternating current from many different generators		x

✓ Modern, small gas-fired generators, or cold fusion, do this function better than a large central generator.

x Modern generators or cold fusion make this function unnecessary.

As a power company customer, you share capacity. You use a tiny fraction of the gigantic central generator, and you only use it when you need it, so the equipment cost is cheaper than it would be if you purchased your own generator. Large factories use electricity at night at lower rates, when extra capacity is available. This advantage will still hold for cold fusion; it would be cheaper to share a cold fusion generator with everyone in your neighborhood, rather than buying one for each house. For that matter, it would be cheaper to share your water heater with the neighbor, with insulated hot water pipes going to both houses. However, no one would bother to share a \$300 water heater. It would not be worth the hassle to maintain the pipes and figure out who owes how much for the gas. With cold fusion it will be less trouble to simply buy your own capacity, and the equipment will be so cheap it will not be worth sharing.

1. Cogeneration, Or Combined-heat-and-power (CHP)

A small generator converts only about 25% of the heat into electricity, and the rest is lost as waste heat. This will probably be true of cold fusion generators as well. “Waste heat” or “degraded energy” is the engineering term, but actually, this heat need not be wasted. It can be put to good use in any application that calls for moderate temperatures. You can channel it to heat the house in winter, or to run a thermal air-conditioner in summer. You can use it in a kiln at 56°C, to heat-treat lumber and kill parasitic worms. This is called cogeneration, or combined-heat-and-power (CHP). Even though a small generator is inefficient, when it is used as a cogenerator, it may actually deliver more useful energy to the house, office or factory than the ultra-modern 100-megawatt power company gas turbine does.^{128, 129}

A giant power company generator plant can also be used as a cogenerator. This is not a new idea. Con Edison cogenerator plants in New York City have been used since the 19th century to distribute steam in pipes under the streets, which is used to heat buildings. This is sometimes called “district heating.” This is not widely used because most power company plants are far from cities and factories, in isolated locations. You cannot transport hot steam 50 kilometers from a generator to a city. A cogenerator must be installed close by the buildings and factories that need the steam. There have been proposals to build factories next door to nuclear power plants, so they can use the waste steam, but so far this has not happened. Power company generators are so large, and they generate so much waste steam, you have to find an equally large application. There would not be much point to channeling a tiny fraction of the steam into one factory kiln.

Since gas turbines do not produce much pollution, and they are fully automatic and safe to operate, they are well suited for use as cogenerators. In Japan, privately owned gas-fired cogenerators are increasingly common in factories, shopping malls and office complexes. They produce so much energy that power company generation peaked in 1996 and has declined since then.¹³⁰ In the U.S., cogeneration has increased from 161 billion kilowatt hours in 1989 to 355 billion today, or 9% of all electric power.¹³¹ At the Cornell University campus, an 8-megawatt cogenerator converts 70% of the fuel into electricity or space heating.¹³² These megawatt scale cogenerators are only useful for a large, self-contained facility such as a shopping mall, office park, airport, university campus, or a densely populated city center.

The Department of Energy and a consortium of manufacturers are working on small gas-fired generators that go beyond combined-heat-and-power (CHP), to provide thermally driven air-conditioning as well.¹³³ A cold fusion version of this machine will be safe to install in basements and equipment closets, since it will produce no fumes, carbon dioxide or other gases. The nuclear

¹²⁸ United States Combined Heat and Power Association, <http://uschpa.admgt.com/>

¹²⁹ CMC Power Systems, Inc., <http://www.cmcpower.com/html/electricity/household.asp>

¹³⁰ Yomiuri, “Tokyo Electric Power Co. freezes new construction plans,” August 2, 2001.

¹³¹ Annual Energy Review 2002, Table 8.2c.

¹³² Cornell University, <http://www.sustainablecampus.cornell.edu/energy.htm>. The entire campus uses 55 megawatts of electricity, including a 1.1 megawatt hydroelectric generator.

¹³³ Petrov, A., *et al.*, *Study Of Flue Gas Emissions Of Gas Microturbine-Based CHP System*, Engineering Science and Technology Division (ESTD), Oak Ridge National Laboratory (ORNL), Oak Ridge, Tennessee

products from the reaction will remain in the sealed cell, until the cell is recycled. They will be suitable for use everywhere, including cities, suburbs, remote cabins and third-world villages.

First-generation cold fusion generators will probably resemble the advanced microturbine generators now under development at the Department of Energy, GE, Capstone, Ingersoll-Rand and other industrial companies. (See Chapter 2, section 2.) These are remarkably efficient cogenerators that produce 25 kW to 500 kW. They cost only about \$500 per kilowatt of capacity, and they run for 15 months between major overhauls.¹³⁴

Cold fusion generators will likely be cogenerators, even though the fuel cost will be zero and there will be no need to conserve fuel. This is described in the next chapter.

A tremendous amount of energy is lost from centralized power plants in the United States. This diagram from the *Annual Energy Review 2000* tells the story. It shows overall electricity flow, measured in quadrillion BTU (quads):

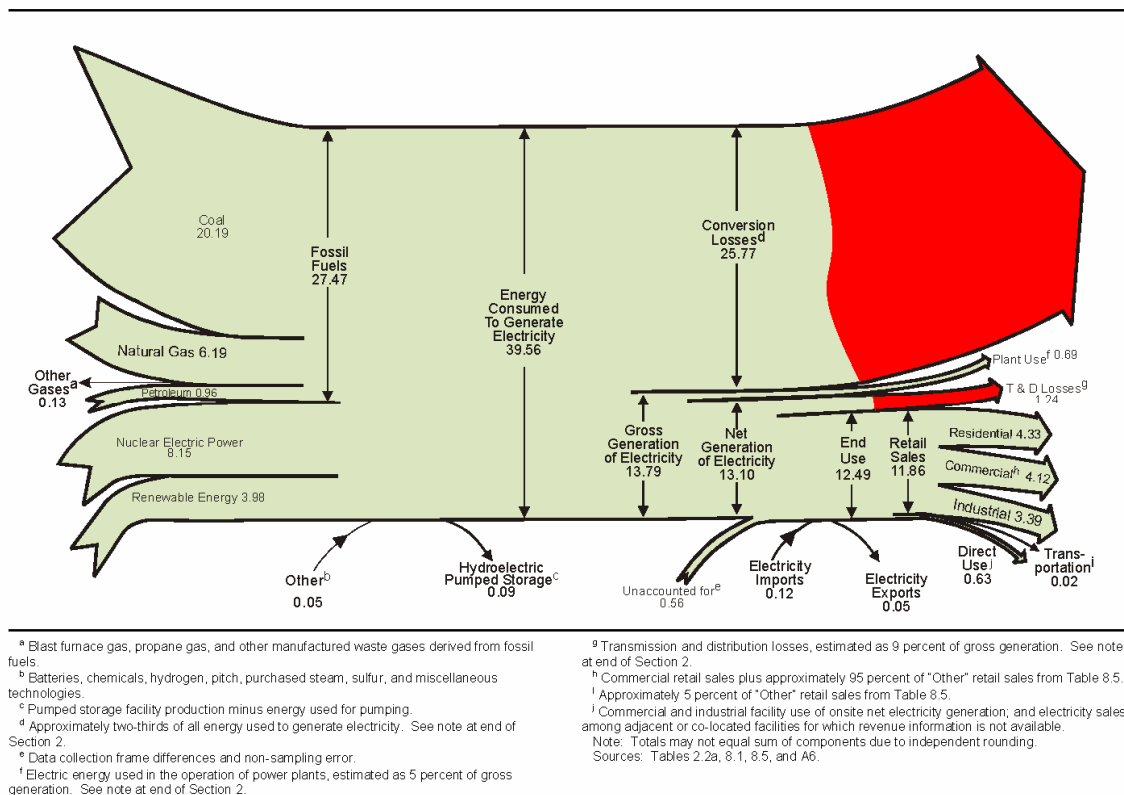

Diagram 14.1. Electricity Flow, 2002 (Quadrillion BTU – Quads). From *Annual Energy Review 2002*. 2003, Energy Information Administration, U.S. Department Of Energy. <http://www.eia.doe.gov/emeu/aer/>, p. 219. Wasted energy is shown in red. (Red color added by J. Rothwell.)

Twenty-six quads of energy — or 65% of energy used to generate power — is wasted in “conversion losses,” and another 1.24 quads are lost in transmission and distribution (T&D). This is the energy we could tap with cogeneration. The waste heat from conversion losses would be used for space or process heating, and the T&D losses would be eliminated because a cogenerator is located next to the building that uses the energy. More energy is lost in conversion

¹³⁴ U.S. Department of Energy, Microturbines Program, http://www.eere.energy.gov/de/program_areas/det_microturbine_prgm.shtml

and T&D than we derive from all the coal consumed in the U.S. (Coal produces 20 quads for electricity, and 3 quads directly for industry, mainly blast furnaces.) To put it another way, these wasted 27 quads equal 7% of all energy consumed worldwide. This is a high price to pay for centralized power generation.

2. What the Power Company Does, and Why We Will Not Need to Have It Done with Cold Fusion

As noted above, thanks to the power company you share generator capacity with everyone else in your city. You only use electricity when you need it, so the equipment costs you less than it would if you purchased your own generator. Power companies provide other benefits and vital services: They shuttle power from one location to another as demand fluctuates. They perform emergency repairs when storms damage the power lines. These jobs will become superfluous with cold fusion. Every house and factory will have all the capacity it needs, and there will be no power lines. One of the most demanding jobs power companies do is to synchronize the alternating current output from every generator on the grid, so that the sine wave peaks match. The 2002 northeast power failure was the worst in U.S. history mainly because recovery was delayed in some locations for a day or two. The delay was caused by the difficulty of synchronizing generator sine waves during startup, and bringing disparate generators online together, perfectly coordinated. When all buildings generate their own electricity, there will be no need to synchronize generators. The power will probably be direct current (DC) instead of alternating current, anyway. The main advantage to alternating current is that it can be sent over long distances efficiently. When the generator is in your basement, the power might as well be DC, since most common modern devices such as televisions and computers require DC in any case, and DC is somewhat safer, being less likely to electrocute people.

Some observers have suggested that even with cold fusion it might be economical to share electricity. A home generator might contribute electricity to the grid during the day, and borrow it from the office generator at night. In California, power companies are obligated to buy excess electricity generated by home solar cell arrays. Since we already have a grid in place, this might be economical, especially if first-generation cold fusion generators are expensive, as seems likely. A household may need 15 to 20 kilowatts during peak hours, when the washing machine and home theater are running full blast. If cold fusion generators cost \$1,000 per kilowatt of capacity, it might make sense purchase a 10-kilowatt generator, and to buy extra electricity from the power company grid during peak hours. But present day standby generators for houses cost only \$350 per kilowatt. If cold fusion generators are as cheap as this, you might as well buy a 20-kilowatt model.¹³⁵ You would never have to worry about running short, and you would not have to deal with the electric power company.

¹³⁵ Centurion Home Standby Generators, <http://www.centuriongenerators.com/>



Fig. 14.2. A 7-kilowatt standby generator installed outside of a house, next to the air-conditioner. A 20-kilowatt cold fusion generator will be roughly this size. Photo by D. Kontac in product review on Amazon.com.

What the power company does is analogous to computer “timesharing” — a technology that came and went in the 1960s and 70s. In 1979, a minicomputer with a 12-megabyte hard disk and 64 kilobytes of RAM cost \$32,000. It was cost effective to attach three or four terminals to the minicomputer, and have three or four employees share same processor (CPU) and hard disk simultaneously. Hundreds of terminals were connected to larger mainframe computers. These mini and mainframe computers were carefully designed to divvy up the resources reliably. They would coordinate and prevent one user from monopolizing the machine or causing a problem. The computer operating system would keep running even when an individual program crashed, or the computer terminal hardware failed. Today, the power company does the same kind of job minicomputers once did. It regulates and allocates a scarce resource. It gives you a tiny share of a gigantic centralized machine. When something goes wrong, any time in the day or night, power company experts fix the problem. Nowadays, individual personal computers have replaced nearly all mini and mainframe computers, because computing power is no longer a scarce resource. The 12-megabyte disk would now cost a tenth of a penny, so we no longer bother to divide it between four people. Computers have become a do-it-yourself proposition. You buy one at the office supply store along with a coffeemaker and pads of paper. Everyone has his own computer, with its own hard disk, and — unfortunately — everyone must be his own expert. When something goes wrong you are on your own. This is why mainframe computers are still used for some critical applications. The computers themselves are less cost effective than microcomputers, but they are still run by experts, who jump to it and fix problems. Perhaps in the future there will still be 50-megawatt power plants run by experts for critical applications in large complexes such as university campuses, military bases or shopping malls.

Cold fusion will eventually make power so cheap, electric companies will be trying to sell a commodity that is essentially worthless, like selling water by the river.

Some authors have suggested that power companies will survive because people do not want to be their own experts when it comes to electricity. It is bad enough having to fix your own computer! Samuel Florman fears that home generators may not be reliable. He wrote: “We all resent the electric and phone companies but, when service is interrupted, a competent crew

arrives on the scene to set things right. It is easy to say that solar collectors or windmills in our homes will be serviced by our independent neighborhood mechanic, but this is a prospect that must chill the blood of anyone who has ever had to have a car repaired or tried to get a plumber in an emergency.”¹³⁶ Florman does not live in Atlanta, Georgia, where winter ice storms sometimes knock out the electricity for hours or days at a time. A repairman from Sears comes to fix appliances or replace a water heater almost as promptly as the electric power company shows up, and he is summoned less often. Since cold fusion generators will be critical, heating and air-conditioning companies might offer rapid replacement swap-out service, the way automobile dealerships offer loaner cars. Should first-generation cold fusion generators turn out to be somewhat unreliable, it might be reasonable to install two, each with about half the maximum capacity you need. Contractors today recommend this configuration for furnaces in some houses.¹³⁷ In any case, cold fusion generators will not be repaired by “independent neighborhood mechanics.” They will be high-tech devices with no user serviceable parts inside. When one stops working, a do-it-yourself homeowner will go to Sears and buy a sealed replacement module.

Power companies will not find ways to substantially reduce the cost of maintaining the grid. They are experts already. They have been dealing with high-voltage pylons, poles, transformers and wires for 120 years. Cold fusion will rapidly reduce the cost of generating electricity, but little more can be done to reduce the cost of distributing electricity over a network.

Hydroelectric and wind turbines will also be obsolete. They can only be located in certain geographical areas, usually far from cities, so we must have the grid to bring the power where it is needed. Cold fusion can be used anywhere.

If we did not already have a distribution grid, and if it were not already paid for, it seems unlikely we would build one from scratch. It would be cheaper to construct small local grids, district heating with cogenerators, and low capacity interconnections between local grids. This would reduce the need for high voltage power lines, which are ugly and destructive. Some people suspect they cause health problems. The evidence for this is weak, but there is no question power lines wreak havoc on the environment and wildlife. Millions of trees are cut to clear a major power line right-of-way, and chemical defoliants (or flocks of sheep) must be used to keep the trees from regrowing.

3. Cold Fusion Will Reduce the Cost of Electric Power By Two-Thirds

Electricity has three major cost components: fuel, generating equipment, and the distribution grid (power lines and substations). The three components happen to be roughly equal: each is about a third of your electric bill. Thus, in principle, extremely cheap fuel or zero cost fuel should shrink your electric bill by about a third. In practice, even though we have discovered some ultra cheap fuels such as uranium, and some completely free ones such as wind and sunlight, they have not yet dramatically reduced the cost of electricity. The problem is we have

¹³⁶ Florman, S., *Blaming Technology*. 1981: St. Martin's Press. p. 86

¹³⁷ My house, for example. The heating contractor recommended we install two small gas furnaces instead of one large one, because the house is narrow with the bedrooms at one end, so only one heater is needed at night. The equipment is a little more expensive, but it is more economical to operate, and on the rare occasions when one heater breaks, the other keeps the house warm enough, and we do not mind waiting until the repairman shows up.

not yet found a cheap fuel that happens to work well with cheap generators. Sunlight is free but photovoltaic chips are expensive. Wind costs nothing, but wind turbine generators are still expensive (although they are getting cheaper every year), and wind is spread out over a large area, so it requires a large grid. Uranium is inexpensive but dangerous, so it requires elaborate safety equipment and containment buildings. Most of the money you save on uranium fuel is lost in the expensive nuclear power plant. Coal is cheap, and the nominal cost of a coal generator is low, but the savings are mainly accrued by passing costs onto the unwary public, killing over ten thousand people a year and ruining health and property, according to the Environmental Protection Agency.¹³⁸ Coal gasification would eliminate many of these problems, making coal as clean as natural gas, and it would extract more electricity from each ton of coal, but the power plants would be more expensive. At present, natural gas has the best balance of moderate fuel cost, low pollution, and moderate generator plant cost.

Cold fusion fuel, deuterium, is so cheap it is virtually free. It appears to be perfectly safe, so you might as well use it on a small scale, in houses, shopping malls and factories. This will gradually eliminate the need for the grid, until it falls into disuse and is scrapped, eliminating another third of your electric bill. Obviously, by this time the power company itself will be bankrupt, having no purpose and no customers. The only expense left would be for equipment. Cold fusion will gradually whittle away at this remaining third. It will reduce the cost of all heat engines, including generators, automobile and aerospace engines, air conditioners and so on, for three reasons:

1. First, with most heat engines, you can trade off energy efficiency for low equipment cost. Cool, low-pressure steam causes less wear and tear on pipes and turbines. Because uranium fuel is cheap, most nuclear power reactors are run at cooler, relatively inefficient temperatures.
2. Most primary energy consuming machines have no direct consumer appeal, and no way to differentiate between product offerings. A water heater has few features, options, or bells and whistles. It does only one thing. No one cares how it looks. Cold fusion equipment manufacturers will have only one way to compete and attract customers: optimize for the lowest lifetime equipment cost.
3. When a major cost component decreases — the cost of fuel in this case — that opens up business opportunities to innovate and reduce other cost components. As explained in Chapter 7, cheap microprocessors spurred the development of inexpensive hard disks. Mass produced automobiles opened the market for improved, cheaper tires. Unfortunately, as noted above, with electricity, technical glitches have prevented this happy synergy so far: cheap uranium fuel only works with expensive reactors; zero-cost solar power only works with expensive photovoltaic chips. With cold fusion, the laws of economics should operate normally, and cheap fuel will encourage the development of cheap engines.

Thus, cold fusion will eliminate two thirds of the cost of electricity (the fuel and grid), and it will reduce the final third (equipment).

¹³⁸ Schaeffer, E.V., Director, Office of Regulatory Enforcement, Environmental Protection Agency, letter of resignation protesting lax enforcement of antipollution laws, March 1, 2002, <http://www.grist.org/news/muck/2002/03/01/>

People may try to use cold fusion to prolong the life of obsolescent machines and doomed industries, such as the oil, gas, and electric power companies. They may succeed for a while. Perhaps there will still be a few oil wells 30 years after cold fusion cars are first sold, with pumps powered by cold fusion. In 1819, a steamship crossed the Atlantic for the first time. In 1839, regular North Atlantic steamship passenger service began. Despite the growing competition from steam, sailing ships achieved a final heyday in the clipper ship era from the 1840s to the 1860s. Sailing ship builders survived by borrowing from the rival technology that was gradually strangling their business. Clipper ships employed the latest improved marine engineering, and steam tugboats were essential to their operation. The clipper was so “extreme” (long and unwieldy) that in the harbors of London and New York it needed a steam tugboat to leave dock, maneuver in a tight channel, and reach the open sea before setting sail. Steam engines first prolonged the age of sail, and then slowly brought it to an end. This is analogous to a slide rule manufacturer using a computer to lower the cost of production, or the Post Office selling stamps over the Internet. People may try to prop up the electric power companies by developing large, central power generators with cold fusion in place of coal or fission. In the long run they will fail, but for a few decades they may provide society with the cheapest power possible.

15. At Home with Cold Fusion

Most energy is used in industry and transportation, but a substantial fraction, 22%, is used at home:

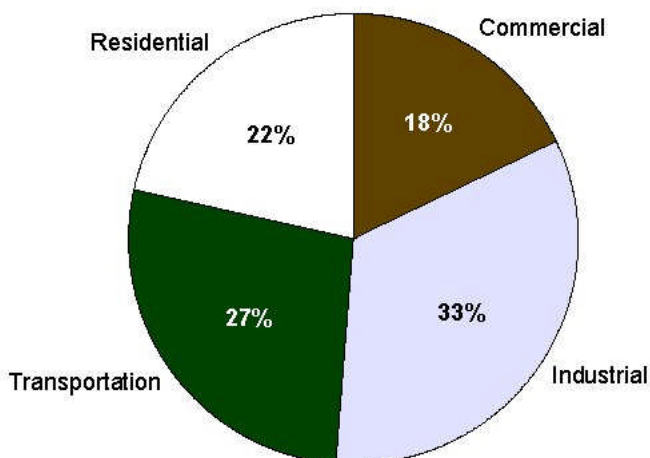

Figure 15.1. End use sector shares of total U.S. consumption, 2002. From *Annual Energy Review 2002. 2003*, Energy Information Administration, U.S. Department Of Energy. <http://www.eia.doe.gov/emeu/aer/>, p. 36.

Total U.S. energy costs in 2000 were \$703 billion, or \$2,499 per person.¹³⁹ This includes the energy used by industry, the military, farmers and so on. For the average household of 2.59 members¹⁴⁰ it works out to be \$6,472. From a family's point of view, most energy expenses are indirect: taxes pay for the energy used by the government and the military; the grocery bill pays for the fuel farmers use. Families pay directly for a large share of Transportation (gasoline) and Residential energy (natural gas and electricity used at home). The latter cost the average household \$1,338 in 1996.¹⁴¹ Here is a breakdown of costs, in a graph published by the U.S. Energy Star program:¹⁴²

¹³⁹ *Annual Energy Review 2002. 2003*, Energy Information Administration, U.S. Department Of Energy. <http://www.eia.doe.gov/emeu/aer/>, p. 13, year 2000 data

¹⁴⁰ U.S. Census Bureau, <http://factfinder.census.gov>. The average household size should not be confused with the average family size, which is 3.14. Not all members of a family live in the same household.

¹⁴¹ DOE/EIA-0632 (97), *A Look at Residential Energy Consumption in 1997*, November 1999, DOE/EIA-0632 (97), <http://www.eia.doe.gov/pub/pdf/consumption/063297.pdf>, p. 1. The numbers have not changed much since 1996.

¹⁴² Energy Star program, http://www.energystar.gov/index.cfm?c=products.pr_pie

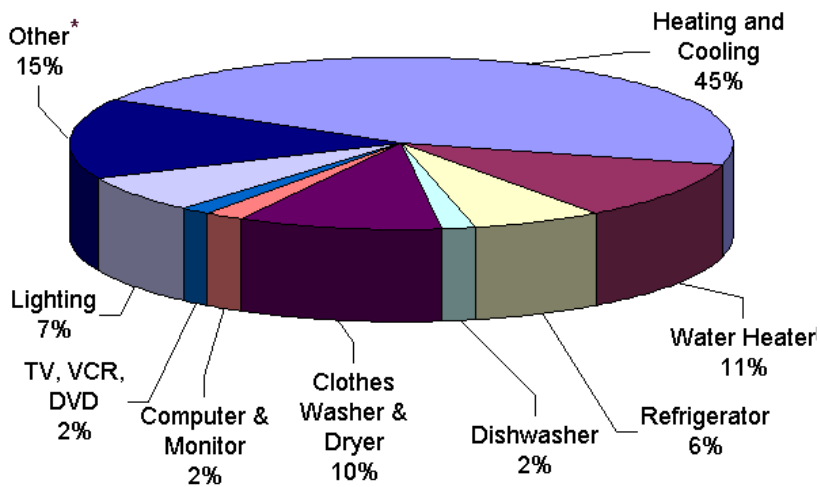

* "Other" represents an array of household products, including stoves, ovens, microwaves, and small appliances. Individually, these products account for no more than about 2% of a household's energy bills.

Figure 15.2. Breakdown of household energy costs, from the Energy Star program.

Since we are all familiar with how we use energy at home, let us take a closer look at the Residential energy sector, and think about how it will change with cold fusion.

This pie chart shows cost, not units of energy. Most energy for Heating and Cooling comes from natural gas, which is cheaper than electricity. Electricity is used for things like Lighting and Dishwashers. We spend 45% of the money on Heating and Cooling, but it buys 55% of the energy.

With cold fusion, much of the energy we consume as electricity will be supplied directly as cold fusion heat, instead.

In today's houses, air conditioning and most refrigerators are electric. Clothes dryers and water heaters are often electrically heated, and in a few houses, even the central space heater is an electric resistance heater. This is terribly wasteful. Electricity is high-grade energy. It is much more economical to heat with gas, or in mild climates, with an electric heat pump. A clothes dryer heated with gas is more economical than an electric one, but only 16% of U.S. dryers are gas fired,¹⁴³ perhaps because people seldom have a gas line running to their dryers. When you heat or dry clothes with resistance electricity, and your electric power company uses a gas-fired generator, you end up losing two thirds of the initial energy between the power generator and your house, whereas when you burn the gas at home with a modern gas furnace, you lose than 10% as waste heat from the chimney.

Cold fusion home generators would have to produce 40 or 50 kilowatts of electricity to supply all of the energy used for heating and cooling as electricity. Since a home generator will be less efficient than a central generator, it would have to produce up to 200 kilowatts of raw heat,

¹⁴³ DOE/EIA-0632 (97), *A Look at Residential Energy Consumption in 1997*, November 1999, <http://www.eia.doe.gov/pub/pdf/consumption/063297.pdf>, Fig. 2.19.

which is as much as an apartment building furnace (700,000 Btu/h). It would be a large, expensive, and dangerously hot machine.

Fortunately, there will be no need for so much electricity. Ten kilowatts should be enough, even for a large house, because most of the energy shown in the pie chart is for heating and cooling, which can be done with cold fusion heat instead of electricity.

Stoves and ovens can be powered by cold fusion. Some cooks may prefer stoves or barbecue grills powered by hydrogen gas generated with cold fusion, perhaps mixed with carbon or some other gasses to make it visible, for safety. The refrigerator will have its own cold fusion heat source. Gas fired refrigerators have been sold since the 1930s. They are rugged, durable, and economical. Only the light inside the refrigerator needs to be electric.

The DoE publication *A Look at Residential Energy Consumption in 1997*¹⁴⁴ shows total residential site energy use in 1997 was 101 million Btu, or 29,600 kWh (kilowatt hours). This is for all types of energy including electricity, natural gas, heating oil, firewood and so on. These energy sources are measured in different units, but the DOE authors converted them to Btu, and I converted Btu to kilowatt-hours. “Site energy” means the energy actually expended in and around the house. Power plants expend an additional 61 million Btu (17,877 kWh) of waste heat when they generate the electricity consumed by the household. So, the total energy consumed by the average household is 29,600 kWh on-site plus 17,877 kWh off-site waste heat, or 47,477 kWh total. Cold fusion will reduce overall energy expended per household down to roughly 30,000 kWh.

The 29,600 kWh used on site is broken into four categories: Space Heating, Air Conditioning, Water Heating, and Appliances (including lighting):

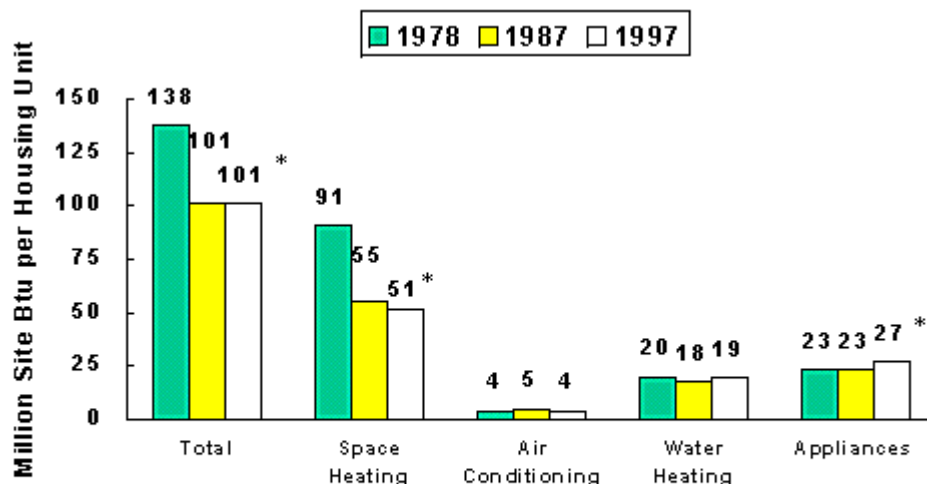

* The difference between the 1978 and 1997 estimates is statistically significant at the 95-percent confidence level.

Sources: Energy Information Administration; 1978, 1987, and 1997 Residential Energy Consumption Surveys.

Figure 15.3. Site energy consumption per US housing unit by total and end use, 1978, 1987, and 1997. DOE/EIA-0632 (97), Fig. 2.8.

¹⁴⁴ DOE/EIA-0632 (97), *ibid.*

Let us divide the total energy from 1997, 29,600 kWh, into these four principal end use categories, while we separate the categories into those that can use cold fusion heat directly, and those that will need electricity generated from cold fusion.

Table 15.1. 29,600 kWh divided into four principal end uses

	kWh	Percent
Direct with Cold Fusion		
Space Heating	14,947	50%
Airconditioning	1,172	4%
Water Heating	5,568	19%
Total:	21,687	
Electric from Cold Fusion Generator		
Appliances	7,913	27%

Another part of the DoE document (Table 3.1) breaks out the energy used by some appliances. The average refrigerator in 1997 used 1,141 kWh, and the average house has more than one refrigerator, so the total energy consumed by refrigerators per household comes to 1,323 kWh. The average household clothes dryer uses 1,090 kWh. Today, it makes sense to lump refrigerators and dryers together with other appliances, because they are usually powered by electricity. But in the future they will run directly with cold fusion heat, so let us break them out and move 2,413 kWh (8%) up to the “Direct with Cold Fusion” category:

Table 15.2. 29,600 kWh divided into five principal end uses, with Refrigerator & Dryer added to the Direct category.

	kWh	Percent
Direct with Cold Fusion		
Space Heating	14,947	50%
Airconditioning	1,172	4%
Water Heating	5,568	19%
Refrigerator & Dryer	2,413	8% ← move up
Total:	24,100	
Electric from Cold Fusion Generator		
Appliances	5,500	19%

Thus, a cold fusion electric generator that produces 5,500 kWh per year would supply all of the appliances that must use electricity.

The biggest single use of energy at home is for space heating, at 14,947 kWh per year. Space heating calls for mild, low temperatures: 30°C warm air. And this is just what an electric power generator produces in huge quantities. To produce 5,500 kWh the generator will throw away 16,000 ~ 22,000 kWh of waste heat. We can use this to heat the house, the same way we heat the passenger compartment in a car. When you drive in winter, you move a lever, which opens a baffle and directs a stream of fresh air across the hot engine block into the passenger compartment. A cold fusion generator will have a similar baffle that will direct warm air into the house in winter, or up a chimney in summer. The baffle plus a blower and a thermostat is all you need to make the generator into a cogenerator (an all-in-one generator plus space heater furnace).

This extra equipment will take up little space and cost practically nothing, and it will eliminate the need for a separate furnace. If the 22,000 kWh of waste heat is not quite enough to keep the house warm, the cogenerator can be set to produce only heat, and no electricity. It might do this during a winter night when the lights are out. All cold fusion generators used in buildings or houses should be cogenerators.

Ideally, the cogenerator would produce 5,500 kWh electricity plus 22,000 kWh of heat, or around 27,500 kWh total, compared to the 47,477 kWh consumed today. Because the cogenerator may need to generate heat at night when electricity is not needed, it will probably produce about 30,000 kWh. It is ironic that cold fusion will probably cut overall energy consumption by a wide margin. We will not need to conserve energy to save money or reduce pollution, but it will probably be a good idea to conserve anyway, since we will use much more energy overall, in megaprojects. (See Chapter 4, Section 4.)

There are 8,760 hours per year, so averaged throughout the year, the 24,100 kWh of direct heat applications (heating, air conditioning, water heating, refrigerator & dryer), consume a constant 2.8 kW (kilowatts). But this average has little meaning. Heating is only needed in wintertime, most often at night. Air conditioning is only used in summer, mainly during the day. Actual heat energy consumption during any given hour may be 5 or 10 times higher than this average. The average electric power demand is only 0.6 kWh, but actual demand is likely to be much higher during some hours of the day. Most appliances and lighting are turned off late at night, or when no one is home on a weekday, but on Saturday morning in a busy household the television, the washing machine, the hairdryer, the computer and most of the lights are likely to be on, and these draw 5 or 10 kW total. When a clothes washer or light is turned on, it draws a brief burst of electricity. This transient peak can be met with a battery pack, but a battery soon drains, so the cold fusion generator will have to supply enough to meet peak demand when all these machines are running at a steady pace. That should take roughly 10 kW.

This analysis shows why it would be a losing proposition to equip a house with a cold fusion generator, and then use the electricity to run today's appliances. This is especially true if you use electric resistance space heating; as we mentioned above, you might need up to 50 kW of capacity. It would be cheaper to wait until your furnace needs to be replaced, and then buy a 10 kW cold fusion cogenerator, plus a cold fusion clothes dryer and air-conditioner. Replacing these three appliances would eliminate most of the demand for heavy-duty peak electricity. You might decide to keep your old electric refrigerator. A refrigerator uses more electricity than a dryer over the course of a year, but the dryer uses much more during the time it is turned on.

As cold fusion becomes more common, your home generator will have less work to do. The first cold fusion clothes dryers will have a cold fusion heating element, but it will still need an electric motor to spin the tumbler. (A gas fired clothes dryer needs an electric motor for the same reason.) Presumably it will plug into the house wiring to run the motor. This will not be much of a burden on the home generator, because the motor uses much less power than the heating element. However, as cold fusion thermoelectric batteries and other heat engines improve, and as designers grow familiar with them, they may decide it would be more convenient to have the entire dryer power itself. Conceivably they could use a Stirling engine to mechanically rotate the tumbler, but a thermoelectric battery with an ordinary electric motor seems more practical. The waste heat from the thermoelectric battery will help dry the clothes.

Many factories use electric resistance power for process heating (such as machines that melt plastic), and in things like ovens to bake bread. Cold fusion heat will be used directly, instead.

If high-efficiency thermoelectric devices can be perfected, eventually all appliances, light fixtures, computers and other machines will power themselves. Suppose efficiency reaches 80%, which some experts believe is possible. There would be little waste heat. A desktop computer needs about 160 watts of electricity, so it would generate 200 watts of thermal power and convert 80% of it into electricity. It would dissipate only a little more heat than today's computer does. It would not need to be plugged into the wall. The home generator itself would no longer be needed, and there would be no electric wires in the walls of houses.

16. Population, Pollution, Problems with Land and Agriculture

Even with cold fusion, the fight against worldwide poverty and environmental destruction will not be won unless we bring population growth under control. Cold fusion can help bring health, food, prosperity and a decent life to all 6 billion people now on earth. But I doubt any technology can support 10 or 20 billion people on earth, and even if it could, the damage to the ecosystem would be tragic. Fortunately, progress has been made in reducing the population boom. The rate of growth has declined, although the actual number of people born each year is still at record highs, and population growth in the third world is still out of control. The solutions are clear. Three steps are essential, and all three are desirable for many other reasons:

1. We must improve education and job opportunities, especially for women.
2. We must improve health care, with a special focus on the reduction of infant mortality. Poor people have many children often because they are afraid some will die. If parents can be assured that nearly all children will survive to adulthood, many will have fewer children.
3. We must provide old-age pensions. Many poor people have children so that they will have someone to support them in their old age.

Reducing population will reduce pollution. The two problems are linked, obviously. All else being equal, the more people there are the more pollution they cause. But all else is never equal. The amount of pollution produced per capita, and per dollar of GDP, can vary tremendously. In most nations, including the U.S., there is still scope to reduce it dramatically.

In the 1960s, air pollution in Japan was horrendous, because population density was high and Japan was experiencing unprecedented prosperity and unbridled industrial growth. In Tokyo, a day when you could see Mount Fuji was so rare, it might be mentioned in the local news. The rivers stank from blocks away. Pollution and environmental destruction reached a nadir in the incidents at Minamata and Yokkaichi, with deaths by disease, mercury poisoning and suicide. Lawsuits were finally decided in favor of the plaintiffs, and the judges held both corporations and local governments responsible. The nation demanded tough environmental regulations and reform.

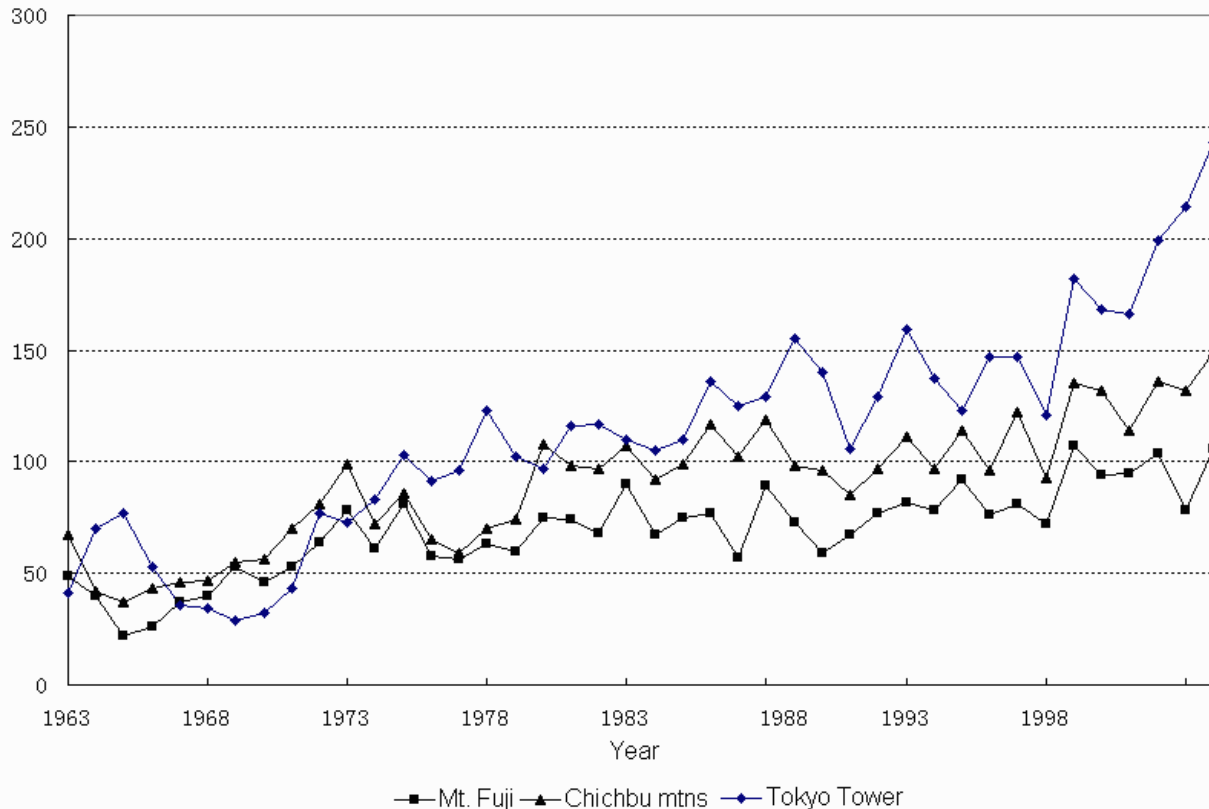

Fig. 16.1. Annual change in daily range of visibility. From the Kichijouji district in downtown Tokyo, the visibility of Mt. Fuji, the Chichibu mountain range, and Tokyo Tower. The y-axis shows the number of days per year in which these objects were visible at 9:00 a.m. Source: Seikai University, Meteorological Observatory, http://www.seikei.ac.jp/obs/pwork/tower_j.htm

Nowadays, you can see Mount Fuji from Tokyo whenever the natural weather is clear, and the rivers in the middle of Tokyo are teeming with more healthy fish than there have been since the 19th century. Yokkaichi has been cited by the U.N. as one of the cleanest industrial cities, and a model for development.¹⁴⁵ The municipal web site relates with pride the story of the pollution, the trial and the recovery.

¹⁴⁵ NHK documentary series, "Navigation Toukai," *Yokkaichi kougai kara no messeiji* (Lessons learned from the pollution at Yokkaichi), September 20, 2004.



Figure 16.2. Yokkaichi, Mie prefecture, in the 1960s and today. The petrochemical refinery in the foreground caused some of the worst pollution on record. From the municipal web site devoted to the history of Yokkaichi's pollution, <http://www.city.yokkaichi.mie.jp/kankyo/kogai.htm>

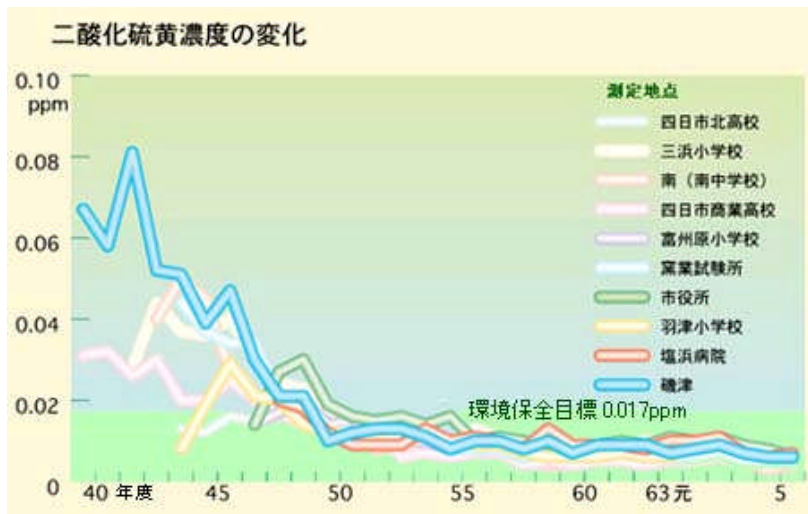

Figure 16.3. The sulfur dioxide concentration levels at Yokkaichi from the 1960s to the present, measured at various locations in the city. The environmental target is 0.017 ppm, shown in the green bar at the bottom of the graph. The peak was in 1967 (Showa 42).

In the mid-1960s, the smoke and grit were so bad, the children were constantly coughing and afflicted with sore throats and asthma. The government decided it was the children's problem. It installed communal sinks in the local schools, and ordered the children to line up in groups daily to wash their faces and gargle to clear their throats, following the instructions on large wall posters. The communal sinks are no longer needed, but the sinks and the posters have been left up as a reminder of how bad things once were. Today school children watch newsreels of their predecessors, and they perform historic reenactments: they line up in groups to wash their faces and gargle, as they try to imagine what it must have been like.¹⁴⁶

¹⁴⁶ NHK, "Navigation Toukai," *ibid.*



Figure 16.4. In the 1960s, the Japanese government decided that pollution was the victim's problem. It installed communal sinks in the local schools, and ordered the children to line up and gargle to clear their throats. A teacher is shown instructing the children on how to gargle properly. Today the communal sinks have been left as a reminder of how bad things were, and students perform historic reenactments. From: NHK documentary series, "Navigation Toukai," *Yokkaichi kougai kara no messeiji* (Lessons learned from the pollution at Yokkaichi), September 20, 2004.

Air and water pollution in Japan declined even though the population remained steady. (Actually it increased slightly, and it is more concentrated in urban areas than it was 40 years ago.) Japanese factory engineers did not discover a secret high-tech panacea. The nation simply implemented and enforced commonsense legal measures, and encouraged cost-effective engineering.

There are still severe problems with pollution in Japan, particularly solid waste. Some experts feel that air pollution technology has fallen behind world standards after a promising start in the 1970s and 80s. Also the extensive and unnecessary boondoggle construction of rural roads, dams and riverbank concrete is one of the worst environmental horror stories in the world today.¹⁴⁷

We cannot radically cut pollution or prevent global warming by reducing the population a little, and it is unlikely we can cut population by half in time to prevent global warming. On the other hand, we could maintain the present population and still reduce pollution by a factor of 10 even without cold fusion. With cold fusion we could reduce it by 4 to 6 orders of magnitude. This will cost us nothing. On the contrary, it will save money, because pollution is defined as mislaid resources: it is valuable raw material that has been washed down a river where we cannot reach it, or lofted into the atmosphere and spread out evenly over millions of hectares. Half of the palladium produced today is used in automobile catalytic converters. A large fraction of this

¹⁴⁷ Kerr, A., *Dogs and Demons: Tales from the Dark Side of Modern Japan*. 2001: Hill and Wang.

metal is heated by exhaust gas, sublimated, and blown out of automobile tail pipes into the soil and water along highways and roads, where it becomes a toxic heavy metal health hazardous to humans, livestock, plants and wild animals. Palladium is a precious metal worth more than gold, but we manage to throw half of it away, converting a hard-won, desirable, marvelous material into poison spread so far and wide across the land we have no means of cleaning it up.

In the distant future, once population comes under control, pollution will be largely abated, and people everywhere will have access to as much education as they want, millions of people may want to migrate from the Earth to other planets. Eventually, 100 billion people may live spread around all the habitable moons and planets in the solar system. Levels of pollution on Earth will be so low, they will be difficult to detect. Industry — especially agriculture and heavy industry — will be moved to desert wastelands, or underground, or to the Moon. The continuing practice of outdoor farming should be our first target for change. It is the largest cause of pollution and serious environmental damage.

Pimentel & Pimentel describe the crisis in land use: “Iowa, which has some of the best soil in the world, has lost half of its topsoil after being farmed for about 100 years.”¹⁴⁸ “During the last 40 years, about 30 percent of the world’s arable land has been lost.” “Further contributing to diminished supplies of agricultural land are the vast acreages continually being lost to urban spread, industrial development, and roadways. For example, in the United States between 1945 and 1975 an area of agricultural land of the size of Nebraska was blacktopped with roadways and covered with homes and factories.” We must have houses, obviously. People have to live somewhere, and we prefer to live aboveground with a nice view. But roadways, factories, and above all agriculture are wasteful and obsolete. They consume far more land, water, energy, labor and money than they should.

The reliability, quality, and the effective use of space in agriculture have hardly improved since prehistoric times. Farmers sometimes lose their entire crop because of a drought or hard rain. Can you imagine any other modern industry losing a year’s worth of output because of such relatively minor weather conditions? Once in a long while, a hurricane might interrupt production at a factory or destroy goods in a warehouse. But a heavy rainstorm that would hardly be noticed in a factory may decimate production on a farm. That is absurd. People should never be at the mercy of the weather. They should never have to worry that locusts or rats might eat their food. Civilization should be beyond that sort of thing by now. We should manufacture our food in indoor, totally controllable production lines, like everything else we make.

1. Indoor farms or food factories

A greenhouse can be partially or totally isolated from the external environment, making it less susceptible to an infestation by insects. But a greenhouse still needs natural light, so in wintertime productivity is low. In Japan, the Cosmoplant Corporation has taken the next step, constructing completely enclosed, high-tech “food factories,” that grow lettuce from start to finish under artificial light and other tightly controlled man-made conditions.¹⁴⁹

¹⁴⁸ Pimentel, D. and M. Pimentel, *Food, Energy, and Society, Revised Edition*. 1996: University Press of Colorado, p. 154

¹⁴⁹ NHK documentary series, “Navigation Shizuoka,” *Hikari no gijutsu ga nougyou o kaeru* (How lighting research is changing agriculture), September 27, 2004

In 2004, Cosmoplant had four food factories in operation, and two more under construction. (Unfortunately, in 2007 the company declared bankruptcy. Perhaps it was ahead of its time.) The factories cost \$4.5 million each. They produce 5,000 heads of lettuce a day, which sell retail for ¥158 each (\$1.40), about the same as lettuce grown outdoors. The factories give grocery stores an assured supply of top-quality fresh lettuce year-round. Consumers like the lettuce, which is green, tender and wholesome because it is uniformly exposed to light and it is loaded with chlorophyll. They appreciate the fact that it is grown without the use of pesticides, in a clean environment. It is more “organic.” The reader should not imagine this is a bland factory food product, like the hard green tomatoes sold in American grocery stores that are bred to be picked by machine. Japanese shoppers have high standards. They demand tasty produce, blemish-free fruit, fish good enough to be eaten raw as sashimi, and fresh baked bread. They are willing to pay for good quality. A grocery store in a small American town may have only frozen food, flyblown fruit, canned goods, snack foods and beer, whereas in a Japanese village in the middle of nowhere you should not be surprised to find a delicious selection of fresh food.

Cosmoplant and other Japanese corporations are planning to build other food factories to produce tomatoes, strawberries and other high-value, seasonal cash crops that consumers would like to eat year-round at a fixed price.

The lettuce factory uses a lot of energy since the lettuce is grown under artificial light. But the lighting is carefully designed, and it uses much less electricity than conventional lighting would. A food factory with conventional fluorescent lighting would use so much electricity that even with cold fusion it would be impractical.

Outdoor farming is by far the most energy inefficient industry on earth. Crops growing outdoors in temperate climates photosynthesize and store less than 0.1% of the sunlight that reaches the ground year-round, mainly because they do not grow in winter. At first glance, the prospects for farming with artificial light seem even more dismal. A coal-fired or nuclear electric power generator is about 33% efficient, and large, first-generation cold fusion powered ones will probably be about the same. A conventional incandescent light bulb is only about 10% efficient, and a fluorescent or LED light converts about 30% of the energy into light. Overall, only about 10% of the cold fusion heat will convert into light, even with efficient lighting. With artificial white light and no seasonal variation, plants might photosynthesize one or two percent of the light. In other words, the plants would capture 0.2% of the starting heat energy; you would need 500 times more energy input with than the final nutritional (caloric) content of the food. Since a normal person should eat 1,200 kilocalories per day (5 megajoules), you would need 2,500 megajoules input heat per person per day, which is about 2.6 times more energy than Americans presently use for all purposes.¹⁵⁰ Americans consume far more energy than other people, so if everyone in the world eats a vegetarian diet of food grown with white fluorescent light, world energy production must increase by at least a factor of ten. (Meat production would increase it even more.) Even with cold fusion, this would be extremely costly, and it would create damaging waste heat.

Fortunately, this will not be necessary. Researchers at Cosmoplant Corp., Tokai University¹⁵¹ and elsewhere have pioneered methods that require much less energy input. For the first two

¹⁵⁰ *Annual Energy Review 2002*, p. xvii. Americans consume 338 million Btu/year per capita, or 0.9 million Btu per day. That equals 977 megajoules.

¹⁵¹ Tokai University, Plant Factory Laboratory, <http://www.c-living.ne.jp/pfl/index.htm>

weeks of growth, the lettuce seedlings are placed under white fluorescent lights. White light works best in the early growth stages. The factory must have room for 70,000 seedlings, but this does not take much room or many lights, because seedlings are small and packed close together. After the plants reach about 6 centimeters, they are transferred to a special growing room with 10 layers of trays on slow moving conveyer belts. This is where most plant growth occurs. The plants emerge ready for market two weeks later.

The trays are lit by red LED lights placed close to the plants. The LEDs produce pure red light at one of the wavelengths absorbed by plants, around 660 nanometers. Most of the red LED light is absorbed, unlike the white light from the sun or from a fluorescent light. Chlorophyll is green; therefore it absorbs red (450 nanometer) and blue (660 nanometer) light most readily (Fig. 16.6). It does not absorb green. The color of an object is the wavelength it reflects instead of absorbing.

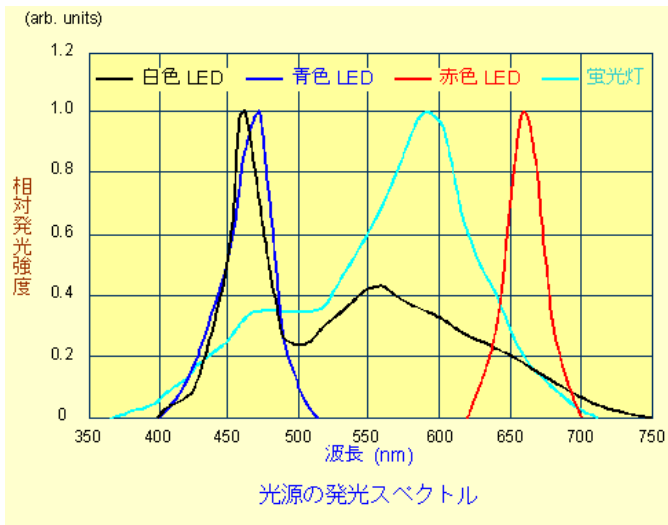

Figure 16.5. Light spectra from white (black line), blue (blue line) and red (red line) LEDs, and fluorescent lights (aqua line). Much of the fluorescent light is wasted, because it is not photosynthetically active radiation (PAR). Data courtesy M. Takatsuji, Dept. of Biology, Science and Technology, Tokai University, Plant Factory Laboratory.

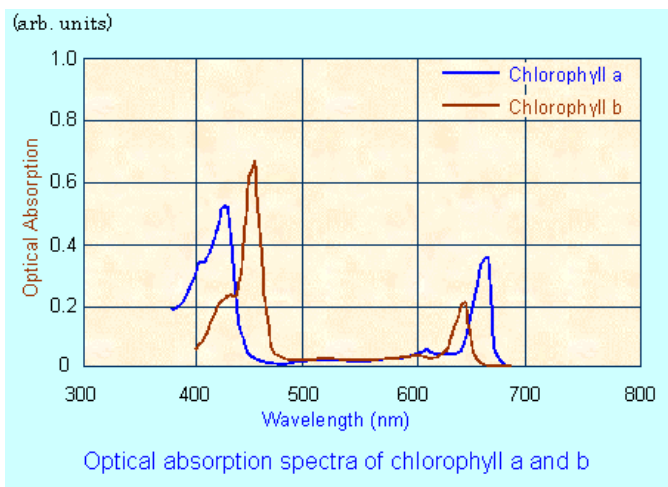

Figure 16.6. Optical absorption spectra of chlorophyll a and b. Light at these peaks is photosynthetically active radiation (PAR). The second set of peaks happens to be close to the output of red LEDs. Data courtesy M. Takatsuji, Dept. of Biology, Science and Technology, Tokai University, Plant Factory Laboratory.

The LED light fixtures are made of aluminum with cooling water channels built into them, to keep the LEDs cool. This makes them last more than 10 times longer than they normally do, and it means they can be brought close to the lettuce without damaging the leaves from heat, so less light is wasted.

On a farm, plants stop growing at night, but in the factory the lights stay on 24 hours a day, and photosynthesis is continuous. Growing conditions are optimized in other ways: The room has five times more carbon dioxide than the natural concentration. The temperature, humidity and the plant food are carefully monitored and kept at optimum levels. The factory is immune to drought, erosion, weather conditions and seasonal changes. The building is sealed against insects and bacteria, and workers wear clean uniforms like doctors and nurses in an operating room. On a farm it takes three months to grow lettuce, but in the factory it takes only a month: two weeks in the seedling room, and two weeks in the growing room.

There are 2 million LEDs in the lettuce factory. Today's bright red LEDs consume 125 milliwatts. The LED array consumes 250 kilowatts, or 6,000 kilowatt hours per day. This is about as much energy as a large tractor-trailer truck engine produces.¹⁵² A cold fusion generator the size of an ordinary office building heating, ventilation and air-conditioning (HVAC) system could supply the factory. (It would be much quieter than a tractor-trailer truck.) Assume that the 6,000 kilowatt hours of electricity convert into about 2,000 kilowatt hours of light energy. Divide that by the 5,000 heads of lettuce produced per day, and convert the result into kilocalories, which are the usual measure of energy in food. It comes to 344 kilocalories input light per head of lettuce. An average head of lettuce weighs 539 grams and supplies 54 kilocalories of food value, so the lettuce photosynthesizes roughly 15% of the light into food. In other words, it converts light into food energy about a hundred times more efficiently than outdoor agriculture.¹⁵³ Of course, with outdoor agriculture the light comes from the Sun, so it is free and nonpolluting, but we have already reached the limits of outdoor agriculture; half of the world's arable land is already farmed, so there is not much more sunlight left for us to tap.

Although man cannot live by lettuce alone, it should be noted that this factory produces enough food energy to supply 200 adults with the recommended daily allowance of calories.

Photosynthesis at the food factory is remarkably efficient, but the factory still consumes a terrific amount of energy. Conventional agriculture takes roughly 10 calories of fossil fuel to produce 1 calorie of vegetables.¹⁵⁴ When you take into account in the energy needed to generate electricity to light the LEDs, the ratio of fossil fuel or nuclear energy to calories of lettuce is 59:1. This is even worse than conventional meat production, takes 34 calories of fossil fuel to produce 1 calorie of food. The food factory probably does reduce other energy inputs such as farm machinery, insecticides, refrigerated warehousing and transportation. Farms are often far from towns and cities, whereas the food factory can be built close by towns, reducing transportation costs. On a farm, an entire field of lettuce all ripens at about the same time, so the lettuce has to be stored and sold over about a month, but the food factory produces a steady stream of lettuce every day year-round.

¹⁵² The Goodyear Tire & Rubber Company, *Factors Affecting Truck Fuel Economy*, http://www.goodyear.com/truck/pdf/radialretserv/Retread_S9_V.pdf

¹⁵³ This is a rough approximation, but I am glad to report that Dr. Ashida of the Tokai University, Plant Factory Laboratory, agreed it is reasonable. Source: A. Ashida, private communication.

¹⁵⁴ Pimentel, D. and M. Pimentel, *Food, Energy, and Society, Revised Edition*. 1996: University Press of Colorado, p. 192, 195.



a.



b.



c.



d.

Figure 16.7. a. The Cosmoplant Corporation lettuce factory. b. Seedlings growing under white fluorescent lights. c. Mature lettuce plants growing under red LEDs. d. Workers wear clean uniforms and plastic gloves while packing the lettuce. From: NHK documentary series, “Navigation Shizuoka,” *Hikari no gijutsu ga nougyou o kaeru* (How lighting research is changing agriculture), September 27, 2004

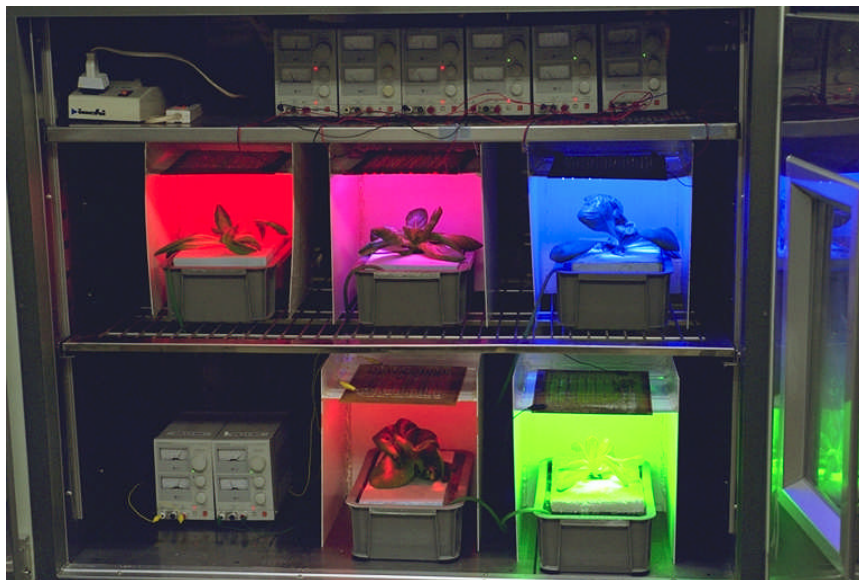

Figure 16.8. Experiments at Tokai University Plant Factory Laboratory growing plants under different colored LED lights. Photo courtesy M. Takatsuji, Dept. of Biology, Science and Technology, Tokai Univ.

The lettuce factory saves resources in other ways. As noted above, it eliminates losses to plant disease, vermin and weather. It saves a tremendous amount of land area, which is important in Japan, where land is expensive. Not only are the lettuce plant trays stacked up in shelves, the plants themselves are placed 8 times closer together than they would be in an outdoor field. Overall, the growing surface area in the factory is 10×10 meters (0.01 hectare), and it produces as much lettuce as a 20-hectare outdoor farm.

In the future, larger food factories may be the size of 40-story office buildings, with a hundred shelves. Perhaps they will grow even larger, to be as big as today's international airport terminal buildings (50 hectares), and as tall as our largest office buildings (400 meters). We could fit 300 shelves into them, giving a 50-hectare plant as much capacity as 3 million hectares of outdoor farms (7.4 million acres). They will be fully automated, staffed with robots, not people, so little space inside the building will be wasted on breakrooms, boardrooms or bathrooms. One or two of these factories could be constructed near a major city to supply all of the produce and grain the city needs, while processing and recycling the organic waste and sewage the city generates. Sewage treatment with high heat, high-energy cold fusion techniques will be far more hygienic than today's methods.

In the future, people will not want to buy food that has been touched by human hands or exposed to insects or harmful bacteria. On the other hand, they will probably not think twice about eating food and drinking water that was sewage a few months earlier. That is what we do already, although we do not like to think about it.

Equipped with Cosmoplant light fixtures, a giant, 50-hectare factory would consume fantastic amounts of power: about 750 megawatts per hectare. It seems unlikely the waste heat could be removed. However, LED lighting efficiency is expected to improve soon, and researchers at Tokai University are working on ways to conserve energy and reduce heat by using pulsed, intermittent light. Still, the factory might require as much electricity as five or ten of today's nuclear power plants generate, and all the food factories in the world might consume more electricity than we presently generate. The generators will cost hundreds of billions of dollars. Even though the fuel will cost nothing, we will still need efficient generators and lights.

It would take prodigious amounts of energy to produce meat with indoor farming, because an animal raised for food eats at least 10 times more than it produces. Fortunately, an alternative is already emerging. At the New Harvest nonprofit organization, researchers are developing "cultured meat," that is, meat from animal tissue grown in vitro, as cell cultures instead of in live animals.¹⁵⁵ Not only would this reduce energy, it would eliminate many other problems with meat, such as diseases from the over consumption of animal fats, meat-borne pathogens, antibiotic resistant bacteria caused by the routine use of antibiotics in livestock, pollution from animal waste, and the cruel warehousing and slaughter of millions of intelligent animals such as cows and pigs.

At present 1.5 billion hectares of arable land is used to grow food worldwide. (Other arable land is devoted to forestry, biomass for fuel and other uses.) This comes to 0.27 hectare per person. This land could be replaced with a thousand giant food factories, which would take up about 60,000 hectares, a little less than greater New York City. Actually, I hope these factories take up zero hectares of land. I would build them underground, located conveniently nearby

¹⁵⁵ New Harvest nonprofit research organization, <http://www.new-harvest.org/default.php>

major cities, or perhaps directly underneath most cities and towns. We will use the land above them for living space or parks. Perhaps the factories can be miniaturized so that every neighborhood grocery store has one directly underneath it, with pipes running to the central sewage processing plant to bring in sterile fertilizer and water. Lettuce, strawberries, melons and other produce will be picked by robots when perfectly ripe, and placed on the store shelves for sale minutes later.

In the distant future, food may be synthesized directly from raw materials, instead of being grown. This will take even less space and energy. It will lower the cost of food by orders of magnitude, and ensure that people everywhere have as much to eat as they want. I do not mean machines will make synthetic glop with artificial food coloring, or tofu-burgers that vaguely resemble meat. The copies will be physically and chemically indistinguishable from the natural originals.¹⁵⁶ One set of machines will scan vegetables, fruit, grain, meat, and other foods at the peak of freshness, and they will store an electronic template, so to speak, of these three-dimensional objects. The electronic copy may be cleaned up a little: any pathogens, soil or blemishes that happen to be present in the originals will be carefully removed. Other machines will reproduce the originals by assembling molecules and building up layers. Machines that can analyze materials at the atomic level have been used for decades. Scanning Tunneling Microscopes (STM) that can identify and move individual atoms around have only recently been developed. Fig. 16.9 shows how IBM researchers used this instrument to move individual atoms around. Of course this is far simpler than assembling a trillion-trillion atoms ($10 \times$ Avogadro's number) to form the three-dimensional array of molecules in an apple! No doubt it will take centuries to perfect this kind of atomic synthesis. Nature perfected it billions of years ago, in DNA and the other cellular machinery.

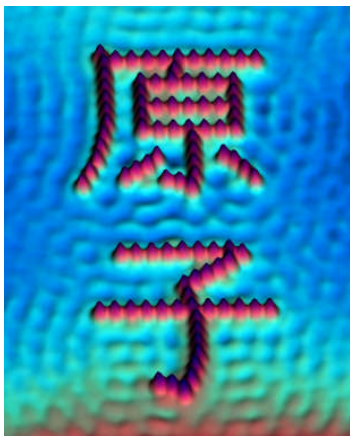

Fig. 16.9. IBM researchers Lutz and Eigler used a scanning tunneling microscope (STM) to move individual iron atoms around on a copper surface to form the character for “atom” in Chinese (or Japanese). In the far distant future, this ability to affect individual atoms may evolve into technology that will allow us to scan at atomic level and later assemble any object from atoms. IBM STM Image Gallery.

<http://www.almaden.ibm.com/vis/stm/atomo.html>

I am not suggesting that all farms, everywhere, should be eliminated. Some should be preserved as living museums, others as research centers to find new types of food and to learn how human interaction with nature has affected the environment. I hope that millions of hectares will be farmed by people who enjoy gardening and farming for its own sake, and for the benefit

¹⁵⁶ The inevitable result of this technology is described in Arthur Clarke's classic short story, "Food of the Gods"

of domesticated animals and livestock, who deserve a place on the earth just as much as wild species do. Farming in the distant future will be more pleasant when robots do the heavy labor, and the animals are not slaughtered at the end of the season.

To an American food purist, it may seem paradoxical that some Japanese consumers consider greenhouse and food factory produce to be more “organic.” (The word cannot be defined with rigor, but most people know it when they see it.) Of course many Japanese would disdain factory food and demand hand grown food and cage-free chicken eggs. A food purist will appreciate the fact that factory food does not require pesticide, but he will decry the uniform, dirt free, blemish free appearance, and the predictable taste. He will mourn the loss of seasonal variety, and the intimate connection to the earth — especially if he himself has never worked on a farm. He might say with considerable justification that many farmers are good stewards of the earth. A conscientious farmer prevents erosion and the destruction of the water table. Compared to people who commute hours a day on highways, or the natural gas companies that are sabotaging the groundwater in Wyoming,^{157,158} the average farmer is laudable. Farming can be good for the land, but not farming is better. It would be best to let land revert to a semi-natural condition, with minimal human intervention to prevent invasive species and periodic brush clearing and forestry to prevent large forest fires. This should be described as “semi-natural,” in North America, because human beings have been modifying forests for hundreds of thousands of years, by setting fires. By now, the effect of human activity on the landscape should be considered as natural as the effects of deer and other large species.

The Buffalo Commons plan describes the kind of world I hope cold fusion and food factories will bring about. Under the plan, millions of hectares of unproductive U.S. agricultural land would be turned into a nature reserve and tourist attraction, like the open African plains:

The Buffalo Commons will be a restored and reconnected area from Mexico to Canada, where we humans learn to work together across borders that were artificial in the first place. The Buffalo Commons means the day when the fences come down. The buffalo will migrate freely across a restored sea of grass, like wild salmon flow from the rivers to the oceans and back. Settled areas can — like they do in Kenya — fence the animals out, not fence them in.¹⁵⁹

About half of the world’s land is given over to agriculture, and another 20% to human settlements.¹⁶⁰ That is far too much for a healthy ecosystem. It reduces biodiversity. Unfortunately, even this large fraction of the land is not enough to feed everyone decently. The system is stretched to the limits. Bioengineering, green revolutions, over-irrigation, the destruction of the water table, and the use of massive quantities of insecticide and fertilizer have increased food production, but there are limits to these methods, and they are destroying the land. The system is overdue for replacement.

¹⁵⁷ Diamond, J., *Collapse, How Societies Choose to Fail or Succeed*. 2005: Viking.

¹⁵⁸ Ivins, M. and L. Dubose, *Bushwacked*. 2003: Random House, Chapter 9.

¹⁵⁹ Great Plains Restoration Council, Buffalo Commons plan, http://www.gprc.org/Bufalo_Commons.html

¹⁶⁰ Pimentel, p. 155

2. Aquaculture

Indoor fish farming (aquaculture) has been commercialized, and it supplies a significant fraction of the fish eaten in New England and Boston.

Ocean fishing is causing disastrous declines in wild fish populations and other widespread ecological damage. Even if it is properly managed in the future, it will never supply more than 1% of the world's food energy.¹⁶¹ Huge fish farms in cordoned-off areas of the ocean have been built, but they damage the ecology because they generate so much pollution. They are also controversial because more toxins are found in farmed salmon than in wild varieties, and the farmed salmon may be pushing the wild ones out of their niche. Indoor fish farming eliminates these problems. It can produce large quantities from a small land area. Fish farming in enclosed lakes (not the ocean) has been practiced in China for thousands of years, but recent high-tech computerized techniques are much more productive. This industry is energy intensive, so cold fusion will reduce costs.

A company in Massachusetts grows 900,000 striped bass in an aquiculture factory on an acre of land, in tanks. The fish are healthier and better tasting than those grown in the wild or in ponds. The tanks are equipped with pumps that produce a rapid current, like an artificial stream, and the fish swim vigorously 20 miles per day in cold water. This improves the flavor of the meat, and I suppose it makes the fish happier, since it is more natural for them than a still pond would be. The fish grow to market size in nine months, half the time it usually takes. The water discharged by the factory "exceeds numerous drinking water standards," according to state environmental officials.¹⁶²

¹⁶¹ Pimentel, p. 106

¹⁶² Herring, H.B., *900,000 Striped Bass, and Not a Fishing Pole in Sight*, in *New York Times*. 1994.

17. The Future of Automobiles

1. Children Living Next To a Precipice

Imagine you visit a primitive tribe of people, and you find they build huts a few meters from the edge of a cliff. From time to time, a small child at play wanders too close to the edge and falls to his death. You would consider this intolerable. You would wonder why these people do not move their huts back 200 meters, or why they do not erect fences and walls to keep the children away from the precipice. You would be horrified, and you would probably think these people are barbarians who do not value the lives of their children.

Now go to any city or town in the U.S., Japan or Europe, and look around. Billions of children live near busy streets, where cars whiz by at speeds up to 80 kilometers per hour. Every so often, a child will chase a ball or a dog into the street, or forget to look both ways while going to school, and he or she will be run down. Thousands of children are killed and maimed every year, yet little is done to prevent it.¹⁶³ Future generations will consider us barbarians for allowing this state of affairs. They will say we were brutes who felt no remorse for the children. We grieve as any parents would, but, like the primitive people whose children fall off of cliffs, we lack imagination. We do not implement simple, cheap, foolproof ways to prevent the carnage, such as building fences alongside roads, and setting civilized speed limits. We should not allow a vehicle to move through a residential area faster than 20 or 30 kilometers per hour (12 to 18 miles per hour), unless there are pedestrian barriers. That is the speed at which a person can run, or ride a bicycle or a horse. A driver's natural reflexes should give him time to brake to a halt before hitting a pedestrian, or to slow down enough that the injury will not be fatal. When an automobile strikes a person at 10 kilometers per hour, the person is knocked out of the way but seldom killed.¹⁶⁴

Motor vehicles cause a worldwide holocaust of deaths and injuries on the scale of the Black Death, early industrial revolution mining and factories, or modern wars. Vehicle accidents kill 1.2 million people, and seriously injure 38.8 million, mainly in the third world. They rival the worst catastrophes of the 20th century:

World War II, 50 million deaths

1918 influenza pandemic, 20 to 40 million deaths

World War I, 9 million deaths

Automobiles, 30 to 50 million deaths from accidents, for the entire century

Pollution from vehicles may kill as many people as accidents do, possibly more, but the numbers are difficult to establish. In wealthy nations, where regulations and good roads minimize accidents, pollution probably kills more people than accidents do. The WHO estimates that motor vehicle accidents kill 45,000 in the EU, and about 120,000 people in greater Europe

¹⁶³ Child Accident Prevention Trust, Factsheet, <http://www.capt.org.uk/pdfs/factsheet%20road%20accidents.pdf> "In 2002, over 36,000 children aged under 16 years were killed or injured on the UK's roads."

¹⁶⁴ Child Accident Prevention Trust, Ibid. "Research has shown that if hit by a car traveling at 40 mph, 85% of pedestrians are killed, at 30 mph this percentage falls to 45%, and at 20 mph it becomes 5% with 30% suffering no injuries at all."

including non-EU countries. It says, “about 80,000 deaths a year in Europe can be attributed to long term exposure to road traffic air pollution.”¹⁶⁵ “In the European Union, the total cost of the adverse environmental and health effects of transport, including congestion, is estimated as up to 260 billion [Euros].” Cold fusion will quickly put an end to the pollution.

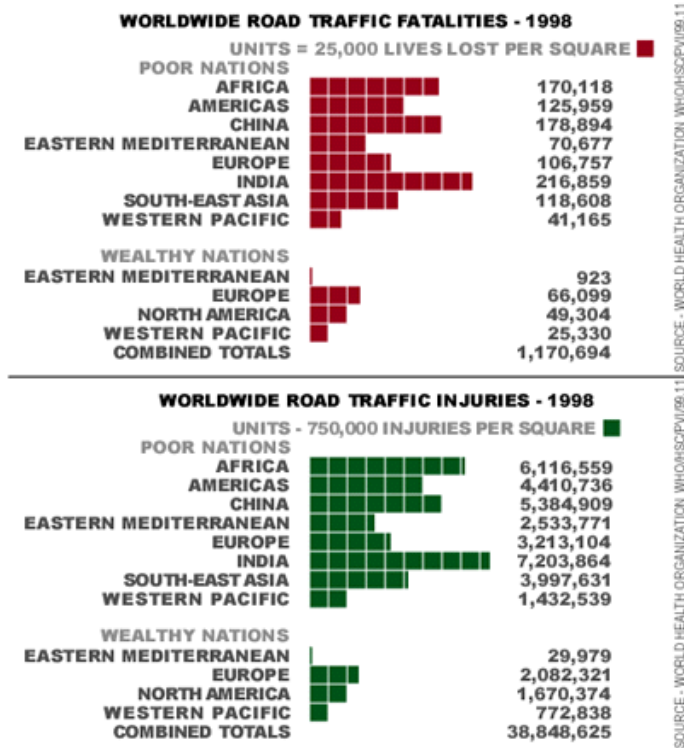

Figure 17.1. Traffic fatalities and injuries in 1998, *Injury: A Leading Cause of the Global Burden of Disease*, World Health Organization

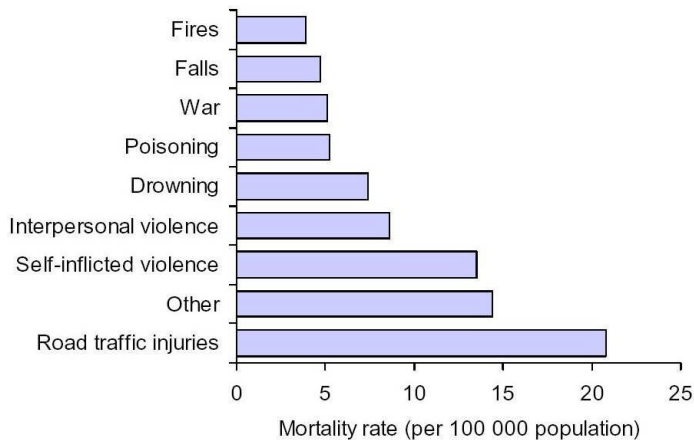

Figure 17.2. Global injury mortality rates by cause, 2000, World Health Organization, *The Injury Chart Book*, <http://whqlibdoc.who.int/publications/924156220X.pdf>. Worldwide, road traffic injuries are responsible for the highest mortality rates.

¹⁶⁵ *Averting The Three Outriders Of The Transport Apocalypse: Road Accidents, Air And Noise Pollution*, Press Release WHO/57, 31 July 1998, <http://www.who.int/inf-pr-1998/en/pr98-57.html>

Reinventing automobiles should be an urgent priority, along with providing drinking water, food and education. Cold fusion is the key to making motor vehicles far safer, as well as more convenient, useful, quiet and speedier.

In the Third World, accidents can be reduced the same way they already have been reduced in the first world: by constructing better conventional roads and traffic barriers, by reducing congestion, and by setting lower speed limits. Meanwhile, in the first world we can use cold fusion to begin moving toward more radical solutions. Once we develop new kinds of cars and roads, we can export them to poorer nations.

Forcing children to live near open roads, breathing in polluted air or drinking contaminated water should be considered criminal child abuse and must be stopped. We have become inured to these horrors because we have always lived with them. The first step toward fixing a problem is to recognize that it is a problem, to become upset about it, and to start looking for solutions.

Many other problems with technology are less dire than fatal accidents or contaminated water, but they still make life miserable, and we should have fixed them decades ago. Traffic jams waste billions of man-hours. Noise from traffic, lawnmowers and construction equipment causes stress and wide-ranging health problems. Bright lights in cities make it hard to sleep and impossible to enjoy the night sky. Some of these problems are caused by necessary trade-offs. People have to go to work, so we must suffer from pollution and traffic jams. But the bright lights in cities benefit no one but power company stockholders, and there is no benefit whatever to making noisy lawnmowers. On the contrary, machines that annoy people or make them sick probably also cost the owners extra money. A noisy machine is usually badly designed, inefficient, or poorly maintained.

2. Reinventing Motor Vehicles

Obviously, cold fusion will have a monumental impact: it will eliminate gasoline. To reiterate the numbers from Chapter 2, a kilogram of heavy water has as much energy as 1.5 million kilograms of gasoline (523,000 gallons), and it will cost \$100 or less in the future.

The first cold fusion powered models will probably look like today's cars. They will likely be large and heavy, like expensive, midsized U.S. models. There will be no reason to make them lightweight. Consumers prefer heavier cars because they handle better; they are quieter inside, and safer in accidents than other motor vehicles.¹⁶⁶

Cold fusion will enable a complete vehicle design rethink. We can eliminate many of the mechanical and structural features of the traditional car. Things such as antipollution devices and energy efficient oil pumps and air conditioners will not be needed, and neither will the fuel tank, exhaust and muffler. Lightweight aluminum and plastic body parts and aerodynamic, molded light fixtures are efficient, but they are expensive to replace after an accident, so they will be dispensed with. (The overall shape will remain aerodynamic because that makes cars easier to drive, and safer.) Manufacturers will cancel costly research programs to meet miles-per-gallon and pollution control standards. Cars will have steel bodies, which are easier to recycle. These changes should eventually make cold fusion cars cheaper to manufacture than gasoline powered models.

¹⁶⁶ National Highway Transportation Safety Administration, <http://www.nhtsa.dot.gov/>

The first models will probably be steam turbine hybrid electric cars, similar to the gasoline hybrid electric models now available from Toyota and Honda. The steam will not be vented; it will be condensed and recycled. Antique steam powered automobiles were inconvenient. When the boiler was cold, you had to light the fire and wait a half-hour before the car was ready to go. Cold fusion appears to be slow to turn on and off, although this may only be an artifact of today's experiments. Suppose it turns out the reactor takes 20 minutes to ramp up to maximum output. With a hybrid design and reserve batteries, this will not be a problem.¹⁶⁷ The boiler will be well insulated to keep the water hot so the motor turns on quickly, and also to keep people from being scalded in accidents. It will remain warm even in the dead of winter, because cold fusion never needs to be fully turned off. It will be left on standby mode. When you press the start button and the accelerator, the car will begin moving on battery power, while the cold fusion cell turns up to the highest setting as quickly as it can go, and the turbine soon begins to recharge the batteries. The turbine will continue to run after the car is parked, until the batteries are fully charged, and then the motor will return to standby mode.

Steam turbines will make cold fusion cars, trucks, bulldozers and other heavy machinery quieter, cheaper and more reliable than today's models. When thermoelectric devices improve, we will dispense with the turbine, making the machinery even quieter and simpler, with fewer moving parts.

Cars will be equipped with a solid-state thermoelectric air conditioners and heating, which the driver will leave running when the car is parked. Vans will be equipped with energy intensive devices such as refrigerators.

A major selling point of the cold fusion car will be its environmental friendliness. It will cause almost no pollution. (Particles of brake pads and tires will still wear off, and lubricating oil will drip onto the road, but these problems are microscopic compared to air pollution from gasoline.) At this writing, gasoline hybrid electric cars are selling like hotcakes, perhaps because trendy people want to show how environmentally sensitive they are. Two models are available, from Honda and Toyota. The Honda is selling in modest numbers because it looks like a regular Civic. The Toyota Prius has a six-month waiting list because it has a futuristic feel, with a computerized dashboard and fully electric operation below 15 kilometers per hour (10 miles per hour), so it is whisper quiet, whereas the Honda sounds like an ordinary gasoline car even at low speed. The first cold fusion cars will sell better if they are cosmetically futuristic looking, even if most internal systems such as the brakes and gears are conventional.

3. Improving the Entire Transportation System: Commuting, Vehicles and Roads

I hope that automobile commuting will be less prevalent in the future, and commuting distances will be shorter. I would like to see most commuting replaced with telecommuting, in which people go to small satellite offices close to home. A large company may have a thousand employees, but they will be scattered around a city (or a continent) in small offices, and connected with continuous large-screen telepresence. I would also like to see improved air transport replace much of our intercity travel and long-distance trucks. However, jobs such as

¹⁶⁷ Today's gasoline hybrid cars do not have anywhere near enough batteries to operate on battery power alone for any length of time. The Toyota Prius battery alone would only carry the car only about a mile. See: http://pressroom.toyota.com/photo_library/display_release.html?id=20040623

nursing, teaching, food preparation or research will require the employees be physically present at a central location. Automobiles are likely to be our main means of transportation for centuries to come. So let us imagine how vehicles and roads together might be improved radically, to eliminate not only pollution, but also: accidents; noise; inconvenience; urban blight; noisy highways where there should be quiet bucolic country lanes; the danger of collisions with deer and other wildlife; and millions of hectares of asphalt that wreak havoc on the ecosystem. Let us think about how the benefits of automobile mobility can be extended to all members of society, including elderly people who are too often isolated when they can no longer operate a vehicle.

Various schemes have been proposed to reduce some of these problems, but I regard them as unsatisfactory, unrealistic half-measures. They will cost too much. Some people advocate more mass transit, but this is a 19th-century solution to 21st century problems. It is naïve to think that Americans might give up cars and ride bicycles or walk to work, or stop living in suburbs. If those are the best solutions we can come up with, we might as well resign ourselves to living with miserable traffic jams for the next thousand years. What we need are bold, radical new solutions that eliminate the carnage, the expense, waste and frustration caused by cars, while at the same time preserving the convenience and freedom cars give us. With cold fusion plus improvements in excavation and computers, we can put most busy main roads and highways underground, and we can make automobiles that finally live up to their name, and become truly automatic.

“Underground highways” may sound wildly unrealistic, I believe they could double or triple travel speed, and prevent nearly all accidents. A system that doubles travel speed, prevents a million deaths and 35 million serious injuries worldwide, and saves \$230 billion in U.S. hospital bills alone is not only realistic, it is inevitable.¹⁶⁸ Why should we put up with anything less? Our ancestors were not content with sailing ships and horse-drawn carriages on dirt roads. They made steamships and automobiles — a gigantic improvement. It is time for us to take similar giant steps. We should never be satisfied with systems that can be made far safer and better. People everywhere on earth deserve the best that technology has to offer.

Cold fusion automotive tunnels will be easier to engineer than today’s tunnels because ventilation will be less demanding. Only the drivers will need fresh air; the vehicles will not burn fuel. In other words, the demands on the ventilation systems will be the same as with today’s electric subway tunnels. Gasoline burning cars will also be prohibited because they are dangerous; they sometimes explode during accidents. Fusion cars might smolder after a severe accident, but they will not explode. Driving conditions in underground tunnels will always be optimum. The pavement will never have to be torn up to fix sewers, pipes or telephone lines, because these will be run in a separate section of the tunnel that workmen can access without stopping traffic. The automobile tunnels will have antennae for radio, television and cell telephones. They will have automatic lights that turn on when cars approach, and cameras and sensors for the traffic control computers. Since the tunnels will be protected from weather, and the vehicles will not pollute, this high tech equipment will last much longer than it would on today’s surface roads. Once a car enters the tunnel, it will operate fully automatically. It will be like a subway train in an airport: a horizontal elevator with no human operator. In the structured

¹⁶⁸ According to the National Highway Transportation Safety Administration, motor vehicle crashes in the U.S. cost \$230 billion a year, “or an average of \$820 for every person living in the United States.”
<http://www.nhtsa.dot.gov/nhtsa/announce/press/pressdisplay.cfm?year=2002&filename=pr38-02.htm>

environment of the tunnels, where there are no pedestrians, animals, fallen tree branches, or other human drivers, we can automate cars using present-day computer technology.

In urban neighborhoods, people will manually drive on surface roads, or walk on sidewalks to go to the store, to school, or to stroll in the evening. When they wish to go more than a few kilometers, they will drive along the surface roads no faster than 30 kilometers per hour, until they reach the local tunnel entrance, or portal, for one of the main underground roads. (The car will not go faster than 30 kilometers per hour under manual control; the computer will limit the speed even when you floor the accelerator.) The portal will be steep and narrow, like the entrance to an underground parking garage. It will be closed and gated, and protected by a camera and a robotic automatic security system to prevent children and animals from wandering in, and to regulate traffic during rush hour. The automatic system will recognize that a car is waiting, and swiftly open the gate. Once the car enters the tunnel, the steering wheel (or control joystick) will retract into the dashboard, the automatic driving computer will take over, and the passenger will read a newspaper or take a nap until the car emerges from the portal closest to his destination.

Underground roads will be nonstop because they will be three-dimensional, like today's interstate highways: where two roads cross, one will dip down under the other. Because they will have no traffic lights, underground roads will be faster than surface roads, even though they will probably have fewer lanes. Traffic may slow down or stop from time to time, to allow merging cars to enter from a portal, or exit to a backed-up portal, but these stops will be fully automatic and regulated by a traffic control computer. The delays will be as brief as possible. As soon as traffic clears, full-speed, nonstop operation will resume. Today's crude traffic signals will stop cars whether there is cross-traffic or not, and they often hold cars for several seconds after cross-traffic has cleared.

Actual travel speeds from portal to portal within cities may be 60 kilometers per hour (40 miles per hour). On underground intercity superhighways, travel speed might be as high as 250 kilometers per hour (150 miles per hour), although moving so rapidly in such narrow confines will take some getting used to. Clearly, no human can operate a car at such high speeds in a tunnel. Human reflexes are not up to the task. A moment's distraction would cause a disastrous accident. Even today changing lanes and maneuvering in crowded, fast-moving highway traffic is often a terrifying experience.

The tunnel roads will have narrow shoulders. All cars and trucks on them will move at the same speed, spaced precisely apart. They can safely run much closer together than manually driven vehicles. They may even be hooked together, bumper-to-bumper, moving like a railroad train from one portal to the next. The U.S. Department of Transportation has tested such "highway train" or "platoon" cars. They are steered automatically, on ordinary highways with magnetic guidance sensors embedded in the pavement.¹⁶⁹ A highway train would be easier to implement in clean, undisturbed underground tunnels where there are no manually driven vehicles. Traffic density can be doubled or tripled by reducing the empty spaces between cars. The central traffic control computer will determine the makeup of these trains, grouping together

¹⁶⁹ Bryant, B., *Actual Hands-Off Steering: and Other Wonders of the Modern World*. 1997, Federal Highway Administration, <http://www.tfhrc.gov/pubrds/pr97-12/p32.htm> This technique also reduces energy consumption: "Vehicles traveling in a tight, automated platoon with about half a vehicle-length interval have a dramatic reduction in aerodynamic drag that results in a 20-percent to 25-percent improvement in fuel economy and emissions reduction." But that will not matter with cold fusion.

cars with the same destination. As the train approaches a portal, some members will detach and exit, while others may join the train. The train may slow or stop for a moment during this reorganization.

Since there will be no human drivers, there will be perfect cooperation between cars, and no aggressive driving or traffic violations. Cars will never fail to signal their intention to turn or change lanes. All cars will “know” where all of the surrounding cars are going, and what each plans to do, because they will constantly signal to one-another in a wireless network, while the central traffic control computer issues general orders to all, as needed. If an accident occurs, all cars for several kilometers back will instantly be informed of the emergency, and ordered to brake to a halt. Since all cars will move at the same speed — the fastest safe speed given overall traffic density and conditions — there will be no dangerous maneuvering to overtake other cars or change lanes, and no unplanned scrambles from an outside lane to an exit. When the central traffic computer decides to move a platoon of cars to an outside lane, it will order the surrounding platoons and individual unattached cars to drop back and make space.

As these automatic controls are perfected and made rugged and cheap, the computer software may improve enough to deal with the hazards of outdoor highways, such as weather conditions and animals wandering onto the road. Some of the remaining ground-level highways may be retrofitted with the automatic controls, so they can handle more traffic and higher speeds. (A breakthrough sometimes prolongs the useful life of a competing, obsolescent technology. Previously I suggested that power companies might use centralized cold fusion generators to extend their lease on life for a few decades.) Old highways may be upgraded after the last manually driven automobiles are retired, but it will probably not be a good idea to allow a mix of manual and automatic cars on the same road. In any case, the overlap will not last more than 10 or 20 years, because cars wear out quickly, and there is no chance people will buy manual cars when automatic ones go twice as fast and have 10,000 times fewer fatal accidents.

All cars and trucks will be fully enclosed. Windows will not open except in emergency. All goods and packages in trucks will be in enclosed, securely sealed compartments. Open bed trucks; dump trucks covered by flapping tarps trailing billowing clouds of dirt and bouncing gravel; trucks carrying thousand of chickens in open cages; and garbage trucks that spill fetid water onto the windshields of the cars behind will never travel at 250 kilometers per hour. The portal control robot will not open the tunnel gate for an automobile with a mattress tied to the roof or hanging out of a partially open door, because such unsecured freight would be blown off onto the road. It will not open the gate when it sees a passenger is not wearing a seat belt. If you undo the seat belt while riding in the tunnel, the car will sound an alarm and put through a call to the police. An irate officer will show up on your dashboard video screen and your car will exit at the next portal, where a patrol car will be waiting with a traffic ticket neatly printed. Perhaps you feel that would be too intrusive. It bothers me too, but I cannot imagine how else we could safely operate vehicles traveling linked together in “tight, automated platoons” at 250 kilometers per hour. These are extreme conditions. There is a positive side to the intrusiveness. If you fear you are suffering from a heart attack while driving and you call the police for help, an Emergency Medical Service paramedic will video-call to your dashboard screen and offer reassurance. All other traffic will be shunted out of the way, and your car will be given emergency clearance to proceed automatically at top speed to the portal of the nearest hospital, where the EMS team will be waiting with an ambulance.

On long, boring trips through tunnels there will be nothing to see, and nothing to do, since the car will drive itself. In-car entertainment will be improved. The windshield will have a built-in liquid crystal display (LCD), which will superimpose information on the view as you drive in manual mode, in a pop-up display. It will show the names of roads, and issue warnings when pedestrians walk out in front of the car. When you travel in automatic mode, you may change the LCD into an opaque multicolor screen display, giving you privacy, lighting, and a fake set of surroundings, like a screensaver. You might select a view showing your car surfing atop a tsunami or canoeing down white water rapids. Cars will be well insulated, engines will be quiet, and the roads will be smooth, so there will be little vibration or sensation of motion. Perhaps it would be more appropriate to select the view seen lounging in a punt down Cambridge's River Cam on a midsummer's evening, or in a Venetian gondola, or heading into space surrounded by appropriate starfield graphics.

Automobiles will resemble subway cars or airplanes. They will all be about the same shape and size, and they will all be capable of high-speed performance and rapid response under computer control. They will have to conform to more exacting engineering standards than today's vehicles, and they will be subjected to frequent, tough, automated safety inspections.

Nearly all accidents today are caused by driver error or recklessness, rather than mechanical failure or road conditions. Most serious accidents occur at speeds above 30 kilometers per hour. When people manually drive cars no faster than 30 kilometers per hour on surface streets, and almost all highways are automated, fatal accidents will be so rare they will make the front-page news. Worldwide fatalities may drop to from 1.2 million to a few thousand per year. As the control computers and sensors improve, accidents will gradually become as rare as commercial airline crashes are today.

Many traffic delays on today's highways are caused by accidents, so there will be few delays, aside from the usual rush hour traffic. Rush hour can be predicted, planned for, monitored and controlled with central computers. It can be greatly reduced by charging automatic tolls that vary by location and time of day. (We will need road tolls or an odometer mileage tax in any case, to replace the gasoline tax.) As you approach a portal during rush hour, the traffic control computer may send a message to your dashboard videophone console: "All westbound traffic slots on this road have been reserved for the next 15 minutes. You may wish to use an alternative route on Wisconsin Avenue instead, or you can reserve a slot at 8:46. Please note that premium toll rates are now in effect, until 9:00 a.m." After you reserve a slot the computer will ask you to park nearby, and it will display a countdown clock on the console and a two-minute warning before the slot becomes available.

Snow and rainstorms will seldom delay traffic in the tunnels, except when they cause traffic to back up at the exit portals. Many drivers may not exit aboveground. They may drive directly into underground parking garages beneath their houses and offices.

If the birdbrain class computers described in Chapter 10 are developed, autonomous vehicles will operate automatically on surface roads as well as underground. You will never drive one. You will simply hop in, tell the computer where you want to go, and then relax while the car navigates slowly through your neighborhood and then careens along at 250 kilometers an hour underground. Such fully autonomous cars will bring tremendous benefits to disenfranchised people. They will be rapid, safe, and available on demand by anyone, including a small child, a blind person, weak, elderly people, and others who cannot operate today's cars. They will extend

to all members of society the freedom, independence and mobility that automobiles now give to the average, able-bodied adult. Underground roads will have already eliminated most serious accidents, but people will have to keep driving on unimproved surface streets until the birdbrain computers take over. This will finally eliminate the few remaining accidents caused by drunk drivers, reckless drivers, taxi drivers and timid drivers who do not merge fast enough, people who are lost and trying to find a street sign or exit marker, people who fall ill or asleep at the wheel, parents distracted by children, and people talking on cell phones. Finally, the “designated driver” will become a thing of the past.

Fully autonomous vehicles and aircraft will do away with most jobs in the transportation sector, such as truck drivers, taxi drivers and airline pilots.

Riding in a fully autonomous intelligent vehicle will not be as novel a sensation as you might imagine. Actually, people have been doing this for thousands of years. Many a tired farmer has ridden home half-asleep on the back of horse that knows the way as well as the rider does.

People will no longer be able ride in the back of an open bed truck, or ride without seatbelts. Although accidents in the underground roads will be rare, and they will not result in explosions from flaming gasoline, a passenger is not likely to survive a crash at 250 kilometers per hour without a seat belt. It will probably be the 4-point restraint used in small aircraft and roller coasters. (To a 20th century driver, these cars will perhaps most resemble amusement park rides.) Helmets may also be required. Pets and all goods will have to be securely stowed; if you stop short abruptly in crash, the momentum of a loose can of peaches flung from the back seat at 250 kilometers per hour could inflict a fatal blow. These are, as I said, extreme conditions. But design engineers know how handle them. Racecars protect the driver’s cabin by self-destructing in a high-speed accident, absorbing most of the shock of a crash. In accidents with small airplanes, the wings and most of fuselage can be smashed to shreds, leaving only the passenger compartment intact and bouncing along the runway, yet the passengers walk away from the wreck.

Dangerous chemicals and explosive materials must be banned from underground highways. They will have to go via the slow surface roads, or pipelines, or eventually by robot-piloted VTOL aircraft. To avoid terrorism and crime, the portal robots may need to check automobiles for explosives or contraband.

When I have suggested that automobiles should be truly automatic, highly regulated and standardized, some readers have bemoaned the loss of freedom this will entail. They enjoy driving. They consider it a means of self-expression. They do not want all cars to look the same. They want to express their individuality by picking the model of their car. They want the freedom to poke around and repair cars themselves. It seems unlikely that amateur mechanics will be allowed to modify computerized vehicles that routinely operate at 250 kilometers per hour. This would be like allowing folks to help change a tire on a Boeing 747. I hope that some roads will be reserved for people who enjoy automobiles and driving as a hobby, or as a means of self-expression. They have every right to do this, just as people have a right to enjoy riding bicycles, swimming and canoeing in the Delaware River, or dangerous sports such as hang gliding. However, the highway system is not intended to give people psychological satisfaction, or a means to express themselves. It is a public transportation system, no different from an elevator. Automatic cars and underground roads would have so many advantages the vast

majority of commuters would prefer them, even though they will make life more regulated and a little less colorful and exciting.

When most large surface highways are abandoned, millions of hectares of land will be freed up for other uses. Perhaps we will reserve some of the famous abandoned highways for automobile nostalgia buffs, as National Parks. Hobbyists running a few hundred thousand gasoline powered cars would cause no measurable pollution or harm. The risks of driving are small, after all. Scenic roads such Skyline Drive in Virginia and Route 1 in California should certainly be left open to manual cars, motorcycles and bicycles. When the Newer New Jersey Turnpike is opened as a 16-lane automatic underground highway, 50 meters under the path of the present turnpike, perhaps 100 kilometers of the old road can be turned into a nostalgia museum for people who want to drive manually operated gasoline vehicles, complete with authentic turn-of-the-21st century gas stations, fast food restaurants, and state highway police wearing period costumes.

It might be better to replace most intercity high-speed highways with telecommunications and air transport, or perhaps underground automated maglev cars that travel at 500 - 1,000 kilometers per hour. These vehicles only operate on the special maglev tracks, unlike the individual wheeled passenger cars that enter and exit the tunnels. It is conceivable, I suppose, that maglev tracks will be built outside the tunnels through to urban neighborhood, so that anyone can drive his own personal maglev car to a parking lot near his house, or right to the front door. This seems awkward and expensive, like a giant grid of trolley cars. Perhaps they could have retractable wheels for slow speed, aboveground operation.

A maglev train is fast in part because it has no wheels. Wheels are the limiting factor for speed and control of an automobile. There are other vehicles without wheels such as hovercraft. Designers have proposed various exotic vehicles, such as cars that convert to privately operated monorails on special hanging tracks. I think these alternatives would be too noisy, difficult to operate, or impractical. If anything replaces the automobile in the future, it will be the personal flying machine, described in the next chapter.

18. The Future of Aircraft, Spacecraft and Personal Flying Machines

Cold fusion coupled with progress in aerospace technology and air traffic control will bring about two new forms of aircraft: those with much larger payloads that carry thousands of people or hundreds of tons of air freight, and those with much smaller payloads that carry one or two people, for personal use.

1. Aircraft

Airplanes and helicopters will have unlimited range. They will travel at top speed; they will not need a “cruising speed” to conserve fuel. High performance cold fusion powered jet and ramjet aircraft will fly at many times the speed of sound for as long as the crew has food and water.

Today’s airplanes suffer from two related problems: they carry a small payload, and they have to keep moving or they crash. Jumbo jets carry up to 500 people. Boeing and Airbus are thinking about building 1,000-passenger airplanes, but this is probably close to the practical limit. Conventional airplanes will never carry more because of the second problem: they cannot slow down much, or stop and hover in the air. So they must have long runways, and they must remain several kilometers apart in the air for safety. The bigger the airplane, the longer the runway it needs, and the more stress it puts on the runway and landing gear when it lands. Airports already take up a great deal of room, and it is not likely cities will allow runways two or three times longer than the ones we have already.

A 1,000-passenger airplane may seem large, but it is not very big by the standards of railroad trains or ships. The *Great Eastern*, launched in 1858, could carry 4,000 passengers in far more comfortable and commodious accommodations than an airplane offers, or 10,000 troops crammed together.

What we need are gigantic aircraft that can hover, descend vertically, and land gently in front of the air terminal without a runway, the way a helicopter does. As a hovering aircraft settles, several skids or tires strike the ground simultaneously, which puts no excessive strain on the runway concrete or the aircraft landing gear.

When air traffic is congested, the aircraft will slow down, stop and hover high above the airport in a fixed position, close to other stopped aircraft, like cars waiting at a traffic signal. They will not need to orbit in giant circles at breakneck speed the way today’s airplanes do. This will make the air traffic controller’s job easier. So will multiple, decentralized airports and direct landing of freight in factories, shopping malls, and trucking yards. Traffic will no longer come through the bottleneck of one large airport.

Four kinds of aircraft can hover:

1. A helicopter. It seems unlikely helicopters can be made much larger or faster than they already are. Cold fusion would not help. The limiting factor is the size and strength of the rotors (propellers).
2. A hovercraft, also known as air-cushion vehicle (ACV), or ground-effect machine.

3. An airship or zeppelin.
4. A vertical takeoff and landing airplane (VTOL), like the Harrier jump jet fighter. This is like a helicopter that uses jet engines instead of rotors.

Large hovercraft have been in use for decades, mainly in the English Channel ferry service. They were not an outstanding commercial success mainly because they used too much energy, which would not matter with cold fusion. They could not compete with the channel tunnel and with the “Fast Ship” catamarans, so they were phased out in 2000. But they have intrinsic advantages over ordinary ships, aircraft, and the Fast Ships. They are much faster than ordinary ships, and they are not affected as much by rough weather and high waves. They can cross water, ice, sand, swamps, or any other flat surface. Giant oceangoing hovercraft may be developed, mainly for freight but perhaps also for passengers. The channel ferries could have crossed from London to New York in two days, and faster ones may be developed. Two days is about how long it takes to send goods by airfreight today, once you break the shipment into small containers, load it, and wait for a crowded airport takeoff slot to open. A large hovercraft might carry as much as a hundred airplanes do.¹⁷⁰ It will dock at an existing containership port on the coast, which can handle much more freight than an airport. Alternatively, it might go to a new port several kilometers inland, if there happens to be a wide, flat open space from the shore to the new inland port. This space would not have to be paved. It might have crops, fences or boulders less than a meter high. Hovercraft would be better than the advanced Fast Ship designs, first because they already exist and people have experience operating them, and second because they would cause less harm to the environment. Fast Ships would ride high in the water at 70 kilometers per hour, like hydrofoils, and they might kill whales and other large species, and disrupt ocean ecology.

Hovercraft are widely used by the military, which likes them because they fly over water, sand, marshes, barbed wire or mine fields with equal ease, a meter or more up in the air. The U.S. Navy has a large fleet of armored hovercraft landing craft.

Gigantic rigid hot-air airships are zeppelins that use hot air instead of hydrogen or helium gas. They might use a combination of hot air and helium. An airship could transport thousands of tons of freight or raw materials from continent to continent. It would not need an airport to land, just an open space. It might hover over a strip mine while loading ore.¹⁷¹ Unless an antigravity machine is possible, airships are likely to remain the quietest form of air transport. Hydrogen-filled airships like the Hindenburg were dangerous, but helium and hot air ships are safe. They may grow gigantic, like floating towns. People may live in them, the way a few wealthy, retired people live year-round on the Queen Elizabeth 2 ocean liner.

So far, only small VTOL airplanes have been developed, mainly fighter planes such as the Harrier jump jet. Propeller driven VTOL have the same mechanical and speed limitations as helicopters. They have not been successful. What we need for long distance travel (1,000 kilometers or more) are gigantic, jet propelled, supersonic cold fusion powered VTOL aircraft that can carry as many people as a 19th-century steamship. After the 4,000 passengers take their seats, the VTOL will move away from the passenger gate, and then fly straight up into the air, without a runway. When it reaches cruising altitude at 11,000 meters (35,000 feet), it can than

¹⁷⁰ The largest hovercraft ever made had a payload of 112 tons, carrying 418 people and 60 automobiles, at a speed of 110 kilometers per hour. A 747 payload is 140 tons. Much larger hovercraft are possible.

¹⁷¹ McFee, J., *The Deltoid Pumpkin Seed*. 1973: Farrar, Straus and Giroux.

begin flying at Mach three (3,572 kilometers per hour, or 2,220 mph). If the destination airport is crowded, the VTOL may hover high in the air while waiting for a gate to clear. Then it will gently descend straight down, pull up at the gate, and discharge the passengers through dozens of exits.

Today, the trip from New York to Tokyo takes a grueling 14 hours. With the supersonic VTOL, it will take three hours and seven minutes. The longest trip on earth will be no more than four hours. Meals, flight attendants, pillows and coddling will be a thing of the past. Flight attendants today have an important role in an emergency. They will not be needed because by the time we build these airplanes, robot flight attendants will be as skilled at dealing with emergencies as humans are. The robots will remain coolheaded no matter what happens. In any case, any accident will probably be instantaneous and catastrophic, flight attendants will be powerless to help, and there seems to be no point to sacrificing a few dozen extra lives. Pilots, needless to say, will also be replaced with robotic control.

People should not get up and walk around inside airplanes much, and the flight will be short, so there will be no need to provide open spaces. But the seats should be as luxurious and commodious as today's first-class seats. There will be no need to save space, or cram passengers in tightly to achieve maximum fuel efficiency.

Large VTOL freight airplanes will help relieve highway traffic congestion. Many long-haul trucks on the highways are already being replaced with airplanes, with the growth of overnight delivery services. Cold fusion will make air transport much cheaper. With VTOL freight airplanes, goods can be shipped directly from factories to grocery stores and shopping malls in pilotless aircraft that land in a parking lot or on the roof.

A supersonic VTOL craft might work best with small wings, or no wings. The engines should provide most of the lift and control. Modern supersonic fighter jets have wide, wing shaped, "lifting body" fuselages. Giant VTOL may have this design.

An airplane with wings can glide for a surprisingly long distance. In 2001, when all engines on an Airbus failed, the pilot managed to glide 136 kilometers and land safely at an airport. But an airplane with only engines and a lifting body to keep it aloft will plummet like a stone if all engines stop. Since the engines are so critical, the airplane should have several, in case one or two fail. Six would be a good number, and nature has already come up with a good way to arrange them: like an insect, with two in the front, two in the middle, and two in the back. (See Fig. 18.1.) They will point straight down while the aircraft takes off and lands, and then swivel a little to the rear to propel it forward. Perhaps it is not feasible to swivel such huge motors. In that case, the motors will remain fixed and the stream of air will be redirected with vanes. This method is used with some advanced fighter airplanes. If the engines do swivel, they would have to move swiftly to maintain control and keep the flight smooth. Today's airplanes rapidly actuate wing flaps, moving them against tremendous forces. The wing flaps have gigantic screws and gears. Future airplanes might use some sort of electrically activated artificial muscles, but probably not the electroactive polymers (EAP) described in Chapter 10. EAP would not be strong enough, but other types that are much stronger with a smaller range of movement, such as piezoelectric varieties, might work.

Cold fusion produces lower power density and lower temperatures than combustion. It is difficult to imagine how a cold fusion aerospace engine would work. The engines would probably be less efficient than today's aerospace engines, meaning they would be heavier and

bulkier. But this will not matter much because the airplanes will not require fuel tanks, so designers will have much more space in the engine compartment to work with, and fewer weight limitations. An empty Boeing 747 weighs 181,000 kilograms (181 tons). When it flies from New York to Japan, it burns 96 tons of fuel, and it must carry a large extra margin of fuel for safety.¹⁷² A cold fusion version will consume 183 grams of heavy water (a cupful).

It is a little difficult to imagine how a cold fusion powered aerospace engine might work. However, conventional uranium fission aircraft engines were developed in the 1950s, and one prototype was run for 120 hours. C. Hamilton¹⁷³ described the culmination of the program:

The Direct-cycle program was run by General Electric and was extremely successful. In a direct cycle jet engine, the airflow in the engine is diverted after it leaves the compressor. It then enters the reactor, is heated directly, and then ducted back into the turbine section of the engine. In 1956, a ground test of a modified J-47 turbojet engine was operated by a nuclear reactor in what was referred to as the Heat Transfer Reactor Experiment No. 1 (HTRE-1) (14).

This program was continued with more rigorous experiments, HTRE-2 and -3, that validated the concept of utilizing a nuclear reactor to power one or more turbojet engines. The final configuration for HTRE-3 powered two turbojet engines and was of the size to fit within an aircraft even though it was not designed to be a flight test model.

The project was abandoned because of the weight of the required shielding, and the danger from an accident. Recently, interest in this subject has been rekindled. Hamilton describes a hybrid chemical-nuclear engine that might operate at temperatures up to 1,500°C. Such temperatures might be achieved with glow discharge cold fusion, or possibly with titanium gas-loaded cold fusion.

I can imagine some ways a motor might work, although I cannot say whether these schemes would be doable:

- A steam turbine jet engine where the working fluid is condensed and reused. Although this would be heavy and relatively low powered, it might work for slow, propeller driven aircraft. Diesel engines are also heavy but during World War II the Germans operated diesel engine powered high-altitude observation aircraft.
- A combustion turbine burning hydrogen and oxygen. Glow discharge cold fusion cells produce copious free hydrogen and oxygen gas from pyrolysis. The gas burns in the turbine, recombines to form hot vapor, and returns to the cold fusion cell. (The oxygen and hydrogen would explosively ignite a short distance from the cell. This is dangerous of course, but the water remaining in the tank would be perfectly safe.) It might be impossible to capture the hot gas, in which case the airplane would have to carry 250 tons of ordinary water instead of 96 tons of jet fuel, and the range would be limited by the amount of water it could carry. Water is far safer than kerosene jet fuel, needless to say.

¹⁷² Boeing Company, <http://www.boeing.com/commercial/747family/flash.html> The long range version of the 747 can carry up to 174 tons of fuel (63,705 gallons).

¹⁷³ Hamilton, C., *Design Study Of Triggered Isomer Heat Exchanger-Combustion Hybrid Jet Engine For High Altitude Flight*. 2002, Air Force Institute of Technology: Wright-Patterson Air Force Base, Ohio.

- Steam or hydrogen-oxygen turbines at low speed, and a ramjet at high speed. A ramjet uses the surrounding air as the working fluid, but it requires an intense source of heat. The experimental ramjet recently tested by NASA uses hydrogen. This could be generated by cold fusion onboard, from water.

No doubt aerospace engineers will find a practical method.

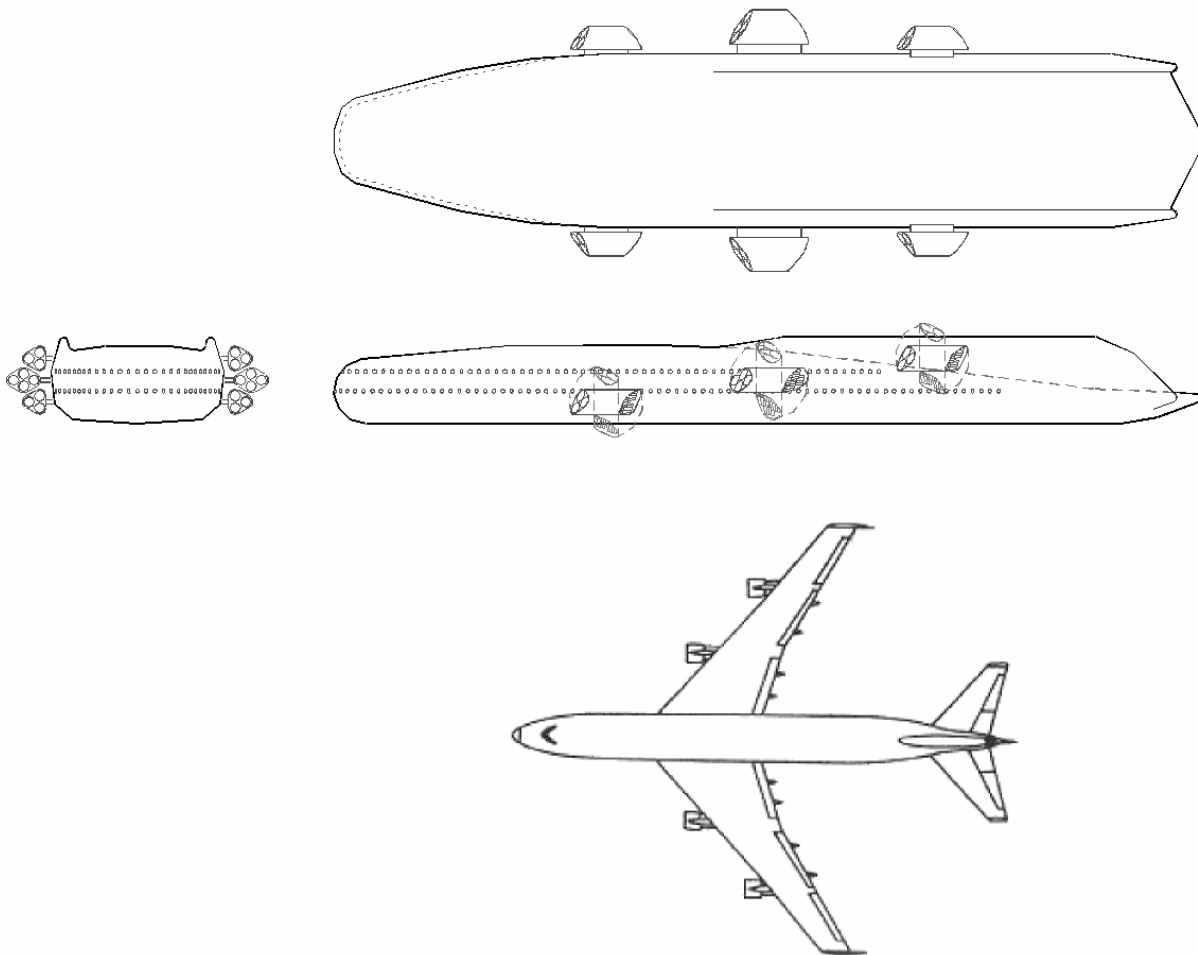

Figure 18.1. A supersonic VTOL (vertical takeoff and landing) passenger airplane, as envisioned by Adam Cox. A Boeing 747 is shown on the same scale, for comparison. The engines swivel to face down during takeoff and landing, and to the rear during flight.

Supersonic Passenger VTOL Specifications

Lifting body design: the fuselage acts as a gigantic wing

Length – 122 meters (400 feet)

Height – 12 meters (40 feet)

Fuselage width – 24 meters (80 feet)

Weight - 4,000,000 kilograms (10 times a Boeing 747)

Engines - 20 cold fusion hydrogen jet engines

- 4 trio pods
- 2 quad pods

Maneuverability

- Engines equipped with limited thrust vectoring
- Engine pods rotate 90° to provide lift / banking

Speed – Mach 3 (3572 kilometers per hour, or 2220 mph)

Passengers: 4,000, all in first-class accommodations, with 1.4 square meters of space per passenger (15 square feet), including aisles between seats, bathrooms and so on. The Boeing 747 has roughly half that much space per passenger.

Two passenger decks, with a combined total of 5,600 square meters (60,000 square feet). This is roughly as much space as a football field (57,600 square feet).

The engine pods are staggered vertically and horizontally to help them clear the exhaust from the pods in front of them.

The footprint of this aircraft is actually smaller than that of a Boeing 747 because it has no wings.

2. Spacecraft

The awkward part of space travel is getting from the ground through the atmosphere to orbit (earth-to-orbit). Given what we know about cold fusion performance today, it seems unlikely that it can be made hot enough or concentrated enough for an earth-to-orbit rocket engine. It can be used to separate water into hydrogen and oxygen, the fuel that powers the Space Shuttle. However, another solution is on the horizon: the space elevator. A space elevator is a long cable, made of carbon filament, running from the ground straight up to a satellite in geostationary earth orbit, 36,000 kilometers high. Ordinary materials such as steel could never be made strong enough to reach such a distance, but carbon nanotubes 100 times stronger than steel have been developed. Within a decade, they may be made strong enough to build a space elevator.



Figure 18.2. A space elevator, seen from the geo-stationary transfer station looking down the length of the elevator toward Earth. NASA, Flight Projects Directorate, Space Elevator Concept, http://flightprojects.msfc.nasa.gov/fd02_elev.html

After one cable is run from the earth's surface to the geosynchronous platform, automatic cars can climb it, lifting other cables. Eventually, several cables can be bundled together, making a cable strong enough to lift a great weight, such as a car with many passengers or tons of freight. The elevator would be much safer and more efficient than any rocket or other aerospace craft. Although this project can be built without cold fusion, cold fusion would be the ideal source of power for it. Eventually, a vast space station might be constructed at the space elevator terminus. Sending more material up to the space station will be an advantage. The more mass that is accumulated at the geosynchronous station and the counterbalance beyond it, the better the space elevator will work. Eventually this station may include vast enclosed areas in which to assemble prefabricated deep space vehicles, and warehouses and freight transfer areas for goods bound for the Moon and the planets of the solar system.

Building huge structures in low gravity or zero gravity might be very economical compared with building even a moderate skyscraper or an enclosed space on the surface of the earth. They would not have to hold themselves up against the force of gravity, nor against forces of nature such as winds, storms and earthquakes. A large space station structure designed for human occupation would have a huge volume of air inside, and it would need immensely strong walls to contain the air. But a giant warehouse or spaceship assembly building might work just as well with a vacuum inside, since most of the workers would be robots, rather than humans wearing spacesuits. Eventually, engineers may discover it is easier and cheaper to manufacture many products in a pure vacuum, or perhaps in a low-pressure pure nitrogen atmosphere. It would be cleaner than today's best computer chip fabrication clean rooms.

Once we leave the space station terminus, we will need ships capable of crossing space to reach the Moon, Mars and other planets. An ion-drive would be a good way to power them

today, but I hope that new propulsion systems are invented that take better advantage of the large, continuous flow of energy cold fusion can produce.

A high-temperature version of cold fusion such as plasma glow discharge may be suitable for rockets. Even so, it would not give rockets unlimited range, like a cold fusion automobile, because rockets must carry propellant. Cold fusion can extend the range of rockets by lifting them high into the atmosphere with conventional engines (jets or ramjets). A rocket plane might leave the atmosphere, cruise through space, and re-enter at will. With a cold fusion-powered rocket, water might be the best propellant, because it cannot explode. It would be expelled as superheated steam, or oxygen and hydrogen. Today's rockets use explosive chemical fuel, which serves as both fuel and propellant. A water-propelled rocket would be much safer. It might eventually become safer and faster than a space elevator.

3. Personal Flying Machines

In the distant future, I hope some sort of personal flying machine will be developed. This will be a small, fully automatic aircraft for private, unscheduled use, similar to today's automobile. It will replace automobiles for most travel over 50 kilometers, so that we no longer need many highways, either above ground or below. People will fly directly to their destination in these silent machines, at a height well above the ecosphere, so as not to disrupt nature or bother anyone with the sound and sight of the passing machine. Perhaps on short hops in an urban area these machines might fly along preset paths a thousand meters above the ground, but away from the cities they should fly so high above the clouds, and they should be so unobtrusive, you will hardly be able to see them without binoculars.

A personal flying machine, or aircar, will take off and land anywhere, going from a household driveway (or roof launching pad) to the office or shopping mall parking lot. It will be fully automatic and autonomous. In other words, it will not require a pilot's license, or any action on the part of the passenger. For that matter, it will not require a passenger; you might dispatch your flyer to take Aunt Millie home, and then have it come back to your house unattended.

Central air traffic control computers will monitor the aircar at all times, and regulate all traffic. In the event of bad weather or heavy traffic, central control might order some fliers to hover and wait for conditions on the ground to clear.

Science fiction authors have imagined three kinds of aircars. Only two are physically possible according to the textbooks:

1. Antigravity machines, or reactionless drives. These would be ideal, but they appear to violate Newton's third law. If it turns out they can exist, when powered by cold fusion they would be silent and able to hover motionlessly, waiting their turn to land, without creating wind or commotion. (Whereas a million noisy gasoline-powered antigravity machines would be a nightmare.) Antigravity would also be the ideal means to propel a space vehicle. After centuries of development, they might evolve into personal flying machines that can go anywhere in the solar system.
2. Helicopters or VTOL, with fully automatic robotic operation. It seems likely that these will be developed in the next 50 to 100 years, given expected improvements in robotics and air traffic control. However, even if they were powered by cold fusion, these would make a terrific din, wind, commotion and damage, and they would kill even more birds and other

wildlife than airplanes do, because they would fly lower. A few hundred wealthy people in a large city might own them, but hundreds of thousands of people flying them over a city such as Atlanta or New York would be unthinkable.

3. Large-scale ornithopters. These are birdlike machines that flap wings instead of spinning propellers or rotors. That may sound improbable, but small-scale models have been built, and a man-carrying version is under development at the University of Toronto.¹⁷⁴ (Actually it is woman-carrying; the 1999 test, which included a brief hop, was performed by a noted female test pilot.) These would make much less noise when powered with cold fusion, and they should cause less commotion and damage from wind than airplanes and helicopters do, since the wings move relatively slowly and the wind is spread out over a large area. Like all birds and flying machines, they would have to continually push a great mass of air downward in order to stay airborne. They will be particularly quiet if they driven by EAP artificial muscles rather than mechanical gears.

Hundreds of thousands of people in urban areas will probably never be able to use aircars for commuting or shopping. Even if the machines are perfectly quiet, they will still be disruptive. They would constantly be whizzing across the sky at low altitudes as they come in for a landing. We would not want to see the famous skylines of Rome, Paris, Washington or Boston infested with swarms of small aircraft. Perhaps it would be tolerable if the machines rode along at treetop height above surface roads. But I think it more likely that wheeled vehicles will continue to serve urban areas for centuries to come, and private aircraft will mainly be useful in towns and isolated suburban and country houses, or for long trips from a city house to a distant location.

Imagine a person living in Atlanta decides to travel to Washington, D.C., a distance of 960 kilometers. Today, it takes 11 hours by car, and anywhere from 4 to 12 hours by airplane, including delays from weather and the two-hour delay in the airport spent standing on line being badgered and humiliated by security personnel. It will take four hours on the underground roads. A person who does not like to spend four hours crammed into a car might fly instead. He will begin by telling the computer to book an air taxi and have it waiting at some convenient nearby location, such as a shopping mall, or some other large building offering regional airport services for a small fee. He drives to the shopping mall, where the aircar taxi is waiting, parked in a garage. His car pulls up alongside. He steps out of the car and into the air taxi while a robot valet transfers his baggage. As his car pulls away and begins to drive itself home, the air taxi rolls out of the garage, flies straight up to a cruising altitude of 10,000 meters, and then wings its way to Washington in an hour and a half. It lands at National Airport, where a ground taxi is waiting. The air taxi joins the queue at the airport, or it flies off by itself to some other location where taxies are needed.

For trips longer than a thousand kilometers, people may still use multipassenger aircraft that depart on a fixed schedule. These will be the supersonic jet VTOL aircraft described above.

In this scenario, we would have streams of small VTOL aircraft taking off and landing from six or eight locations in a major city. Since the aircraft will go straight up, and come straight down to a handful of designated places, they would be less disruptive than aircraft would be if we allow people to take off and land anywhere they like. They would be less noisy and aesthetically jarring. Perhaps we could implement this system fairly soon, within a century, using

¹⁷⁴ Project Ornithopter, University of Toronto Institute for Aerospace Studies
http://www.ornithopter.net/index_e.html

helicopter or jet powered aircraft. Even though these would be noisy, as long as they are confined to a few areas in the city, they should be no worse than today's airplanes.

Aircars will gradually evolve to fly faster, eventually reaching supersonic speeds. Someday, people may routinely travel from continent to continent to visit friends or commute to work. No one will live more than a few hours away from anyone else on earth. They may live in the Antarctic or high in the Himalayas, hundreds of kilometers away from towns and cities, yet they will suffer no inconvenience. The robot appliance repairman or human babysitter will come to their door as quickly as they do today.

Millions of people will routinely fly from continent to continent, crossing international boundaries. It is hard to imagine a million customs inspectors and border patrol police chasing after this vast crowd of people. I hope that eventually the whole dreary business of nation-states, borders, immigration, and the rest will wither away, and everyone will be free to live anywhere in the solar system they please. The names of countries will only be used for postal addresses, and we will cross from one country to another with less notice than we travel from Virginia to Maryland. If this seems like a distant dream, consider that in 1945 the nations of the European Union were at war with one another, but today there are no border checks between them, they use the same money, and any citizen of the E.U. can live in any member country.

Part IV: The Future

19. Making Things Worse, and What Some Pessimists Fear

It cannot have escaped the reader's attention that while the marvelous new gadgets and sublime capabilities I have described might make life wonderful, they might make things worse, if they fall into the hands of a dictator, terrorist, or an irresponsible corporation or government. Underground high-speed automated roads must have gatekeeper robots and traffic control computers to watch over the cars. A despot might use the gatekeepers to keep track of citizens. Although I doubt that a cold fusion nuclear bomb is possible, I can think of many other ways cold fusion might kill people, or ruin their lives and make life hell on earth.

Cold fusion can bring us a little closer to Utopia, that elusive ideal. It can certainly bring health, leisure and material wealth to everyone, which is probably as close to Utopia as we can wish for. But Dystopia is always a possibility. People can turn any blessing into a curse. Ever since we invented tools and began to shape our own environment, we have shaped our own destiny.

When cold fusion was first announced in 1989, some extreme environmentalists feared for the worst. A. Lovins, J. Rifkin and others said they hoped cold fusion was an experimental error because it would give mankind too much power.¹⁷⁵ They compared it to giving a baby a machine gun. Rifkin said, "the [cold] fusion findings are the worst news that ever happened. Right when we are beginning to develop a global awareness of problems of global society, here come some scientists saying we don't have to deal with these problems." I do not understand this logic. If, in fact, we no longer have to deal with "these problems" — pollution and the energy crisis — we can deal with other problems instead. It is not as if we are running short of calamities. Cold fusion can do nothing to solve the U.S. health-care crisis, AIDS, crime, racial intolerance and religious wars. It will not educate the millions of illiterate people in the world. Does Rifkin think our only problems are pollution and the energy crisis, and it would be a shame to fix them because we would have nothing left to worry about? In any case, we can easily destroy the earth with the technology we already have. We do not need cold fusion, nuclear bombs or any advanced technology. We are using fire, man's oldest tool, to destroy the rain forests. The ancient Chinese, Greeks and Romans deforested large areas and turned millions of hectares of productive cropland into desert. The destructive side effects of technology in 2000 BC were as bad as they are today.

Cold fusion surely will enhance people's ability to commit everything from public nuisances to continental-scale mayhem. Gigantic cold fusion powered boom boxes and laser light shows may blast popular music and bright lights into neighborhoods, beaches and pristine National Parks. People may be tempted to drive SUVs the size of Mack Trucks, since they will not have to pay for gasoline.

It is easy to see how cold fusion might be used to reduce the amount of carbon dioxide in the atmosphere, allaying the threat of global warming. Perhaps someone will find a way to profit from cold fusion by drastically increasing levels of carbon dioxide or some other pollutant. If you devise a way to earn an easy \$100 per acre by incinerating a rain forest, or killing off a

¹⁷⁵ Mallove, E., *Fire From Ice*. 1991, NY: John Wiley. p. 86

thousand tons of ocean krill, you can bet someone will do it unless laws are passed forbidding the practice. Unfortunately, many U.S. laws have the opposite effect. They subsidize ethanol production, urban sprawl, \$80,000 corporate Hummer SUVs, and other mindless environmental destruction.¹⁷⁶ I have extolled the benefits of putting roads underground, making machines quieter and less obtrusive, and putting factories in places people do not want to live, such as desert wastelands or even on the Moon. In the short term at least, it seems more likely that developers in America will take advantage of cold fusion in their frenzied rush to build more giant shopping malls, converting the most verdant, beautiful land in the world into a wasteland of filthy, oil-stained, litter-filled parking lots and empty, bankrupt big-box super-stores.

Cold fusion will give us wider choices and more opportunities. It will give us the means to undo nearly all of the damage we have done in the past, and to make life better for everyone. We may use it wisely. Our ancestors often choose wisely and accomplished many wonderful things, after all. They improved life for everyone, and abolished inhuman institutions such as slavery and child labor in the U.S., although sadly these practices survive elsewhere in the world. They stemmed the wholesale destruction of species from buffalo hunting and whaling. The blue whale, the world's largest mammal, is still endangered, and the numbers are still falling, but it may yet recover from the deprecations of the 19th century. Japan has greatly reduced air pollution since the 1960s. (See Chapter 16.) People have made tremendous progress in the past. Whether they will continue to do so now depends upon the will of the public and the wishes of voters. I believe the majority of people favor scientific research and the responsible use of new technology. Most people will do the right thing, once the issues are clearly explained by the media and by moderate political leaders.

Most people are sensible and right-minded. Our species would not have survived otherwise. Democracy and the free market system would never have worked. History has been a test of strength between the rapacious, foolish, greedy, shortsighted minority and the sensible majority. So far, in cold fusion, the fools have won every round, suppressing nearly all research. I have had a ringside seat at this fiasco. No one knows better than I how powerful the fools can be, and how badly the cold fusion researchers have muffed the few opportunities that have come their way. Without public support, researchers will never receive funding, yet they have often scorned opportunities to convince the public of the validity of their work. But history shows that people have often changed their minds, reformed, overcome great difficulties, and beaten back hordes of fools and angry naysayers. History gives us guarded hope that things may yet turn out as I have predicted here.

1. Nihilists and Naysayers

Pessimism is fashionable nowadays. Educated, comfortable, influential people and leaders in science and technology, such as J. Horgan, a senior writer at the *Scientific American*, say we have reached “the end of science.”¹⁷⁷ From now on, we will only fill in details and add decimal places to the fundamental constants. There may be marginal progress in esoteric theory, but

¹⁷⁶ Ethanol from corn is an energy sink, not an energy source. It takes 1.7 megajoules of fossil fuel to produce 1 megajoule of ethanol fuel. See Pimentel, D. and M. Pimentel, *Food, Energy, and Society, Revised Edition*. 1996: University Press of Colorado, chapter 19. The ethanol lobby claims the ratio is 0.6 megajoules to make 1 megajoule, which is still absurdly inefficient.

¹⁷⁷ Horgan, J., *The End of Science: Facing the Limits of Knowledge in the Twilight of the Scientific Age*. 1996: Helix Books.

experimental science has run its course and can reveal nothing new. Others say we have reached the end of history, and in the future we can only hope to muddle through a little better off than we are now. Society, economics, and politics are beyond improvement. The *New York Times* says that energy independence is “an unattainable goal” (see Introduction). This can only mean the consensus view is that the energy crisis cannot be solved and we will remain primarily dependent upon oil for the foreseeable future.

I doubt there is a grand organized conspiracy to prevent cold fusion research. If there is, the conspirators do not invite me to their meetings. My sense is that opposition springs from greed, laziness, know-it-all irrationality, ignorance, and this newly-fashionable nihilism. Scientists who should know better than to judge a claim without first doing their homework have not bothered to read the literature, let alone read it thoroughly and objectively. Horgan typifies the defeatist, irrational, anti-science crowd. He, his editor Rennie, and the others who oppose cold fusion have never published scientific papers to back up their views. They have never offered a falsifiable argument. They say that their views are based on the majority opinion and the “consensus,” as if science were a popularity contest. Rennie boldly told me it is not his job to understand the technical issues or offer a falsifiable argument. He thinks the public does not expect that of him.¹⁷⁸ A normal scientist would be ashamed to admit he harbors such strange ideas, but Rennie brags about them.

Many opinion makers have lost faith in progress. They do that periodically, cycling back-and-forth between contempt for technology and misplaced awe in it. In the 1960s and 70s technology was considered a snare and a delusion. People imagined the fruits of new technology could take on an ominous Frankenstein’s monster-like life of its own, and exude a magical ability to alter human nature. Librarian of Congress Daniel J. Boorstin wrote in *Time* magazine: “The Republic of Technology where we will be living is a feedback world. There wants will be created not by ‘human nature’ or by century-old yearnings, but by technology itself.”¹⁷⁹

In the 1980s popular culture swung to the opposite extreme. The computer was crowned by *Time* magazine as its Man of the Year (the first and only time an inanimate object has held that honor). Programmers and the creators of the Internet were glorified. Both extremes are typical of people who know little about how machines work, and how they come to be. Technology is only a tool, and can be used as easily for good as for evil. We can eliminate most of the pollution in Yokkaichi, or we can make thermonuclear bombs. Of course one must distinguish between the tools at our command. Some are only meant to cause harm or mischief. Perhaps it makes sense to hold companies that make handguns or radar detectors culpable for part of the mayhem they cause. But to blame general-purpose technology for our problems is like suing the hardware store because someone bludgeoned you with a hammer.

At the opposite end of the spectrum, as far from Horgan, the *Times* and the end of history crowd as you can go, Arthur C. Clarke wrote in 1963:

The heavy hydrogen in the seas can drive all our machines, heat all our cities, for as far ahead as we can imagine. If, as is perfectly possible, we are short of energy two generations from now, it will be through our own incompetence. We will be like Stone Age men freezing to death on top of a coal bed.

¹⁷⁸ *Appeal to Readers*, LENR-CANR.org, <http://lenr-canr.org/AppealandSciAm.pdf>

¹⁷⁹ Florman, S., *Blaming Technology*. 1981: St. Martin’s Press, p. 7. The quote is from 1977.

. . . there need never be any permanent shortage of raw materials. Yet Sir George Darwin's prediction that ours would be a golden age compared with the aeons of poverty to follow, may well be perfectly correct. In this inconceivably enormous universe, we can never run out of energy or matter. But we can all too easily run out of brains.¹⁸⁰

In 1818 Thomas Jefferson wrote:

And it cannot be but that each generation succeeding to the knowledge acquired by all those who preceded it, adding to it their own acquisitions and discoveries, and handing the mass down for successive and constant accumulation, must advance the knowledge and well-being of mankind, not *infinitely*, as some have said, but *indefinitely*, and to a term which no one can fix and foresee. Indeed, we need look back half a century, to times which many now living remember well, and see the wonderful advances in the sciences and arts which have been made within that period. Some of these have rendered the elements themselves subservient to the purposes of man, have harnessed them to the yoke of his labors, and effected the great blessings of moderating his own, of accomplishing what was beyond his feeble force, and extending the comforts of life to a much enlarged circle, to those who had before known its necessities only. That these are not the vain dreams of sanguine hope, we have before our eyes real and living examples.¹⁸¹

These are the traditional views, and the wellsprings of our civilization.

People have always felt a measure of antipathy toward technology. This is understandable, given some of the horrendous machines and weapons humanity has inflicted upon itself, but the particular brand of Luddite philosophy espoused by Rifkin has lingered since the 1960s, and it has colored people's ideas about cold fusion. Anything nuclear is, naturally, suspect. Cold fusion is accused of being a false promise, like nuclear fission. People often ridicule John von Neumann for saying in 1956, "[A] few decades hence, energy may be free — just like the unmetered air." In 1954, at the height of postwar optimism, Atomic Energy Commission head Lewis L. Strauss made predictions similar to the ones in this book:

It is not too much to expect that our children will enjoy in their homes electrical energy too cheap to meter, will know of great periodic regional famines in the world only as matters of history, will travel effortlessly over the seas and under them and through the air with a minimum of danger and at great speeds, and will experience a lifespan far longer than ours as disease yields and man comes to understand what causes him to age.¹⁸²

It is foolish to dismiss the likes of von Neumann or Strauss. They were wrong by several decades, but in the long term they will undoubtedly be proven correct. With or without cold fusion, methods will be discovered to generate all of the energy we want. Methods will be discovered, that is, unless the Rennies and Rifkins prevail. Schwinger feared that "censorship will be the death of science." (See the Introduction). Martin Fleischmann says, "People do not want progress. It makes them uncomfortable. They don't want it, and they shan't have it."

Fleischmann is discouraged and understandably disillusioned. He has put up with more villainous and vicious personal attacks than any scientist in recent history. Naturally, I share his

¹⁸⁰ Clarke, A.C., *Profiles of the Future*. 1963: Harper & Row, Chapter 12.

¹⁸¹ Jefferson, T., *Report of the Commissioners for the University of Virginia*, August 4, 1818, <http://etext.virginia.edu/toc/modeng/public/JefRock.html>

¹⁸² Strauss, L., *Speech to the National Association of Science Writers*. 1954: New York City.

sense of outrage, but I try to balance it with what I hope is realistic optimism. Cold fusion cannot prevail unless its supporters have faith and belief in the future.

Progress demands a mental balancing act. We must never be satisfied with things as they are. We must feel, by degrees, discontent with inconvenience; frustration with waste and lost opportunities; and white-hot anger at accidents, pollution, and starvation that might easily be prevented. Yet we must not give in to despair, and we must never stop imagining ways these problems can be fixed, and things can be improved. Progress may not continue infinitely, but as Jefferson said it will continue “*indefinitely*, and to a term which no one can fix and foresee.” We are nowhere near the limits yet. Were the empire of the unknown as large as North America, we have established a few settlements on the coast; we have some notion how large the continent may be, and we are still debating whether California is an island or a peninsula. There are 3,000 miles of unexplored wilderness to the west. Even this analogy is an understatement. The unknown and unexplored facets of nature will never decrease in number. Each new answer reveals dozens or scores of new mysteries. We will, someday, run out of gumption and stop seeking answers, but we can never run out of questions.



Figure 19.1. A French map of North America circa 1760, published after it was established that California is a peninsula, not an island, and Florida is an archipelago. Collection of the author.

20. Unemployment

The widespread introduction of cold fusion might hurt the economy and cause personal anguish by increasing unemployment in some sectors of the economy, especially the fossil fuel and electric power industry. But the impact may not be as large as you might think, at least not in industrialized countries. The U.S. energy sector is gigantic measured in dollars, but it employs a surprisingly small number of people.¹⁸³ Cold fusion will probably cause more serious, widespread unemployment and social unrest in nations that export oil such as Russia, Venezuela or Saudi Arabia.

The first jobs to be adversely impacted by cold fusion will be in the fossil fuel industry, especially in the oil industry. Oil is the most expensive fuel per joule, and one of the world's largest imports. It is the biggest commercial product on earth, measured both in dollars and tonnage.

Almost all oil-based fuel is used for transportation. Some is used for aircraft, ship and railroads, but most is refined into gasoline for cars. As soon as cold fusion models appear, sales of gasoline models will plummet, for the following reasons:

1. Gasoline is one of the biggest and most visible expenses in the average household, so cars will be among the things consumers will most want to replace with cold fusion powered models.
2. Most cars wear out after 5 or 10 years and must be replaced anyway. As long as you have to buy a new car, you might as well buy a cold fusion model.
3. There are many competing manufacturers. All will be anxious to grab market share with the new cold fusion models, so they will develop them at a breakneck pace.

Even if oil continues to sell for several years, oil companies will see that the end is coming. They will abandon maintenance and new construction projects, and use up the equipment they have. Oil expert Kenneth Deffeyes¹⁸⁴ believes they are already doing this because they know that oil supplies have peaked and will soon decline rapidly. By the time they are ready to quit, their refineries and oil tankers will be ready for the scrap heap. If, in the interim period, a dilapidated tanker or oil pipeline has a serious accident, the public will demand that the industry be liquidated even more quickly. (See Chapter 7, Section 4.)

The electric power and natural gas companies are also doomed in the long run, but they will remain competitive with home generators for considerably longer than gasoline powered cars will compete in the marketplace with cold fusion cars. Power companies may even adopt a 'if you can't beat 'em, join 'em' attitude, and replace some of their coal and fission plants with large, centralized cold fusion power plants.

Because it takes a long time to design a new automobile and build new production lines, it may be many years before the first models hit the showrooms, and the transition to cold fusion cars begins. But once it does finally begin, it will be swift. Ten years after the first cold fusion car is sold, gasoline cars will have disappeared. (See Chapter 7, Section 2.)

¹⁸³ Bureau of Labor Statistics "Establishment Data Employment Seasonally Adjusted," <ftp://ftp.bls.gov/pub/suppl/empsit.ceseeb3.txt>

¹⁸⁴ Deffeyes, K., *Beyond Oil, the View from Hubbert's Peak*. 2005: Hill and Wang.

Jobs directly related to fossil fuel technology fall in these categories:

Table 20.1. Jobs Related to Fossil Fuels, From: Bureau of Labor Statistics “Establishment Data Employment Seasonally Adjusted,” <ftp://ftp.bls.gov/pub/suppl/empsit.ceseeb3.txt>, July 2004 column.

Industry	Workers
Oil and gas extraction	132,000
Coal mining	75,000
Support activities for mining	185,000, but only about 56,000 for coal mines
Petroleum and coal products	113,000 but many are non-energy related
Gasoline stations	868,000

The total is about 1.2 million workers. Nineteen percent of oil production goes to non-energy products, such as plastic feedstock and fertilizer. These products are more labor intensive than gasoline. At first, they will not be affected by the changeover to cold fusion. Later, after years of additional research and development, these petrochemical-based materials may be synthesized using cold fusion heat. This will hurt the oil companies, but the plastics factories and synthetic refineries should need roughly as many workers as oil-based feedstock equipment does, so it will not reduce employment.

Seventy five percent of the workers listed in Table 20.1 are in low-pay, dead-end jobs at gas stations. Night shift gas station attendants are robbed so often, theirs is most dangerous job in the U.S. The only well-paid people in a gas station are the owner and the mechanics. Mechanics will still be needed to maintain cold fusion cars. Gas stations make most of their profits from inside sales of food, beverages and sundries. Some may remain in business as neighborhood convenience stores, and on the highways to serve travelers.

To put 1.2 million jobs in perspective, 2.8 million people work in food and beverage stores, where pay and job benefits are usually better than at gas stations. Since people will buy the same amount of food, beverages and sundries with or without cold fusion technology, we will need roughly the same number of cash register clerks selling such things. The gas station clerk who moves to a regular grocery store will probably have a better job.

These employment projections may underestimate the number of jobs that could be lost, because other industries may be substantially adversely impacted. For example, one fourth of the world's ships are oil tankers, so shipbuilding may be reduced. On the other hand, it may increase, because cold fusion would be ideal for new Fast Ships or hovercraft, and cold fusion will lower the cost of all transportation, which may spur a worldwide boom in trade.¹⁸⁵

Electric power companies will gradually be pushed into bankruptcy, causing some inevitable unemployment. But the power companies will remain viable longer than the oil companies, so the decline will be gradual, taking many years. It should have a less immediate and catastrophic impact on the workforce. Most power company employees are well-paid, skilled linemen and technicians, unlike the 75% of the fossil fuel employees who work as gas stations clerks. Their

¹⁸⁵ With conventional ships, fossil fuel costs are moderate; about 5% of the total, but with Fast Ships it would be about a third of the total. Source: MGI Cargo Analyst, *Fast Ships*, <http://www.mergeglobal.com/fastship.pdf>

skills will remain valuable and sought after. Indeed, they are just the people we need for megaprojects such as massive desalination to roll back the deserts, or to put the majority of roads and highways underground. We may want to encourage the rapid dissolution of the electric power industry by offering tax credits for home generators, to give these people a chance to work where they can do more good, and earn more money.

Twenty-five percent of oil industry employees are skilled workers. They are experts at projects such as building and maintaining pipelines, and cleaning up massive oil spills. Perhaps as oil is phased out, a company such as Exxon will relaunch itself in the burgeoning environmental cleanup and preservation industry, and in the ambitious new megaprojects to remake the face of the earth. It can start by cleaning up the mess left by the 20th century. Then it can purge the land and sea of invasive species, and later it can terraform Mars. It will be ironic if 300 years from now, a corporation such as Exxon is considered a preeminent expert in preserving the ecosystem on Earth, and creating new ecosystems from scratch elsewhere in the solar system.

When people stop paying \$20 per week for gasoline, they will probably spend the money on something else instead.¹⁸⁶ They may buy more expensive cuts of meat, which will benefit those 2.8 million grocery store clerks, the 1.5 million in the “Food manufacturing” sector, and farmers. Or they may spend more on movies, which will benefit the 378,000 people who work in the “Motion picture and sound recording industries.” The money we no longer spend on oil will not vanish down a black hole. It will be recycled back into the economy one way or another.

Despite these hopeful reassurances, the loss of 1.2 million jobs over ten years is a serious problem. That is almost one percent of U.S. jobs. The overall economy could be hurt by the loss, should the politicians and business leaders panic or botch the transition. However, I think other problems with employment, such as outsourcing, may have a larger effect than cold fusion will. Consider, for example, health care. Some experts say that as much a third of the money spent on healthcare in the U.S. goes to pay for paperwork and bureaucratic overhead. In Japan and Europe, healthcare overhead is less than 5% of expenses. U.S. health care costs are about three times higher per capita than those of other advanced nations. Fourteen million people are employed in health care, and 6 million more work in “finance and insurance.” A serious reform of health care administration will put millions of these people out of a job. Furthermore, healthcare reform can only reduce employment, whereas the adoption of cold fusion will create some new jobs even as it abolishes others.

Decades from now the robot chickens described in Chapter 10 may reduce employment, but that will be a problem for our children and grandchildren to worry about. There is already a great deal of unemployment for reasons that have always baffled me. Everywhere you look, you see work crying out to be done. Houses, buildings and streets need repair. Children in schools need more time with teachers, tutors and mentors. Software is sloppy and written in haste. Mechanics and repairmen work long hours. All of the scientists and researchers I know work 10 hours a day, 5 or 6 days a week, even when they are supposedly retired and are no longer paid. I know little about economics, but employment seems to have little or no connection with the amount of work that actually needs to be done.

Most of the people who will be adversely affected by the collapse of oil will be wealthy stockholders and oil sheiks, who can take care of themselves. They have already been given 18

¹⁸⁶ Energy Information Administration, *Annual Energy Review 2002*, p. 61. The average motor vehicle consumed 532 gallons of gasoline in 2001. At \$2 per gallon, this comes to \$20.46 per week.

years advance warning that their industry has no future. If they have not invested in cold fusion or taken other steps to preserve their fortunes, they have only themselves to blame.

21. My Vision of Life In The Distant Future

“. . . a small boy [who] took a special delight in climbing an old tree . . . to pick and eat ripe sickle pears. In the spring of the year, he sailed his toy boats in the surface water of the melting snow. In the summer with his dogs he dug into woodchuck holes. And he used to lie flat between the strawberry rows and eat sun warmed strawberries — the best in the world.”

– Franklin Roosevelt describing himself as a child ¹⁸⁷

“So we may hope, therefore, that one day our age of roaring factories and bulging warehouses will pass away, as the spinning wheel and the home loom and the butter churn passed before them. And then our descendants, no longer cluttered up with possessions, will remember what many of us have forgotten — that the only things in the world that really matter are such imponderables as beauty and wisdom, laughter and love.”

– Arthur C. Clarke ¹⁸⁸

What should we do with cold fusion in the future? I hope we will use it to turn back the clock. I would like to see many of the outward, tangible aspects of daily life — and the roads, parks and houses — gradually revert back to the way they were in 1950, or even 1920. Visions of great roaring cities cooled by massive air conditioners make me cringe. A few roaring cities would be fine, but I think the majority of people would be happier with a quiet life in intimate, pedestrian friendly cities such as Georgetown in Washington, D.C., or dwelling peacefully in the tranquil countryside.

Technology is best when it is invisible. Cold fusion and other breakthroughs should be used to banish the big, noisy machines that do the essential work of civilization, such as manufacturing and recycling, to places people do not want to live, such as deserts, underground, or the moon. If anyone hears a machine, it is too loud. If anyone is bothered by one, it is too intrusive.

I hope cold fusion will enable us to invent ways to eliminate pollution, danger, noise, and irritating, time wasting things such as traffic jams. We should put automobiles underground, out of sight, and make them fully automated so they never hurt anyone again. If we must have shopping malls and fast food restaurants, put them underground too. Let us have no more highways and hulking, buzzing, ugly power line bisecting the countryside, but only narrow, quiet, shady, bucolic byways that are perfectly suited for bicycling, walking and flirting, like the country roads in England. In the 20th century, people decided it was no longer acceptable for families to live cheek-by-jowl next to steel mills, pit mines, or noisome slaughterhouses and soap factories. So why do we still live next door to highways? A highway is an industrial plant, like a factory. We must have highways, obviously, but they should not impede on anyone's neighborhood, ruin the view, or bother anyone.

We should banish bright light and noise at night, so everyone can see the stars and fireflies, hear the frogs croaking, and sleep peacefully. When we are cold in winter, let us light a wood fire in the fireplace, and have a hidden, silent gadget in the chimney scrub the smoke to remove any pollution.

¹⁸⁷ Miller, N., *F.D.R., An Intimate History*. 1983: Doubleday, p. 18

¹⁸⁸ Clarke, A.C., *Profiles of the Future*. 1963: Harper & Row.

Starting in the late 1960s there was a refreshing and long overdue change in the public's attitude toward technology. People were no longer willing to be pushed around. In the 1950s we savagely destroyed city neighborhoods in Boston with elevated highways, ruining some of the oldest historic urban landscapes in America, and spreading smoke and noise everywhere. We did this so that wealthy commuters would find it more convenient to drive to work. In the 1990s we began to make amends, burying the whole filthy complex in the Big Dig project. In the 1970s we reached a similar low point in gastronomy, with the introduction of tomatoes which were deliberately bred to be hard, so they could be picked with machines and shipped unripe. This made them tasteless and odorless, like eating wet cardboard. This is a sign of backward priorities, and a damn-the-customer attitude. Nowadays food producers are scrambling to find a way to pick and ship soft, ripe, natural tomatoes. Why should we compromise our quality of life for the sake of machines? Let the product designers strive to meet our needs, and serve our fashions and whims. That is their job.

To take a morbid example: in new graveyards, the tall stone markers of yore have been replaced with flat stones, invisible until you stand right over them and look down. They are spaced equidistant apart in neat rows, all the same, all anonymous. Gone are the eccentric sculptures, rococo decorations, benches, trees, miscellaneous shapes, raised beds and the odd groupings of graves which reflected a complicated marriage or a tragic childhood. And why are graveyards now so regimented? So that one person on a riding mower can easily cut the grass. Even in death we are supposed to conform to the demands of a mechanized, streamlined aesthetic that puts cost-effectiveness ahead of tradition, and stifles individual personality and memory. Let the mower manufacturers and robot builders find a way to cut grass while avoiding complicated gravestones, trees, or woodchuck holes, flower beds and croquet wickets.

I hope cold fusion will be developed with the modern design ethic: machines must serve humanity; it should never be other way around.

Most of all, I would like to see our cities and towns made safe for children to play in. Children should live as I did in Washington, D.C. in the 1960s. They should spend every hour of daylight, all summer long, playing outdoors together, unsupervised. In pouring rain they should dam up the water in gutters or streams, and splash around in the mud. In bright sunlight they should play chess or poker on someone's front porch. Every child should have the freedom to roam through woods and fields without fences or borders, accompanied by a dog, and protected by an inconspicuous robot that tags along behind. Children learn more from nature and from playing with their friends than school, textbooks, computer games, or Little League baseball.

Despite what the newspapers say, it is not crime that destroys the social life of children nowadays, leaving them isolated and bored. It is not the Internet, or television. Crime rates in most neighborhoods are no worse than they were in the 1960s, and we never worried about such things back then, because we were always together with older children. The problem is that over the last 60 years, our architecture, city planning, suburbs, and school designs have conspired against children, robbing them of their happiness and independence. The transportation system, and the long distances to neighbors, schools, stores and movie theaters imprison them. Children cannot casually go visit a friend, or get together with a gang of kids to build a fort in the woods. Mother has to drive them everywhere. In the future, I hope that a child will be able to call for an autonomous automobile to go anywhere she pleases. Naturally, she will need her parents' permission. The car itself will have enough artificial intelligence to ask the parent. Children aged six and above will routinely speed down highways by themselves, or with friends, going

anywhere they want. This is a sensible age cut off; most airlines today allow a six-year-old child to travel as an unaccompanied minor with parent's permission.

In the distant future, centuries from now, I envision a talented 9-year-old girl commuting to advanced piano lessons twice a month. She rides by herself from a village in Sri Lanka to a music academy on the far side of the moon. The trip takes three hours, and she ignores her homework along the way, gossiping with friends on the videophone instead. During that trip, she might use more energy than a typical American today uses in a lifetime. What of it? If people in future generations expend energy at a rate a thousand times greater than we do, and they expend it for purposes we would consider frivolous, it will make no difference and cause no harm, as long as the noise and waste heat does not bother anyone or harm the biosphere. A child playing a video game today has more computing power at her disposal than any scientist had in 1970, and the machine does more calculations in a single second than an ancient mathematician did in a lifetime, yet no one considers this an extravagant waste of resources, and no one raises objections to it.

I despise the notion that poverty is ennobling, or that people want material things because they are greedy or decadent. Everyone on earth who wants a car should have a car. Or a dozen cars, a home movie theater, and a Jacuzzi. Cars are made of iron, and we have unlimited amounts of iron in the solar system. As long as those cars do not prevent me from riding my electric bicycle, or destroy the world with ugly highways, noise, smoke, filth and carnage, people should have as many vehicles as their hearts desire. Samuel Florman wrote:

Our contemporary problem is distressingly obvious. We have too many people wanting too many things. This is not caused by technology; it is a consequence of the type of creature that man is . . .

It is common knowledge that millions of underprivileged families want adequate food and housing. What is less commonly remarked is that after they have adequate food and housing they will want to be served at a fine restaurant and to have a weekend cottage by the sea. People want tickets to the Philharmonic and vacation trips abroad . . . The illiterate want to learn how to read. Then they want education, and then more education, and then they want their sons and daughters to become doctors and lawyers. It is frightening to see so many millions of people wanting so much. It is almost like being present at the Oklahoma land rush, except that millions are involved instead of hundreds, and instead of land, the prize is everything that life has to offer.¹⁸⁹

Florman thinks that most people have sensible and moderate desires, but "the problem arises only when we put all those moderate desires together and find there is not enough of the good things to go around." As long as the supply of material goods and energy are limited, our population remains high, and our houses, highways, factories and shopping malls encroach on land that birds, turtles, fungi, fish and other wildlife need, we must be frugal.

It is immoral to buy dozens of cars or live in a sprawling mansion when other people are starving, and other species are endangered. The long-term solution is not to try to limit people's desires. That is impossible; as Florman says, people: ". . . will not stand still for vague promises of psychic contentment that is to follow in the wake of voluntary temperance. Man has not come this far through the evolutionary furnace to settle for a bucolic idyll." The solution is to remake

¹⁸⁹ S. Florman, *The Existential Pleasures of Engineering* (St. Martin's Griffin, 1996), p. 76

the world, and ultimately the whole solar system, so that everyone can have practically unlimited amounts of material goods. Most people, when given all the all the money they want, are satisfied with a moderate, sensible, responsible lifestyle.

In the future, I hope that dire poverty will be eliminated everywhere on earth. People should have as much food and water, health care, higher education and Internet access as they want. These things should be free, like street lighting, public libraries and public elementary education are today. This does not mean I hope everyone will be able to live the way wealthy people do today, or I hope that great wealth will be abolished. I do not advocate communism. I would like to see everyone to achieve an American or European middle-class standard of living. I do not care whether there are a moderate number of people richer than that. Perhaps a few million lucky people worldwide, such as lottery winners and captains of industry, will live on a grand scale, ostentatiously, like some of today's movie stars and moguls.

Some resources are inherently limited. Only a few people can live in prime real estate in Manhattan. Only a few can occupy vaunted political offices, top corporate positions, or hold university presidencies. Still, anyone who wants a comfy country cottage deserves to have one. We cannot all fit into the Hamptons, but there are any number of other beautiful spots in the world. We can make room in the countryside by getting rid of highways, factories, and hundreds of miles filled with depressing fast food joints. Many places now ugly were beautiful when I was a child, and shall be made beautiful again. We can undo our mistakes. We probably need to reduce the population too, perhaps by having a few billion people migrate to the Moon and Mars. (Nature is just as beautiful on other planets, and I hope that someday we will terraform Mars and people will walk there without spacesuits.)

Traditionally, people have assumed that poverty is inevitable. "For ye have the poor always with you . . ." This attitude has become an excuse to evade social reform. Poverty is a personal tragedy, and a threat to the community, the economy and national security. It is no more inevitable than infectious disease, pollution, smoking indoors, illiteracy, open sewers, or any of the other scourges we have eliminated. We can bring everyone up to a middle class level of income and security with enlightened social policy, education, capitalism, and clever new technology — especially cold fusion. The nihilists, whose day this is, say we have reached the end of history and there is no hope of great wealth or improvement in the future. Others say it is human nature to exploit people, there must always be winners and losers, someone has to hew the wood and draw the water, et cetera. In short, they say someone must be poor. Perhaps they feel there is not enough worthwhile work to go around, or enough books in the library for everyone to read.

People who think that life will never be better for the masses do not understand that these downtrodden billions are not faceless specks, they are people like us, and given half a chance — no, given *one-tenth* the opportunities we are blessed with — they will achieve for themselves all that we have. A billion people in China will buy cars. If they buy gasoline-powered cars, the world may be plunged into an unprecedented disaster of global warming, and it will surely run short of oil in a decade. Corporations and governments have two choices: they can stand by and

do nothing while Chinese people buy gasoline cars, or they can begin serious cold fusion research, and offer them cold fusion powered models instead.¹⁹⁰

People who believe there is no likelihood of dramatic progress have no sense of history. Everyone living in the first world today, even a wretched person on welfare, is well off by the standards of 1600. By the standards of ancient and primitive people, we are all fabulously wealthy and we enjoy godlike powers. We can do things that people in 1800 never imagined, in their wildest dreams or worst nightmares. We can talk to friends anywhere in the world, and see recorded events that happened years ago. In a few seconds, we can find any one of millions of books, newspapers, or facts recorded on the Internet. We have unlimited clean water, and all the food we can eat. More, in fact, than we should eat. We have banished most dread diseases. We can repair the heart itself, or implant a new heart, and recover from injuries that would have been beyond hope a few generations ago. We can fly halfway around the world in 14 hours. A friend of mine, on a whim, flew from Hiroshima to Atlanta over a four-day holiday weekend just to visit and enjoy a concert. Our scientists explore other planets with remote control robots. Then too, with a half-hour notice, our military could annihilate any nation on earth, destroying thousands of cities, and killing a hundred million people.

The ultimate purpose of cold fusion, or any technology, is to give people the freedom to do for themselves, take charge of their lives, and make themselves happy or miserable. The immediate goal of cold fusion should be to restore life back to some semblance of what it was before the population boom and the dark satanic mills of industrialization took hold. Of course some people prefer cities and dark satanic nightclubs, but I hope most will choose to live close to nature. Except they will have full access to television, the Internet, grocery stores, hospitals and all other modern conveniences and necessities. I am not suggesting anyone should go “back to nature” and live in primitive conditions, unless they want to. People should live in harmony with nature, not disturbing it more than they need to, but *never again* should anyone have to live at nature’s mercy. No one should fear that drought might destroy his livelihood. No one should fear infectious disease. I hope that no one will live in thrall of tyranny, terror, crime or war, but alas, technology can do little to solve these problems.

I hope our first goal will be to improve the lives of children. Perhaps this springs from an elegiac longing for my own childhood, but that is a fine motivation. Franklin Roosevelt had an idyllic childhood in the Hudson River Valley. It was the prime source of his reforming spirit, and his indomitable optimism and faith in the future. He returned to his childhood home often, and he insisted the house and grounds be left as he remembered them. For rest of his life he felt that all children deserved the same happiness he had enjoyed. That is a worthy goal for our civilization, at least for the next few hundred years. Perhaps we will go on to initiate epic projects such as conquering interstellar space or understanding the origin of the universe, but for now let us put things right for our children, and for other species, and clean up the mess left by the 20th century. It may be expensive, but if we cannot afford to make our children safe and happy, what is money for?

¹⁹⁰ Chinese researchers are working on cold fusion, and they are doing a fine job with minimal funding and rudimentary resources. See: *The 9th International Conference on Cold Fusion, Condensed Matter Nuclear Science*. 2002. Tsinghua Univ., Beijing, China: Tsinghua Univ. Press.

The simple pleasures of walking in the woods or swimming in a pond on a hot summer day should be the birthright of every child. Everyone should be free to walk out of the door alone at daybreak, along a deserted, frost covered path to the upper field where a hawk cries out, and a deer suddenly darts out across the meadow and runs *right there*, directly in front of you.

Imagine it is a winter evening in the year 2204. On a whim, you might go visit the moon for the weekend, where some friends have a team of robots building a 2-million square meter radio telescope to test a pet theory. This is a 22nd century version of a modest, privately funded physics experiment, like a cold fusion experiment today. But instead, you decide to stay home in Frederick, Maryland. You might have the robot bring you a nice cup of cocoa and light a fire. I would; I find fires more interesting to watch than television. For those who prefer noisy distractions, you will have an Internet connected, 2-meter-wide flat panel television that shows any program, movie, documentary, news broadcast or concert recorded in the last two centuries anywhere on earth. Or you can hook the screen up to a friend's house for an impromptu visit, and converse with their life-sized image. You might view a live sporting event. Or you might convert the screen into a large real-time web cam projector overlooking the Grand Canyon, Mount Fuji, the Himalayas, or the view on the Moon from Montes Apenninus overlooking the Mare Imbrium, if your taste in landscapes runs to the dramatic. But if you are like me, and you prefer the secret, silent places, you might select the view shown by an unobtrusive, noiseless camera hidden in a tree 50 kilometers to the north, that looks out over that still silent, frozen, moonlit meadow where I walked two hundred years earlier.

Appendix A: Glossary

This glossary is adopted from Mizuno's book *Nuclear Transmutation: The Reality of Cold Fusion*.¹⁹¹ Some of the terms defined here are not used in this book, but a reader interested in cold fusion will soon encounter them.

Alpha particle, alpha decay

See Radioactive decay

Amperage, Voltage

See Volt

Anode

The positive electrode in an electrochemical cell, which attracts oxygen. (See electrode; electrolysis.)

Atom; atomic nucleus, chemical versus nuclear reactions

The smallest unit of an element, consisting of a positively charged nucleus surrounded by a cloud of negatively charged electrons. Most of the mass of atom is concentrated in the nucleus, which is made up of protons and neutrons. Chemical reactions affect only the electrons, leaving the nucleus unchanged. Nuclear reactions affect the nucleus, transmuting the atom into a different element or isotope.

Beta particle, beta decay

See Radioactive decay

Btu (British Thermal Unit)

The heat needed to raise one pound of water by 1°F. 1 Btu = 1,055.06 joules.

Calibrate

In the first phase of an experiment, an instrument is calibrated by measuring a known quantity, or by comparing it against a standard, higher quality instrument. For example, a thermometer might be calibrated by dipping it into ice slurry, which is at 0°C (by definition) and boiling water at 100°C. Or, it might be calibrated by placing it a beaker of warm, stirred water along with two other high quality thermometers. As the water cools the temperatures shown on all three thermometers is noted, and a correction factor is determined for the target thermometer.

A calorimeter might be calibrated by placing an electric heater in the sample chamber, and running 1 watt through the heater for several hours, then 2 watts, 3, 4 and 5 watts. At each power level the calorimeter stabilizes at a particular temperature, when the heat going into the water is balanced by losses out of the calorimeter walls to the surroundings. Suppose you find that at 1 watt the temperature settles 2.4°C above the surrounding temperature; at 2 watts, 4.8; at 3 watts 7.2 and so on. You graph these temperatures to make a calibration curve, and you determine the

¹⁹¹ Mizuno, T., *Nuclear Transmutation: The Reality of Cold Fusion*. 1998, Concord, NH: Infinite Energy Press. Eugene Mallove and I wrote this glossary.

calibration constant is 2.4°C per watt, or 0.42 watts per degree Celsius. Later, a sample placed in the calorimeter raises the temperature 5.1°C. You know that the sample is producing 2.1 watts of heat.

This method of calibration works because the electric power consumed by the heater in the chamber can be measured with great precision and the power remains stable over time. The calibration will be less reliable with poor quality meters and a low quality power supply which produces fluctuating power. The greatest difficulty in calibrating a calorimeter is often noise introduced by changes in the temperature of the surroundings.

In a cold fusion experiment, calibration and other testing of the instruments may take months.

Calorie

The energy required to raise one gram of water by one degree Celsius. This equals approximately 4.19 joules (watt-seconds). Note that a “dietary” or “large calorie” equals 1,000 calories (1 kilocalorie). The energy content of food when oxidized in the body is measured in large calories.

Calorimeter

An instrument that measures the heat generated by an exothermic process, or the heat absorbed by an endothermic process. Conventional, old-fashioned calorimeters surround the sample with water. The sample heats (or cools) and the water temperature rises (or falls). The mass of water and the temperature indicate how much heat energy was produced. In a modern electronic Seebeck envelope calorimeter, the sample is surrounded by panels containing hundreds of thermocouples connected in series — a thermopile. The net output from all thermocouples together indicates the amount of heat evolving from the sample.

Catalyst

A substance that modifies and usually increases the rate of a reaction without being consumed in the process. In a closed cold fusion cell, platinum mesh or beads are often used as a catalyst that causes the free deuterium gas to recombine with oxygen at low temperatures.

Cathode

The negative electrode in an electrochemical cell, which attracts hydrogen. (See electrode; electrolysis.) In a conventional cold fusion experiment, the cathode is made of palladium, which absorbs the hydrogen.

Cogeneration, or combined heat and power (CHP)

Most conventional electric power generators waste two thirds of the energy they use, generating great billowing clouds of steam from cooling towers. The steam is not hot enough to run a turbine, but it is hot enough for many industrial uses or for space heating. With cogeneration, the steam is channeled into factories or buildings where it is used. See Chapters 14 and 15.

Deuterium, tritium

Deuterium is heavy hydrogen. Ordinary, light hydrogen atoms consist of one proton and one electron. A heavy hydrogen atom has one proton and one neutron in the nucleus, and an electron. In ordinary air and water, approximately one hydrogen atom in every 6,200 is heavy hydrogen.

A tritium atom nucleus has one proton and two neutrons. Tritium is a radioactive isotope, with a half-life of 12.3 years. There is practically no measurable tritium in ordinary air and water.

Deuterium and tritium are isotopes of hydrogen.

Water made with deuterium (D₂O) is called heavy water. In contrast, ordinary water is sometimes referred to as “light water” but it actually contains one part in 6,200 heavy water. This ratio is the same in all natural water everywhere on earth, in ice, water, and steam.

Deuteride

Metal that has absorbed deuterium. See Hydride.

Deuteron

A deuterium ion; a proton and a neutron.

Electrolysis, electrode, electrolyte

Electrolysis is the passing of an electric current from one electrode to another through a liquid, which is called the electrolyte. Electrolysis breaks apart the molecules of liquid into positively and negatively charged ions. The positively charged ions are attracted to the negative electrode (the cathode), and the negative ions are attracted to the positive electrode (the anode). A water molecule consists of two hydrogen atoms and one oxygen atom. When it is electrolyzed, it breaks apart. The hydrogen atoms are positively charged so they are attracted to the cathode, while the free oxygen atom is pulled to the anode. To put it another way, oxidation occurs at the anode and reduction occurs at the cathode.

Electron volt (eV, keV, MeV)

The energy gained by an electron in passing from a point of low potential to a point one volt higher in potential. Electron Volt is abbreviated eV; kilo- and mega-electron volts are abbreviated keV and MeV. Chemical reactions typically produce a fraction of 1 eV per atom, or at most 4 or 5 eV. Nuclear reactions produce MeV levels of energy per atom. An electron volt equals 1.6^{-19} joules.

Energy versus power

Energy is heat, or the capacity to do work. Power is the instantaneous measure of energy. For example, at a given moment the power level might be 10 watts. When this power continues steadily for 20 seconds, it adds up to 200 joules. Power is analogous to speed, and energy is analogous to the total distance traveled. (Speed \times duration = distance; Power \times duration = energy) Large amounts of energy are sometimes measured in kilowatt-hours. A kilowatt-hour is 1,000 watts continued for 1 hour, or 3.6 million joules.

Excess heat

Heat generated by a chemical or nuclear reaction inside a calorimeter over and above the heat input into the cell from external sources. In a cold fusion experiment where electrolysis consumes 4 watts but the cell produces 5 watts, the extra 1 watt is excess heat. At first you cannot tell whether it is caused by a chemical or nuclear reaction. If it continues for a long time, adding up to a great deal more energy than chemical reaction might produce, and if you find no indication of a chemical reaction after the experiment terminates, you know it must have been caused by a nuclear reaction instead.

Exothermic, Endothermic

An exothermic chemical or nuclear reaction produces heat. An endothermic reaction absorbs heat. An endothermic reaction occurs in a cold fusion cell when the palladium initially absorbs a great deal of hydrogen or deuterium to form a hydride. This absorbs heat and cools the surroundings. After the current is turned off, much of the hydrogen gradually escapes from the cathode, which is an exothermic reaction. The two cancel out one another; the heat absorbed by the first reaction equals the heat generated by the second if all of the hydrogen leaves the palladium. (Actually, much of the hydrogen usually remains; it is difficult to drive it all out.) Cold fusion has produced far more heat than these chemical reactions can. In some cases it has produced thousands of times more, and in a few cases it has produced hundreds of thousands of times more.

Fission, fusion

Fission is breaking apart of heavy element atomic nuclei to form lighter elements. Fusion means building up heavier elements by combining lighter ones together. When elements heavier than iron fission, they release energy. Fissioning elements lighter than iron consumes more energy than it releases. Fusion is the opposite: the lighter the element, the more energy produces during fusion. Fusing the lightest element, hydrogen, produces the most energy of any nuclear process. This energy drives the stars.

Fission and fusion both result in transmutation: changing one element or isotope into another.

Gamma ray

Electromagnetic radiation emitted by radioactive decay. Gamma rays have between 10 keV and 10 MeV of energy.

Heat after death

In some cold fusion experiments, the palladium cathode has remained hot long after electrolysis has been turned off and the cell should have cooled. Fleischmann and Pons first reported this and called it “heat after death.”

Heavy water, light water

See Deuterium.

Helium

The second lightest element, with two isotopes: helium-3, with two protons and one neutron, which is unstable, and helium-4 with two protons and two neutrons, which is stable. Helium-4 is

the by-product of many nuclear reactions. There is good evidence that the cold fusion reaction produces it.

Hydride

A metal that has absorbed hydrogen, the way coffee absorbs sugar. A deuteride is metal that has absorbed deuterium. More generally, this means a compound of hydrogen with a more electropositive element or group.

Ion

An electrically charged atom or group of atoms. A positive ion is an atom that has been stripped of one or more outer electrons. A negative ion has extra electrons.

Isotope, isotopic ratio

An atom with the same number of protons but a different number of neutrons. One element may have several isotopes. For example, copper atoms always have 29 protons, but some have 34 neutrons and some have 36, which makes some copper atoms heavier than others. The two isotopes of copper have atomic masses of 63 (29+34) and 65 (29+36). These isotopes are designated copper-63 (^{63}Cu) and copper-65 (^{65}Cu). Some elements, like gold, have only one isotope. Most isotopes have the same gross chemical properties, but subtle differences in behavior have been observed, such as better conductivity with different isotopes of iron. There may be many more undiscovered differences between isotopes, but the subject has not been researched in detail because it is difficult and expensive to separate out isotopes and prepare pure mono-isotopic samples.

Different isotopes of an element are found in different ratios, and these ratios are fixed. For example, 69% of copper is copper-63, 31% is copper-65. With other elements the isotopic ratios are more extreme: 99.762% of all oxygen is oxygen-16; oxygen-17 is 0.038% and oxygen-18 is 0.200%. When an element is found with unnatural isotopic ratios (also called unnatural isotopic distribution), it can only have two origins:

1. It might be man-made, using a chemical or physical separation technique. Ontario Hydro produces purified heavy water for CANDU fission reactors. Uranium isotopes are separated to make atomic bombs.
2. It might come from a nuclear reaction, in which one element is transmuted into one or more other elements.

Cold fusion can change isotopic ratios, which proves it is a nuclear reaction.

Joule

A measure of energy; one watt of power maintained for one second. 1 calorie = 4.2 joules.

Kilowatt (kW)

A measure of power; 1,000 watts.

Kilowatt-hour (kWh)

A measure of energy; 1,000 watts of power maintained for one hour. 1 kilowatt-hour = 3.6 million joules (megajoules)

Neutron

A neutral (uncharged) particle in the nucleus of all atoms except light hydrogen. A neutron weighs almost exactly as much as a proton.

Palladium, Platinum, Platinum Group Metals (PGM)

These precious metals have similar properties, and the ores are often found together. Palladium absorbs a large amount of hydrogen, so it is used in hydrogen filters, hydrogenation catalysts, and cold fusion cathodes. Platinum is often used for the anode in a cold fusion cell, or as the cathode in a control run; that is, in a test that is not supposed to produce excess heat, used to calibrate the equipment in preparation for a test with palladium. Platinum group metals include iridium, osmium, palladium, platinum, rhodium and ruthenium.

Plasma

Atoms broken into protons, charged atoms, neutrons, and electrons in a highly ionized gas-like state. Plasma is electrically neutral.

Power

See Energy versus Power

Proton

A positively charged particle in the nucleus of an atom.

Radioactive decay

In radioactive decay, a particle is emitted from the nucleus of an atom, and the atom converts from element to another. There are three forms of naturally occurring (spontaneous decay) in which atoms convert themselves with no outside influence.

An alpha particle is emitted by one form of natural radioactive decay. The alpha particle is a helium nucleus: two protons and two neutrons. Alpha particles are positively charged. Alpha decay occurs with heavier elements, those above the middle of periodic table. Two other forms of radioactive decay occur with uranium and heavier elements: spontaneous fission and beta decay. Spontaneous fission occurs when a heavy element splits into two nearly equal fragments, forming two atoms of lighter elements. Beta decay involves electrons emitted from or captured by a nucleus. Since electrons are much lighter than protons and neutrons, the mass of the atom changes only a little, the mass number remains the same, but the element is transmuted into another element. For example, tritium (super-heavy hydrogen) consists of a proton and two neutrons, mass number 3. When tritium undergoes beta decay, a neutron converts into a proton, one electron is emitted, and the atom transmutes from hydrogen into helium-3 (two protons, one neutron), still with mass number 3. There are three kinds of beta decay:

1. Negative electron beta decay, in which a neutron converts to a proton, an electron is emitted, and the element transmutes to the next higher element.
2. Positron emission, in which a proton converts into a neutron and a positive electron (a positron) is emitted, and the element transmutes to the next lower element.

3. Electron capture, also called K-capture. An electron from the lowest orbit (the K shell orbit) is captured by a proton, which converts to a neutron, and the element transmutes to the next lower element.

These are natural forms of radioactive decay, meaning the atoms change by themselves, in contrast to nuclear changes which occur when a mass of material is gathered inside a reactor or a nuclear bomb, or when neutrons from a reactor bombard material. In this case, neutrons from one reaction cause another reaction in another atom.

Radwaste (radioactive waste)

Waste left over from uranium mining, nuclear power generation, or nuclear weapons production. The disposal of radwaste is a major problem.

Thermoelectric Chip

A thermoelectric chip converts heat into electricity without moving parts, similar to the way a photovoltaic chip on a calculator converts light into electricity. Thermoelectric devices are reversible heat pumps. When you expose a thermoelectric device to heat, it generates electricity (the Seebeck effect), and when you run electric current through a thermoelectric device, it draws heat from one side to the other, acting as a heat pump or refrigerator (the Peltier effect). Present day thermoelectric chips are inefficient, so they are seldom used to generate electricity. They are mainly employed as refrigerators. These are typically beer cooler sized boxes powered by the auto dashboard cigarette lighter connection. When you run power through them, one side of the chip gets hot and the other gets cold. Actually, they work as either refrigerators or heaters. Press the power switch in one direction and the contents of the beer cooler stay cold. Press the power switch the other direction, reverse the current, and the inside of the box grows warm, because heat from outside the box is pumped into the box.

Transmutation

The conversion of one element into another by fission (breaking apart the atomic nuclei) or fusion (bringing together and combining nuclei).

Tritium

A hydrogen atom with two neutrons. Tritium is radioactive, with a half-life of 12.3 years. See Hydrogen.

Volt

Voltage is a measure of electrical potential or electromotive force. Direct current electric power is measured in volts multiplied by amperes. Increasing either will increase the amount of work the electricity can do. In a rough analogy to a river pushing a water wheel to perform work, voltage is the height the water falls, and amperage is the volume of water.

Watt (electrical, thermal)

A measure of power. In direct current electricity, watts = volts \times amps. A thermal watt is the level of heat produced by a heater that consumes one watt of electric power.

Waste Heat

Strictly speaking, this is: “heat energy produced in an energy conversion or transfer process that is lost during conversion or transfer and is not available for useful purposes” (as defined by Pacific Northwest National Laboratory). For example, a typical automobile engine is 20% efficient, meaning that 80% of the heat from the burning gasoline goes out of the exhaust system, and 20% converts to vehicle propulsion. With electrical transmission, conversion losses and transmission and distribution (T&D) losses end up as waste heat. All forms of energy ultimately degrade into heat. Vehicle propulsion, for example, ends up warming the air, the tires and the road.

However, the 80% of the waste heat from an automobile engine is not all necessarily wasted in the literal sense. As explained in Chapter 15, in wintertime, you move a lever to open a baffle, directing a stream of fresh air across the hot engine block into the passenger compartment. In other words, you use waste heat to keep yourself warm. At a typical electric power plant, 66% of the heat is wasted. This leftover heat is not hot enough to generate electricity with conventional turbines, but it can be used for space heating and other purposes. See: Cogeneration.

Appendix B: Potential Cold Fusion Applications

This table lists speculative or blue-sky uses for cold fusion that people have suggested over the years. Many of these ideas are discussed in this book. This list is divided into:

- Bad ideas.
- Good ideas that can be built with today’s technology plus cold fusion.
- Futuristic stuff that may become possible after cold fusion plus other new technology is developed.

Bad Ideas
All sidewalks and streets in cold climates would be heated in the winter. Bad for the ecology. Heating some main city streets to melt ice is a good idea, and it has been done with conventional energy.
Efficiency does not save money anymore, so buildings will not need insulation to save money. Such buildings would be uncomfortable to live in. Efficiency will continue to be important with cold fusion.
Large terawatt heaters and lights over cold cities making winter and darkness a thing of the past. This would be dreadful for the ecology!
Massive refrigeration plants making hot summer living a thing of the past
Fences made only of white hot electrically heated boundaries. Obviously, this could only be done in wartime.
Countless mischievous military toys.
Terror weapons.
Cold fusion powered oil well pumps. Oil executives have actually said they want these! See Chapter 13.
Good Ideas
Conventional, every-day energy applications in the third world, such as cooking, lighting, pumping water, purifying water, transportation.
Improved electric bicycles. These are fun, and widely used in China as a practical means of transportation.
Perpetually aloft hot air balloons or other aircraft, some of which people may live in, permanently.
Very high altitude robotic aircraft that hover over one spot for years, and function like geosynchronous satellites. They would be used as television transmitters, cell phone towers and telephone repeaters.
Turbine engines that run at lower temperatures, making the hardware much cheaper and longer lasting.
Aircraft can be heavy and therefore stronger and cheaper. Propulsion devices can have smaller areas.
Desalination; the distillation of seawater making fresh water for massive irrigation projects.
Recovery of rare and useful elements from the seawater.
Thermal depolymerization plants to treat sewage and garbage, to dispose of plastic, and to produce synthetic oil (for feedstock, not as fuel), and fertilizer. See Chapter 13.
Vastly expanded recycling, and cleaning up most existing solid waste dumps. Free energy plus improved robots can accomplish this.
Improved food factories and aquaculture.

Futuristic Stuff
Large-scale excavations. Put highways, factories and shopping malls underground.
Large-scale, long distance manned spacecraft. An ion-drive may be a good choice today. New propulsion systems are likely to be invented.
Vertical takeoff and landing (VTOL) aircraft, but I hope no individual helicopter-like flying cars, because they are too noisy.
Aircraft without wings, that remains aloft from jet reactions only.
Large oceangoing hovercraft, mainly for freight but also, perhaps, for passengers. Better for the ecology than fast ships.
Space elevators.
Low gravity and zero gravity hotels in earth orbit accessible by millions of people.
Large-scale space exploration and colonization, possibly by billions of people. Underground cities and industry on the moon.
Terraforming Mars. Lots of energy would make it easier.
Lots of un-terraforming here on earth, that is, cleaning up the mess left by the 20th century.
Big improvements in prosthetic devices, especially legs and arms that require a lot of power, and in artificial muscles (electroactive polymers EAP).
Improved heart pumps, also known as Ventricle Assist Devices (VAD) and artificial hearts.
Using the same sort of technology: super-human cyborgs and body extensions, such as equipment you strap to your legs that allow you to run at 20 kilometers per hour for 100 kilometers, or arm-extension strap-ons such as a set of wings that let you fly (flapping - not pedaling) even in earth's gravity.
Big improvements in conventional mobile robots, even before the "birdbrain"-class computers described in Chapter 10 are developed. Fixed location, production line robots already have all the energy as they need.
Reverse oil wells, that synthesize oil and then bury it deep underground, to reverse global warming.
Massive food factories, and farming on the moon, or in orbit. This would free up most of the land for housing, recreation and wildlife.
Industrial scale isotope separation of common elements such as iron, silicon and copper. Isotopically pure versions of these elements may have unique, useful properties.
Industrial scale transmutation of elements in cold fusion cathodes.

Appendix C: Approximate SI (Metric System) Equivalents

All units in this book are SI with customary American spelling. Thus, a “ton” refers to a metric ton, spelled “tonne” in Europe. This appendix is for readers who are unfamiliar with the metric system, or more properly the International System of Units (SI). A rigorous definition of the system may be found at the National Institute of Standards and Technology web site:

<http://physics.nist.gov/cuu/Units/index.html>.

Many Internet web sites offer conversion tables to convert SI into standard American units. Some convert energy and power units, such as joules, kilowatts and British thermal units (Btu), and the energy stored in an average barrel of oil (bbl) or a ton of coal and cubic feet of natural gas. Because these online tools are available, there is no need to include a comprehensive set of equivalents here, but some readers who are unfamiliar with SI units might appreciate some informal examples of approximate equivalents. For example, it helps to know that one liter is about a quart, and a meter is about a yard (three feet). There is no need to remember that a meter is 1.093613298 yards.

In this book I have sometimes included customary American units in parenthesis; i.e., “80 kilometers (50 miles).” Again, these are approximate equivalents; 80 kilometers actually equals 49.7097 miles. It is easier to remember the approximate ratio of 8:5. Note that customary American units are defined according to SI units; thus, 1 mile is exactly 1609.344 meters. Here is a table of handy rule-of-thumb equivalents, and exact equivalents. Some exact equivalents are not defined, or seldom used.

SI and approximate US traditional units

Unit type	SI Unit	Approximate US equivalent	Exact US equivalent
Length	Meter	1 m \approx 1 yard	39.370078740 inch
	Kilometer	8 km \approx 5 mile	0.621371192 mile
Area	Hectare	1 ha \approx 2.5 acre	2.471043692 acre
Mass	Gram	28 g \approx 1 ounce	
	Kilogram	1 kg \approx 2 pounds	2.204622622 lb
	Ton	1 ton \approx 1 US ton	1.102311311 US ton
Volume	Liter	1 L \approx 1 quart ($\frac{1}{4}$ gallon)	0.264172052 US gal
	Milliliter	200 ml \approx 1 cup	
Power	Watt		1 HP = 745.7 watt
Energy	Megajoule	\approx 1000 Btu	947.817120313 Btu

Temperatures

Conversion: temperature in Celsius = $(5/9) * (\text{temperature Fahrenheit} - 32)$

Some temperature comparisons

Celsius	Fahrenheit	At this temperature
0°C	32°F	Water freezes
20°C	69°F	Many experiments are conducted at this temperature
37°C	99°F	Body temperature
60 - 80°C	140°F - 176°F	Coffee temperature, and the temperature at which many industrial processes operate. Cold fusion can easily achieve these temperatures, and it has done so in hundreds of experiments.
100°C	212°F	Water boils at one atmosphere. Cold fusion can easily achieve this temperature, but most cells are not pressurized, so they are deliberately kept cooler to avoid boiling. There is considerable evidence that cold fusion works better at higher temperatures.
200 - 300°C	392 - 572°F	Nuclear power plant pressurized water temperature. This would be the ideal temperature for most cold fusion heat engines. Combustion plant pressurized water is hotter and therefore more efficient, but it causes more wear and tear on the equipment.
407°C	765°F	Coal ignition
1,500 - 3,200°C	2732 - 5793°F	Coal combustion temperature, depending on the type of furnace. This might be difficult to achieve directly with cold fusion. Cold fusion could be used to generate electricity or chemical fuel, which could easily reach these temperatures.
1,552°C	2826°F	The melting point of palladium
1,660°C	3020°F	The melting point of titanium. It does not seem likely that cold fusion will work at this temperature, or above.
15 million °C	27 million °F	Core of the sun
400 million °C	720 million °F	Plasma fusion inside the PPPL tokamak reactor ¹⁹²

¹⁹² *PPPL: An Overview*, 1991: Princeton University Plasma Physics Laboratory. Since 300°C is ideal for most practical purposes, 400,000,000°C might be considered an impedance mismatch.

Sources

Sources are referenced in the text in footnotes. The following books are particularly valuable sources of information about cold fusion, energy and the future.

Annual Energy Review. Energy Information Administration, U.S. Department Of Energy.
<http://www.eia.doe.gov/emeu/aer/>

Beaudette, C.G., *Excess Heat. Why Cold Fusion Research Prevailed*. 2000, Concord, NH: Oak Grove Press (Infinite Energy, Distributor).

Cardwell, D., *The Norton History of Technology*. 1995: W. W. Norton & Company.

Christensen, C., *The Innovator's Dilemma*. 1997: Harvard Business School.

Clarke, A.C., *Profiles of the Future*. 1963: Harper & Row.

Clarke, A.C., *Profiles of the Future, Millennium Edition*. 1999: Indigo. This edition includes some discussions of cold fusion.

Deffeyes, K., *Hubbert's Peak, The Impending World Oil Shortage*. 2001: Princeton University Press.

Florman, S., *Blaming Technology*. 1981: St. Martin's Press.

Florman, S., *The Existential Pleasures of Engineering*. 1996: St. Martin's Griffin.

Krivit, S. and N. Winocur, *The Rebirth of Cold Fusion*. 2004: Pacific Oaks Press.

Mallove, E., *Fire From Ice*. 1991, NY: John Wiley.

Mizuno, T., *Nuclear Transmutation: The Reality of Cold Fusion*. 1998, Concord, NH: Infinite Energy Press.

Pimentel, D. and M. Pimentel, *Food, Energy, and Society, Revised Edition*. 1996: University Press of Colorado.

Storms, E., *The Science Of Low Energy Nuclear Reaction*. 2007: World Scientific Publishing Company.

Index

- Aerospace engines, 152
- Aircar. *See* Personal flying machine
- Airports, 149, 150, 157
 - Runways, 149
- Airships. *See* Zeppelins
- Allen, F. L., 64
- American Physical Society, 4
- Aquaculture, 138
- Artificial intelligence, 58, *See also*: Robot chickens
- Artificial muscles. *See* Electroactive polymers (EAP)
- Asian longhorned beetle, 88
- Atomic Energy of Canada Ltd., 34
- Automobile, 42, 50, 64, 139
 - accidents, 139
 - cold fusion powered, 35, 141
 - history, 44, 62, 65, 70, 74
 - pollution, 139
 - self-driving intelligent, 146
- Backhoes, 73
- Beaudette, C., 105
- Beaver, H. E. C., 5
- Benson, T., 28
- Big Dig project in Boston, 2, 58, 170
- Blast furnace, 39, 42
- Boorstin, D., 162
- Buffalo Commons plan, 137
- Calorimeters, 15, 17, 15
- Catalytic converter, 35, 129
- Cell phones, 53
- Chemical fuel, 12
- Chernobyl accident, 106
- Children
 - automobile accidents, 139
 - social life, 146, 170
- Christensen, C., 71
- Cirillo, D., 2
- Clarke, A. C., 1, 68, 84, 162
- Clipper ships, 119
- Coal, 31, 46, 66, 81, 107, 115
 - employment, 166
 - fatalities caused by, 118
 - radioactive pollution from, 26
- COBOL, 66
- Cogeneration, 176, 182
- Cogenerator, 50, 76, 113, 114, 117
- Cold fusion
 - cost of implementing, 11, 67
 - making things worse with, 58, 96, 103, 160, 161
 - potential danger from, 26, 103
 - probably is fusion, 9
 - public support essential, 5, 161
 - too good to be true, 10, 23
- Combined heat and power (CHP). *See* Cogenerator
- Cosmoplant Corp, 130, 131
- Deer overpopulation, 94
- Desalination, 2, 51, 76
- Deserts, irrigating, 76, 81
- Destructive technology circa 2000 BC, 160
- Deuterium, 14, 33, 177
- Diamonds, thin film, 2, 57
- Disruptive technology, 71
- Dyson, F., 100
- Efficiency, continued importance with cold fusion, 27, 47, 48, 135, 183
- Eisenhower, D., 96
- Electric Power Research Institute (EPRI), 74
- Electricity and electric generators, 42, 60, 74, 110, 113, 115, 117, 121, 135
- Electricity, cost of, 117
- Electroactive polymers (EAP), 43, 57, 88, 151, 157
- Electrolysis, 177
- Embodied energy, 46
- Excess heat, 8, 178
- Explosions during cold fusion experiments, 104
- Exxon's future as environmental clean-up expert, 167
- Faraday, M., 10
- Farms, indoor, 130
- Fast Ship hydrofoils, 150
- Fish farms, 138

Fleischmann, M., 8, 9, 12, 35, 103, 108, 163, 178
 Florman, S., 5, 116, 171
 Food, 84, 130
 embodied energy, 47
 organic, 137
 synthesis, 109, 136
 Food factory, 130
 Ford Model T, 65
 Fossil fuel, 33
 Furnace. *See* Space heater
 process heating, 49
 Gasoline tax, 146
 Generators. *See* Electricity and electric generators
 Global warming, 1, 45, 80, 84, 129
 sequester carbon, 82, 83
 Glow discharge cold fusion, 2, *See* Plasma cold fusion
 Gould, S. J., 63
Great Eastern (ship), 149
 Guerrilla tactics in war, 98
 Haiti, 42, 52, 80
 Heat (excess heat), 12
 Heat after death, 13, 178
 Heavy water, 31, 32, 33, 34, 78
 Helicopters, 149, 156
 Highway train (platoon) cars, 144
 Horgan, J., 161
 Hot fusion. *See* plasma fusion
 Hovercraft, 149, 150
 Huizenga, J., 4
 Hybrid automobiles, 35, 50, 142
 Hydraulic equipment, 73
 Hydroelectricity, 23, 24, 42, 67, 111
 International Thermonuclear Experimental Reactor (ITER), 21
 Invasive species, 87, 88, 93
 Isotopes, 25, 78, 179
 industrial scale isolation of, 56
 Jefferson, T., 163
 Land, soil problems, 130
 Las Vegas, 71
 LENR-CANR.org online library, 8
 Lettuce (grown in food factory), 131
Lilo and Stitch, 99
 Lovins, A., 160
 Mallove, E., 103
 Marine engines, 49, 66
 Maxim, H., 44
 McKubre, M. C. H., 5, 19
 Metric system (SI), 185
 Microprocessors, 68
 Middle east, 1
 Minamata, Japan, 126
 Mizuno, T., 2, 8, 13, 104, 106
 MK-47 Torpedo, 99
 Mosier-Boss, P. A., 37
Nature (magazine), 4
 Neumann, J. von, 163
New York Times, 3, 162
Newsweek magazine, 19
 Nuclear power. *See* Uranium nuclear power
 Nuclear powered aircraft, 152
 Obsolete technology still in use, 66
 Ohmori, T., 2
 Oil, 31, 50, 64, 81
 industry has no future, 107
 oil company executives, 108, 109
 production overhead, 46
 reverse oil wells, 83, 109
 tankers, 46
 war for, 1
 Oriani, R., 9
 Palladium, 35, 130
 Park, R., 4
 Pebble bed modular reactor, 106
 Personal flying machine, 148, 156
 Pessimists, 160
 Piel, J., 4
 Pimentel, D., 46, 130
 Pipelines, 46, 165
 Pipelines, vulnerability to attack, 102
 Planck, M., 5
 Plasma cold fusion, 2, 39
 Plasma fusion (hot fusion), 19
 Platinum group metals, 35, 180
 Plutonium battery. *See* Radioisotope thermoelectric generator (RTG)
 Pollution, 1, 5, 23, 31, 45, 77, 111, 127, 129, 139
 Pons, S., 8, 9, 12, 35, 178

Poor people. *See* Poverty
Popular Mechanics, 103
 Population boom, 84, 126, 173
 Poverty, 1, 42, 76, 77, 80, 84, 126, 172
 QWERTY keyboard, 63
 Radhakrishnan, T. P., 104
 Radioactive decay, 180
 Radioisotope thermoelectric generator (RTG), 24, 25, 73
 Recycling, 53
 Rennie, J., 4, 162
 Residential energy use, 120
 Rifkin, J., 160
 Riley, A., 105
 Robosect. *See* Robot chicken
 Robot chickens, 85
 as weapons, 101
 burglar alarms, babysitters, 92
 radioactive waste, 95
 specifications, 88
 Roosevelt, F. D., 169
 Runways at airports, 149
 Rush hour, 146
 Russia, 165
 Saudi Arabia, 52, 76, 83, 165
 Schwinger, J., 4
Scientific American, 4, 54, 161
 Japanese edition (*Nikkei Saensu*), 62
 Seawater, elements in, 78
 Shannon, Claude, 70
 Shinkansen railroad trains, 66, 67
 SI - International System of Units, 185
 Smart weapon, 101
 Smoke alarms, 26
 Solar energy, 23
 Space elevator, 81, 154, 155
 Space heater, 50, 117, 122
 Space Shuttle, 39
 Space station, 155
 Stirling engine, 27, 49, 124
 Storms, E., 16
 Strauss, L., 163
 Submarine warfare, 99
 Szpak, S., 37
 Takatsuji, M., 132
 Tax, 146
 Telecommuting, 142, 148
 Terror weapons, 103
 Thermal depolymerization, 49, 108
 Thermoelectric device, 56
 Thermoelectric devices, 25
 Three Mile Island accident, 61
 Three Mile Island nuclear accident, 111
Time magazine, 162
 Tokai University, 135
 Tokamak, 19, 21
 Transistors, early unreliable prototypes, 10
 Tritium, 15, 103, 177
 potential hazard from, 26
 Underground infrastructure, factories, 57
 Underground roads, 57, 143, 144, 146
 Unemployment, 165
 Uranium nuclear power, 5, 19, 67, 77, 103, 106, 111, 117, 118
 fuel pellet, 39
 nuclear powered aircraft, 152
 Utopia, 160
 Venezuela, 165
 Vertical takeoff and landing aircraft (VTOL), 147, 150
 supersonic, 150, 151
 War, 1, 83, 96, 107, 139, 158
 Waste heat, 27, 113, 124, 182
 potential harm from, 48
 Water heater, 42, 50, 67, 109, 118, 122
 Water, sanitation, 42, 76
 Weapons, 96
 Wilson, W., 64
 Wind energy, 20, 23, 24, 46, 67, 118
 Wright brothers, 54
 Yokkaichi, Japan, 127, 162
 Zeppelin, 71, 150