

Part One. Conventional Mine Operations

CHAPTER 1

CONVENTIONAL MINES

This chapter provides the mechanics of conventional mines and the characteristics and descriptions of antitank (AT) and antipersonnel (AP) conventional mines and antihandling devices (AHDs). Conventional mines are hand-laid mines that require manual arming. Conventional mine laying is labor-, resource-, and transport-intensive. Soldiers emplace conventional mines within a defined, marked boundary and lay them individually or in clusters. They record each conventional mine location so mines can be recovered. Soldiers can surface lay or bury conventional mines and may place AHDs on the mines.

MECHANICS OF MINES

Characteristics and Functioning

A mine used in warfare is an explosive device designed to destroy or damage equipment or personnel. Equipment targets include ground vehicles, boats, and aircraft. A mine may be detonated by the action of its victim, by the passage of time, or by controlled means. There are two types of conventional mines: AT and AP. Mines generally consist of the following parts (Figure 1-1, page 1 -2):

- Firing mechanism or other device (sets off the detonator or igniter charge).
- Detonator or igniter charge (sets off the booster charge).

- Booster charge (may be attached to the fuze/igniter train or be part of the main charge).
- Main charge, in a container (usually forms the body of the mine).
- Outer casing (contains all the above parts).

Components and Initiating Actions

The purpose of firing mechanisms is to prevent a mine from exploding until it makes contact with, or is influenced by, its target.

Once a mine has been armed, the firing mechanisms may be actuated by the following methods (Figure 1-2, page 1-3):

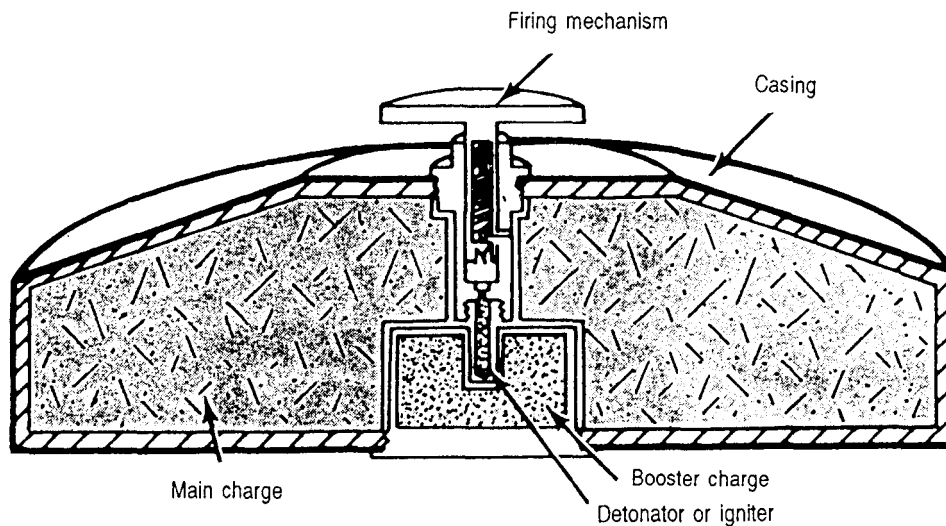

Figure 1-1. Mine components

- Applying pressure.
- Pulling a trip wire.
- Releasing tension or breaking a trip wire.
- Releasing pressure.
- Passage of time (time-delay mechanism).
- Impulses.
 - Electrical.
 - Vibration.
 - Magnetic.
 - Electromagnetic frequency.
 - Audio frequency.

For a mine to be armed, the igniter must be put in position and the mechanism properly set. In addition, the safety device must be disengaged (usually by removing a safety pin).

The fuze is the initial component in the firing chain. It has a low explosive power but is highly sensitive. The fuze is actuated by an initiating action. Although mines are issued with a standard fuze, alternate fuzes are issued separately for some mines.

The four main fuzes are as follows (Figure 1-3, page 1-4):

- Mechanical.
- Chemical.
- Friction.
- Electrical.

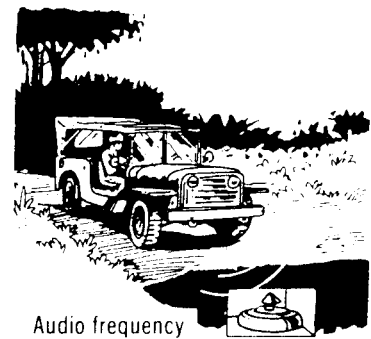
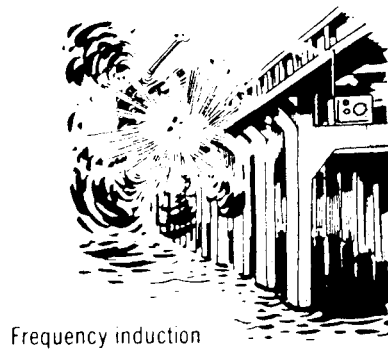
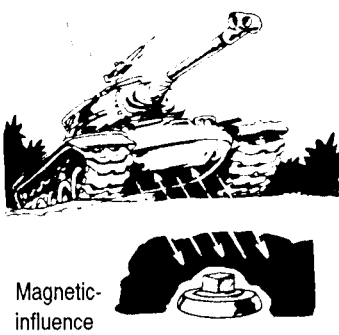
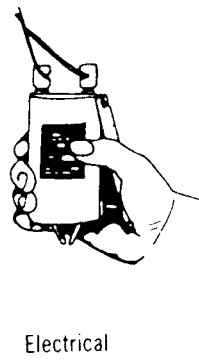
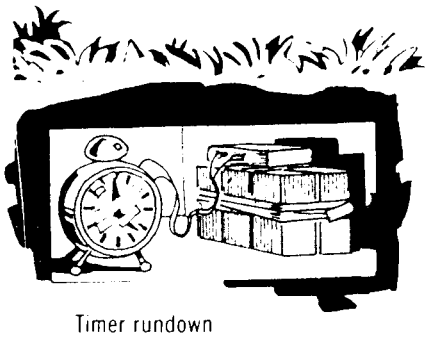
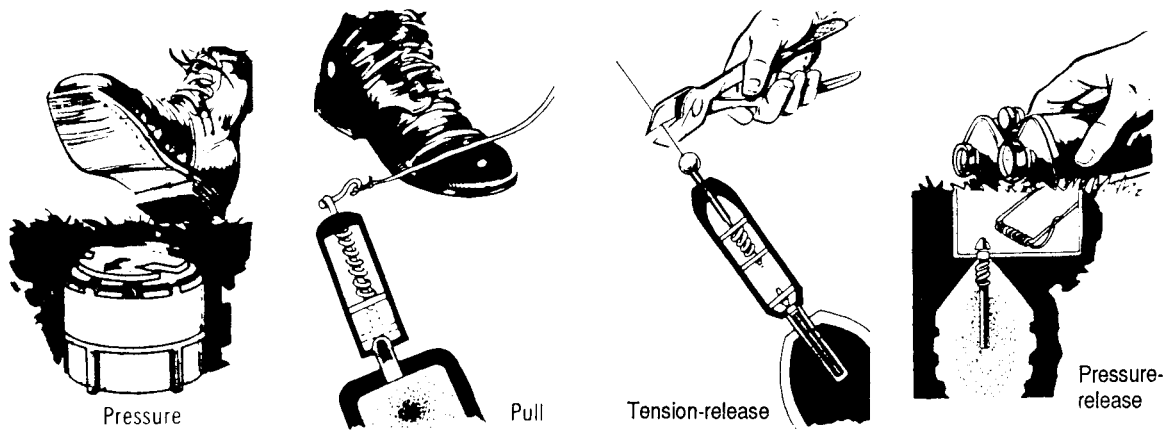
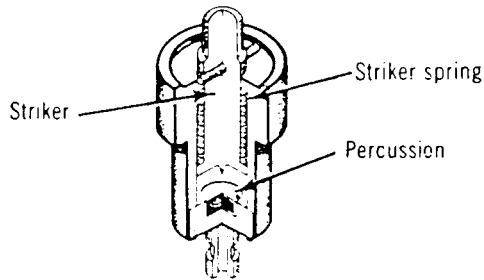
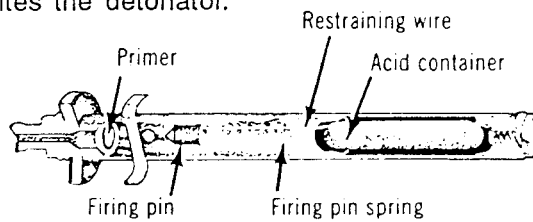

Figure 1-2. Methods of actuating mines

Mechanical. A spring drives a striker against a percussion cap, which fires the detonator.



Chemical. A small container of a chemical compound is broken by the initiating action. The chemical compound reacts with another substance to generate heat which ignites the detonator.



Friction. The initiating action ignites substances inside the fuze by friction. The flame fires the detonator.

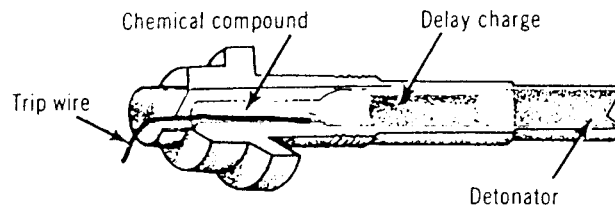

Electrical. The initiating action closes an electrical circuit which detonates an electrical detonator.

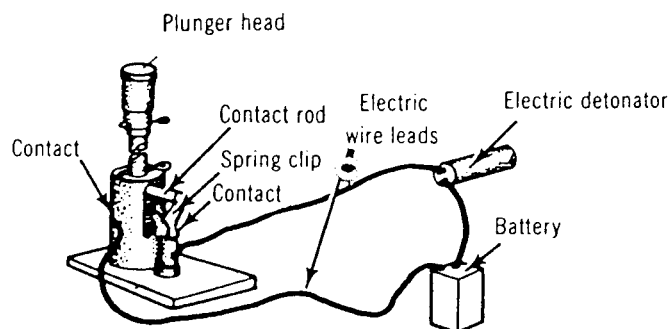

Figure 1-3. Four main types of fuzes used to pass the initiating action on to the rest of the firing chain

ANTITANK MINES

AT mines are designed to immobilize or destroy tracked and wheeled vehicles and the vehicles' crews and passengers.

Types of Kills

AT mines produce either a Mobility Kill (M-Kill) (Figure 1-4) or a Catastrophic Kill (K-Kill) (Figure 1-5).

An M-Kill destroys one or more of the vehicle's vital drive components (for example, breaks a track on a tank) and immobilizes the target. The M-Kill does not always destroy the weapon system and crew. The weapon system, though immobilized, may continue to function. In a K-Kill, the weapon system or crew is destroyed; therefore, the vehicle can no longer perform its intended mission.

Types of Sensing

AT fuzes fall into the following three categories: track-width, full-width, and wide-area.

Track-width (Figure 1-4). Usually pressure-actuated, requiring contact with the wheels or tracks of a vehicle. This fuze normally produces an M-Kill.

Full-width (Figure 1-5). Activated by several methods: acoustics, magnetic, tilt-rod, radio frequency, and vibration. Tilt-rod or magnetic-influence fuzes are the most common. They are designed to be effective across the entire target width. When a full-width fuze is activated solely by contact with the wheels or tracks of the target vehicle, it usually causes an M-Kill. Most of the energy is absorbed by the wheels or tracks.

Wide-area (Figure 1-6). Designed to produce an M-Kill when a target vehicle activates the fuze with acoustic and seismic signals. An infrared-sensored sublet is launched and acquires the target.

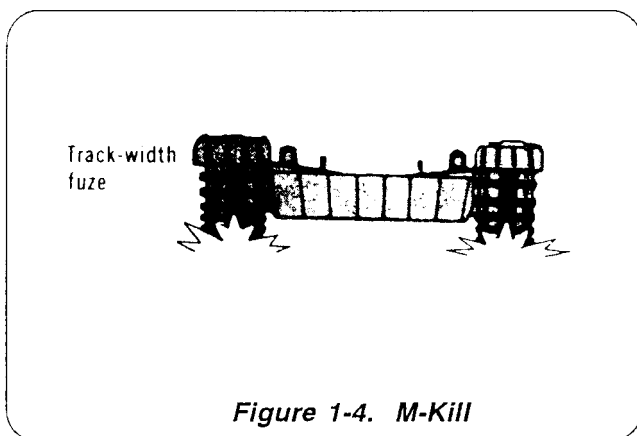

Figure 1-4. M-Kill

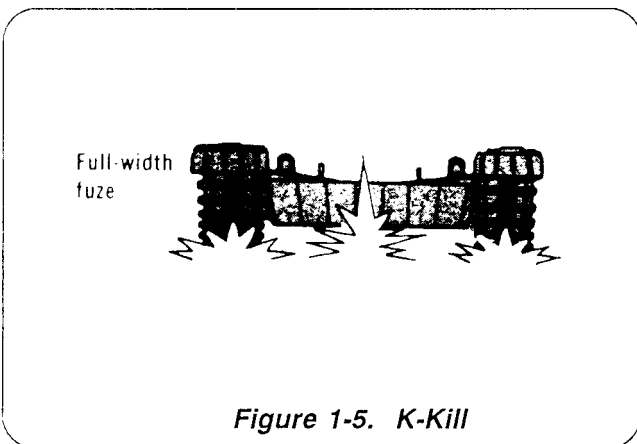

Figure 1-5. K-Kill

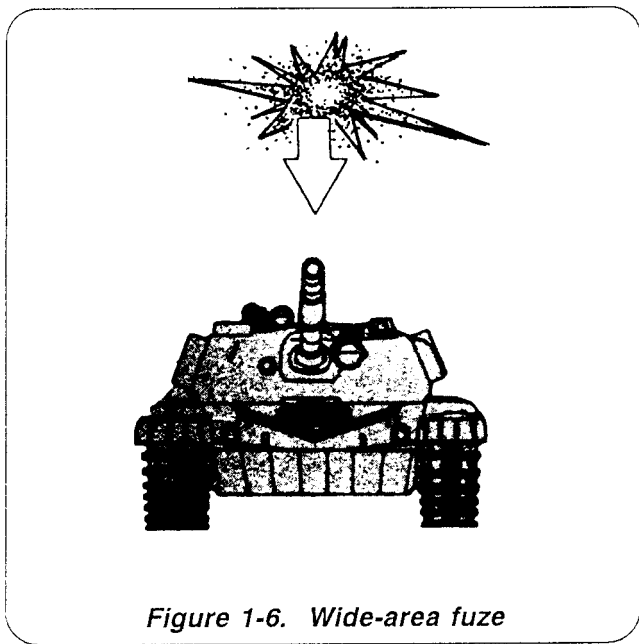

Figure 1-6. Wide-area fuze

Types of Warheads

The different AT mines are also distinguished by their warheads (blast or shaped charge).

A blast AT mine derives its effectiveness from the force generated by high explosive (HE) detonation. It usually produces an M-Kill when the blast damages the track or vehicle, but a K-Kill is also possible.

Self-forging fragmentation (SFF) mines use a direct-energy (shaped charge Miznay-Schardin (M-S) effect) warhead designed to penetrate the armor on the vehicle's underside, or on its side for horizontal-effect mines. It usually causes a K-Kill because spalling metal from the vehicle created by the blast of the mine or secondary explosions kill the crew.

The following conventional AT mines are used by the Army (Figure 1-7 and Table 1-1):

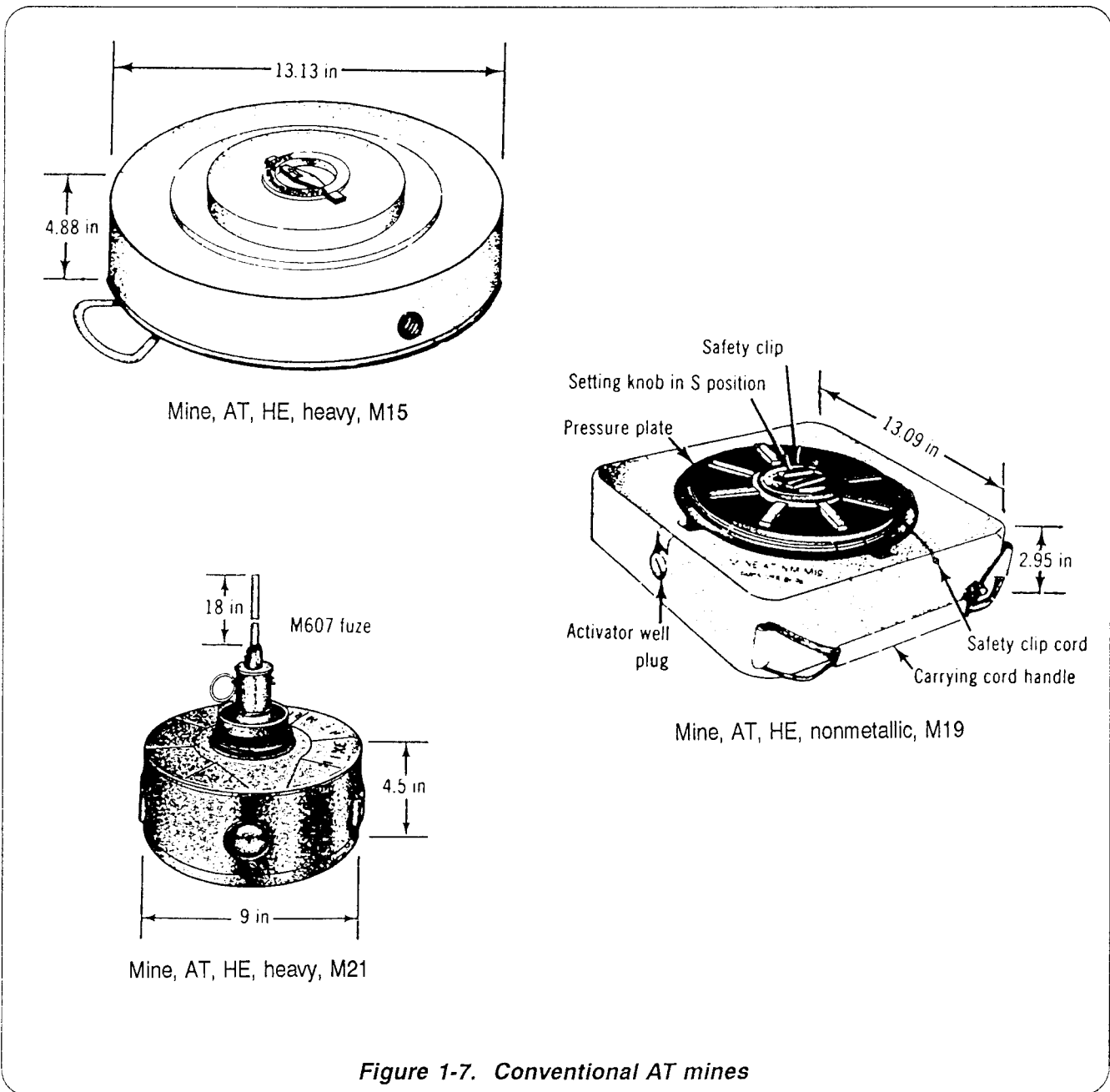

★ *Table 1-1. Conventional AT mine characteristics*

Mine	Safe Arm Time	Fuzing	Warhead	AHD	Explosive Weight	Mine Weight	Mines Per 5-Ton Dump
M15	NA	Pressure	Blast	Yes	22 lb	30 lb	112
M15 w/M624 Fuze	NA	Tilt Rod	Blast	Yes	22 lb	30 lb	112
M19	NA	Pressure	Blast	Yes	21 lb	28 lb	128
M21	NA	Tilt Rod	Shaped Charge	Yes*	11 lb	17 lb	128

*Conventional antihandling devices will not couple with this mine; however, a booby trap using the M142 multipurpose firing device can be configured under the emplaced mine.

M15 AT (with or without tilt rod). The M15 mine is 13 1/8 inches in diameter and 4 7/8 inches high. It weighs 30 pounds and contains 22 pounds of Composition B explosive. The primary fuze well is on the top center of the mine. Secondary fuze wells are on the side and bottom. When the M603 fuze is employed on the primary fuze, the M 15 is a track-width mine that is activated with 350 to 750 pounds on the pressure plate. This produces an M-Kill. When the M624 fuze (with tilt rod) is employed on the primary fuze well, the M 15 is a full-width mine that is activated by deflection of the tilt rod. Depending on the armor, this produces an M-Kill or possibly a K-Kill.

M19 AT (plastic). The M19 mine is a non-metallic square mine that measures approximately 13 by 13 by 3 inches. It weighs 28 pounds and contains 21 pounds of Composition B explosive, a tetryl booster pellet, and an M606 integral pressure fuze. When the setting knob on the pressure plate is in the S (safe) position, the mine cannot function by action of the main fuze. After the safety clip

has been removed and the setting knob turned to the A (armed) position, a force of 350 to 500 pounds on the pressure plate depresses the Belleville spring and begins the firing chain. A standard firing device may be used with the M2 activator in any of the secondary fuze wells on the side and bottom of the mine. When the M1 9 is employed, it is hard to detect because of its plastic construction. It produces an M-Kill with a blast effect.

M21 AT (with or without tilt rod). The M21 mine is 9 inches in diameter and 4 1/2 inches high. It weighs 17 pounds with 11 pounds of Composition H6. The mine is activated by 4 pounds of pressure against a 21-inch-long rod on the M607 fuze. It uses an M-S (directed energy) plate to produce a K-Kill. The M21 with tilt rod must be buried or staked (use two stakes, one on each side of the carrying strap) to avoid enemy vehicles tipping the mine over. Without the tilt rod, the mine is activated by 290 pounds of pressure on the M607 fuze and produces an M-Kill by blast effect.

ANTIPERSONNEL MINES

AP mines are designed to kill or wound soldiers.

Types of Kills

AP mines can either kill or incapacitate their victims. Other soldiers must tend to the victim, which temporarily takes them out of the fight.

Types of Sensing

AP mines can be fuzed by pressure or trip wire or can be command-detonated.

- Pressure fuzes usually activate an AP mine when a soldier steps on the fuze.
- Trip wires activate an AP mine when a soldier disturbs barely visible wires. The exploding mine can kill or incapacitate him or other soldiers in the immediate vicinity.
- Command-detonated mines are activated by a soldier when he detects enemy in the blast area of the mine and detonates the mine to kill or incapacitate enemy soldiers.

Types of Warheads

The three types of warheads are: blast, bounding fragmentation (frag), and directed frag.

The blast AP mine is designed to cripple the foot or leg of the soldier who steps on it. It can also burst the tires of a wheeled vehicle that passes over it.

When the bounding frag AP mine is activated, it throws a canister into the air. The canister bursts and scatters shrapnel throughout the immediate area (Figure 1-8).

The directed frag AP mine propels fragments in the general direction of enemy soldiers.

The following conventional AP mines are used by the Army (Figure 1-9 and Table 1 -2):

M14 AP blast mine. The M 14 is a nonmetallic, blast mine consisting of a main charge (1 ounce of tetryl), a plastic body, and an integral plastic fuze with a steel firing pin. It is cylindrical in shape, 2 3/16 inches in diameter, and 1 9/16

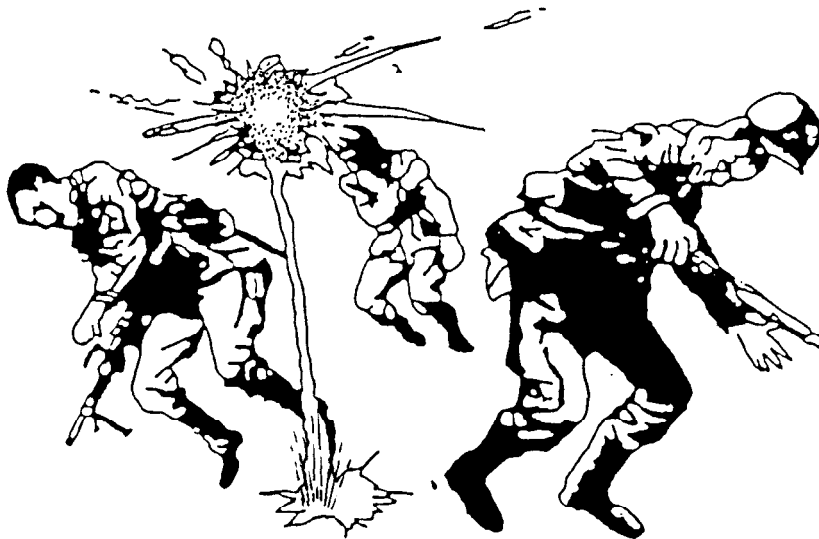

Figure 1-8. Bounding frag AP mine

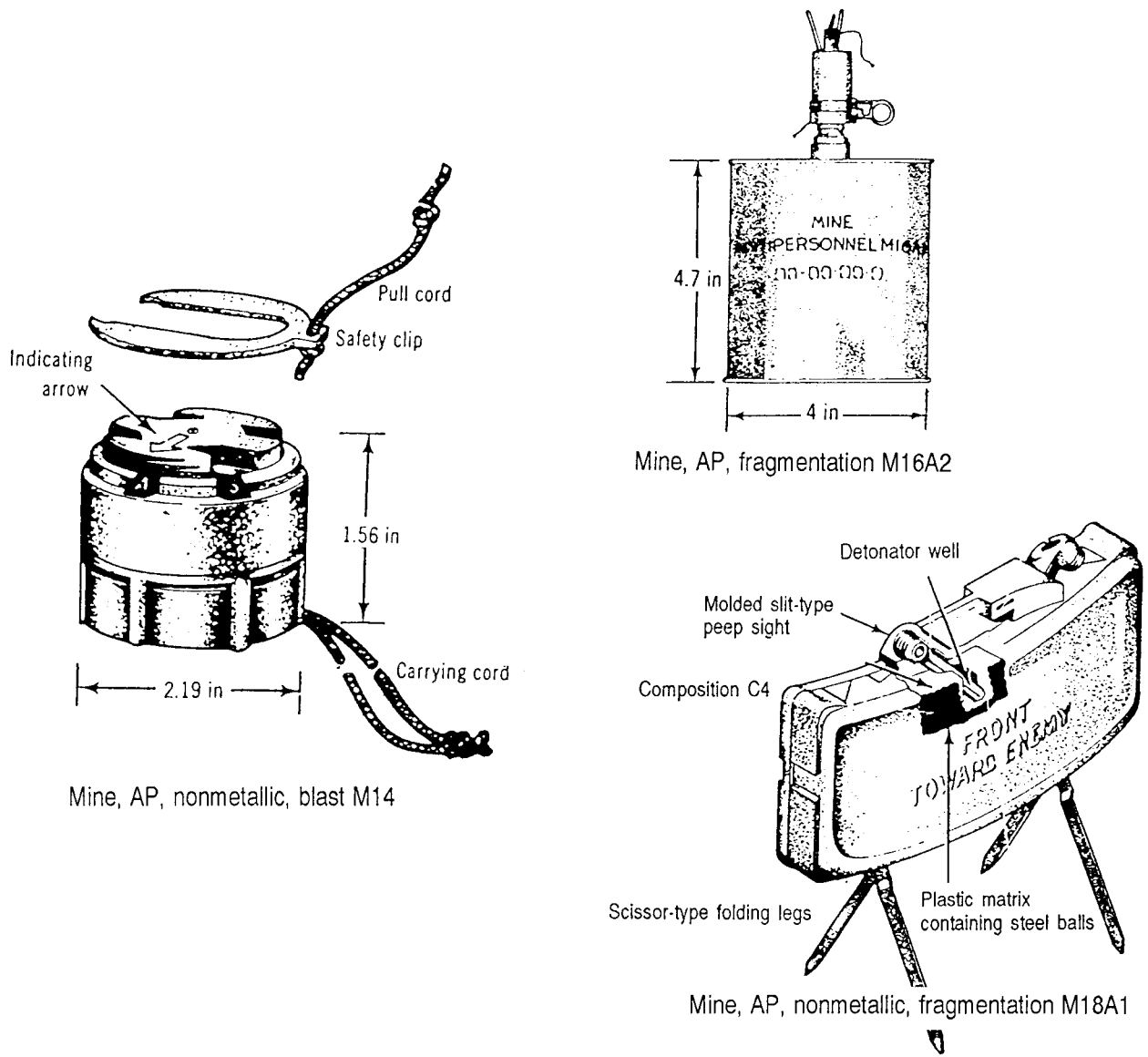

Figure 1-9. Conventional AP mines

Table 1-2. Conventional AP mine characteristics

Mine	Safe Arm Time	Fuzing	Warhead	AHD	Explosive Weight	Mine Weight	Mines Per 5-Ton Dump
M14	NA	Pressure	Blast	No	1 oz	3.3 oz	6,480
M16A1	NA	Pressure Trip Wire	Bounding Frag	Yes	1 lb	8 lb	672
M18A1	NA	NA	Directional Frag	No	1.5 lb	3.5 lb	1,782
M86 (PDM)	25 sec	NA	Bounding Frag	100%	21 gr	1 lb	NA

NOTE: The M86 (PDM) mine self-destructs in 4 hours.

inches high. It weighs 3 ½ ounces. The pressure plate has an indented yellow arrow that points to the A (armed) or S (safe) position on the top of the fuze body. A force of 25 to 30 pounds depresses the pressure plate, causing the Belleville spring to drive the firing pin into the detonator. Although the M14 is not designed to kill, it can incapacitate. It is difficult to detect because of its plastic construction.

M16 AP frag mine. The M 16 is a bounding frag mine consisting of a combination mine fuze (M605), propelling charge, and projectile that are contained in a sheet steel case. The mine is 4 inches in diameter and 7 5/8 inches high (with the fuze), and it weighs 7 7/8 pounds. The principal differences between the M 16 and the A1 and A2 versions are in the construction of the detonators and boosters. The casualty radius for the M 16 and M16A1 is 27 meters; and for the M 16A2, it is 30 meters. Pressure of 8 to 20 pounds acting on one or more of the three prongs on the M605 fuze or the pull of 3 to 10 pounds on a trip wire activate the mine.

M18A1 AP frag mine. The M18A1 Claymore mine is a directional frag mine that contains 700 steel balls and 1 ½ pounds of Composition C4 explosive. The mine can be detonated by command or trip wire. It is activated by electric

or nonelectric blasting caps inserted into the detonator well. When the mine detonates, it projects a fan-shaped pattern of steel balls in a 60-degree horizontal arc and covers a casualty radius of 100 meters, at a maximum height of 2 meters. The forward danger radius for friendly forces is 250 meters. The backblast area is unsafe in an unprotected area 16 meters to the rear and sides of the mines. All friendly personnel within 100 meters to the rear and sides of the mine should be in a covered position to be safe from secondary missiles. When employing the M18A1 mine with other mines, separate the mines by the following minimum distances:

- 50 meters in front of or behind M18A1 mines.
- 3 meters between M18A1 mines that are placed side by side.
- 10 meters from nearest AT or frag AP mines.
- 2 meters from nearest blast AP mines.

M86 pursuit-deterrent munition (PDM). The PDM is a manually activated mine with a hand grenade release firing mechanism (Figure 1-10). It has a self-delay arming time of 25 seconds and deploys up to seven trip wires. It possesses a 4-hour self-destruct time and is issued as a Class V munition.

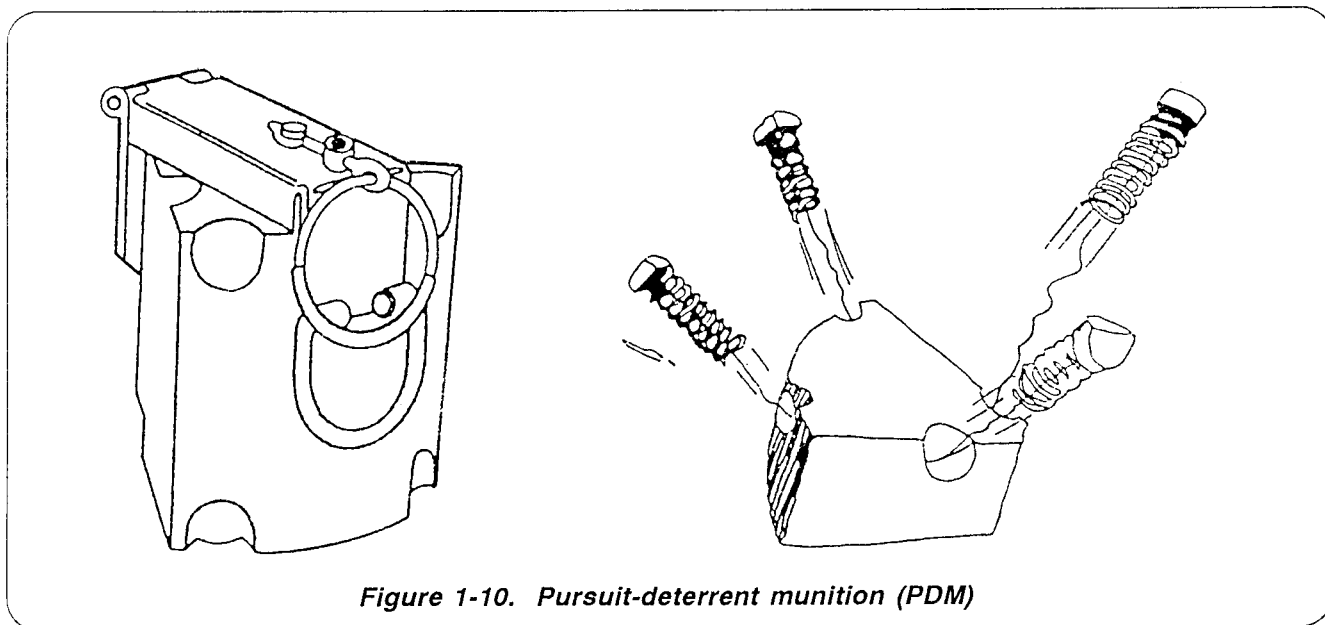
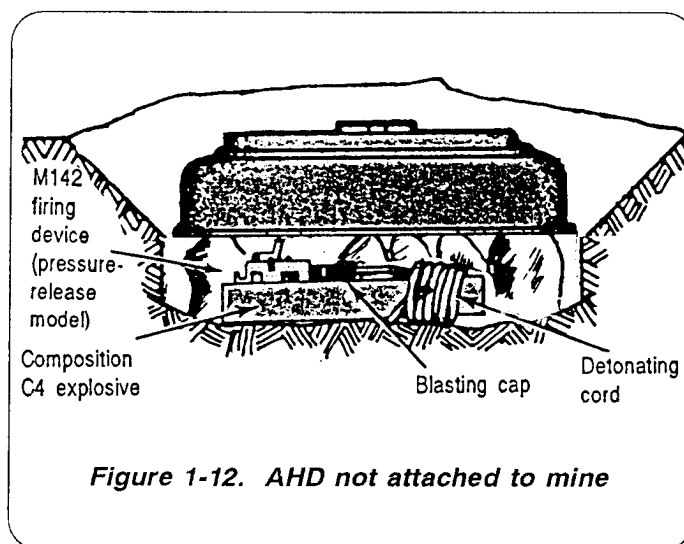
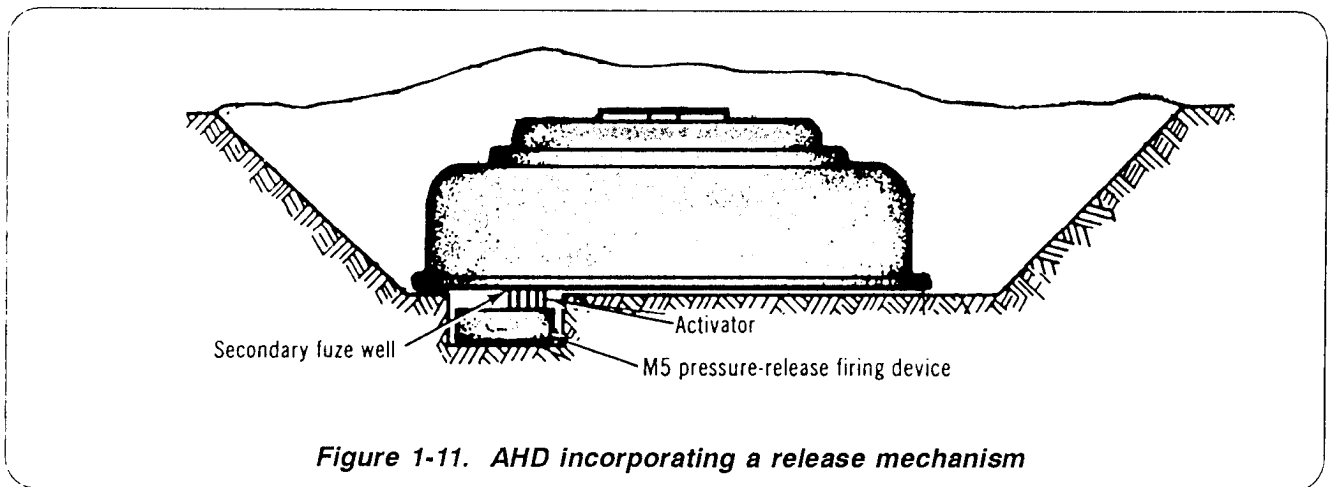
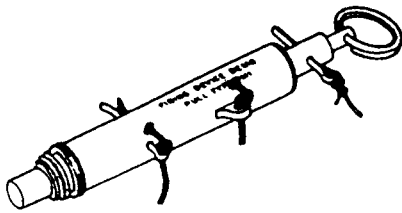

Figure 1-10. Pursuit-deterrent munition (PDM)

ANTIHANDLING DEVICES

- ★ AHDs perform the function of a mine fuze if someone attempts to tamper with or remove the mine. An AHD usually consists of an explosive charge connected to or placed next to the mine. It can be a manufactured device attached to the mine body. It can also be activated by a wire attached to a retaining pin that fires the device when the mine is moved.
 - ★ Some mines are provided with extra fuze wells, making it easier to install AHDs (Figure 1-11). The AHD may also be placed beneath the mine (unattached to the mine) (Figure 1-12). Mines with AHDs are sometimes incorrectly called *booby-trapped* mines.
 - ★ The following US AHDs are used (Figure 1-13, page 1-12):
 - M1 pull firing device.
 - M3 pull tension-release firing device.
 - M5 pressure-release firing device.
 - M1A1 pressure firing device.
 - M142 multipurpose firing device.
- These devices use a spring-loaded striker with a standard base and function in one or more of the following modes: pressure, pressure-release, tension, and tension-release. When firing devices are employed with certain AT mines, they require the use of the M 1 or M2 activator. These firing devices and activators are described in Appendix A.





M1 - Pull

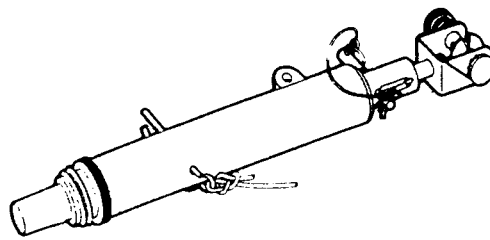

M3 - Pull/tension-release

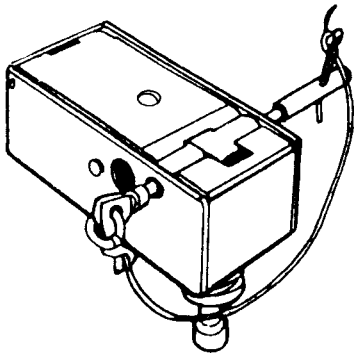

M5 - Pressure-release

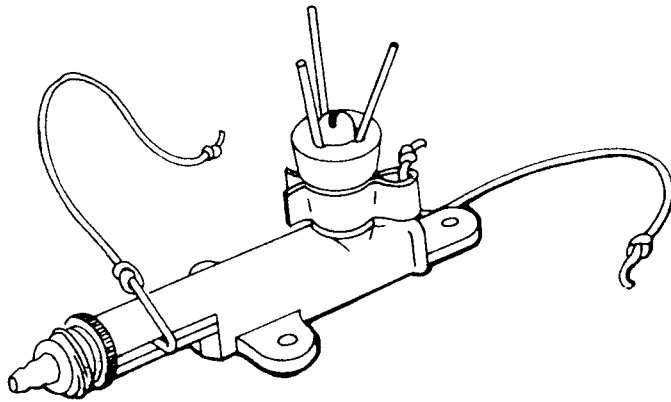

M1A1 - Pressure

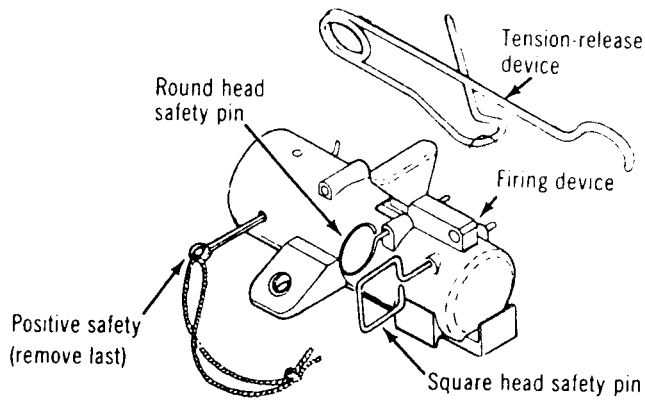

M142 - Multipurpose

Figure 1-13. US AHDs