

CHAPTER 2

MINE WARFARE PRINCIPLES

This chapter provides guidance to staff personnel who must plan the employment of minefield to support tactical operations. It defines the three types of minefields—protective, tactical, and phony. The remainder of the chapter provides guidance on employment of tactical minefields—specifically their functions, designs, and integration principles.

MINE WARFARE POLICY

Mines are explosive devices emplaced for the express purpose of killing, destroying, or otherwise incapacitating enemy personnel and /or equipment. They can be employed in quantity within a specified area to form a minefield, or they can be used individually to reinforce non-explosive obstacles. They may also be emplaced individually as booby traps to demoralize an enemy force. A minefield is an area of ground containing mines emplaced with or without a specific pattern, or it is an area of ground without any mines (a phony minefield). Minefields may contain any type, mix, or number of AT and/or AP mines. Minefields are used to—

- Produce a specific effect on enemy maneuver, thereby creating a vulnerability that can be exploited by friendly forces.
- Cause the enemy to piecemeal his forces.
- Interfere with enemy command and control.
- Inflict damage to enemy personnel and equipment.
- Protect friendly forces from enemy maneuver.

TYPES OF MINEFIELDS

There are three general types of minefields—*protective*, *tactical*, and *phony*. Minefield type is determined by the battlefield purpose. Protective, tactical, and phony minefields all have different purposes on the battlefield. As a result, they are employed differently and target the enemy in a unique way that supports the overall concept of operation. Protective obstacles are employed to protect a defending

force from an enemy assault. Tactical obstacles, on the other hand, directly attack the enemy's maneuver in a way that gives the defending force a positional advantage. Phony minefields deceive the enemy as to the exact location of real minefields. Phony minefields cause the attacker to second-guess his decision to breach and may cause him to wastefully expend his breach assets. Phony minefields

may be employed in conjunction with tactical or protective minefields.

It is important to distinguish the difference between the type of minefield and the means of emplacement. Volcano, Modular Pack Mine System (MOPMS), standard pattern, and row mining are not types of minefields. They are just some of the means used to emplace tactical or protective minefields. They may also be the method of emplacement replicated by a phony minefield. For example, tracked vehicles may drive in a phony minefield to give it the same signature as a minefield emplaced by row mining.

Protective Minefields

Protective minefields, like other protective obstacles, are employed to protect the defending force from the enemy's final assault. Protective obstacles are key components of survivability operations. Protective minefields are normally employed and emplaced at the small unit level (platoon and company/team). The authority to emplace protective minefields is normally delegated to the company/team commander. In some cases, protective minefields are laid on short notice by units using mines from their basic load or local stock, such as in a hasty defense. More commonly, protective minefields are used as part of a unit's deliberate defense. The mines are laid so they are easy to detect and recover by the laying unit.

An important aspect of protective minefields is the requirement to recover them before leaving the area. This is often overlooked and is difficult to control because they are emplaced at the small unit level. When a unit is being relieved in place by an adjacent unit, protective obstacles are turned over to the relieving unit. This implies that protective obstacles are recorded and reported as any obstacle. Again, the decentralized emplacement of protective obstacles makes consolidating reports and records difficult and requires command involvement.

Much like final protective fires (FPF), protective minefields provide the defender with close-in protection during the enemy's final assault.

Protective minefields serve two purposes. They impose a delay on the attacker to allow the defender time to break contact, and they displace to another battle position or break up the enemy's assault to complete its destruction. The composition of protective minefields is driven by the vulnerability of the defender.

- The greatest close combat threat to a defending tank company/ team is dismounted infantry. Protective minefields in this case consist predominantly of AP mines to limit enemy dismounts to close with the armor defender.
- The greatest threat to an infantry defense is a tank force. Protective minefields in this case consist predominantly of AT mines to reduce the enemy's ability to close quickly onto the infantry's position.

Neither AP nor AT mines are used in isolation. The preponderance of the mine composition is designed against the most severe close combat threat and the likelihood of that threat.

A protective minefield may take many forms. It may be only a few mines in front of a platoon, or it may be a standard pattern minefield around an airfield. Protective minefields are used in both close and rear operations and are classified as either hasty or deliberate.

- ★ • Hasty protective minefields are used as part of a unit's defensive perimeter. They are usually laid by units using mines from their basic load. If time permits, mines should be buried to increase their effectiveness; but they may be laid on top of the ground in a random pattern. AHDs and nonmetallic mines are not used, so the minefield can be easily recovered. Mines are employed outside the hand grenade range but within the range of small caliber weapons. All mines are picked up by the emplacing unit upon leaving the area, unless enemy pressure prevents mine retrieval or the minefield is being transferred to a relieving commander. The brigade commander has the initial authority to employ hasty protective minefields. This authority may be delegated to the battalion commander or to the company commander on a mission basis.

Procedures for recording a hasty protective minefields are contained in Chapter 5.

- ★ • Deliberate protective minefields are used to protect static assets (vital sites): logistical sites, communication nodes, depots, airfields, missile sites, air defense artillery (ADA) sites, and permanent unit locations. The typical deliberate protective minefield is the standard pattern minefield. A row minefield can also be used for a deliberate protective minefield. Deliberate protective minefields are usually emplaced for extended periods of time and can be transferred to another unit. Two techniques for emplacing deliberate protective minefields are discussed in Chapter 3, Standard Pattern Minefield, and Chapter 4, Row Mining.

Tactical Minefields

Tactical minefields are employed to directly attack enemy maneuver and to give the defender a positional advantage over the attacker. Tactical minefields may be employed by themselves or in conjunction with other types of tactical obstacles. They attack the enemy's maneuver by disrupting his combat formations, interfering with his command and control, reducing his ability to mass fires against the defender, and reducing his ability to reinforce. The defender masses fires and maneuver to exploit the positional advantage created in part by tactical obstacles.

Tactical minefields add an offensive dimension to the defense. They are the commander's tool for recapturing and maintaining the initiative normally afforded the attacker. Combined with fires, tactical obstacles force the attacker to conform to the defender's plan.

Tactical minefields are not only used in the defense. They may also be emplaced during offensive operations to protect exposed flanks, isolate the objective area, deny enemy counterattack routes, and disrupt enemy retrograde. This chapter further discusses the principles behind designing, integrating, siting, and emplacing tactical minefields

Nuisance minefields. Nuisance minefields are a form of Tactical minefields. They are mainly used to impose caution on enemy forces and to disrupt, delay, and, sometimes, destroy follow-on echelons. Once nuisance minefields are emplaced, they do not necessarily need to be covered by observation or direct fire. Nuisance minefields are usually of irregular size and shape. They can be a single group of mines or a series of mined areas. They can be used to reinforce existing obstacles and can also be rapidly emplaced on main avenues of approach. Both conventional and scatterable mines may be used in nuisance minefields

Phony Minefields

Phony minefields are areas of ground that are altered to give the same signature as a real minefield and thereby deceive the enemy. Phony minefields serve two primary functions. First, they confuse the attacker's breach decision cycle and cause him to second-guess his breach decisions. Second, they may cause the attacker to wastefully expend breach assets to reduce mines that are not really there.

The success of phony minefields depends on the enemy's state of mind. The bluff succeeds best when the enemy is mine-conscious and has already suffered the consequences of a mine encounter. A fear of mines can quickly evolve into paranoia anti break the moment urn of the enemy's attack. Therefore, phony minefields are normally employed in conjunction with real minefields and seldom employed by themselves. Once the enemy has become mine-conscious, phony minefields may produce considerable tactical effects with very little investment in time, labor, and material. Phony minefields may also be used to extend the frontage or depth of live minefields when mines or labor are in short supply or time is restricted. Phony minefields may be used to conceal minefields gaps through live minefields. However, there is no guarantee that phony minefields will achieve their purpose.

There are two mission-essential tasks inherent in the employment of a phony minefield. First, the phony minefield must completely replicate a live minefield in every detail using a specific method of emplacement as a model. This be-

comes the deception story, and every aspect of the phony minefield must support the deception story. For example, if the deception story is a buried row minefield, the depth, frontage, and marking must be similar to other employed buried row minefields. The ground should be disturbed as for live mine laying, and tracks should be made on the ground in the same pattern as other minefields to give the ground the same signature. Occasional empty mine crates, discarded fuzes, or other mine-laying supplies add to the deception.

The second mission-essential task is to never compromise the deception story. Once emplaced, the phony minefield must be regarded by friendly forces as live until the tactical situation no longer warrants maintaining the deception. This can be extremely painful for the friendly unit. There is great temptation to drive through, rather than around, a known phony minefield, particularly if it is intended to be a gap between live minefields. However, one vehicle observed by enemy reconnaissance driving through a phony minefield compromises its effectiveness.

Live mines are never laid in a phony minefield. A minefield designated as phony implies that the area contains no live mines. Emplacing

even a single live mine within a phony minefield makes it a live minefield no matter how low the density. Empty tins and such may be laid in a phony minefield, but it is seldom worthwhile. Minefield marking and covering fire should be the same as for a live minefield. Employment authority and reporting requirements are the same as for the minefield being simulated.

Protective Versus Tactical Minefields

As discussed, minefields can be *tactical* or *protective* obstacles. Tactical and protective obstacles have different purposes with regard to the enemy's maneuver. This difference causes them to have a particular relative place on the battlefield. Tactical obstacles attack enemy maneuver and are placed on the battlefield where the enemy maneuvers from march, prebattle, and attack formations. Protective obstacles are used to protect the force from the enemy's final assault onto the force's position. Protective obstacles are close to defensive positions and are tied in with the FPF of the defending unit (Figure 2-1).

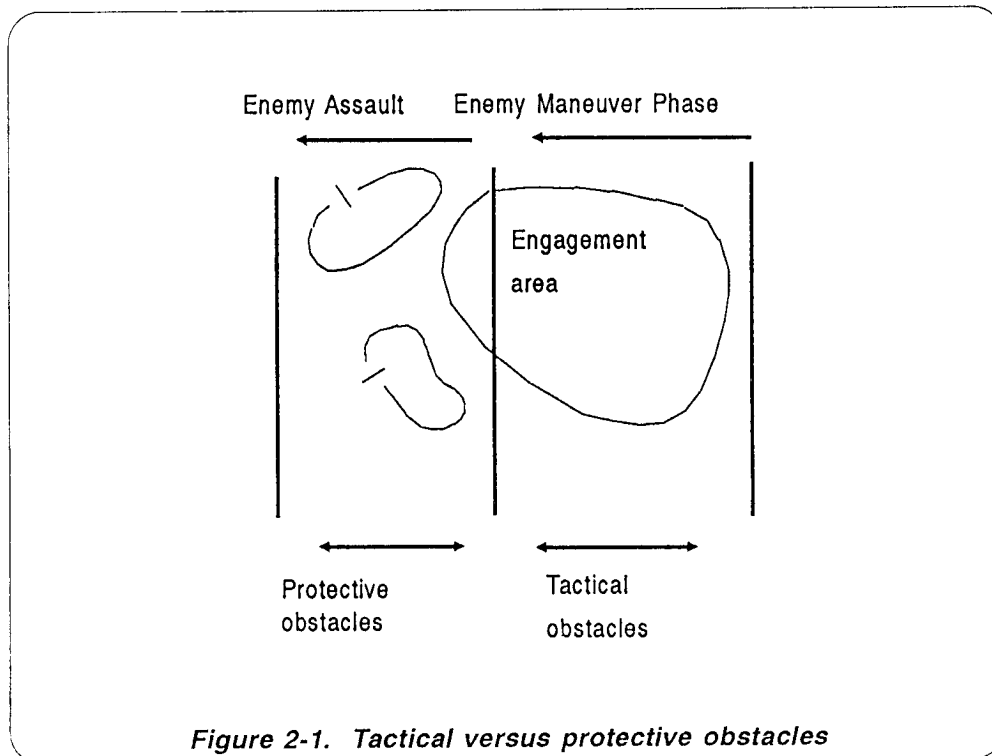

TACTICAL MINEFIELD EFFECTS AND DESIGNS

Tactical minefields are designed, sited, emplaced, and integrated with fires to produce four specific tactical obstacle effects: disrupt, turn, fix, and block (Figure 2-2). Each obstacle effect has a specific impact on the enemy's ability to maneuver, mass, and reinforce. They also increase the enemy's vulnerability to friendly fires. Obstacle effects support the friendly scheme of maneuver by manipulating the enemy in a way that is critical to the commander's intent and scheme of maneuver. Minefield design is the means by which the emplacing unit varies minefield width, minefield depth, mine density, mine composition, use of AHDs, and an irregular outer edge (IOE) to best achieve one of the four tactical obstacle effects. Modifying these variables is at the heart of tactical minefield employment principles.

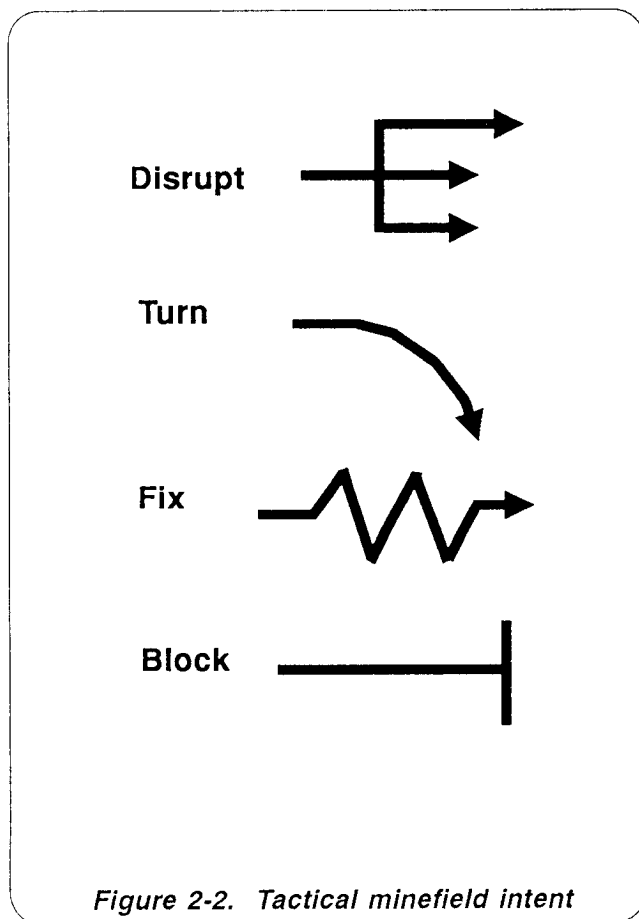

Tactical Minefield Variables

First, it is important to understand how the variables relate to minefield effects. Figure 2-3, page 2-6, helps clearly define some of the terms used to discuss minefield variables.

Front. Minefield frontage is that dimension of minefield that defines how much of the attacking enemy formation is affected by the minefield. The front of an individual minefield is based on the desired minefield effect (disrupt, turn, fix, and block) and the attack frontage of an enemy company. The frontage of an attacking enemy depends largely on the type enemy force (armored, motorized, or dismounted infantry) and norms by which their army fights. For armored warfare, the frontage of an individual minefield is based on effecting a doctrinal company attack frontage of 500 meters (13 to 18 combat vehicles). Frontages may vary and require a study of the enemy force and terrain. Groups of individual minefields are employed to affect battalion and larger formations to achieve a larger frontage. For example, a battalion consisting of 52 to 72 combat vehicles has a frontage of 1,500 meters and requires more minefields.

Depth. Minefield depth is based on the amount of breaching assets we want the enemy to exhaust to reduce a lane. The standard should start with 100 meters and increase in depth if denying the enemy use of a mobility corridor (MC) is the intent (turn or block).

Density. Minefield density is an expression of how many mines are contained in the minefield. It is expressed in either linear or area density. Linear density is an expression of the average number of mines within a 1-meter path through the minefield's depth anywhere along the front. In Figure 2-3, page 2-6, the minefield contains 100 mines with a minefield front of 200 meters. The linear density is 0.5 mine per meter front (100 mines/200 meters of front). Area density is the average number of mines in a 1-square-meter area anywhere in the minefield. The minefield contains 100 mines within a 20,000-square-meter

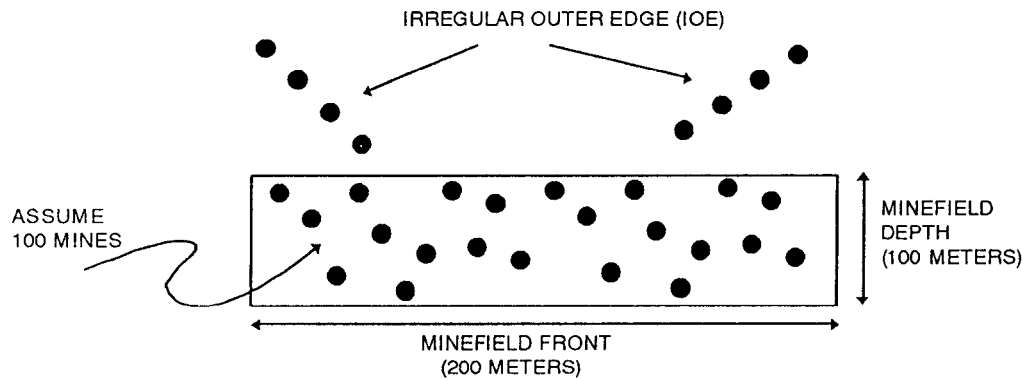

Figure 2-3. Minefield variables

area. The area density is .005 mine/square meter (100 mines/(200-meters X 100 meters)). Area density is normally used to express only the density of scatterable minefields.

Mine composition. This variable includes effective use of different types of mines. By using full-width kill mines, the probability of kill increases for the minefield. AP mines are used where the enemy is expected to conduct a dismounted breach.

AT mines. If the enemy is an armored force, tactical obstacles are predominantly AT heavy. The two options for minefield composition are full-width and track-width fuzed mines. Track-width mines (M15s) have a lower probability of kill (M-Kill or K-Kill) compared to full-width fuzed mines (M21s). The ratio of full-width versus track-width in a minefield depends on

the kill required. In general, a track-width minefield does not adequately affect the enemy's maneuver.

AP mines. AP mines target dismounted soldiers. Their composition in tactical minefields depends on the threat and the enemy's breaching assets. Based on current technology, the majority of breaching operations are accomplished by mechanical or explosive means. If the minefield intent is to exhaust the enemy's breaching assets, AP mines would be integrated to attack his dismounted breach ability.

Probability of encounter and kill. The probability of encounter and kill are measures of a minefield's lethality. Probability of encounter is a measure (expressed in percent chance) that a vehicle blindly moving through

a minefield will detonate a mine. The probability of mine encounter is a function of mine density, type of mine, and type of enemy vehicle. In short, the more dense a minefield the higher the probability is of encountering a mine. Probability of encounter also depends on the fuze capability of the mines emplaced. Tilt-rod and magnetic-fuzed mines will detonate if they are encountered anywhere along the width of the enemy vehicle. Pressure-fuzed mines only detonate if a vehicle's track or wheel actually runs over them.

Probability of encounter is affected by the type of enemy vehicle. The smaller the width or track signature of the vehicle, the less likely it will encounter and detonate a mine. Finally, probability of kill is measured (in percent

chance) that the vehicle is no longer mission-capable (M-Kill or K-Kill) because of mine effects. It is a function of the combined probability that a vehicle will encounter a mine and the probability that the mine effect will produce either an M-Kill or a K-Kill.

Figure 2-4 illustrates the relationship between density and probability of mine encounter for light versus heavy tracked vehicles and pressure versus heavy tracked vehicles and pressure versus full-width fuze-capable mines. Figure 2-4 also provides general guidance for varying density to yield the necessary probability of encounter to construct minefields with disrupt, fix, turn, or block effects. Varying density and probability of encounter to achieve these effects is discussed in more detail later in this chapter.

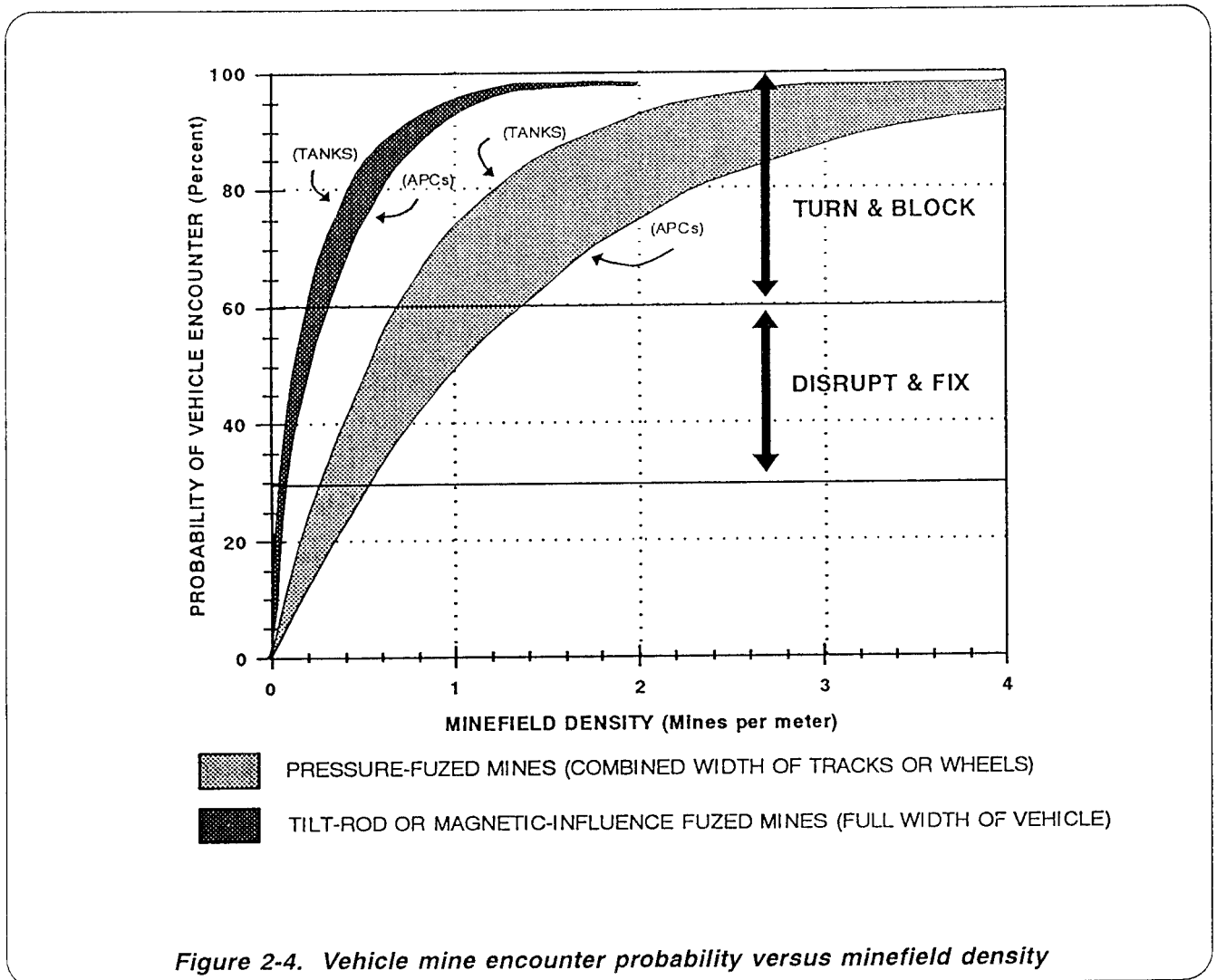

Figure 2-4. Vehicle mine encounter probability versus minefield density

AHDs. Emplacing AHDs on mines is time-intensive. AHDs are added to a minefield to protect it from covert and dismounted breaches and to demoralize the enemy attempting to clear minefields.

IOE. An IOE is a strip or multiple strips of mines normally extending toward the enemy from the first (enemy side) row of mines. An IOE is employed to break up the otherwise regular pattern of a minefield. It is used to confuse the enemy as to the exact limits of the minefield, particularly its leading edge. An IOE adds an unknown quality to a minefield that makes enemy breach or bypass decisions more difficult. The effect the IOE has on enemy actions may increase the overall lethality of the minefield.

Tactical Minefield Design

Modifying the above minefield variables to achieve the desired obstacle effect is a challenge for the engineer, both technically (resourcing and designing) and tactically (supporting the maneuver scheme). Figures 2-5 through 2-8, pages 2-9 through 2-12, provide guidelines for varying minefield depth, frontage, density, and composition to best achieve disrupt, fix, turn, and block effects.

The guidelines are not fixed rules. They are simply considerations or parameters to use when designing tactical minefields regardless of emplacement method. They apply to conventional mine-laying techniques as well as employment of scatterable mine dispensers. They give the engineer the flexibility to design and emplace tactical minefields based on mission, enemy, terrain, troops, and time available (METT-T) (particularly resources available and terrain) and still achieve the required effect. These *norms* are also the basis for developing the standard minefield packages and emplacement procedures outlined throughout the remainder of this manual. Chapter 3 is dedicated to the standard pattern minefield, Chapter 4 outlines procedures for row mining using conventional mines, and Chapter 6 discusses the characteristics and emplacement procedures for each of the scatterable mine systems. Each chapter describes standard disrupt, fix,

turn, and block packages particular to that method of emplacement or dispensing system.

One of the new norms introduced below is the minefield resourcing factor. Each tactical obstacle effect has a specific resourcing factor. In short, this numeric value helps determine the amount of linear tactical-obstacle effort needed to achieve the desired effect. The resource factor is multiplied by the width of the avenue of approach (AA) or MC to get the total amount of linear obstacle required. The linear effort is then divided by the minefield frontage norm for the specific effect (rounded up) to yield the number of individual minefields required in the obstacle group.

Disrupt. A disrupt effect breaks up the enemy's formations, causes premature commitment of breach assets, interrupts command and control, alters timing, and causes a piecemealed commitment of attacking units (Figure 2-5). Disrupt minefields should not be time-, manpower-, or resource-intensive. They are used forward of or within engagement areas (EAs).

To achieve a disrupt effect, normally only half of the enemy's AA is attacked with minefields or other tactical obstacles. In order for a minefield to disrupt an enemy company (frontage of 500 meters), half the formation has to react to the minefield. The typical width of a disrupt minefield is 250 meters. To disrupt an enemy battalion, three individual disrupt minefields (750 meters of minefield) are combined to attack half his frontage. The standard depth for a single disrupt minefield is 100 meters. When designing a disrupt effect to attack an enemy battalion, three disrupt minefields are arrayed in a box (group) with a width and depth about half the size of the frontage. The resource factor for a disrupt group is 0.5. This factor, multiplied by the width of the AA, provides the amount of linear minefield required for a disrupt effect. An alternative disrupt group is three point obstacles along the AA when the avenue is narrow.

Disrupt minefields should be designed with approximately 50 percent probability of mine encounter to achieve the desired disrupt effect

Resource factor	0.5 (3 point obst) x AA
Group dimensions	W=0.5 x AA; D=0.5 x AA
Probability of kill	50%
Frontage	250 m
Depth	100 m
AT Mines	Yes (Pressure/tilt)
AP Mines	No
AHD	No
IOE	No

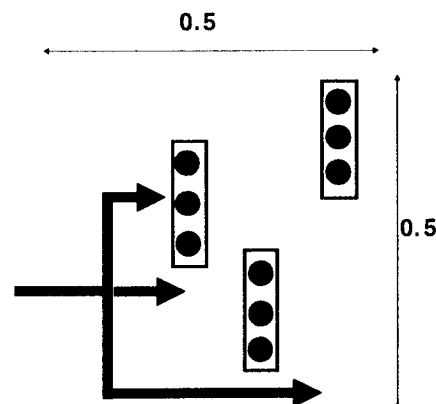

★ Figure 2-5. Disrupt minefield

(Figure 2-4, page 2-7). The disrupt minefield should contain predominantly track-width AT mines. Full-width mines, which increase the probability of mine encounter, are used at the leading edge of the minefield. This should cause the enemy to commit his breaching assets.

AHDs may be added to disrupt minefields to frustrate the enemy's breaching and clearing operations. However, adding AHDs may be too resource-intensive for the return in effect. Normally, AHDs are not added to disrupt minefield emplaced with conventional mines. Most scatterable mine systems have some form of inherent AHD requiring no additional effort. An IOE is not required to deceive the enemy on minefield orientation or to increase the probability of kill.

★ **Fix.** This is the most misunderstood obstacle effect. The term does not mean to stop an enemy advance. A fix effect slows the enemy within a specified area, normally an EA, so that he can be destroyed with fires (Figure 2-6, page 2-10). The primary use of the fix effect

is to give the defender time to acquire, target, and destroy the attacking enemy throughout the depth of an EA or AA. A fix effect may be used to generate the time necessary for the force to break contact and disengage as the enemy maneuvers into the area (typically used for delays). Fix minefields in the group must be employed in depth, causing the enemy formation to react and breach repeatedly. Fixing groups must span the entire width of the AA.

Individual fix minefields must not appear too difficult to breach. The enemy should be enticed into the area. The obstacles should not be made to look impenetrable. The concept is to employ multiple individual minefields that each attack only a portion of a deployed company formation. Therefore, the fix minefield frontage is 250 meters. It takes on the characteristics of a disrupt minefield (with two changes) with a similar density, mine composition, and probability of encounter (Figure 2-4). AHDs are not required because the application of massed direct and indirect fires complicate the enemy's breaching effort. An IOE

is added to further delay the enemy and confuse the attacker on the exact orientation of individual minefields. This also serves to increase the effective lethality of the minefield. The majority of mines are track-width AT. The most lethal AT mines (full-width) are used in the IOE and the leading edge of the minefield.

While individual minefields are designed to attack only portions of an enemy company formation, the fix group as a whole is resourced, arranged, and sited to attack the entire front of an enemy battalion. Figure 2-6 depicts a fix group effect on an attacking enemy battalion. In this case, six fix minefields are arrayed in an area the full width of the battalion AA (1,500 meters) by 1,500 meters deep. Accordingly, the resource factor for a fix minefield group is 1: the amount of linear minefield that should be resourced equals the width of the AA.

Turn. A turn effect manipulates the enemy's maneuver in a desired direction (Figure 2-7). One technique or a combination of three tech-

niques aid in achieving the turn effect. First, in order to entice the enemy to maneuver in the desired direction rather than breach the obstacle, the obstacle must have a subtle orientation. Second, the bypass must be easily detected in order to entice the enemy to it. Finally, the point where the turn is to be initiated is anchored by no-go terrain or heavily fortified friendly forces.

The standard turn minefield has a width of 500 meters and a depth of 300 meters. One turn minefield affects the entire width of an enemy company's frontage. It must be deep enough to cause multiple applications of line-charge breach assets. In short, the minefield must discourage any attempts to breach and entice the enemy to bypass rather than reduce. Figure 2-7 depicts a turn effect on an attacking battalion. Three standard turn minefields are arrayed in a group 1,500 meters wide (1.0 x width of battalion frontage) by 1,500 meters deep. The orientation (angle) of the minefields may mean a fourth minefield is required to effect the entire frontage. This is considered

Resource factor	1.0 x AA
Group dimensions	W=1.0 x AA; D=1.0 x AA
Probability of kill	50%
Frontage	250 m
Depth	120 m
AT Mines	Yes (Pressure/tilt)
AP Mines	No
AHD	No
IOE	Yes

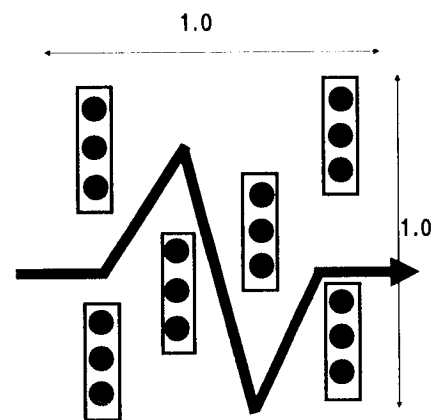

★ Figure 2-6. Fix minefield

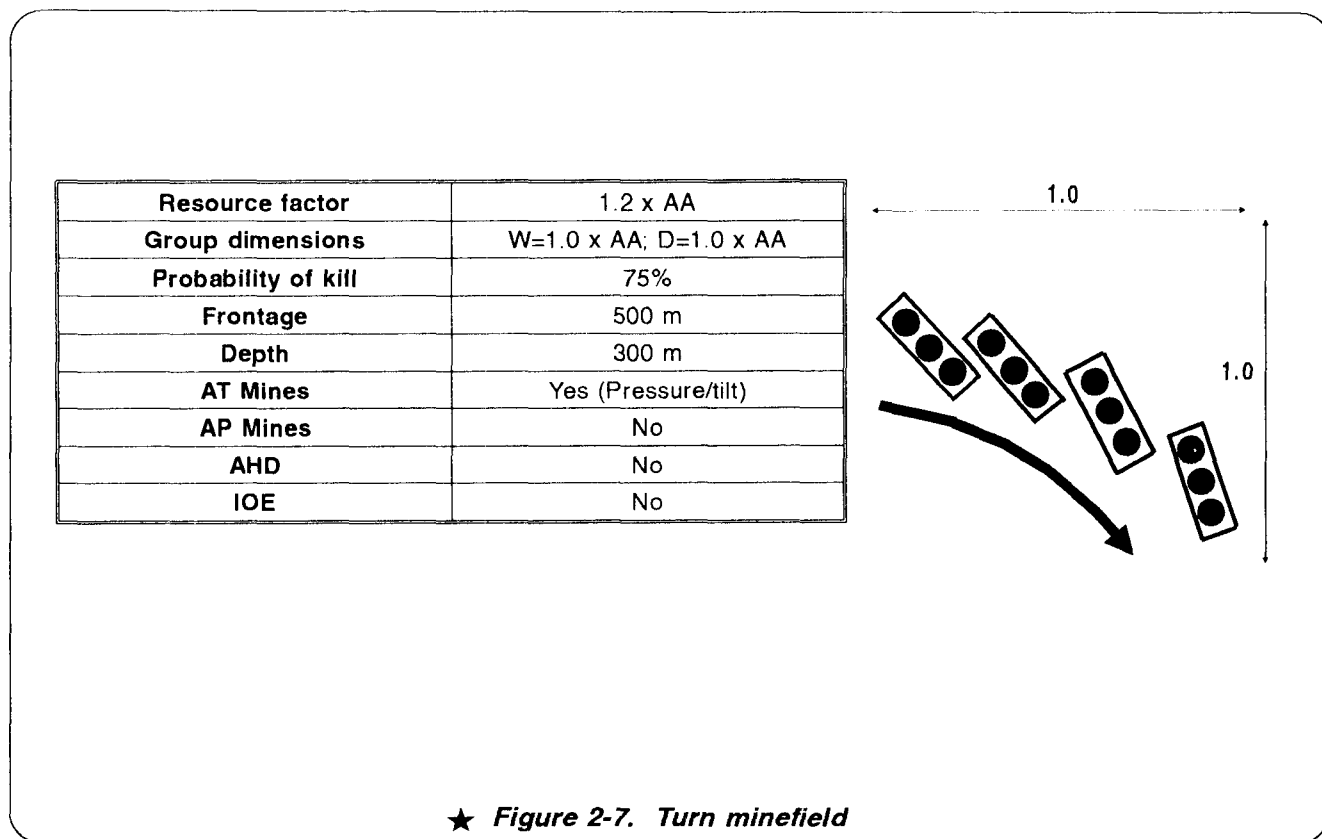

in the resource factor (1.2) for a turn obstacle group. This factor, multiplied by the width of the AA, equals the amount of linear minefield required for this turn effect.

As shown in Figure 2-4, page 2-7, turn minefield must be extremely lethal and achieve approximately 80 percent probability of encounter. In other words, an enemy vehicle attempting to breach or bull through the minefield must pay the consequences. This forces the small unit commander to make an immediate decision—breach or bypass. A lethal minefield, covered with intense fires with an easily detectable bypass, reduces breach decisions to instinct; and the enemy will choose the bypass (turn). To produce this lethality, the majority of mines should be full-width AT. Full-width mines in the first rows the enemy encounters and the depth of the minefield either exhaust the enemy’s breaching assets or convince him to bypass early. AHDs are not required since the enemy force will seldom commit to dismounted breach when faced with intense direct and indirect fires. An IOE should

not be used; the enemy must be able to determine the orientation of the minefield and the bypass.

Block. A block minefield is designed specifically to stop an enemy’s advance along a specific AA or allow him to advance at an extremely high cost (Figure 2-8, page 2- 12). Blocking obstacles are complex and integrated with intense fires: block minefields do not stop an attacker by themselves. Individual blocking obstacles are employed successively in a relatively shallow area. As soon as the enemy breaches one blocking obstacle, it is critical that he encounters another, thus denying him to project combat power and maintain momentum. Blocking obstacles must defeat the enemy’s breaching effort, both mounted and dismounted, as well as his maneuver. The block effect must span the entire width of the AA and must not allow a bypass.

The typical block minefield is 500 meters wide and 300+ meters deep (includes an IOE). Figure 2-8 depicts a block effect on an attacking bat-

Resource factor	2.4 x AA
Group dimensions	W=1.0 x AA; D=.33 x AA
Probability of kill	100%
Frontage	500 m
Depth	300+ m
AT Mines	Yes (Pressure/tilt)
AP Mines	Yes
AHD	Yes

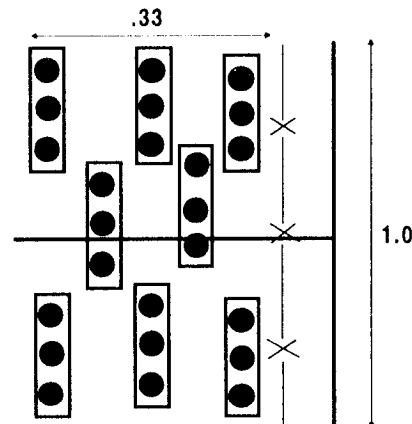

★ Figure 2-8. Block minefield

★ talion. Note how individual minefields are arrayed to affect the entire width of the AA but in a relatively shallow depth (only one-third the width). Eight block minefields are required in this example to achieve the necessary group depth and width. The block group is understandably more resource-intensive. The resource factor is 2.4 (multiplied by the width of the AA equals linear minefield required). As mobility corridors become more narrow, blocking minefield groups may become impossible to fit within the condensed depth. Simply expand the group's depth to accommodate the required number of individual minefields.

★ The lethality of the block minefield (80 percent or higher) is similar to the turn minefield (Figure 2-4, page 2-7). The lethality of the group is considerably higher, since there are enough minefields in the group to cover over twice the width of the AA. This lethality is produced by a density slightly greater than 1 mine/meter

of front and use of predominantly full-width AT mines.

The block minefield must be capable of defeating both mechanical and dismounted breach efforts. Therefore, AP mines and AHDs are used to target dismounted breaching. An IOE again confuses the attacker as to the exact minefield limits and complicates his employment of mechanical breaching assets. The depth of the block minefield requires employing multiple line charges.

The above minefields are not standard solutions to every situation. The terrain could dictate a decrease or increase in the effort required. Incorporating other reinforcing obstacles (AT ditches, road craters, wire, or a family of scatterable mines (FASCAM)) aid in attacking the different breach assets. Experience provides the best basis for designing minefields.

TACTICAL OBSTACLE INTEGRATION PRINCIPLES

Echelons of Obstacle Control

Tactical obstacle planning occurs at every level, and each level uses different graphic control measures (Figure 2-9). This ensures obstacle plans are well-synchronized and are mutually supporting from corps down through battalion. In some cases, corps may also designate obstacle zones to division. Normally, divisions use obstacle zones, brigades use obstacle belts based on the division zones, and task forces (TFs) use obstacle groups based on obstacle belts.

A specific obstacle effect (disrupt, turn, fix, or block) may be assigned to obstacle control measures. This enables the commander to direct the overall effect obstacles within the designated zone, belt, or group must achieve to support his plan. At division level, assigning specific effects to obstacle zones is optional. However, at brigade and battalion level, the commander must assign specific effects to belts and groups, respectively. This ensures subordinate commanders emplace tactical obstacles that support the maneuver and fire plans. Assigning a specific obstacle effect to

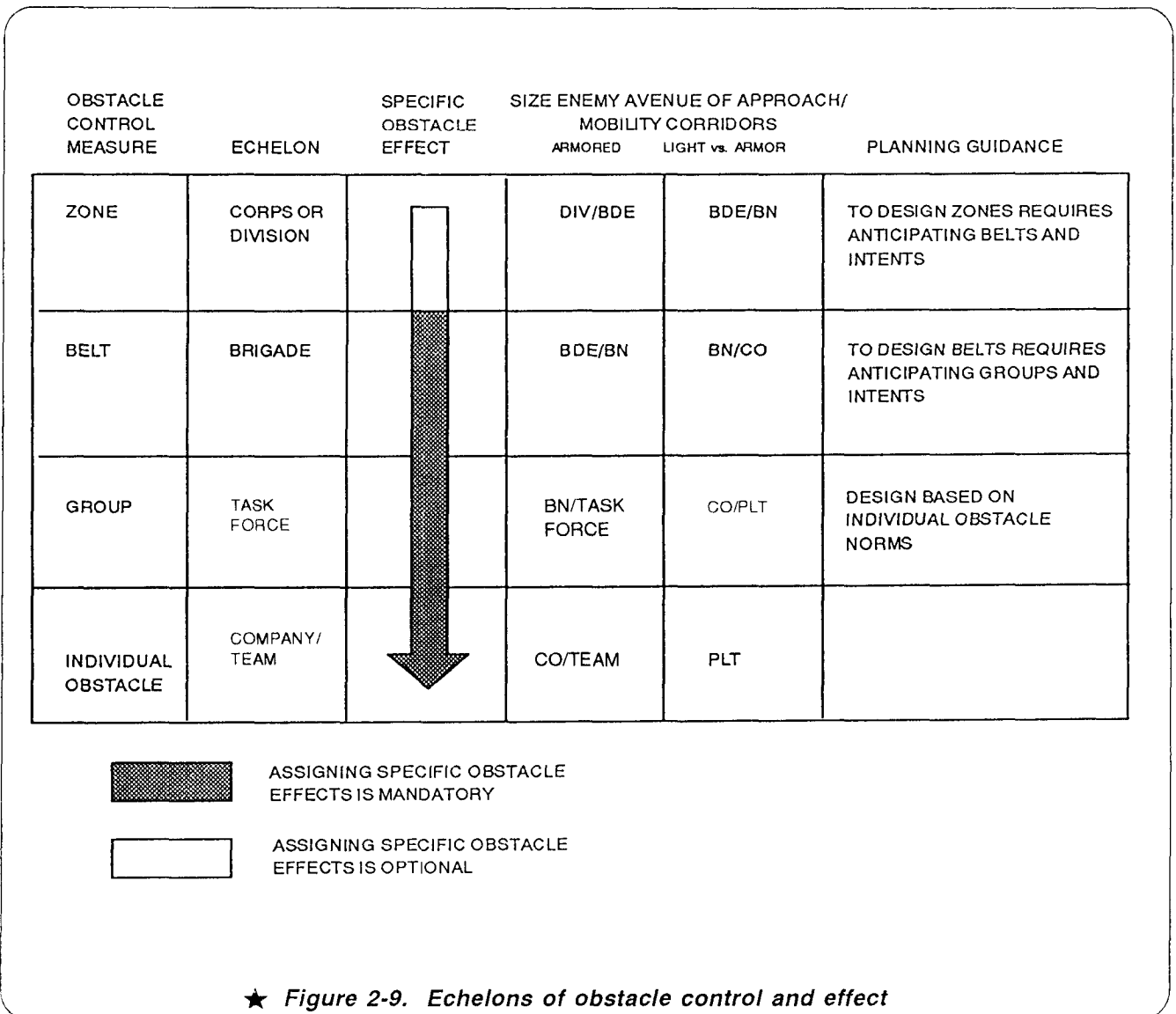

a control measure becomes obstacle intent giving the obstacle effect, target, and location. Obstacle intent provides a direct link between the obstacle plan and scheme of maneuver, commander's intent, and fire plan (direct and indirect). Obstacle intent is vital at brigade and below and becomes the foundation of obstacle group development and design at the TF level.

Each echelon uses obstacle control measures to limit/authorize emplacement of tactical obstacles by their subordinate units. Protective obstacles are the only obstacles that can be employed outside designated obstacle zones, belts, and groups.

At division, the commander uses obstacle zones to limit/authorize subordinate brigades where they can emplace tactical obstacles (brigades may only emplace tactical obstacles within obstacle zones). They plan obstacle zones to give maximum flexibility to maneuver brigades and to preserve the freedom of division counterattack forces and reserves (Figure 2-10). The division commander assigns an obstacle zone (a specific effect) only when he feels it is imperative to supporting the scheme of maneuver. The division staff also considers the plan for future operations when designating obstacle zones.

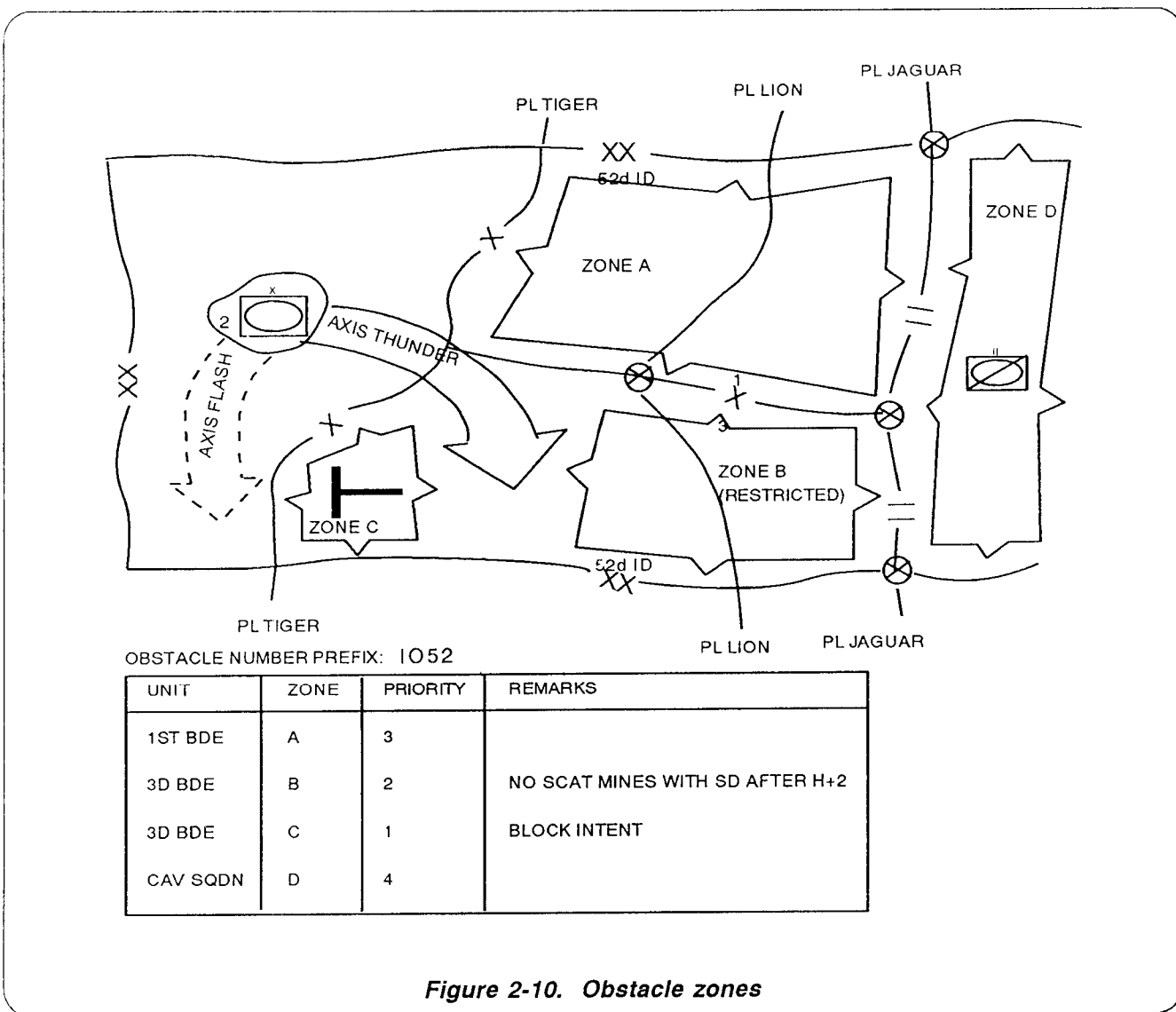

Figure 2-10. Obstacle zones

The brigade refines obstacle zones into belts (Figure 2-11). Like the division, the brigade uses belts to limit the location of tactical obstacles. This is normally the first level at which the commander assigns an intent to the obstacle plan. It gives TF commanders the necessary guidance on the overall effect of obstacles within a belt. It does not designate that all obstacle groups within the belt must be the same effect. It simply means that the sum effect of groups within the belt must achieve the assigned belt effect. This serves to synchronize the obstacle effort within the brigade, particularly between adjacent TFs.

Belts are planned to attack enemy regiments based on an analysis of enemy battalion AAs

and MCs. Brigades allocate maneuver companies based on the motorized rifle battalion (MRB) MCs and organize TFs to defeat the motorized rifle regiment (MRR). Obstacle belts and their intents are directed against MRR MCs. This provides the appropriate level of guidance while preserving the TF's need to refine the obstacle intent based on how they will fight their allocated companies.

TFs use obstacle groups as the basis for their obstacle planning (Figure 2-12, page 2- 16). TFs allocate platoons against motorized rifle company (MRC) MCs and task-organize them into company/teams to defeat MRBs. Likewise, direct fire plans are designed based on the maneuver of MRBs and independent MRCs.

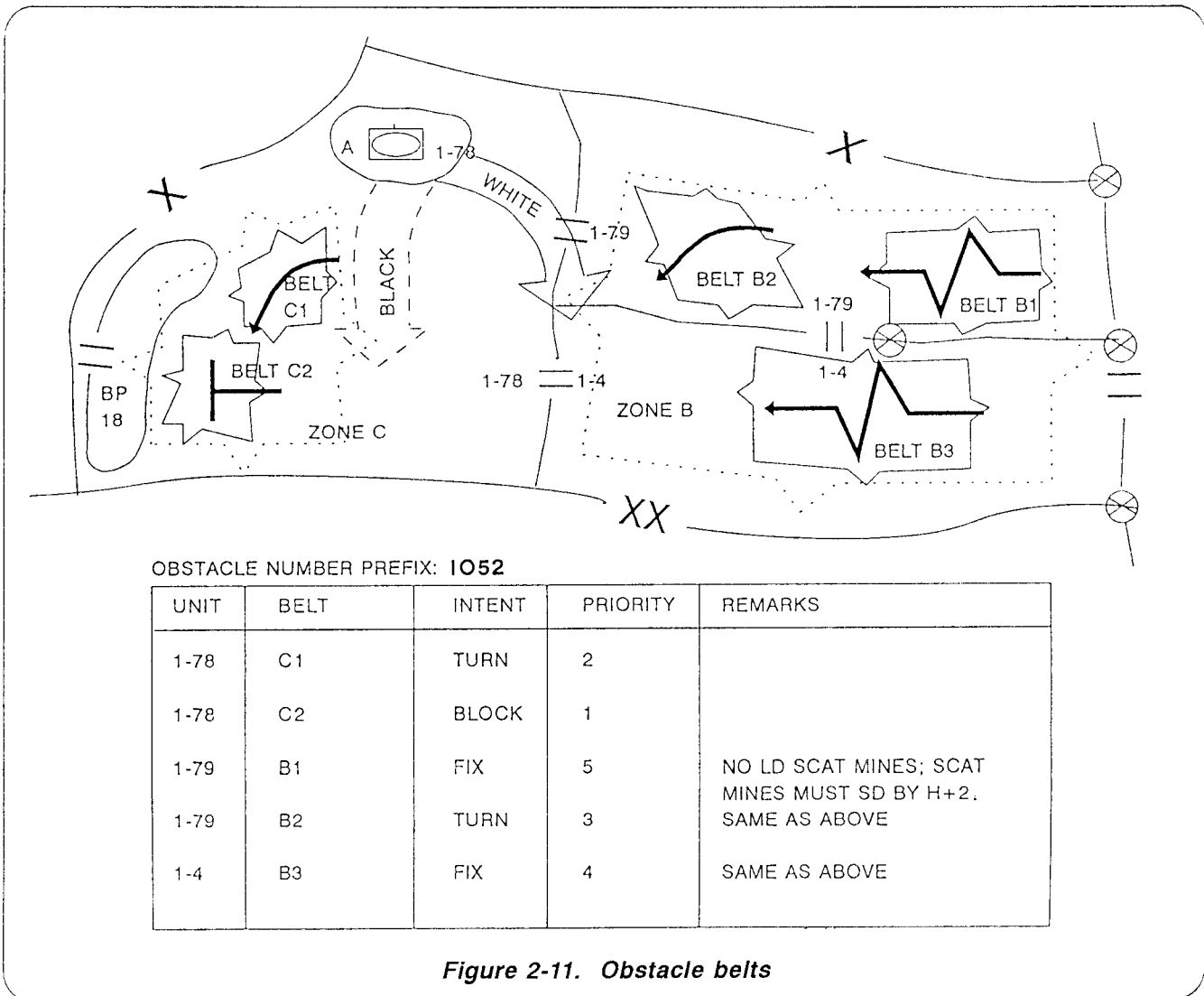

Figure 2-11. Obstacle belts

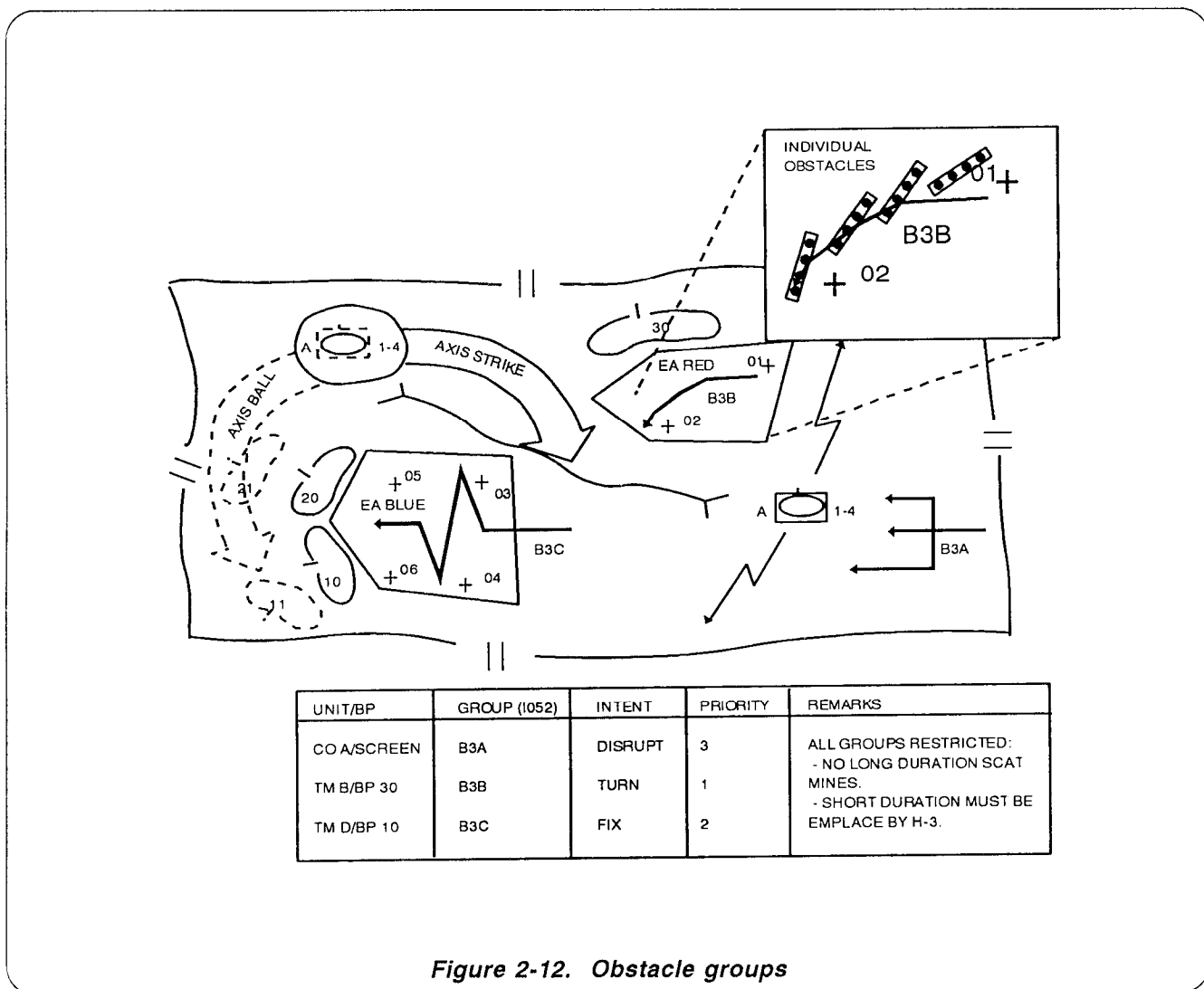

Figure 2-12. Obstacle groups

Therefore, obstacle groups are used to attack the maneuver of MRB-size forces. Groups are designed specifically to support the direct fire plan of the TF. The TF designates groups rather than obstacles because the location of individual obstacles hinges on siting at the company/team level. The group effect or obstacle intent drives obstacle siting and is therefore more important to convey to commanders. There can be more than one type obstacle group to support the overall intent of an obstacle belt. This is because the belt is designed based on the brigade maneuver scheme and without knowing the TF direct fire plan or maneuver scheme. Groups are developed once the fire plan is established.

Fratricide Prevention

The modern tendency toward maneuver warfare and the disappearance of the linear battlefield places repositioning forces at an increased risk of fratricide by minefield. Obstacle control and use of graphic obstacle control measures is vital in preventing minefield fratricide at every echelon. Obstacle control is further facilitated by positive command and control of all sustainment traffic, tactical repositioning, obstacle turnover, well-established and disseminated traffic plans with traffic control, and strict adherence to minefield marking procedures (discussed later in this chapter).

Supporting the Maneuver Plan

The goal of the obstacle-planning process is to achieve the commander's intent through optimum obstacle emplacement. A step-by-step approach is provided for the obstacle-planning process. The process begins by taking what the Intelligence Officer (US Army) (S2) knows about the enemy, analyzing the commander's intent for use of his available weapons, and then integrating tactical-obstacle effects to support the plan. The focus of the obstacle-planning process is at the TF level where the TF engineer plans obstacle groups.

Situational analysis. Obstacle planning begins with the situational template (developed by the S2). Knowing the AA, the lateral MCs, the no-go/slow-go/go terrain locations, and the enemy's probable course of action are essential to start the process. Figure 2-13, page 2-18, shows an example of a template which the engineer needs. AA Alpha is initially a regimental AA which splits into two battalion-size AAs. The commander has designated an EA (EA Red) where the MRR AA splits into two MRB AAs. Note how the commander has arrayed his forces to mass fires on EA Red.

Direct fire analysis. The next step is to understand the maneuver scheme and organization of fires. The location of the target-reference points (TRPs), trigger lines, and weapon systems helps determine exactly where the direct-fire systems are massed. Figure 2-14, page 2-19, shows a sample direct-fire plan. By analyzing direct fires, it is easy to see the area where the fires are massed. This is typically the desired location for killing the enemy. Based on analysis of the direct-fire plan, the engineer will plan obstacle groups which manipulate the enemy into areas where fires are massed.

Obstacle intent integration. Based on the TF commander's intent, obstacle group effects are recommended (Figure 2-15, page 2-20). The engineer starts by giving obstacle effects/groups a battlefield placement to support the maneuver plan. Normally, groups are allocated against MRB-size MCs, which are doctrinally 1,500 meters wide. A com-

pany/team is allocated to defeat an MRB. Therefore, the placement of obstacle groups is actually driven by company/team fire responsibility. As the engineer decides what type of group to use, it is important to keep in mind the type of weapons covering them to ensure compatibility.

Note the placement of obstacle groups in Figure 2-15 and their effects. First, the engineer must manipulate the right MRB into the EA and keep it off Team C's flank. The turn obstacle-group effect, combined with a heavy volume of AT fires from Team C at the turning point, achieves this. In EA Red, particularly where the TF fires are massed, a fixing group slows the enemy and increases the effects of the fires. Block groups between Team A and Team B and between Team B and Team C stop advance of the lead MRBs. Protective obstacles in front of all three team positions reinforce the blocking groups and protect the teams from the enemy's final assault.

Obstacle effect priorities. The engineer must designate which obstacle effects are most critical to the maneuver plan. This will identify the priority for resourcing and effort. Align tactical-obstacle-effect priorities with the TF direct-fire main effort. In this case, the first priority is to turn the enemy where the fires are massed. Second, it is the block tactical obstacle effect to keep the enemy in the EA in order to destroy him. The fix-obstacle effect is the last priority. While it enhances the TF fires in EA Red, it only slows the enemy. The block effects are a higher priority because they stop the enemy from exiting the EA.

Obstacle design/resourcing. Obstacle design begins by resourcing the groups based on MC widths and the desired effect. The TF engineer resources the obstacle groups according to obstacle group priorities. The total amount of linear minefield required in a particular group is equal to the width of the MC multiplied by the resource factor for the obstacle effect. Use Figure 2-11, page 2-15, to resource the obstacle groups.

Turn group. The turn group is intended to affect an MRB. The MC for an MRB is 1,500 meters. The resource factor for a turn effect is 1.2 (Figure 2-7, page 2-11). The amount of linear

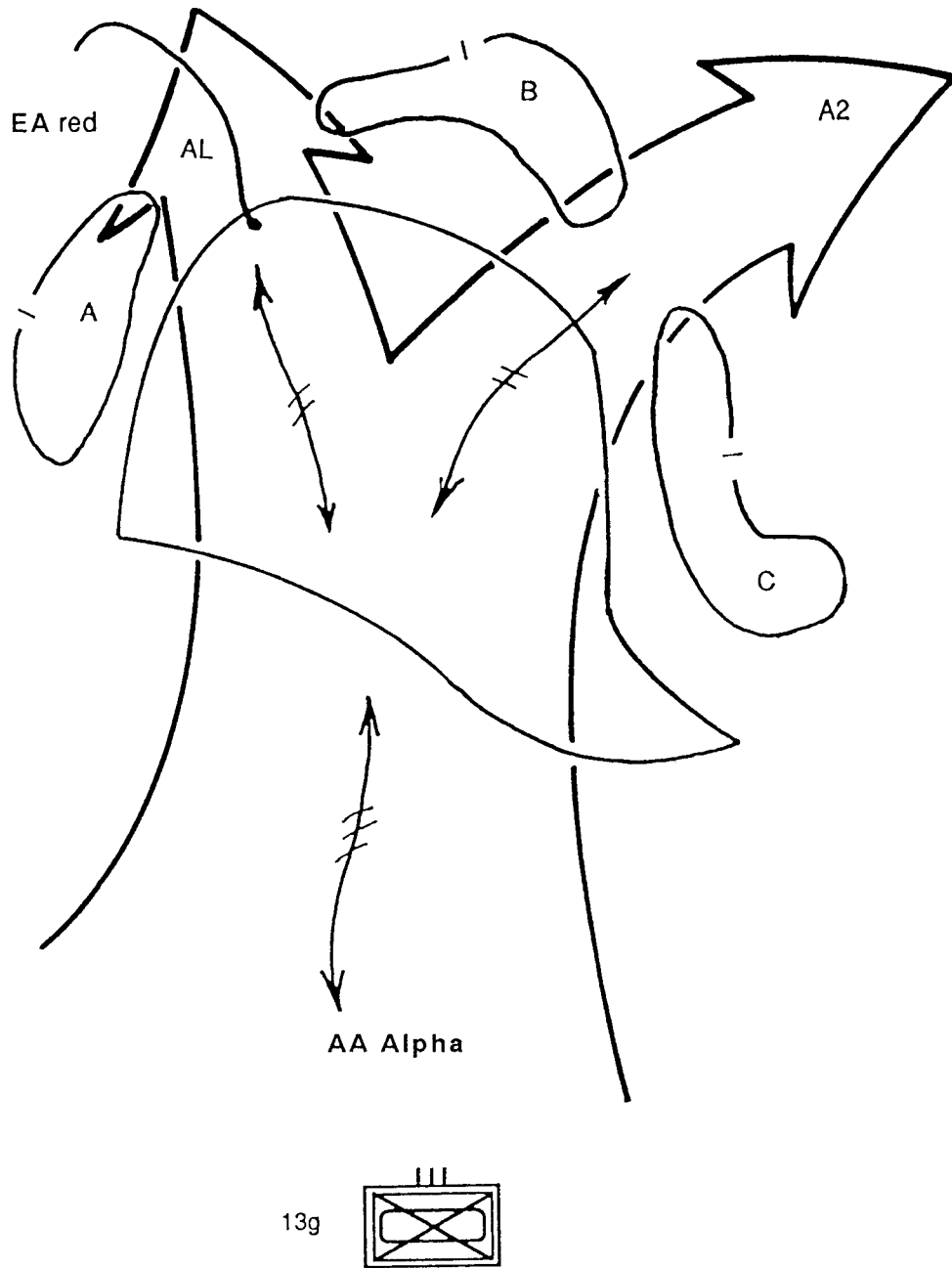

Figure 2-13. Situational template

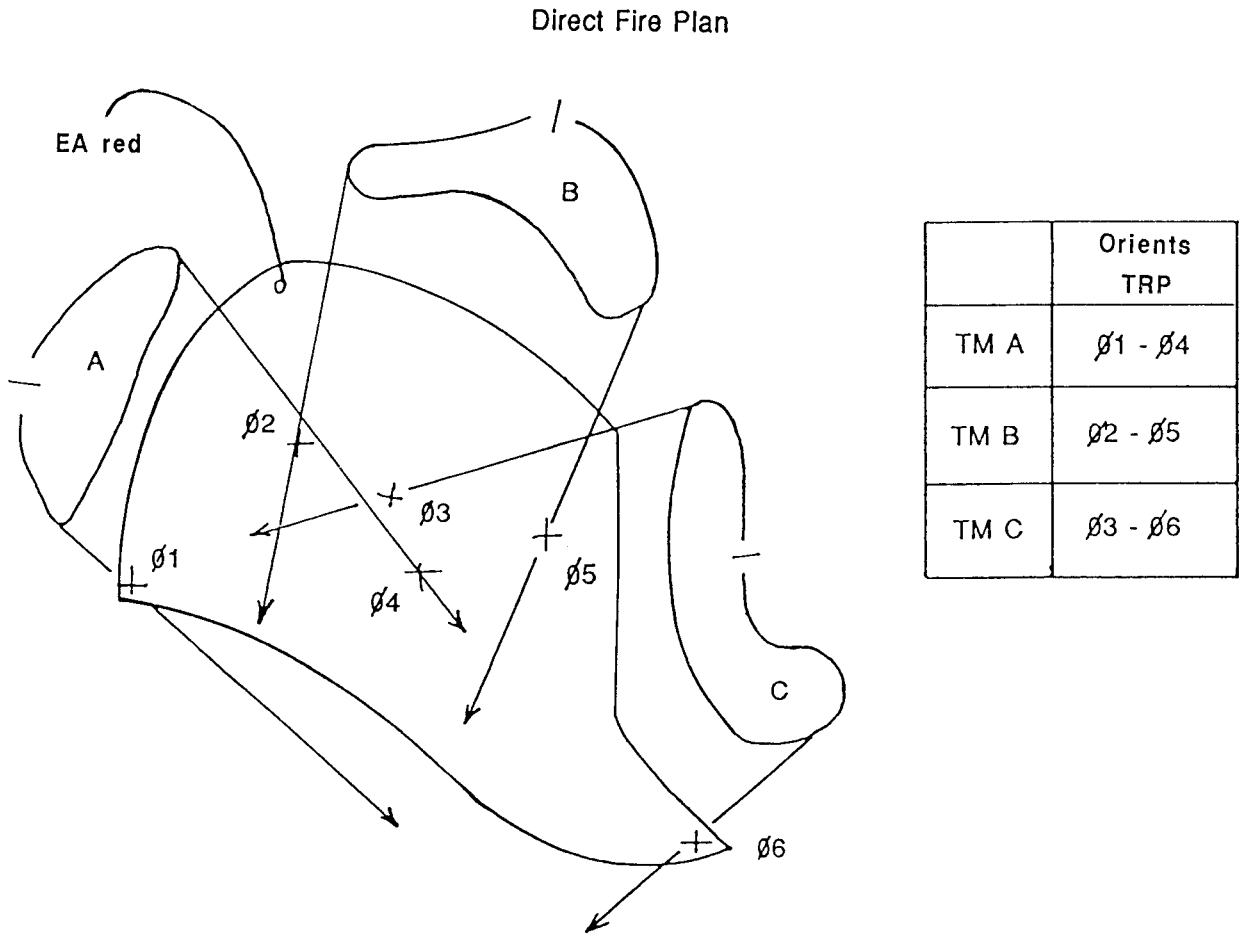

Figure 2-14. Obstacle group planning - direct fire plan

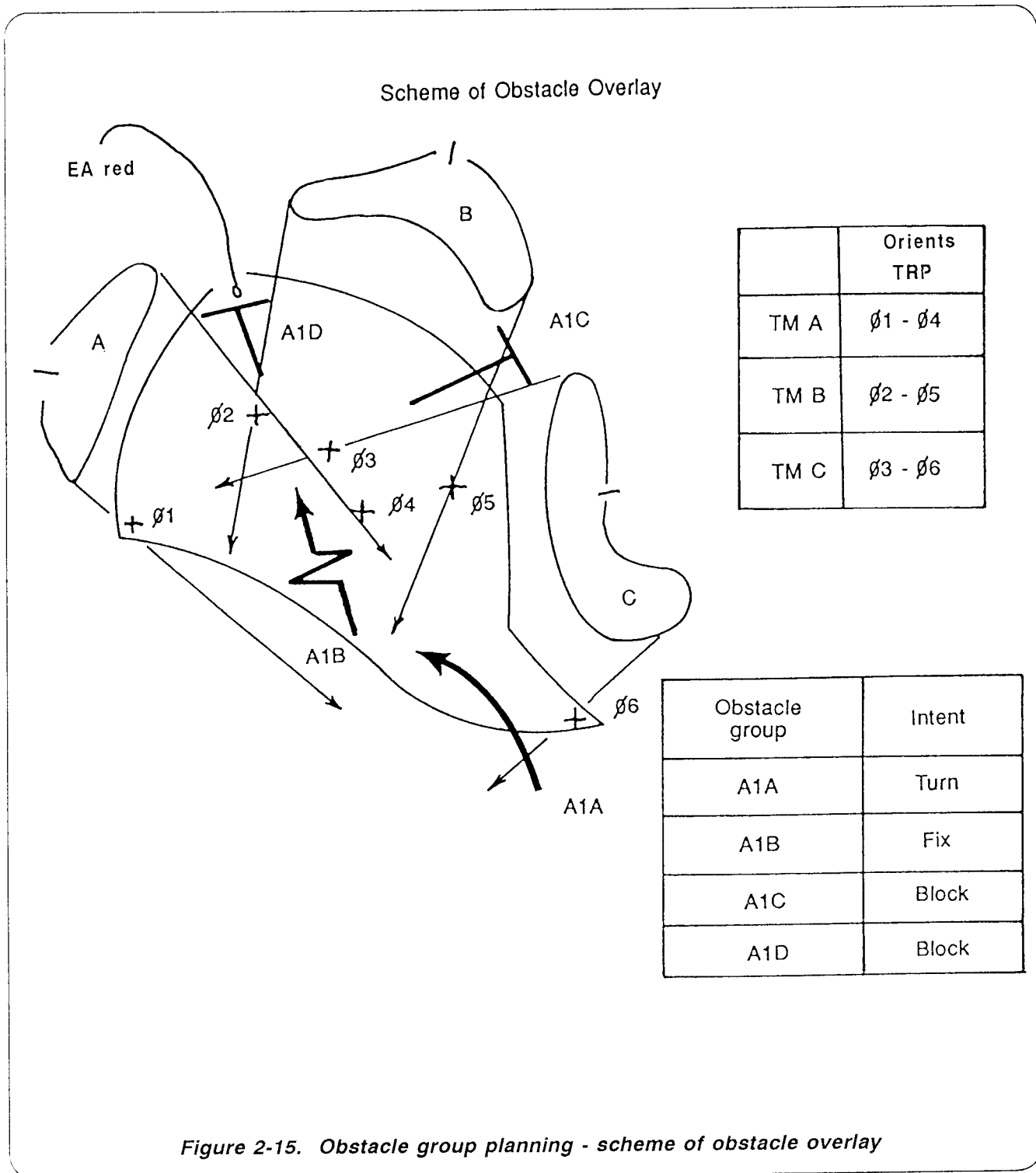

Figure 2-15. Obstacle group planning - scheme of obstacle overlay

minefield required to emplace this turn group is 1,800 meters. Individual turn minefields are 500 meters wide. Round up the linear minefield amount to equal individual minefield increments. This turn group requires four turn minefields. Chapter 4 provides the actual total mine requirements, by type, to resource this group.

Fix group. The fix group effects an MRB on an MC of 1,500 meters. Multiplied by the resource factor of 1 (fix), 1,500 meters of fix minefield are required. Fix minefields are 250 meters wide; resources are provided to emplace six minefields

Block groups. Both block groups affect MRBs with MCs 1,500 meters wide. The width of the MC multiplied by the resource factor of 2.4 (block) equals 3,600 meters. Block minefields are 500 meters wide. Each block group is resourced with enough mines and material to emplace eight block minefields.

Once obstacle groups are resourced, the engineer designs individual obstacles using the intent graphics as a guide. The design of individual obstacles may be conducted at the engineer platoon level if there has not been sufficient reconnaissance at the TF level to lock in the direct fire plan and obstacle plan. In this case, the platoon leader may be given the obstacle groups and may have allocated the resources necessary. He designs the individual obstacles based on ground reconnaissance and coordination with company/ team commanders. The next section of this chapter provides guidance on siting and emplacing tactical minefields at the engineer platoon and maneuver company/ team level.

The TF commander may conduct a TF reconnaissance to establish company/team fire responsibilities, site supporting individual obstacles, and establish other fires responsibilities (field artillery (FA) or attack helicopter). The commander may choose to do this at critical places within the TF sector. The TF engineer is a key player in this reconnaissance.

Siting in individual obstacles, which make up a planned group, follows the same procedures discussed at the engineer platoon and company/team level. Reconnaissance and coordination is conducted with the TF staff and the company/team commander in the company/team area of operations. The reconnaissance party reviews AAs and MCs affecting the company/ team area. The company/team commander identifies his direct fire plan and responsibilities and points out the location of his TRPs and EA. He verifies the company/team task organization and location of key weapons. Based on the scheme of obstacles overlay, the engineer platoon sites in the effect of the obstacle group. The TF engineer has someone drive the trace of the proposed individual obstacles. The TF commander, company/team commander, and TF engineer verify the location of individual obstacles and their integration with the direct-fire plan. Other fire responsibilities are verified at this time. Figure 2-16 shows the relative location and arrangement of individual obstacles within the turning obstacle group.

Mobility requirements identification. After designing obstacle groups and individual obstacles, the engineer identifies mobility requirements (obstacles which need lanes). Lanes are normally required for tactical repositioning and sustainment traffic. After coordination with the TF staff, lane requirements are identified and command and control procedures are established. Lane marking is discussed later in this chapter.

Scheme of obstacles overlay. The scheme of obstacles overlay is the final and most important product of the obstacle planning process. It illustrates to commanders at company/team level where obstacle groups will be located on the battlefield and their effect on the enemy's maneuver. As a minimum, the overlay must show obstacle groups, effect graphics, and lane locations. If individual obstacles have already been identified, they are also shown on the overlay.

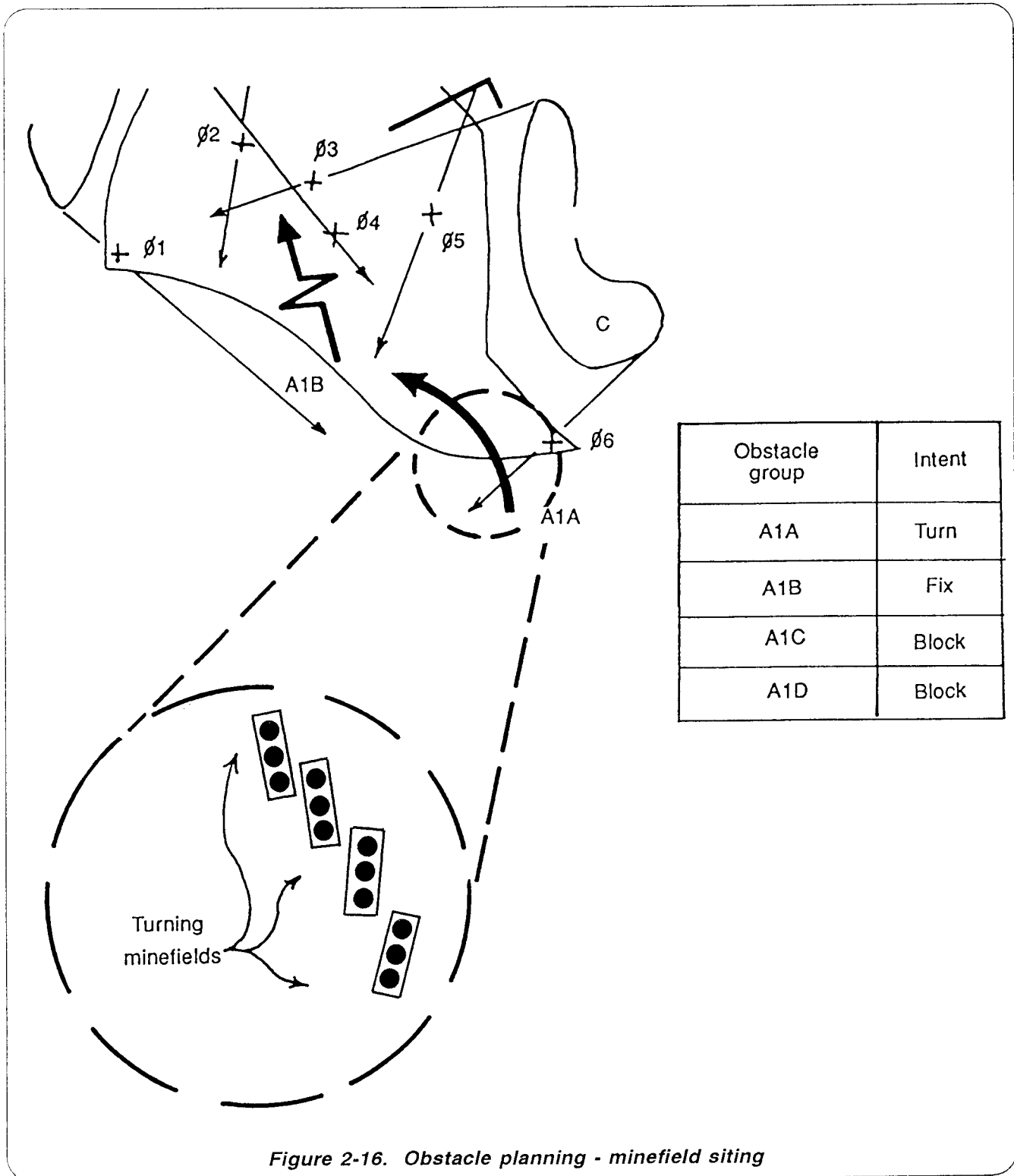

SITING AND EMPLACING TACTICAL MINEFIELDS

This section outlines principles for siting tactical minefields to support the maneuver company. These principles apply to all methods of emplacement—standard pattern, row mining, and scatterable mine systems. The focal point of the discussions on siting is the coordination that must occur between the emplacing engineer (normally the engineer platoon leader) and the maneuver company commander. Coordination between the engineer platoon and the maneuver company is perhaps the most vital component of effective obstacle integration. Obstacles are directly integrated with weapon effects, capability, and fire plan at this level. There are two subcomponents of tactical obstacle siting—coordination with the maneuver commander and siting the minefield.

Coordination with the Maneuver Company/Team Commander

Effective coordination with the maneuver company/team commander who will fight the obstacle(s) is essential to realizing the full potential of minefields as a combat multiplier. In short, the emplacing engineer becomes the maneuver company/team commander's team engineer for the mission. The engineer and the maneuver commander must work closely to ensure complete integration of the minefield in all aspects of the company plan. But before the emplacing engineer can conduct effective coordination, he must have certain tools or information from the TF order that serve as common ground between the emplacing engineer and the maneuver commander. These drive the integration of tactical obstacles into the fire plan and ensure they attack their intended enemy target in a way that supports the scheme of maneuver.

Below is a list of minimum tools or information that the emplacing engineer must have in order to conduct coordination with the maneuver company commander. A brief discussion of each is included, focusing on how that tool or information relates to tactical obstacle siting.

Modified combined obstacles overlay MCOO. The MCOO is a product from the intelligence preparation of the battlefield (IPB) process that graphically depicts the maneuverability of the terrain. It depicts slow-go and no-go terrain relative to the type enemy force. It also defines AAs and MCs the enemy may use for his attack. Since tactical obstacles attack the enemy's maneuver and must compliment the existing terrain, the MCOO is vital to obstacle siting. It helps ensure that obstacles correctly address enemy AAs and MCs. It also helps select how and what part of the enemy formation will be directly attacked by obstacles and the effect the obstacles will have on the enemy's maneuver.

Situation template. The situation template is developed by the maneuver battalion S2 during the IPB. It depicts his estimate of how the enemy will attack, in terms of size and type units, and the formations they will use. At battalion level, the situation template normally depicts down to enemy battalions but may include special company-size forces such as a forward security element. Tactical obstacles are employed to produce specific effects on specific enemy targets. Therefore, the situation template helps the engineer and maneuver commander site and emplace obstacles in a way that attacks the right target. The situation template may also depict the likely routes for enemy reconnaissance elements. This helps the engineer and maneuver commander analyze requirements for reconnaissance and surveillance (R&S) patrols that defeat enemy attempts to reconnoiter the obstacles and reduce their effectiveness before the enemy attack. The type formations the S2 expects the enemy to use during the entire course of the attack is also vital information. The situation template should identify when the enemy is in march, prebattle, and attack formations. The enemy formation may impact on the necessary frontage of obstacle groups and their effectiveness in achieving the intended effect on enemy maneuver.

Commander's intent. The emplacing engineer and maneuver commander must have a common understanding of the maneuver bat-

talion commander's intent. The battalion commander's intent is his vision of the battle. It normally briefly outlines what actions the unit must do to accomplish the mission. The commander's intent may include key aspects of the plan that the commander wants to emphasize to subordinates to synchronize the actions of subordinates toward a single purpose. The engineer must understand the commander's intent and how it relates to integrating obstacles. The engineer should constantly reflect on whether the obstacles he is emplacing support the commander's overall in-

Maneuver graphics and fire plan. In order to fully support the scheme of maneuver, the engineer must have and understand the maneuver graphics on the battalion's operations overlay. The maneuver graphics use symbols to depict the missions of each subunit within the battalion. Maneuver control measures such as battle positions, sectors, phase lines, passage lanes/points, and counterattack axis are vitally important to understanding the plan and integrating tactical obstacles. The maneuver graphics may include direct fire control measures that direct how and where combat forces will mass, shift, and lift fires to destroy the enemy. Direct fire control measures include EAs, trigger lines, and TRP and unit boundaries. In short, they dictate the direct fire responsibilities of each subordinate. Understanding the direct fire plan and organization of the engagement are fundamental to integrating obstacles with fires. The maneuver graphics also give the engineer an appreciation for how tactical obstacles supporting one unit must complement the adjacent units. This is particularly true of adjacent EAs or plans requiring any tactical repositioning of forces.

Execution matrix. The execution matrix summarizes the tasks to be performed by all combat units within the battalion. The matrix arranges subunit tasks by unit and phase of the operation. It allows the battalion commander to synchronize the actions of all units to achieve unity of effort. The emplacing engineer should have a copy of the execution matrix and know how to read it. Different units use different forms of matrices and ab-

breviated terms. Before conducting coordination with a maneuver commander, the emplacing engineer should review the execution matrix and ensure he understands all the subunit tasks of the company he is supporting. The execution matrix is an excellent tool for quickly verifying the maneuver company's assigned tasks as well as those of adjacent units.

Obstacle overlay. At maneuver-battalion level, the obstacle overlay depicts the location of brigade-directed belts, TF obstacle belts, and any directed obstacles within the battalion sector. Any obstacle restrictions attached to an obstacle-control measure (belt or group) that preclude the employment of certain type obstacles are annotated on the overlay. The obstacle overlay normally contains a matrix showing the obstacle group number, priority, and maneuver unit responsible to receive obstacle turnover and overwatch the obstacle with fires. Obstacle overlays are graphic obstacle-control measures that define the general location and the effect to be achieved by individual obstacles. The obstacle overlay does not normally depict individual obstacle locations unless they are directed obstacles. The location of individual obstacles within a group is determined during the siting process between the emplacing engineer and the maneuver company commander. When overlaid on the maneuver graphics and situation template, the obstacle overlay should depict the essential elements of obstacle integration—the enemy targeted by the obstacle, the location of the obstacles on the battlefield, the unit covering the obstacle, and the directed link between obstacle effects and the fire plan.

Fire support plan. The emplacing engineer should be familiar with key elements of the fire support plan. He must understand the general scheme of fires and how it supports the scheme of maneuver, commander's intent, and scheme of obstacles. Normally, the emplacing engineer does not need the entire fire support overlay depicting the location of targets. However, he should know the location of fire support targets directed by battalion to cover obstacles. The emplacing engineer should know who has the priority of fires for each phase of the battle. The emplacing engineer should know the location and type of

- Review and get updates on the tentative fire support plan.
 - Allocation of fires to the company.
 - Artillery or mortar targets.
 - Priority targets (what type) and any FPF.
 - Plan for covering obstacles and their effects with indirect fires.
 - Indirect fire control measures to synchronize direct fires, indirect fires, and obstacles.
 - Location of company FIST and platoon forward observers (FOs).
 - Plan for registering fires. Deconflict with obstacle emplacement. Registration should occur after obstacles are sited but before emplacement.
 - Review the company fire support execution matrix.
 - Coordinate means for obtaining fire support if enemy contact is made during emplacement.
- Air defense.
 - Enemy air AAs during emplacement.
 - Update on changes to air defense warning and weapons status.
 - Location of air defense systems that can cover engineers emplacing obstacles.
 - Method of obtaining early air defense warning.
 - CSS.
 - Tentative location of mine dump (if used) within the company position and routes from mine dump to obstacles.
 - Routes the company plans on using to conduct logistics package (LOGPAC) operations that must remain open.
 - Method of obtaining emergency Class III/V supplies, maintenance, and medical support from the maneuver company trains.
- Manpower assistance at the mine dump.
 - Command and control.
 - Location of commander during defensive preparation.
 - Frequency modulated (FM) net of the supported company and means of communication.
 - Unit boundaries affecting obstacle emplacement.
 - Time and place of company order, if required to attend.
 - Coordination that must occur with adjacent units.
 - Required reports on obstacle status and completion.
 - Lane marking materials discussed and understood throughout unit.
 - Time and method of obstacle turnover, to include lanes.

Siting the Minefield

Siting the minefield is wholly concerned with achieving synchronization between obstacle, its effect, and fires. It requires the complete involvement of the emplacing engineer and the maneuver commander. In short, siting is conducted to verify obstacle synchronization with fire control measures in light of the terrain. It represents the final adjustments to both obstacle location and fire control before emplacement.

In order to site obstacles, the defensive plan must be developed enough to meet certain conditions. First and foremost, the commander must have decided where he plans to mass fires and have marked the necessary fire control measures on the terrain. The location of these control measures must be clearly identifiable since they are the basis for obstacle siting. Second, the commander must have identified tentative locations for his key weapons within his position or sector based

- Review and get updates on the tentative fire support plan.
 - Allocation of fires to the company.
 - Artillery or mortar targets.
 - Priority targets (what type) and any FPF.
 - Plan for covering obstacles and their effects with indirect fires.
 - Indirect fire control measures to synchronize direct fires, indirect fires, and obstacles.
 - Location of company FIST and platoon forward observers (FOs).
 - Plan for registering fires. Deconflict with obstacle emplacement. Registration should occur after obstacles are sited but before emplacement.
 - Review the company fire support execution matrix.
 - Coordinate means for obtaining fire support if enemy contact is made during emplacement.
- Air defense.
 - Enemy air AAs during emplacement.
 - Update on changes to air defense warning and weapons status.
 - Location of air defense systems that can cover engineers emplacing obstacles.
 - Method of obtaining early air defense warning.
 - CSS.
 - Tentative location of mine dump (if used) within the company position and routes from mine dump to obstacles.
 - Routes the company plans on using to conduct logistics package (LOGPAC) operations that must remain open.
 - Method of obtaining emergency Class III/V supplies, maintenance, and medical support from the maneuver company trains.
- Manpower assistance at the mine dump.
 - Command and control.
 - Location of commander during defensive preparation.
 - Frequency modulated (FM) net of the supported company and means of communication.
 - Unit boundaries affecting obstacle emplacement.
 - Time and place of company order, if required to attend.
 - Coordination that must occur with adjacent units.
 - Required reports on obstacle status and completion.
 - Lane marking materials discussed and understood throughout unit.
 - Time and method of obstacle turnover, to include lanes.

Siting the Minefield

Siting the minefield is wholly concerned with achieving synchronization between obstacle, its effect, and fires. It requires the complete involvement of the emplacing engineer and the maneuver commander. In short, siting is conducted to verify obstacle synchronization with fire control measures in light of the terrain. It represents the final adjustments to both obstacle location and fire control before emplacement.

In order to site obstacles, the defensive plan must be developed enough to meet certain conditions. First and foremost, the commander must have decided where he plans to mass fires and have marked the necessary fire control measures on the terrain. The location of these control measures must be clearly identifiable since they are the basis for obstacle siting. Second, the commander must have identified tentative locations for his key weapons within his position or sector based

on where he wants to mass fires and weapons capability. Finally, the commander and the engineer must agree on the intent of the tactical obstacles (effect, target, and location) which is normally directed by battalion as an obstacle group on the obstacle overlay.

Figure 2-17 illustrates how the engineer and the maneuver commander work together to site a turn and a fix obstacle group, respectively. Minefield siting takes the form of a mini rehearsal and concentrates on marking the obstacle group as a whole instead of marking

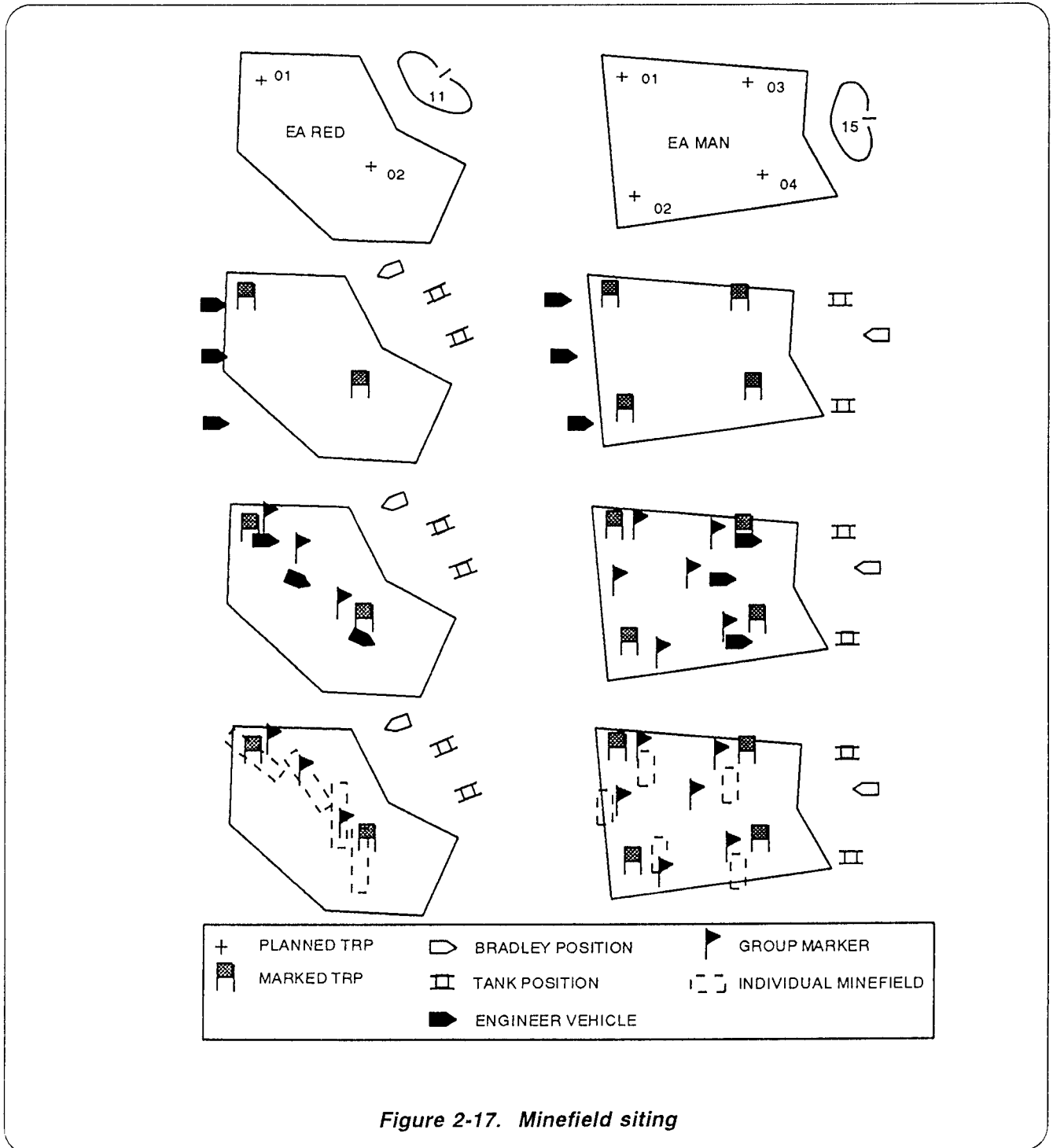

Figure 2-17. Minefield siting

each individual minefield. The engineer platoon moves into the EA to the enemy side of the obstacle group. The platoon deploys on a frontage that is similar to that expected of the enemy. The engineer platoon leader and the maneuver company commander collocate in the defensive position in the vicinity of the weapons covering the obstacle. As a technique, one or all of the tanks, Bradleys, or other crew-served weapons may occupy their position and contribute to the siting process. The engineer platoon, platoon leader, maneuver company/team commander, and other participants use a common FM net to communicate during siting.

The engineer platoon moves into the EA, simulating the enemy's attack but at slower pace. Once they are in the vicinity of the marked fire control measures, they place markers occasionally as they drive the trace of the obstacle group effect. The platoon remains oriented on key fire control measures marked in the EA to ensure obstacle location and effect are synchronized with fires. During the process, each participant verifies that he can cover the obstacle, notes the collocation of fire control measures and obstacles, and records the appropriate data on range cards if weapon positions are set. As the platoon drives the obstacle effect, siting participants must also identify dead space and any requirements to refine

the location of the obstacle group of fire control measures. The rehearsal may also identify the need for additional fire control measures.

Once general limits anti orientation of the obstacle group are marked, the process may be repeated to verify changes or the process of marking individual obstacles can begin. To mark individual obstacles, the engineer platoon uses the group markers as a guide. As shown in Figure 2-17, page 2-27, group markers may lend themselves well as the start and end points of individual minefields, but this is not always the case. As the engineer platoon refines the group limits into the site of individual obstacles, the platoon can then begin the necessary site layout based on the method of minefield emplacement.

It is important to mention that siting must **not** be the last thing done in defensive preparations. In other words, the time and resources involved in emplacing tactical obstacles requires siting to begin as soon as, if not concurrent with, establishing the defensive position. It is imperative that the minefield be sited as soon as the maneuver commander has established the EA and identified tentative positions for key weapons. It is not necessary for all weapons to be emplaced and dug in before siting. Normally, well-marked fire control measures and one known position per maneuver platoon (not dug in) is all that is required to effectively site the obstacles.

EMPLACING INDIVIDUAL MINEFIELDS AND MINES

Based on the group effect, resources allocated, and engineer plan, the platoon leader determines the method of emplacement for individual minefields—row, standard pattern, or scatterable. The procedures for emplacing a standard pattern minefield, row minefield, and scatterable minefield are contained in Chapters 3, 4, and 6, respectively.

Determining Resources Required

- ★ The engineer platoon leader must determine the number of standard individual minefields

needed to make up the group and ensure the allocation of required resources. The amount of linear minefield for a group is equal to the width of the AA multiplied by the resource factor. For example, the AA is 1,500 meters wide (Figure 2-18). In this example, the tactical obstacle effect is to turn the enemy and the resource factor is 1.2. The linear minefield requirement is 1,800 meters. One turn minefield has a front of 500 meters ($1,800/500 = 4$ minefields (round up)). The number of mines and time required per minefield depends on the emplacement method.

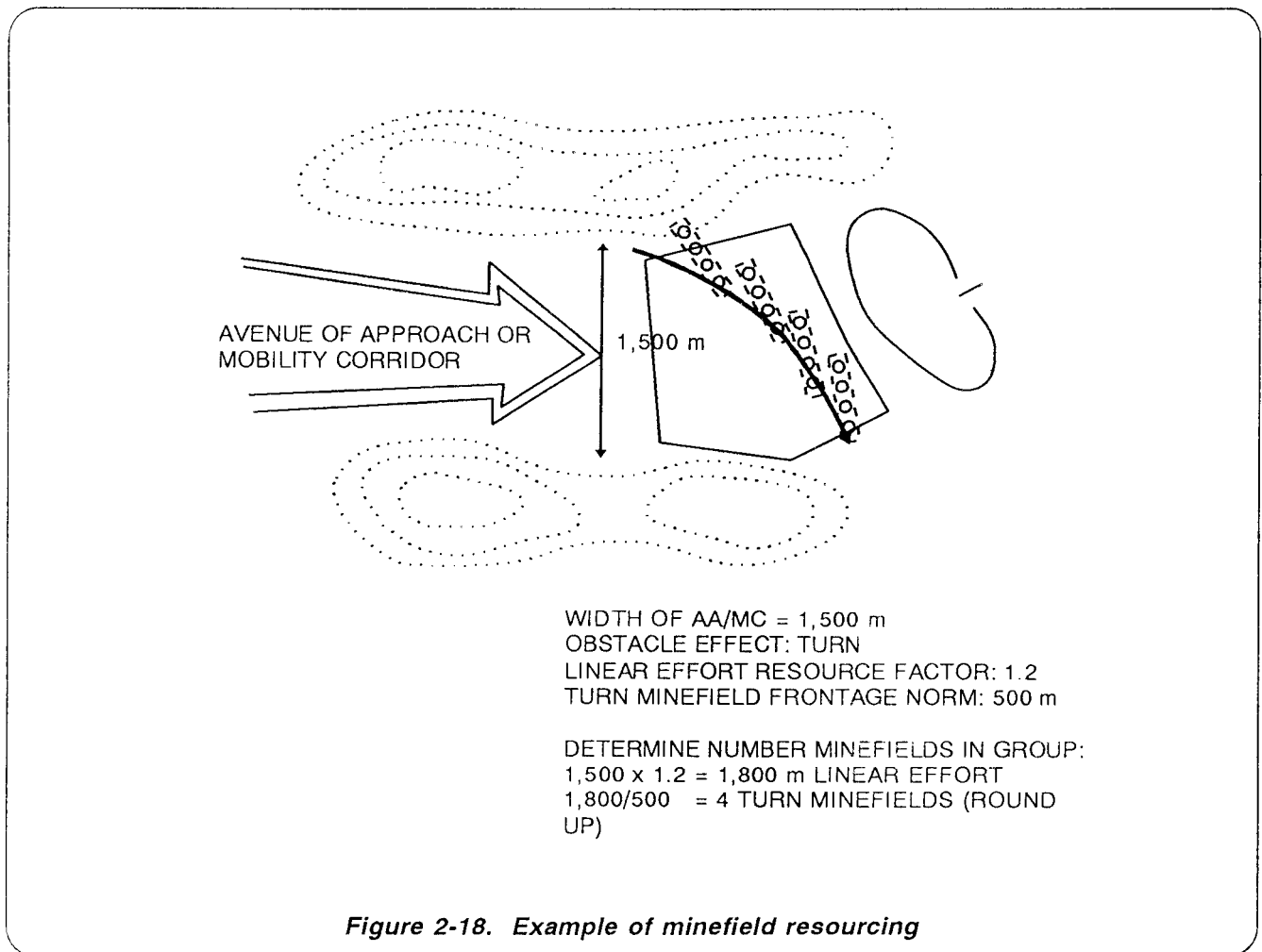

Emplacing Mines

The method used to lay and conceal each type of mine depends on the method of mine operation, the type of ground in which the mine is to be laid, and the type of ground cover available for camouflage.

Hand laying is laborious and time-consuming (standard pattern), but it is more flexible than row mine laying and allows better mine concealment. Hand laying is well-suited for protective and nonstandard point minefields. It can be used in terrain where the nature of the ground makes row mine laying methods impractical.

Whatever the mine emplacement technique, there are certain general rules that should be followed. To achieve their maximum effect, mines must be laid so they cannot be seen

and so a vehicle's wheel or track or a person's foot exerts enough pressure to detonate them.

The following rules should be applied to achieve maximum effects of mines:

- ★ **Mines with prongs or studs.** Mines with prongs or studs should be buried flush with the ground so that only the tips of the mechanism are exposed (Figure 2-19, page 2-30). Mines buried in this manner are held firmly upright. The target exerts a direct downward pressure rather than a sideways thrust. These mines are protected from damage and are difficult to see. If buried more deeply, they become unreliable because the layer of spoil may prevent the mine mechanism from operating. If mines are activated by a trip wire, they should be buried so the trip wire is at least 2 to 3 centimeters above the ground (Figure 2-20, page 2-30).

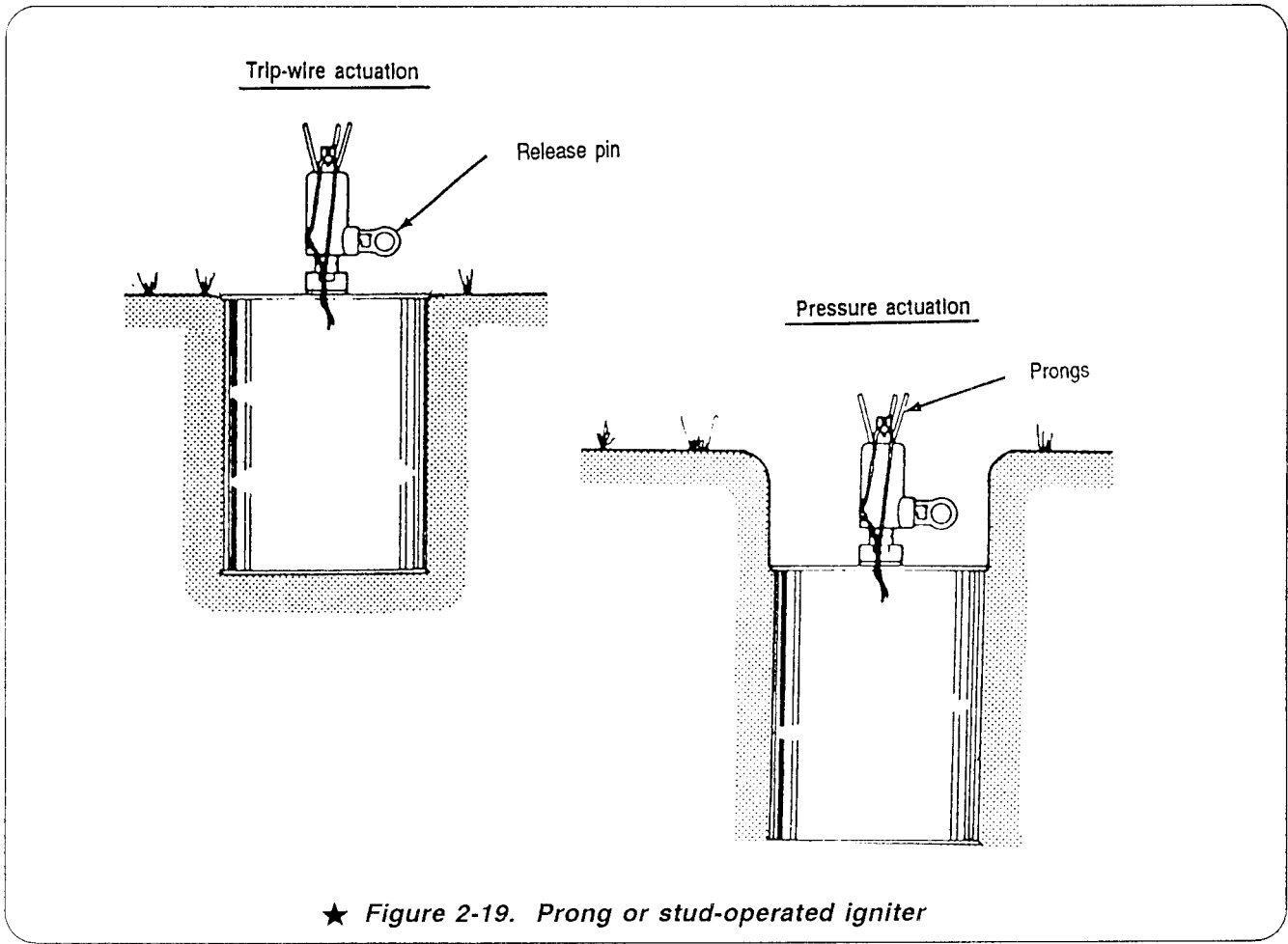

★ Figure 2-19. Prong or stud-operated igniter

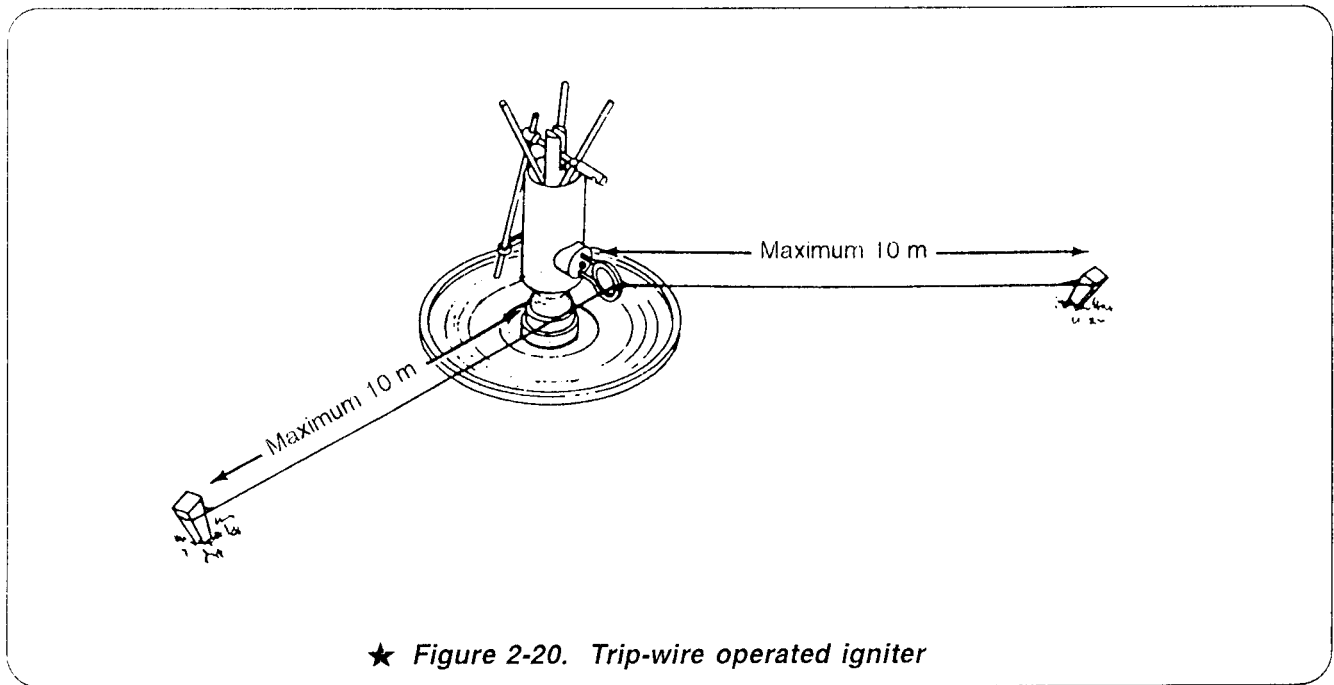

★ Figure 2-20. Trip-wire operated igniter

Bearing boards. Due to the high pressure required to activate AT mines, it may be necessary to place a board or other bearing plate under mines buried in soil with a low bearing pressure. Otherwise, mines may be forced down without detonating.

Concealment. When a hole is dug for a mine, the spoil should be placed in a sandbag to reduce evidence of laying. If a sandbag is not available, spoil should be heaped. After the

mine is laid, camouflage all traces of digging. Where the ground cover is turf or other matted, root material, spoil that cannot be hidden should be removed. In the area where the mines are placed, sod should be cut out by using an X-, I-, or U-shape. The sod is then rolled back in place to camouflage the mine. Loose earth over mines will eventually consolidate, so immediately after laying, the mine location should look like a small mound (Figure 2-2 1). Care must be taken to ensure the mound is incon-

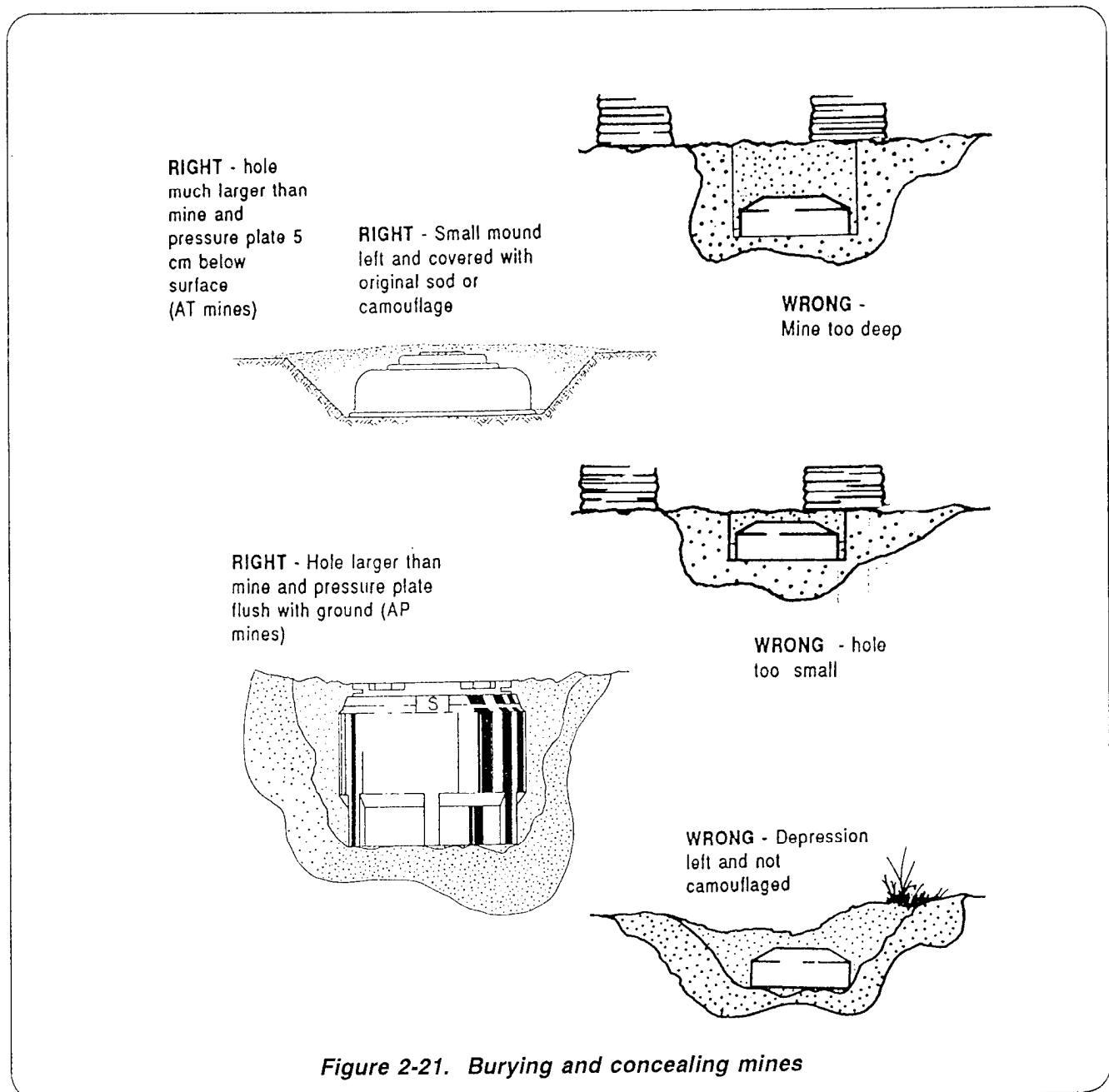

spicuous and blends with the surrounding area. A final check is made after concealing each mine so that faults can be corrected progressively. This is very important, because faults cannot be corrected later.

Mines with pressure plates. Mines with pressure plates will function when completely buried as long as the cushion of earth above them is not too thick. AT mines are normally buried with the top of the mine approximately 5 centimeters below ground level. AP mines are usually placed in a hole and only covered with camouflage material. If the hole is only slightly larger than the mine, the weight of the target may be supported by the shoulder of the hole, and the mine will fail to activate. Such bridging action can be avoided if the hole is dug much wider than the mine (Figure 2-22).

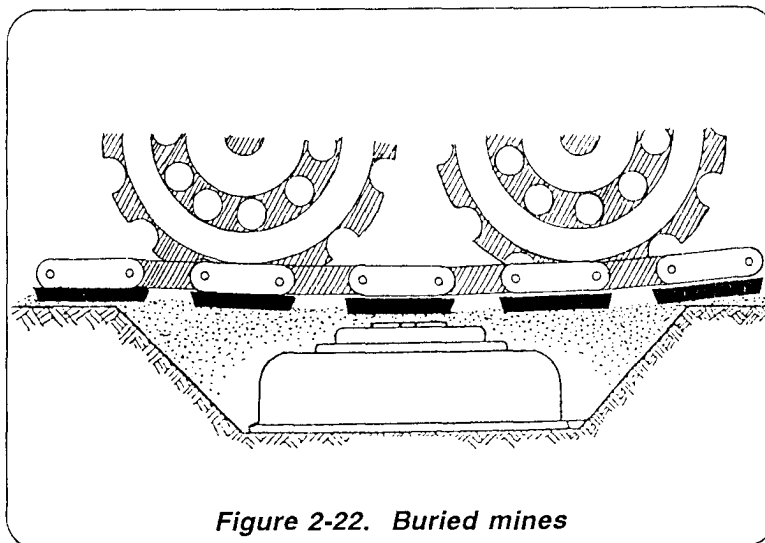

Figure 2-22. Buried mines

Mines with tilt rods. Tilt-rod fuzes normally require the body of the mine to be buried and the tilt-rod assembly to be clear of the ground (Figure 2-23). A tilt-rod fuze is preferred in areas where vegetation is sufficient to conceal the extension rod. Camouflage materials are carefully used to prevent premature detonation or interference with the normal functioning of the fuze. Extension rods are camouflaged before the mine is armed.

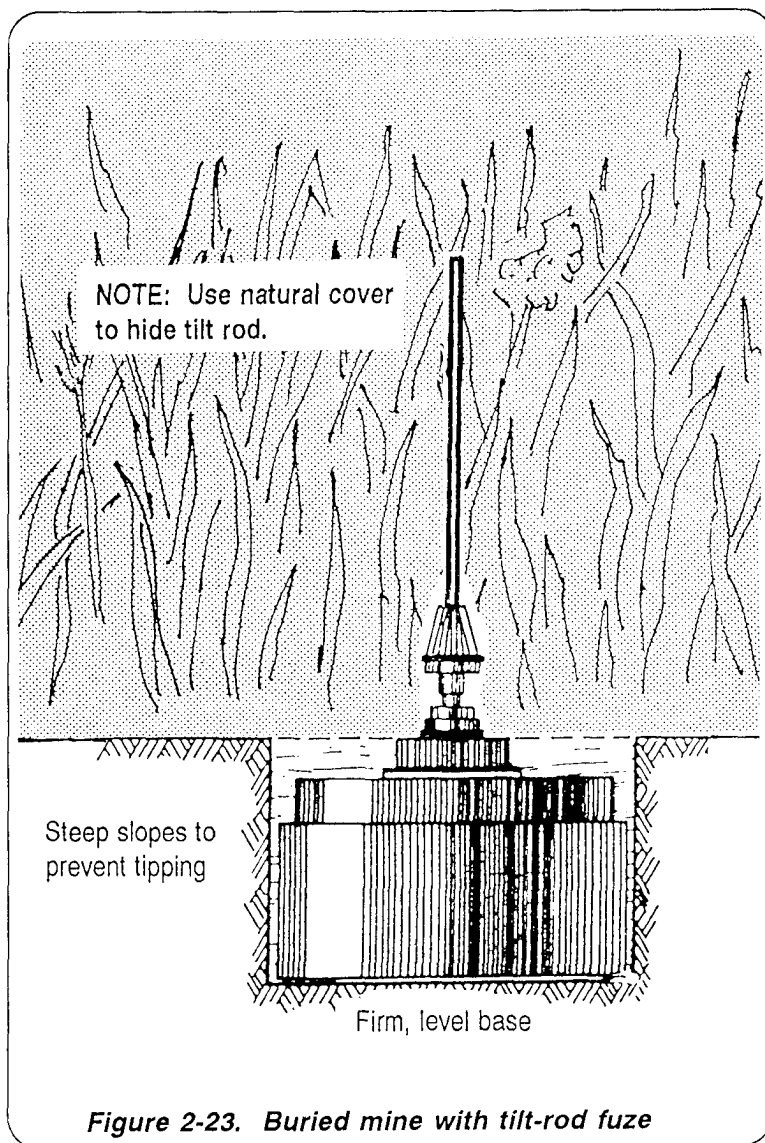

Figure 2-23. Buried mine with tilt-rod fuze

AT mines in standard pattern minefields should be buried. However, if conditions dictate, mines with a single-impulse fuze may be laid on the surface. Mines with double-impulse fuzes should always be buried because if they are laid on the surface, they are likely to be physically damaged when the first pressure is being exerted by a tracked vehicle. Also, buried mines have some resistance to countermeasures while surface-laid mines have none. Consideration must also be given to sympathetic detonation of AT mines, whether buried or surface-laid (Table 2-1).

Table 2-1. Sympathetic detonation chart

	M16	M15	M19
Surface-laid	--	14 ft/4.2 m	25 ft/7.6 m
Buried flush	5 ft/1.5 m	8 ft/2.4 m	18 ft/5.5 m
Buried 2 in	--	5 ft/1.5 m	15 ft/4.8 m

Unless mines contain integral AHDs, the extra time to lay mines with AHDs may be unacceptable. If the enemy is known to have a limited breaching capability, time may be wasted on laying mines with AHDs.

In very rocky ground, the difficulty of burying mines and the necessity for surface laying will have a bearing on suitable mines. For example, small, blast-type AP mines are hard to detect and easy to camouflage. They are much easier to camouflage than larger, fragmentation mines. The AT mine used will make little difference because the mine size will always make camouflage very difficult.

Using maneuver assistance to emplace minefields. During large mine-laying operations, engineers seldom have sufficient manpower to carry out all minefield tasks. Other combat arms units must often provide work parties. Engineers must be capable of organizing, controlling, and supervising combined arms work parties. They must also instruct them in new equipment and techniques. Work-

ing parties may be integrated with engineers or given certain tasks which are within their capabilities.

When laying a standard pattern minefield, consider supplementing work parties with other combat arms soldiers to comprise the following:

- Class IV/V (mines) supply point or mine dump party. Used to uncrate, prepare, and remove empty boxes and residue.
- Laying party. Used to position mines within strips and dig holes.
- Marking party. Used to construct the perimeter fence and emplace mine signs.

The most time-consuming tasks when laying a row minefield are unpacking, preparing, fuzing, and loading mines. This is an ideal task for other combat arms soldiers and using them allows for more efficient mine-laying operations.

MINEFIELD SUPPLY OPERATIONS

At the maneuver-battalion level, sustaining mining operations is an extremely difficult task. Centralized throughput operations by corps or division stop at the battalion level. Mass quantities of mines are centrally received, broken down into useable packages, and then distributed throughout the sector based on the obstacle plan. At some point in the distribution plan, the maneuver battalion turns over control of the mines to engineers who then emplace them in tactical minefields. Mine warfare logistics at the battalion level can be com-

plex, require prudent use of scarce haul and material handling equipment, and demand positive command and control.

This section describes some of the underlying principles in mine supply operations. It concentrates on the flow of Class IV/V (mines) through the battalion sector. The flow of obstacle materials within the maneuver battalion sector is a maneuver unit responsibility. However, it is effectively a shared responsibility between the engineer and the maneuver unit.

Key Mine Resupply Nodes

There are two critical mine resupply nodes within the battalion sector, each with a different function in the mine resupply process. They are the *Class IV/V (mines) supply point* and the *mine dump*. As discussed later, a mine dump is not always used and depends on the type of mine resupply technique used. The relative location of the Class IV/V (mines) supply point and mine dump are shown in Figure 2-24.

Class IV/V (mines) supply point. The Class IV/V (mines) supply point is the central receiving point of mines in the battalion sector. It is the point at which the maneuver battalion receives and transfers control of mines pushed forward by either corps and/or division throughput haul assets. The supply point is established and operated by the maneuver battalion and is centrally located to support all planned obstacle groups within the battalion sector. Where the tactical obstacle plan allows, the supply point should be located near the battalion combat trains to better facilitate command and control and the availability of equipment assets.

The focal point of the Class IV/V (mines) supply point operation is receiving, task-organizing, and uncrating the bulk of mines as they arrive on corps or division trucks. This implies that the supply point must have a dedicated Supply Officer (US Army) (S4) representative to track the flow of mines in and out of the supply point. The supply point should have dedicated materials handling equipment (MHE) to off-load the bulk quantities of mines and task-organize them into minefield packages. Mines will normally arrive at the supply point with like types on a single truck. Since minefields seldom use all one type mine, mines are task-organized into type minefield packages. This requires a dedicated engineer representative to ensure proper task organization of mines.

The most labor-intensive task at the Class IV/V (mines) supply point is the uncrating of mines. This requires dedicated manpower equipped with the tools needed to break shipping bands and uncrate the mines from their containers. Another important aspect of uncrating mines is tracking fuzes and booster charges. As the mines are uncrated, fuzes and booster charges are separated. However, the same number and

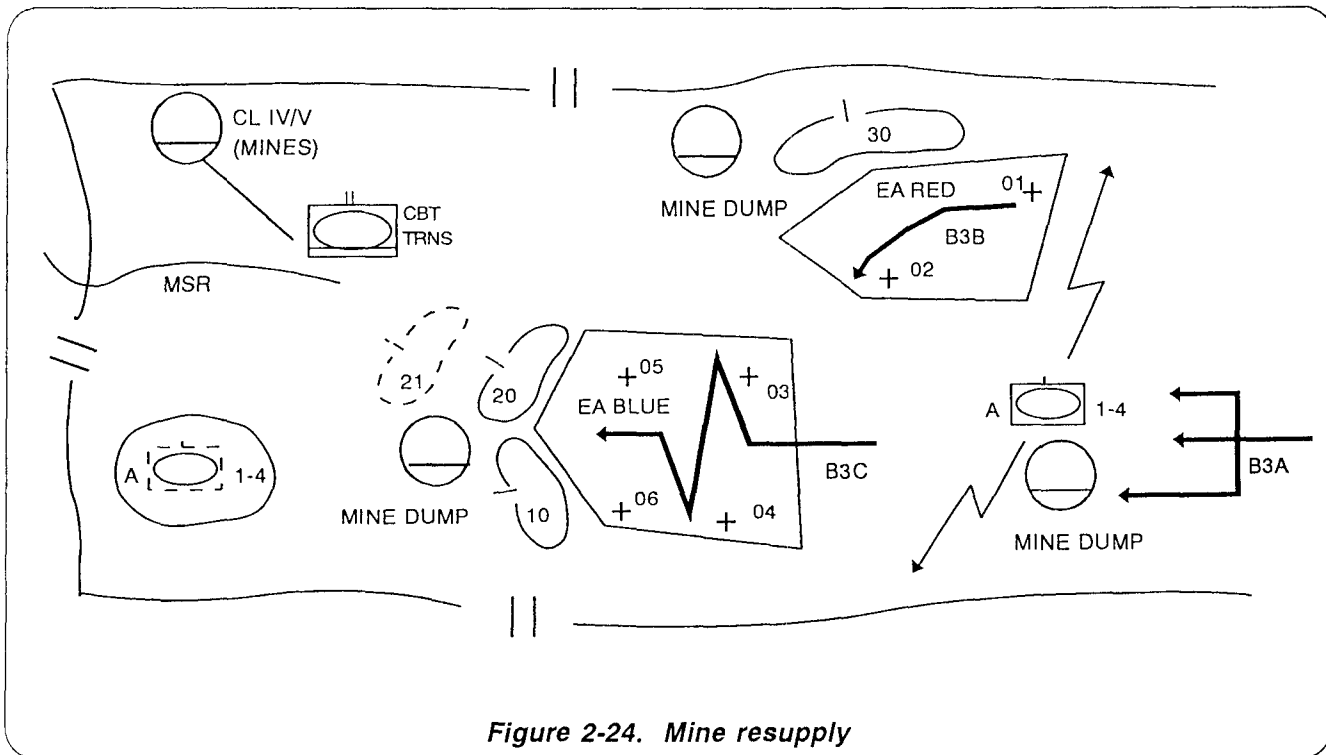

Figure 2-24. Mine resupply

type fuzes and boosters must be task-organized with minefield packages. This requires strict supervision; mistakes quickly lead to confusion and disastrous loss of emplacement time.

Because of the assets involved in the Class IV/V (mines) supply point, a battalion is normally capable of operating only one supply point at any given time. If the battalion sector is extremely wide or deep, several supply points may be planned, but only one can be operated at a time based on the commander's priorities for obstacle emplacement.

Mine dump. The second critical mine resupply node in the battalion sector is the mine dump. The mine dump is the most forward mine resupply node. It is the point at which mines are task-organized into mine strip packages, inspected, prepared, and loaded onto the emplacing vehicle. It is not a permanent supply point. A mine dump is not always used and depends on the method of minefield resupply. These techniques are discussed in more detail below. When used, one mine dump supports a single obstacle group. It is activated or deactivated upon initiation and completion of emplacing the obstacle group. Mine dump operations are primarily an engineer company or platoon responsibility. However, it is a good technique to augment mine dump operation with personnel from the maneuver company overmatching the obstacle group being emplaced. The mine dump may be located either in the vicinity of the maneuver company position or nearer to the obstacle group.

- ★ There are three critical tasks that must be accomplished at the mine dump. First, as minefield packages are transported to the mine dump, they are further task-organized into strip packages—complete with the right number, type, and mix of fuzes and boosters. For example, if the platoon is emplacing a standard disrupt row minefield, mines are task-organized into three strips. As the engineer platoon moves to the mine dump to resupply, each emplacing vehicle falls in on its designate strip to up-load. Second, the mines are prepared for emplacement. Pressure mines may be fuzed and transported from the mine dump. Fuzed mines will not be stacked more than two mines high/deep in the transport vehicle. Prepara-

tion includes loosening and greasing fuze and booster wells and checking to ensure proper functioning. Finally, the mines are transloaded onto the emplacing vehicles or delivery system.

Transportation of mines from the Class IV/V (mines) supply point to the mine dump is a supported maneuver battalion responsibility. However, it is normally shared between the engineer company and the maneuver battalion, since neither one has the haul capability to simultaneously service all active mine dumps.

Mine Resupply Rules

There are several principal rules that govern mine resupply.

- Mines should be uncrated at the Class IV/V (mines) supply point to preserve transportation assets going forward.
- Mines are task-organized into type minefield packages at the Class IV/V (mines) supply point.
- Mines are transported from the Class IV/V (mines) supply point uncrated full stock. This may require some modification to transportation assets.
- When a mine dump is used, transportation from the Class IV/V (mines) supply point to the mine dump is a shared engineer and supported maneuver unit responsibility.
- Mine fuzes and boosters are separated during uncrating at the Class IV/V (mines) supply point and task organized with each minefield package.
- Mines are inspected and prepared at the last supply node (Class IV/V (mines) supply point or mine dump) before loading onto the emplacing vehicle or dispensing system.

The following are considerations for selecting a location for the Class IV/V (mines) supply point and/or mine dump:

Carrying capacity. The location of key supply nodes depends in part on the type, amount, and availability of haul assets. The carrying

capacity plays a large role. In short, the more mines a vehicle can carry, the more turnaround time you can afford. The supply point can be from the obstacle group without affecting emplacement times. Table 2-2 provides the mine haul capacity for various types of vehicles.

Traffic circuit. Vehicles must be able to enter, load, unload, and exit without interfering with the loading and unloading of other vehicles.

Camouflage and cover. Protection from observation and thermal imaging is desired. Protec-

★ Table 2-2. Class IV and V haul capacity

Vehicle	Concertina Wire		M15 AT Mine		M19 AT Mine		M21 AT Mine		M16 AP Mine		M14 AP Mine		MOPMS Mine		Flipper Mine		Volcano Mine		MICLIC Reload		
HMMWV, M998 2,500 lb 215 cu ft	2		51		34		27		55		56		15		11		1			*1	
2½-Ton Truck 5,000 lb 443 cu ft	4		102		69		55		111		113		30		23		2			1	
5-Ton Truck 10,000 lb 488 cu ft	7		204		138		109		222		227		61		46		5			3	
5-Ton Dump Truck 10,000 lb ***135/291 cu ft	2/4		112/204		64/138		32/70		168/222		71/153		23/51		39/46		3/5			2/3	
20-Ton Dump Truck 40,000 lb 754 cu ft	11		628		443		179		888		443		132		184		20			11	
HEMTT Truck 20,000 lb 540 cu ft	8		408		277		128		444		317		94		92		10			7	
12-Ton S&P 24,000 lb 875 cu ft	13		489		333		208		533		514		148		110		12			9	
40-Ton Lowboy 80,000 lb 1,760 cu ft	27		1,466		1,035		419		1,777		1,035		308		368		43			27	
M548 12,000 lb 529 cu ft	8		244		166		125		266		272		74		55		6			4	
# Mines/ W/lb		40/ 1,180	64	1/ 49	1.2	2/ 72	1.6	4/ 91	4.1	4/ 45	8	90/ 44	1.9	21/ 162	5.7	40/ 217	3.4	240/ 1,850	37.6	** 2,656	64.8

For concertina = bundles; 1 bundle = 40 rolls * Overloads vehicle **Line charge + rocket *** Without/with sideboards

tion from artillery and air attack should be considered. Residue must be removed.

Defense. The site must be organized for defense against enemy patrols and saboteurs.

Time. Platoon leaders must take into consideration the time it takes to uncrate, inspect, grease, and fuze mines.

Operators. Soldiers must be specifically allocated to operate mine dumps. They will most likely remain there until the task is complete. The supply node may have to be collocated with or be near a source of manpower. Table 2-3 provides general guidance on how much manpower is required to sustain mine resupply operations.

Mine Resupply Methods

There are three methods for minefield resupply — *supply point*, *service station*, and *tailgate*. In each method, corps or division transport delivers Class IV/V forward to a designated Class IV/V point in each TF sector. The primary differences in each method are how mines are delivered from the Class IV/V point to the minefield group and whether or not a mine dump is activated in the resupply chain.

Supply point. The supply point technique revolves around the emplacing engineer platoon returning to the Class IV/V (mines) supply point each time it must reload laying vehicles or dispensers. Figure 2-25, page 2-38, illustrates the supply point method of resupply. The supply point technique does not activate a separate mine dump. In effect, it

moves the normal tasks associated with a mine dump to the supply point. Mines are prepared and inspected at the supply point as they are loaded onto the emplacing vehicle or dispenser.

Several considerations may drive the use of supply point resupply. First, if there are no additional haul assets to transport mines forward from the Class IV/V (mines) supply point, the supply point method may be the only viable technique. Second, the obstacle group may be close enough to the supply point that any other method is less efficient.

There are several advantages and disadvantages to a supply point.

- Advantages.
 - Minimizes unloading and loading of mines.
 - Requires minimal augmentation of haul assets.
 - Allows manpower and equipment to be massed at a single supply point.
 - Streamlines command and control of mines, particularly fuzes and booster charges.
- Disadvantages.
 - Requires more movement of the platoon, which may take away from emplacement time.
 - Requires the platoon to move in and out of the mined area.

Table 2-3. Mine dump planning factors

Number of Personnel	Quantity of Mines
2-man team (2 minutes per mine)	25 mines/hour
Squad (8 soldiers)	100 mines/hour
Platoon	300 mines/hour; 3,600 mines/day
Company	10,800 mines/day
NOTE: Soldiers work 50 minutes per hour, 12 hours a day.	

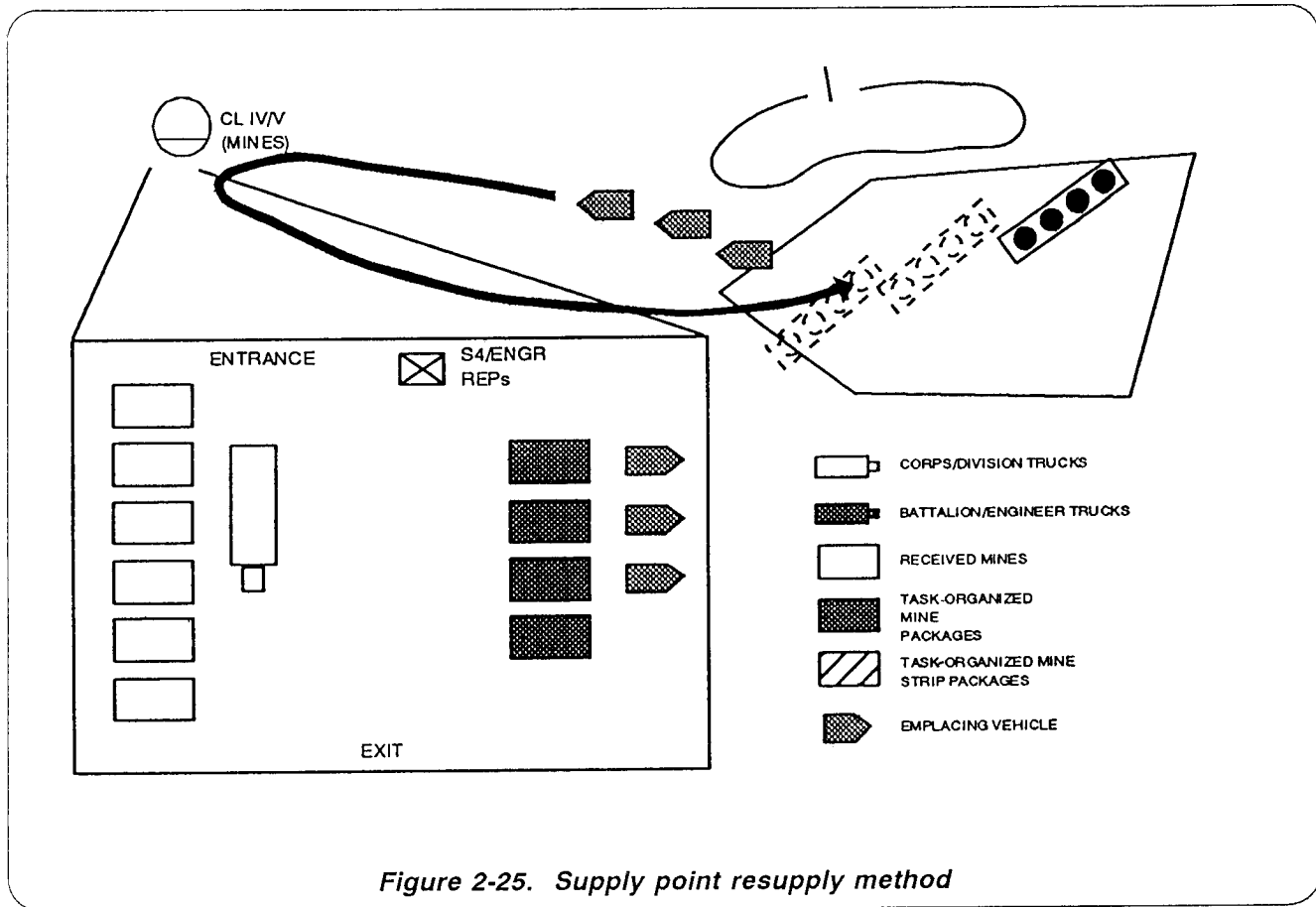

Figure 2-25. Supply point resupply method

- May disrupt the emplacement of individual minefields when emplacing vehicles cannot carry enough mines to start and complete the minefield. This causes emplacing vehicles to stop work, reload, and pick up where they left off.
- Requires a larger Class IV/V (mines) supply point capable of receiving mass quantities of mines and loading platoons simultaneously.
- Does not afford an opportunity to task-organize mines into strip packages.

Service station. The service station technique centers on the activation of a mine dump forward of the Class IV/V (mines) supply point. In the supply point method, mines are transported to a mine dump using a combination of battalion and engineer haul assets that are normally under the control of the emplacing engineer platoon sergeant (Figure 2-26). At the mine dump, mines are stockpiled and

prepared by a mine dump party. Mines are further task-organized into strip packages to facilitate easy and correct loading of mines onto emplacing vehicles or dispensers. Fuzes and boosters are task-organized in the appropriate numbers, type, and mix for each strip. The emplacing platoon moves to the mine dump to resupply emplacing vehicles or dispensers. Once the obstacle group is emplaced, the mine dump is deactivated or moved to support another obstacle group.

There are several considerations for using the service station resupply method. First of all, it is used when the minefield group is located too far from the Class IV/V (mines) supply point to allow efficient turnaround. Since this method provides for prestocking mines forward, it is used when available haul assets have a relatively small capacity. This allows for frequent short duration resupply trips and stocking mines to keep pace with emplacement. It also streamlines emplacement since there is

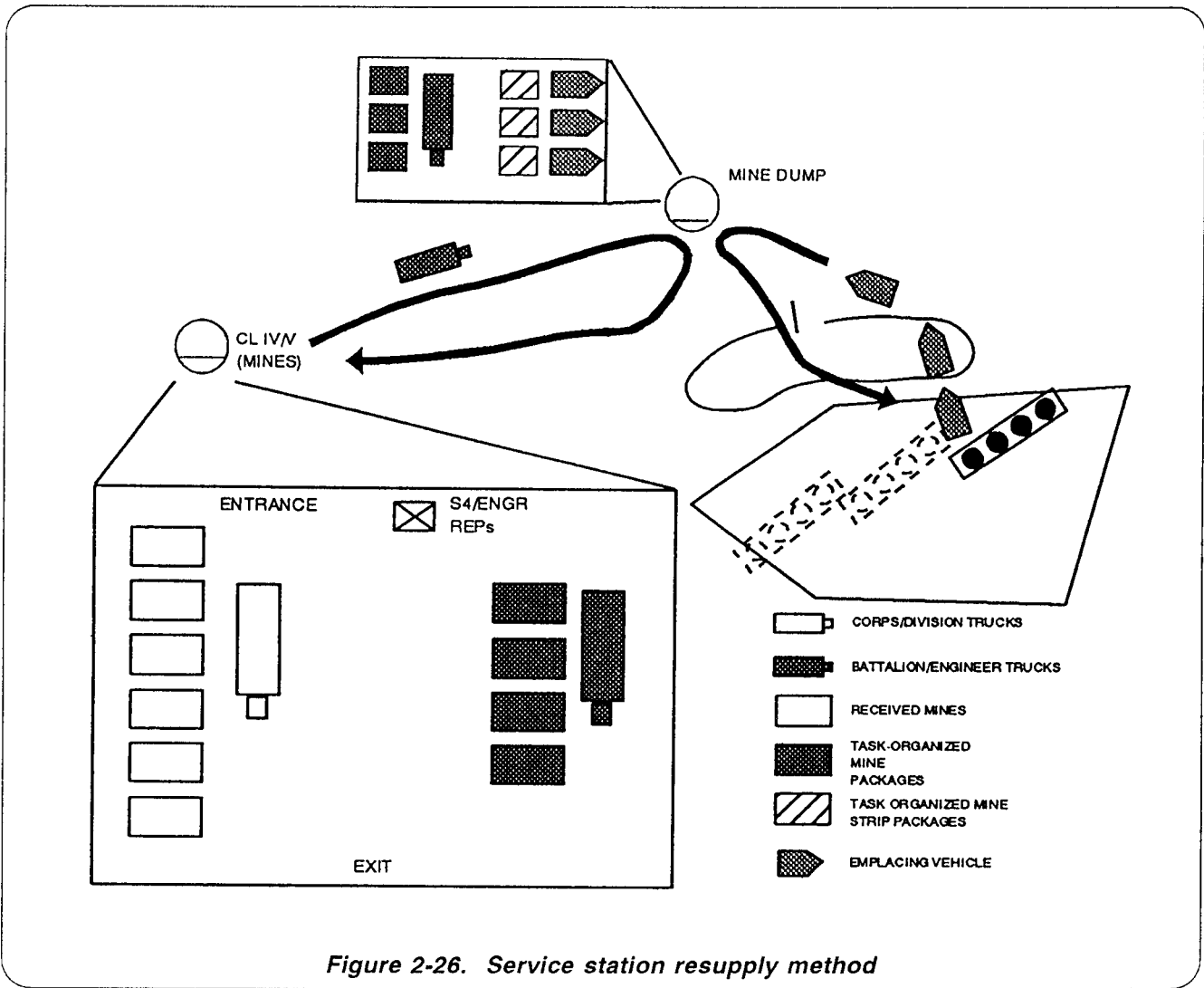

Figure 2-26. Service station resupply method

an opportunity to task-organize the mines into strip packages based on the emplacement method and type minefield. Finally, while it still requires the emplacing platoon to stop laying and resupply, it minimizes the distance and time the platoon must travel to reload. This further allows for a small party to be left at the minefield to assist in picking up where emplacement stopped.

There are several advantages and disadvantages to the service station resupply method.

• Advantages.

- Allows for prestockage of mines to keep pace with emplacement.

- Minimizes the distance and time the emplacing platoon must travel to reload.
- Allows for task-organizing mines into strip packages.
- May provide additional manpower and security if located near supported maneuver company.

• Disadvantages.

- Requires additional loading and unloading of mines and handling of fuzes and booster charges.
- May require augmentation with haul assets.

- Disrupts emplacement by requiring the emplacing platoon to stop emplacement, move to the mine dump, reload, and return to the minefield.

Tailgate. The tailgate resupply method transports mines directly from the Class IV/V (mines) supply point to the emplacing platoon on the minefield site (Figure 2-27). This technique does not use a mine dump. Mines are transported to the emplacing platoon using both maneuver battalion and engineer haul assets. At the minefield, mines are transloaded to emplacing vehicles or dispensers. As the mines are transloaded, they are inspected, prepared, and loaded for emplacement. These actions are performed by emplacing engineers rather than a separate party. If emplacing vehicles are not ready for resupply, the mines remain up-loaded at the mine site until they are called for.

Two overriding considerations drive the decision to use the tailgate resupply method. First, if minefield emplacement is being conducted during limited visibility, the tailgate method is the primary resupply method. It minimizes disruption of emplacement and chance of fratricide as engineers move back into a mined area after reloading. Second, the tailgate is the primary method used when establishing a hasty defense or when the situation is unclear and an attack can happen at anytime. Since mines remain loaded until transferred to the emplacing vehicle, the tailgate method enables engineers to quickly break contact without risking a loss of mines to the enemy. The tailgate resupply method is the norm for light forces.

There are several advantages and disadvantages to the tailgate resupply method.

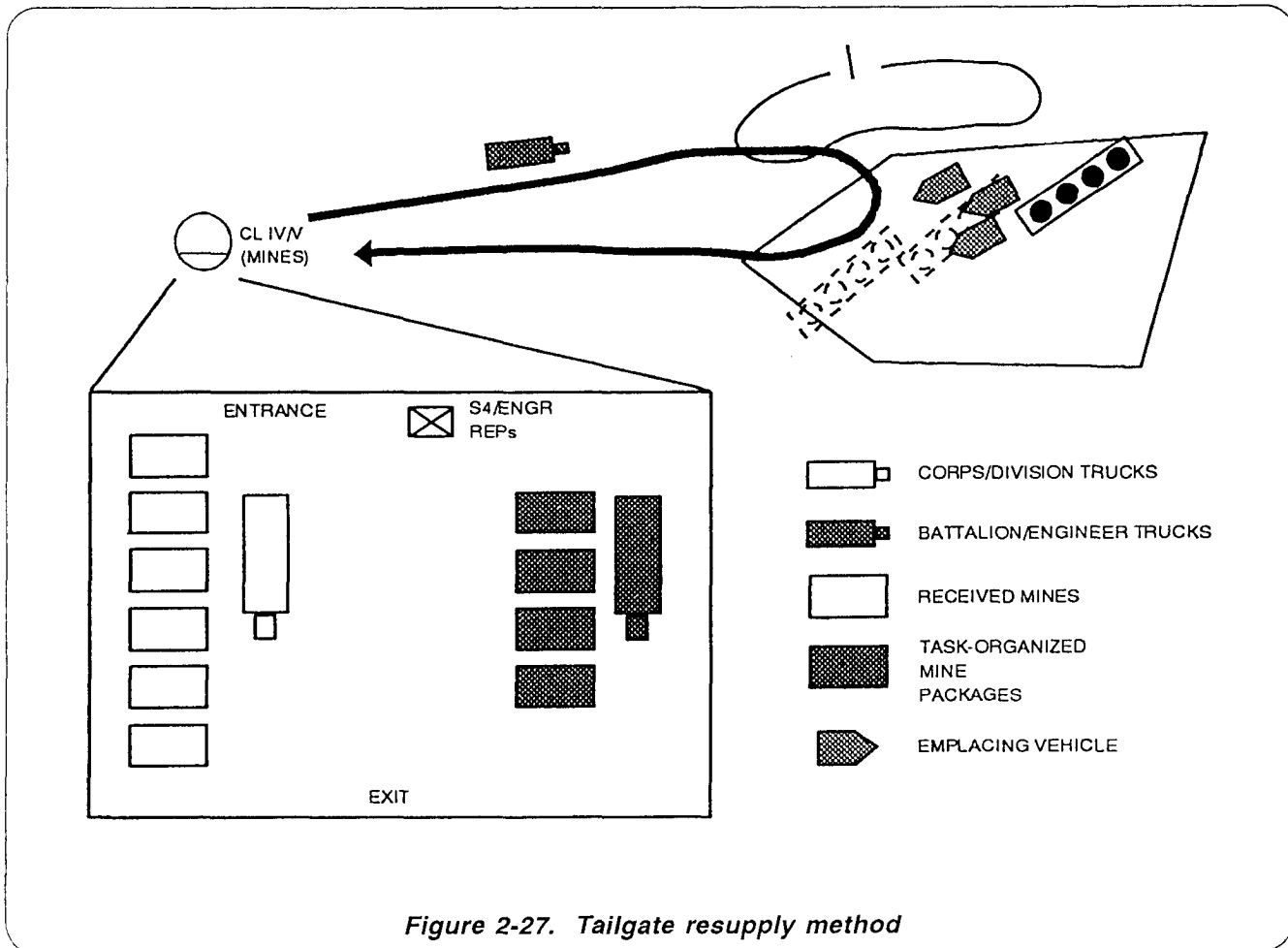

Figure 2-27. Tailgate resupply method

- Advantages.
 - Minimizes loading and unloading of mines and handling of fuzes and booster charges.
 - Allows engineers to rapidly break contact, in the event of enemy attack, without losing mines to the enemy.
 - Minimizes the movement of platoons in and out of the minefield (suitable for limited visibility).
 - Does not require a dedicated mine dump party.
- Disadvantages.
 - Requires augmentation by high-capacity transportation assets capable of offsetting the loss in turnaround time if the vehicle has to wait on-station at the minefield site.
 - May result in inefficient use of haul assets.
 - Complicates command and control in linking up mine transport assets with emplacing engineers as the engineers continue emplacement.
 - Task-organizing strip packages, mine inspections, and preparation are conducted concurrent with loading.

MINEFIELD MARKING

Marking Criteria

Minefields need to be marked to prevent fratricide. Marking minefields ensures that friendly soldiers do not accidentally enter a minefield. Marking minefields is a requirement under STANAGs and Geneva Convention agreements. When emplacing minefields behind the forward line of own troops (FLOT) (in the main battle or rear areas), mark the minefields on all four sides. This includes air-delivered Volcano minefields that are sited and emplaced before the enemy attack.

Remote antiarmor mine (RAAM)/area denial artillery munition (ADAM) and Gator minefields are the exceptions to the rule. To preserve the system's flexibility and the relative inaccuracy of emplacement, these minefields are not normally marked before emplacement unless the tactical situation permits. Marking the area where mines are to be emplaced by artillery or fixed-wing aircraft is not recommended. Mines could likely be emplaced outside the marked area.

Forward of the FLOT, minefields are not generally marked before emplacement. However, commanders must make every attempt to mark these minefields as soon as the tactical situation allows. The commander may decide to remove minefield marking if the minefield

is abandoned and control of the area is to be turned over to the enemy. For scatterable minefields, the commander may choose to remove markings once the self-destruct time of the mines has expired; but the location of the minefield must still be recorded and forwarded to higher and adjacent units in the event some mines did not self-destruct.

Perimeter Marking

To mark a minefield, construct a perimeter fence. Start emplacing the perimeter fence before emplacing mines, preferably during site layout if the tactical situation permits. For conventional minefields, ensure the perimeter fence will be at least 15 meters outside the nearest mine or cluster. For scatterable minefields, the area inside the perimeter fence must include the safety zone particular to the method of emplacement (see Chapter 6 for more details).

Place warning signs for areas containing emplaced mines. Space the warning signs 10 to 50 meters apart depending on the terrain. If using pickets and barbwire to mark the minefield, ensure the wire is waist-high. If using concertina wire, use a one-roll height. Place additional strands of barbwire or rolls of concertina at the discretion of the commander (Figure 2-28, page 2-42).

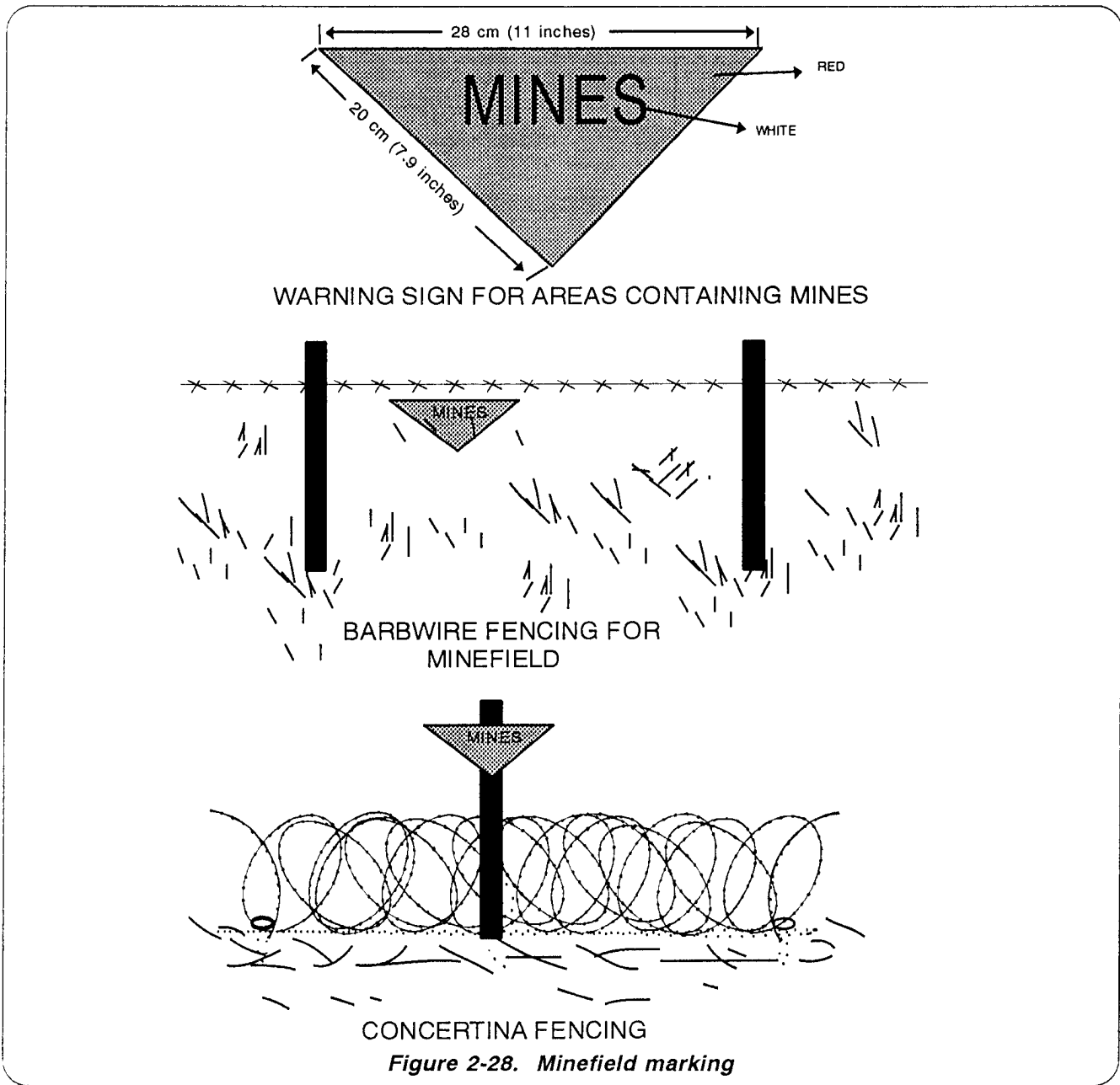

Figure 2-28. Minefield marking

Marking Techniques

The commander may decide to mark individual minefields in an obstacle group or to mark the group as a whole (Figure 2-29). Depending on the size and location of the minefields, either technique may have the advantage of using fewer resources or labor. Nor really, marking individual minefields in a fix obstacle group requires less resources than marking the group

in its entirety. The opposite is usually true for disrupt, turn, and block obstacle groups. The decision to mark minefields or obstacle groups should not, however, be based solely on logistical considerations. The commander must consider the amount of tactical or sustainment movement required in and around the obstacle groups as well as his unit's capability to command and control forces. The following advantages and disadvantages to

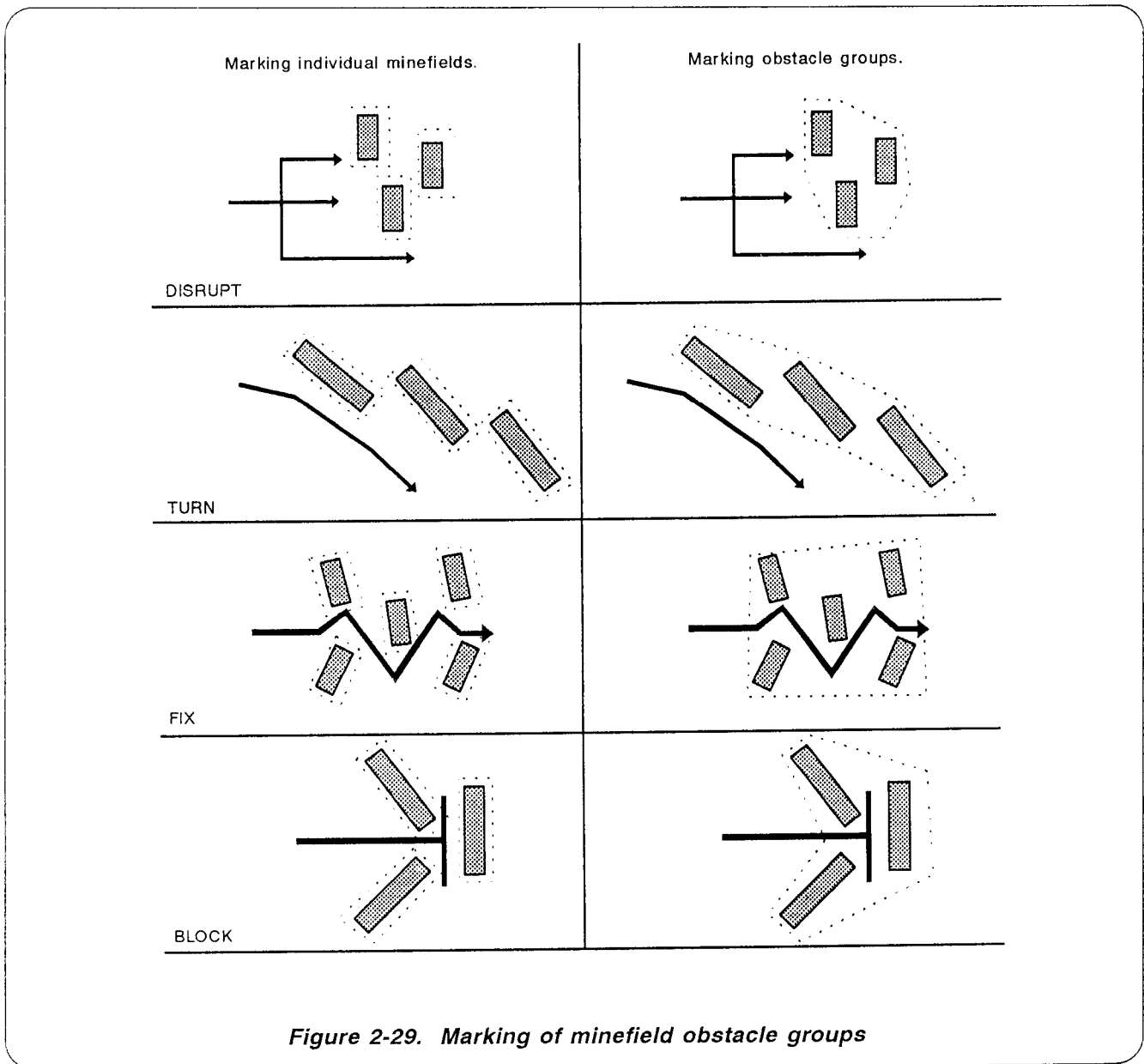

Figure 2-29. Marking of minefield obstacle groups

marking individual minefields versus marking the obstacle group are provided to help commanders make the best decision.

Marking individual minefields.

- Advantages.
 - Returning units forward of the minefields have more routes (tactical lanes or bypasses) through the obstacle group.

- Tactical lanes need only pass through individual minefields.
- Mine recovery is easier when individual minefields are marked.
- Disadvantages.
 - Obstacle may not provide the desired effect.
 - Enemy units can more easily bypass individually marked minefields in a fix or block obstacle group.

Marking entire obstacle group.

- Advantages.
 - Obstacle is more likely to provide desired effect.
 - The enemy cannot easily discern individual minefields and decide when to employ breach assets in a fix or block

- Disadvantages.
 - Friendly patrols cannot clearly see if the minefield is tampered with unless they are within the perimeter fence.
 - Tactical lanes need to pass through the entire obstacle group. Friendly units passing through the lanes will be slowed considerably.

MINEFIELD TURNOVER

Minefield turnover from the emplacing engineer unit to the overmatching unit is an inherent part of any minefield emplacement. Turnover is conducted whether or not there are lanes/gaps to be closed. Minefield turnover takes on the same significance as transfer of a minefield from one commander to another. Normally, minefield turnover is conducted between the engineer platoon/squad which emplaced the minefield and the maneuver company/team who has the responsibility for covering the obstacle with fires. Minefield turnover is a must; time and location for turnover is established during initial siting coordination.

Listed below are several items the engineer platoon /squad leader must address with the overwatching company/team.

Intelligence.

- Provide an update on any enemy activity forward of the minefield.
- Discuss expected enemy reconnaissance efforts.

Maneuver.

- Discuss obstacle protection against enemy dismounted patrols. Recommend that the maneuver unit conduct security/patrols to protect the minefield during limited visibility.
- Discuss fire control measures.

Mobility/survivability.

- Discuss the obstacle's intended effect on enemy maneuver.
- Discuss minefield front and depth and walk/ride the minefield trace. Provide grid coordinates of the minefield trace.
- Discuss minefield composition.
- Discuss friendly minefield marking.
- Discuss lane or gap closure, if applicable. Confirm the signal or activity which initiates lane closure.
- Train units on how to close lanes. This may mean training the unit on emplacing conventional mines or using the MOPMS.

Fire support.

- Update the company FIST on grid coordinates for the minefield trace.
- Discuss indirect fires covering the minefield.

CSS. Provide mines/material required to close lanes/gaps. Ensure all necessary material is available and prepared.

Command and control.

- Sign over the minefield report.
- Report completion of turnover to higher engineer headquarters.
- Forward written minefield report.

MINEFIELD INSPECTION AND MAINTENANCE

Mines left in the ground for a long time may deteriorate and malfunction for one or more of the following reasons:

- Moisture may have entered the igniter or body of the mine and either neutralized the explosive or corroded the metal parts. Such actions may be aggravated by local factors (soil acidity or wide temperature swings).
- Frost or heat may have subjected the mine to mechanical strain and caused distortion.
- Insects or vegetation may have caused obstructions.
- Animals may have turned mines over or detonated them.

Technical inspections should only be made by experienced engineers or explosive ordnance disposal (EOD) personnel. When a minefield deteriorates below the operating level, additional mine strips/rows are added to restore its effectiveness. They are sited to the front or rear of the existing minefield to increase its depth. New mine strips/rows are treated as a separate, additional minefield.

Technical inspections of minefields are normally done at three-month intervals. They are done more frequently during extreme weather conditions.