

# CHAPTER 9

## MINEFIELD REDUCTION

*Reduction is the physical creation of a lane through a minefield. It is a fundamental of breaching operations as discussed in Chapter 8 and FM 90-13-1. A number of tasks directly support or are included in minefield reduction. Engineers are involved the most in this part of breaching. Minefield reduction tasks include: detecting, reporting, reducing, proofing, and marking.*

*These tasks also apply to clearing operations. The minefield is detected during reconnaissance for the breaching operation, and detection is also inherent in the clearing operation. While reduction in the breaching operation entails creating a lane through the minefield using specialized equipment, it is taken one step further in the clearing operation where all mines are eliminated from an area.*

### DETECTING

Detection is the actual confirmation and location of mines. It may be accomplished through reconnaissance, or it may be unintentional (such as a vehicle running into a mine). Mine detection is used in conjunction with intelligence-gathering operations, minefield bypass reconnaissance, and breaching and clearing operations. The four detection methods are: visual, physical (probing), electronic, and mechanical.

#### Visual

Visual detection is part of all combat operations. The following techniques are recommended for visual detection of mines and booby traps. Personnel visually inspect the terrain for—

- Trip wires.
- Signs of road repair (such as new fill or paving, road patches, ditching, or culvert work).
- Signs placed on trees, posts, or stakes. Threat forces mark their minefields to protect their own forces.
- Wires leading away from the side of the road. They may be command firing wires that are partially buried.
- Odd features in the ground or patterns not present in nature. Plant growth wilts or changes color; rain may wash away some of the cover, or the cover may sink or crack around the edge; the material covering the mines may look like mounds of dirt.
- Civilians. They may know where mines or booby traps are located in the residential area. Civilians staying away from certain places or out of certain buildings are good indications of mines or booby traps. Question civilians to find exact locations.
- Pieces of wood or other debris on a road. They may indicate where the enemy has emplaced pressure or pressure-release firing devices.

These devices may be on the surface or partially buried.

- Patterns of objects which might be used as a sighting line. The enemy can use mines fired by command. Road shoulders and areas close to them should be searched.

### Physical (Probing)

Probing is very time-consuming and is used primarily for clearing operations or for covert breaching operations. Detection of mines by visual or electronic methods should be confirmed by probing. Use the following procedures and techniques when probing for mines:

- Roll up sleeves and remove jewelry to increase sensitivity. Wear a Kevlar helmet with the chin strap buckled.
- Stay close to the ground; move on hands and knees or from a prone position.
- Use sight and touch to detect trip wires, fuzes, and pressure prongs.
- Use a slender, nonmetallic object as a probe.
- Probe every 2 inches (5 centimeters) across a 1-meter front.
- Gently push the probe into the ground at an angle less than 45 degrees.

#### DANGER

**If the probe is pushed straight down, its tip may detonate a pressure fuze.**

- Apply just enough pressure on the probe to sink it slowly into the ground.
- If the probe encounters resistance and does not go into the ground freely, pick the soil.

away with the tip of the probe and remove the loose dirt by hand.

- When a solid object is touched, stop probing and carefully remove the surrounding soil to determine what the object is.
- If the object is a mine, remove enough soil to show the mine type and mark its location. Do not attempt to remove or disarm the mine. Use explosives to destroy detected mines in place, or use a grappling hook and rope to cause mines to self-detonate. Do not use metal grappling hooks on magnetic-fuzed mines.

### Electronic

Electronic mine detectors are effective for locating mines; however, they are time-consuming and expose personnel to enemy fire. In addition, the mine location must be confirmed by probing.

The AN/PSS-11 detector (Figure 9-1a) and the successor model, AN/PSS-12 (Figure 9-1b), can only detect metal. However, most mines have metal components in their design. The detectors can locate and identify plastic or wooden mines by this slight metallic signature. Technical data is available on the AN/PSS-11 in TM 5-6665-202-13 and on the AN/PSS-12 in TM 5-6665-298-10. The detector is handheld and identifies suspected mines by an audio signal in the headphones.

### Mechanical

The track-width mine roller is a minefield detection system. It is most effectively deployed to lead columns on route movement, but it can be used to precede tactical formations. In column movement, unit vehicles travel a narrow path, and one or two mine rollers can effectively detect mines in the path. Mine rollers are also used to detect minefield in front of deployed tactical formations, although more than one roller tank is required for good probability of detection.

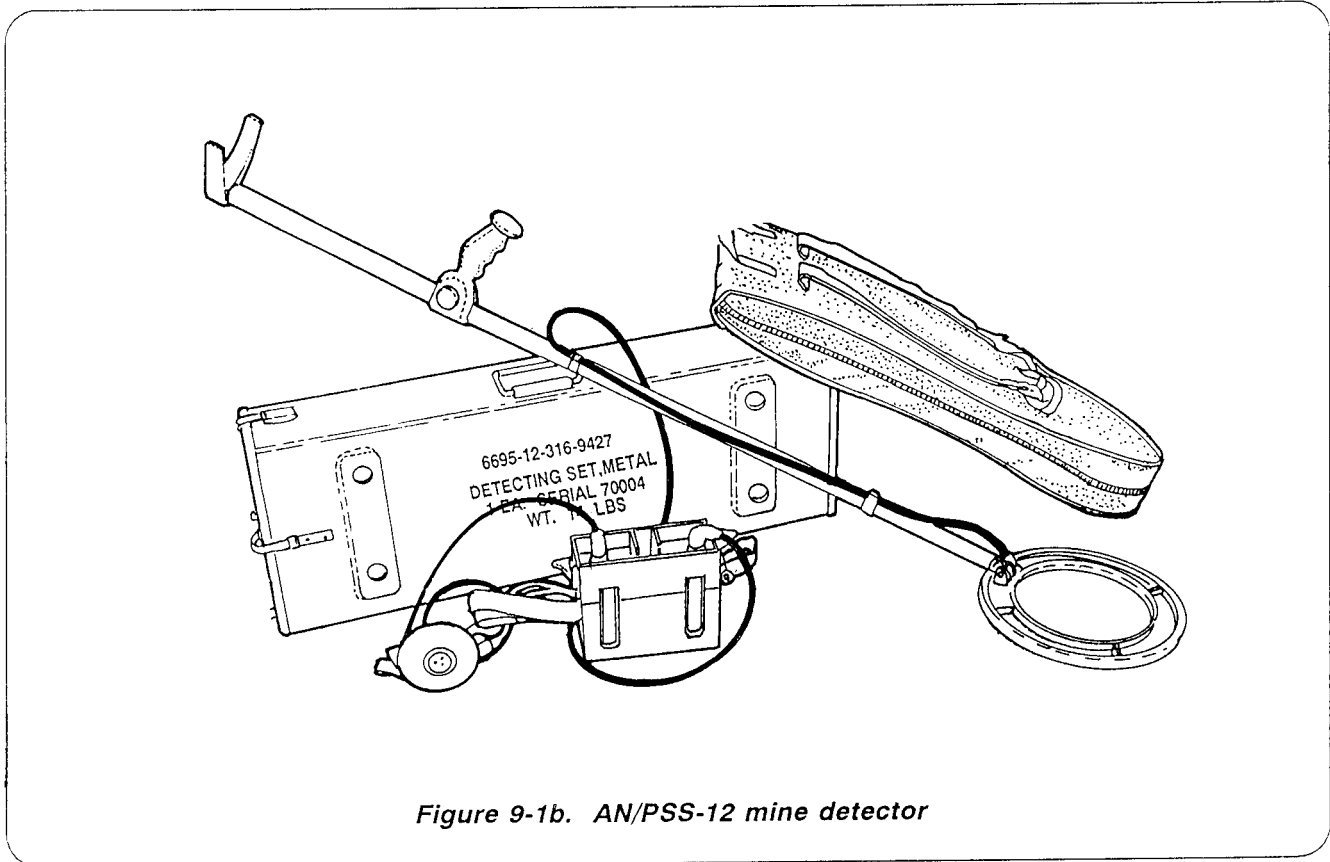
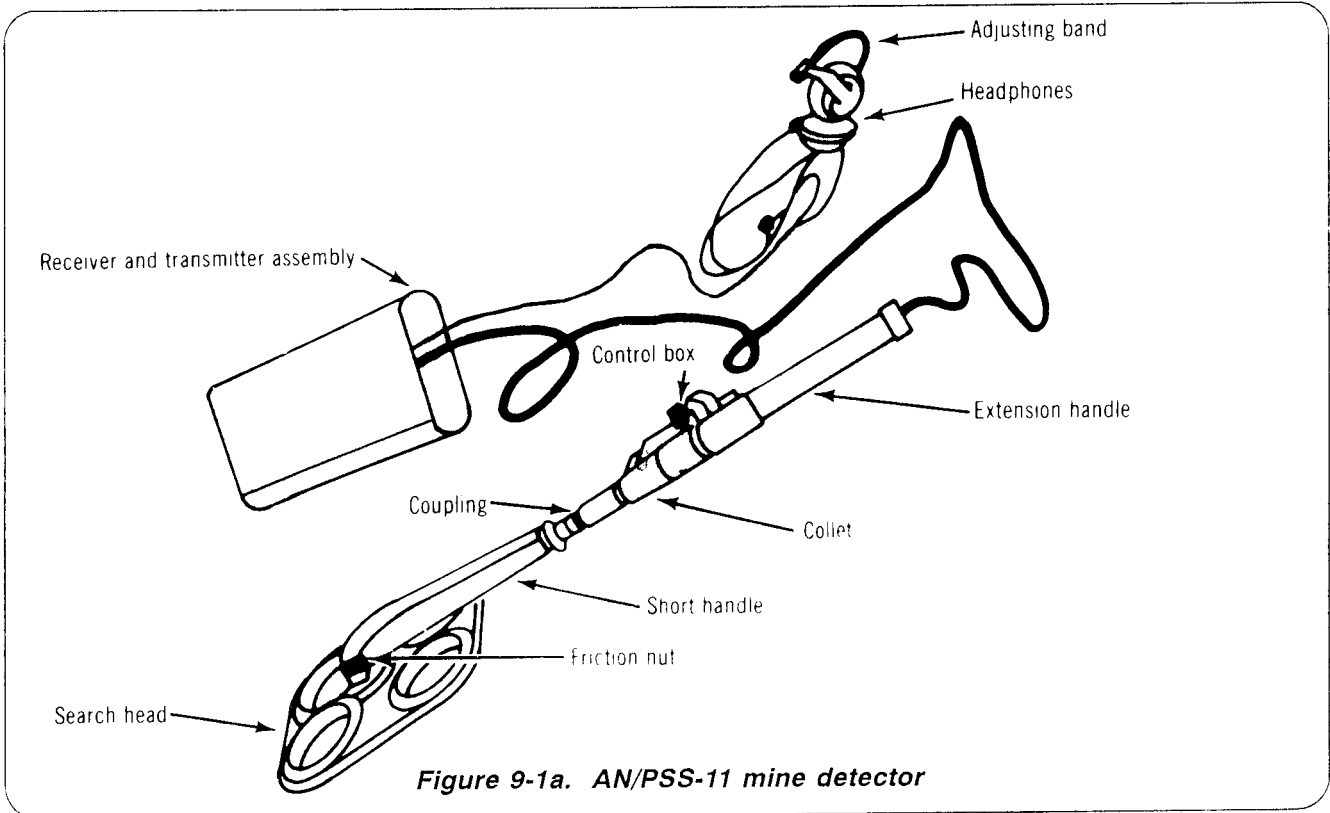

## REPORTING

Intelligence concerning enemy minefields is reported by the fastest means available. Spot reports are the tactical commander's most common source of minefield intelligence. They originate either from patrols that have been sent on specific minefield reconnaissance mis-

sions or from units that have discovered mine information in the course of their normal operations. The information is transmitted to higher headquarters using the enemy minefield report.

## REDUCING (BREACHING AND CLEARING)

Minefield reduction and clearing equipment is broken down into explosive, mechanical, and manual means. Combat engineers and operators of breach assets practice and become proficient in reduction means. They integrate them into breach drills of units they support. The team applies different tactics and techniques to breach drills and prepares and rehearses them as part of the TF plan.

### Explosive

#### M58A4 Mine-Clearing Line Charge.

The MICLIC (Figure 9-2) is a rocket-propelled explosive line charge used to reduce minefields

containing single-impulse, pressure-activated AT mines and mechanically activated AP mines. It clears a 14- by 100-meter path. The MICLIC has a 62-meter standoff distance from launcher to detonation point. It has limited effectiveness against magnetically activated mines, including scatterable mines and those containing multiple-impulse or delay-time fuzes. It also has little effect on other obstacles, such as log and concrete barriers or anti-vehicular ditches and walls. The shock effect and psychological impact of the detonation make the MICLIC a useful weapon in a close fight or in MOUT.

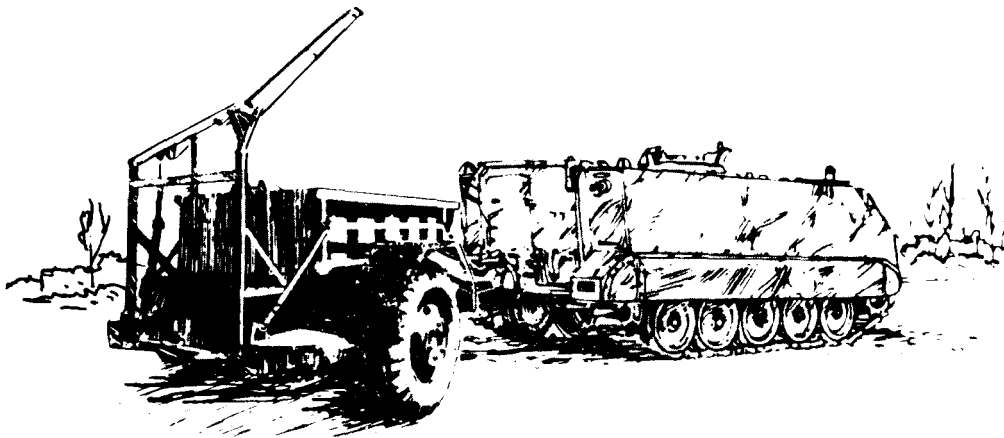

Figure 9-2. M58A4 Mine-clearing line charge (MICLIC)

The MICLIC is mounted on a rubber-tired trailer, or two MICLICs can be mounted on an armored vehicle launched bridge (AVLB) with the bridge downloaded. This is called an armored vehicle launched MICLIC (AVLM) (Figure 9-3). Using the AVLM is the preferred method because a trailer is not involved to hinder the mobility of the towing vehicle. Towing vehicles for the trailer-mounted MICLIC include the M60 tank, CEV, M1 13, M2, M3, ACE, 5-ton wheeled vehicle, and 2 ½-ton wheeled vehicle. An M1 series tank has high exhaust temperatures so it cannot tow the charge. A trailer limits the MICLIC's mobility in rough terrain and degrades the maneuverability of the towing vehicle, thereby increasing vulnerability. Since the MICLIC is critical to the breach, it is kept under the protection of the force and is moved to the breach site along easily trafficable, covered, and concealed routes. This effectively prevents the towing vehicle from performing any other task (firing and maneuvering) or from serving as an engineer squad vehicle unless MICLIC employment is the squad's only mission. This is an important consideration when selecting the towing vehicle because the vehicle must be solely dedicated to the mission.

The MICLIC can be fired from within an armored towing vehicle without exposing soldiers to fires, although prefiring preparations must be done in advance at a covered and concealed location near the breach site. The lanyard and initiating cable are brought into the vehicle through a hatch which must be left ajar or through the portal of a periscope that has been removed. Therefore, the crew is not afforded nuclear, biological, chemical (NBC) protection. When the MICLIC is fired from a wheeled vehicle, however, the crew must move to a covered position to the rear and side of the launcher. The special-purpose cable of the firing control switch is long enough to allow adequate standoff.

The towing vehicle operator must be proficient in all aspects of preparing and deploying the MICLIC, including the critical aspect of selecting the optimum breach site. Although the operator will generally be directed to the breach site by the engineer platoon leader or breach force commander, ensuring that he can independently accomplish the task simplifies the operation and greatly enhances its likelihood of success. The towing vehicle and operator must be selected well in advance and be

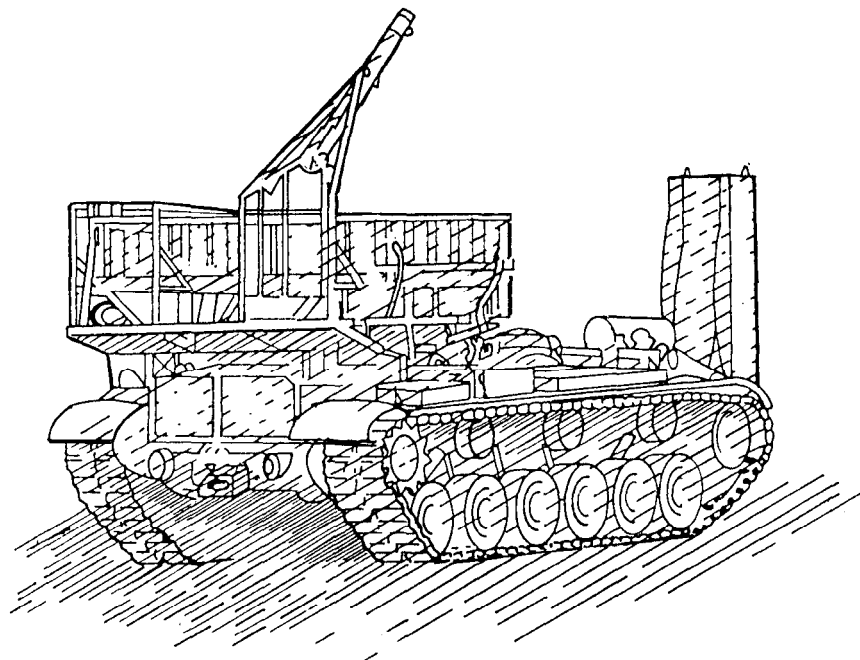

Figure 9-3. Armored vehicle launched MICLIC (AVLM)

dedicated solely to the task. The operator must be included in all rehearsals and planning sessions and, if possible, during leader reconnoiters.

Each MICLIC trailer transports and fires one charge and then reloads. The AVLM can fire both MICLICs before reloading. The loaded charge container weighs 2,850 pounds, so a lifting device such as a 5-ton wrecker or a heavy expanded mobility tactical truck (HEMTT) is needed. Reloading, which can be done by an experienced crew in about 30 minutes, entails loading a rocket on the rail and lifting a new charge container onto the launcher. The reloading operation must be done in a covered and concealed location.

The number of MICLICs needed to clear a single lane through a minefield depends on the minefield depth. Minefields greater than 100 meters deep require two or more MICLICs;

minefields less than 100 meters deep require only one MICLIC. However, the exact limits and depth of an enemy minefield are seldom known before the breach. This is particularly true when the situation is unclear and the minefield is encountered simultaneously with enemy contact. The first and only indication that the unit is in a minefield may be when a vehicle encounters a mine. The leading edge of the minefield may still be uncertain since the vehicle could have hit a mine in an interior row. Therefore, there are two basic drills for MICLIC employment:

- Clearing a lane through a minefield less than 100 meters deep requires one MICLIC (Figure 9-4). If time permits, the leading edge of the minefield is identified and confirmed by reconnaissance. The MICLIC is deployed from a minimum standoff distance of 62 meters from the leading edge of the minefield.

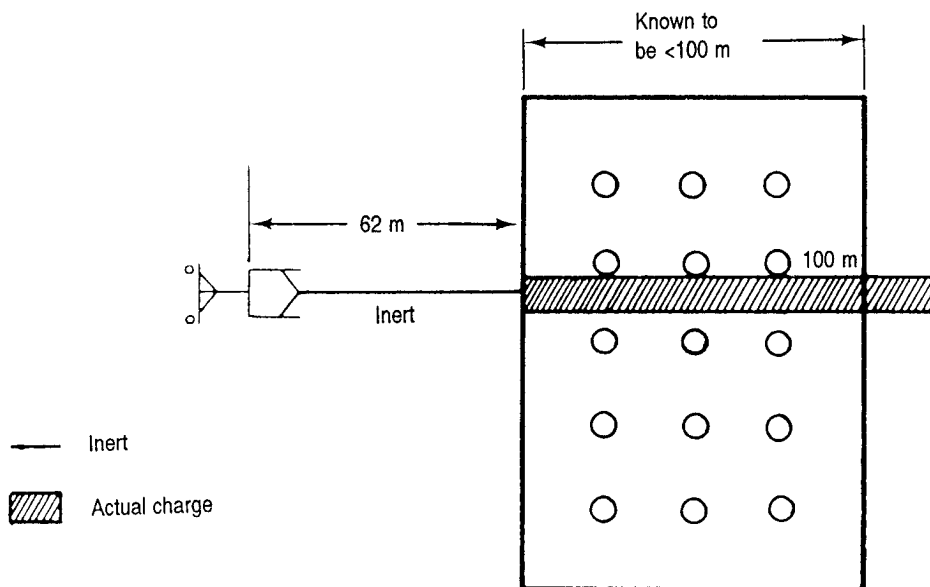

Figure 9-4. MICLIC employment in a minefield less than 100 meters deep

- ★ • Clearing a lane through a minefield more than 100 meters deep or of uncertain depth requires two or more MICLICs. If the leading edge cannot be identified, the MICLIC is deployed 100 meters from the possible edge or stricken vehicle (Figure 9-5). When the first MICLIC is detonated, a second MICLIC

moves 25 meters into the first MICLIC's path and fires its charge. This extends the lane an additional 87 meters. Additional MICLICs are used for minefields of extreme depth, and each one moves down the lane 25 meters into the path created by the previous charge.

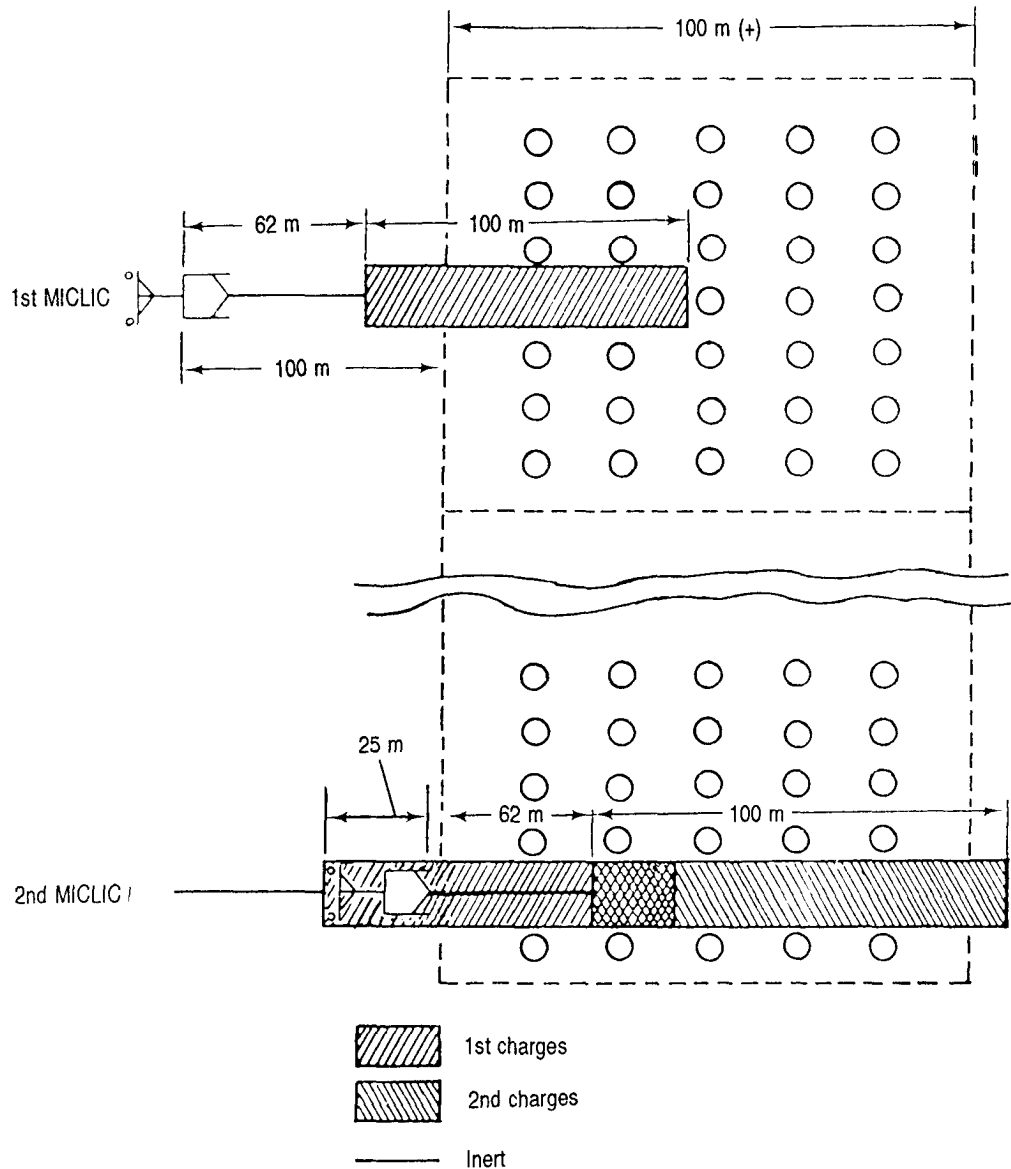

Figure 9-5. MICLIC employment in a minefield of uncertain depth or greater than 100 meters

### Antipersonnel Obstacle Breaching System.

The Antipersonnel Obstacle Breaching System (APOBS) (Figure 9-6) is a man-portable device that is capable of quickly creating a footpath through AP mines and wire entanglements. The APOBS is normally employed by combat engineers, infantry, or dismounted armored cavalry personnel. It provides a lightweight, self-contained, two-man, portable line charge that is rocket-propelled over AP obstacles from a standoff position away from the edge of the obstacle. For dismounted operations, the APOBS is carried in backpacks by no more than two soldiers and for a maximum of 2 kilometers. One backpack assembly consists of the rocket motor launch mechanism containing a 25-meter line charge segment and 60 attaching grenades. The other backpack assembly contains a 20-meter line charge segment and 48 attached grenades. The APOBS weighs approximately 110 pounds. It is capable of breaching a footpath approximately 0.6 by 45 meters and is fired from a 25-meter stand-off.

### M1A1/M1A2 Bangalore Torpedo.

The bangalore torpedo (Figure 9-7) is a manually emplaced explosive-filled pipe that was designed as a wire breaching device, but it is also effective against simple pressure-activated AP mines. It is issued as a demolition kit and consists of 10 1.5-meter tubes. Each tube contains 9 pounds of high explosives and weighs 13 pounds. The kit clears a 1- X 15-meter lane.

The bangalore torpedo is used by dismounted infantry or engineer troops. An individual soldier or a pair of soldiers connects the number of sections needed and pushes the torpedo through the minefield before priming it. A detailed reconnaissance is conducted before employing the bangalore torpedo to ensure no trip wires have been used.

Bangalore torpedoes usually do not generate enough overpressure to detonate AT mines unless they are placed immediately next to them. Several threat and friendly mines require two

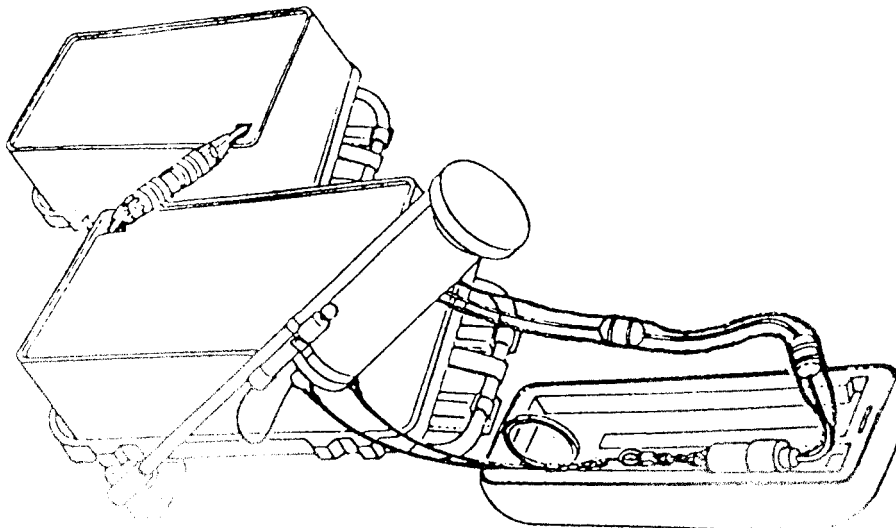

Figure 9-6. Antipersonnel Obstacle Breaching System (APOBS)



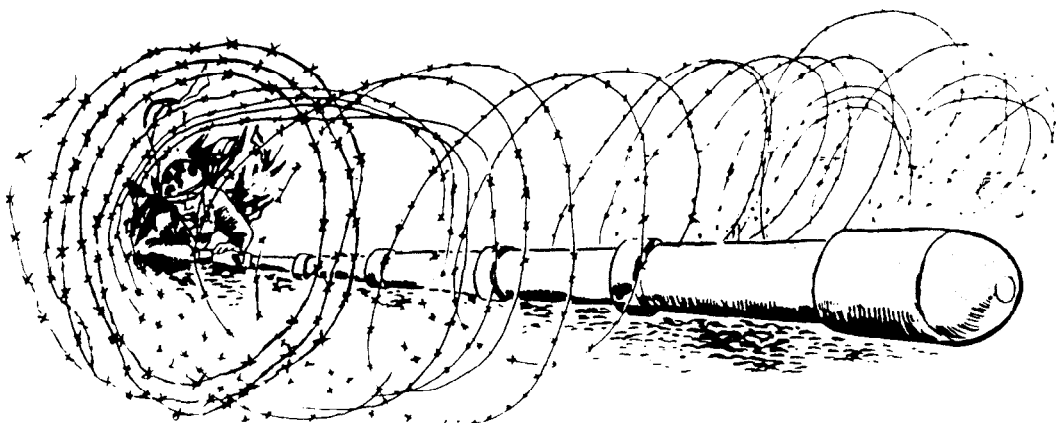

Figure 9-7. M1A1/M1A2 bangalore torpedo

impulses or a single, long impulse for detonation. The bangalore generates one short impulse. As a last resort against AT mines, use the bangalore as follows:

- Place the bangalore immediately adjacent to surface-laid mines. If mines are mechanically buried in furrows, lay three sections along the furrow, perpendicular to the direction of the lane (Figure 9-8). If mines are staggered or widely spaced, lay sections parallel to the direction of the lane.

- Clear two track-width paths. A 100-meter minefield requires several kits.

### Mechanical

MCBs, mine clearing rollers (MCRs), and Cleared Lane Marking Systems (CLAMs) are fielded as armor battalion sets containing twelve MCBs, four MCRs, and four CLAMs. Blades clear lanes through minefields, while rollers are used to detect minefields and proof lanes created by other means. Rollers are not

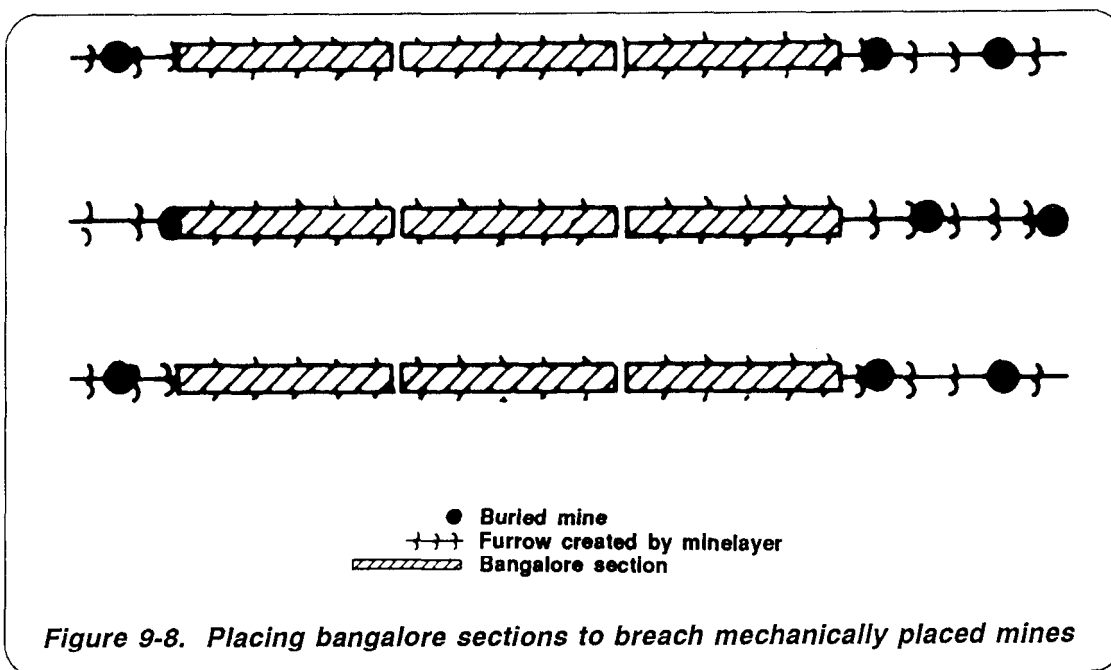

Figure 9-8. Placing bangalore sections to breach mechanically placed mines

a good primary system for lane reduction because multiple mine detonations destroy the roller system and the vehicle pushing it.

### Mine Clearing Blade.

The MCB (Figure 9-9) is used to extract and remove land mines from the minefield. It consists of a blade arrangement with scarifying teeth to extract mines, a moldboard to cast mines aside, and leveling skids to control the depth of the blade.

The MCB lifts and pushes mines, which are surface-laid or buried up to 12 inches, to the side of a track. It has three depth settings—8, 10, and 12 inches. The blade creates a 58-inch cleared path in front of each track (Figure 9-10). The skidshoe for each blade exerts enough pressure to activate most single-pulse mines and effectively clears a section of the centerline by explosive detonation. This action may disable the blade. A *dog bone* and chain assembly between the blades defeats tilt-rod fuzed mines. The improved dog bone assembly (IDA) being fielded defeats tilt-rod and magnetically fuzed mines. The IDA projects a magnetic signature when plowing. Multiple impulse pressure fuzes encountered by skidshoes

are not defeated. Mines armed with antihandling and antidisturbance devices or magnetic and seismic fuzes may be activated when lifted by the blade. They may also disable the blade. Mines lifted by the blade are left in the spoil on each side of the furrowed path and remain a hazard until they are removed.

The blade can be mounted to an M1 tank without special preparation or modification. Mounting requires lift capability and takes up to an hour, so it must be done well in advance of the mission. It is not easy to mount or transfer the MCB to another tank under battlefield conditions. Once mounted, an electric motor raises and lowers the blade. The MCB is also equipped with an emergency, quick disconnect feature.

The MCB weighs approximately 3 1/2 tons. When it is in the raised position, it minimally effects the M1's maneuverability and speed. This does not greatly impact the employment of the weapon system, except when the blade is in operation.

When plowing, the M1 is restricted to less than 10 kph depending on soil conditions. It cannot maneuver but must continue in a straight path

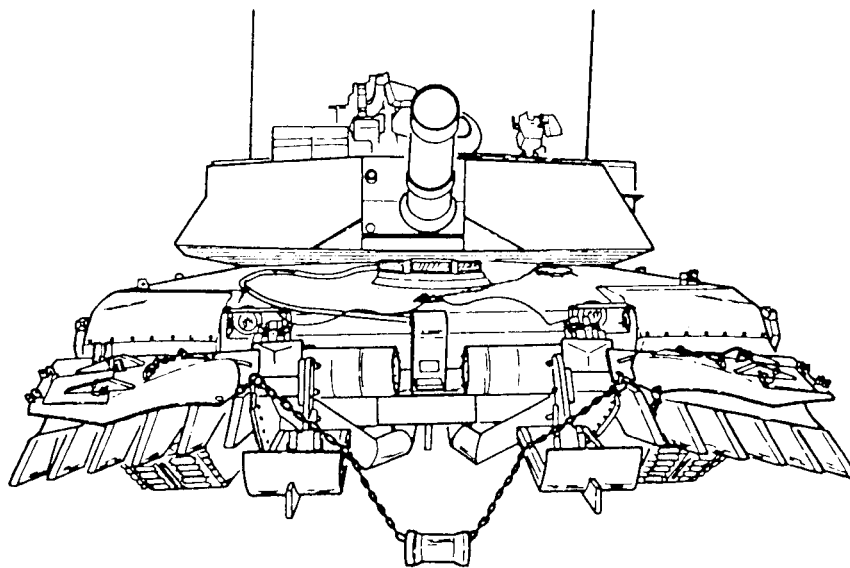

Figure 9-9. Mine clearing blade (MCB)

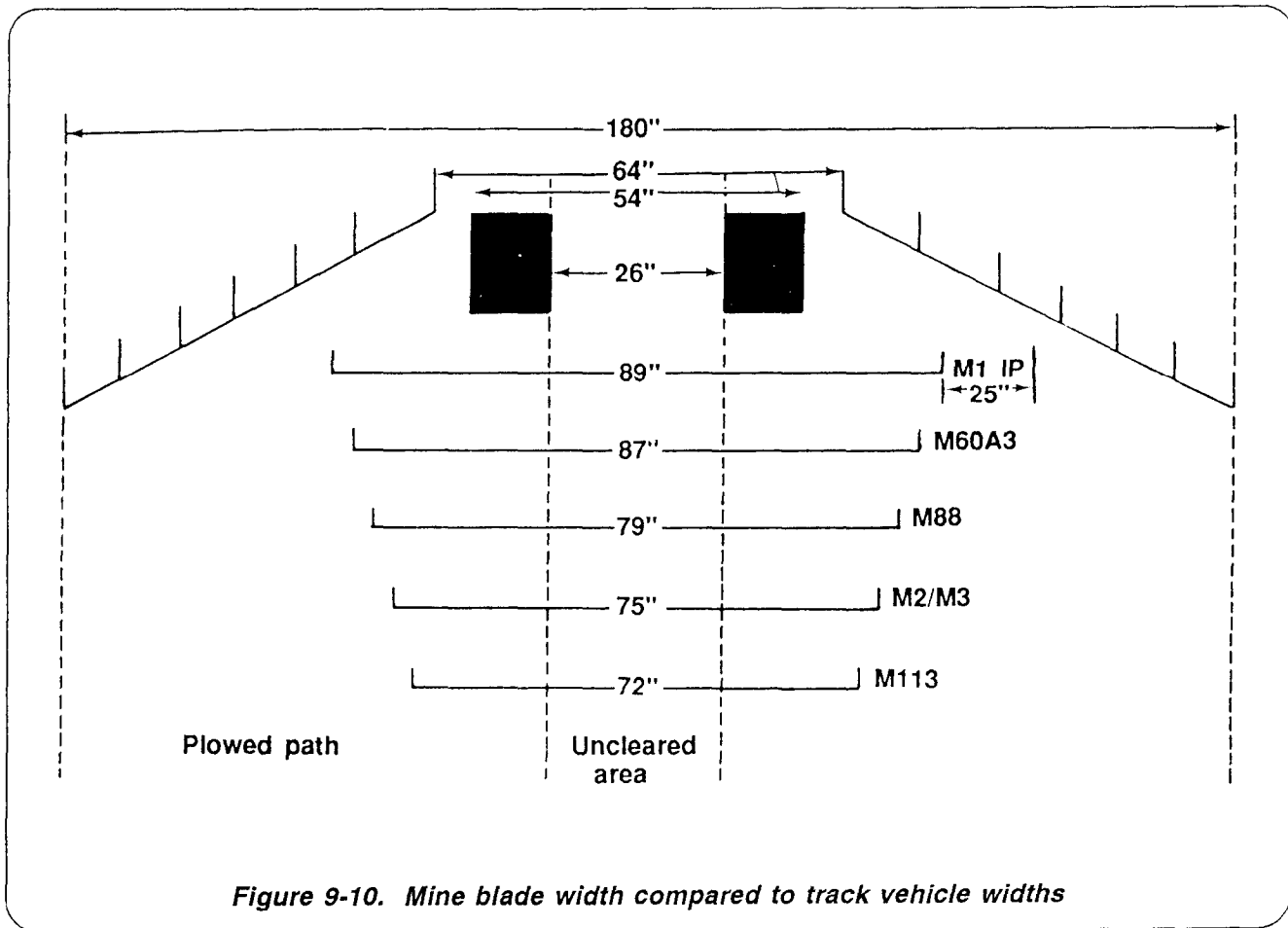

Figure 9-10. Mine blade width compared to track vehicle widths

through the minefield to avoid damaging the blade. The main gun must be traversed to the side during plowing, since a mine detonation under the blade may cause it to be thrown violently into the air and damage the tube. The area selected for the lane must be relatively flat and free of rocks or other obstructions.

The operator begins plowing approximately 100 meters from the estimated minefield leading edge. He creates a lane extending another 100 meters beyond the estimated minefield far edge to ensure the lane extends through the entire minefield.

**Mine Clearing Roller.**

The MCR (Figure 9-11, page 9-12) consists of a roller assembly, mounting kit, and hand winch kit. The roller assembly weighs approximately 10 tons and consists of two push beams mounted to the front of the tank. Rollers

are designed to defeat most single-pulse, pressure-activated AT and AP mines. The roller creates a 44-inch cleared path in front of each track (Figure 9-12, page 9-12). A dog bone and chain assembly between the rollers defeats tilt-rod fuzed mines. The IDA can be fitted to the roller. The roller is designed to withstand multiple mine explosions before damage; however, this depends on the size of the mine explosive material. Large blasts may destroy the roller and vehicle or injure the crew.

The MCR can be mounted on an M1/M60 tank with a permanently attached mine roller mounting kit. Mounting of the roller to the tank is a cumbersome and time-consuming operation. It is very difficult under battlefield conditions and requires lift capability. When employed, the roller tank is limited to 5 to 15 kph. When employed in a suspected minefield, the MCR must travel in a relatively straight

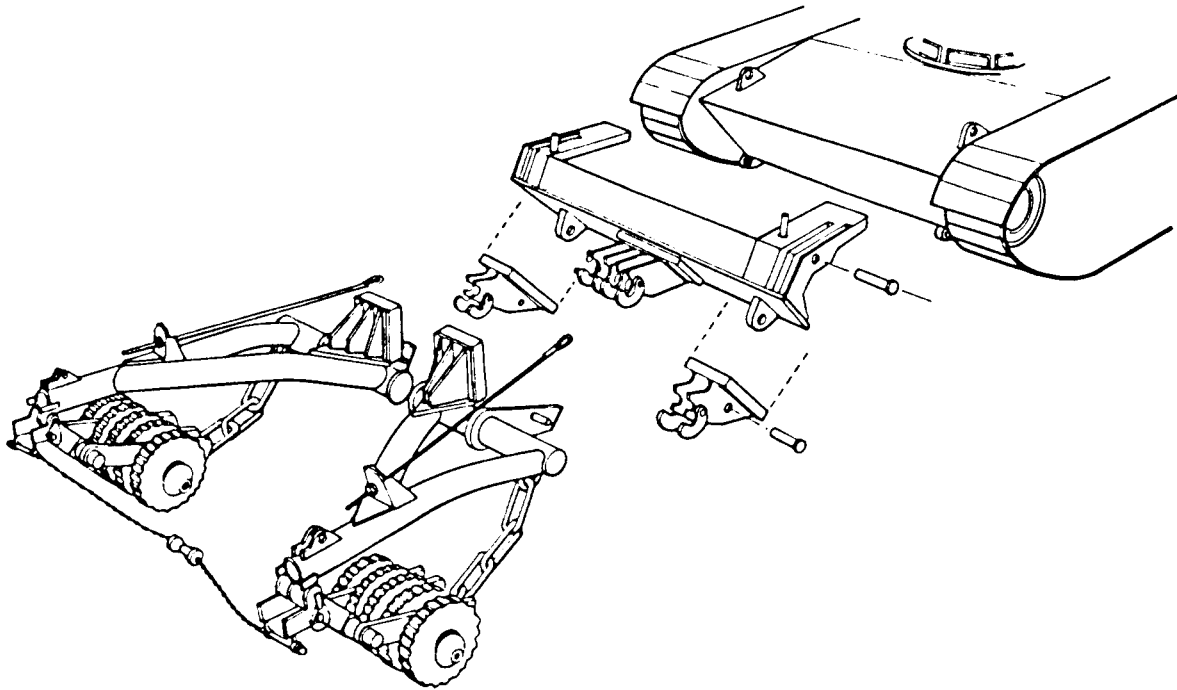

Figure 9-11. Mine clearing roller (MCR)

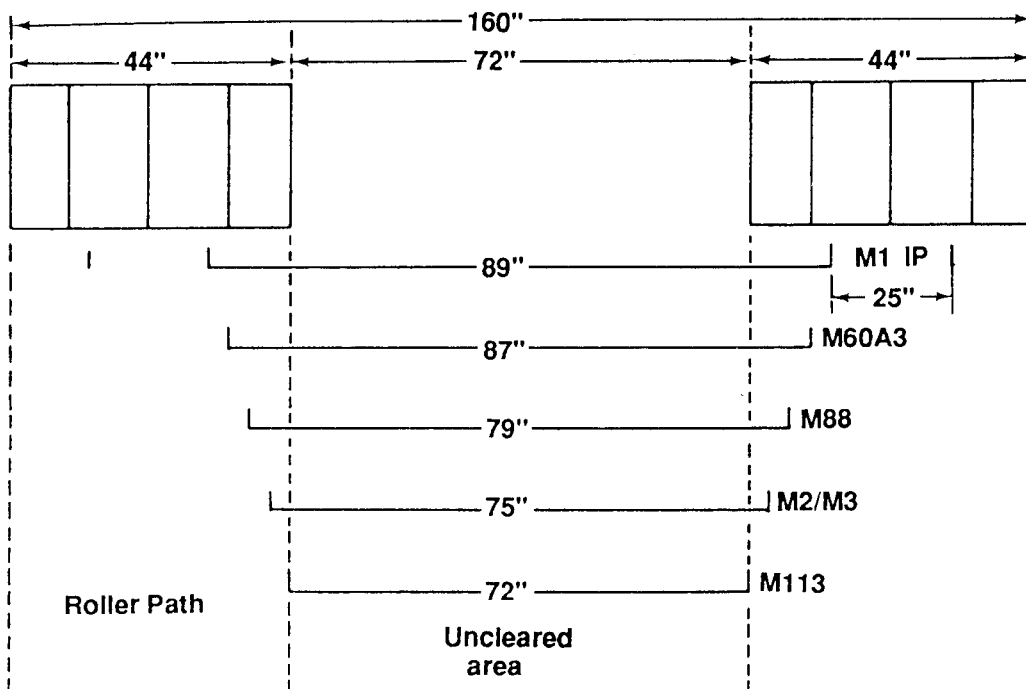

Figure 9-12. Mine roller width compared to track vehicle widths

path because tight turns may cause the roller to deviate from the path of the track and leave the tank vulnerable to mines. Ground fluctuations, bumps, or berms may cause the roller to lift from the ground and miss mines. The MCR is not designed to negotiate gaps on its own; however, it can be used on an AVLB caution crossing. In this situation, the bridge curbing is removed. To prevent bridge hydraulic line damage, the tank driver uses a strap to lift the dog bone and chain when crossing the bridge. The main gun must be traversed to the rear or side when a mine encounter is possible or imminent, because a mine blast can throw the roller or parts of the roller violently into the air and damage the tube.

When the situation and mission permit, MCRs may be employed as lead vehicles to detect minefields. This is most viable when the supported element is traveling in a column. The roller may also be used to lead a supported element traveling in a tactical formation other than a column, but it is less effective than other methods because—

- Vehicles not directly behind the roller may encounter mines passed by the roller.
- The roller may travel well into or completely through a widely spaced minefield without encountering a mine, thus giving the formation a false sense of security.
- The mine encountered by a roller may not be on the leading edge of the minefield.
- The roller is extremely vulnerable, because it cannot effectively use its weapon system.

Rollers are best used to proof lanes in obstacles breached by other means, such as the MICLIC or MCB. A roller pulling a trailer-mounted MICLIC can proof a lane created by a MICLIC launched by another vehicle. The roller then fires the second MICLIC and proofs its own lane.

If rollers participate in a deliberate breach operation, or if the force incorporates rollers into in-stride breach plans, rollers should be

mounted before rehearsals. If left unmounted, rollers are carried in the TF formation on M916 tractor-trailers. Rollers require lift capability (such as an M88), a secure location, and 30 to 60 minutes to mount on a tank that is fitted with a mounting kit.

### **Cleared Lane Marking System.**

The CLAMS (Figure 9-13, page 9-14) allows rapid, remote marking of a breached lane so it can be seen at night. It can be mounted on the rear of an M1/M60 tank having the proper adapter assembly. Marking is only adequate for the initial assault, and it must be replaced and improved as soon as possible with marking procedures discussed later in this chapter.

### **Combat Engineer Vehicle with Full-Width Mine Rake.**

This system consists of a wedge-shaped rake mounted to a CEV blade (Figure 9-14, page 9-14). The rake weighs 2 tons. The rake is lifted off the transport vehicle with a HEMTT, wrecker, an M88, or a CEV boom. Then, the CEV crew installs it in 30 minutes using basic issue item tools. The rake has a skidshoe to maintain a raking depth of 12 inches. It provides vehicle-width clearance (15 feet) at 5 to 10 kph. The rake has a quick disconnect feature. It lifts surface-laid mines and mines buried up to 12 inches, and it pushes the mines off to both sides. The CEV with full-width mine rake is used to clear lanes during minefield breaching. Since it is full width, it is preferred over the MCB. While the CEV can be employed as the first breaching asset into a minefield, a MICLIC should be used first to eliminate as many mines as possible. The rake is then used to proof the lane. The CEV with rake can pull a MICLIC and fire it before proofing. Raking begins 100 meters before the minefield and continues 100 meters beyond the suspected limit. The CEV maintains a straight course through the minefield. If the skidshoe is damaged, the operator reduces speed and manually controls the blade depth. This is very difficult and risky. The rake performs well in sandy soil, but its effectiveness may be considerably reduced in loamy or clayey soil.

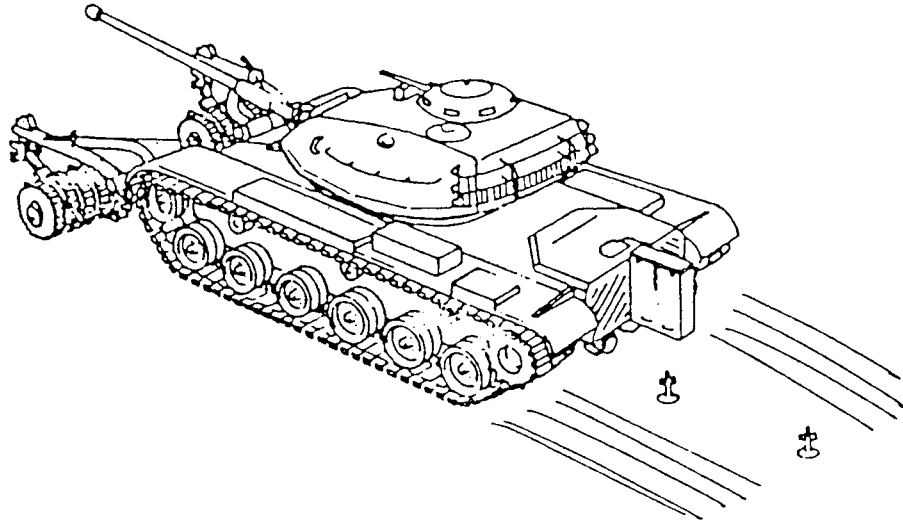

Figure 9-13. Cleared Lane Marking System (CLAMS)

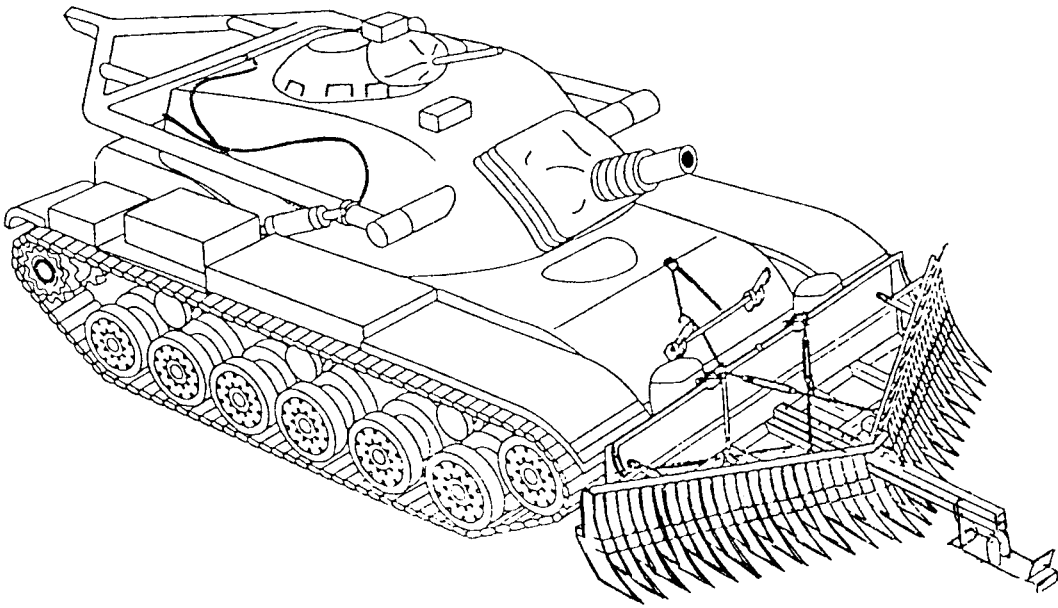

Figure 9-14. CEV with full-width mine rake

## Manual

When advanced mechanical equipment is unavailable, manual breaching procedures provide a backup. Manual obstacle reduction is the only method that works in all situations and under all conditions. Certain types of terrain, weather, and sophisticated fuzes can severely degrade the effectiveness of rollers, plows, and line charges. Engineers use hand-emplaced explosives, grapnel hooks attached to ropes, probes, mine detectors, and hand-emplaced marking equipment to breach obstacles.

### Surface-Laid Minefields.

The Soviets possess a significant mechanical mine-burying capability. They also have the capacity and propensity for the labor-intensive effort required to bury mines by hand. However, they often lay mines on the surface. Buried mines are usually found in a prepared defense requiring a deliberate breach operation. Training and execution of surface and buried minefield breaches should always assume the presence of AHDs and trip wires until it is proven otherwise.

From covered positions, engineers first use grapnel hooks to check for trip wires in the desired lane. The limited range of the tossed hook requires the procedure to be repeated through the estimated width of the obstacle. A demolition team then moves through the desired lane. The team places a line main down the center of the lane, ties the line from the explosives into the line main, and places blocks of explosives next to surface-laid mines. After mines are detonated, the team makes a visual check to ensure all mines were cleared before directing a proofing roller or other traffic through the lane.

As a variation of this procedure, blocks of explosives are preprinted with a fixed length of time fuze set for an SOP time, such as 5 minutes. The team moves through the surface-laid obstacle. Team members light the time fuze on the blocks of demolitions, set it next to a surface-laid mine, and then move to the next mine. This procedure is much faster than

the line-main method, but it does have drawbacks. A higher chance of misfire exists with individually primed demolitions. Possible injuries in the minefield containing initiated firing devices can defeat the closely timed breach, and detonations occurring at different times can dislodge charges placed next to other mines. Use this technique only when speed and mission necessitate such risks. Manual procedures must be well-practiced no matter what the technique details are. Demolition team soldiers are assigned special tasks such as grappler, detonating cord man, and demolitions man. All engineers in the team should be cross-trained on all procedures. Demolitions are prepared for use before arriving at the breach site. An engineer platoon uses squads in series through the minefield to clear a lane for a company team. The platoon must rehearse reduction procedures until execution is flawless, quick, and technically safe. During the breach, the engineer platoon is exposed in the lane for 5 to 30 minutes or more depending on the mission, minefield depth, and their level of training.

### Buried minefields.

Manually breaching a buried minefield is extremely difficult to perform as part of an in-stride breach operation. It is usually part of a deliberate breach. If mine burrows are not easily seen (as they are after moisture falls on a recently buried, poorly compacted hole), mine detectors and probes must be used to locate mines. Mines are then destroyed by hand-emplaced charges. As an alternative, mines can be removed by using a grappling hook and, if necessary, a tripod.

The engineer platoon leader organizes soldiers into teams with distinct, rehearsed missions including grappling, detecting, marking, probing, demolitions, and detonating cord emplacing. The platoon is exposed in the obstacle for long periods of time.

### Grappling Hook (Grapnel).

The grappling hook is a multipurpose tool with important use in manual obstacle reduction. Soldiers use it to detonate mines from a stand-

off position by activating trip wires and AHDs. After the grappling hook is used to clear trip wires in a lane, dismounted engineers can move through the minefield, visually locate surface-laid mines, and prepare these mines for demolition. In buried minefields, soldiers grapple and then enter the minefield with detectors and probes. A 60-meter (or longer) cord is attached to the grapnel for hand throwing. The throwing range is usually no more than 25 meters. Excess rope is used for stand-off distance when the thrower begins grappling. The thrower tosses the hook and seeks cover before the grapnel and rope touch the ground in case the impact detonates a mine. He then

moves backward, reaches the end of the excess rope, takes cover, and begins grappling. Once the grapnel is recovered, the thrower moves forward to the original position, tosses the hook, and repeats the procedure at least twice. He then moves to the end of the grappled area and repeats this sequence through the depth of the minefield. Multiple grapplers can clear a lane of trip wires quickly and thoroughly, but they must time their efforts and follow procedures as simultaneously as possible.

Engineers carry extra hooks and cord because a hit on a trip wire or pressure fuze can destroy them.

## PROOFING

Proofing verifies a lane is free of mines by passing a mine roller or another mine-resistant vehicle through the lane as the lead vehicle. The CEV with full-width mine rake or the MCB can be used to proof. This is only done when the risk of live mines remaining in the lane exceeds the risk of loss to enemy fire while waiting. Some mines are resistant to certain breaching techniques (for example, magneti-

tally fuzed mines may be resistant to the MICLIC blast), so proofing should be done when time, threat, and mission allow.

During a limited clearing operation, proof upgraded breach lanes following a breach. After the minefield is completely cleared, proof the routes used through the area.

## MARKING

After tactical lanes or bypasses are established in an obstacle, they must be marked and identified for follow-on forces. Mark and report reduced lanes immediately. Additionally, the tactical breach lane marking system must be standard throughout the division area. See FM 90-13-1, Appendix E, for detailed guidance.

The tactical lane marking system must be easily seen and recognized by a buttoned-up vehicle crew. It must be seen through smoke and dust and, if required, at night. It must also be constructed from materials readily available in the Army supply system. Modern tanks and infantry fighting vehicles have infrared sights that can see heat sources through smoke. Remember, though, the active

battlefield will have many heat sources, and the tactical lane marking system must be easily seen under these conditions.

Markers and guides must be visible from a distance so the follow-on unit can initially get on the correct route. There is a V-shaped entrance (like a funnel) to guide the unit. The exit is marked so the unit does not deploy back into the combat formation while they are still in the obstacle system. This is extremely critical when the obstacle is complex and has depths greater than 100 meters.

The OPLAN identifies combat engineer units to expand tactically breached lanes, establish two-way traffic, and mark lanes using the standard minefield marking set #2.



The centerline marker must be eye-level (3 to 5 feet) and extremely visible. Mark the reduced (breached) lane at the entrance, along the left side, and at the exit (Figure 9-15, page 9-18). Entrance and exit markers are different from left-side markers and are easy to recognize. Again, it is critical that exit markers be different so the driver knows when he is out of the obstacle. The funnel-shaped entrance is spread over a 50- by 100-meter area. The outer opening is 100 meters wide and is 50 meters from the tactical lane entrance. This allows mounted forces to transition to a column formation. The far recognition marker is established like a traffic control post and has a guide to assist follow-on assaulting forces. This marker can be a maximum of one kilometer from the breached lane(s) and should be visible for at least one kilometer in open country. An unmanned, intermediate recognition marker is placed approximately 500 meters from the obstacle. If possible, left-side markers of the assault lane marking system are done from an armored vehicle to protect the sapper or infantry man from enemy fire.

A systematic improvement is required to the above minimum tactical lane marking system. First, markers are placed on the right side of the lane. Lane markers are moved to the edge of the reduced and cleared lane. (The MICLIC-cleared lane is 14 meters wide after it is proofed.) Next, a centerline is established and a funnel marking system is placed at the exit to allow two-way traffic (Figure 9-16, page 9-19). Finally, a follow-on combat engineer unit expands the lane and marks it with a more

permanent marking system. The regimental engineer designates a combat engineer unit to accomplish this mission.

Criteria for adopting a division tactical lane marking system are as follows:

- The marker is visible by a buttoned-up driver and the TC in extensive dust and smoke.
- The marker is durable and able to remain upright in high winds.
- The marker can be quickly and easily emplaced, allowing the marking unit to move quickly through the reduced (breached) lane.
- Left-side lane markers are placed by a squad. The squad does not dismount when marking the lane. They can dismount to mark the entrance and exit.
- The marker can be easily modified for use during limited visibility.

Marking systems currently available are the HEMMS, standard traffic cones, highway markers, and locally fabricated *Tippy Toms*. (The Tippy Tom is a copy of an Israeli system and uses a fabricated base and HEMMS poles.) (See Figures 9-17 and 9-18, page 9-20.)

A sample division tactical marking system is shown in Table 9-1, page 9-21. Table 9-2, page 9-21, shows a sample division tactical marking system for a division that has an abundant supply of HEMMS and VS17 panels.

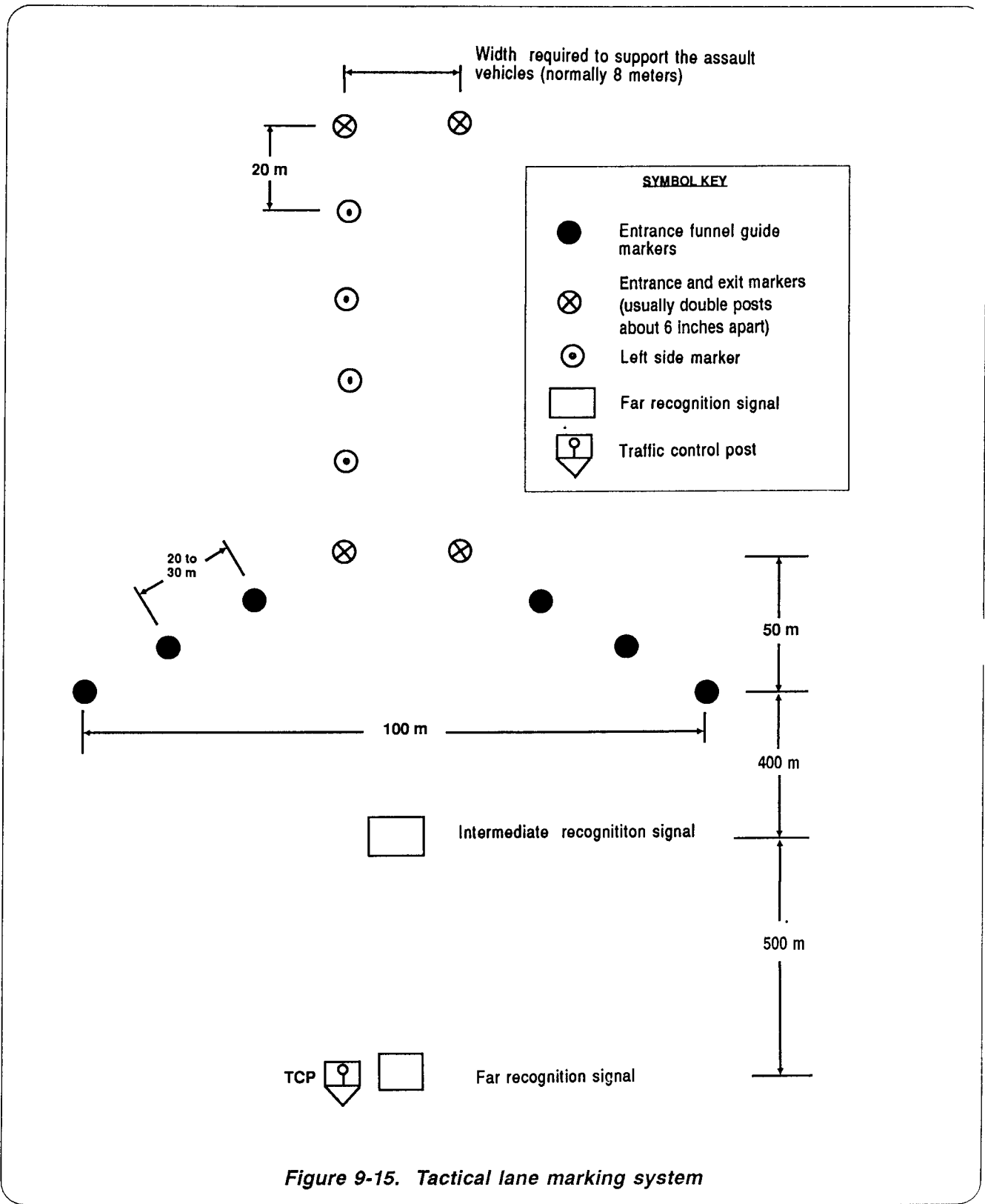

Figure 9-15. Tactical lane marking system

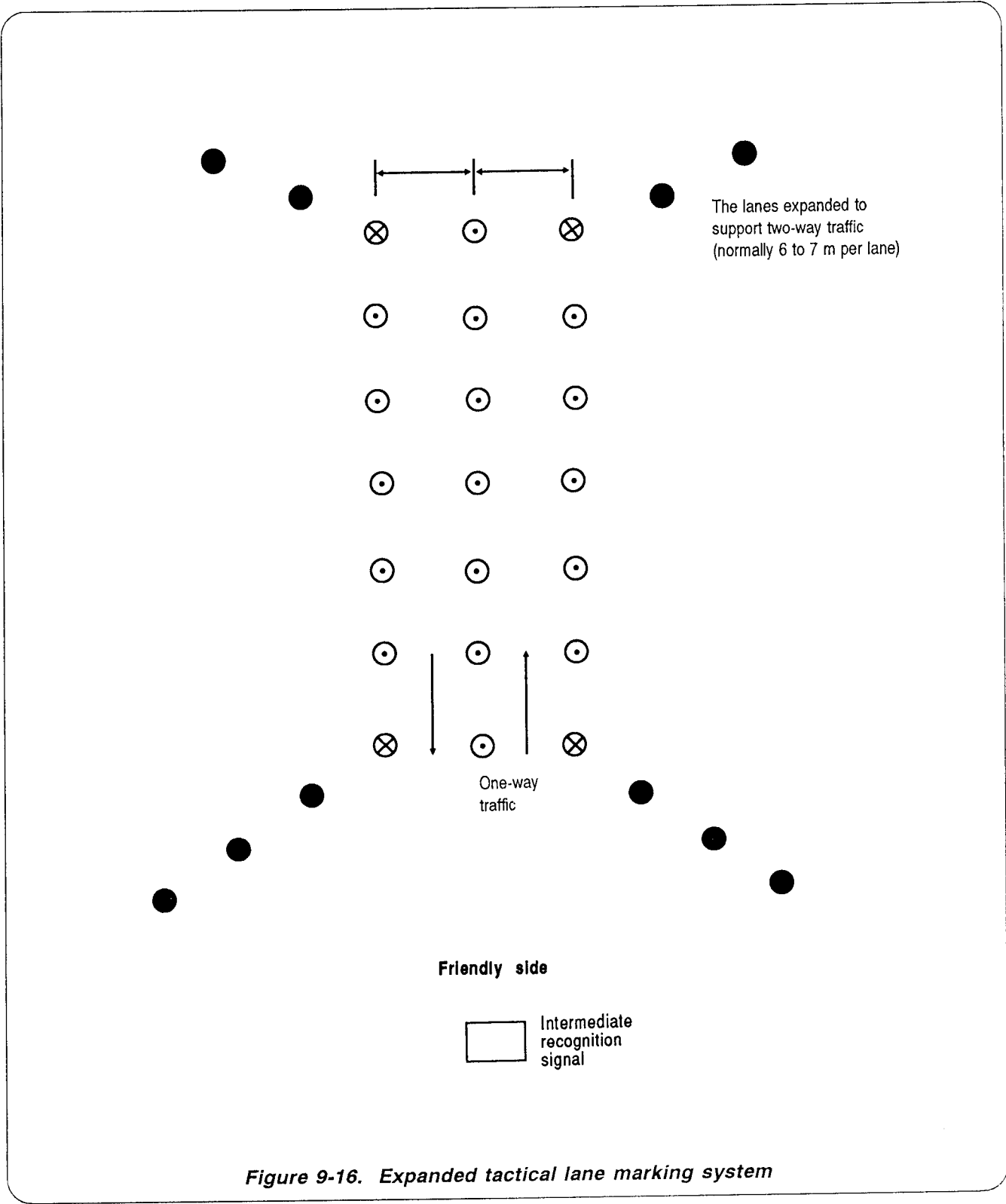

Figure 9-16. Expanded tactical lane marking system

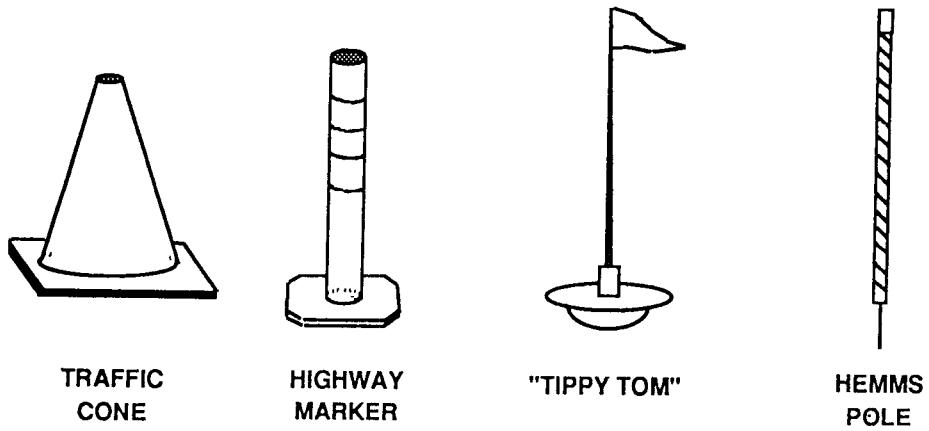

Figure 9-17. Currently available lane markers

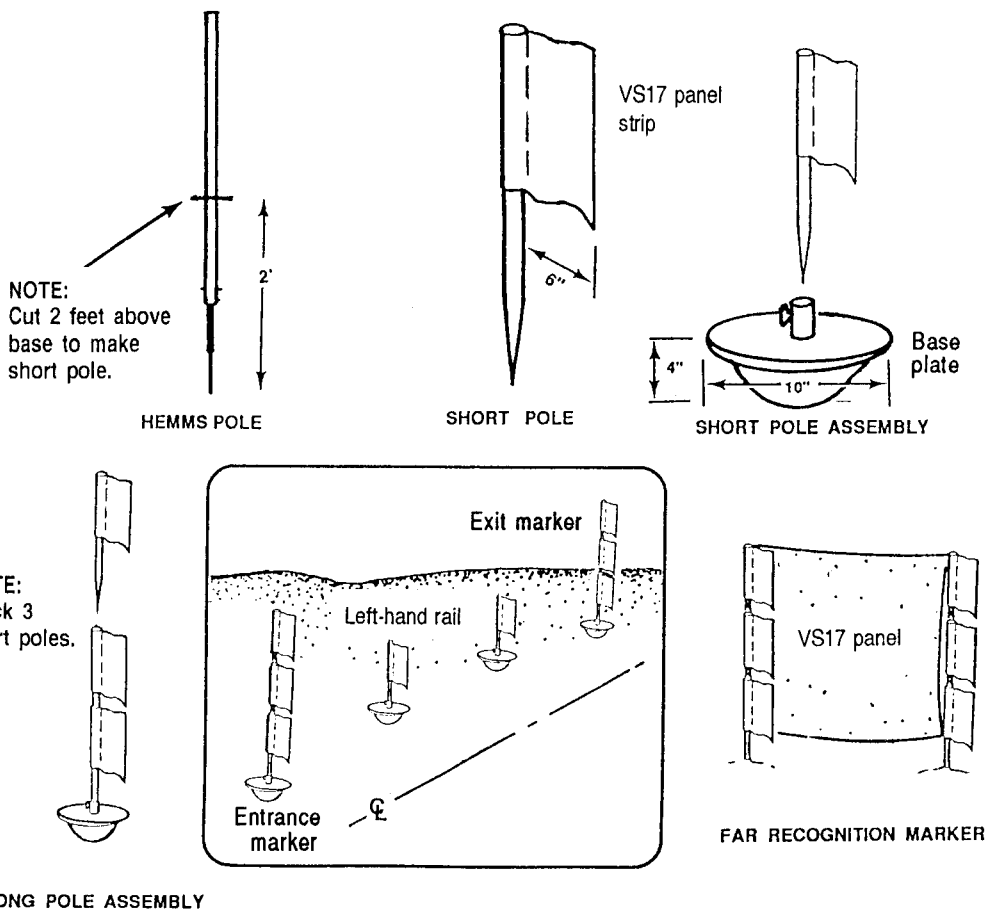

Figure 9-18. HEMMS and Tippy Tom marking combination

**Table 9-1. 23rd Armored Division tactical lane marking system**

<u>Marker</u>	<u>Day</u>	<u>Night</u>
Far recognition marker	TCP with 2 pickets holding 2 VS17 panels, orange side out.	TCP with green filter flashlights and four green filter flashlights across top of VS17 panels.
Intermediate recognition marker	Same as above, without TCP.	Same as above, without TCP.
Funnel guide markers	U-shaped pickets with inside U painted orange, facing friendly forces.	Place red filter flashlights on top of pickets, facing friendly forces.
Entrance/exit markers	2 U-shaped pickets with inside U painted orange.	Place 2 green filter flashlights on top of pickets on each side of the lane.
Left-side marker	Tippy Tom.	Green chem-light taped to top of Tippy Tom shaft.
Centerline marker	Highway marker.	White chem-light taped to top of highway marker.

**NOTE:** The division tactical lane marking system will be laid out as shown in Figure 9-15, page 9-18, and expanded to that shown in Figure 9-16, page 9-19.

**Table 9-2. 52d Infantry Division (Mechanized) tactical lane marking system**

<u>Marker</u>	<u>Day</u>	<u>Night</u>
Far recognition marker	TCP with 3 HEMMS long-pole assembly holding 2 VS17 panels, orange side out.	TCP with green filter flashlights and green chem-light in top of three HEMMS poles.
Intermediate recognition marker	Same as above, without TCP.	Same as above, without TCP.
Funnel guide markers	HEMMS, 6-foot-tall pole.	Red chem-light in top of HEMMS poles.
Entrance/exit markers	2 HEMMS 6-foot-tall poles with green flags on each side.	Green chem-lights in top of HEMMS poles, 2 lights on each side.
Left-side marker	HEMMS short-pole assembly "Tippy Tom."	Green chem-light in top of HEMMS poles.
Centerline marker	HEMMS short-pole assembly "Tippy Tom."	White chem-light in top of HEMMS poles.

**NOTE:** The division tactical lane marking system will be laid out as shown in Figure 9-15, page 9-18, and expanded to that shown in Figure 9-16, page 9-19.