



**A Librum
(<http://www.Librum.us>)
Hosted PDF.**

This file is hosted on the Librum website with the permission of the copyright holder of record.

The collection is hosted for the primary use of various help organizations located world wide.

The only authorized uses of this material is for these organizations, and for personal educational use.

The Librum

SOFT-TECH

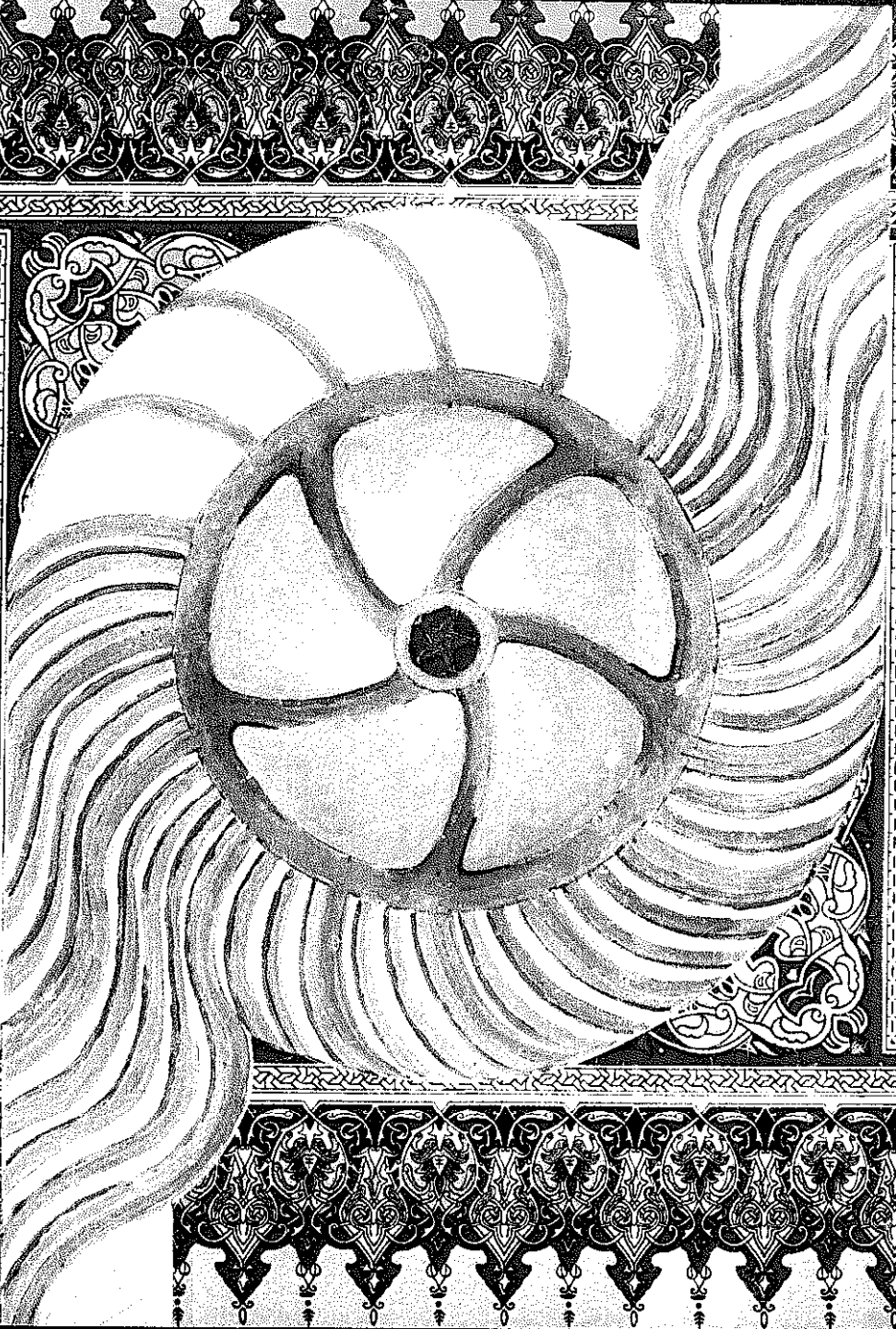

REVOLUTION BOOK

Edited by J. Baldwin
& Stewart Brand

Produced by the Whole Earth Catalog

\$5

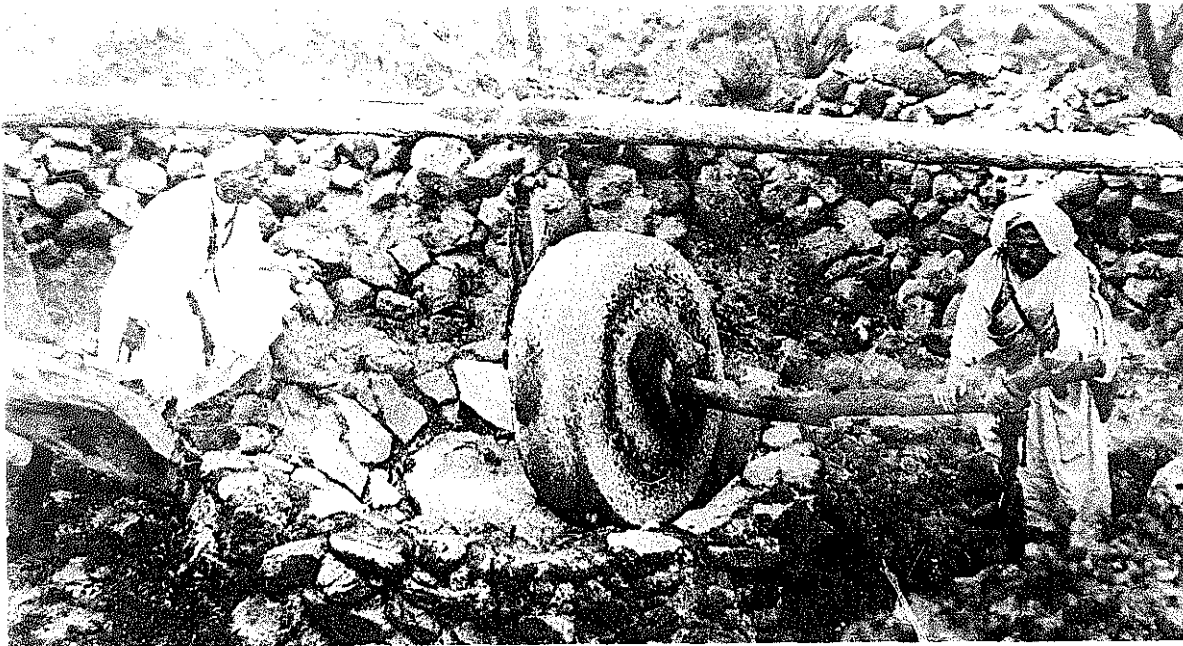

“Appropriate Technology”

A copy from a Spanish postcard of about 1915, shows a mill for grinding olives. The two gentlemen are Berbers who live in the Rif, in north Morocco, at that time under Spanish “protection.” It is my opinion that the underdeveloped countries see Appropriate Technology as in fact a “mill-stone.” It may seem quaint to us, as it obviously did to the Spaniards who sold, and bought, this postcard, but you have only to look at the face of the Berber on the right to see the truth. In fact the Rifis were engaged in insurrection against the Spanish from 1921 on. Only the intervention of the French postponed the inevitable date of independence till 1956.

THE OTHER DAY it hit me. The key. They always refer to it not as an appropriate technology, but as Appropriate Technology. The big A and the big T, sometimes AT. In simply altering a lower case to an upper case, we go from experience to belief.

The realization is not as obvious as it appears; it eluded me for some time. I was attending a meeting in Mexico City last year to discuss the role of appropriate technologies in the development of the poorer nations. About thirty people had been invited, and it soon became clear to me that, if not a schism, at least a serious division, was apparent among the participants.

An American, obviously taken with the Appropriate Technology argument if not himself an active member, described the aspirations of the people he worked with. Among other things he described their relationship to money as a concern with giving rather than getting. Now, in a Californian context this does make sense, and it certainly has a poetic ring to it. One can only speculate on the impact of such a statement coming from the richest country in the world on someone from “the other side of the tracks.” During lunch I was talking with a Colombian whose organization was responsible for encouraging the growth of small and medium-sized industries. He was puzzled by the American’s presentation. “What does it mean?” he asked me. “Do these people actually live without money; is this now possible in the United States?” Try explaining the idea of cultural secession to someone outside the United States or Europe, you will find it difficult

if not impossible. Yet it is exactly this kind of secession that forms one of the cornerstones of Appropriate Technology.

It is significant that the Appropriate Technology devotees in the underdeveloped countries are by and large financed by the Mother Country. Likewise visits by Appropriate Technology advocates to advise Third World bureaucrats are rarely financed by their hosts. What does this mean? Is this a new version of the White Man’s Burden? Is it still up to Us to show Them? Is this, as some Third World nations claim, a neo-colonialist trick? Has any underdeveloped country actually espoused Appropriate Technology on its own?

There are elements of a religious revival in Appropriate Technology. It is a strange melange of Marxism, Puritanism, and something called Buddhist Economics. To the pragmatic observer however, who is interested in solving problems, AT has little to offer. It is a movement that is long on polemic, and pitifully short on actual accomplishments.

— Witold Rybczynski

If AT is a religion, Witold Rybczynski is one of its founding saints. His Minimum Cost Housing Group at McGill University in Montreal put out The Ecol Operation and Stop the 5-Gallon Flush (which Peter Warshall called “one of the crucial books of the 70’s”), and numerous pamphlets on building with recycled containers. Here he is carping away like every saint in history long-lived enough to see his technique decay into a belief.

— Stewart Brand

SOFT-TECH

Edited by J. Baldwin
& Stewart Brand

 A Penguin Book

IT'S A NEW ERA, MAN!



I didn't believe in the alternate-energy future until I saw how dull it was gonna be and how stupid the slogans were gonna be and how much I wasn't gonna like it. Then I knew it would come.

— Steve Baer
Solar Inventor

CONTENTS

- 4-6 INTRODUCTIONS by *J. Baldwin (JB)* and by *Stewart Brand (SB)*
5 LOCAL DEPENDENCY by *Stewart Brand*
7 RAIN (Journal of Appropriate Technology) ■ Rainbook ■ Energy Primer (Revised and Updated)

Tools

- 8-17 ONE HIGHLY-EVOLVED TOOLBOX by *J. Baldwin*
17-21 Whole Earth Access Company ■ More toolbox ■ Experiences in Visual Thinking ■ Pump Flashlights? ■ Do-It-Yourself Plumbing ■ Aushalser ■ Garrett Wade Company ■ Devcon ■ New Equipment Digest ■ Foundrywork for the Amateur ■ Drafting Technology & Practice ■ VW prime mover ■ Theatrical equipment and supplies ■ The Procedure Handbook of Arc Welding ■ Handtool Handbook for Woodworking ■ The Oxy-Acetylene Handbook ■ How to Run a Lathe
22-23 *SMAIL TRACTORS* by *Richard Nilsen*
24-29 The Marugg Company ■ Farm and Ranch Supplies ■ Hopperdozer ■ Central Tractor Parts Company ■ Dictionary of Tools ■ The Good Neighbor Heritage Catalog ■ Iron Horse Antiques ■ The Living BASICS from the UN ■ The Cumberland General Store ■ Ways of the Sierra Madre ■ Guide to Hand-Operated and Animal-Drawn Equipment ■ Garden Way Cart ■ Appliance Service Handbook ■ An alternative technology equipment directory ■ Cloudburst 2 ■ Marks' Standard Handbook for Mechanical Engineers ■ Australian Traditional Bush Crafts ■ Dictionary of Scientific and Technical Terms ■ Sharpening

Invention

- 30-32 THE DOUBLE BUBBLE WHEEL ENGINE by *Steve Baer*
32-34 Zomeworks' products ■ Breadbox solar water heater ■ Nightwall ■ The Pro Heater ■ Sili Shutters ■ Skyliids ■ Beadwall ■ Solar Gravity Drivers ■ Skylight Water Heater ■ Sun Calculator ■ Drumwall and Water Heater ■ Sunspots
35-39 NITINOL by *Fred Gardner*
40-45 BUILDINGS AS ORGANISMS by *Day Chahroudi*

Solar

- 46-49 A-Z Solar Products ■ Solar Age Catalog ■ Solar Components ■ Solar hardware ■ Tuffak-Twinwall ■ Grumman Sunstream solar hotwater system ■ Serrande Shutters ■ Ecosol 101 Energy Recovery System ■ Solar Directory ■ Shurecliff's last catalog ■ Sun Earth ■ Solar Energy Society
50-51 THE CLOTHESLINE PARADOX by *Steve Baer*
64-65 SOLAR WATER HEATERS IN CALIFORNIA, 1891-1930 by *Ken Butti and John Perlin*
Solar Energy Thermal Processes ■ Enhanced Solar Collection ■ Pocket Solar Meter ■ Thermic Diode Solar Panel ■ California Solar Information Packet ■ Solar Age ■ Solar Energy Digest ■ Little arctic solar trackers ■ Alternative Sources of Energy
66-69 SUNLIGHT CONVERGENCE/SOLAR BURN by *Charles Ross*

Wind

- 70-75 Windcatchers ■ Wind Workshop 2 ■ Wind Power Access Catalog ■ Wind Energy Utilization ■ Here's an interesting bit of news from our Department of Energy (DOE) ■ Wooden wind-generator blades ■ North Wind Power Co. ■ Energy from the Wind ■ Wind Technology Journal ■ Simplified Wind Power Systems for Experimenters ■ This Is How You Can Heat Your Home With a Little Windmill ■ Gemini Synchronous Inverter ■ Design With Wind ■ Storage Batteries ■ Homemade Windmills of Nebraska ■ The battle axe ■ Food from Windmills ■ Windmills

Transport

- 76-77 CARS by *J. Baldwin*
78-79 Pedal Power ■ Le Truck ■ Without Wheels ■ A Model Used Oil Recycling Act ■ Auto Enthusiast Directory ■ Mopeds ■ EcoDog ■ Economy Driving
80-81 HOMESTEAD BICYCLE TECHNOLOGY by *Jim Burgel*
82-83 Bickerton Bicycle revisited ■ Bicycling Science ■ Bicycles in Shanghai Street

Penguin Books Ltd, Harmondsworth, Middlesex, England
Penguin Books, 625 Madison Ave, New York, NY 10022, USA
Penguin Books Australia Ltd, Ringwood, Victoria, Australia
Penguin Books Canada Ltd, 2801 John St, Markham, Ont, Canada L3R 1B4
Penguin Books (N.Z.) Ltd, 182-190 Wairau Rd, Auckland 10, New Zealand

Copyright © POINT, 1978. All rights reserved. ISBN 0 14 00. 48065.
Printed in the U.S.A. by Waller Press, San Francisco, California
First printing, March 1978 — 33,000

Except in the United States of America, this book is sold subject to the condition that it shall not, by way of trade or otherwise, be lent, re-sold, hired out, or otherwise circulated without the publisher's prior consent in any form of binding or cover other than that in which it is published and without a similar condition including this condition being imposed on the subsequent purchaser.

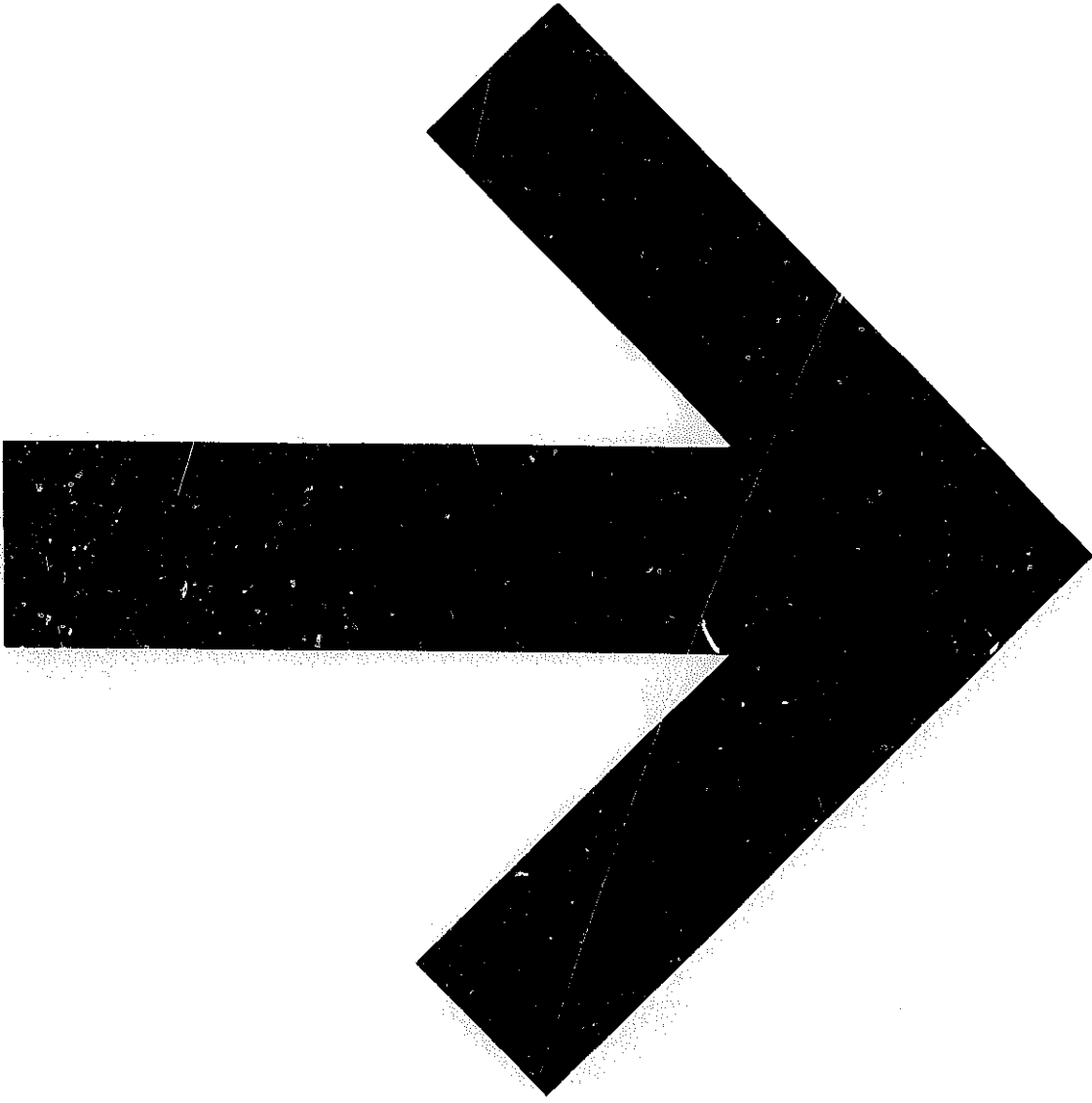

Cover By Greenman Cooperative, Taos, New Mexico, S.N. Durkee, proprietor. Steve is an old Soft Tech hand. At Lama commune near Taos he built two of the most spectacular 'zomes' designed by his friend Steve Baer. The Lama "Growhole" was an early development in ground storage of heat for winter gardening. The cover design is based on Naqshband geometry and a high pressure water wheel.

-SB (Stewart Brand)

Steam

- 84 Geothermal Technoecosystems and Water Cycles in Arid Lands ■ Coles' Power Models ■ Day-Land steam engine ■ Live Steam

Biofuels

- 85-87 Energy: The Solar Hydrogen Alternative ■ Methanol & Other Ways Around the Gas Pump ■ Methanol: Its Synthesis, Use As a Fuel, Economics, and Hazards ■ The Pegasus Unit ■ Pegasus revisited ■ Producer Gas from Davis
 88-89 THE GREAT METHANE BUBBLE by *Jim Burgel*
 90-97 BURNING WOOD by *J. Baldwin* ■ Wood Heat ■ The Woodburner's Encyclopedia ■ The Complete Book of Heating With Wood ■ Modern and Classic Woodburning Stoves ■ Stove Book ■ How to Install a Fireplace ■ Planning and Building Your Fireplace ■ Wood 'N Energy ■ Wood Stove Buyer's Guide ■ Wood Burning Quarterly ■ Wood Stoves ■ Blazing Showers ■ Mexican water heater ■ The Lorena Cookstove ■ A beautiful woodburning boiler ■ Pioneer Lamps and Stoves Co. ■ August West Chimney Sweep ■ Sotz Splitting Maul ■ The Stickler ■ A quiet chainsaw! ■ Sachs Dolmar Chainsaw ■ Crosscut ■ Crosscut Saw Manual ■ Losing Ground ■ Plant a Tree

Building

- 98-101 THE UNDERGROUND WORLD OF BALDASARE FORESTIERE by *Joseph Torchia*
 102-111 UNDERGROUND ARCHITECTURE by *Malcolm Wells*
 112-121 The Use of Earth Covered Buildings ■ Underground building ■ Development and Utilization of Underground Space ■ The Skylight Book ■ National Construction Estimator ■ Porous paving blocks ■ Ferrocement: Applications in Developing Countries ■ Inexpensive Evaporation Coolers ■ Adobe News ■ Mud, Space & Spirit ■ Homegrown Sundwellings ■ The Indian Tipi ■ Living in One Room ■ The Spacemaker Book ■ The Mariner's Catalog Volume 5 ■ Fredson Trailer Supply ■ Home Is Where You Park It ■ Living Aboard ■ Houseboat ■ Wind Vane ■ Nets ■ Grid Shells ■ Adaptable Architecture ■ Pneumatic Structures ■ Tent Works
 122-129 Barns, Sheds and Outbuildings ■ From the Ground Up ■ Farm Builder's Handbook ■ Ideas for All Around the Farm ■ Construction Manual: Finish Carpentry ■ Construction Manual: Concrete & Formwork ■ Illustrated Housebuilding ■ Designing Houses ■ The Green Wood House ■ Wood Handbook ■ The Timber Framing Book ■ Stone Masonry ■ Modern Carpentry ■ Country Comforts ■ In Harmony With Nature ■ Building With Logs ■ American Preservation ■ Old House Buyers' Guide ■ How to Rehabilitate Abandoned Buildings ■ Back to the City ■ The Owner Builder and The Code ■ Housing By People ■ Energy and Form ■ The Glass House
 130-131 INSULATION HERESY by *Richard Nilsen*
 132-135 The Solar Home Book ■ Solar Energy, Fundamentals in Building Design ■ An Introduction to Heat Pumps ■ Air powered pump systems ■ The Handbook of Moving Air ■ Architecture and Energy ■ Winona - towards an energy conserving community ■ Building Value ■ Concrete and Energy ■ The Food and Heat Producing Solar Greenhouse

Integrated Systems

- 136-139 THE TRANSFORMATION OF THE TRACT HOME by *Richard Nilsen*
 140-141 Solar building code ■ Energy Conservation Code Workbook ■ Your Home's Solar Potential ■ Good Shelter ■ Energy Basis for Man and Nature ■ Jobs and Energy
 142-145 METRIC SYSTEM CON by *Steve Baer*
 145-147 Boycott the Metric System ■ An Index of Possibilities (Energy and Power) ■ Ecodevelopment News ■ Appropriate Technology Sourcebook ■ Economically Appropriate Technologies for Developing Countries ■ Other Homes and Garbage ■ Radical Technology
 148-158 THE NEW ALCHEMISTS by *John Todd*
 159-165 LAUNCHING THE ARK by *J. Baldwin*
 166-167 FROM URGENCIES TO ESSENTIALS speech by *Canadian Prime Minister Pierre Elliot Trudeau*
 167-168 About New Alchemy ■ Ecotopia ■ Seriatim
 169 END OF THE BOOK
 170-174 INDEX
 175 Business
 176 Announcement of *The CoEvolution Quarterly*

.Abbreviations - CQ means The CoEvolution Quarterly. CATALOG means
 'The Last Whole Earth Catalog. EPILOG means The Whole Earth Epilog.
 .All three are published by the people who are publishing this book
 .and are described inside the back cover.

INTRODUCTIONS



by
J. Baldwin
(JB)

by
Stewart Brand
(SB)

EVOOLUTION makes many starts," is my favorite Bucky Fuller phrase. I like to think that the ventures shown in this book represent beginnings that are in the process of developing into new ways of integrating us and our environment. I feel a dreadful urgency in all this, and I think that many of the adventurers reporting here would agree. It's Earth miners versus Earth nurturers. If the nurturing attitude is to prevail, we had better get busy. But doing what? We started years ago with outrage.

After the wave of protest and doom books, a consequent wave of what I call "suppress" books appeared. Some of the phenomena to be suppressed turned out to be science and technology in general. Technological

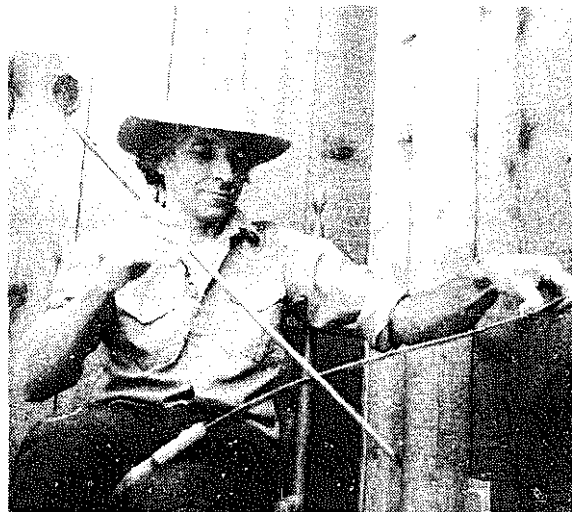

Brand

Editor Baldwin with a favorite tool — musical saw (Messehl & Westphal, \$20, capable of two full octaves.)

excess begat antitechnological excess. Fortunately, there are people who can think in terms of process rather than mere labels. They see a future in which technology is steered with an eye towards helping to make Experiment Earth a success. They see that we are going to have to learn how to live here in large numbers without trashing the place. Some have already made dramatic progress in utilizing technology to augment rather than oppose natural systems. Many hopefully evolutionary starts are actually being made.

There are people who champion a return to the ways of our forefathers, but this has not turned out to be much of an answer. Our grandparents were in many ways worse than ourselves. They sow forests endless and topsoil beyond measure. The wonderful Cape Cod House assumed an unlimited supply of

THIS may be a book for soft tech professionals.

It is certainly a book for soft technology professionals. Steve Baer of Zomeworks. John Todd of Now Alchemy Institute. Day Charoudi of Suntek. Witold Rybczynski of Minimum Cost Housing Group, Montreal. Underground architect Malcolm Wells.

And, not least, the gent on my loft, J. Baldwin, our soft technology evaluator since the Whole Earth Catalog began in 1968. Now 44, James Tennant Baldwin graduated from the University of Michigan in 1955 and did graduate work at the University of California, Berkeley. In 1952 he had the 8th Volkswagen in America. He first worked with Buckminster Fuller about that time. 1955-57 he was in the Ski Infantry in Alaska. 1958-62 with Bill Moss Associates working on such advanced camping equipment as the Pop Tent. 1962-68 he was teaching design at San Francisco State College (where I met him), San Francisco Art Institute and Oakland College of Arts and Crafts, simultaneously. 1968-69 of Fuller's invitation he was Visiting Lecturer in Design at Southern Illinois University. 1969-72 he was at Pacific High School teaching the kids and working with Lloyd Kahn on Domebook I and Domebook II. 1972-74 he worked with Bob Reines at Integrated Living Systems in New Mexico contriving a totally independent solar and wind energy system. In 1976 J. and his lady Kathleen Whitacre helped the Now Alchemists finish the renowned Ark on Prince Edward Island, Canada (see p. 160). Nowadays J. is with us, the Farallones Institute, the New Western Energy Show, the California Office of Appropriate Technology, and the Mew Alchemists again.

With his skills J. has never looked for a job. Work looks for him.

Thanks to the Energy Crisis of 1973 and other developments, work in those areas is looking for a lot of people, particularly ones who can integrate their skills in to an applied form of whole systems thinking. Wherever that happens it makes news. Considering that most of the pieces in this book are reprinted *CoEvolution Quarterly* articles, it is surprising how many are *still* news. The report on the astonishing properties of the "heat muscle" alloy Nitinol on p. 35 is still an exclusive scoop. The history of America's first solar technology boom, 1891-1923 (p. 52), has appeared nowhere else. And a previously unguessed structure of the solar year is revealed in "Sunlight Convergence/Solar Burn" (p. 661).

As for the book's title, "Soft Tech" is a term we've used and defended since the late sixties. It first emerged in Great Britain but then dropped out of

Local Dependency

One other little matter.

"Self-sufficiency is an idea which has done more harm than good. On close conceptual examination it is flawed at the root. More importantly, it works badly in practice.

Anyone who has actually tried to live in total self-sufficiency — there must be now thousands in the recent wave that we (culpa!) helped inspire — knows the mind-numbing labor and loneliness and frustration and real marginless hazard that goes with the attempt. It is a kind of hysteria.

The trouble is that self-sufficiency looks good and tastes good and gets swallowed whole — clear down into one's premise structure, where it becomes a design guideline. When a problem comes up, we check the various solution alternatives against the criterion of whether this solution will help make us more self-sufficient. And each time we make a mistake.

Because: self-sufficiency is not to be had on any terms, ever. It is a charm-

ing woody extension of the fatal American mania for privacy. "I don't need you. I don't need anybody. I am self-sufficient."

It is a damned lie. There is no dissectable self. Ever since there were two organisms life has been a matter of co-evolution, life growing ever more richly on life. Any "self" is strictly a term of convenience for one's mildly discontinuous local set of body and mood considerations. Any "privacy" is a temporary incremental respite from the big world. I cherish privacy, even live it, but so it's a bit of a jump to say how unbasic it is.

Now our poor rich nation wants energy self-sufficiency — a deadly stupid chimera. We nations all are in total dependency on systems which have no respect for national boundaries — atmosphere, oceans, ocean life, biotic provinces and our daily Sun, without which nothing. Cultural flow, language, economic flow — this stuff slows up at national boundaries and

probably should, but it never stops. To refute George Washington: "Life IS entangling alliances."

So, where does this come out for one's premise structure, design guidelines, and such? It would seem that the more fundamental statement is one of dependency. We can ask what kinds of dependency we prefer, but that's our only choice.

For example, is it preferable to be dependent on institutions we don't know, and which don't know us, or on people, other organisms, and natural forces that we do know? ... local dependency.

I'm betting that abandonment of illusions of self-sufficiency will free us to accept and enjoy local dependency, by preference.

And since our world is increasingly cultural, and proportionally ever less physical, the meaning of "local" is not geographic, at least not only.

—SB



Diana Fairbanks

Editor Brand in his favorite tool — a 16-foot Whitehall, built by Shew & Burnham, South Bristol, Maine. Not a bad commute to work, through the celebrated houseboat ghetto of Sausalito.

BRAND continued

fashion to be replaced by Alternative Technology (AT) and Appropriate Technology (AT). Recently the publication of Amory Lovin's landmark book *Soft Energy Paths* has helped revive the better language. "Soft" signifies that something is alive, resilient, adaptive, maybe even lovable. The other terms are administrative.

Governor Jerry Brown's aide Jacques Barzaghi recently quoted a Gregory Bateson remark — "There are just two kinds of people in the world. The cuckoos. And the administrators" Jacques said. "Gregory, I hope I will always be a cuckoo." Same here. And to help that here's a book of cuckoo technology. ■

BALDWIN continued

firewood nearby. Our predecessors wrecked the land and moved west to wreck some more. The westward movement has slowed a bit but the wrecking hasn't. Even the Native Americans did their share of damage. There are lessons in the past, but we shouldn't end can't go back. As a species, we're not doing so well in the present either.

So what do we do? How do we decide what to try next? One of the hopeful signs in this time of uproar is that we are beginning to talk about technology in a wider context. The Space Colony arguments are an example. Not too long ago there would have been no public discussion of such an enormous proposal. Also hopeful is that the discussions take in many aspects of the proposal rather than being confined to hard-were feasibility, I take this to be setting a precedent of public systemic thinking, something that we absolutely must have if we are to survive.

On the other hand the discussion is endlessly complex as all the nuances of special interest groups are given time at the microphone. All that talk can be paralyzing, yet it is a time for action. Much of the basic knowledge we need for action hasn't been developed yet. For instance, you'd think that after countless centuries there would be hard data for something so simple as the heat transfer rates of adobe, but it is only recently that such work has been done. There's a lot more to do. I call it "doing your homework." One of the more distressing aspects of the anti-tech movement is that it has tended to discourage doing homework. Ignorance IS bliss, but there is no future in it. Equally distressing is the number of projects undertaken by people of good heart who are willing to try new things but who also have not done their homework. The thousands of leaky domes are a sad example. Righteousness doesn't guarantee good results.

[more →]

BALDWIN continued

Doing homework can take many forms. /got into soft tech by reading dragsters! (In a previous incarnation, you may be sure.) /couldn't afford a 500 horsepower monster so I built a super light one with a tiny motor. Quite without intent, I had begun to think small; more-with-less. That same year (1955), I met Buckminster Fuller. It was a shocking experience to a callow 18 yea, old. He used the word "ephemeralization." Something in me was ready to hear that, and I began to turn my mechanical skills to projects with more redeeming social virtue than a fast and noisy quarter mile. Yet the dragsters had taught me how to use tools and bring dreams in to reality. Somewhere along the line /had begun to think more-with-less intuitively. I can't remember not thinking that way. It has prove" to be an appropriate mode of thought. More recently, I've begun to integrate a feeling for natural systems into my intuition. Just in time. I still hold high regard for those who replace iron with brains.

I don't know how the other writers in Soft Tech got into it; they are a pretty diverse crew. But I can tell you that they share some common traits. One is insatiable curiosity about virtually everything. Another is a willingness to risk all their money end time (and occasionally that of their friends) to see something happen that they think has to happen.

They all do their homework. They seem to work harder than most. None appear to be genius types, Their work excited me a lot. When we meet, there is much arm-waving end high-voltage exchange of information just in from the field. Most exciting of all, there always seems to be a force urging all of us to wards synthesis and in tegration. Lately, there has been a strong emerging idea that technology be used to facilitate and augment natural systems rather than oppose them. An example would be passive solar house design instead of glittering arrays of whirring hardware, however efficient. When I talk with John Todd at the New Alchemy Institute, ideas whiz around like machine gun bullets. My blood boils and it's hard to sleep. I hope that reading these accounts in Soft Tech will give you the same feeling of excitement and potential. I hope you will join the fray. It really is a new era, men.

This book has been arranged with only a vague linearity. It starts with the hard specifics of tools end materials end proceeds through various floppily

Some Utopia, Characteristics of Soft Technology (Robin Clarke)

'HARD' technology society	'SOFT' technology society
1 ecologically unsound	ecologically sound
2 large energy input	small energy input
3 high pollution rate	low or no pollution rate
4 non-reversible use of materials and energy sources	reversible materials and energy sources only
5 functional for limited time only	functional for all time
6 mass production	craft industry
7 high specialization	low specialization
8 nuclear family	communal units
9 city emphasis	village emphasis
10 alienation from nature	integration with nature
11 consensus politics	democratic politics
12 technical boundaries	technical boundaries set by nature
13 world-wide trade	local bartering
14 destructive of local culture	compatible with local culture
15 technology liable to misuse	safeguards against misuse
16 highly destructive to other species	dependent on well-being of other species
17 innovation regulated by profit and war	innovation regulated by need
18 growth-oriented economy	steady-state economy
19 capital intensive	labour intensive
20 alienates young and old	integrates young and old
21 centralist	decentralist
22 general efficiency increases with size	general efficiency increases with smallness
23 operating modes too complicated for general comprehension	operating modes understandable by all
24 technological accidents frequent and serious	technological accidents few and unimportant
25 singular solutions to technical and social problems	diverse solutions to technical and social problems
26 agricultural emphasis on monoculture	agricultural emphasis on diversity
27 quantity criteria highly valued	quality criteria highly valued
28 food production specialized industry	food production shared by all
29 work undertaken primarily for income	work undertaken primarily for satisfaction
30 small units totally dependent on others	small units self-sufficient
31 science and technology alienated from culture	science and technology integrated with culture
32 science and technology performed by specialist elites	science and technology performed by all
33 strong work/leisure distinction	weak or non-existent work/leisure distinction
34 high unemployment	(concept not valid)
35 technical goals valid for only a small proportion of the globe for a finite time	technical goals valid for all men for all time

Thirty-five characteristics and counter-characteristics borrowed from AD magazine (July '74) who borrowed the list from a book by David Dickson (we're still tracking it down) who borrowed the material from Robin Clarke, who...

defined provinces (I don't like compartments) to the stunning demonstration of systemic thought in the ARKS. Along the way is a selection of books and tools that I trust you will find useful. You may already have noticed there seems to be a lot missing that you'd expect to see in a Soft Tech book. That's because I've purposely avoided needless competition with those on our side who are already doing a great job. Thus I've left most energy matters to the new edition of the excellent Energy Primer and its superb bibliography, end just about everything else Soft Tech doesn't mention to the remarkably complete Rainbook.

What we are showing in Soft Tech is a 1978 still-shot of a continuing process that has been visible for maybe ten years. Many of the experimenters began work at about the same time the Whole Earth Catalog first appeared as a place for them to get together to trade information. The work not only continues, but is gathering momentum as the people involved begin to weave their knowledge into new combinations. What you see reported here must be pretty close to the state of the art.

RAIN (Journal of Appropriate Technology)

Dear Stewart, Andrea, et al C-Q,

I guess I just don't understand. You seem to be ignoring us, our work - RAIN, and now it begins to feel intentional. This is what I feel and I'd like to 1) open the dialogue as to why and 2) persuade you to acknowledge us and work with us beyond mailing list exchanges. . . .

—Lee Johnson

Good Lord, Lee, everyone here thought we'd reviewed RAIN long ago and enthusiastically - I swear I can see it on the page - but none of us can find it. To set matters straight, we use RAIN all the time as a research source, I consider your reviews usually better than ours, we feel comforting commonality with RAIN and praise it to our friends and our strangers, and I'll say as much in the Winter '76 CQ. Your poster's on a wall in the Gov's office. We admire your solar workshops. And I know how you feel about apparent conspiracies of silence. RAIN is good enough to be taken for granted, is what happened.

—SB

RAIN

(Journal of Appropriate Technology)

\$10.00 /year
(10 issues)

from:
Rain Magazine
2270 N.W. Irving
Portland, OR 97210

Energy Primer (Revised and Updated)

The original Energy Primer arrived in 1975, filling the need for an "alternative energy" workbook that was a step above the generalized overviews for beginners, yet not requiring a Ph.D. to understand. It replaced and obsoleted a whole shelfload of scientifically loose energy books that didn't offer much useful to people actually involved in developing hardware. Energy Primer was remarkably successful, and rightly so. It was so well done that no other book offered it serious competition. On the other hand, energy matters are subject to rapid changes, and the Primer was getting a bit long in the tooth. Hence this 1978 edition. As with the

first one, the new Primer has a very strong bibliography that contains even more specialized bibliographies. The best way to show you what's in it is to show the table of contents.

—JB

Energy Primer
(Revised and Updated)
Richard Merrill and
Tom Gage
1978; 256 pp.

\$7.95 postpaid

from:
Delacorte Press
1 Dag Hammerskjold
Plaza
245 E. 47th Street
New York, NY 10017
or Whole Earth

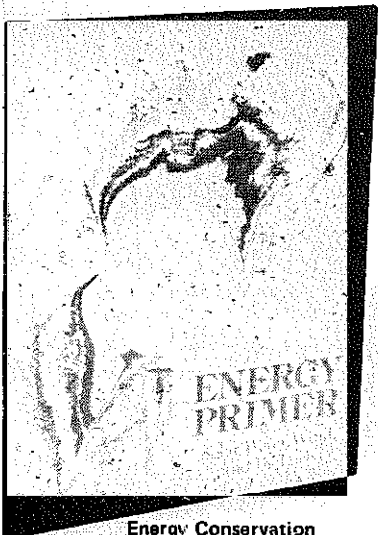

Energy Conservation

Energy and Its Conservation by Richard Merrill
Heat Pumps by Robin Saunders and Harry Whitehouse
Building Heat Loss by Michael Riordan
Energy and Conservation Book Reviews

Solar

Solar Radiation and Its Uses on Earth by John Yellott
Solar Availability: Quantitative Data on Solar Energy by Matthew Thekaekara
Photovoltaics: Process and Potential by Marshal Merriam
Photovoltaics: Economy and Politics by David Morris
Solar Book Reviews
Solar Hardware

Rainbook

The editors of RAIN bring you a finely sifted collection of what has proven to be good and useful in the baffling tangle of what's available. The sifting is done (as usual with this crew) by persons who are actually working with the subject of the review, giving a quiet honesty that permeates the entire Rainbook. There's also a refreshing emphasis on a sense of community development rather than the lone-home-steader-against-the-world: "let's work together" instead of "screw you." Makes you feel good just to open Rainbook anywhere and snoop around.

In the year that Rainbook has been with us, I'm finding that I use it almost daily either for my own information or looking things up for friends. That's the true test of a book of this sort; do you actually use it?

—JB

RAINBOOK

(Resources for Appropriate Technology)
Editors of Rain
1977; 250 pp

\$7.95 postpaid

from:
RAIN: Journal of Appropriate Technology
2270 N.W. Irving St.
Portland, OR 97210
or Whole Earth

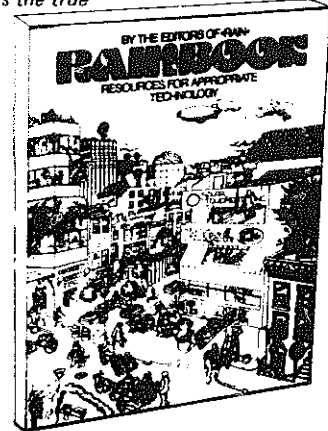

Solar Architecture

Solar Architecture by Michael Riordan
Solar Architecture Book Reviews

Water

Harnessing the Power of Water by Robin Saunders
Water Reviews

Wind

Wind Energy Introductions
Wind Driven Generators by James Sencenbaugh
Thoughts on Wind Driven Generators by Donald Marier
Recycled Wind Generator by James Bukay
Wind Book Reviews
Wind Hardware
Wind Research Groups

Biofuels

Biomass
Biomass Energy by Richard Merrill

Agriculture

Energy and Agriculture by Richard Merrill
Agriculture Reviews by Richard Merrill

Aquaculture

Aquaculture by Dominick Mendola
Aquaculture Book Reviews and Bibliography

Methane

Methane Systems: Principles and Practice by Ken Smith
Methane Book Reviews
Methane Bibliography

Alcohol

Alcohol As A Biofuel by Richard Merrill and Tom Aston
Alcohol Reviews

Wood

Wood For Fuel by Thomas Gage
Woodlot Management by Thomas Gage
Fuelwood Basics by Thomas Gage
Efficient Heating With Wood by Thomas Gage and Ken Smith
Wood Book Reviews
Wood Hardware

Integrated Systems

Practical Small-Scale Renewable Energy Systems by Energy Primer Staff
Integrated Systems Reviews
Energy Conversion Factors
Index

One Highly-Evolved Toolbox

BY J. BALDWIN

Our portable shop has been evolving for about 75 years now. There's nothing really very special about it except that a continuing process of removing obsolete or inadequate tools and replacing them with better ones has resulted in a collection that makes trying out ideas uncommonly easy. It's a generalist's shop; we're not equipped to produce fine cabinetry. We can work any common material. It is orderly enough to permit others to find things, but it stops short of constricting anal neatness. It enables things to get done with less hassle, and so more gets done with less hassle. We "see it as a three-dimensional sketchpad.

We mostly shop Silvo and U. S. General. Their prices nearly always beat local stores even when you add postage. Sometimes the savings are dramatic. You should compare these catalogs with each other and with Sears to get an idea of what you are saving. There's nothing more annoying than sending away for something that turns out to be cheaper a block from your home. The mail order places have a larger selection than local outlets. More esoteric tools can be found in the always-tempting offerings of Brookstone, Garrett-Wade, and other specialty houses. (Only lack of funds keeps me from going bananas ordering things) Check your Whole Earth Catalog, Epilog, and past CO's for other sources. Most mail order places accept returns gracefully.

For faster service or for items awkward to ship, hit the nearest big city wholesale hardware and industrial supply houses. They usually will only sell wholesale so you'll have to work out something. It can be very frustrating to have to pay 40% more for something than it is worth. Behind the wholesale curtain, we call it. A contractor's license helps Here are some addresses. I wish you luck in acquiring the money to use them.

— JB

As thing-makers, tool freaks and prototypers, Kathleen and I find ourselves custodians of about a ton of versatile hand tools. These have been used by us and friends over the years to help many projects and repairs get done. People keep asking us what tools to get, where to get them, and how to keep them from getting ripped off. Well, here goes.

Stand in Sears Tool Dept. and it'll soon be obvious that you don't need one of each even if you have the money. Ask a craftsman what to buy, and you'll get as many answers as people you ask, for each has their own favorites and specialized needs. They'll all agree on one thing though: BUY THE BEST YOU CAN. And the more a tool will be used, the better the quality should be. Tools used every day, especially electric tools, should be of commercial or production line grade. You usually can't find these at hardware stores. Industrial supply houses are where to go. Take a friend who can buy wholesale. These tools will be expensive, so we'd better justify the cost.

For many, the best reason to go first class is that good tools are a real pleasure to use and handle. This helps make work less labor. The heavy duty stuff looks brutal. It wasn't made to look good in the box, it was made to do the job and has been perfected over many years. The tough ones have their own kind of beauty that you'll see better as your viewpoint gets aligned with reality. Such tools, of course last longer and are repairable when they finally do wear. They can take a lot more abuse, especially the inevitable overload. They can handle the bigger jobs and poor working conditions that would soon trash cheap versions. And after a few years in your hand, they often get to be old friends.

For tools that get used now and then, middle quality will do. By that I mean Sears better grades and no lower. Really cheap tools are of no use at all, can

Brookstone Tools
Catalog

\$.50 postpaid
from:

Brookstone Tools
Department C
Brookstone Building
Peterborough, NH 03458

Garrett Wade Co.
Catalog

Free (\$1.00 first class.
Send a buck anyway.)

from:
Garrett Wade Co., Inc.
302 Fifth Avenue
New York, NY 10001

Woodcraft
Catalog

\$.50 postpaid

from:
Woodcraft Supply
313 Montvale Avenue
Woburn, MA 01801

Silvo
Catalog

\$1.00 postpaid

from:
Silvo Hardware Co.
Dept. "EC"
107 Walnut Street
Philadelphia, PA 19106

U.S. General Supply
Catalog

\$1.00 postpaid

from:
U.S. General Supply
100 Genera, Place
Dept. WE
Jerico, NY 11753



BOSCH TOOLS

Note how this drill fits my hand: putting my weight directly behind the bit. It's the only drill we've seen where your hand doesn't cover cooling slots. Smooth and super powerful, these drills last a long long time. They are also double insulated which makes them a lot safer, particularly outdoors

The Bosch jigsaw is merely the best there is. Ask anyone who has used one. My only regret is that I waited 5 years to get one, and made do with a poorly designed domestic commercial grade machine whose bearings failed regularly and whose handle soon got too hot to hold. (Sears best grade jigsaw is more versatile but not as high quality.)

be dangerous, and often break the first time you use them. They are also discouraging to use, which might even cause a beginner to give up. Our only regrets have been not buying the best when we could have.

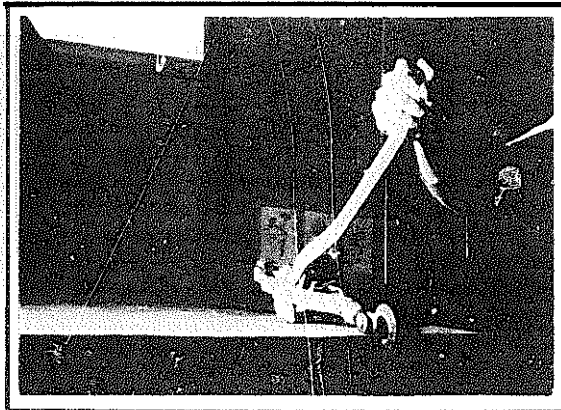

COME-ALONG

It's surprising how often this thing gets used if you're living in the country. Lifting engines, "battening down," unsticking cars in the mud, dragging loads into trucks, straightening sagging sheds, stretching fence, moving things over just a little . . .

Tools that receive great strain, such as gear pullers, should be super top quality only. If you only need one every five years, rent it.

OK so what tools do you need? How do you start the stash? There are a few basic tools that everyone should have available: Hammer, crosscut saw, adjustable wrench, pliers, screwdrivers (get a set), tape measure, hand drill and bits. Beyond these, you'd best gather tools as you need them. Auto work will require a rather complete set of wrenches and a whole boxfull of special tools, some of which are for particular vehicles. Carpentry will require another whole group: planes, chisels, etc. Electrical and plumbing still more. Our rule of thumb is if we need to borrow a common tool more than once, we buy one.

Fleamarkets are a good place to look for expensive items like vises or anvils. Absolutely the best place to get a whole mess of tools at once is to keep alert for a widow selling off her deceased husband's retirement shop. Another place to look is auctions, but you'd better know what you're doing. You should shop around. Recently in the Bay Area, we were quoted prices varying 50% on a tool we wanted! If you want to buy a bunch all at once, (which makes sense these days of inflation — tools are a good

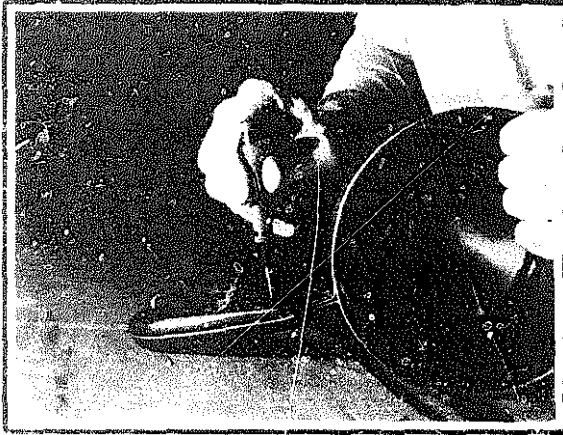

AUTO PUNCH

Instead of having to beat on this punch with a hammer, you just press it. The spring is adjustable, making it ideal for fine work and sheet metal layout.

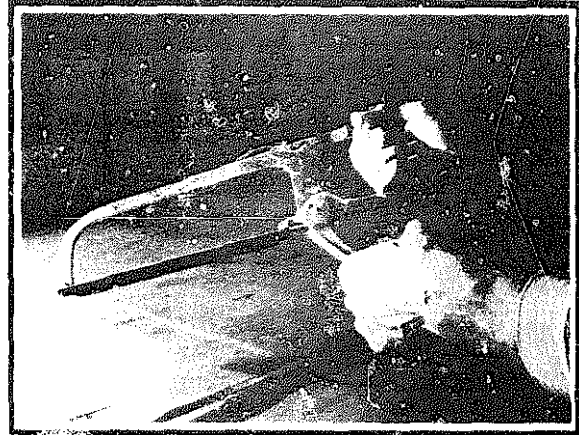

MILLERS FALLS HACKSAW #300

Lever makes blades super-tight in seconds without diddling little wingnuts. Blades last longer, and you can change blade type and position easily too (and thus do) and things go much better.

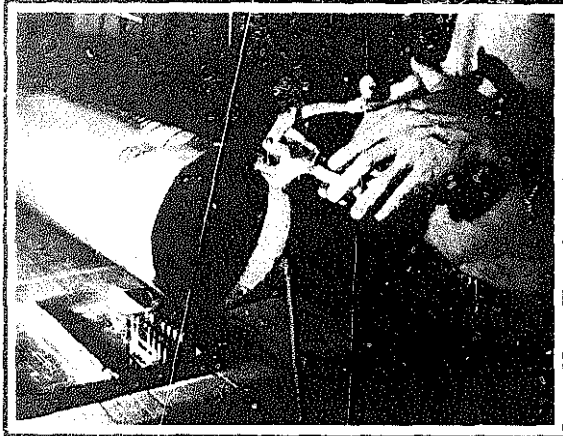

WHITNEY PUNCH

A fine punch set that can handle heavy leather and sheet metal. We use it a lot in conjunction with the Popriveter.

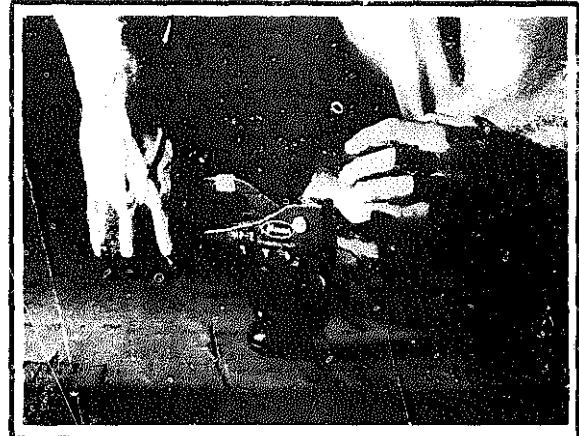

POPRIVETS

We use Poprivets for lots of things. Especially good for repairing sheet metal (as in car bodies) where welding isn't practical. They'll work in leather, Masonite, plastic, too.

savings account), some stores will make you a 20% deal. Even Sears can be dealt with, as the sales people work on commission. They and other stores also have unadvertised freight-damaged goods hidden away. These can be good deals, as the damage is often merely cosmetic. You can give a salesman your name (and take his card) and have him call you when a certain tool is on sale or arrives damaged.

Whether in a Big Store or private sale, you should critically inspect each tool for condition. These days, many new tools by reputable (?) manufacturers are faulty. Used ones may be worn beyond repair. Anyway, be picky about it; you'll be living with it in your hand. And beware of package deals claimed to be a great saving. The "complete mechanics tool set for \$450.00" often includes tools you don't need, and may force you to take inferior items that you would be better off picking up individually.

What do you do about that little voice that whispers. "Buy one, you might need it someday!" Well, it's possible you'll be needing them all someday, but Sears is only the tip of the iceberg. Have you ever seen a real hardware catalog? 2000 pages? On the other hand, if often does pay to get a set of tools that greatly increases your capability, such as a welding rig. Another way to go is for a group to buy a Set of tools for working on one particular item, such as old Chevy 6 engines, and then everyone in the group that needs a vehicle gets one that uses that engine and hence those tools, and the consequent parts pile. (That's being done around here. There must be dozens of 56 Chevy pickups and flatbeds within 30 miles.) Some groups get known for specialties: "the Butterfly Mountain people fix tractors." Those communities and families pool their resources and buy a set of expensive heavy duty tools maybe for tractor repair. You have to be pretty

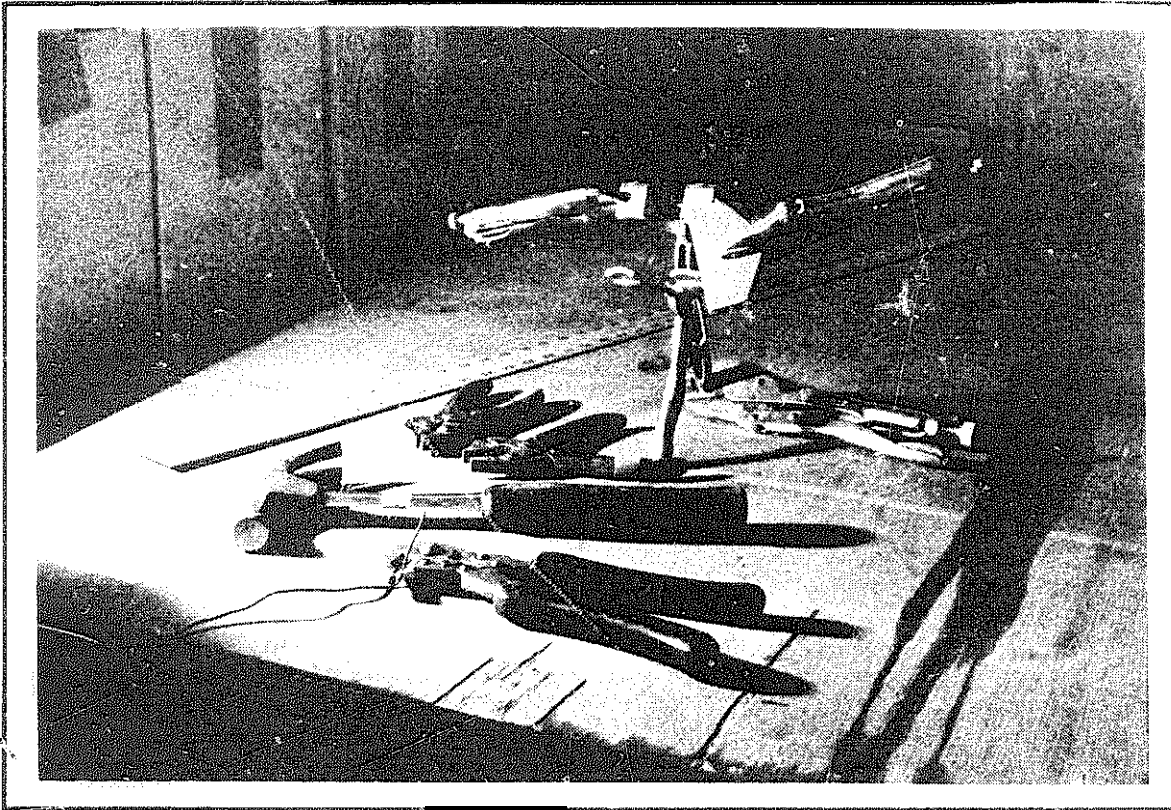

BIRDHEADS (Sometimes called "Parrot")

If you do a lot of work with heavy wire, these are just the thing. Compound levers let you snip through most wire like it wasn't there. Nose makes working overhead easy.

4 FOOT RULER

If you work with plywood or 4x8 anything, one of these will save you lots of time and grief. NB Some new plywood isn't 90° square!! Check it always. Best rulers have etched numbers.

STEEL HANDLED HAMMERS

Steel or fiberglass may not be as aesthetic as wood, but the heads don't fly off when dry weather shrinks the handle. Violent nail pulling won't break them either. Pro carpenters don't like them, claiming that they eventually injure elbows if used every day.

VISEGRIPS

Buy these by the genuine name Visegrip. They come in an array of sizes and jaw shapes, allowing you to grab what you see with a grip strong enough to crush things. Handy for undoing old rusty machines, and as a portable vice for welding, etc.

"BERNARDS"

Pliers whose jaws work parallel (there's a nifty wire cutter too). We often use these in pairs for twisting and shaping small parts, and glass breaking. Our most pilfered item too; we've lost a dozen pairs. I can see why.

mellow to make this work, especially if there is a high turnover of people. But this is a growing trend, and we think a good one. It leads to barter and lessens the need for duplicate sets of specialty equipment.

Our shop is known for its versatility. It's portable; everything fits a 4x5 U-Haul trailer. It's been set up in ten different places in 5½ years. The tools were chosen for quality and versatility. With versatility goes a handy ability to work in harmony with other tools, enhancing all. For example, with the drills and vises we have, we can drill a hole at any angle in just about anything. The combinations allow us to easily mass-produce parts like dome struts or Inkleloom frames. This gives a nice potential for making

money as well as greatly easing tasks that might be as bad as working in Detroit. Versatility also means needing fewer tools which means less money out, less space for storage, and less tools to keep track of.

For many people, the biggest problem with tools is keeping them together. That was our problem too for awhile, especially at Pacific High School where there were always a number of young people who didn't yet see that tools are in a different category than other possessions. Our answer has been to take the time to try and give people a good feeling about tools being extensions of their own hands, and that tools are the means to getting good shelter and other desirable results. A French poet (whose name I

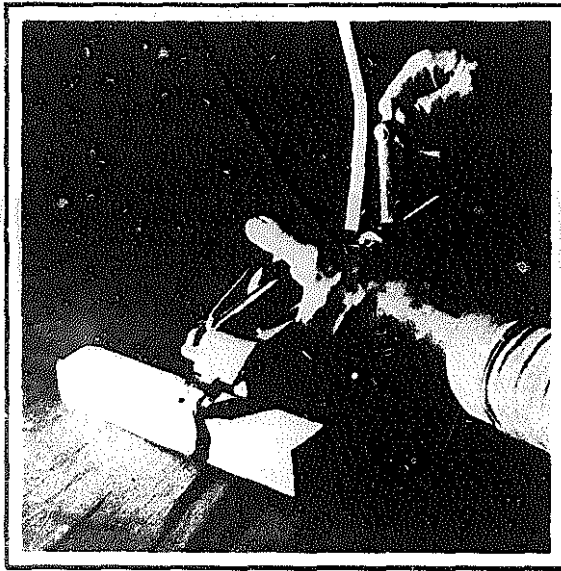

BANDIT

Designed for making hose clamps on the job, this tool can be used for banding just about anything with a variety of band sizes and metals. This was used to make dome hubs (See Domebook 2), band concrete forms, secure crates, make barrels, extend tipi poles, repair broken spars on sailboats, reinforce porch railings, etc., etc.

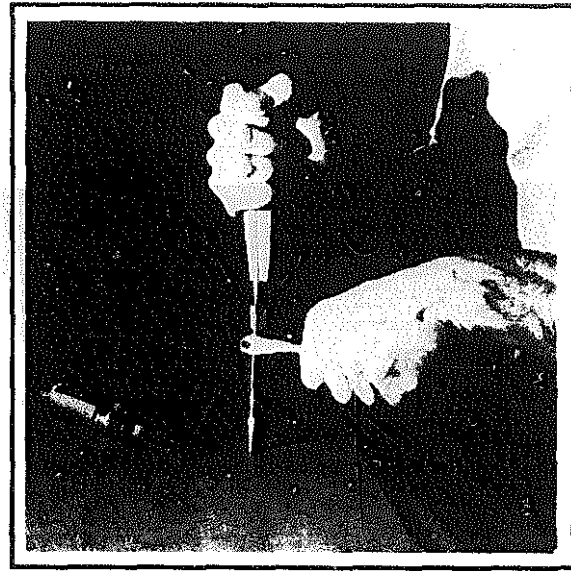

FAT SCREWDRIVERS

Big handles, heavy blade, compact size, make Sears #41586 and Irwin our favorite screwdrivers. Square shank allows help with wrench. You can't own too many screwdrivers, as they grow legs easily, and there are so many screw sizes.

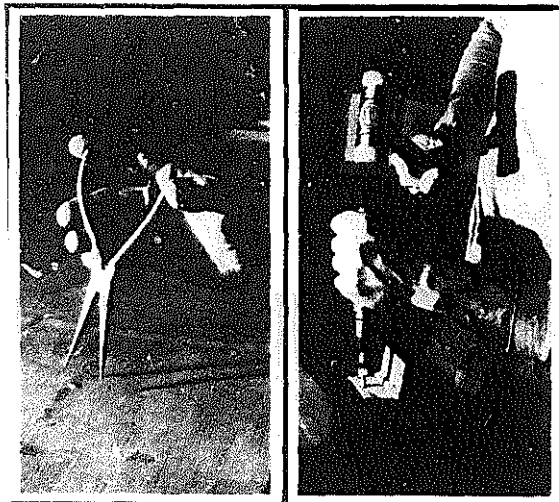

NEEDLENOSE PLIERS WITH SPRING (left)

The spring and delicate jaw shape permits very delicate nabbing. You can actually pick up a live ant without damaging it (physically, anyway).

IMPACT DRIVER (right)

(Craftsman #9 GT 47634) This works like those air operated tire wrenches in garages except the power in this case is your hand. This tool is often the only practical way to loosen rusted screws and bolts on older machines. Wear goggles and gloves while using. Comes with several different bits and can be used with air drive socket wrench sockets too.

Not pictured

GLOVES & GOGGLES

The goggles save your eyes. The gloves (leather) save your hands and let you add double power to screwdrivers and snips. (I should be wearing goggles in these posed photographs.)

TEFLON COATED SAW

Disston crosscut saw slices through green 4x4's and plywood with uncanny ease due to coating. Ours still looks good after 5 years. These saws play nicely with a bow too. Crummy handle can be sanded to a better shape.

regrettably can't remember¹ said, "Hammers spend a lot of time sleeping. ." We like to see the tools at work. We show people how to use the tools and encourage them to in turn show still others how. Having good tools in the hand, together with that tasty feeling that comes from teaching somebody else, gives the tool borrowers a respect for the whole bit.

We also have all the tools marked with a colored stripe. This not only reduces arguments on job sites where lots of people's tools are at work, but it makes it easy for people of good heart to return strays. We put out the word: "Bring a blue stripe tool to breakfast" and we round 'em up. We also ask that tools be brought back at sundown unless needed that night. There's a place to bring them back to. This is essential. A casual pig-pen shop just can't keep its tools because there "isn't any there, there." As an experiment, we

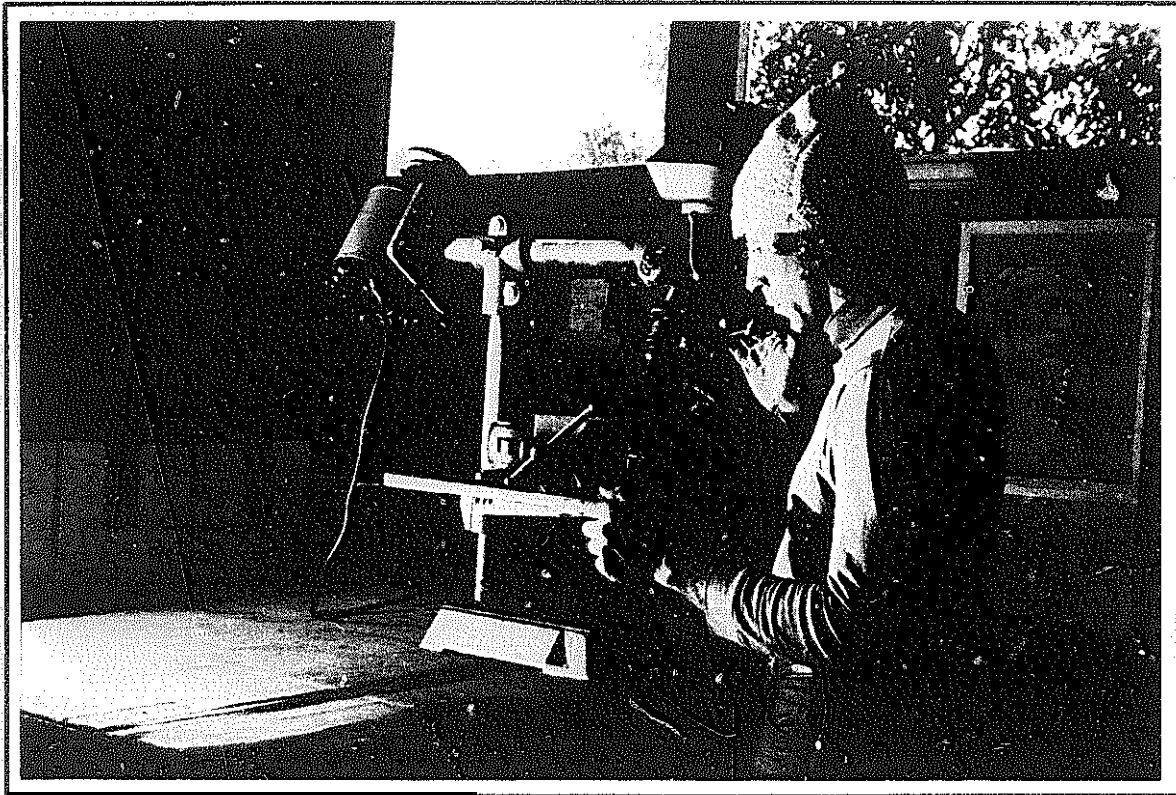

ROCKWELL RADIAL DRILL PRESS

Our most-used tool, bar none. This 1/2-inch drill can extend to drill a hole in the center of a 32" circle, and can swivel out to drill big things sitting on the floor. It can drill at any angle, including horizontal. Though not of machine shop accuracy, it will do 99% of the work most people will ask of it. Radial feature costs extra and is worth every penny. You clamp the work down (we use a Versa Vise) and bring the drill to it at the desired angle. We have it mounted on a box that holds accessories and brings typical drill table height to that of other shop benches so we can support long objects being drilled. Dependable too: no repairs in 14 years. It's light enough to carry to a big job.

VERSA VISE

These wonderful vises can stand up, lay down, swivel, and come with a clamp base that you can take to the job on the third floor. We have two, and a number of bases (one on the drill press table), allowing us to grip just about anything you could name short of a dead sheep in any position. They can be used as clamps when removed from base, a 1-second operation. Come with pipe jaws, too. Not for heavy metal work or heavy pounding.

abandoned our collapsed old bureau toolbox and bought a (freight damaged) Sears (the best for the money) rolling mechanics tool chest like you see in big auto shops. We segregated the tools by function and labeled the drawers. The result is that tools are easily looked over and selected and just as easily put to bed. To our great surprise, we found that this chest caused a drastic increase in the number of tools being used and a similar increase in action. We even found that we were using our own tools more! The neat storage made it easy to see who was missing, but people brought them back much more reliably than before anyway. The chest can be locked to control unannounced borrowing which is always a disaster. The overall effect has been that under very poor risk conditions, both sociological and physical, we've only lost about \$50.00 worth of tools in 7 years! And this without having to yer too heavy or "high school

shoppish" about things. In case you wondered, we did try the toolboard-on-the-wall. It didn't work, and nobody we know that's tried it has made it work either, though it is nice to see all those tools hangin'. It has not been necessary to sentence anyone to being tool crib librarian either. We'll admit that it takes some time to develop tool-consciousness in a crew, but it can be done, and peaceably. The tools spend a lot less time sleeping ton.

Making a deliberate effort to raise your own tool-consciousness can result in some interesting new possibilities in your life. As with most mysterious-appearing phenomena, a bit of learning soon clears things up and you wonder what had been previously keeping you from doing your own repairs and thing-making. Sometimes all it takes is a different point of view. I've remarked that tools are extensions of your hands.

No mystery there; a hammer is just a hard fist; a screwdriver, a tough fingernail. But hands usually operate according to instructions from head, so it can also be said that tools are an extension of your mind. Looked at this way, the big (expensive) mechanic's cabinet with all the tools of similar function stored together with high visibility becomes even easier to justify. I find it is effective to store the tools by function rather than by name because this is the most useful way to think of the best tool when you are selecting. Hitters, grabbers, slashers, abraders — regardless of what they are called, are there in their places. You take your pick. Often, just looking at them will give you a better idea not only of what tool to use, but how to do the job or how to design the object. That's a big advantage of the neat toolbox. If the tools are "somewhere out on the back porch or maybe in the back seat of the VW" then your mind is deflected from creative thinking into a hunting mode, and the aggravation can easily cause you to lose your ability to get things done.

Easily accessible, functionally sorted tools also give you a ready familiarity with the tools you have. This has two effects. First is that as you get to know your tools, you gain the easy fluid motions that go with using them. You're not afraid of them any more, though respect is increased. This makes you able to work faster with less fatigue just as good form in sports often makes a big difference. It makes you safe, too. Safety is also enhanced by having the tools where you can easily inspect them for condition, sharpness and rust. We have found that Safety is largely a matter of attitude. The closer tools are to being a working extension of your mind, the safer you'll be. Self-preservation.

The second effect is that you get to "know" all the tools you own without having to consciously think about it. This makes it simple to round up strays, of course, and it's easier to see where there are annoying gaps in your capabilities ("we don't have a lightweight mallet"). More importantly, you begin to think in terms of the tools you have. The eventual result is that you and your entire toolbox and shop become a big, complex tool with many possibilities. You begin to sense what you can do together. Buying tools with overall flexibility of purpose in mind, keeps you from falling into the trap of building a one-function capability with accompanying tendency to conservatively fossilize your creativity. This tendency is strengthened as the value of the tools rises, which is the main reason society doesn't get fast response to its changing needs from large corporations who have sunk enormous capital into shops that make that only. Like fat cars. Once in that position, it's difficult to evolve at all, let alone without damage or drastic change of form.

So you begin to build your tool capability into the way you think about making things. As anyone who makes lots of stuff will tell you, the tools soon become sort of an automatic part of the design process. Beginners worry too much about skill and safety, rather like new drivers worry most about

jerking the clutch when learning to drive a stick shift. It doesn't take long before more serious aspects take over, and the manipulation problems fade out. But tools can't become part of your design process if you don't know what is available and what the various tools do. In addition to buying tools that I find useful, I spend some time reading catalogs so as to become familiar with tools that I can't afford or don't need at the time. Tool catalogs such as Silvo (CATALOG p.140) are rather like my cabinet in appearance so I find it painless to sort of automatically file the information away in the back room somewhere. Tool dictionaries, especially of older tools, are helpful too.

Some of you are saving about now, "Who wants to get into it that far anyway?" Friends, there are advantages. Obviously, making or repairing things yourself can save you money and time. Well, maybe it isn't so obvious. Example: next time your car breaks down, find out how many hours it will likely take to fix it. You don't have the time, right? OK, how many hours will you have to work at some job so you can pay that mechanic? For many of you, the hours you have to work to pay the mechanic will be more than the job would take if you did it yourself. Moreover, you don't have to pay yourself, and the job can be done to your standards and at your convenience. If you don't have the skills or the tools, that's what we're talking about! Doing it yourself can free you from certain dependencies

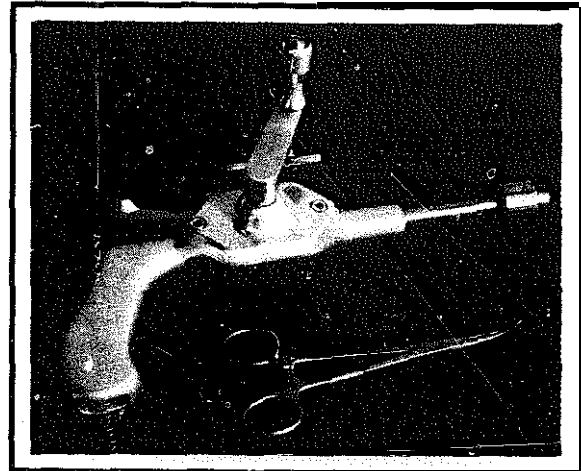

SURPLUS SURGICAL TOOLS are often ergonomically excellent and are useful for precise work. Bone surgeon's drill and this hemostat aren't really absolutely necessary in your shop, but are very satisfying to use. (Hemostat from Brookstone, CATALOG, p. 142.)

that you may find smothering. What if the \$20.00/hour plumber can't come until next Friday? Repairing pipes is relatively easy. Once you learn how, you not only avoid being at someone's mercy, you have a skill that can help friends or make money for you. How-to books are tools, in case you haven't guessed.

Another advantage of having some tools that you know how to use, is that as you get an easy, facile

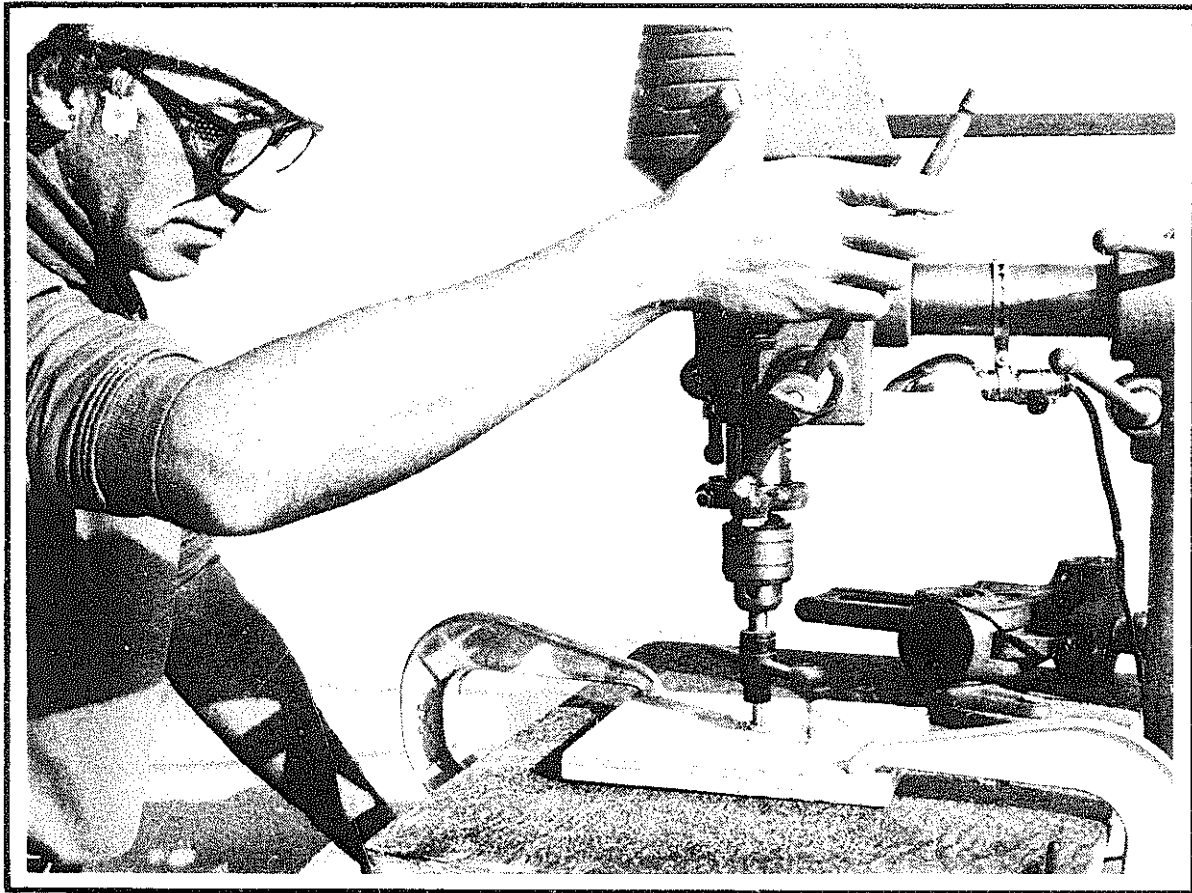

HOLE CUTTER making piston discs. I have a small town phonebook in my shirt just in case something lets go. I've picked metal out of it twice. It doesn't take a Ph.D. thesis to tell you that certain tools require a

certain caution. Be extra careful as you go through the super-cool, smarty-pants phase of tool familiarity. Except for rare freak accidents, few tools will cut things that you don't deliberately feed them.

familiarity using them, you begin to yet a better feel of the ergonomics of other techno-hardware that you use or make. (Ergonomics is the man-machine interface; how the steering wheel feels in the hand anti how it tells you what's happening to the wheels; the wrist-breaking poor feel of eggbeaters; the built-into-you feel of a good rifle). Poor ergonomics is one of the main reasons behind the recent public disenchantment with technology. Things are made with the convenience of the machine in mind instead of the human user. The result is hardware that is hard to hold, too cold or too hot, difficult to repair, easy to lose or lose control of, easily broken, etc., etc., etc. The machine is in control of you instead of the other way around. You can do better, yes? Most highly evolved good quality tools are ergonomically good. (Rifles are tools. You peaceable types can put down your neck hairs, it was only an example.) So without having to take a course in the subject, you can gain an informed feel of what is satisfying. As with most problems brought to us by technology, ergonomic problems are often best solved not with more technology but with clear thought and a better-informed intuition,

An informed tool intuition works best if it's augmented by an informed materials and processes intuition. For instance, if you don't know anything about foundry work (casting), it's unlikely that you will come up with ideas that require it. Often, this ignorance (ignore-axe! is easily remedied. A bit of inquiry may well show that what you had considered a black art is actually not one at all. Bronze and aluminum castings, for instance, are made every day in high school art departments by unskilled students using scrap metals from auto wrecking yards. Anyway, things take a form dictated by the possibilities inherent in the material to be used and the tools that can shape it, and the ideas in the head of the worker. It follows that the more you read, and snoop around and experiment and practice, the easier it will all come and the more independent you can be. Freedom rising.

The ultimate is to make your own tools. Tools fitted intimately to you by you. What could be niftier? Blacksmiths are really into that. A good example is found in the books by Alexander Weygers (EPILOG p. 548). But tools need not be limited to

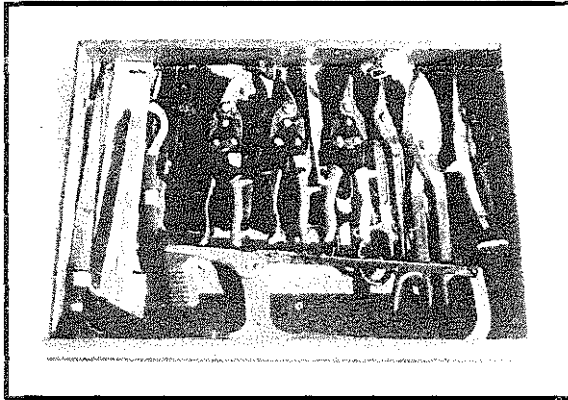

SAWS AND SNIPS DEPT. Don't get hung up on tool names. "Tin snips" can cut lots of other things such as leather. The three identical-looking guys are "aircraft snips" and they aren't identical at all. The yellow handled ones cut straight; the green handled ones cut righthanded circles or curves and are just the thing for lefthanded people; the redhandled ones cut left as you might expect.



To test several schemes for a **SOLAR HOT WATER HEATER**, we're making up a number of identical new 5-gallon cans and covering them with a variety of heat-retaining skins. Then we'll race them. To have these made for us would not only be horrifyingly expensive, but we'd lose the experience gained by actually working with the various materials that we will be specifying eventually.

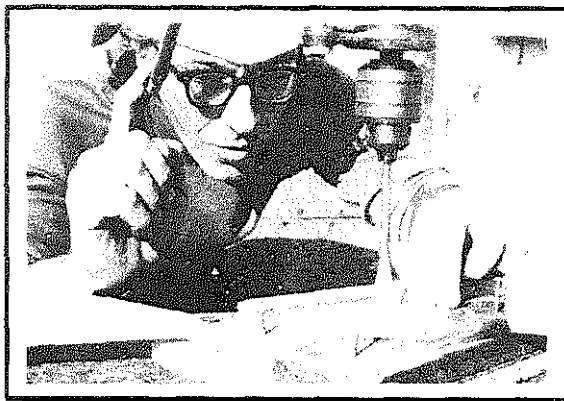

SIMPLE JIG holds each 2 x 4 inserted for drilling in the same relative grip, and so each will have its hole in the same place. Be sure and blow out chips so part will fit snugly, and always mark jigs so you can detect if they are slowly moving as parts thump into place. **CLAMPS** are a good thing to have lots of.

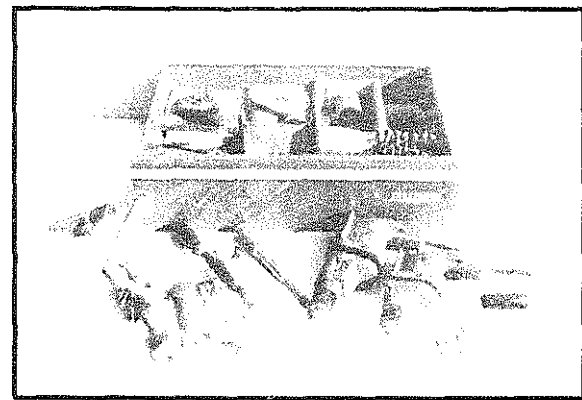

HOLE-MAKING DEPARTMENT gets heaviest use, partly because the rotary devices are so versatile in other modes. Assortment of hand drills is because we often work where there is no power available. Their lair is rather deep for a photo, so I've had them sit on the step for a class portrait.

the shop How about making your own personal canoe paddle? Or your own left-handed kitchen equipment? You can modify existing tools too. For instance, when we needed to make 7-inch diameter pistons for a small production run of giant raft-inflating hand pumps, we reversed the bit in a hole cutter so it made discs instead. The pistons were then easily and accurately cut from heavy plywood with a great saving in time and material compared to turning them on a lathe that we would have had to borrow. Making the big pump's leather "piston ring" seals proved to be easy after we spent some time talking to craftsmen in a sandal shop. With their advice, we soaked heavy leather discs in Mink Oil and then pressed them into the desired shape with a matched male and female die rammed by our vise. The dies were made on a bandsaw modified

with a simple homemade attachment that enabled us to cut bevelled round holes with good accuracy. That attachment was also used to make the next batch of pistons, as it proved faster than the disc-maker on the drill press. Tools making tools making tools.

I can hear some of you saying "small production run! Yuk. . ." Unless you are an artist, and maybe even then, you will sooner or later need a bunch of things all alike. Even with only the most basic tools, you can mass-produce things. The precision and complexity of the produced parts is somewhat dependent upon the adaptability and quality of your tool bank. another reason to intelligently gather good stuff. Large scale mass-production tends to

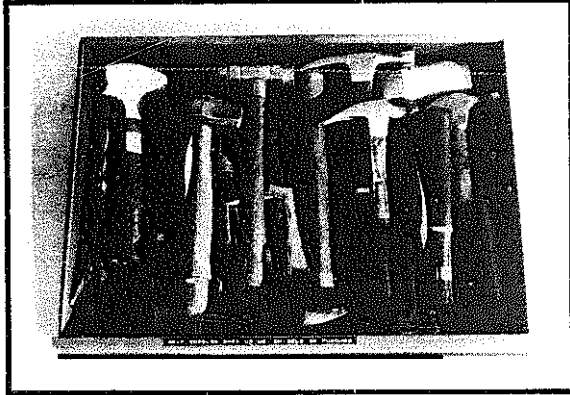

HITTERS. Wood handled hand sledge has been replaced by more reliable and better-balanced Estwing model. I'll give the old one away to a friend who has none and doesn't mind replacing the handle again. Our big sledgehammer lives with "outdoor" tools hanging on the wall. Third hammer from left is a BB-filled "no-bounce," really great for sheet metal and chisel work. (Brookstone)

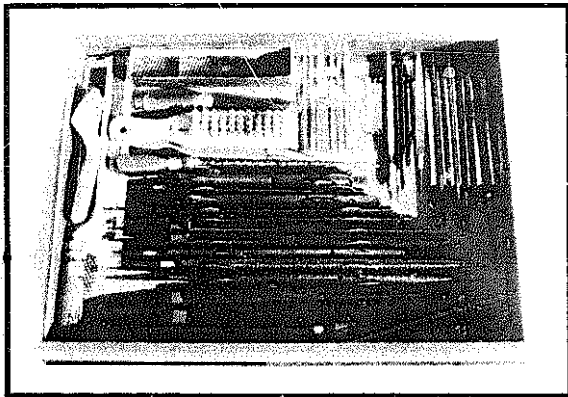

ABRADER DEPARTMENT. Spring keeps files separate so you can see them, and also keeps files from filing each other. Drawer lining is indoor-outdoor carpet.

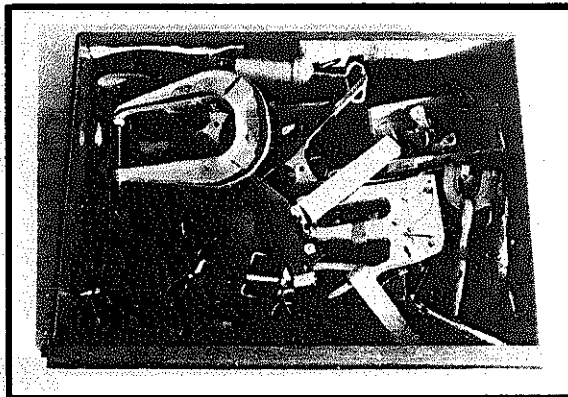

ASSORTED UNSORTABLE DEPARTMENT. You didn't really think that there was a way around having one of these did you? Nobody, including me, knows what's in here.

enslave both the workers and the customers. The workers are used as if they were machines. The huge capital outlay for the factory means that there must be a huge and relatively steady demand. This in turn means heavy manipulation of public "desires" and almost always involves politics and coercion.

Smallscale production, though, can mean a great reduction in drudgery as well as interesting possibilities in barter. By means of jigs and other simple fixtures that you can figure out yourself, you can be freed from having to measure each part. Hold the piece of wood against the jig and hit it with the drill and all the holes will be in exactly the same place in each part.

We've mass-produced thousands of dome struts and parts for conventional construction. We've also produced simple looms and the aforementioned pumps (which we bartered for a fleet of rafts and got into the whitewater river running business!). solar collector parts, signs (during an anti-freeway fight), toys, boxes, electronic parts, concrete forms, fence rails, adobe blocks, tents, shelving, lighting systems, and model parts. to name but a few. The ability to get on a small production run frees you from dependence on larger less efficient manufacturers. their prices, specifications and schedules. It can be rather fun, too, if it doesn't go on for too long. "Shop Yoga," we sometimes call it.

And it can be done without sophisticated expensive equipment if you take the time to think it all out first. The thinking is the most powerful part. You can actually change some things out there! Maybe not in a big way, but certainly at a scale that you can understand. You will find that as you work, your understanding of technology will increase a bit, and your fears based on ignorance will decrease. (Your fears based on newfound understanding might well increase, but that's another paper.) In a modest way, you can combat the "machines taking over" by having better control of the technology you live with. It's a good feeling. And it's free. .

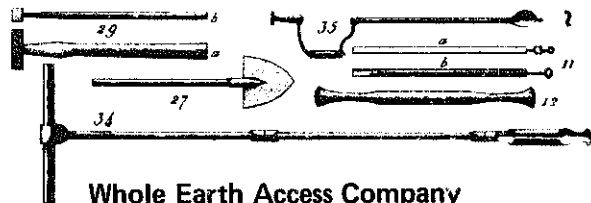

Whole Earth Access Company

When I have to buy tools retail, I almost always drop by the Whole Earth Access Company in Berkeley. Their prices are just plain unbeatable for a retail outfit, though for many items you have to put in an order and then wait a week or so. The more popular items, including Bosch tools, are in stock. They also carry other hardware such as stoves and canning equipment, at discounts that can be as high as 40%. The store carries books too. Nice people to do business with. They are not connected with us in any way, despite the name.

—JB

Whole Earth Access Company
2466 Shattuck Avenue
Berkeley, CA 94704

More toolbox

Joe Eddy Brown conducts a notorious junior high school art class in a midwest city. Here's how he got the kids into tools.

—JB

The kids have built a huge working tool library within the existing Art Room. True, a couple of students must play "tool librarian," but believe-you-me it is not by force. Picture this: huge cardboard side walls with a front of found chicken wire. The framings are made from the 2x2s once used to ship motorcycles from Japan. To the right is a screen door with found rug hinges and an undecipherable locking system from kid design. A closable slot is provided in the screen at eye level for obtaining and returning tools. In order to get the tool of your needs, one must trade a shoe or belt or something else of value. This they get back upon return of the borrowed object. Tools are traced on construction paper & laid out on shelves. We have a Teacher Black List posted which restricts the teacher-offender (our worst customers!) from using the tools until he/she returns or replaces what is owed. We lose nothing! We ain't perfect, we are evolving. . . . I can see it day to day. Each period requires 2-4 kids to operate and they make changes as needed. Jay, I wish you could see it/them! The whole crazy thing works like a kinetic machine sucking in shoes and spitting out hammers and Majic Markers!

Experiences in Visual Thinking

If you're a poor visualizer, you're working without one of the most important mental tools. Fortunately, visual thinking is an ability one can develop and improve, and Bob McKim has provided a manual for doing just that. The book is both informative — good background information on creativity and problem-solving — and experiential, full of excellent exercises structured to develop specific aspects of visual thinking. A fine balance of about and how to. It's one of the very few books with exercises to do that I've actually managed to work my way through.

—Linda Williams

Experiences in Visual Thinking

Robert H. McKim
1972; 172 pp.

\$9.95 postpaid

from:
Brooks-Cole Pub. Co.
c/o Wadsworth Pub. Co.
10 Davis Drive
Belmont, CA 94002
or Whole Earth

2-12 / pulleys

In Figure 2-12, which way (a or b) will pulley "X" turn?

Did you trace the motions of the pulleys with your finger, or feel some sort of inner muscular involvement, as you came to the correct conclusion that pulley "X" goes in direction b? If so, you were experiencing the importance of kinesthetic imagery to active thinking operations.

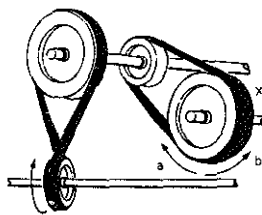

Figure 2-12.

Tower of pulp

With two sheets of newsprint and 24 inches of Scotch Tape, construct the tallest tower that you can in 30 minutes. You may cut, fold, or form these materials any way you like. Other challenges, using the same materials: the longest bridge, the largest enclosed volume (open or closed), or the strongest 12-inch-high support structure (add increments of weight to test).

"Have a big tree in front of you. / Breathe fire on the tree and burn it all up. / Have an old castle in front of you. / Breathe fire on the castle and have it fall down. / Have an ocean in front of you. / Breathe fire on the ocean and dry it up.

Pump Flashlights?

A source question: Do you have any leads on producers of pump flashlights? — the kind operated by a generator with a hand squeezing action? They're great for emergency use as they never go dead from storage as there is no battery to give out. Hammacher Schlemmer in NYC sells one but it is delicate & expensive (what do they sell that isn't). We need a rugged one that can take a lot of abuse. — I've seen one made some 20 yrs. ago but can't trace it. I think many of your readers would enjoy knowing about it. If you don't know of one, how about putting a request in the catalogue for information.

Best,
Bill Coperthwaite
Bucks Harbor, Maine

Flywheel Generator Flashlight

\$15.95 postpaid

from:
Edmund Scientific CO.
Edscorp Bldg.
Barrington, NJ 08007



Never needs batteries, uses a flywheel generator to keep light bright. Each squeeze of handle gives 2 sec. flash of light. Continuous squeezing keeps light shining. Only 6 oz.

RE squeeze-powered flashlights. From experience, I can tell you all that unless you have forearms like Popeye, you won't get more than about ten minutes of light from one, and the last few moments will be accompanied by gritted teeth, excessively speedy heartbeat, and whimpers.

—JB

Do-It-Yourself Plumbing

There are many books that adequately handle this subject (another good one EPILOG p. 518) but this one is special: In addition to being commendably clear on repairs, both graphically and in the text, it has a really fine section on designing your own plumbing system. I especially like the author's insistence on explaining the basic reasons underlying his instructions and also building codes. That way you really learn something. This is another of the excellent Popular Science books, but the price is an outrage even these days.

— JB

Do-It-Yourself Plumbing

Max Aith
1975; 301pp.

\$12.95 postpaid

from:
Harper and ROW
Keystone Industrial Park
Scranton, PA 18512
or Whole Earth

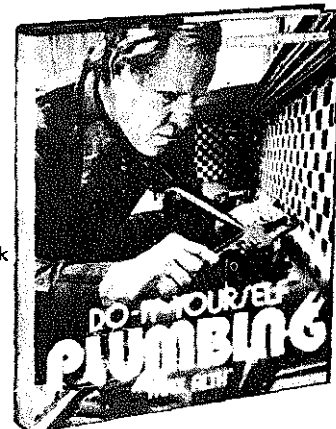

Aushalser

Uh, for those of you that don't know what an Aushalser is, it's a device that makes holes in the sides of tubes so you can attach other tubes there without T fittings. It's too expensive for the average toolbox, but if you have to make a bunch of manifold type flat plate collectors it could save you money. The joints are more reliable and cheaper than T fittings. The tool is made with typical German

precision. They also make a nifty small tubing bender. The tool can also be purchased separately for less.

—JB

Aushalser Kit
\$300.00 and up (approx.)

from:
Rothenberger USA
7317 Cahill Rd., Suite 261
Minneapolis, MN 55435

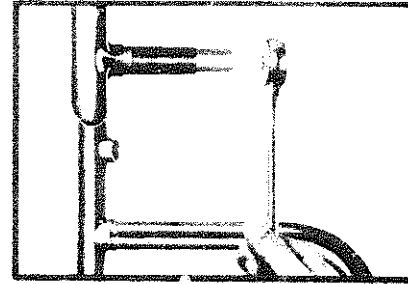

Garrett Wade Company

For the livin' end in catalogs of expensive professional woodworking tools take a look at this! The studio color photographs give a good feel of the high quality (though I admit that even Globemaster tools would look good shown in this context). The contrast with your Local Hardware Store is obvious and deadly. I hold such catalogs in high regard not only for their yummy contents, but for their educational value; the accurate descriptions together with the sharp illustrations show what's available and what the tools do, and thus can inspire the craftsman to assume new responsibilities.

— JB

Garrett Wade Company, Inc.
Catalog
\$1.00

from:
Garrett Wade Co., Inc.
302 Fifth Ave.
New York, NY 10001

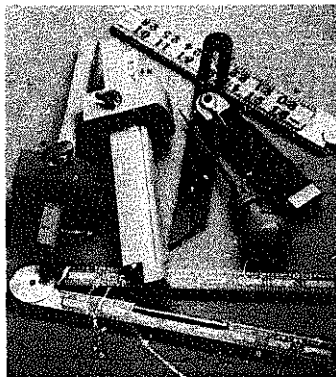

Devcon

One way to conserve energy and resources is to fix things that break rather than throwing them away. The Devcon Corporation makes a wide variety of products that can solve some very nasty repair problems as well as increasing the life of various hardware. Typical is Plastic Steel and Plastic Aluminum. A far cry from their sissy hardware store counterparts, they are super strong and you can (for instance) repair engine blocks. They make a paint called "Z" that actually outperforms hot dip galvanizing (Milspec no less). Their Devcon Rubber repairs split rubber boots better than anything else I've seen. They make a wear resistant self-lubricating epoxy compound that can be used to make long wearing bearing surfaces in wood. (It can also be used to build up worn shafts.) The list goes on. I've used all this stuff and find it to be at least as good as they say. Not many companies are worthy these days. This one is. You'll probably have to get their products from an industrial supply house. The catalog is available there too.

—JB

Devcon Corporation
Danvers, MA 01923

Devcon Ltd.
Theale, Berks., England

Devcon Canada Ltd.
Scarborough, Ontario, Canada

Devcon De Mexico, S.A.
Mexico, 5, D.F.

Devcon Z — The Zinc Rich Coating. Contains 95% pure zinc and 5% epoxy binders (weighs 24 lbs. per gallon). Approved by Underwriters' Laboratories as equal to hot dip galvanizing. Used on large metal tanks, towers, buildings, ships, fencing, railings, etc. Stops rust and rust creepage by galvanic action. Unlike red lead and other "sealing" paints, it protects surface by galvanic action even when coating has been scratched. Meets or exceeds U.S. Navy Specification MIL-P-21035 (ships), Galvanizing Repair; U.S. Air Force Specifications and others. "Cold galvanize" material may be applied by brush, dip, spray or roller. Devcon Z thinner available if dipping or spraying is desired. 1½, 6, 24 lb. packs (24 lbs. = 1 gal.). Also supplied in 16 oz. aerosol can. Thinner: 1 qt., 1 gal.

New Equipment Digest

To technofreaks, this big mag is a mother lode fairly stuffed with the gizmos and whatnots of production. The very tone will be a turn-off to those interested in a humane world less marred by industrialism, but open-minded snooping will often turn up procedures and devices with interesting possibilities. Some are the result of OSHA safety standards and many are intended for something else than what you might have in mind. You have to be imaginative. You'll also have to be imaginative getting ahold of most of what's shown, as it's behind "wholesale curtain." There are ways, though . . .

— JB [Suggested by Ken Shepard]

SEALING TAPE patches leaks and cracks



Pressure - sensitive sealing tape adheres to any surface to permanently patch leaks and cracks. Miracle Seal Plus is formulated from 30% steam-refined asphalt and EPDM rubber which boasts ozone and ultra-violet ray resistance and excellent sound dampening and vibration control properties. Product withstands -70 to 180°F temperatures and comes in 2½ and 8-in. widths.
Revere Chemical Corp., 30875 Carter St., Solon, OH

New Equipment Digest

\$18.00 /year (12 issues)
U.S. and Canada

\$36.00 foreign

Subscription free to qualified firms listed in Dun & Bradstreet

from:
Penton/IPC, Inc.
Penton Plaza
1111 Chester Avenue
Cleveland, OH 44114

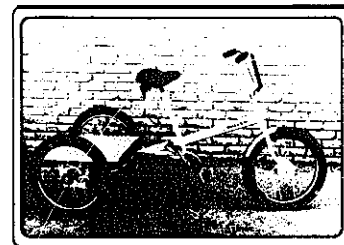

the MOVER

Model 1E-P

Used in: Warehouses - Factories - Foundries - Airports - Refineries

Used by: Order Fillers - Maintenance - Inspectors - Supervisors - Production - Mechanics - Tool Room

Industrial Cycles, Inc.
3120 Wilmington Pike
Dayton, Ohio 45429 (513) 293-8322

Foundrywork for the Amateur

A foundry need not be a huge industrial complex or even a purchased kit. You can start with your kitchen stove, an old pot, some sand, scrap aluminum, and this book. Such a kitchen foundry would give you an immediate source of emergency replacements for a broken pulley or small bracket on that old "patented 1892" water pump. Recycling a scrap auto into cast bridge washers and boot scrappers takes a bit more. Directions for construction of the requisite backyard blast furnace, patterns, and molds are provided.

—Alan Kalker

Foundrywork for The Amateur

B. Terry Aspin
1972; 108pp.

.50p + .50p postage
(currently \$2.05 total)

from:
Model & Allied Publications
P.O. Box 35
Hemel Hempstead, Herts.
England HP1 1EE



VW prime mover

This company can help you put that old bug engine to work as a reliable and efficient stationary power source for driving irrigation pumps, compressors or a host of equipment. Upon request, they will send product data sheets for conversion accessories such as a universal bell housing, direct drive, pump drives, T-box (on special request), a universal clutch housing, double or single shaft reduction gears, drive plates, spline shafts, etc. They also sell 40 and 53 hp VW engines modified slightly for stationary use. Ask for a price sheet.

They provide specifications and also graphs of power output versus RPM, torque versus RPM and fuel consumption versus RPM for both engines (handy to have).

You might want to consider using methane or fuel/alcohol as an alternative or backup to gasoline.

—Bill Hutchinson E.S.I.
Arlington, Texas

Type 122 & 126A VW Industrial Engine & Accessories

Information free

from:
Industrial Engine Division
Volkswagen of America, Inc.
North Central Region
3737 Lake Cook Road
Deerfield, IL 60015

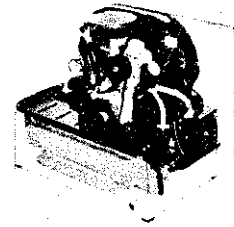

Drafting Technology & Practice

Drafting is the language you speak to the person who is going to have to make your idea. There are formalities. But it also is an art, especially when the idea is not easily explained. "Drawing it up" also tends to make the inventor more honest both with the rest of the world and himself. This book must be the clearest I've ever seen on the subject. So clear that it makes you think clearly. You couldn't ask for more. Mapping, technical illustrating, and electronic diagramming are also covered, along with just about anything else you could think of.

—JB

I wish to hell the makers
of home-made how-to
books would attend
to this text. —SB

Drafting Technology & Practice

(A Comprehensive
Guide to Drafting
for Modern Needs)
William P. Spence
1973; 814 pp.

\$17.50 postpaid

from:
Charles Scribner's Sons
Vreeland Ave.
Totowa, NJ 07512
or Whole Earth

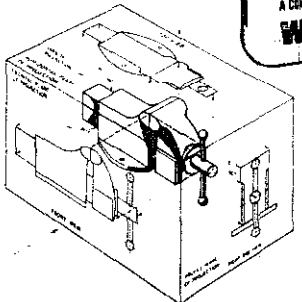
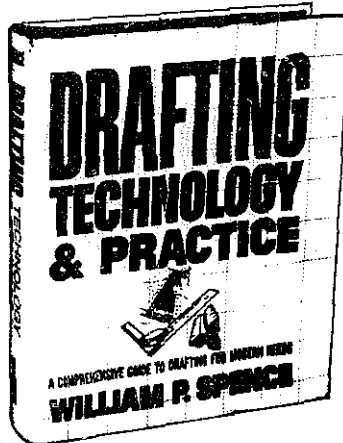

Theatrical Equipment & Supplies

Oh my goodness! A mouth-watering catalog of stage stuff, much of it easily adapted for other uses. (As you might guess, because stage equipment is by its nature always being adapted for this or that). Hide my checkbook!

—JB
(Suggested by Dick Dillman)

Theatrical Equipment and Supplies Catalog

\$1.50 postpaid

from:
Mutual Hardware Corp.
5-45 49th Avenue
Long Island City, NY 11101

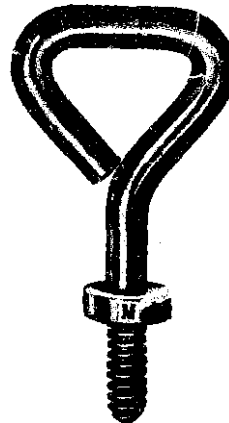

IMPROVED STAGE SCREW

The new Improved Stage Screw & Plug were developed to eliminate the destruction of stage floors. A 1/2 inch hole is drilled into stage floor to accommodate a threaded Stage Plug. A vise type thread on Stage Screw allows quick and easy insertion. An unused plug can easily be removed and the hole filled with a 9/16 inch dowel. Holding power is approximately 5 times that of any old style stage screw.

\$1.50 each



IMPROVED STAGE SCREW PLUG

The new Improved Stage Screw Plug is designed to be used with the Improved Stage Screw. See explanation above.

\$1.25 each

The Procedure Handbook of Arc Welding

As a welder in a large plant using many different welding processes every day, I have found this to be the most comprehensive and current book on arc welding going.

Reliable information on all arc processes (stick, innershield, submerged, electro-slag, MIG, TIG), weldability of metals (carbon and stainless steels, aluminum, cast iron, copper) including sheet metals, with special sections on design, machinery, testing and qualification procedures, pipe and out-of-position techniques, distortion control, underwater welding, arc-gouging, galvanized and concrete re-bar welding, and hardsurfacing. All clearly explained with plenty of photos and diagrams, tables and graphs.

Really an eye-opener into the welding field; information valuable to the worker in a large metal fabrication plant as well as the farm welder and small shop. First printed in 1933 it is currently in its 12th edition, updated last in 1973.

Their mail service is prompt (I received my copy in about 2 weeks, their catalog arrived within 4 days) and at a fair price too. They also have learning manuals available plus some excellent volumes on welded structures throughout the world.

—Steve Keleher

The Procedure Handbook of Arc Welding
1973: 700pp.

\$5.00 postpaid

from:
The Lincoln Electric Co.
22801 St. Clair Ave.
Cleveland, OH 44117

The Oxy-Acetylene Handbook

The corporations that make the product often publish the best manuals on how to use it well, in the hopes of encouraging further sales. So it is that Union Carbide brings us this authoritative textbook at a very fair price. (You'll still need an experienced instructor though.) Comprehensive, to say the least.

—JB

The Oxy-Acetylene Handbook
1943, 1972, 1976; 300 pp.
\$7.75 postpaid

from:
union Carbide Corporation
Linde Reference Library
47-36 36th Street
Long Island City, NY 11101

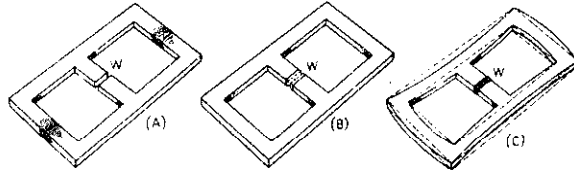

Here, step by step, is illustrated the effect of expansion and contraction in making a weld in a restrained part. Ductility is of great importance in this example.

Handtool Handbook for Woodworking

Tool-use books must be among the most deadly boring literature available in our society, probably because they are written for retarded seventh-graders. The few books that avoid such an accusation tend to be written in the imperious tone of a retired Master Sergeant shop teacher. I for one simply can't read them. An exception is available. R.J. DeCristoforo, who brought us his excellent Complete Book of Power Tools (CATALOG, p. 521) has done it again for common woodworking hand tools. The first page I opened to showed me something I didn't know (the dowel trick below).

—JB

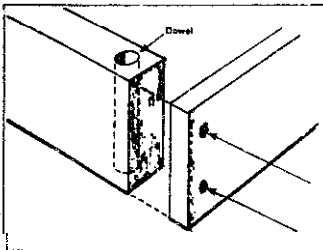

A dowel can be placed in a drilled hole to help hold screws driven into weak end grain.

Handtool Handbook for Woodworking
R.J. DeCristoforo
1977; 184 pp.

\$4.95 postpaid

from:
H.P. Books
P.O. Box 5367
Tucson, AZ 85703
or Whole Earth

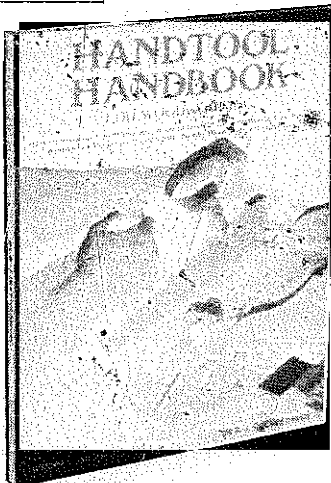

How to Run a Lathe

Lathes are great. I've got one made about 1910. Cost a couple hundred and took a week of work cleaning it up and rebuilding it. It's at least as good as a new one costing \$6000.

I've look at a lot of books on lathes and this one covers all of it. I've been reading it for a year now and there are still things in it I haven't learned. Get your copy quick. It may not be available forever. Oil and clean your lathe a lot. Lots of lathes get ruined by not being oiled.

— Fred Richardson

How to Run a Lathe
(The Care and Operation of a Screw-Cutting Lathe)
South Bend Lathe
1914-1966; 128 pp.

\$1.00 postpaid

from:
South Bend Lathe
400 W. Sample Street
South Bend, Indiana 46623

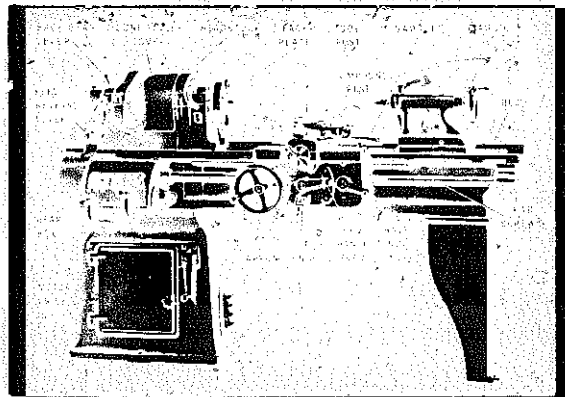

Small Tractors

BY RICHARD NILSEN

photos by David Edwards

The California Farm Equipment Show was held recently at Tulare, in the San Joaquin Valley. Most of the machinery was geared toward the state's thriving "agribusiness" industry, which in 1973 grossed 7.5 billion dollars. As American farm machinery companies produce bigger and bigger tractors, more of the small equipment is imported. (Many American firms do make a line of small tractors for lawn and garden use; they are usually under 20 h.p. and several of the salesmen I talked to referred to them frankly as toys.)

The tractors you see below are built for heavier work. But I have not tried them out, and these are not reviews in the sense of being recommendations. A small tractor review is easy: BUY A USED FARM TRACTOR — by far the best value. If, after looking at the price tags on new tractors you still want one, consider one other factor — service. The best designed, most exotic tractor in the world is no good to you if it won't run because you are waiting for a part to be shipped from the other side of the world. Many of the smaller imports have good U.S. service networks, but that really depends on where you live. If you have experience with these or other small tractors, new or used, and want to share it, please write.



Typical of the direction that agribusiness is heading is the Big Bud model 747. It weighs 65 tons and can pull a cultivator 80 feet wide at about 6 mph. At that rate it can cover 1000 acres in less than 24 hours. Built by Northern Manufacturing Co. of Havre, Montana, the Big Bud 747's base price is \$300,000. A television to monitor what's happening behind it is extra.

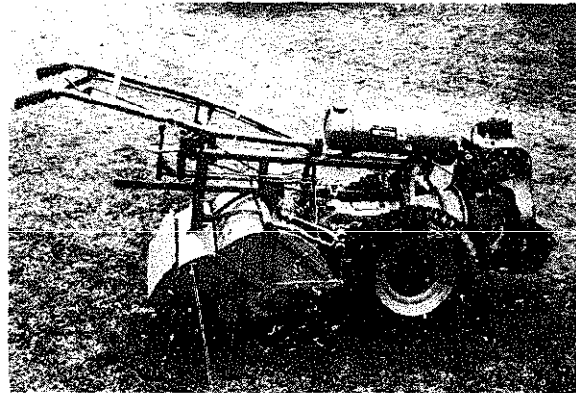

Howard Rotavator's largest walk-behind tractor, the "Gem," is shown above. It comes with either a 9.2 or 15.2 hp 4 cycle gas engine. With the smaller engine, this model costs \$2,900. Dealers throughout the U.S.



The smallest tractor Gravelly Corporation makes is their 8 hp gas powered "convertible tractor." It has a rotary plough, not a roto-tiller, and sells for \$1,200.00. The T-head, 1 cylinder engine is the same design they have been using since the 1920s; 30 years of continuous use is not uncommon. Gravelly is now entirely out of the shredder/composter business. (Gravelly Corporation, Gravelly Lane, Clemmons, North Carolina 27012.) (Also reviewed in CATALOG, p. 55.)



The only sickle-bar mower still made in the U.S. is the Jari. The 4 hp gas-powered "Monarch" pictured above is their largest model. Bars range from 16" -60"; the photo shows a 36" bar, and the unit costs \$650.00. (Jari Division, Year-A-Round Cab Corp., P.O. Box 2075, Mankato, Minn. 56001.)

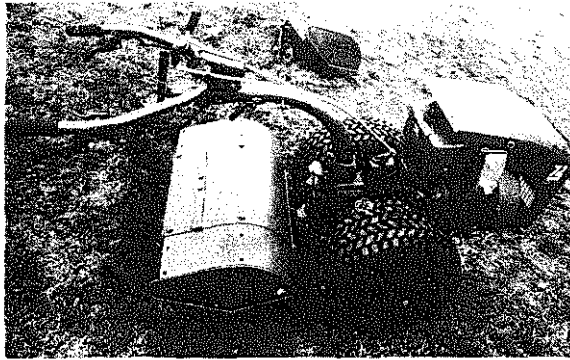

From Italy comes this Ferrari Model 72, their largest walk-behind model. The only roto-tillers in the world to be powered by air-cooled diesel engines, this one uses a Lombardini 14 hp diesel. One handy feature is that the handle pivots 180°, allowing you to remove the tiller and attach other implements to the PTO — the machine then runs backwards. Pictured on the top with a tiller; on the bottom in reversed position with a sickle-bar. The machine costs \$2,930.00 and includes roto-tiller; sickle-bar is \$700 extra. (Ferrari, 6104 Avenida Encinas, Carlsbad, CA 92008.)

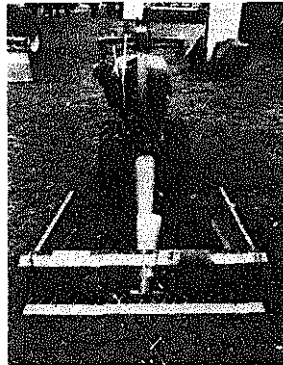

Also from Italy is this Goldoni Model 224. It has 27 hp and costs about \$5,000.00. (Smallest engine is 21 hp, largest is 42.) Air-cooled diesel engine (2 cylinders, 4 cycle), 4-wheel drive, only 31" - 44" wide (depending on tires), and articulated in the middle — see photo — for tight turning.

Lamborghini has a complete line of 4-wheel drive tractors, the smallest of which is the Model 235, with 38 hp. We don't know who is currently distributing these.

As far as I could learn, no American tractor manufacturer uses air-cooled diesel engines; yet several European companies do, and have for many years. The first one was built in Germany in 1942. One salesman told me that high mineral content in European water, and poor quality water, was hard on water-cooled engines, and was a big factor in developing air-cooled diesels. Their main advantages seem to be:

- a simpler engine, cheaper to build and easier to maintain. No radiator or water circulating system (lighter weight), no rust or freeze-ups.
- works in a wider range of temperatures; will start at -30° and will run cooler in hot weather than water-cooled diesels.
- faster warm-ups. Ready to go under a full load in 5 minutes, instead of the 20-30 minutes it takes a water-cooled diesel to warm-up. This, plus the fact that there is no cooling fan to pull, means less fuel consumption.
- cleaner exhaust and lower noise level than gasoline engines.

When I asked the salesman for American tractors what was wrong with the air-cooled diesel engines, their main objections were that it was an easier engine for an inexperienced operator to ruin. For one thing, the engine can burn up if dust and straw clog up the air circulation; this is less likely to happen with a sealed water-cooled system. And since an air-cooled engine has a wider range of operating temperatures, and must be built with greater tolerances in the engine, things tend to knock around a bit when it's cold. Running any kind of engine too hard when it is cold will shorten its life, but this seems especially true of the air-cooled diesel.



Kubota, from Japan, makes a full line of 4-wheel drive water-cooled diesel tractors. Pictured is the Model B6000C, which with 12.5 hp is the smallest 4-wheel drive tractor currently on the American market. It costs \$3,500. (Kubota Tractor Corp., 300 West Carbo St., Compton, CA 90220.)

One way or another, American farmers will probably be seeing more Japanese tractors. For example, the small Ford farm tractors (the 1000 series) are all made by Ford of Japan. Two other Japanese tractor makers were at the Tulare show, both with small tractors. They are: the Yanmar (water-cooled diesels, write to: Gearmore Inc., 1300 66th St., Emeryville, CA 94608), and the Satoh (gasoline, write to the National Equipment Distributors Association, P.O. Box 5025, Richmond, VA 23220, for the nearest dealer.) ■

The Marugg Company

The Marugg Company sells hand scythes imported from Germany and Austria, and hickory snaths (handles) from Tennessee. Christian Marugg began the business in 1873, after immigrating from Switzerland; two men make the handles and fill the orders today.

The blades are sharpened by hammering on an anvil, not by grinding. Also available — grass scythes for haying from 20 to 30 inches in length, plus heavier weight bush scythes for chopping briars or clearing irrigation ditches.

—Richard Nilsen
[Suggested by Wendell Berry]

The Marugg Company
price list
Free

from:
The Marugg Company
Box 326
Tracy City, TN 37387



Austrian Grass Scythes

20 inches long	— \$14.00	26 inches long	— \$14.65
22 inches long	— \$14.25	28 inches long	— \$14.75
24 inches long	— \$14.35	30 inches long	— \$14.90

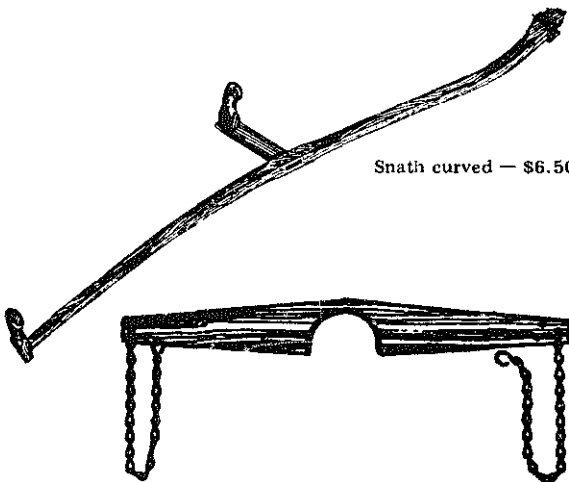

Snath curved — \$6.50

No. 93 — Wateryoke (Wasserjoch). Most useful in carrying full pails without spilling. Water from the spring, slop to the pigs, milk from the dairy barn, water or liquid manure to the growing plants. A thousand uses on every farm. Made of best hardwood, galvanized carrier chains. Has special device for regulating the load forward or backward. Length 40 inches; weight about 5 lbs. Price \$4.50.

Farm and Ranch Supplies

If you need a serious quantity of stock fence or irrigation pipe, check Bernstein Brothers' prices. Their current prices on field fence are similar to Sears and on farm gates 25% less. Since Bernstein prices include prepaid freight, while Sears do not, Bernstein is 10 to 35% cheaper. They carry a variety of other heavy duty items such as cattle guards, large stock tanks, windmills, hog feeders, and squeeze chutes. Some of their fabricated steel items are surprisingly cheap; less than what it would cost you to build it of wood or steel. For example, they sell bull-proof corral panels made of 1/4" steel rod welded in 4" x 4" mesh, 5 feet by 20 feet for \$37.00. Wood rails for a similar section of a recently constructed bull-pen cost more (and failed to hold the bull).

—Alan Kaiker

Hopperdozer

To be pulled by horse through clover, alfalfa, meadowhay, grasshoppers jump up, fly against tin and fall into oil [old crankcase oil or vegetable oil, depending on whether the grasshoppers are to be eaten] cheap, organic pest removal.

—J.D. Smith

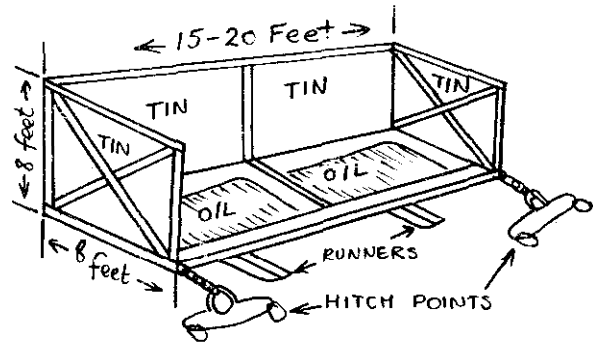

Central Tractor Parts Company

A mail-order supply house for farm machinery and parts, similar to Tractor Supply Company (CATALOG, p. 74). The difference is that this company also sells used tractor engine parts for all major makes of American tractors. They offer a 30 day guarantee on used parts, and the listings are quite extensive. So if you have an old but reliable tractor that will run fine if only that part that's been back-ordered for 10 months ever arrives, you might do better checking here.

—Richard Nilsen

Central Tractor
Parts Company
Catalog

Free

from:
Central Tractor
Parts Company
1515 East Euclid Ave.
Des Moines, IA 50313

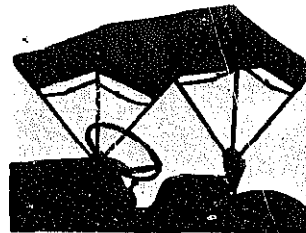

CENTRAL TRACTOR'S JUMBO FOLDING CANOPY
\$50.50

Field tested, gives ample head room and elbow room. Mounting location does not conflict with equipment. 48" wide and adjustable to desired angle. Please advise: color desired and axle or fender mount, and model of tractor so we can include the proper mounting brackets.

Axle mount, red 11115-235; axle mount, yellow 11116-235; fender mount, yellow 111122-235; fender mount, red 111123-235.

Replacement covers: red 11117-235, yellow 11118-235. \$15.25

Catalog

Free

from:
Bernstein Brothers
P.O. Box 917
Pueblo, CO 81002



HEAVY-DUTY CAST-IRON PITCHER PUMP

Neat, attractive Pitcher Pump made of highest grade gray iron castings. Cylinder is machined smooth and polished. Closed spout and closed base promotes sanitation. Good grade leathers used. Modern advanced design. Raise the handle to full height to drain cylinder and prevent freezing. Tapped for 1/4 inch suction pipe. \$27.95 postpaid.

Dictionary of Tools

Tool freaks, this is the ultimate tool book! Not only an incredible array of woodworking tools from past and present shown, but plenty of special-purpose (e.g., wheelwrighting) ones, too. The extra clear illustrations often show the tool in action, which should enable you let's-do-it-the-old-way people to get at it. There are diagrams of such things as coaches, barrels, farm wagon undercarriages, Dutch windmills, and the like. All wood! This adds up to a book that is much more than a museum display of artifacts. It is, in my opinion, worth the money which is a special deal by the importer. Perhaps you can talk your library into it, but serious workers will want one of their own. Yummy!

— JB
[Suggested by
Jonathan Katz]

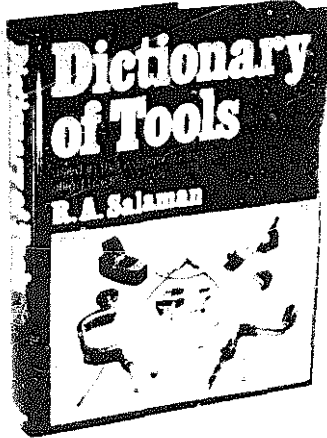

Dictionary of Tools
R.A. Salaman
1975; 545pp.
\$48.10 postpaid
from:
Woodcraft Supply Corp.
313 Montvale Ave.
Woburn, MA 01801

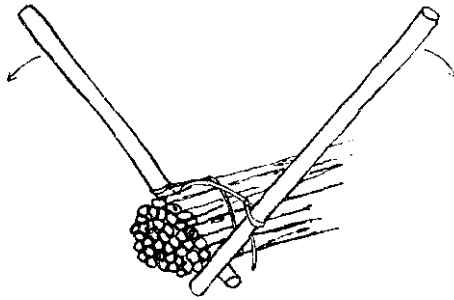

Woodman's Grip. Two strong poles, about 3 ft 6 in long, connected by a length of rope at a point about a foot from the lower end. Its purpose is to compress rods and stakes into bundles for tying up before carting away.

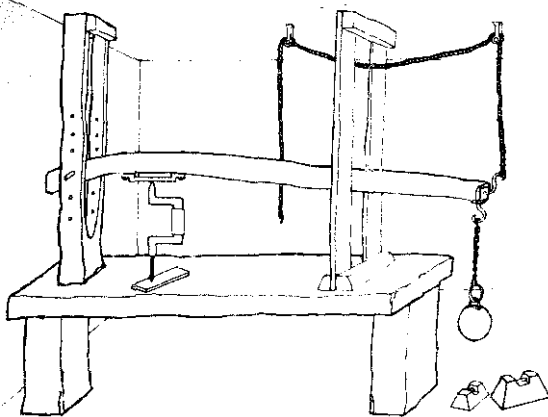

The Good Neighbor Heritage Catalog

These people stock many old timey tools, such things as Coleman irons (for those of you not into wash and wear) and a host of other equipment appropriate (there's that word again) to the Amish manner of living. Some of you might be interested in the kerosene refrigerators which are doubtless adaptable to other heat sources.

— JB

**The Good Neighbor
Heritage Catalog**
\$1.00 postpaid

from:
Lehman Hardware &
Appliances, Inc.
Box 41
Kidron, OH 44636

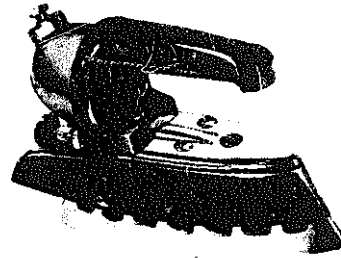

Kerosene (Paraffin)
Coleman

Preheats Quickly
With Alcohol
(Meth. Spirits)

Light Weight
Aluminum Sole
Plate
\$30.94

- Uniform heat distribution through sole plate
- Perfectly balanced
- Modern design
- Cool, comfortable handle
- Tapered ironing edge
- Iron in comfort, no muscular fatigue.
- No wires or connections can be used anywhere
- Sturdy, long-life generator
- Built-in pump
- Large opening for refilling or fuel tank
- Generator and tank assembly easily removed for service
- Burns for approximately 2 hours on one tank of fuel

Iron Horse Antiques

Iron Horse Antiques primarily serves as a mail-order outlet for books on traditional tools and crafts. Their 1977 catalog offers one of the most comprehensive listings for tool collectors and craft people. As their catalog states, "No books on remodeling your kitchen, or how to build a dog house out of one 4 X 8 sheet of plywood," but you will find titles on woodturning, leatherworking, blacksmithing, the history of tools, and industrial archaeology.

In addition to the mail-order service, Iron Horse also deals in antique tools, and from time to time holds auctions. Subscribers to the tool catalog also receive the auction catalog. Mail bids are accepted if accompanied with a deposit.

—Pete Hartman

Iron Horse Antiques, Inc.
Catalog

\$6.00 /year (3 issues)
(back issues
\$2.50 each)

from:
Iron Horse Antiques
RD No. 2
Poultney, VT 05764



- 36-1 Bark spud. (43AD) \$8.00
- 36-2 Hand forged bark spud. (103AD) \$15.00
- 36-3 Hand forged buttriss. (35383AD32) \$20.00
- 36-4 9 inch froe with original handle. (35733AD32) \$20.00
- 36-5 Unusual hand forged buttriss. (35253AD35) \$25.00
- 36-6 Very simple hand forged buttriss. (35653AD32) \$18.00
- 36-7 Large froe maul. 23 1/4 inches long by 6 inch diameter. (323AD) \$28.00
- 36-8 Stanley No. 95 block trimming plane. Nearly new. (35793AD40) \$36.00

The living BASICS from the UN

Dear Sirs:

I am pleased to send you Volume 2 - Home Techniques, Series 1 - Labour Saving Ideas, produced by the Food and Agriculture Organization of the United Nations, as you requested in your letter to me of 8 June 1976. I have also enclosed photocopies of some of the illustrations to be included in the next five volumes. The complete list of materials which have been published or are planned for publication in the next few months is:

Home Techniques

- Volume 1/Food Preservation (FPR) - Series 1
- 2/Labour Saving Ideas (LSI) - Series 1

Rural Home Techniques

- Volume 3/Food Preparation (FPP) - Series 1
- 4/Labour Saving Ideas - Series 2
- 5/Food Preservation - Series 2
- 6/Labour Saving Ideas - Series 3
- 7/Household Furnishing & Equipment (HFE) - Series 1

Please note that the volume titles beginning with Volume 3 will be called Rural Home Techniques instead of Home Techniques.

This series is priced at \$7.00 per folder, except Volume 1, which is \$4.00. Requests may be addressed to the FAO sales agent for North America, UNIPUB, Inc., Box 433, Murray Hill Station, New York, NY 10016.

Thank you for your interest.

Thomas Laughlin
Rome, Italy

All illustrations here are from Vol. 2, Home Techniques, Series 1, Labour Saving Ideas. Instructions are provided in English, French, and Spanish.

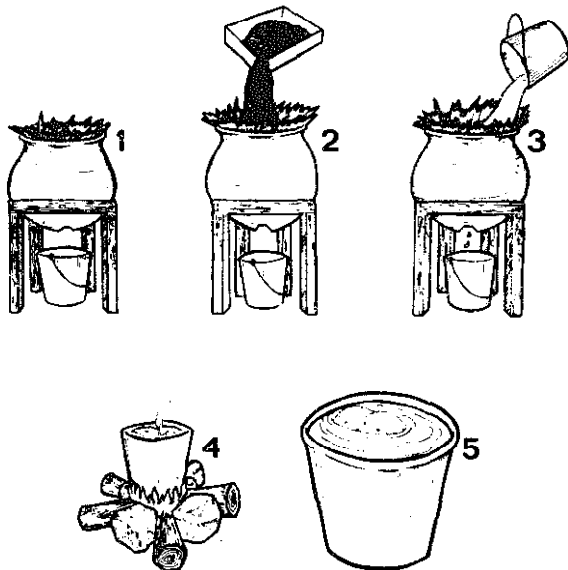

MAKING LYE

1. Elevate ceramic pot onto the wooden frame and place the bucket directly under the hole in the pot. Line the pot with straw or other filtering material.
2. Fill the pot with wood ashes
3. Scoop out a hole in the wood ashes and add as much water as will fill the hole. Add water daily as it is absorbed
4. After three weeks remove the bucket containing the lye. Boil the lye
5. Test the lye with a raw potato. If the potato floats the lye is ready for use.

The Cumberland General Store

Tools that last because they HAVE lasted, available now from where they're still manufactured. A better investment than gold.

We've never seen a finer catalog.

- SB

The Cumberland
General store
Wish and Want Book
1974; 245pp.

\$3.00 postpaid
from:
Cumberland General Store
Route 3
Box 479
Crossville, TN 38555

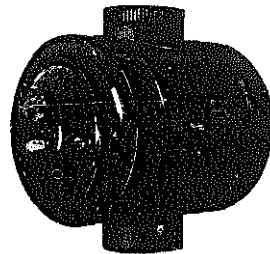
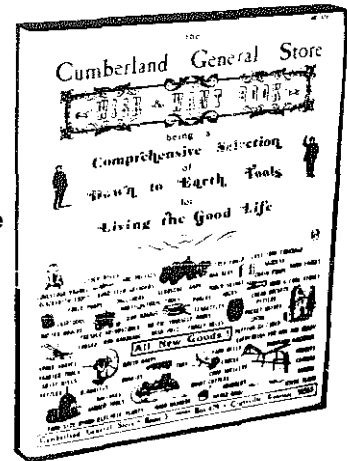

"SOOTLESS SUE" DRUM OVEN with Thermometer & Soot Cleaner. Equipped with reversible pan rack which may be used as cookie sheet or biscuit pan. Practical in the kitchen for baking and warming foods. In other rooms with the oven door open, it acts as a radiator and throws off a surprising amount of heat at no additional expense. Merely turn the crank in the back of the oven and blades revolve between walls for soot removal. Size; 16 in. long x 14 in. diam. Cookie sheet 10 x 13 ins., Pipe collar; 6 inch diameter. Shipping wt. 12 lb. H5 3-1 TC-\$33.00.



\$3.20

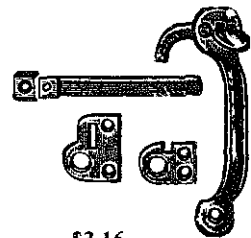

\$3.16

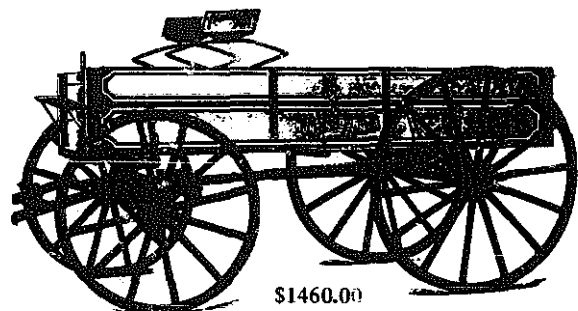

\$1460.00

Ways of the Sierra Madre

A loving, beautifully illustrated book celebrating the methods used by rural Mexicans in their everyday life.

-- JB

Ways Of The Sierra Madre

Eugene H. Boudreau
Illustrated by Joe Jaqua
1974; 96pp.

\$3.00 postpaid

from:
Pleasant Hill Press
2600 Pleasant Hill Road
Sebastopol, CA 95472
or Whole Earth



The soft brown soap (*jabon*) made by boiling together animal fat and lye leached from wood ashes has unknown beginnings, but was in use at the time of the Roman Empire. Besides being used for bathing and washing clothes it is a good shampoo for the hair, and its crude manufacturing process in no way detracts from its efficient cleansing properties.

Soaps are the salts of fatty acids that occur in natural fats and oils, and soap-making is based on the reaction of a caustic alkali with fat or fatty acid. The caustic alkali used in making *jabon* is caustic potash or potassium lye (KOH). *Jabon* is soft because it contains glycerine, which is separated out in most soap-making.

Some ash yields stronger lye than other, with ash from *bledo* or *roble blanco* (white oak) being two that are preferred. Ash from corn cobs or *palo blanco* is also good. *Bledo* is a wild plant that has a straight stalk several feet high with a pithy center. (Tender leaves of young *bledo* make a delicious green that is either fried or boiled in a soup.)

Leaching of the ash is done in a bin made of sticks and palm leaves called the *estiladera* . . .

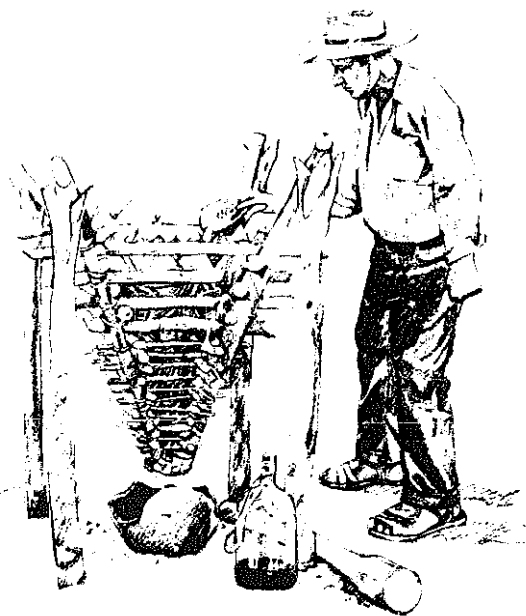

Guide to Hand-Operated and Animal-Drawn Equipment

These Intermediate Technology People work very hard and consequently come up with a lot more than prophecies of doom and useless propaganda. This manual is a sort of catalog of worldwide devices, with clear photos and addresses of suppliers. You can learn a lot from that. But better, the same people also publish dimensioned drawings for such things as ox carts and seeders, and complete excellent shop prints for certain other equipment such as a people-powered peanut thresher. I'd send for a list of all their publications.

-- JB

Intermediate Technology Development Group

1973; 81pp.

\$8.50 postpaid airmail

\$4.50 postpaid surface

(Publications list available) from:

Intermediate Technology Publications Ltd.
9 King St.
London WC2E 8HN
England

Animal-Drawn Single-Furrow Mouldboard Plough

This VS series plough is available with an 8 in or a 10 in cut. The share is made of the finest quality steel, and the plough beam is of rolled steel. A furrow wheel is fitted.

Agrimai (Malawi) Ltd,
P.O. Box 143
Blantyre
Malawi

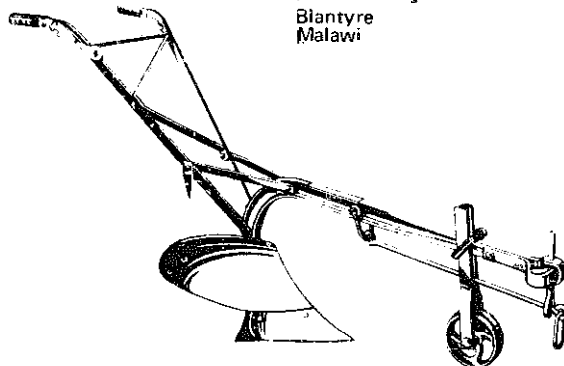

Garden Way Cart

As gardens get bigger so does the demand for a bigger wheelbarrow. The Garden Way Cart, Model 26, has an international reputation, but for anyone who hasn't heard of it, the cart is light-weight and balanced so that a bulky, heavy load can be carried with ease. It's the same principle as a horse-drawn sulky in a trotting race, which enables the horse to run with the least possible drag. Comes with a try-it-you'll-like-it-or-your-money-back guarantee.

--Rosemary Menninger

Garden Way Cart

\$129.50 + shipping

(Also available in other models and kit form. Write for price list.)

from:
Garden Way
Charlotte, VT 05445

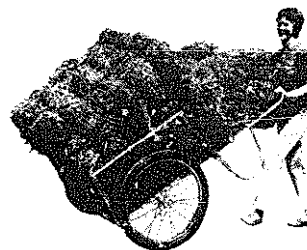

Appliance Service Handbook

Ogod, how many of these we've seen. This one's far the best — most comprehensive, most readily usable. Household technology.

— SB

Appliance Service Handbook

George Meyersink
1973; 426pp.

\$13.95 postpaid

from:
Prentice-Hall, Inc.
Box 500
Englewood Cliffs,
NJ 07632
or Whole Earth

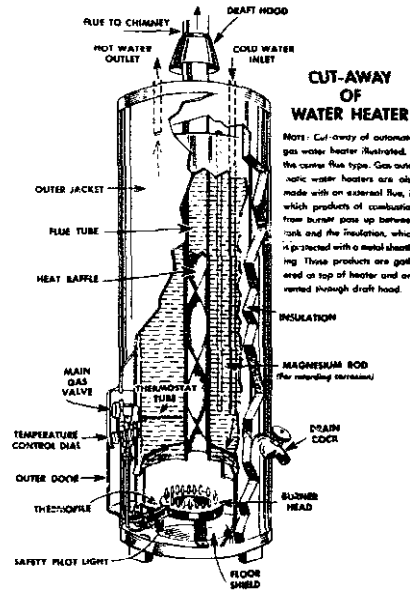

An alternative technology equipment directory

A less expensive, less complete, more recent guide to soft tech gear than *The Energy Primer* (EPILOG p. 527). Some non-duplications may make it worth having both.

— SB

Spectrum
(An Alternative Energy
Equipment Directory)

\$2.00 postpaid

from:
Alternative Sources of Energy
Rt. 2, Box 90A
Milaca, MN 66363

Amana Refrigerator Co.
Amana, IA 52203

Frost-free and manual defrost models are available with extra insulation and other energy conserving features. They claim the manual defrost model can save as much as 60% over other refrigerators.

Philco-Ford Corp.
Union Meeting Rd.
Blue Hill, PA 19422

They have several refrigerators with added insulation and more efficient compressors and motors. Savings in energy of from 30 to 50 percent are claimed.

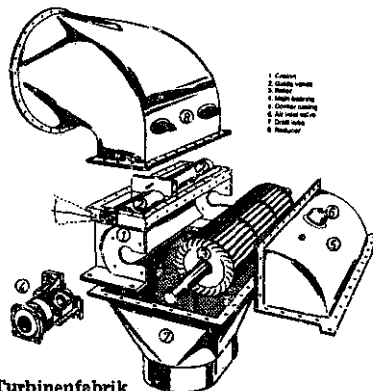

Ossberger-Turbinenfabrik
P.O. Box 425
Weissenburg, Bavaria

The patented "Ossberger" water turbines made by these folks are suitable for small-scale hydro-electric, pumping, or direct drive applications. They have been installed for saw-mills, shops and remote villages in many parts of the world. Some installations pay for themselves by selling electricity into the power grid in their communities when not using it themselves. They can operate on water head (drop) as small as 1 meter.

The Occupation of Service
Tools of the Trade
The Basic Approach
Installation
The Machine — A Box of Parts
Electricity at Work
Lubrication
Refrigeration
Air Control
Water
Servicing Techniques
The Gas Flame
Customer Relations
Room Air Conditioners
Blenders
Coffee Makers
Trash-Masher Compactors
Dehumidifiers

Dishwashers
Food Waste Disposers
Dryers: Electric
Dryers: Gas
Humidifiers
Incinerators
Electric Irons
Knife Sharpeners; Can
Openers
Food Mixers
Probe-Control Cooking
Appliances
Ranges and Ovens
Refrigerators
Toasters
Vacuum Cleaners
Automatic Washers
Water Heaters

Cloudburst 2

A book of useful designs, but not all are proven and some are reprints from other publications. Nonetheless, there's a lot of useful stuff here for the make-it-ourselves people.

— JB

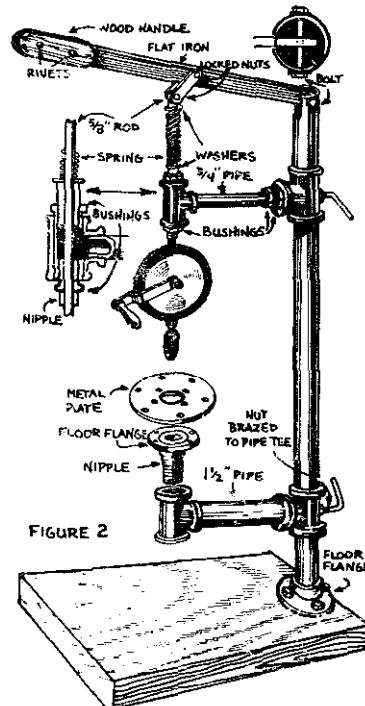

FIGURE 2

Cloudburst 2
Vic Marks, ed.
1976; 128 pp.

\$4.95 postpaid

from:
Cloudburst Press
1716 N. 45th Street
Seattle, WA 98103
or Whole Earth

A hand operated
drill press

Marks' Standard Handbook For Mechanical Engineers

For 50 years this has been where engineers, inventors and the curious have looked it up. It's sort of a huge review book of the math, formulas, and principles of the various fields of mechanical engineering. This includes, in addition to the expected thermodynamics, piping, hydraulics, etc. chapters on pollution control, cost accounting, and safety. As an example of using the book, I recently had to determine how far away from our house I could erect a wind machine without getting an unacceptable voltage drop in the wire I had available. A few minutes in the index and about 5 minutes on a cheap calculator and I had a drop of half a volt at 200 feet, which is OK. Like that. The book has been in print a long time, so there are certain out-of-date items. But the hard number stuff is right there where you need it, and the bibliography tells where to find more details. Now that I'm 20 miles from a library, buying one seems to make sense.

- JB

Marks' Standard Handbook from:
Fur Mechanical Engineers
 7th Edition
 Theodore Baumeister, Ed.
 1967; 2456 pp.
\$31.00 postpaid

McGraw-Hill Book CO.
 c/o Trade Order Service
 Dept.
 Princeton Road
 Hightstown, N.J. 08520
 or Whole Earth

Table 10. Approximate Weights and Heat Values per Cord of Fuel Woods*

Variety of wood	Weight per cord containing 90 cu ft of solid wood, lb		High heat value per cord, million Btu		Equivalent in heat value to tons of coal†	
	Green wood	Wood with 12 percent moisture	Green wood	Wood with 12 percent moisture	Green wood	Wood with 12 percent moisture
Ash, white	4,320	3,690	26.0	28.3	1.00	1.09
Beech	4,860	4,050	27.1	31.1	1.04	1.20
Birch, yellow	5,190	3,960	27.2	30.4	1.05	1.17
Chestnut	4,950	2,700	19.2	22.7	0.75	0.80
Cottonwood	4,410	2,320	16.0	19.4	0.69	0.75
Elm, white	4,860	3,150	22.2	24.2	0.85	0.93
Hickory	5,670	4,390	29.0	35.2	1.12	1.36
Maple, sugar	5,640	3,960	27.4	30.4	1.05	1.17
Maple, red	4,500	3,420	23.7	26.3	0.91	1.01
Oak, red	5,760	3,960	27.5	30.4	1.04	1.17
Oak, white	5,670	4,170	28.7	32.3	1.10	1.23
Pine, yellow	4,770	3,140	23.7	26.0	0.91	1.01
Pine, white	3,240	2,150	17.5	18.1	0.62	0.70
Walnut, black	5,220	3,420	24.8	28.8	0.95	1.01

Australian Traditional Bush Crafts

Craft and survival skills from down under. Housing, furniture, leather working and net making, always with only the very simplest of tools. Though most of the material derives from Australia's European pioneers, they obviously learned a thing or two from the Aborigines. Nicely illustrated by the author.

-Richard Nilsen

Australian Traditional
Bush Crafts
 Ron Edwards
 1975; 143 pp.

\$6.95 postpaid

from:
 Schocken Books, Inc.
 200 Madison Avenue
 New York, NY 10016
 or Whole Earth



FOUR STRAND KNOT (EASY METHOD OF REPAIRING RINES)

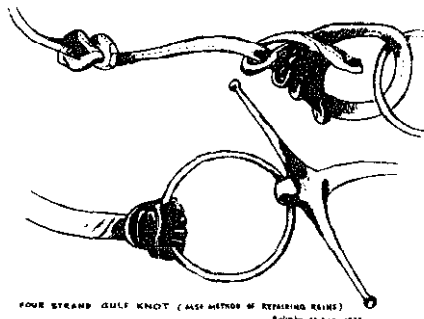

FOUR STRAND GULF KNOT (EASY METHOD OF REPAIRING RINES)

Dictionary of Scientific and Technical Terms

As technology becomes more complex, the language involved is increasingly laced with specialized words. Webster's isn't much help with these. McGraw Hill's is. As might be expected, you sometimes have to look up the words in the given definition too before you get the meaning e.g. "restiform body. See inferior cerebellar peduncle." Generally, though, the book is concise, clear, well illustrated, and easy to read. The discipline generating the word is indicated which makes it easy to tell where you can find out more about the subject in the definition. And the range of subject matter just has to be seen to be believed! Even as a technocrat, I've never before felt so strongly the immensity of technology. Insist your library get one.

- JB

McGraw-Hill
 Dictionary of
 Scientific and
 Technical Terms
 Daniel N. Lapedes,
 Ed.
 1974; 1660pp.

\$39.50 postpaid

from:
 McGraw-Hill Book
 Co.
 c/o Trade Order
 Service Dept.
 Princeton Road
 Hightstown, NJ
 08520
 or Whole Earth

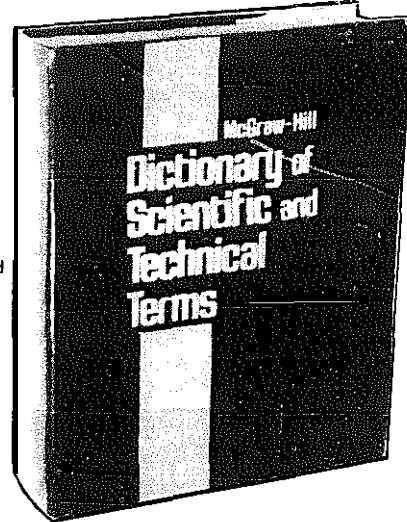

Lagrangian points [ASTRON] In planetary orbits, two positions in which the motion of a body of negligible mass (such as an asteroid) is stable under the gravitational influence of two other bodies (such as the sun and Jupiter), one of which is moving about the other in an approximately circular orbit; the two positions are located on the orbit, 60° ahead of or behind the orbiting body so that the three bodies form an equilateral triangle.

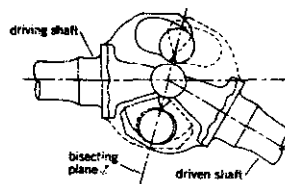

Rzeppa joint [MECH ENG]
 A special application of the Bendix-Weiss universal joint in which four large balls are transmitting elements, while a center ball acts as a spacer; it transmits constant angular velocity through a single universal joint.

Sharpening

I like this sharpening book the best of any I've seen because it tells you why you're doing it the way they suggest so you really learn something, and it only costs a buck.

-JB

A Manual on Sharpening
 Hand Woodworking Tools
 J. K. Coggin, L. O. Armstrong,
 G. W. Giles
 48 pp.

\$1.00 postpaid

from:
 The Interstate Printers
 and Publishers, Inc.
 Danville, IL 61832
 or Whole Earth

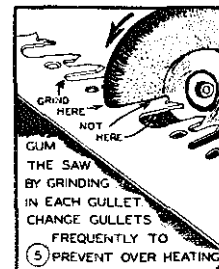

GRIND HERE
 NOT HERE
 GUM THE SAW BY GRINDING IN EACH GULLET
 CHANGE GULLETS FREQUENTLY TO PREVENT OVER HEATING

The Double Bubble Wheel Engine

A patent disclosure

BY STEVE BAER

To understand the invention it is best to first understand its elements. *Figure 1* shows a ring of 6 divers. The water level is indicated. The ports on top of each diver are open — the ring is horizontal and the water reaches the same level in each diver. If the ring is slowly rotated the water remains at essentially the same level in each diver. In *Figure 2*, the ring is shown tilted. The water has shifted to a new level, almost filling some of the divers at the low side and almost absent from the divers at the high side. If the ring is rotated in this position water alternately fills and empties individual divers. For instance as diver No. 1 moves towards the position of No. 3, it fills with water and as it continues on past the position of No. 3, it empties. The open ports allow air to enter as a diver empties and air to leave as a diver fills.

The ring is returned to the position of *Figure 1* and corks are inserted into the ports preventing air from entering or leaving. *Figure 3* shows the ring again tilted on its side. This time the water is at many different levels. The air captured in the lower divers prevents all the water from running into the lower divers. The size of the air bubbles in each diver may be approximately the same. The lower bubbles are somewhat smaller since the density of liquid multiplied by the difference in elevation between the level in diver No. 1 and No. 4 now compresses No. 4.

If the ring is rotated in this position there is a slight flow of water into the divers as they sink and out of the divers as they rise. The magnitude is a function of the ring diameter, fluid density, and gas pressure in the bubbles.

In "Gravity Engines and the Diving Engine" Baer spelled out the principles of a simple two-diver gas/liquid engine in the Summer '74 CQ. A month or so later The New Scientist ran a big article on a similar, if cruder, engine developed by British scientists. Neither went beyond models into application. This new diving engine of Baer's may be closer to making that step.

Steve Baer is the head of Zomeworks in Albuquerque, New Mexico, which designs and manufactures such advanced soft technology as Skylids, Beadwall, Zomes, and working solar buildings. Baer's books include Zome Primer and Sunspots.

—SB

In *Figure 4* two rings are placed on the same vertical axis. Diver No. 1 above diver No. 7. Their ports are now connected by a tube so that an air passageway exists between No. 1 and No. 7, but No. 1 and No. 7 are not connected to the outside atmosphere. Similarly for No. 2 and 8, 3 and 9, etc.

If the pair of so-connected rings is tilted as in *Figure 5*, the water assumes levels similar to the situation in *Figure 3*, but the relative liquid levels in the top ring are essentially the same as in the bottom ring. The gas pressure resisting the inflow of the water is the same in No. 1 as in No. 7.

When the pair of rings is rotated there is a compression of the gas and inflow of liquid at the bottom of the cycle — similar to that described in *Figure 3*. The resemblance of *Figures 5* and 3 is true only so long as the connected divers are in the same angular position on the axle.

Figure 6 shows the two rings with the relative positions rotated 60° lower than No. 1. The water levels in No. 1 and No. 7 were identical. As No. 7 is lowered the pressure from the liquid increases and the bubble rises through the tube into diver No. 1 leaving diver No. 7 largely filled with liquid and diver No. 1 largely filled with air. Rotating the pair of so-attached rings causes the air bubbles to move always towards the relatively higher of the connected divers — consequently the air is equally divided between the two connected divers every 180° as they come to the top and bottom position and is largely held by each diver for a period once every 360°. If the two rings are at the same temperature, there is very little resistance to turning in either direction because if the two rings are at the same temperature, the bubbles descending in one ring are the same size as the bubbles ascending in the other ring and there is no resulting turning force.

However if one of the rings is warmer than the other, the bubbles in the warm divers tend to expand more than the bubbles in the cold divers, with a resulting turning force that rotates the pair of rings such that the warm bubbles rise and the cold bubbles sink.

Patent Summary

The invention is a device for converting thermal energy into mechanical energy. Pairs of chambers (divers), one hot and one cold are connected with an intermediate regenerator so that a bubble of gas may pass from hot diver to cold diver through the regenerator. The divers are arranged about an axle so that as the engine turns the bubbles pass from hot

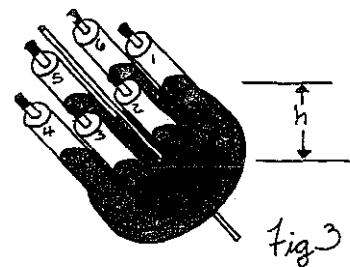
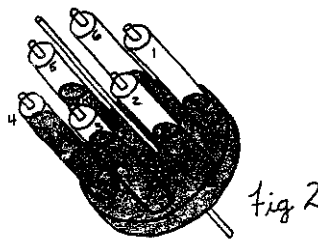
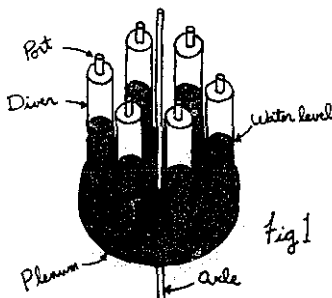

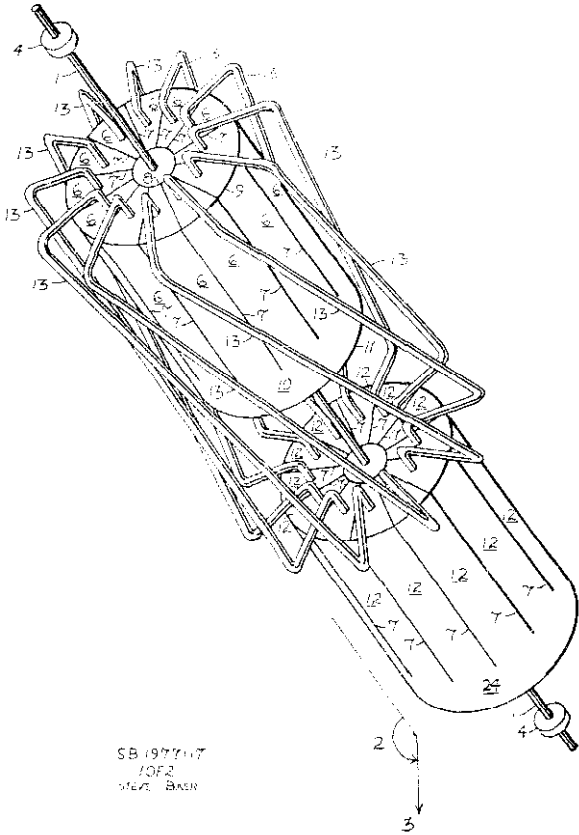

SB 1977-17
19F2
HELV. BASIN

One object of the invention is to build a device that can economically use a variety of heat sources, such as burning fuel, solar energy, or waste heat from other applications. Another objective of the invention is to build a device that moves as one part, but which is capable of collecting and storing heat and cold for its own operation. A further objective of the invention is to build a device that can easily be used as a heat pump or refrigerator. It is obvious that the engine, or multiples of the engine, can be arranged so that they spin about their own axes. They rotate the arrangement about an external axis so as to create a centrifugal field to increase the power output.

Comments

The problem with these engines is their relatively low power compared with their volume and weight. (See *Stirling Cycle Machines*, G. Walker, Clarendon Press, Oxford, 1973.) The engine shown in the photograph weighs about 80 lbs. and yet we have only coaxed about 1/3 of a watt from it. This is the first engine built and I believe we can increase the power to weight ratio. The first version had the rings connecting the divers made of 3/4" copper pipe. The small pipe restricted the flow of water from diver to diver and the engine exhausted itself by fluid friction at a very low r.p.m. [more →]

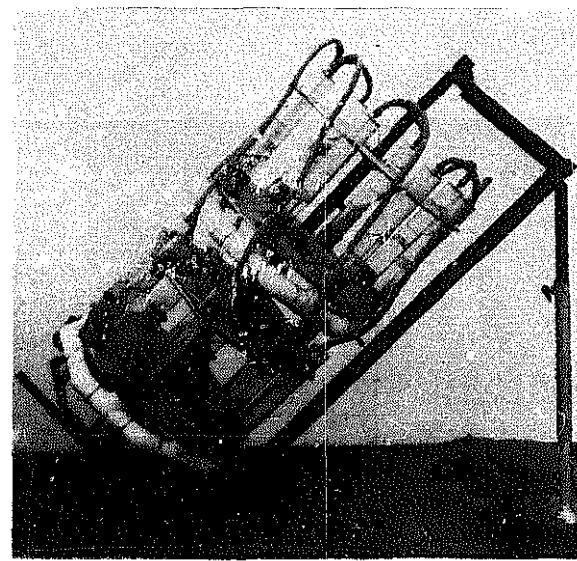

to cold to hot divers. The alternating expansion and contraction of the bubbles keeps the majority of liquid always on one side of the axle. The imbalance causes the engine to turn in a gravitational or centrifugal field. The cycle that powers the engine depends on the liquid, or liquids in the engine and the gas or gases in the bubble. A liquid with a relatively low vapor pressure, such as a low viscosity oil, and a high pressure bubble of a gas different than the vapor of the liquid, such as air, causes a cycle similar to that of a Stirling engine. A liquid with a relatively high vapor pressure, such as water, and a relatively low pressure of gas different than the vapor of the liquid, such as air, causes a cycle like that of a Rankine engine.

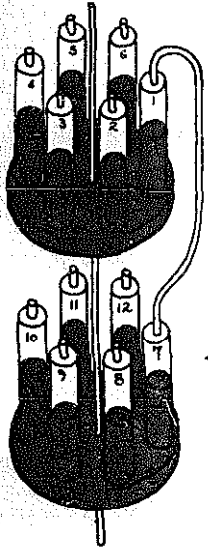

fig 4

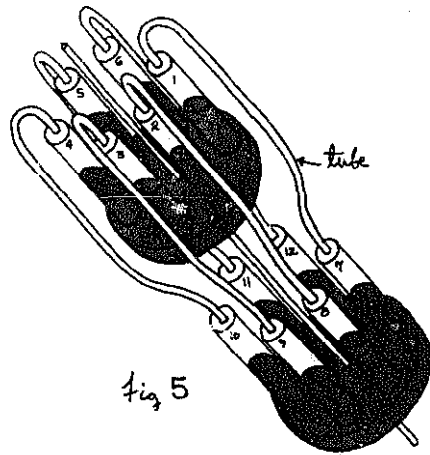

fig 5

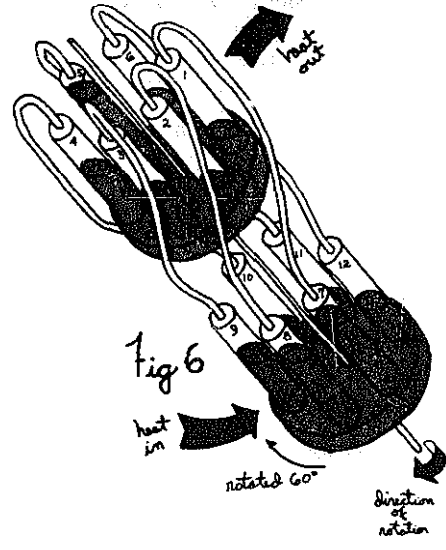
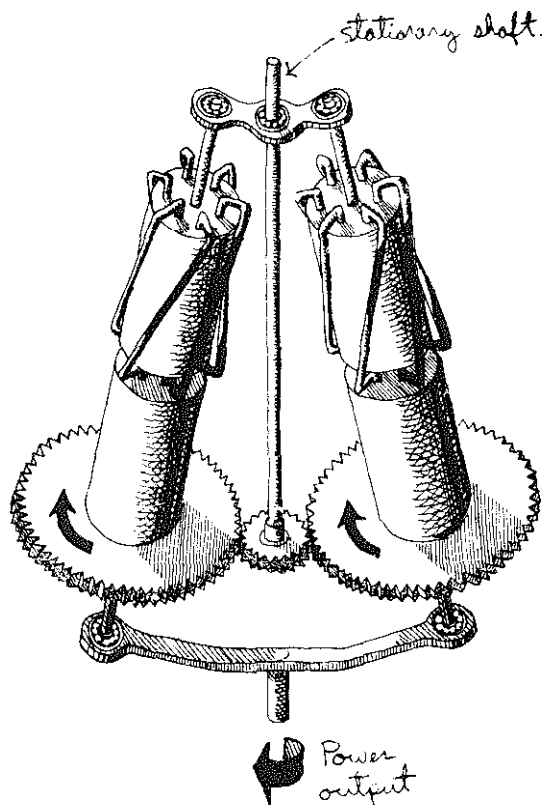

fig 6



We have not tried this yet. The power can be taken from the rotating assembly, which enjoys perhaps 10 to 100 or even more G's. The double bubble wheel is simply a rotating diving engine with only one moving part. Sunspots has a chapter on these - a slightly altered version of the article from the Summer '74 CQ. Once you have started playing with hot and cold liquids and bubbles it's hard to believe that there aren't simple engines ready to provide mechanical energy or to be run in reverse as heat pumps. It seems the double bubble wheel may be an answer.

If you let a double bubble wheel run without load, it reaches terminal velocity when all the energy is used to move liquid from diver to diver and gas from diver to diver. In the first version - which my son Jose and I got going on Saturday afternoon, 18 December, the terminal velocity - with cold divers at 60° F and hot divers at 125° F was about 3 r.p.m. and the power output was about 1.75 ft. lbs./min. Ten days later, after enlarging the rings from 3/4" to 2" pipe, enlarging the air hose from 5/16" to 1/2" and shoving Tuffy scouring pads up into the ends of the hot divers for heat exchangers, we got 17 r.p.m. and 15 ft. lbs./min. with 60° to 134° F.

There is great promise in enlarging the flow channels and divers. If you double the diameter of all the tubes in the engine, you not only increase the volume by 4, but you cut the head needed to move the water at the same velocity. Double the pipe diameter and the head is cut about in half for the same fluid velocity. The gases do better as the tubes get larger, but not quite so dramatically as the liquids.

It seems to be a matter of doing a number of experiments to confirm the advantages of changing scale. I don't know whether we have the design for an insect which we are trying to build the size of a dog or whether we have the design for a dog which we are trying to build the size of an insect. I suspect it is the latter.

The engine can have a low power density and still be useful. Even if it ran 24 hours a day to convert only 5% of the sunlight incident upon its hot divers into mechanical power, the engine would have a place as a water pump. The large volumes of water in the hot and cold divers mean that the same parts can act as collectors, cylinders, flywheel and heat storage. A cold clear night can be useful to the engine since as the temperature of the cold divers sinks, the power increases.

A promising way to increase the power output which Bill Mingenbach has been pointing to as the ultimate goal for all the gravity engines we have worked on these last years - is to have the engine supercharge itself by creating its own field. In the case of the double bubble wheel this is easy to design. Two or more wheels spin themselves rapidly about an external axis as they themselves spin slowly about their own axis. ■

ZOMEWORKS' PRODUCTS

Breadbox solar water heater

Zomeworks does it again. A solar water heater that needs no "collector". Steve Baer writes, "We have done a great deal of work on this kind of water heater and feel it is a good system for someone to build himself. They are bulky and heavy and are not very suitable for shop production and sale, but the simple construction methods make them right for backyard construction." Basically, the heater is a black water tank in an insulated box equipped with two glass walls to admit sunlight, and two insulated lids that reflect sun into the box during the day and close to keep in the heat at night. The plans are big, clear, and hand drawn in Steve's own inimitable style.

-- JB

Breadbox Water Heater Plans

\$2.50 postpaid

from:
Zomeworks
Box 712
Albuquerque, NM 87103

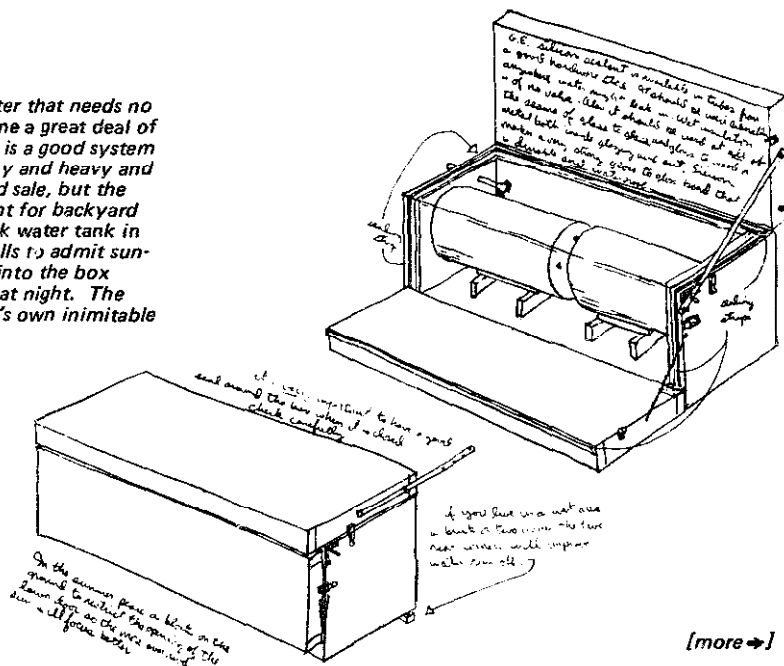

[more →]

Nightwall

Dear Stewart;

I am enclosing a sample of our magnetic Nightwall. Peel off the paper strips — place it against a window — press firmly above the magnetic strips — then pull the beadboard away. The strips stay. You can pop the Nightwall on and off as you want.

A single glazed window without the Nightwall has a U factor of 1.1 (it loses 1.1 BTU per ft² per hour per degree Fahrenheit temperature difference). With the 1" beadboard blanket, the U factor is lowered to .25.

What does this mean in energy savings? Let's assume that the Nightwall is left in place during 3/4 of the heating season — put on at night, taken off during sunny days. (See chart below.)

A fuel cost of \$2.5/kwhr is pretty high, but there are many places in the country where it is even higher.

What does Zomeworks sell to the customer? Beadboard is bulky stuff and expensive to ship. You can buy your own insulation locally and send for our clips and make the Nightwall panels yourself. We sell the magnetic clips — the branding iron for setting them, along with installation instructions.

Prices for 6" Magnetic Strips & Clips

20 (minimum order) and above	\$.30/ea
40 and above	.28/ea
100 and above	.26/ea
1000 and above	.24/ea

This price includes postage and handling to anywhere in the United States.

How many magnetic clips do you need? Roughly one clip for every 1-1/2' of perimeter around the windows. The Nightwalls are meant to fit one on each pane of glass. You can easily make 4' x 6' Nightwalls of 1" beadboard and our magnetic clips (16 of them). 1" beadboard costs about \$.20/ft².

Some of the variations we will sell on these: snap on convective heaters and coolers — and hinged freon operated south wall sky-lids.

The Nightwalls can be painted with latex paints (the outside should be left white, or painted white) — individual pieces of beadboard can be glued together along the edges to make large panels out of scraps. Thicker beadboard (2") can be used by the conservation zealot for Super Nightwalls. Small Nightwalls can be used effectively over TV sets.

— Steve Baer
Zomeworks
Box 712
Albuquerque, NM 87103



A small sample of Nightwall being set on its magnets by Diana Fairbanks. The real thing would fill the entire windowpane.

The Pro Heater

The Pro water heater must be the simplest design to make yet, and I can personally vouch for its performance: "hot water by noon." I also tend to agree with Steve Baer's claim that:

One great benefit from using the sun to heat your house and hot water is that it makes you feel better. Although untested scientifically, it is possible that exposure to the sun enriches the water or the house with orgone energy (or some other scientifically disreputable substance) improving the health, energy and spirits of the users.

And in a gallons-of-hot-water-per-buck comparison, this heater makes the \$1000 commercial outfits seem absolutely ludicrous.

— JB

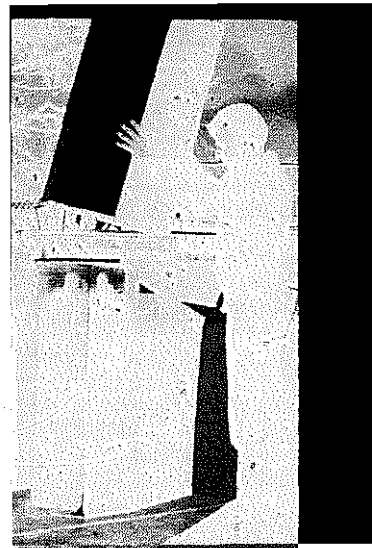

Baer and styrofoam "tea cozy" for solar hot water tank.

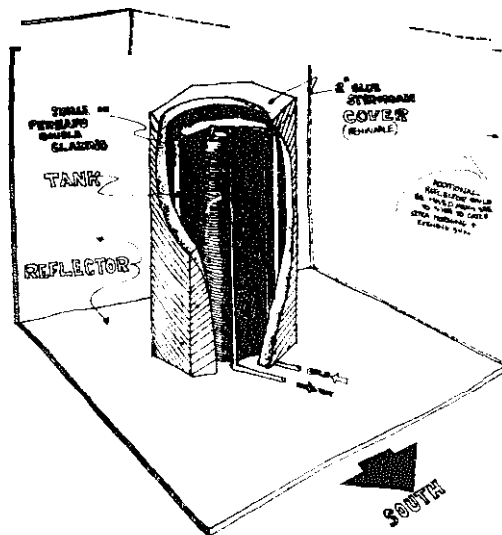

Sili Shutters

Marc Sherson of Zomeworks has performed some simple tests on thin aluminum shutters attached to a window by means of a thin hinge of silicone seal. Tests show that the shutters are more efficient than double glazing, especially if you consider that they are much better in keeping out unwanted heat gain too. This idea is part of an increasing tendency to regard walls less as fortress and more as controllable membrane like our skin.

— JB

Sili Shutters

write for information from:
Zomeworks Corporation
P.O. Box 712
Albuquerque, NM 87103



Shutter with Tab

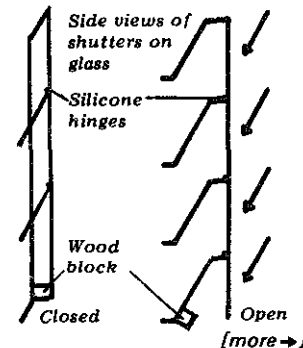

More from Zomeworks

Zomeworks also manufactures a host of other clever devices, and offers plans for still more. All are proven and work well. Herewith is a selection. Prices on request from Zomeworks Corporation, P.O. Box 712, Albuquerque, NM 87103. Phone (505) 242-5354.

- JB

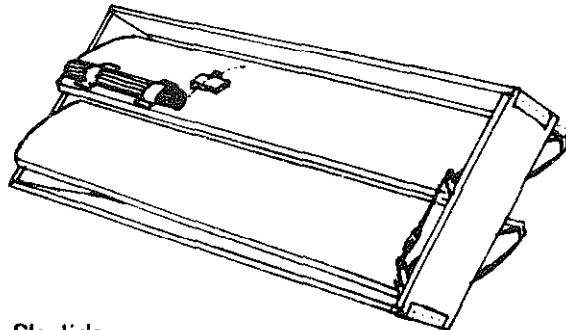

Skylids

Mostly used under skylights to control heat gain or loss, these shutters automatically open and shut as required. An ingenious activator uses no electricity.



Beadwall

A hollow transparent wall is blown full of styrofoam beads when it is desired to block sun or retain interior heat. Beads are sucked out to regain transparency. A 2-1/2" thick Bead-wall gives an R value of 8. Not only does this idea work well, it's fascinating to watch!

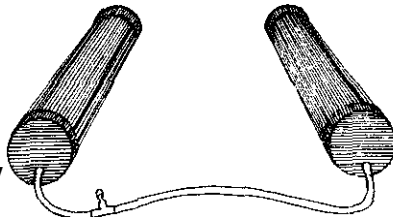

Solar Gravity Drivers

Freon shifting between two sealed cannisters provide the force necessary to operate vents, Skylids, and sun-tracking devices. There is an explanation in Sunspots.

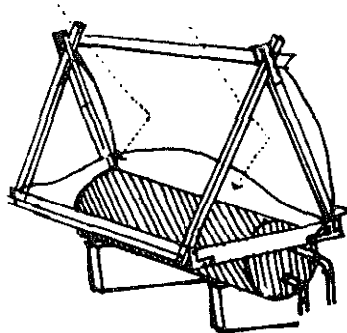

Skylight Water Heater

This application of the Breadbox principle has the tank mounted in a skylight equipped with reflectors.

Sun Calculator

With this device, you can tell the sun position for a given hour on a given day at any latitude.

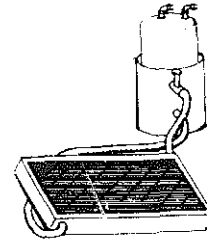
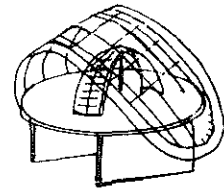
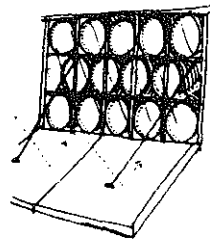

Drumwall and water heater

Zomeworks also sells plans for the famous Drumwall (50 gallon drums used to store water as a heat sink), and a hot water heater using a thermosyphon flat plate collector.

Sunspots

This is the deepest of Steve Baer's works and also the most crisply presented. Here is accumulated the experience of Zomeworks' ten years of successful experimentation, design, and delivery of solar energy systems. All that richly blended with Steve's J. G. Ballard-type fantasies (printed as "Energy Stories" in the Spring '75 CQ) and his acerbic criticism of federal energy studies, modern engineering text literary style, and the like.

If a real philosopher were a real engineer, he would write like this.

-SB

Sunspots

Steve Baer
1975, rev. 1977; 115 pp.

\$4.00 postpaid

from:
Zomeworks Corporation
P.O. Box 712
Albuquerque, NM 87103
or Whole Earth



A house is a shade sandwich — the roof on one side, the earth on the other.

When you are designing something it is important to know what you must be careful about and where you needn't be careful. Rafts are extremely simple to build. You can add anything you want — so long as it will float.

Bridges are not like rafts; enough weight added in the wrong place can break the bridge. Building a heat conductor is more like building a raft than a bridge. Anything added in parallel to a path along which heat is being conducted is an aid to the transport of the heat. So that in fabricating a heat exchanger, if you had some scraps of metal left over, you might just solder or weld them on the exchanger rather than throw them away.

NITINOL

BY FRED GARDNER

Illustrated by Carol Kramer

FIRST HEARD ABOUT the metal from Bob Trupin, an a-physicist making his living es a carpenter in San Francisco. He was wildly enthusiastic, and hearing his story about a wire that contracted with greet force when heated, I suspected he might have fallen for some Uri Geller bullshit. That would have been very unlike Trupin, but the collapse of your society does funny things to people.

In the kitchen he proceeded to demonstrate: dipped into a glass of cool water a Nitinol wire bends easily in your fingers. Transferred to a glass of hot water it springs back to the straight position with remarkable force. It is an amazing phenomenon, and there is simply no conveying its impact.

Nor is there a definitive explanation of the solid-state phase transformation that Nitinol undergoes when heated. Despite its seemingly unique properties, it has been studied in depth by only a few scientists and not used much in industry.

Nitinol is an alloy of two abundant metals, nickel (53% to 57%) and titanium. It was developed in 1958 at the Naval Ordnance Laboratory — hence Ni, Ti and N.O.L. It is a strong, heat-resistant, lackluster gray metal. The Navy was more interested in its corrosion-resistant properties than in its “shape memory” (the ability of certain metals to resume their original shape after being deformed). A guitar string has a memory: bend it into a U-shaped loop and it will snap back when you release it. What’s special about Nitinol is that it bends in response to a very small reduction in heat and then forgets to spring beck until it is reheated. It also contracts when heated and stretches when cooled. A hypothetical explanation is that in the heated state its molecules are locked into a lattice arrangement, whereas in the

cool state they rearrange themselves along more parallel planes that make for easy slippage.

The Navy toyed with the idea of using Nitinol to build satellite antennas (they pay off in military applications) but eventually lost interest in it. The Air Force uses Nitinol fasteners to couple structural members on bombers. The Edmund Scientific Company used to sell a small novelty item called the “nitinol experimenter’s kit” but dropped it almost 5 years ago. Suffice it to say that for many years after its discovery, nobody took Nitinol very seriously.

Until Ridgway Banks got his hands on some in 1973.

Banks is a 41-year-old inventor and musician employed es a technician et the Lawrence Laboratory in Berkeley. For some time he had been trying, on his own, to develop a solar-powered steam engine. He had reluctantly concluded that solar energy was too diffuse to convert water into steam economically. But he knew that inexpensive solar collectors could provide ample hot water. The only question was: how do you get mechanical work OUT of hot water?

It was at this point that a co-worker, Pete Schwemin, gave Banks his own untested nitinol experimenter’s kit. Not having a torch on hand to heat the wire cherry red. Banks decided to dip a piece into a coffee pot. “Here is a discovery I have not made,” he later wrote. ‘How to describe in words what it feels like to have an inanimate piece of metal suddenly come alive in your hand. The force and speed of the nitinol shape-memory response can be measured, of course, but it has to be felt to be believed.” Banks felt he had come upon the material that would make a roof-top heat engine feasible. Or one that could run on the industrial wastes being poured into rivers and

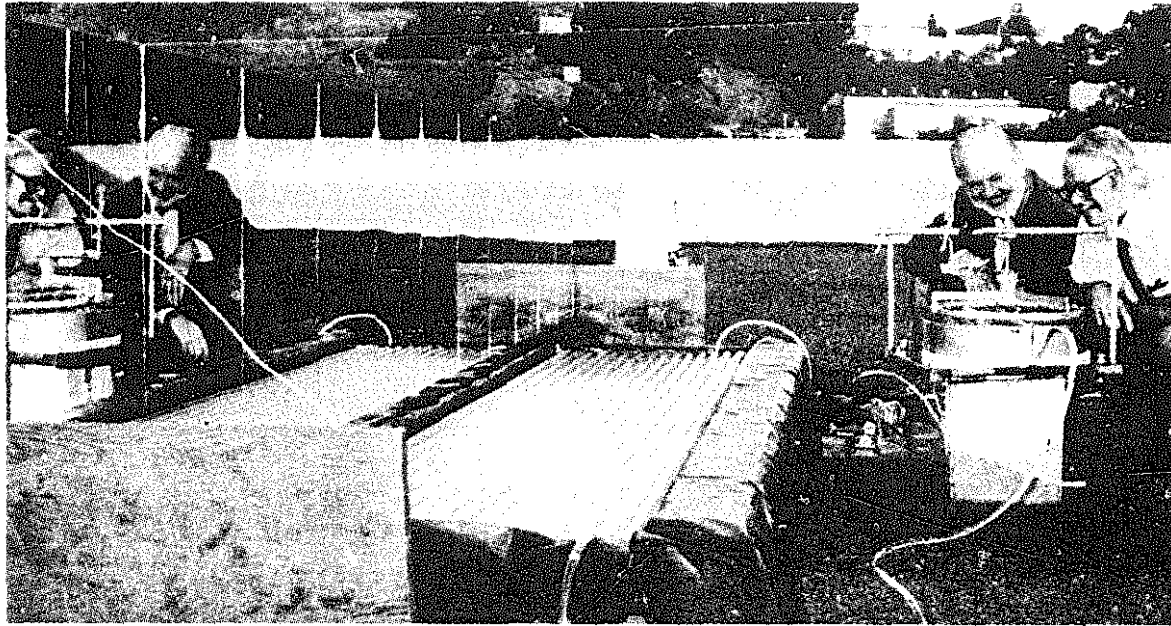

ROOFTOP ENGINE devised by Ridgway Banks (right) runs on hot water provided by a solar collector made from fluorescent-light tubing. The Banks engine converts heat energy to mechanical energy by means of a nickel-titanium alloy called Nitinol. Mirrors and black plastic maximize the heat provided by the sun. The scene is the roof of a building at the Lawrence Berkeley Laboratory, and the enthusiastic observer is Dr. Harry Heckman, who encouraged Banks to work on Nitinol.

streams in the form of "heat pollution." Or even temperature differentials within the ocean. By varying the percentages of nickel and titanium you can vary the "threshold temperature" at which nitinol producer mechanical work from -150° to $+150^{\circ}$ C.

But Banks' elation wasn't shared by the men who control the money. He recalls that along his fund-raising route, "No one I met had ever heard of nitinol, but few were slow to point out its potential limitations. They all mentioned the problem of efficiency and future economic competitiveness." He couldn't answer the efficiency question because the most basic studies of nitinol's physical characteristics hadn't been undertaken. And he couldn't talk about its economic competitiveness before even a prototype engine existed. He was in a bind.

Eventually Banks' supervisor, Harry Heckman, diverted some money from his own heavy-ion research project to enable Banks and machinist "Hap" Hagopian to build a prototype engine. It consisted of a horizontal wheel, about 12 inches in diameter, attached to the bottom of a vertical shaft. From each of the 20 spokes dangled a 6-inch, U-shaped loop of nitinol. (See illustration.) The Banks engine produces work when the wheel is lowered into a round pan divided into semicircles of hot and cold water. As the nitinol loops hit the hot water they straighten out, creating a piston-like motion along the spokes. The wheel starts turning and gets up to a rate of about 70 R.P.M.

Banks and Hagopian tested their device at the Lawrence Lab on August 8, 1973. It ran without an adjustment or a hitch. An enthusiastic observer, Nobel laureate Dr. Edwin McMillan, scribbled the first output calculations on a Kleenex box as the engine lifted a light hammer off the floor. (Today, after some 17 million rotations, the engine is as efficient as ever, generating about half a watt.)

Having built a successful prototype, Banks sought a \$190,000 grant from the National Science Foundation to do fundamental studies on nitinol and to build several small engines testing its properties. Eventually the NSF pledged \$113,000—but there were two catches. They wanted to see a 1 to 3 kilowatt engine produced—a "break-through" that could prove nitinol competitive with existing turbines. (A kilowatt is enough power to run a home air conditioner or ten 100-watt bulbs.) The second catch was that Banks couldn't direct his own project. He was a mere technician, and Lab rules stipulate that only department heads, senior scientists and university faculty members can take financial responsibility for a research program. The formal—and as it turned out, actual—leadership of the engine-building project went to H. Paul Hernandez, head of the mechanical engineering department.

Hernandez and his assistant, Jack Gunn, designed an elaborate "test-bed" engine that they hoped would give the NSF its kilowatt of work. (See illustration.1 The gist of it is that two non-parallel "wobble plates"

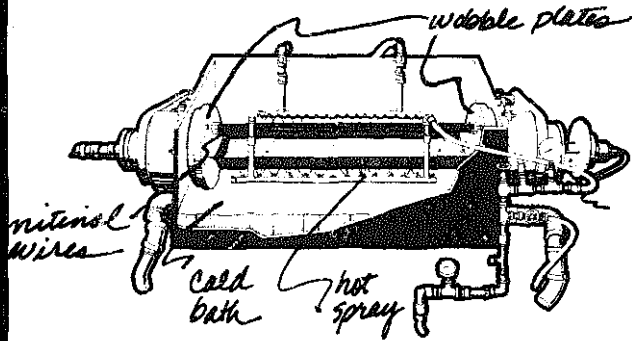

TEST-BED ENGINE built by H. Paul Hernandez and Jack Gunn uses nitinol wires strung in tension between two non-parallel wobble plates. The plates are connected by a synchronizing shaft (not shown) so that they turn together. During the top half of the cycle, nitinol wires are sprayed with hot water, causing them to contract and exert a rotational force on the plates. Cold bath is at bottom. Only one "wire element" is shown.

are connected by 70-centimeter-long nitinol wires strung in tension. The wobble plates are connected by a synchronizing shaft so that they turn together. Any two corresponding points on the plates will get closer through half their cycle of rotation, and further apart through the other half. During the top 1804 the wires are sprayed with hot water, causing them to shorten and pull the plates around. The wires then descend into a cold bath and relax.

Unfortunately the test bed engine has not produced good initial results. Stringing the wires in tension resulted in their going slack after relatively few rotations. Banks, who has hopes that adjustments can salvage the thing, comments "perhaps not enough allowance was made for what the wires want to do."

More promising results have been achieved by another inventor working at the Lab, Dave Johnson, who received a Small fraction of the NSF money to develop a continuous-band engine. In the Johnson engine (illustrated) there are two drive pulleys of unequal size on a single shaft (top), rotating with the same angular velocity. A continuous coil of nitinol makes a figure-8 path from the larger of the drive pulleys to an idler pulley in cold water, and back to the larger drive pulley. The section of nitinol wire connecting the larger drive pulley to the smaller one (via the hot bath) is trying to contract. As it does so it pulls with equal force on the two of them; but since they are different in size, a difference in torque is created. (The wire stretched around the top half of the larger drive pulley shrinks enough in the hot bath to fit over the smaller one.) The continuous movement of the wires over the system of pulleys leads to a work output as high as 2.2 watts along the shaft.

Johnson is currently weaving a belt of nitinol wires — a simple way of making his engine more powerful. His latest model consists of horizontally arrayed pulleys; it incorporates tubes between the hot and cold sides that facilitate heat exchange between the to-be-

EARLY JOHNSON ENGINE uses a continuous band of Nitinol in coil form. Two drive pulleys of unequal size are mounted on the same shaft (top). Nitinol heads from the front of the larger drive pulley down to an idler pulley in a hot water bath (middle) and then back up to the smaller drive pulley. It then goes down to another idler pulley in a cold bath (bottom) and back up to the larger drive pulley. The nitinol connecting the two drive pulleys, via the hot bath, is trying to contract. It pulls with equal force on the two; but since they are of unequal size, a different twisting force is created and the wheels spin.

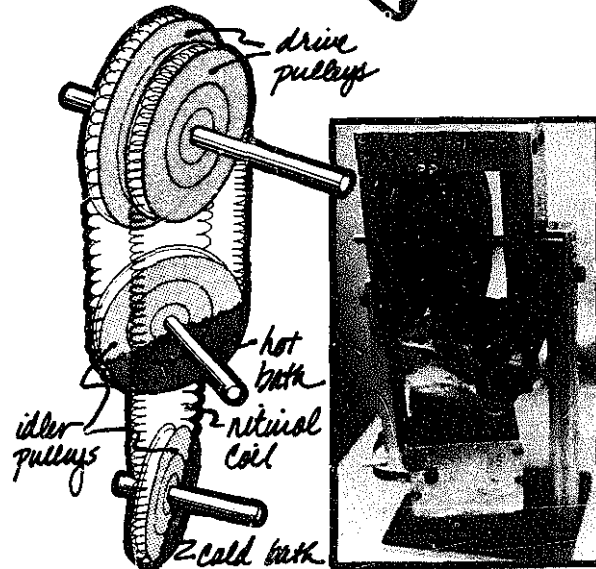
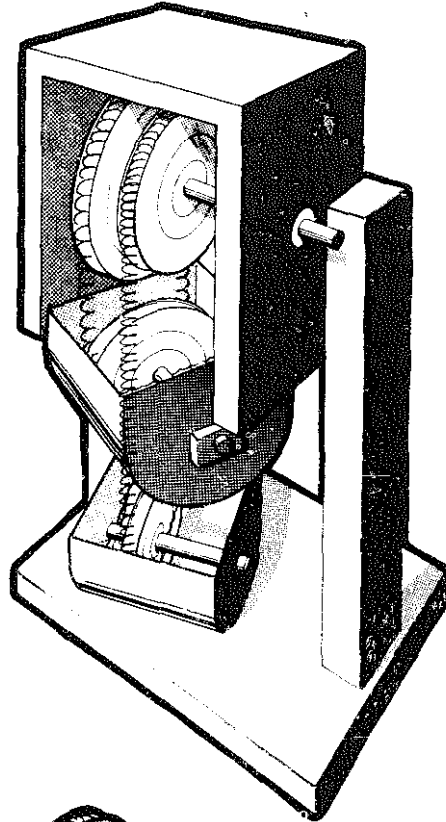

NITINOL CONTRACTING in the hot bath (middle) can then fit over the smaller drive pulley (top). Proportions of the two pulleys have been exaggerated for purposes of illustration.

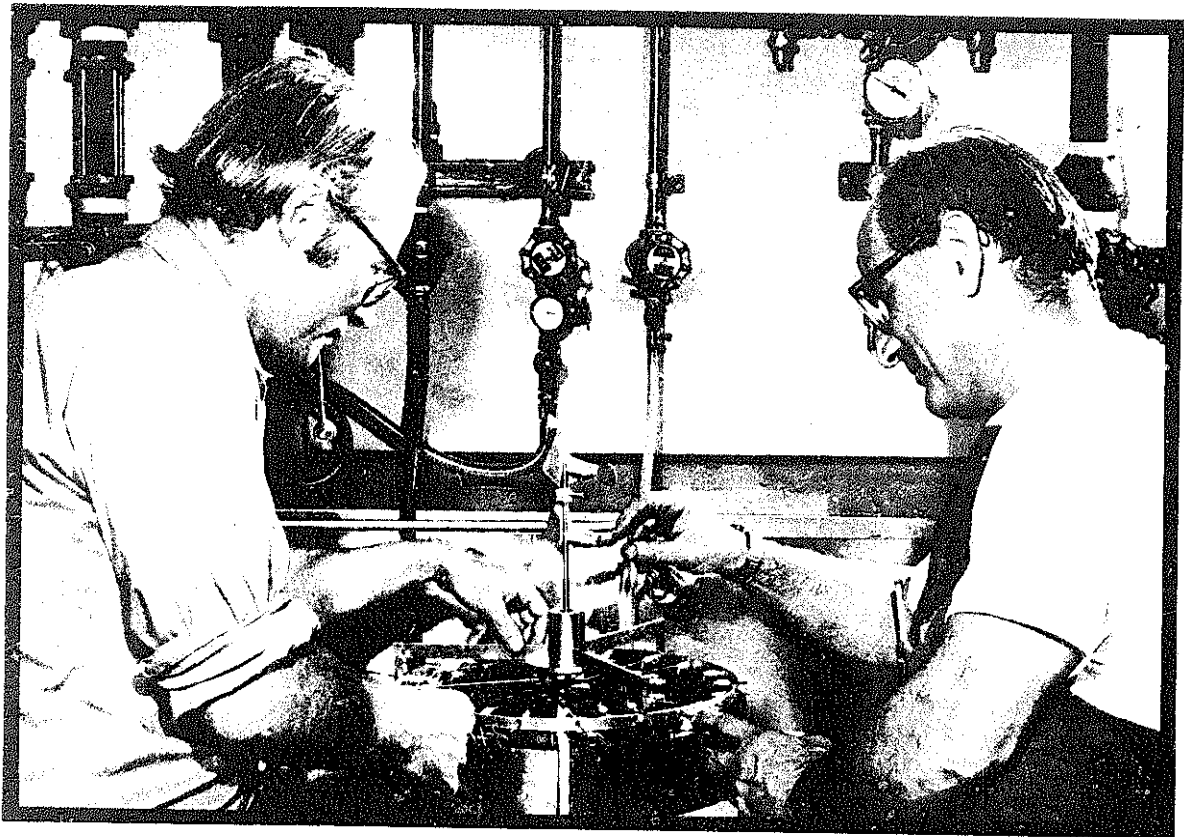

RIDGWAY BANKS (left) and machinist "Hap" Hagopian with the first successful nitinol engine. It was put into operation at the Lawrence Berkeley Laboratory, in August, 1973.

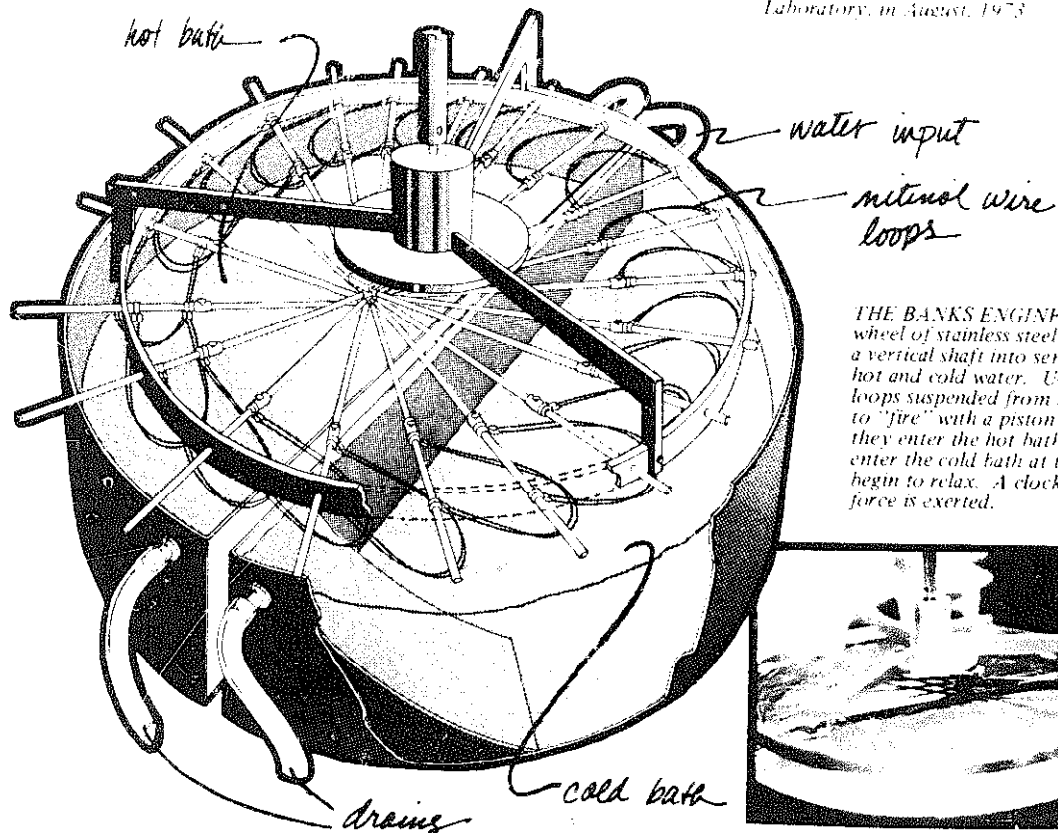

THE BANKS ENGINE is a horizontal wheel of stainless steel, suspended from a vertical shaft into semicircular baths of hot and cold water. U-shaped nitinol loops suspended from the spokes begin to "fire" with a piston-like motion as they enter the hot bath (left). As they enter the cold bath (right), they begin to relax. A clockwise rotational force is exerted.

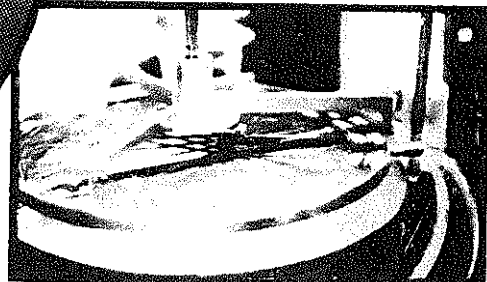

heated and to-be-cooled sections of wire as they head in opposite directions.

One problem Johnson has yet to overcome: the electron-beam welds that connect a length of nitinol wire into a continuous loop tend to break. This might be readily solvable if Johnson could obtain nitinol that had been annealed in an O-shaped ingot. But the only company that makes the alloy, the Titanium Metals Corporation of America, far from going to greater lengths to meet the inventors' specifications, wants to phase out of the business altogether. Nitinol is a minor sidelight of their operation, and a spokesman for the company says that aside from the recent spate of interest from Bay Area inventors, there is virtually no demand for it.

Which is a profound mystery to Banks, Johnson and others who see nitinol as the leading contender in the solar energy sweepstakes. My friend Bob Trupin wonders whose interests are served by suppressing nitinol research? The Arabs? The power companies? "Isn't it amazing," he says. "There's no money in this country, despite all the talk about the energy crisis, for a project that could end our dependency on oil. They don't intend to scrap any of their existing technology. And there's no way for the big utility companies to cash in on nitinol. It lends itself to a small rooftop unit where the sun can heat up a pan of water. You look at this wire and you see an engine that's... I guess small is what they really hate. Only big is good. 'Big of you' has replaced 'white of you.' "

Trupin has decided to give science another whirl. He's got a design for a pump that takes advantage of nitinol's ability to contract when heated (with a force he calculates at 67,000 pounds per square inch). He intends to go nowhere near the Lawrence Lab (where he once worked); nor will he approach the NSF with his idea. "They're all stalemated," he contends. "Banks and Johnson can't help but be effected by the fact that whatever they come up with -when

they're allowed to work at all they owe to the AEC, which is the real power behind the Lawrence Lab, not the University of California. I'm no big advocate of 'the private sector,' let alone hippy-bullshit-tinkering, but all the establishment doors seem to be closed. Whether it's an oil conspiracy or just office politics, who knows? The science bureaucrats nowadays all pay lip service to 'finding alternatives to fossil fuel' but deep down they think solar energy is form. Nitinol especially."

And that's where things stand. Ridgeway Banks' great enthusiasm for nitinol is equaled only by the difficulties he has encountered in getting sponsorship for his research ideas. Dave Johnson's conviction that he has an efficient prototype is tempered by a certain wariness as to the commercial feasibility of developing it. The Hernandez/Gunn test-bed has yet to produce satisfactory results. Most of the creative thinking about nitinol these days seems to be coming from drop-out scientists and inventors who have been passing samples of the metal around smoke-filled kitchens and doodling out designs for world-saving devices. □

Since 1975, when this article first appeared, nitinol is still unexploited and unreported upon. Banks' original engine has been through tens of millions of cycles with no failure or sign of fatigue. In fact, incredibly enough, it is now running 50% faster at the same temperature than when it was made. No one knows why, though Banks speculates that the nitinol wires have acquired a "double memory." By now there is an informal network of 15 people in various locales independently working on nitinol engines. One of them, they know, is going to develop the commercial device that will give all of them employment. Nitinol is still hand-made, though that may change soon, and it costs a couple hundred dollars a pound from the Naval Surface Weapons Center at White Oak, Maryland (contact Dr. David Goldstein).

-SB

In early 1977 Ridgeway Banks demonstrated his original nitinol engine - still going strong after four years of constant use - to a fascinated audience at the office of California Governor Jerry Brown (left). Buckminster Fuller (right) also looked on with interest. In his remarks Banks noted that what's unusual about nitinol is not that it remembers its shape - "every metal in your car does that, or it would be a puddle." Nitinol's special talent is that it can forget its shape, and then remember it again.



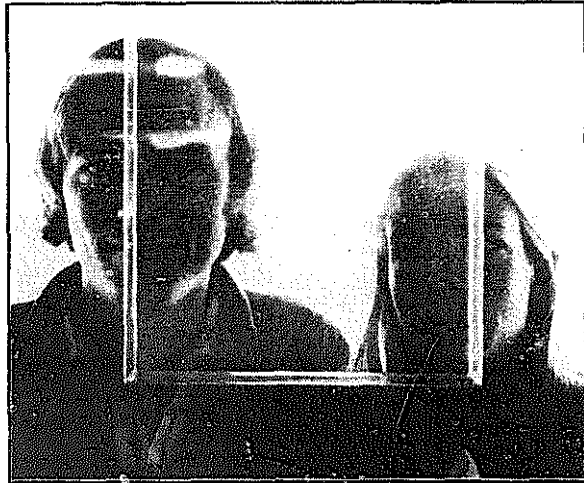

Looking through a pane of HEAT MIRROR mounted 3/8" from a glass window are John Brooks and Sandy Jones of Suntek. Though transparent, the HEAT MIRROR has the heat-containing properties of 1 inch of foam insulation.

BUILDINGS AS ORGANISMS

BY DAY CHAHROUDI

Suntek Research Associates
500 Tamal Vista Blvd.
Corte Madera, California 94925

Molecular soft technology: Heat Mirror, Cloud Gel, and Thermocrete

Heat Mirror

Imagine an insulating material which is also transparent to light. It sounds like a contradiction in terms. Such a material would prevent the flow of heat and yet would hardly be visible. We have developed such a material and will be manufacturing it in a totally automated factory in a year or so for less than a dollar per square foot. Eventually it may cost less than conventional opaque insulations. It is a coating, about one thousand atoms thick, that can be put onto any plastic film. Because the coating is so thin, the coated film looks just like the uncoated film but the material is made from and their structure are carefully arranged so the coating reflects heat. That is to say, it reflects thermal or infrared radiation, which is just like light except it has a longer wavelength and is thus invisible to the eye.

Because infrared radiation is invisible, most people (including many engineers and architects who should know better) don't realize what a large role radiation plays in the movement of heat in everyday life. The recent introduction of infrared cameras is beginning to stimulate awareness of thermal radiation. If you could see it, any energy consuming device such as an oven or an automobile would glow brightly and any cold place, such as an open icebox or the night sky; would appear black.

The coating that we have developed reflects thermal radiation, a property normally possessed only by polished metal surfaces, and this reflectivity makes the coating an effective thermal insulation. Even though the coating is a hundred times thinner than a piece of paper (which is why it is so cheap) it can insulate as well as an inch of plastic foam or glass wool insulation when it is used with a dead air space. This is stepping lightly indeed in the consumption of dollars, energy, and human effort. We call this coating "Heat Mirror."

Cloud Gel

As long as we are imagining things, let's imagine another plastic film, one that is perfectly transparent and indistinguishable from an ordinary plastic film until it is heated above a certain critical temperature, at which point it turns white -- an opaque white that reflects light without absorbing it. Imagine also that this temperature induced change is thoroughly reversible; that as soon as the film is cooled below its critical temperature, it becomes transparent again. We have developed such a material -- called "Cloud Gel" -- and are convinced it would also be inexpensive to manufacture. It switches from transparent to white and back again instantaneously over a temperature change of only three degrees. This transition temperature can be tuned to any value between 0° and 100° C by adjusting the proportions of its constituents.

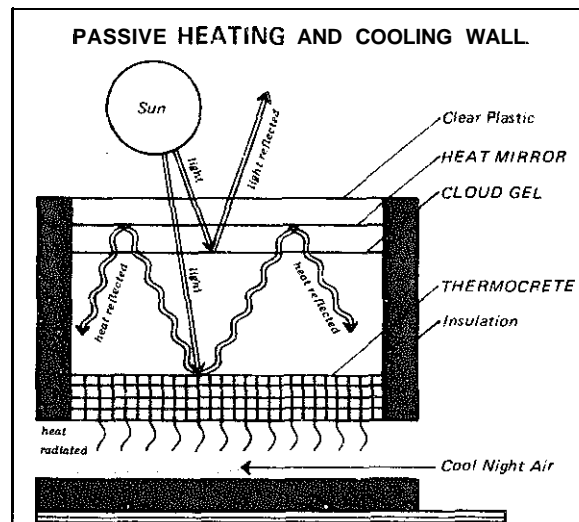

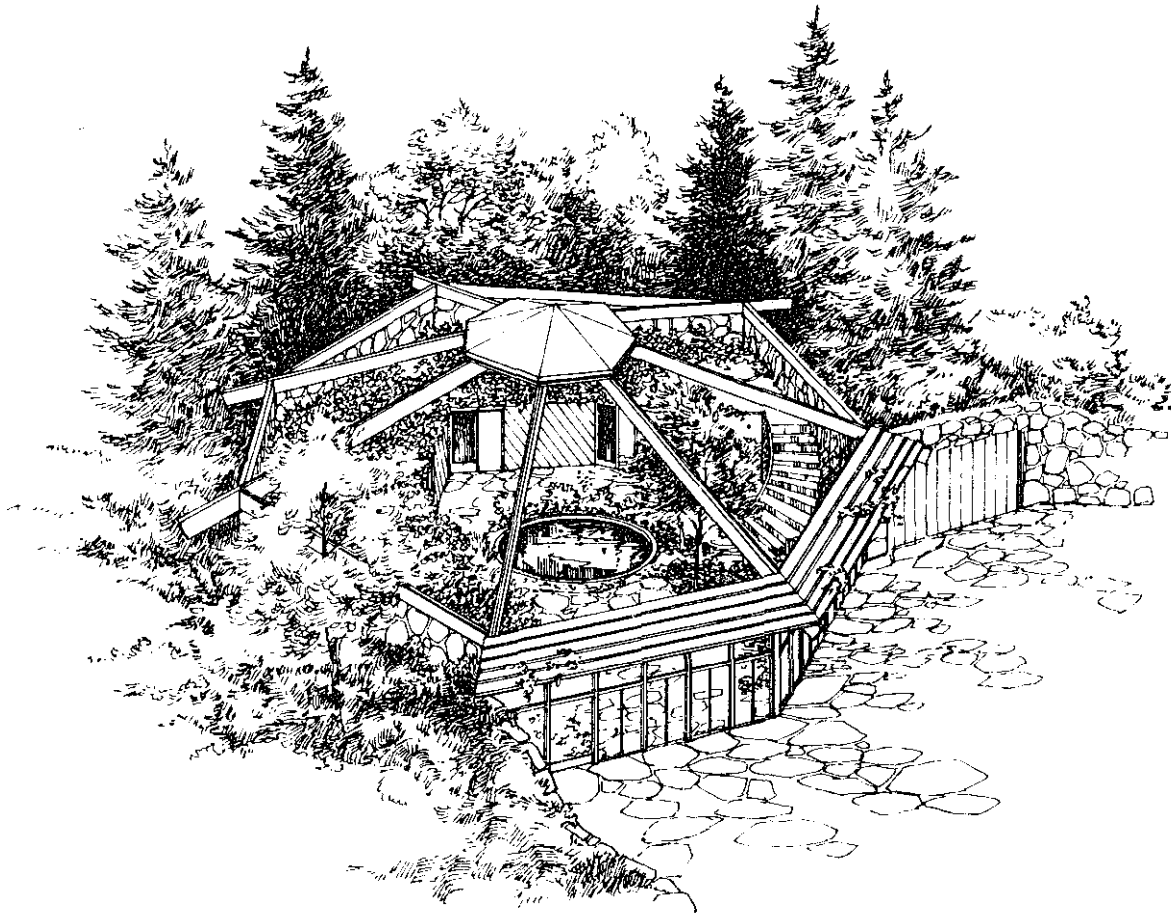

Like a one-celled organism, a house using HEAT MIRROR and CLOUD GEL as roof and THERMOCRETE for internal heat storage will respond homeostatically, maintaining a constant interior comfort by selectively exploiting the exterior fluctuations of temperature and weather. Since the materials are temperature-tuned at the molecular level, almost no mechanical devices are needed.

The Cloud Gel is made from plastic molecules which are likelong chains. These chains are dissolved in a solvent where they thrash about in a tangled mass much like spaghetti in a pot of boiling water. Since the diameter of these chains is much smaller than a wavelength of light, the light cannot "see" them anymore than a large fish swimming in a straight

line through a sea of spaghetti could distinguish individual strands. Physicists would call this an example of the uncertainty principle. Thus the plastic solution appears perfectly homogeneous and transparent to the eye in spite of its fine structure. The plastic chains are dissolved in the solvent by virtue of their attraction for smaller and roughly spherical solvent molecules which coat them to form a "cage" much like the insulation around a wire. As the solution is heated, the chains thrash about with more and more violence (thank God we can't hear them) until finally a temperature is reached at which the cage is broken and the solvent molecules are cast off. At this point, the plastic molecules become insoluble in the solvent.

Now an interesting thing happens Without the solvent cage the chains and solvent repel each other and they try to reduce the surface area where they are in contact. The chains accomplish this by curling from their extended position up into balls like spaghetti wound on a fork. Of course the diameter of these balls is much greater than the diameter of the chains. In fact the balls are now large enough to deflect our fish (light particles) from their straight line paths when they bump into them. This change from extended interwoven chains to separate balls is observed on the macroscopic level as a change from transparent to opaque white. The light is scattered randomly from its straight line path and the information contained

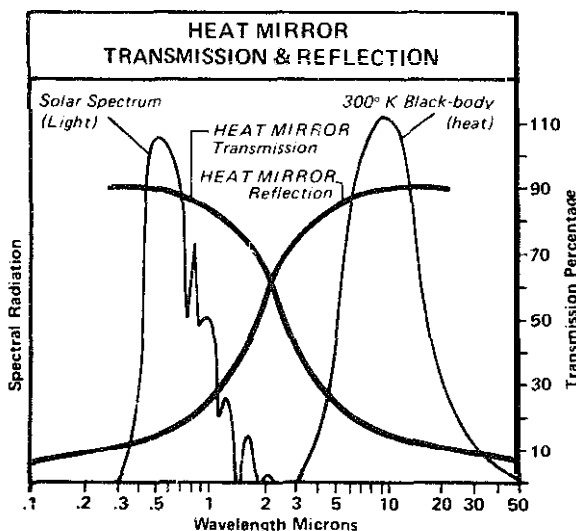

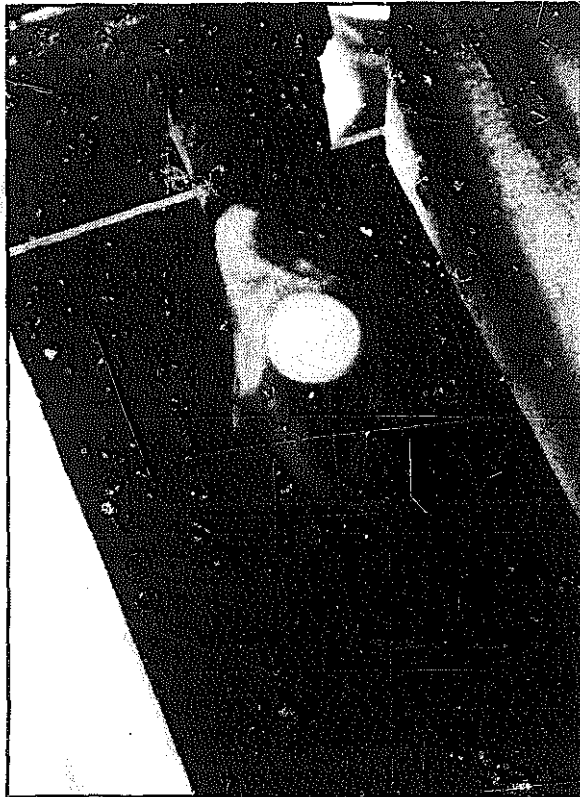

Lighting a cigarette lighter under a pane of glass coated with CLOUD GEL demonstrates the shift from transparent to white-opaque with a rise in temperature. The transition takes place in less than a second.

in the image the light transmits is lost. When the solution is cooled, the whole process is reversed — the bails unfold, reacquire their solvent coating, and the Cloud Gel becomes transparent again. Of course the plastic and solvent molecules are specially designed to have these relationships.

Thermocrete

Now imagine a concrete block, one that can store twenty times the amount of heat that an ordinary block can and furthermore without a change in temperature. How can heat be stored without a change in temperature? Consider a glass of ice water. Since the ice and water co-exist, the temperature must be 0°C — the freezing point of water and melting point of ice. If heat is added to the ice water, the temperature cannot rise until all the ice has melted. Similarly, if heat is removed, the temperature cannot be lowered until all of the water has frozen. A scientist would call this an isothermal situation since large quantities of heat can be exchanged without attendant temperature changes. The temperature of the glass of ice water is self-regulating. Now every material has its own melting point, so if we want to store heat (or “cool” which is really another way of looking at the same thing) at some particular temperature, we merely select a material which melts at that temperature. Since the changes in molecular structure and organization are much greater in the solid-liquid transition than they are in simply heating and cooling a material, the quantities of heat involved are similarly greater.

Unfortunately most materials when cooled a bit below their freezing point do not crystallize but remain liquid unless there is a “seed” crystal for them to crystallize around. That is to say, it is easy to make a crystal grow, but hard to create one from a pure liquid by just cooling it. Another problem is that most materials, unlike water, are made from several components which on freezing can form a variety of different solids, each with different proportions of the components. These other solids generally store much less heat and store it at the wrong temperature. A third problem is that like the ice water, which needs a glass, these materials also need a container to prevent things from getting messy. All of these problems can be solved by incorporating the heat storage material into the very fine pores in foamed concrete. The concrete initiates crystal growth by acting as a seed, it keeps solid and liquid components from separating by the fineness of its pore structure which insures that the sought after compound is formed on freezing, and the concrete acts as a structural container for the thermal storage material when it is in its liquid state.

We call this material which we are developing “Thermocrete.” For a room temperature melting point its main ingredient is calcium chloride, the stuff they throw on streets to melt ice. We can select other salts to store heat at many temperatures between 0°C and 100°C. Laboratory samples have withstood one thousand freeze-thaw cycles with no measurable loss in the amount of heat stored. The compressive strength of Thermocrete is one thousand pounds per square inch, approaching ordinary concrete.

Combined

So now we have three new materials — a material which transmits light but not heat, a material which transmits light when it is cool and reflects it when it is hot, and a material which stores heat and cool without getting warmer or cooler. So what?

Well! suppose one were to lay a stack of these materials out in an open field as is shown in the first drawing, what would happen? Assuming it is a sunny day, sunshine will pass through the Heat Mirror and Cloud Gel and will be absorbed on the Thermocrete where it will turn into heat. Since the heat cannot escape through the Heat Mirror, it will go into the Thermocrete where it will melt the heat storage material in the Thermocrete. We have thus trapped and stored the sunlight.

When all the heat storage material has melted, and only then, the temperature of the Thermocrete block will start to rise. If we have set the temperature at which the Cloud Gel turns from transparent to white a few degrees above the temperature at which the Thermocrete melts, then only after the Thermocrete is completely charged with heat will the Cloud Gel turn white. Thus the Cloud Gel prevents the sunlight from overheating the Thermocrete. The Cloud Gel does not respond to outside temperature changes because it is insulated from them by the Heat Mirror. Nor does it respond to sunlight, being activated solely by temperature. So, during a sunny day, this stack of materials rises to a temperature in the narrow range

(70° F to 75° F) between the transition temperature of the Thermocrete and the transition temperature of the Cloud Gel, and stays there.

What happens at night or during a cloudy day? Heat slowly leaks out of the Thermocrete through the Heat Mirror, and the Thermocrete slowly freezes without cooling. Calculations show that if the Thermocrete melts at 70° F and the temperature averages 30° F outside, and we are using two layers of Heat Mirror, then over a 24-hour period a layer of Thermocrete only one third of an inch thick will freeze. This is a measure of how good an insulation the Heat Mirror is and how good a storage material Thermocrete is. Calculations also show that on an average January day in Boston there will be enough sunlight falling through our stack of materials to melt two third, of an inch of the Thermocrete. Thus we see that even in the grip of the Terrible New England Winter, our stack of materials easily maintains a comfortable 70° F day and night by captured and regulated sunlight.

Thermocrete is also useful for cooling in the summer, especially in hot dry climates where the nights are usually below 70° F even when daytime temperatures reach 100° F. This is done as follows. During the night the Thermocrete is cooled by placing it in contact with the cool night air by using either natural convection or fans. If you'll remember our glass of ice water, you'll see that the Thermocrete can store large quantities of "cool" just as it can store heat, and it stores this cool without a temperature change. This is the beauty of storing heat and cool by melting and freezing. Since the Heat Mirror and Cloud Gel isolate the Thermocrete from the heat and sunlight of the day, the cool collected and stored during the night trickles out very slowly during the day. This "ratchet effect" is useful most of the time even in hot humid climates, but it won't work all the time in the deep south where the summer nights are usually above 70° F. When this happens the Thermocrete can't freeze.

In summary, these three materials can maintain a comfortable year round climate by utilizing locally available and natural (free) energy sources — sunshine and cool night air. This remarkable winter and summer performance has been borne out by experiments and computer simulations. It is done with no moving parts except molecules, electrons, and photons, which don't wear out, and with materials which are extremely cheap. The simplicity and elegance resulting from the design of building materials on a molecular level is reflected in their cost effectiveness. Other climate control systems requiring energy inputs and active elements will find it difficult to compete with the combination of these materials in the market place.

Organism

Now we can see where the title of this article came from and what the viewpoint is that unities these three materials. It is the biological analogy which gave the direction for their development. The building is viewed as a one-celled organism whose environment contains all the necessary nutrients and also

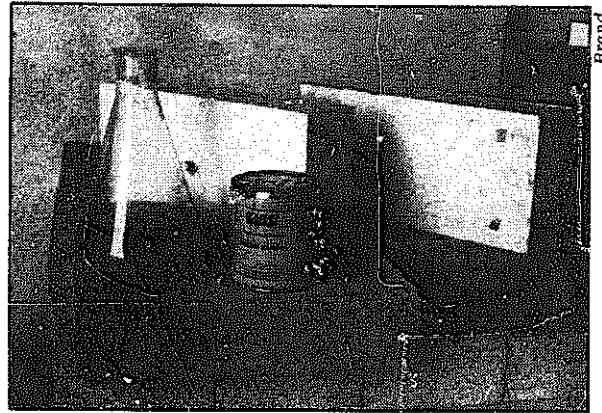

Blocks of THERMOCRETE are made from ordinary concrete blocks by sealing a calcium chloride phase-change-material tuned to 75° F (in flask) into the block with epoxy or other sealant (can). THERMOCRETE has a latent heat of fusion of 25 BTU/pound — 1/6 as great as ice.

some hostile elements. The cell wall (Heat Mirror and Cloud Gel) establishes relations between the inner and outer environments in a way such that the internal environment remains constant while the external environment changes. Using the selective permeability of its roof or walls the building exhibits homeostasis, perhaps the most basic property of living things.

Well, this discussion has all been very abstract, but: how will these materials actually affect buildings? In two sorts of ways. First, they will allow conventional buildings to use local and renewable rather than centralized one shot energy sources and thus greatly reduce the cost of running conventional buildings. The sun belongs to everyone — coal, oil and uranium don't. Secondly, these materials will make it possible to build new types of buildings.

In order for these materials to have an interesting effect on the real world, they must first find large and perhaps unimaginative existing markets to initiate the manufacture and distribution of the new materials. Both manufacture and distribution are subject to the economies of scale, so our materials will not be cheap until they are popular. Since new buildings replace old buildings about every 40 years, there is a large market in reducing the energy consumed in the heating and cooling of existing buildings.

Although it has been compared with putting sails on tugboats, the use of Heat Mirror on all existing windows would reduce national energy consumption by about 1.2 million barrels of oil per day and save Captain and Mrs. America almost a dollar per year for each square foot of window they cover with Heat Mirror. The use of Cloud Gel on all windows where sunlight increases air conditioning loads would reduce national energy consumption by roughly .5 million barrels of oil per day.

Thermocrete could also reduce the amount of fuel used in heating a building by storing the heat from its oil burner and then distributing the heat to the building when needed. Since the oil burner need fire only

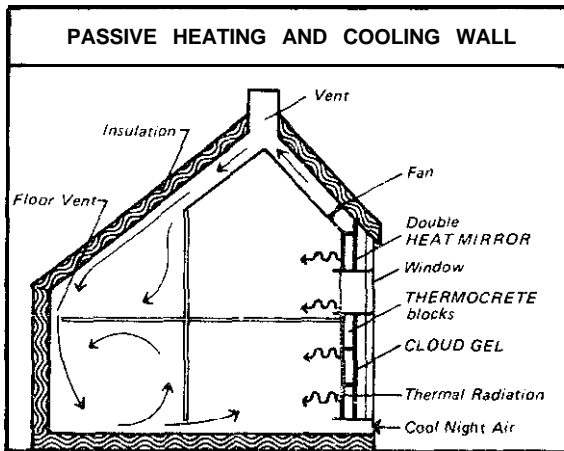

once per day, it would not waste fuel getting up to operating temperature. A four foot cube in the basement next to the oil burner would be large enough for the average home and would pay for itself in two or three years. Universally installed, these units would save the U.S. about 1.3 million barrels of oil per day. On the other hand, much smaller Thermocrete cool storage units connected to air conditioners would allow electric power plants to run at night. While this would not save fuel, it would save money since electric generating stations would not have to be so large, as they are usually sized for air conditioning peak loads. Adding the effects of all these retrofit energy conservation measures together, these three materials could reduce national energy consumption by about 10% and reduce the need for adding nuclear capacity as fossil fuels run out.

In use

For new construction or for retrofitting of fairly conventional looking houses with solar heating and night air cooling, we need to turn our stack of materials on end to make the south wall of the house. The second drawing shows such a house. This wall does many things. It is a load bearing structural element, it collects solar heat and night air cool, it stores this heat and cool, and it regulates and distributes the flow of heat and cool. Since in new construction it replaces an ordinary south wall, its energy processing functions are purchased for a marginal increase in cost. Structures using these materials which are thermal models of this type of building are being tested at M.I.T. and Los Alamos Labs. Their test performance will be put into computers to predict performance in other climates. Our materials should also find wide application in improving the performance and lowering the cost of conventional solar heaters.

Climatic Envelope

But much more interesting than energy conservation and solar heating is the entirely new kind of buildings that can be built using these materials. There include Climatic Envelopes and Biospheres. The Biosphere is a home which feeds, heats, and recycles water and the wastes of its occupants. Its potential social impact

is enormous because it makes work, in the sense of the nine-to-five job, unnecessary. Its core is a solar collecting greenhouse which can be built without our three materials, but which would benefit greatly by them. Also based on the biological analogy, the Biosphere was invented by the author in 1969. Since then the New Alchemists, the Berkeley Solar Group, and the Ouroboros Group have actually built functioning whole systems.

The Climatic Envelope is an old concept, but no one has built one yet because it won't work without the three materials. It is simply the stack of materials from the drawing on page 40 elaborated into a large bubble of good weather. It is suitable in small spans for a revised version of the home or greenhouse. In large spans it can enclose tropical parks or housing development! with no heating or cooling bills. First use will probably be for covering large commercial buildings such as sports arenas, shopping centers, university campuses, etc., but they also seem to be the most practical solution to the problems of energy for space conditioning the city, where any other kind of retrofitting seems hopeless. The height of large span envelopes will facilitate natural ventilation by wind and the chimney effect, but one could not use present automobiles inside climatic envelopes.

Removing the weather protection and structural restraints from the living areas inside buildings should produce a corresponding relaxation and personalization of the internal architecture, not to mention a great reduction of first and running costs. The main functions of a home under a climatic envelope are visual and audio privacy and pleasing appearance. These greatly reduced functions are much more within the realm of the amateur home builder in both skill and financial resources. Because the shelters inside the climatic envelope have such reduced functions, they can consist largely of movable partitions and sound proof curtains. Activities that now occur inside only for climatic reasons could take place in the "open air." The envelopes could be either one for each family, separated by berms, or could span large areas, with families separated by trees and fences.

The drawing on page 41 shows a typical Climatic Envelope. The building is a transparent roof, shaped to shed snow, placed over a hole dug in the ground. The rooms are placed against the walls of the hole in the form of a horseshoe which is covered with gardens. Fruit trees and vine arbors provide shade. The outer roof is made from Heat Mirror and Cloud Gel and the leaves of the plants are the absorbing surface for sunlight. Thermal radiation and a big lazy fan circulate either heat from the plants (or cool night air when appropriate) to Thermocrete tiles which are distributed throughout the structure.

Suntek

So that, in broad strokes, is what Suntek is all about. Who is Suntek and how did we get together to develop these interests! Back in 1968 while traveling through New Mexico I met Steve Baer, who has a particular design esthetic about buildings and had organized a

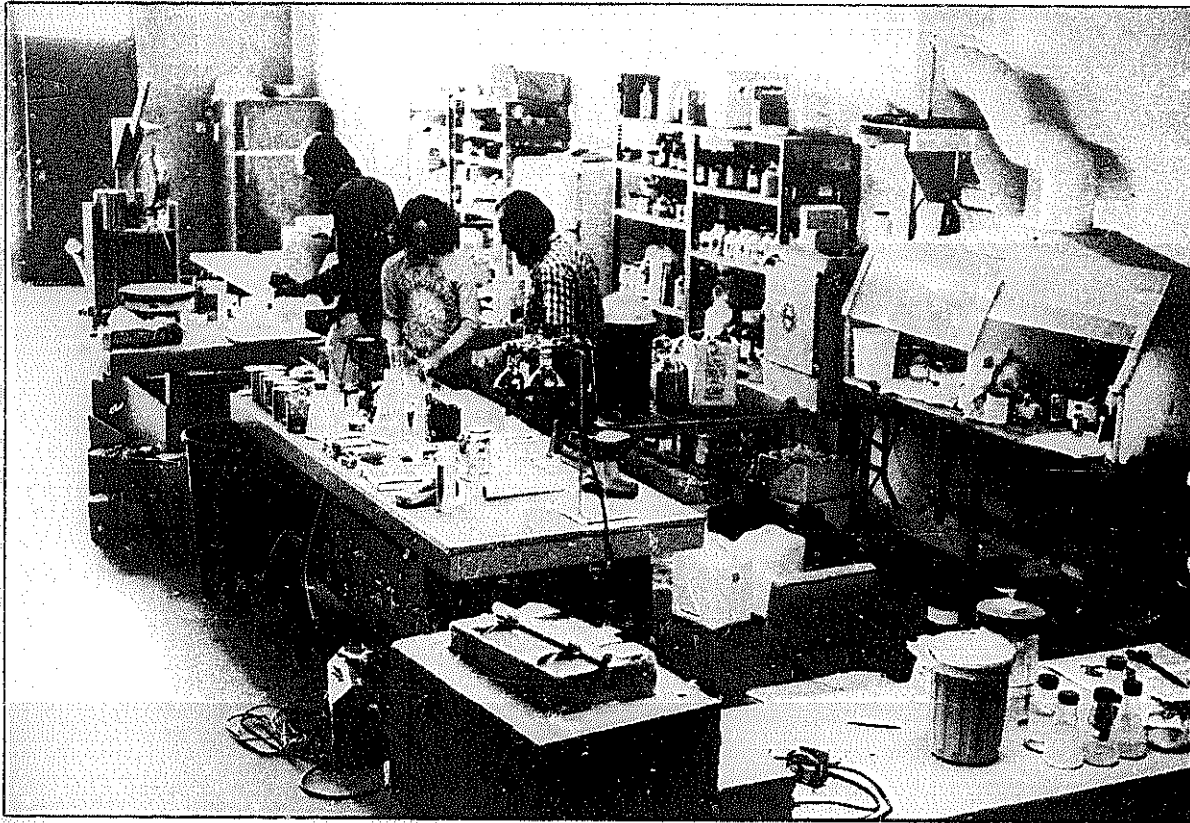

Suntek's lab area for development of THERMOCRETE and glazing materials for solar collectors.

company, Zomeworks, to realize this esthetic — which is based on minimal use of materials, energy, and human effort and is directed towards the needs of people in the third world. Solar energy seemed like a safe field for a physicist and the philosophy was appealing, so we worked together for several years with some funding from the Whole Earth Catalog.

In 1973, Blair Hamilton invited me to a conference he had organized that was held in a half acre transparent inflatable bubble that he had built for Antioch College with Charles Tilford, Sean Wellesley-Miller and Beth Sachs. This building was built with materials like the ones I was working on in my mind and was a product of the same design esthetic, so we were naturally quite excited about meeting each other. Sean invited me to work with him at M.I.T., where he was in the Architecture Department faculty. We were able to get a National Science Foundation grant which was 17% of the nation's then miniscule solar energy budget. At this point, John Brookes, a biochemist from Harvard who had also been working on heat mirrors, joined Sean and me.

In 1975 the oil crisis shifted the government's funding emphasis in solar energy from the academic to the private sector, and Suntek was awarded two materials development contracts from the Energy Research and Development Administration, one for Thermocrete through Oak Ridge National Laboratory and one for Heat Mirror and Cloud Gel through Lawrence Berkeley Laboratory. Since these materials had already been

invented and patented by Suntek, we were able to retain manufacturing rights. At this time John, Sean, and I moved to our present location in California where we were joined by Charles Tilford, a mechanical engineer, and Blair Hamilton and Beth Sachs, both very competent scientific administrators. After spending a year setting us up and organizing us, Blair and Beth left to help the National Center for Appropriate Technology get organized. Mel Hodge, our president, has filled their role. His considerable talent and business experience should prove instrumental in bringing our materials into the real world.

A venture like Suntek would not exist today were it not for the encouragement, advice and financial support of a varied group of people whose common denominator is imagination, a vision of a certain kind of future, and confidence in their own judgement. We anticipate that Suntek will remain a research organization committed to translating the philosophy expressed in this article into reality. We expect to work with other companies — either existing or established for the purpose. In transferring this new technology from our research laboratory into production and the marketplace. At this point, none of the materials described in this article are yet available for sale except for Heat Mirror in limited quantities 12 inches in width at rather exorbitant prices because it is being manufactured on a prototype machine. We would like to build a climatic envelope like the one illustrated. Again, costs would be relatively high because the structure and materials are experimental. ■

A-Z Solar Products

Everything from sundials to solar bumper stickers can be had from this catalog. We don't have experience with the quality or performance of some of the items, but they sure stock a variety of stuff, some of it difficult to find elsewhere. This service has been needed for a long time. This catalog services a chain of retail stores currently being developed.

A-Z Solar Products Catalog

— JB

Free from:
A-Z Solar Products
200 E. 26th St.
Minneapolis, MN 55404

"Nextel" Brand Velvet 101-C10 is an air dry enamel designed for spray application to properly primed surfaces. This coating uniformly scatters light regardless of incidence angle and provides extremely uniform light diffusion over a wide range of viewing angles. Coverage is 200 sq. ft./gal. (5 sq. meters/liter.) Maximum recommended temperature continuous service is 300° F (149° C).

No. 7860 6 oz. aerosol \$4.59
No. 7861 1 gallon 11 lbs. \$43.95
T.C.C.



"NEXTEL" Brand Velvet Optical Black

- Infrared absorbing coating for thermal control.
- Solar absorption 98%.

Solar Components

Kalwall not only makes the deservedly famous Sun-Lite fiberglass collector cover material, they make a considerable selection of other solar products. The Kalwall Corporation also engages in research of a sort that is proving highly useful to builders. Now they have a store, claimed to be the "largest solar mail order house in the USA." The catalog is downright fascinating, and shows many devices I've needed but never seen before.

— JB

Solar Components Catalog

Free

from:
Solar Components Division
P.O. Box 237
Manchester, NH 03105

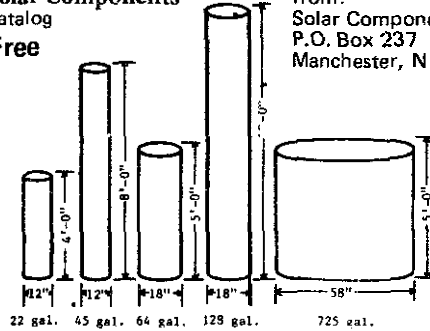

Sun-Lite Tubes and Tanks have been utilized by a number of research groups and colleges experimenting in the field of aquaculture. When ordering tubes or tanks, please specify the use, such as "heat storage" or "aquaculture."

Solar Age Catalog

A flourish of trumpets please! Here is the first real quality catalog of solar hardware and materials. But that's not all. The catalog features extensive articles by known solar energy experts so you'll be better able to judge the equipment shown. That's a pretty bold move, as catalogs go, and typical of the sponsoring Solar Age magazine. By the way, Solar Age is now the official magazine of the American Section of the International Solar Energy Society. Solar Age (\$20/year from Church Hill, Harrisville, NH 03450) also promises to update the catalog in a regular monthly column. This may well be the best catalog of anything I've ever seen.

— JB

Solar Age Catalog

1977; 232 pp.

\$8.50 postpaid

from:
Solar Age
Church Hill
Harrisville, NH 03450
or Whole Earth

THERMAL STORAGE VAULTS
manufactured by:
American Solarize, Inc.
19 Vandewater Ave.
Princeton, N.J. 08540
Joe Brudis; phone: (609) 924-5645



Vaults are made of lightweight cellular aggregates, vermiculite cement, and other additives. Can be used for rock storage or liquid tubes or be filled directly with liquid. Needs no other insulation. Features and options: standard sizes or custom made. Installation requirements/considerations: suitable for above or below ground applications. Guarantee/warranty: on manufacturing defects and failure to meet warranty specifications. Manufacturer's technical services: design service available. Field supervision when necessary. Availability: L.O.B. from factory. Price: \$250 to \$6,000.

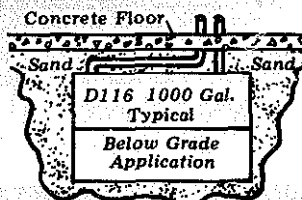

Solar hardware

"Inevitably the fields of Solar Energy and Refrigeration and Air Conditioning will become intertwined . . ." says this catalog of heat exchangers, collector plates and other goodies (including the new 4 Mil Tedlar glazing). This is typical of a growing number of companies that see what's coming.

— JB

Components For Solar Energy Systems Catalog

Free (but I'd send \$1.00)

from:
Refrigeration Research, Inc.
Solar Research Div.
525 N. Fifth St.
Brighton, MI 48116

TYPE II The No. 5840 heat exchanger is for various liquid to liquid applications. It may be used to provide heat interchange between liquid circulating from a solar collector and water to be heated in a water heater or pre-storage tank for the water heater. Depending upon the application, a circulating pump will be required in one or both of the water circuits.

Larger heat exchangers of this type are available upon special order. Capacity of the No. 5840 is indicated by the following curve:

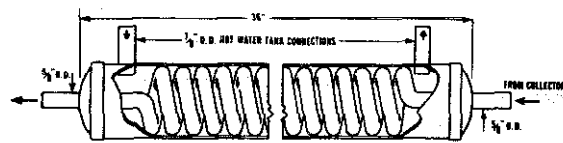
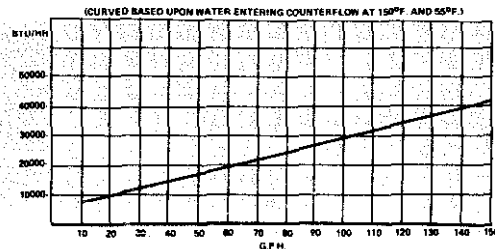

TYPE III Special heat exchangers can be made to special order. This includes special heat exchangers made for interchange between a solar collector system and absorption air conditioning system.

Tuffak-Twinwall

Rohm & Haas, makers of Plexiglas, have come out with an insulating double walled Polycarbonate sheet. It's very similar to that used by the New Alchemists' P.E.I. Ark (page 159). I expect it'll see a ready market.

— JB

Tuffak-Twinwall
see your local plastics dealer
or write:

Rohm & Haas, Plastics Dept.
Independence Mall West
Philadelphia, PA 19105

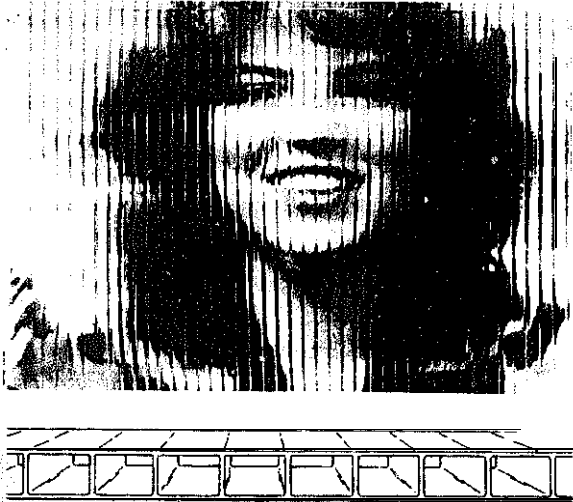

Grumman Sunstream solar hotwater system

The biggies get into the act at last with all the goods and bads such attention implies. The collector is a more-or-less conventional flat plate affair used primarily as a hot water heater booster. What's new is having a huge corporation making and marketing it. That in itself together with a typically competent big-corporation product finish, should generally upgrade public confidence in the entire industry. Not so good is that many small entrepreneurs who brought in that industry will now be driven out by it, thus suppressing innovation at a time when it is needed most. It will be interesting to see how this and other expensive solar hardware fares. How many thousand-dollar water heaters can you sell?

— JB

Grumman Sunstream

Information from:
Sunstream
4175 Veterans Memorial Hwy.
Ronkonkoma, Long Island
NY 11779

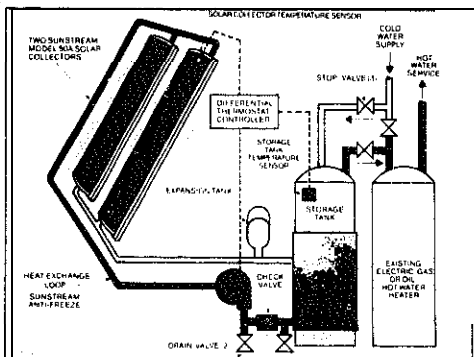

Serrande Shutters

These are roll-up "shutters" so often seen in Europe. You can roll them all the way up or down, or spread the slats apart a bit for controlled sun and view. They repel heat, wind, noise, rain and snow and should help reduce the load on furnace and air conditioner. They make it tough for burglars, too.

— JB

Serrande
\$3.95/sq. ft.
(approx.)

Catalog from:
Serrande of Italy
P.O. Box 1034
West Sacramento
CA 95691

INTERIOR VIEW

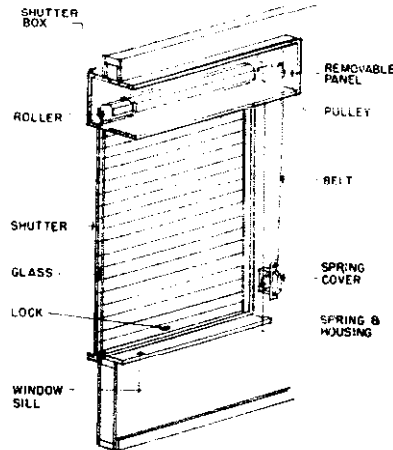

Ecosol 101 Energy Recovery System

"Sorry buddy, we don't do that kind of work," has been heard all too often by people trying to get local contractors into solar hardware installation. The local banks likely have a similar attitude; they're being cautious about machinery they're not familiar with. The Ecosol shouldn't scare anyone, including your accountant. It combines solar-collector fed hot water heating with a "furnace," your choice of fossil fuel back-up system, and an air conditioning unit (not solar powered). The operation is controlled by an on-board computer that optimizes everything and has a place to plug in cassettes to record what's going on. It also has a jack for a diagnostic device, rather like on a late Volkswagen, that should make service easy. Most important, though, is that the Ecosol is in one neat box all wired, piped and ready to go. The contractor only has to hook it up. Less mystery means less acceptance troubles. A 7 - 8 year payback is claimed in an Ohio climate. This sort of thing is probably the wave of the future, especially combined with collectors such as the Grumman, plus a few imaginative bankers.

— JB

Ecosol101 Energy Recovery System

Information from:
Ecosol LTD.
3382 El Camino A".
Sacramento, CA
95821
Suite 37



Solar Directory

A comprehensive (to say the least) directory of people, organizations, manufacturers, educational institutions, researchers, projects, and damn near everything else you could think of that pertains to solar energy. Not much on plot, but the characters are all there in fine detail.

solar Directory

Carolyn Pesko
1975; 622pp.

\$20.00 postpaid

from:

Ann Arbor **Science**
Publishers Inc.

P.O. Box 1425
Ann Arbor, MI 48106

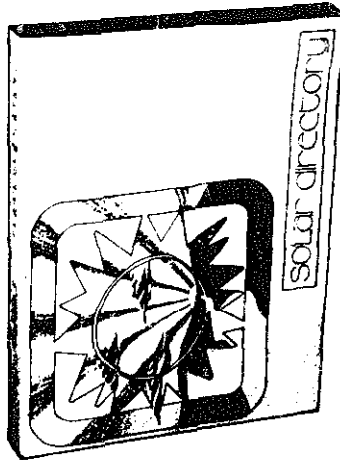

Shurcliff's last catalog

To Editor, CoEvolution Quarterly

Review copy of *Solar Heated Buildings: A Brief Survey*, 13th ed., herewith. It costs \$12 postpaid.

Comparison of 13th edition with the (now sold-out) 12th edition:

12th edition had 212 pages, described 220 solar bldg., had no photographs; stapled (not bound).

13th edition has 330 pages, describes 319 solar bldgs., has 85 photos (79 of them by Peter Hollander), and has std. tape binding. 100 of the accounts of solar buildings are entirely new.

This is the final edition. I shall write no further comprehensive books — because there are getting to be so many solar buildings.

Wm. A. Shurcliff
19 Appleton St.
Cambridge, MA 02138

RAPID GROWTH IN SOLAR BUILDINGS

The number of solar heated buildings complete in USA in the single year 1976, namely 146, exceeds the total number completed in all the preceding years, namely 140.

Sun Earth

Oh no, not another solar home book! And a general "beginner's" one at that. What makes this just a hair different, and well worth looking at in passing at least, is that an architectural style is very strongly presented by means of actual examples. It's a style that I bet will take hold in the next few years and become the path through which solar homes and offices become esthetically acceptable to Mr. & Mrs. Front Porch. The bold professional-architect drawings will make things clear to persons who just can't get by the usual dry technical diagrams in other books. I do wish someone would come up with a solar building workbook with worked-out real life problems though. That's something we really need.

— JB

[Suggested by Joe Eddy Brown and Carolyn Pesko]

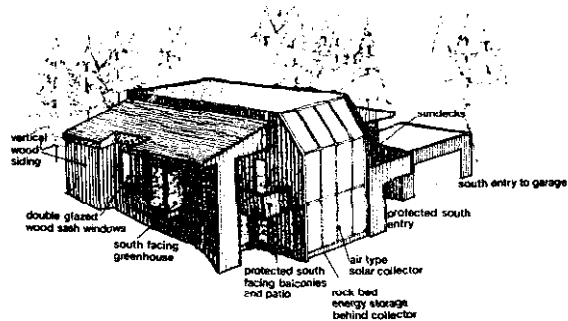

In snowy regions, provision should be made to prevent snowdrifts from obstructing entrances. Reflective surfaces can be used above or around the door area to accomplish this. These should be calculated to allow entryways to be heated by the sun during the winter months and to be shielded from the sun during the summer. Care should also be taken to avoid directing the solar radiation into the eyes of people when they are exiting or entering. The reflection should be directed toward a flooring surface dark in color, to absorb as much energy as possible. Also, adequate drainage must be provided so that melted snow doesn't freeze in the entryway at night.

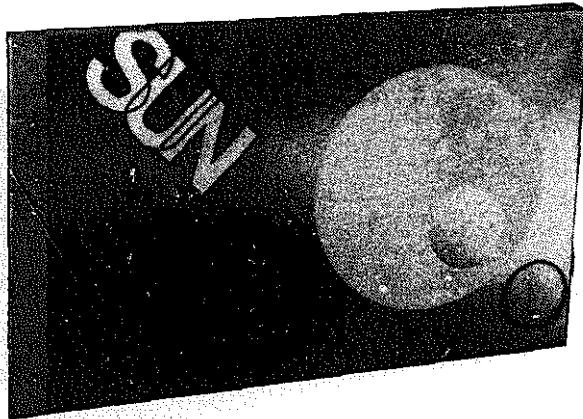

Sun Earth

Richard L. Crawther A.I.A. et al
1976; 232 pp.

\$12.95 postpaid

from:

Architects Group
310 Steele St.
Denver, CO 80206
or Whole Earth

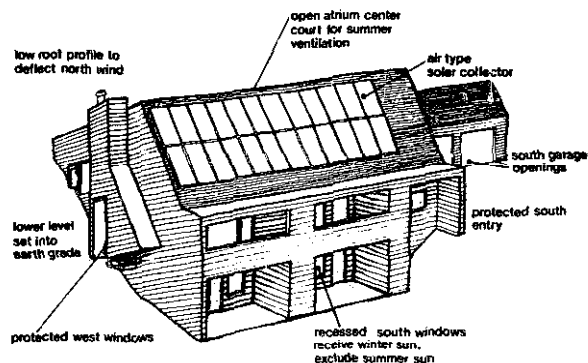

Solar Energy Society

The American Section of the International Solar Energy Society Inc. sounds pretty stuffy, but it's the official name for the organization dedicated to making solar energy an increasingly important part of our lives. Most solar experimenters and others involved in encouraging the use of solar energy are members of local chapters as well as the International Solar Energy Society (ISES) itself, which is a separate organization. If you are interested in getting together with sun workers, the local chapter is your best bet.

I'm finding that much of the solar information that I need and use has come to me through the very lively New Mexico Solar Energy Association. As with other chapters, their newsletters are full of the very latest experimental data, much of it regionally appropriate. The chapter publications often bring you information years ahead of formal books. Here's a list of existing chapters and those in the making:

EXISTING CHAPTERS

ALABAMA

Solar Energy Association
Dr. G.R. Guinn
c/o University of Alabama
in Huntsville
Johnson Environmental
& Energy Studies
P.O. Box 1247
Huntsville, AL 35807

ARIZONA

Solar Energy Association
Mr. Russell Clark
Secretary/Treasurer
P.O. Box 7
Flagstaff, AZ 86001

COLORADO

Solar Energy Association
Mr. Paul Shippee, President
c/o Solar Energy Program
University of Colorado
1100 14th Street
Denver, CO 80202

EASTERN NEW YORK

Solar Energy Society
P.O. Box 5181
Albany, NY 12205
(518) 457-4861

GEORGIA

Solar Energy Association
Mr. Des Yawn
Campus Box 32743
Georgia Institute
of Technology
Atlanta, GA 30332

METROPOLITAN

NEW YORK

Solar Energy Association
Mr. Joseph Cuba
United Engineering Center
345 East 47th Street
New York, NY 10017

MICHIGAN

Solar Energy Association
Mr. Edward J. Kelly, Jr.
201 East Liberty Street
Ann Arbor, MI 48104

MID-ATLANTIC

Solar Energy Association
Mr. Robert T. Bennett
Department of Architecture
Graduate School of Fine Arts
University of Pennsylvania
Philadelphia, PA 19104

NEW ENGLAND

Solar Energy Association
Mr. John T. Scheibly, Jr.
P.O. Box 541
Brattleboro, VT 05301
(802) 254-2386

NEW MEXICO

Solar Energy Association
Ms. Barbara Francis
P.O. Box 2004
Santa Fe, NM 87561

NORTHERN CALIFORNIA

Solar Energy Association
Dr. Donald W. Aitken
Director
Center for Solar Energy
Applications
San Jose State University
San Jose, CA 95192

NORTHERN ILLINOIS

Solar Energy Association
Mr. J.A. Hartley, Secretary
P.O. Box 352
Argonne National Laboratory
Argonne, IL 60439

OHIO

Solar Energy Association
Mr. Joseph J. Barbish
12931 West Geauga Trail
Chesterland, OH 44026
(216) 729-9350

SOUTHERN CALIFORNIA

Solar Energy Association
Mr. John T. Brand
Chairperson
202 C Street 11B
San Diego, CA 92101

TEXAS

Solar Energy Society
Mr. Peter E. Jenkins
Texas A&M University
Mechanical Engineering
Department
College Station, TX 77843

VIRGINIA

Solar Energy Association
Mr. John G. Lewis, Jr.
Chairperson
P.O. Box 12442
Richmond, VA 23241

ORGANIZING CHAPTERS

British Columbia

Canada

Colorado

Hawaii

Illinois

Iowa

Kansas

Louisiana

Michigan

Mexico

Minnesota

Nebraska

Nevada

New Jersey

North Carolina

Oklahoma

Oregon

Puerto Rico

South Carolina

Tennessee

Metropolitan Washington, D.C.

Missouri/Arkansas



Membership in the American Section gets you a subscription to the excellent Solar Age magazine (for review see page 65), as well as an annual membership directory, proceedings from the annual meeting, and several other publications. Membership in ISES also includes the bi-monthly Technical Journal, a quarterly called Sunworld, and the International Newsletter, also published quarterly. Most sun workers I know are members of both groups. In addition to all this, the American Section also offers affiliations with the special interest groups listed below.

—JB

AGRICULTURE

Includes the areas of greenhouses, drying, crop improvements, energy plantations, animals, irrigation, and desalination. Contact: Dr. C. Direlle Baird, Department of Agricultural Sciences, University of Florida, Gainesville, FL 32611.

BIOLOGY AND CHEMISTRY

Includes the areas of bioconversion, photobiology, photochemistry, chemical storage, photoelectrolysis, photogalvanics, bio-medical and bio-engineering. Contact: Dr. James R. Bolton, Department of Chemistry, University of Western Ontario, London, Ontario, Canada N6A3K7.

ENGINEERING

Includes areas of solar thermal applications, heating and cooling, system modeling, thermal storage, heat transfer, thermodynamics, engineering, process heat, and ocean thermal. Contact: Dr. J. Richard Williams, Associate Dean of Engineering, Georgia Institute of Technology, Atlanta, GA 30332.

PASSIVE SYSTEMS

Includes the areas of architecture, energy conservation, natural cooling, heat storage, thermal flow control, siting and microclimate, daylighting and thermal comfort criteria. Contact: Dr. J. Douglas Balcomb, M.S. 571, Los Alamos Scientific Laboratory, P.O. Box 1663, Los Alamos, NM 87548.

PHYSICS

Includes the areas of photovoltaics, optics (coatings), solid state physics, and material sciences. Contact: Dr. Karl W. Boer, College of Engineering, University of Delaware, Newark, DE 19711.

SOCIO-ECONOMICS

Includes the areas of commerce, the law, communications, economics, education, institutions, and legislation. Contact: Mr. Keith Haggard, P.O. Box 2004, Santa Fe, NM 87501.

RADIATION

Includes the areas of climatology, solar energy data, atmospheric physics and meteorological optics, instrumentation and radiometry and radiation transfer. Contact: Dr. Kinsell L. Coulson, Department of Land, Air and Water Resources, University of California, Davis, CA 95616.

WIND POWER

Includes the areas of meteorology and climatology, aerodynamics, ocean waves, and engineering of wind power systems. Contact: Dr. C.G. Justus, School of Aerospace Engineering, Georgia Institute of Technology, Atlanta, GA 30332.

The Chapters of the Section provide information and participatory opportunities for interested laypersons. Chapter activities include technical, educational, social and publications programs and opportunities to assist legislators in their actions. Members are encouraged to participate and to join their colleagues in forming new chapters.

Assistance in organizing Chapters and Chapter Formation Packets are available from the Section's National Coordinator and the Headquarter staff.

Members also receive discounts on a variety of books, kits, and reprints. For membership forms and a complete catalog write: American Section of The International Solar Energy Society, Inc., 300 State Road 401, Cape Canaveral, FL 32920.

The Clothesline Paradox

BY STEVE BAER

Illustrations by Carol Kramer

A few years ago Peter Van Dresser mentioned the Clothesline Paradox.

Solar energy advocates are continuously humiliated by being shown "energy pies." Slices are assigned to coal, gas, oil, hydroelectric and **even** nuclear, but solar energy is evidently too small to appear. I have a typical energy pie from the Ford Foundation whose source is the U.S. Bureau of Mines. The large pie is split into 5 pieces. Petroleum — 46%, coal — 18%, natural gas — 31%, hydropower — 4%, and nuclear — 1%. (An asterisk notes that wood has been omitted — why?) We are frequently reminded that the energy we advocate — solar energy — must, after the proper technical efforts, appear alongside coal, oil, natural gas, and nuclear before it will make an "impact." ERDA in its different energy consumption predictions assigns only a thin wedge of the pie to solar energy and then only as a faint hope **15 to 25 years from now**. The demoralized reader is then ripe to be persuaded of the necessity of nuclear power plants or offshore drilling. The accounting system shows that he has done absolutely nothing with solar energy. He lacks even a **trace** of a useful habit or activity that he could build on. As Peter and I discussed — if you examine these **figures** you find the cards are stacked against solar energy.

If you take down your clothesline and buy an electric clothes dryer the electric consumption of the nation rises slightly. If you go in the other direction and remove the **electric** clothes dryer and install a clothesline the consumption of electricity drops slightly, but there is no credit **given** anywhere on the charts and graphs to solar energy which is now drying the clothes.

The poor old sun is badly mistreated by such graphs. In the first place the obvious should be pointed out; that coal, oil and natural gas are all solar energy products stored ages ago by photosynthesis, and hydroelectric power is solar energy no older than the weather patterns which dropped the precipitation flowing through the turbines.

The graphs **which** demonstrate a huge dependence on fossil fuels are fine in one respect. They are **alarming**. But they are very bad in another respect. They are misleading. Misleading to such an extent that they blind people to obvious answers and prime them to a

frenzy of effort in poor directions. Attention given to such graphs and charts trains people to attempt to deliver what is shown in these accounting systems rather than what is needed.

If you drive a motorcycle, the gasoline you consume appears in the nation's energy budget. If you get a horse to ride and graze the horse on range nearby, the horse's energy which you use does not appear in **any-**one's energy accounting.

If you install interior greenhouse lights the electricity you **use** is faithfully recorded. If you grow the plants outside no attempt is made at an accounting.

If you drive your car to the corner to buy a newspaper the gasoline consumption appears. If you walk — using food energy — the event has disappeared from sight, for the budget of solar energy consumed by people in food is seldom mentioned.

The Ford Foundation's energy study shows the U.S.'s energy consumption in 1968 at about 62 quadrillion Btu or, **310,000,000 Btu/person/year** or, $310/365 = 850,000$ Btu/day. If the average daily caloric intake is 2500 Kcal., this is approximately 10,000 Btu/day/person — about 1.2% of the total consumption listed by the Bureau of Mines. But this 1.2% doesn't appear **anywhere** on the graphs. Nuclear energy with 1% does appear. The food is obviously solar energy. **Why** is it not included?

What about the question of the energy used in growing the food? Can't we treat this in the same way as the coal burned to generate electricity? If we use the **figure of .5% efficiency (Ayres and Scarlott)** this means we have consumed approximately 2,000,000 Btu/person/day of sunlight in producing the 10,000 Btu/person consumed. Solar energy then immediately **fills** over 2/3 of the new energy pie. If we aren't allowed to show the actual sunlight required **for** our 10,000 Btu/person, then what about power plants? **Why is it that** when they burn 4 Btu of fuel for every Btu delivered as electricity all the consumption appears in the energy accounts rather than **the 1 Btu**?

Why wouldn't it be fair to expand the slice — 4% (1973 — Bureau of Mines) given to hydroelectric

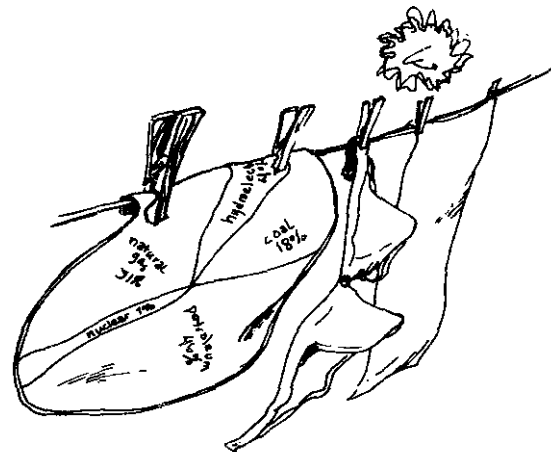

Reprinted from SUNPAPER, A Newsletter from the New Mexico Solar Energy Association, Summer 1975.

power by a similar factor of efficiency for the solar energy consumed in raising the water to its working head? After all, in most cases, the rain or snow fell through long unexploited distances before it went to work in a power plant.

Then there is the question of heating houses. Every time the sun shines on the surface of a house and especially when it shines through a window there is "solar heating" to some extent. How do we measure this? How do we account for this in our discussions of energy use? According to the NSF/NASA Energy Panel of 1972 the percentage of thermal energy for buildings supplied by the sun was too small to be measureable. But is that accurate? Shouldn't we recalculate the energy consumption of every building assuming it were kept in the shade all day and then attribute the difference between this amount and its actual consumption to solar energy? In most cases this would result in an enormous difference. Almost every building is solar heated to some extent. I would guess the average shaded fuel consumption to be at least 15% higher, and then of course our next concern in heating the building is what keeps the earth as warm as it is? What supplies the United States with the necessary energy to maintain an average temperature of 60 degrees Fahrenheit as it spins in empty space at absolute zero? This is a heating contract no oil company would be quick to try and fill.

Clearly it would be a very difficult thing to account for every calorie or Btu that passed through us or by us every day in the various forms. It doesn't seem to be a particularly urgent job, but it is very important to examine what the limits of an accounting system are — to know what the numbers and quantities displayed really mean.

If you go to a drive-in movie to watch the flickering lights on a screen the energy consumption of the automobile and the drive-in is dutifully recorded and appears in the statistics. If you walk out on a hillside, lie on your back and look at the stars, no attempt is made to measure the power output of the distant stars.

I don't advocate an enormous effort to measure all these things. It would just be more helpful if the graphs stated more clearly what they are about.

The design of houses can be stilted by such graphs. Now that the experts have started this infantile accounting system, which evidently finds us completely independent of the sun, solar energy will be admitted only so long as it has been properly collected, stored and transferred. Legislation aimed at encouraging the use of solar energy equipment by subsidizing the price of certain hardware must end by being pathetic and blundering. It would take an enormous crew of experts to determine the efficiency of different orientations of windows, different arrangements of shade trees, etc., etc. To ignore these efforts and only to reward the purchase of "off the shelf hardware" is to further the disease of narrow minded quantification.



It should be pointed out to the people promoting the use of solar energy in the place of fossil fuels that the accounting systems used by the experts are rigged against them. As I understand it, we are being prepared to accept that there are legitimate and illegitimate ways of using the sun. If you purchase certain kinds of hardware to exploit solar energy it will be accounted for and a credit will be given to the sun. If you depend on more customary old-fashioned uses of solar energy, growing food, drying clothes, sun bathing, warming a house with south windows, the sun credit is totally ignored.

Our present accounting system with its promise of a credit to the sun after the right hardware has been installed can only discourage good house design. If the natural solar contribution to house heating from windows is ignored, then the designer knows that expanding this share done by the sun will also be ignored. No tax incentives no credit given to the sun in ERDA's graphs.

I think we would be much better informed if alongside every graph showing our use of oil, coal and uranium there were also an indication of the total energy received from the sun. Since we can't do without it, let's not omit it from our accounts. In the case of the United States a conservative estimate of the solar energy received in one year might be:

$(3,600,000)$ square miles (52802) ft.²/mile² x 350×10^3 Btu received/ft²/year = $3 \times 10^6 \times (5.28)^2 \times 10^6 \times 3.5 \times 10^5 = 293 \times 10^{17}$ Btu/year. Twenty nine thousand three hundred quadrillion Btu as opposed to the 62 quadrillion shown as used during 1968 by the U.S. Bureau of Mines.

When small children first start paying close attention to money and to their allowances they briefly commit their whole minds to their few coins and what chores they did to earn them -without even considering the budget of the family's household. We can't allow our entire civilization to be similarly ignorant for long. We must ask who's keeping score and why they have such peculiar methods. .

What's new in 1897: 30% of Pasadena homes
have solar water heaters.

Solar Water Heaters in California, 1891 - 1930

BY KEN BUTTI AND JOHN PERLIN

Copyright © by Ken Butti and John Perlin, 1977.

Sun power is a pure gain to humanity. It subtracts nothing; the world will not be in the least impoverished tomorrow by the fullest use of "visible solar heat" to-day.

We must consider that wood and oil and coal and gas are steadily consumed by use. Not only will the coming generations be less comfortably supplied — a thing most of us care very little about — but the drain to-day may produce distress in our own homes and lay an embargo on our own business to-morrow. Contrast this with the freedom of the people who receive daily gifts of fuel from the Creator, taking all they wish, all they can use, freely.

— C.H. Pope
Solar Heat, 1903

If you're surprised to learn of all this don't feel bad. The very firms who used to manufacture solar water heaters (and now make air conditioners and such) were astonished when Butti and Perlin turned up the solar material in their files. Perhaps this is how things eventually become part of cultural memory — when it is recalled that they were the link to something that became important later.

Worth noting is that the solar boom in California as well as the later, larger one in Florida took place without government funding, ballyhoo, or even notice except for the protection of patents. Building codes were not enforced to either require or make difficult such innovation.

Authors Butti and Perlin, who are young professionals in the solar field, are assembling a book on early American solar experience in California, Arizona, Florida, New England, and elsewhere. Another chapter, "Solar Water Heaters in Florida — 1923-1978," appears in the Spring 1978 CoEvolution Quarterly.

We are grateful to Alvin Duskin of Pacific Alliance for sending the authors our way. Nice brokering, Al.

—SB

GLASS HAS LONG BEEN KNOWN to act as a solar heat trap; that is, glass permits sunlight to pass through but prevents its heat from escaping. Horace de Saussure, an 18th century naturalist, demonstrated how effectively glass could trap solar heat by exposing to the sun a box with a glass cover. The bottom of the box heated to 228.2°F—16.2°F above the boiling point of water — more than hot enough for home and water heating purposes. The first commercial solar water heater, a glass-covered box with water tanks inside heated exactly as de Saussure's box, was patented by Clarence M. Kemp, of Baltimore, Maryland in 1891.

Two Californians bought the rights to Kemp's patent and set up business in Pasadena, California in 1895. Because fuel was scarce and expensive (gas for heating sometimes cost six times as much as it does at this writing) many Californians turned to the sun to supply their hot water. In Pasadena by 1897 30% of the homes had solar water heaters. Refinements on the 1891 patent which were made in 1909 resulted in the configuration still in use today — a glass-covered box containing pipes soldered to a metal plate (the metal plate conducted heat to the pipes) through which water flowed to a storage tank. The manufacturer of these heaters had sold over 10,000 by the late 1920's. These solar water heaters, depending on their size, supplied from 40 to 120 gallons of water daily at temperatures from 115° F to 140° F.

The story we present is about an industry that thrived in California and Florida early in the century and somehow became forgotten. A few traces of this story remained in early magazine and newspaper articles, but we acquired the story, by and large, from elderly people. They chuckle when they hear younger people talk about this "new, exotic" solar technology which is no different from equipment they used to heat their water nearly 70 years ago.

THE CLIMAX SOLAR-WATER HEATER—Patented April 28th, 1891.
 Has been in use since the summer of 1889 and has more than fulfilled the expectations. It is made of the best galvanized metal, made for ordinary service and is thought well for 10 or 15 years of the same as other fixtures in a house, such as Bath Tubs, Kitchens, etc. When the heater in service you can go home at night and find hot water for each room for use on tap same as the cold water. You can do without the change in seasons. The Heater will give the HOT WATER and a fine shower in the morning.
 You have simply to open a cock and instantly comes the hot water; there is no delay—no expense for fuel. No 1 size will furnish hot water for several baths.

Can be connected with Iron Pipes or with flow. To connect—cuts but a FEW INCHES.
ESPECIALLY IN THE COUNTRY as well as IN THE CITY.
 Pipe connections can be made through the roof or through the side wall, or through the window frame, easily and cheaply without injury to the room.
 This Heater absorbs an extremely large amount of heat from the sun and stores it for bathing, domestic and other purposes. It consists of a white pine box, inside very close and tight and lined with felt paper; this box is covered with a glass sash. Inside the box is placed four cylindrical tanks made of heavy galvanized iron—each holding about eight gallons of water, or thirty two gallons in all for No. 1 model. These tanks are painted a dull black and quickly absorb the heat-rays of the sun which penetrates through the glass top. They are arranged in such manner as to secure the greatest results, and keep the incoming cold water from mixing with the hot water; the heat grasped by this apparatus is retained for a long time, even if a Storm or Cold Wind comes up.

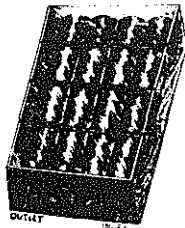

Fig. 1—No. 1 Climax Solar Water Heater. Glass and ready for connection.

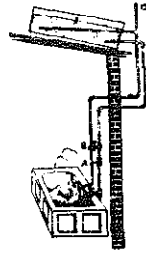

Fig. 2—Shows heater on a roof with connections for bath.
 A—The cock to let on the cold water which displaces the hot water in the tank, causing some to pass down the discharge pipe into the tub.
 B—The drain cock for running the water below the tub.
 C—The air opening which prevents vacuum in the heater and siphons the water.

The heaters are made with four cylindrical tanks, the water enters the lowest tank at the front end and forces the hot water ahead of it, causing it to leave at the top of the first tank at the rear end, and pass into the rear end of the next tank through a tube which runs to the bottom, this causes a displacement in the second tank, the water leaving at the top of its front end and passing into the bottom of the third tank, and so on from the rear end of the third tank into the bottom of the fourth tank, and finally the discharge takes place from the top of the front end of the fourth tank into the pipe that runs to bath-room. By this arrangement of pipes, all air is kept out of the tanks, the water fills them completely, hence the sun's heat striking the darkened surfaces of the tanks is directly absorbed by the water. By this arrangement, also, when it is desired to drain the tanks, the drain cock is opened in the bath-room, and the



Fig. 3—Shows a swimming pool which can be supplied with hot water from "Our Heater."



Fig. 4—Shows another service it is qualified for.

Pages from the original Maryland brochure for Climax solar water heaters.



Courtesy of Alice Kemp Travers

Clarence M. Kemp, inventor of the Climax, the first solar water heater, patented 1891. He was the owner of C.M. Kemp Manufacturing Company, Baltimore, Maryland (established 1877).

In the late 1800's in California heating water was not a simple task. In the countryside and in many small towns, where the majority of people lived, there was no gas or electricity. People had to rely on the cook stove for hot water. As one homesteader, Luba Perlin (64), recalled:

You took just one bath a week, a Saturday night deal, because it was such hard work to heat water on the stove. YOU put pots, pails, anything which would hold water and you could lift (because water is heavy). It took a while for those old stoves to get going because the heat had to first penetrate through the heavy metal.

In cities and towns where there was constant water pressure, residents attached water tanks to their stoves and connected the water heating unit to the household plumbing system, eliminating the constant labor of hauling water to and from the stove. A coil was looped through the firebox of the stove and connected to the water tank. An elderly man, Theodore Hotchkiss (85), explained to us how they worked:

Once you got the fire going really good, you'd have to wait about fifteen or twenty minutes as the cold water would heat as it circulated through the coil and into the holding tank. The hot water would naturally rise up into the tank (hot water being lighter than cold water). The holding tank was not insulated. That was a real problem because if you didn't use all the hot water, it would lose its heat after a while. So the water in the tank would be cold within an hour or so.

[more ->]

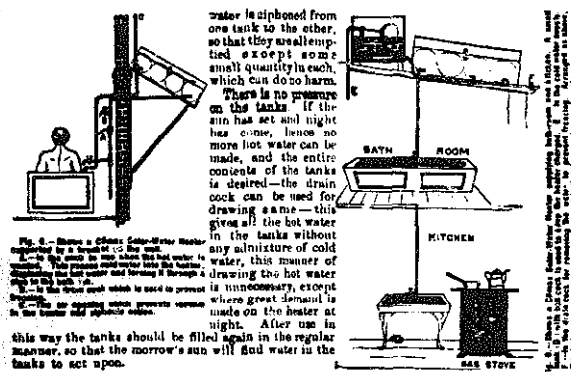

Fig. 4—Shows a Climax Solar Water Heater connected to a house. A—The cock to let on the cold water which displaces the hot water in the tank, causing some to pass down the discharge pipe into the tub. B—The drain cock for running the water below the tub. C—The air opening which prevents vacuum in the heater and siphons the water.

Fig. 5—Shows a Climax Solar Water Heater connected to a house. A—The cock to let on the cold water which displaces the hot water in the tank, causing some to pass down the discharge pipe into the tub. B—The drain cock for running the water below the tub. C—The air opening which prevents vacuum in the heater and siphons the water.

THE CLIMAX SOLAR-WATER HEATER

Can be used in some states throughout the entire year, in others from the 1st of April until the end of October; in the northernmost states from May 1st until October 1st.

During the early Spring and late Fall months, while the temperature during the day has been near the freezing point, the heater water has been over 100 degrees, the efficiency shown by the heater is from 60° to 100° degrees greater than the temperature for the day.

The water at times almost boils.



Fig. 7—Shows the two removed, and the four cylindrical tanks connected.

No.	SIZE	CAPACITY	WEIGHT	PRICE
1	3' x 41" x 31"	32 gals.	125 lbs.	\$25.00
1A	3' x 41" x 31"	89 "	225 "	48.00
2	3' x 51" x 31"	65 "	185 "	40.00
2A	3' x 51" x 31"	160 "	325 "	70.00
3	5' x 7" x 31"	170 "	450 "	135.00
3A	5' x 7" x 31"	330 "	700 "	200.00
4	6' x 9" x 31"	290 "	700 "	240.00
4A	6' x 9" x 31"	700 "	1200 "	390.00

Discount Per Cent.

We will make to order any size wanted. On Cloudy Days the Climax Solar Water Heater absorbs 70% considerable heat.

CLARENCE M. KEMP, BALTIMORE, MD.



WE DO IT. WHAT?

Reduce your fuel bill 40 per cent. Let us demonstrate it to you.

THE CLIMAX SOLAR WATER HEATER CO.
125 S. Broadway.

Dr. PIERCE'S FAVORITE PRESCRIPTION FOR WEAK WOMEN.

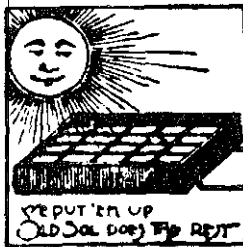

Free Hot Water!

No stove or fuel necessary — the sun's rays utilized.

Climax Solar Water Heater Co
125 S. BROADWAY

...BATHS...

Turkish, Hammam, Russian, Electric, Steam, Vapor and Salt. Large plunge; everything new and first-class.

118 EAST THIRD STREET.
Late residence of Capt. C. E. Thom.

Circa 1900 Southern California newspaper ads for Climax solar water heaters.

In the summer the heat of the stove made living unbearable. "It was torture just to be in the house with the stove on! You nearly died from the heat," confided a stove user. Many did without hot water rather than endure such discomfort.

Gas was available in the larger cities, not natural gas, but a type made from coal. It was produced by burning coal briquets at extremely high temperatures, capturing the flared off gas and piping it for domestic and commercial uses. Called "artificial" or "manufactured" gas, it had only one-half the heating capacity of natural gas and was oily, not a clean-burning fuel.

The common gas water heater in use was the side-arm, so named because it was attached to the side of a hot water tank. The side-arm was not automatic. If you wanted to wash clothes or take a bath, you hit the heater and then waited for the water to get hot as it circulated through the heating coils of the side-arm.

The hot water flowed into the adjacent holding tank. When the water in the tank got hot enough, "the tank would start jumpin' and you knew it was time to shut it off." If you forgot, as one plumber (R. Carroll, 84) recalled:

You might get your hand scalded or get a face full of steam if you opened the hot water faucet. There were times when they would split a tank. We had this one house where this woman started this side-arm up and went up town and when she came back the goddamn back of the building was blown off!

Not only was heating water difficult, it was expensive in California. California had to import coal and it cost over twice the national average. Artificial gas sold for \$1.60 per thousand cubic feet — equivalent to paying \$3.20 for a thousand cubic feet of natural gas (since natural gas has about twice the heating capacity of artificial gas), and natural gas only costs \$1.60 per thousand cubic feet today in dollars which command less than 1/5th the buying power they had in 1900. This meant the consumer in 1900 had to pay more than ten times what natural gas costs today. As high as the price of gas was, electric rates were even higher, so nobody even considered heating water with electricity. The difficulties of heating water combined with exorbitant fuel prices forced southern Californians, as one eastern journalist observed in *Countryside Magazine* in 1914:

... to take the asset of sunshine into full partnership. In this section of the country where soft coal sells for \$13 a ton (and the huge peaches bring only \$2 a ton) a builder cannot afford to waste his sun-rays. California is in peculiar need of its solar heaters.

Exposed Water Tank Solar Heaters

The first solar water heaters were simply water tanks placed upright or laid on the ground where they would best catch the sun and avoid the shade. They were usually painted black. As the tanks absorbed solar heat, the water inside heated. By late afternoon on clear hot days, they supplied early settlers with water hot enough for showering.

Because the tanks were bare and unprotected, at night the water readily lost heat, cooling to air temperature. No usable amounts of hot water could be available until well after noon as it took time for the sun's heat to penetrate such a relatively deep body of water.

1891 — The Climax Solar Water Heater

Clarence M. Kemp of Baltimore, Maryland improved the efficiency of bare tank solar water heaters by placing the water tanks inside a white pine box insulated with felt paper and covered by glass. Four tanks, made of heavy galvanized iron and painted a dull black, were laid side by side and connected to each other by tubing. The most common tank size was eight gallons. He patented this solar water heater on April 28, 1891, calling his invention the Climax.

The Climax was set up on the roof of a house or shed, or secured by brackets to a wall. It was usually in-

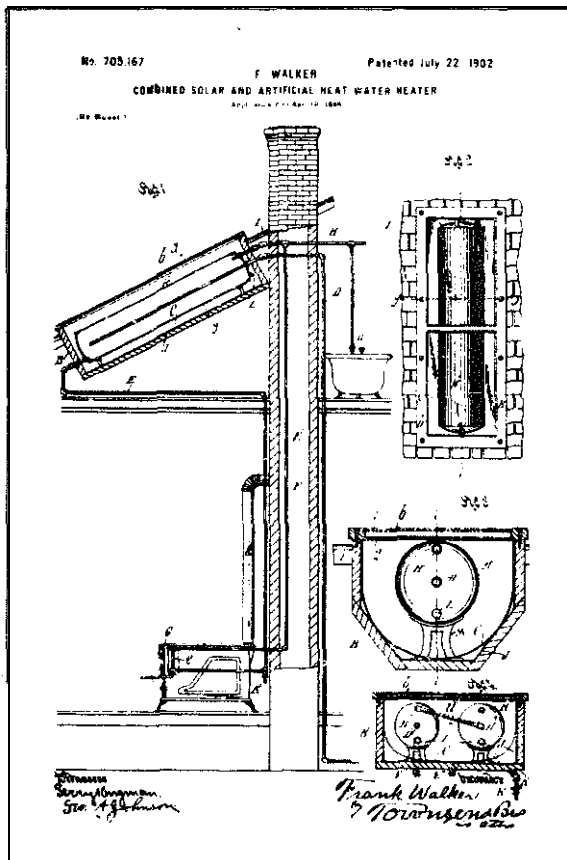

1902 — Patent drawing for Frank Walker's solar water heater showing auxiliary heat source in kitchen stove.

lled at an angle with the four cylindrical tanks lying horizontally one above the other. When hot water was needed, a valve controlling the flow of cold water from the household plumbing system was turned on. Cold water entered the lowest tank, forcing hot water out of the upper tank into pipes running through the roof, wall or window frame and into the bathtub, sink, or wherever. Another method of installation was to connect the Climax to a reservoir-type system. Opening the hot water faucet drew hot water from the tanks. Cold water from the reservoir replaced the spent hot water and a float valve in the reservoir opened to refill it with cold water.

How many solar water heaters Kemp sold in Maryland is not known, but their manufacture never became his main line of business, remaining just one of many household devices he produced. Kemp sold the exclusive rights to manufacture the Climax Solar Water Heater in California to two Pasadena businessmen, E.F. Brooks and W.H. Congers, in 1895.

No ecological arguments were needed to sell the Climax in southern California. "We didn't think it was anything revolutionary. Everybody had one. It was a thing of the time because it made sound economic sense," explained Walter Van Rossem (86), who had a Climax Solar Heater on his house,



Solar inventor Frank Walker was born in Kincardine, Canada, in 1843 and moved to Los Angeles in 1885 for the climate. Well-regarded in the construction trade, by 1900 he was a member of the Los Angeles city council.

The No. 1 Climax, costing \$25 (\$162 today), saved its owner about \$9 (\$58) worth of coal annually. It was even more economical if it was used as an alternative to other fuels such as artificial gas or gasoline. Owners of the Climax enjoyed the convenience of "a 'faucet full' of hot water without so much as the trouble of striking a match," as one journalist commented.

The rights to the Climax Solar Water Heater changed hands several times around the turn of the century. Congers and Brooks had originally bought the rights to the Climax for a mere \$250. Just three years later, in 1898, Mrs. Sarah Robbins bought the rights from Congers for \$2,500. Sales of the Climax expanded from the Pasadena area to all of southern California. By 1900, over 1600 solar water heaters had been installed.

1898 — The Walker Solar Water Heater

Frank Walker, a Los Angeles contractor and realtor, invented a solar water heater in the spring of 1898 which improved upon the Climax design. Walker's solar heater usually contained not more than one or two water tanks rather than four as in the Climax. These blackened thirty-gallon tanks were enclosed in a glass-covered box that was set inside the roof so that the glass top was flush with the shingles. This not

[Text continues on page 58.]

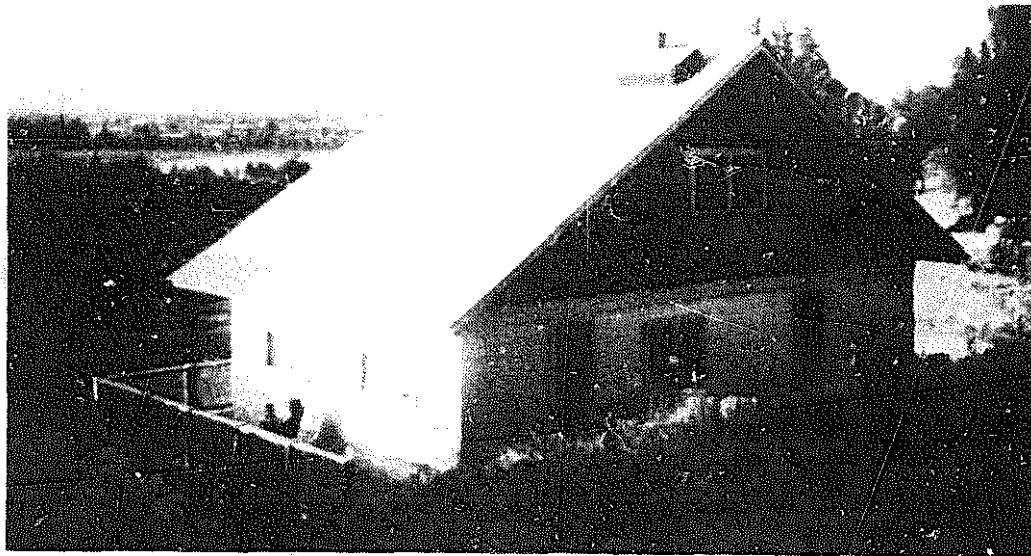

Historical Collections, Security Pacific Bank

August, 1896, Pasadena, California. That's a Climax solar water heater on the roof. The boy on the porch, Walter Van Rossem, then age 2, now age 84, speaks below. The lady is Mrs. A.C. Van Rossem, Walter's mother. In the background is Brookside Park, the present location of the Rose Bowl.

WHEN WE FIRST moved in, there weren't any utilities. WE had to do it ourselves with either a wood stove for heating or a gasoline stove for cooking and coal oil lamps. There was no gas, no electricity, no nothing, practically pioneering. The solar heater was up on the roof for heating water. There was nothing uncommon about it at all. I can't remember a house on the block that was built at the time or soon after that, that didn't have a solar heater on it. I don't think anybody would be thinking at the time about paying for heating water if they could get it from a solar heater.

"We were pretty well curtailed for expenses, I know that. Mother's inheritance only amounted to \$20 a month. We had to pay for wood for the wood stove and gasoline for the cook stove. The solar heater was so much more economical than buying wood or gasoline to heat water. And it was less work, too. It would take half an hour to get a wood stove warmed up, because it takes a lot of time to heat up a stove made of iron. You can't boil water on a wood stove unless it's hot all the way through because the heat is going into the iron and not what you have on it. Besides, it got the kitchen awfully hot in the summertime. And what the heck, I didn't like to chop wood any better than anybody else did!

"Our solar heater was a square box affair and it had four tanks in it and it was covered by glass. It faced south-west, of course, just the direction the house was. It was our main supply of hot water. The pipes came down through the house from the heater, one went to the bathroom, and one went to the kitchen. There was no excess of plumbing.



"The type of day would mean how hot the water was or how quick it would heat up. It usually didn't take long for those tanks to heat up. You see, each tank held maybe ten gallons. You'd be surprised how fast it heated up. I know that on an ordinary sunny day everybody in the house could take a bath and wouldn't have any trouble at all, but you had to kind of time when everybody was going to take a bath, you know. By afternoon, my mother and our housekeeper would have enough hot water for baths and by evening there would be enough for us kids. We used to go barefoot all the time and then, you know, we had to take a bath every night, or else!

"Whether we had hot water the next morning depended on how much we used the night before. If we didn't use all the hot water up, it stayed

fairly warm . . . warm enough to wash your hands and face. But I don't remember if it was hot enough to take a bath or not. The water was never quite hot enough to do the laundry where you wanted the very hot stuff though. It was hot enough for a small amount of washing, the things the women wore, but when we did the heavy washing, the stuff we kids wore, our overalls and that stuff, we always had to boil it on the stove. As far as washing your hands and face, bathing, and washing dishes, we never had any trouble at all. I can't remember any trouble. You'd be surprised how much it would heat up even on a cloudy day. In the wintertime usually there was a couple of kettles, one anyway, sitting on top of the wood stove heating; they were used for dishes and a lot of things because the water in the solar heater never got as hot in the wintertime as it did in the summertime.

"I know when I was walking down to school, Throop, walking down Colorado Street to Walnut Street and then down Fair Oaks, that's where Throop was, as I remember, every house had a solar heater. We didn't think the solar heater was anything marvelous or revolutionary. Everybody had one. It was a thing of the time."

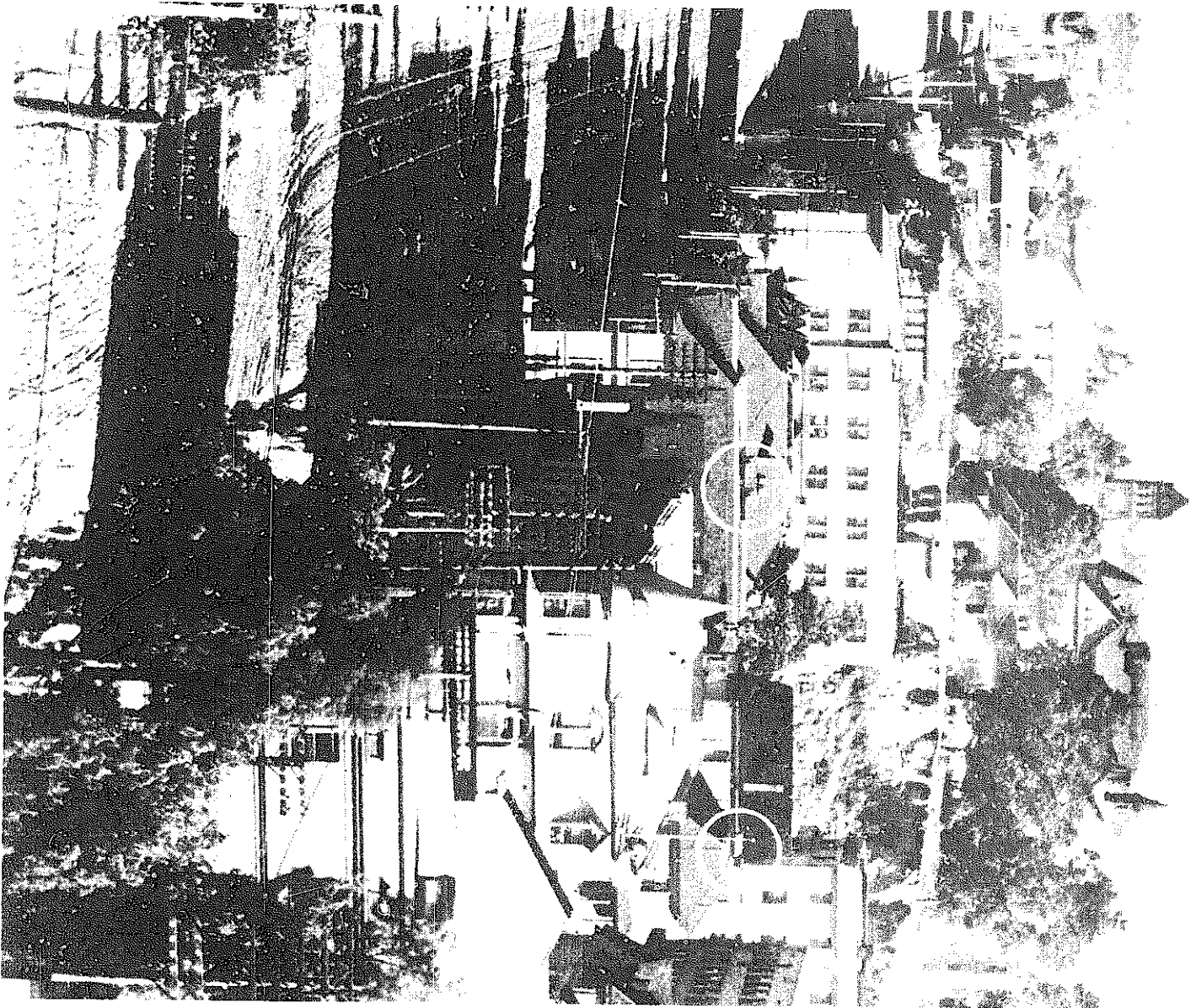

*Olive Street, north of Third Street, in Los Angeles, 1900,
showing three buildings using Climax Solar water heaters. Note clear skies.*

only looked better than the Climax which protruded from the roof, but it insulated the heater better. Walker also placed a polished metal reflector underneath the tank to focus direct sunlight onto it (although later research proved there was little if any additional heat gained through this technique). Walker's design made use of the differences in density between hot and cold water to keep the two from mixing and insure that only the hottest water would be drawn. He placed the hot water outlet at the top of the tank where the hottest (therefore lightest) water naturally rose. The cold water inlet was placed near the bottom where the cold water stayed, never mixing with the hotter water until it too heated and rose. The Walker heater was connected to the conventional water heating system, which provided a back-up and assured his customers hot water at all



A Glendale, California, residence equipped with a Walker solar heater (seen at upper right corner of roof).

times. When the sun failed to adequately heat the water inside the Walker heater — for example at night, during extremely cloudy weather, or when it rained — cold water at the bottom of the tank flowed through a pipe to a heating coil inside a stove or gas heater. The water in the coil heated and rose back to the top of the tank, ready for service.

The cost of the Walker heater, including installation, was less than \$50 (\$340 in 1977). It was more expensive than the Climax No. 1, but many consumers were willing to pay a little extra for the added benefits. James Guinne a California historian, wrote that 'Walker's heater was "used extensively in southern California and has proved such a convenience and comfort to so many families."

1905 — The Improved Climax Solar Heater

Water in the Climax and Walker Solar Heaters warmed up slowly because it took time for heat to penetrate through the relatively deep body of water contained inside the cylindrical tanks. Charles Haskell, by 1905 owner of the rights to the Climax and Walker Heaters, reduced the depth of tank heaters without changing their volume by introducing a shallow, rectangular design. The broader, shallower tank heated faster than the cylindrical tanks because there was less water

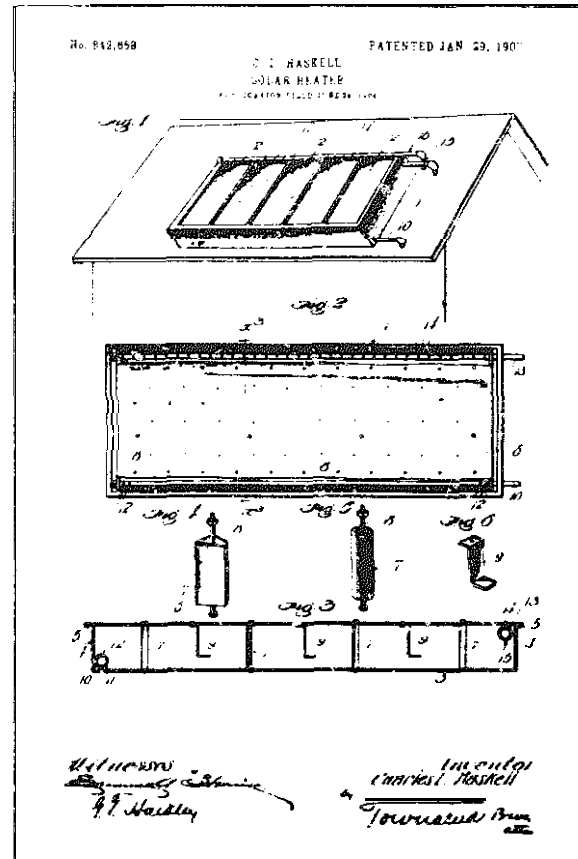

1907 — Charles Haskell's patent drawing for the Improved Climax.

per square foot of container being heated. This meant hot water earlier in the day. Haskell marketed his invention as the "Improved Climax."

The flat tank of the Improved Climax was painted black and fitted tightly inside a glass-covered box. Vertical metal braces inside the tank provided rigidity. Cold water entered through perforated pipe extending along the length of the tank's lower end — the perforations divided the water into numerous small streams, distributing the water more evenly than one relatively large stream would. Hot water was drawn off through perforations in the top of the hot water outlet pipe which extended along the length of the uppermost end of the tank. The Improved Climax, like the Walker, was usually connected to the conventional water heating system for auxiliary heat during unfavorable periods.

Usually the company installed the Improved Climax on or in the roof. An installer (James Bailey, 82) explained,

I'd put it on the side where it saw the most sun. Even on a foggy day, the first one to use it would get warm water. But, of course, on a sunny day it would be much hotter. Why, hell's bells! you'd have to use the cold water with it because you couldn't stay under the shower with just the hot water turned on! It really got hot!

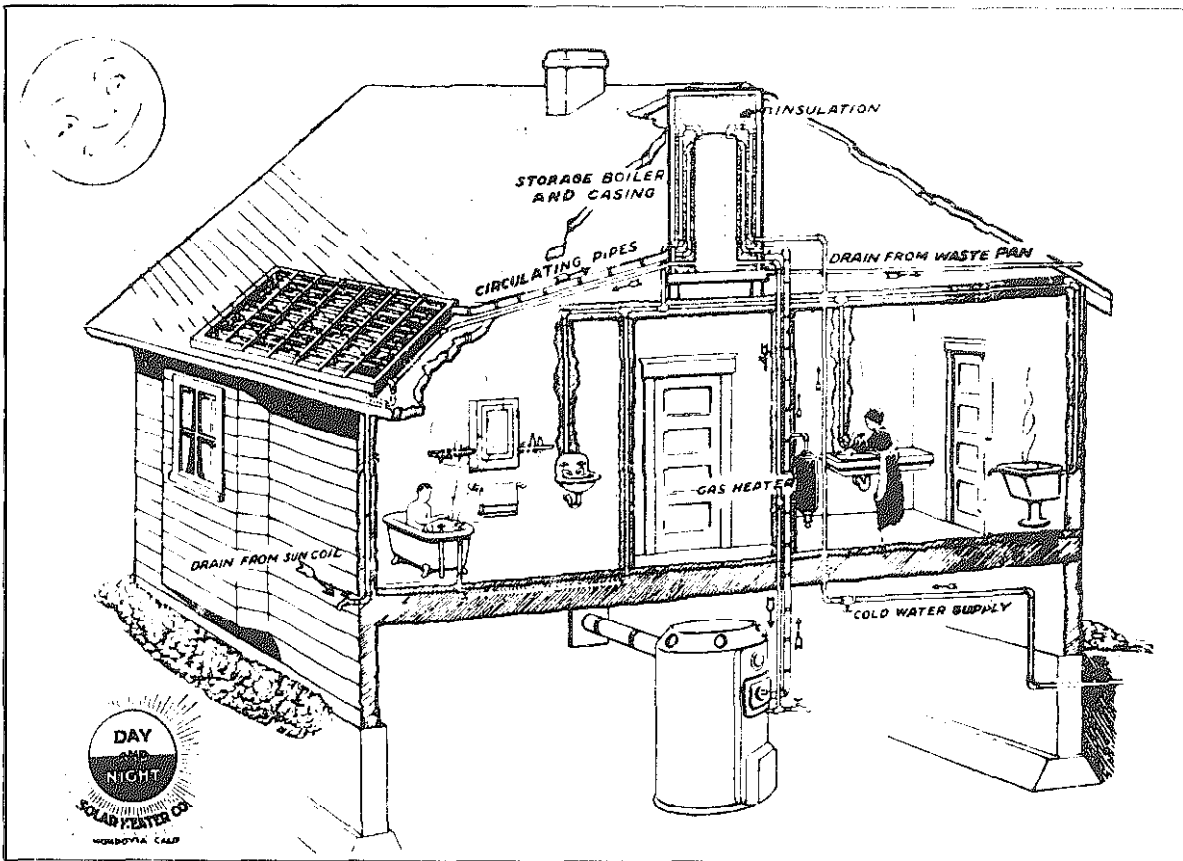

Typical Day & Night installation in a residence, 1918. Note auxiliary gas heater connected to the system.

J.J. Backus, Superintendent of Buildings in Los Angeles, wrote an open letter to Haskell about his Improved Climax heater in a 1907 issue of *The Architect and Engineer of California*:

I take great pleasure in saying that after a thorough trial extending over a year and a half, our solar heater continues to give just as much satisfaction as when first installed. I am ready to admit that we were unreasonably prejudiced against the heater, and feel that refusing to let you install one in my house for so long a time after you first approached me upon the subject, we lost a great deal of comfort and convenience. It looks to me that all your company needs is a little judicious advertising to increase your business beyond your greatest expectations. Of this we are sure, that every person having a heater will in a way become an advertising agent for your company, for so great will be his satisfaction that he cannot help talking about it.

The beauty of the Climax, Walker, and Improved Climax was their simplicity and effective performance during warmer months of the year, which in southern California was 8 - 9 months of the year. The Climax and Walker models heated water up to 120°F by the late afternoon; the Improved Climax could reach this temperature earlier in the day.

But no matter how well these tank heaters worked, the hot water stored inside the tanks was not well pro-

TECTED. Only a pane of glass lay between the tank and the outside air. During chill cloudy weather, or on cold nights, heat readily escaped and the water cooled. Although the enclosed tank heaters did not cool to the degree that bare tanks did, water was never hot enough for washing clothes in the early morning.

1909 — Day and Night Solar 'Water Heater

Kemp invented the first commercial water heater, and Walker and Haskell improved upon Kemp's design, but it was William J. Bailey's refinements that revolutionized the industry and created the configuration currently in use. Mr. Bailey, an engineer with the Carnegie Steel Company in Pennsylvania, came out to California in 1908. He rented a bungalow in Monrovia (a suburb of Los Angeles) and on the bungalow's roof stood "one of those old fashioned solar heaters consisting of a tin tank and a sash of window glass." The tank heater performed well during the day, but every night the heated water cooled. Mr. Bailey, formerly employed to upgrade various manufacturing processes for Carnegie Steel, applied his talents to improve upon the shortcomings of tank solar heaters. He divided the solar water heater into two separate units — a solar heat collector and hot water storage unit.

Bailey's solar heat collector was a shallow-glass-covered box, only four inches deep, lined with felt paper. It



1911 Pomona Valley, California, house with Day & Night Installation. At left is what we would call their "organic" garden.

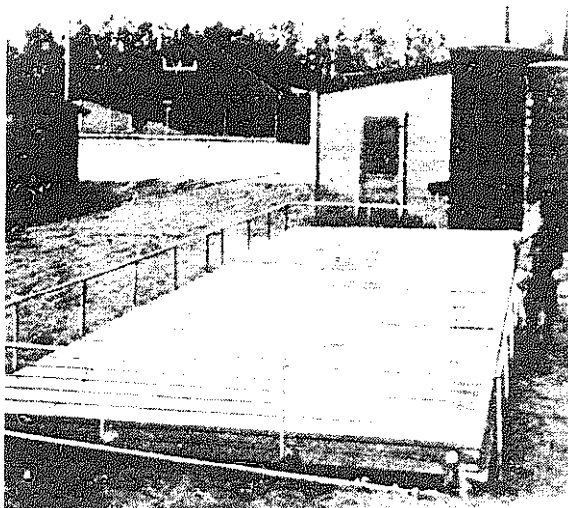

1918 - Solar water heater at the Army Balloon School, Arcadia, California.

"When the United States entered the war the Day and Night Solar Heaters seemed to Mr. Bailey just what every camp needed and efforts were made to bring to Uncle Sam's attention all the good points of the apparatus. A demonstration heater was installed at the Army Balloon School at Arcadia and 500 gallons a day of hot water were provided for the boys. The balloon school heater was a success, but it did not prove anything to Washington, where high officials had been reading the advertising literature in vain. After long delays Mr. Bailey received a letter in which an army officer of high rank told him that, after deliberation, it appeared to the Board of Investigation that the proposition of heating water according to the Bailey method was about as feasible as getting gold from gold fish."

— Monrovia, California
Daily News

contained 3/4" copper tubing coiled back and forth across a copper sheet to which it was soldered. The copper sheet and tubing were painted black. Compared to the rather bulky tank heaters, "This heater makes a very neat appearance on the roof," remarked Bailey, "being a thin skylight affair." Bailey's solar collector produced hotter water faster than tank heaters because a smaller volume of water was heated at a time. Heat was conveyed to the water by copper, a better conductor of heat than the customary galvanized iron, and a greater surface area per gallon of water was exposed to the sun.

But the major advance was Bailey's heavily insulated storage unit. The sun-heated water was stored in a steel tank surrounded by insulation in a wooden box, where it would stay hot all night, and if necessary, the following day. Bailey could guarantee that when the sun ceased to shine, the water stored in the tank would not lose over one degree per hour.

The storage tank stood above the collector. The bottom of the tank was connected by pipe to the lowest tube in the solar collector; the top of the tank was connected to the highest tube so that hot water entering the storage tank would drive the cold water at its bottom back into the collector to be reheated. The water circulated in this fashion without need of pumps as long as the water in the collector was hotter than the water in the bottom of the storage tank.

A man (William W. Crandall, 86) who installed Bailey's solar heating system described how he went about the job:

Once you got the tank up in the attic, you'd put it on a stand that was made at the factory. Sometimes you'd have to build a platform for the tank because you'd have to get it above the solar collector for

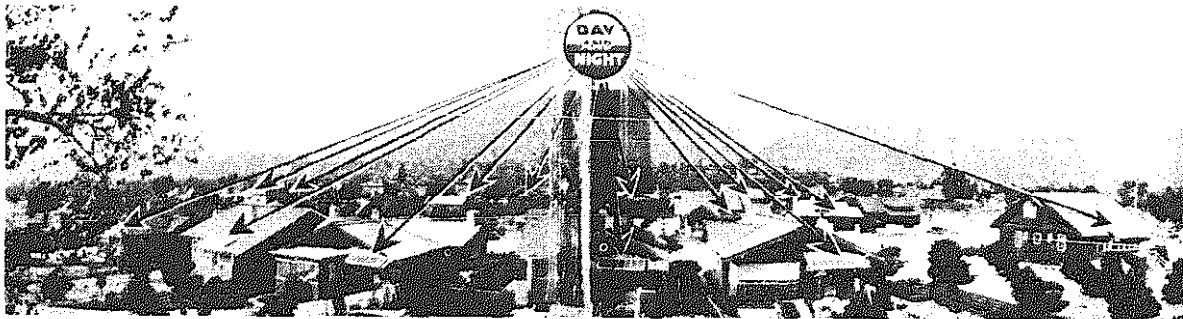

Sixteen Day & Night solar water heaters in one section of Monrovia, California, home of the Day & Night factory. By this time, 1918, 4,000 of their heaters were in use. Cost, \$100 for the 40-gallon model (\$600 - 1977).

good circulation. Then you'd build a box around the tank. And you'd make all your pipe connections. Then you'd dump this sil-o-sel (powdered limestone) in for insulation. And if you don't think that was a mess. That powder floatin' in the air and you'd have to spit that stuff out! At the narrowest point, there would be three and a half inches of sil-o-sel, but around the tank at the corners, there would be seven, eight, or nine inches of this powdered stuff. And then over the top. Thoroughly insulated!

Then to pull that solar collector up on the roof! On some jobs, two story houses, with that tubing in the middle and all that lumber and sash, it wasn't light! We had skids, down on the ground and up on the roof. We'd set the solar collector on the skids and put a rope around it. Just by mean strength and awkwardness, we'd put it on the roof.

When you'd have the right exposure, that is a south exposure, that was just ducksoup. I've also installed them on pergolas, I've installed them on the north-side of the house on brackets which gave it the same exposure as you would get on the southside of a house. I've even installed them on the ground. In other words, we'd find a way!

Usually we connected the storage tank to some type of auxiliary heater to insure hot water after several days without sun. Sometimes we'd hook up a small electric insert heater to the storage tank. It would automatically turn on when the water went below the desired temperature. On other jobs, I've connected storage tanks to gas heaters, wood ranges, and even furnaces down in the basement.

The end result of Bailey's creation was "a solar heater that will heat water and keep it hot under conditions that would render most other heaters of little or no use," one newspaperman wrote in July, 1909. "It is the NE PLUS ULTRA of solar heaters."

Bailey saw a large market for his device as there was little change in the energy situation or other water heating technologies in California since the introduction of the Climax. Bailey established his solar water heater business at Monrovia in the summer of 1909. "It war a little outdoor shop on the corner of Lynnwood and Myrtle," an early resident of Monrovia recalled. Bailey called his new firm the Day and Night Solar Heater Company to emphasize the uniqueness of his product - "Steaming hot water from a solar heater day and night!"

The system sold well. The smallest model, a 4 foot by 10 foot solar collector with a 40 gallon storage tank, cost about \$100 (\$600 in 1977) installed. Customers, however, were willing to pay a higher price than for the Climax because of the grater convenience the Day and Night system offered. No longer did the housewife have to wait until the afternoon for hot water from a solar heater. "Many of our customers are reporting that they are putting out their entire washings early in the morning with hot water from a heater we installed," a Day and Night ad proclaimed. "Ask your neighbor if she can do this with her old style heater."

Many of Day and Night's first customers bought the solar water heating systems to reduce their gas bills. Whereas the Climax cut gas consumption by 40%, the Day and Night saved 75%. The smallest Day and Night system saved the consumer about \$25 a year, an annual return of 25% on the investment. Day and Night Heating Systems were even in greater demand in the rural districts where there was no gas. They paid for themselves in one to three years depending on whether the customer was substituting solar for electricity or coal.

Even though there were "a large number of solar heaters in use throughout southern California," according to The Architect and Engineer of California of May, 1907, "and the number is constantly increasing," the solar water heater remained mystifying to some individuals especially a product that promised sun-heated water day and night. A rancher (Paul Squibb, 83) recalled such skepticism in the area where he lived:

When they first began putting in these Day and Night jobs, old timers were giggling about how silly they were. They'd say, 'You couldn't get water any hotter than if you just stood a can full of water out in the sun.' One poor guy nearly got the skin burned off himself. He said he'd put his hand in any water heated by the sun and the poor guy got an awful roasting. He jerked his hand out before he lost his skin! He just didn't realize the accumulative effect of the solar heater.

Demonstration models set up at fairs and operating at the Day and Night office verified the company's claims. One advertisement urged skeptics to:



"The sun coil in this installation serves as an awning for an outside cellar-way. One of many ingenious installations we have worked out."

Day & Night brochure



"The sun coil here, in addition to supplying plenty of hot water, keeps the kitchen temperature lower by absorbing and conveying to the storage boiler the sun's rays that would otherwise enter the kitchen window."

Step in (to our office) some cloudy morning following a day of sunshine, hold your foot in the water from the Heater for five minutes, and we will give you the Heater. Cork legs are barred from the test.

With his business growing, Bailey incorporated in 1911 and moved to a larger plant. But in early 1913 his company almost went under because of a disastrous freeze that hit southern California. "Lowest temperatures ever known were reported in some of the orange districts early this morning," read the front page of the Los Angeles Times (January 9, 1913) "In some localities the thermometer registered 19 20° F with the mercury still falling." The water inside the tubes of many Day and Night collectors froze and the tubes split. "His (Bailey's) telephone rang all night long - irate customers were having problems with water coming through their ceilings," his son William recalled, "so that sent him back to the drawing board to design a non-freezing solar water heater."

Bailey's non-freezing system made the solar collector's circulation system independent of the storage tank's water supply. He connected the tubing in the solar collector to a coil inside the storage tank. A non-freezing solution (usually water mixed with alcohol) circulated through the solar collector and the coil in the tank. As the heated solution passed through the coil, it transmitted its heat to the water inside the tank, cooled, and returned to the solar collector to be re-heated. Another advantage of this independent circulating system was that you could use distilled water in the solar collector. In areas where the water was very hard, this prevented deposits from accumulating and crusting up the tubing.

With the danger of freezing resolved, Day and Night's business continued to flourish. The company expanded its marketing territory to northern California, the Hawaiian Islands, and Arizona. Arizona Magazine wrote in 1914, "The sight of the 'Sun Coil' (Day and Night's trade name for its solar collector) is becoming as familiar on Salt River Valley homes as in California where they have been in general use for several years."

Over 4,000 Day and Night Solar Heating Systems had been sold by the end of World War I, and the solar

water heater became synonymous with Day and Night's name. The more efficient coil design forced the manufacturers of tank solar heaters out of business. Day and Night's only competition came from local plumbers and handymen. Solar water heating systems were simple, and "The man who was handy with tools and pipewrenches could build his own." The Sheet Metal Worker commented in 1914. All a plumber or handyman had to do was to see a Day and Night job and then copy it. Out in Ramona, California, one plumber sold collectors made of galvanized iron pipe coiled back and forth on black tar paper. Another equally simple but more effective design built by a Santa Barbara plumber consisted of similarly coiled pipe strapped to copper backing. The storage tank could be any ordinary water tank boxed in and insulated with sawdust, ground cork, rice hulls, or other coarse, dry materials.

Day and Night's sales of solar heating systems peaked in 1920 with over 1,000 sold that year. Then natural gas began to erode the solar water heater market. All major natural gas finds in the Los Angeles Basin occurred between 1920 and 1930, with the exception of the Wilmington Field. Production of natural gas exceeded demand and fuel prices dropped. In 1900, one thousand cubic feet of gas with similar heat equivalency to natural gas had cost \$3.20; by 1927 a thousand cubic feet of natural gas cost only \$.90. Networks of new pipelines connected town and rural areas formerly without gas.

Complementing these new gas discoveries was the concurrent development of the automatic storage gas water heater - the type currently in use. The solar technology developed by Bailey led to its invention. Bailey now insulated a gas-heated water tank just as he had the solar storage tanks. He also designed a copper heating element which conducted gas heat to the water more efficiently, just as he had done with the solar collectors.

Bailey's gas heater also had a thermostat that automatically heated water to the desired temperature. "No trouble. No fuss. Simply turn dial indicator," ran a Day and Night ad promoting its new automatic storage gas water heater. "All the hot water you need, heated quickly and kept hot in an insulated tank, constantly awaiting your needs."

**"What so Rare as a Cloudy Day
in Arizona"**

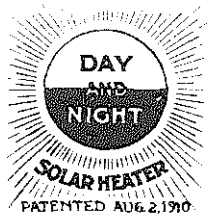
HOT WATER		FOR THE
Summer Winter Spring Fall without Gas Bills		Bungalow Garage Residence Apartment Hotel Business Block

**SUNSHINE
Like Salvation is Free!**

and
Every Arizona home should take advantage of it by installing a
"Day and Night" Solar Heater

because
It can't stop working, while the sun shines
It can't get out of fix, explode, or start a fire.
It not only heats your water,
It **KEEPS IT HOT** in a storage boiler.

Will it really work?
Thousands of satisfied users think so.
Let us give you prices and full information.

Write
Southwestern Solar Heater Co.

218 Nat'l Bank of Ariz. Bldg. P. O. Box 1298
PHOENIX ARIZONA.

Arizona magazine advertisement, 1914



Signal Hill oil field in the Los Angeles basin circa 1920. Discoveries of local oil fields were the end of solar water heaters in California – for the time being.

The gas companies pushed the sale of automatic storage heaters as one of many programs to encourage gas use. "They'd finance gas water heaters on a monthly basis or let you carry 'em for a year or two," retired plumber R. Carroll related. "The gas company would do anything to get you buyin' from them." Through cut-rate prices, easy terms, and free installation service, gas companies added new customers.

The combination of cheap, accessible supplies of gas and the convenience offered by the automatic gas water heater sent solar water heater sales plummeting. In 1926 Day and Night sold 350 solar heaters and in 1930, only 40. But the company's sales of gas water heaters soared. "Steaming hot water day and night" now meant water heated by gas. Day and Night became one of the largest producers of gas water heaters.

As to the fate of the solar water heater -- in 1923 Bailey sold the patent rights on the heater to an entrepreneur in Florida for \$8,000 (\$24,000, 1977) and an Oldsmobile touring car. This entrepreneur, according to Mr. Bailey's son, "made quite a bit of money on the solar heater because it had even a greater adaptability in Florida than it did in California." In southern Florida the solar water heater saw its greatest success. Water heating was expensive and the solar heater offered an economic alternative. By 1941 at least 60,000 solar heaters were installed, but war came,

Uncle Sam froze the use of copper, and the solar water heating industry ground to an abrupt halt. The solar water heating industry resurged after the war, but cheap electric rates stymied its growth. The once thriving solar heater industry, by 1955, was reduced to a small service business.

in California Day and Night continued building and selling solar water heaters, although at a greatly reduced level, until the beginning of World War II. The last production run was, as William J. Bailey, Jr. recalled, in 1941:

It was for Pan American Airlines, who bought a big lot of them and had intended to ship them out to the South Pacific to put them on Canton Island. That was the time when Pan American flew the old Clipper Ship runs to Australia, and Canton Island was the stop-over point. They wanted hot water there and using solar was the only way they could get it. Those water heaters were on the dock in San Francisco, ready for shipment, when Pearl Harbor came along. They were never shipped. ■

NOTE TO READER – If you have any knowledge or experience of early American solar technology, we would be grateful to hear from you care of the publisher -- Box 428, Sausalito, CA 94965.

*– Ken Butti and
John Perlin*

Solar Energy Thermal Processes

Dilettantes stand aside! This one is for the trained engineer/scientist interested in sharp performance and cost analysis of solar heating and cooling systems. The basic theory is presented in great detail, but the practice concentrates on flat plate hardware, with a bit on focussing devices. Storage and system-modeling are also discussed thoroughly. Unfamiliar, unusual and innovative designs are given short takes only, but the book will fill a long felt need in architect's offices getting into solar work.

— JB

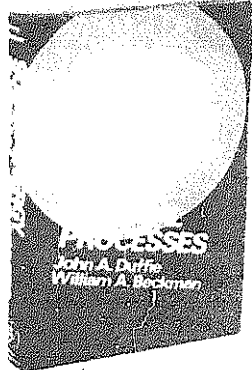

Solar Energy Thermal Processes

John A. Duffie and William A. Beckman
1974; 385pp.

\$16.95 postpaid

from:
John Wiley & Sons, Inc.
One Wiley Drive
Somerset, NJ 08873
or Whole Earth

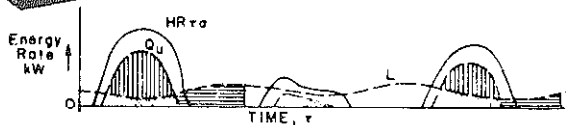

A hypothetical solar energy process with storage. Absorbed solar energy, $HR\tau\sigma$, collector useful gain, Q_u and loads, L as a function of time for a 3-day period. Vertical shaded areas show times of excess energy to be added to storage. Horizontal shaded areas show energy withdrawn from storage to meet loads. Dotted areas show energy supplied to load from collector during collector operation.

Enhanced Solar Collection

This paper gives all the formulas needed for the design of a reflector that boosts the performance of a flat plate collector as much as 60%. Mr. Mathew's house uses such a reflector which is one reason it can do so well in a climate like that of Coos Bay, Oregon. Very technical presentation requires user to be able to handle college level math. Very impressive gain in efficiency makes it essential reading for the solar house designer.

—JB

[Suggested by Henry Mathew]

Enhanced Solar Energy Collection Using Reflector-Solar Thermal Collector Combinations

D.K. McDaniels, D.H. Lowndes, H. Mathew, J. Reynolds, R. Gray
1974; 60pp.

\$2.50 postpaid

from:
D.K. McDaniels
Physics Dept.
University of Oregon
Eugene, Oregon 97403

Henry Mathew, whose all-solar house plans are reviewed EPILOG p. 533, writes:

My house is being improved slightly as time goes on. So far this fall, solar heating has supplied 100% of our heating except for electric blankets and built in electric heaters in the bathrooms.

A book was written, proving by mathematics the best angles of roof reflector and heat collector in almost an infinite number of sizes and angles, with more than 20 graphs and charts, all of which are of immense value to anyone designing a solar heating system. The name: Enhanced Solar Energy Collection Using Reflector-Solar Thermal Collector Combinations.

— Henry Mathew
Coos Bay, Oregon

Pocket Solar Meter

In the past, if you wanted to actually measure the "power" in the sunlight falling on a site or collector, you had to use a very expensive instrument called a pyranometer. Now you can do it much cheaper with this ingenious meter which is calibrated for direct readings in BTU per ft^2 per hour, Langley's per hour, and mW/cm^2 . It's solar powered too; no batteries. Diffuse radiation can also be measured, as can losses through transparent materials. Looks good to me, especially at the price.

— JB

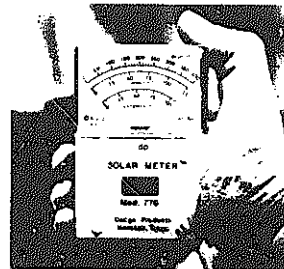

Pocket Solar Meter

\$51.00 includes shipping

\$6.50 case

from:
Dodge Products
Box 19781
Houston, TX 77024

Thermic Diode Solar Panel

Diode? You mean like transistor? Well, sort of. The key feature of this nifty idea is a marvellously simple valve that prevents the solar heated water from back-siphoning at night and losing its hard-won BTUs. This scheme also has the advantage of being self-contained; it serves as its own storage tank. No pumps either. Its designer, Dr. B. Shawn Buckley of M.I.T., estimates a cost 30 - 50% less than "conventional" solar heating systems. Even if you're up to your eyes in solar hardware claims, I'd watch this one.

— JB

[Suggested by Conn Nugent]

For more information watch Popular Science Magazine, or you might try a self-addressed, stamped envelope to:

Dr. B. Shawn Buckley
Massachusetts Institute of Technology
Department of Mechanical Engineering
Cambridge, MA 02139

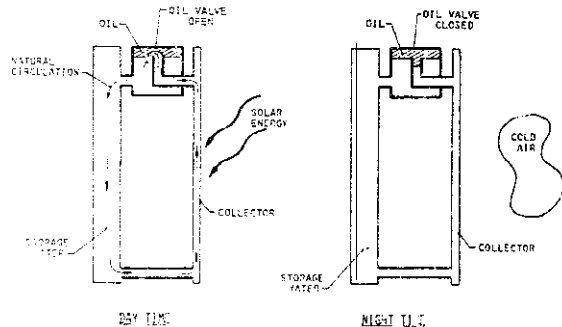

California Solar Information Packet

Developed to answer the flood of inquiries concerning solar energy, this packet presents a quick course in solar principles and available equipment. It's current, accurate, and free. No copyright either. A fine example of getting the useful word to the people.

— JB

California Solar
Information Packet
free

from:
Publications Unit
California Energy Commission
111 I Howe Avenue
Sacramento, CA 95825

Solar Age

This magazine is now the official publication of the American Section of the International Solar Energy Society. The editor is Bruce Andersen, who is one of the authors of the excellent Solar Home Book (see p. 132). In the two years it has been with us, Solar Age has developed into a truly useful tool. It's where you look for the latest results from the field, professional controversies being worked upon, and detailed discussions of news items briefly covered in various media. Many of the articles are of a caliber one expects to see in a formal book, but in Solar Age you get it about two years sooner. You can subscribe in the normal way, or get it as a part of your membership in the Solar Energy Society (p. 49).

—JB

Solar Age
\$20/yr.
 (\$10 extra outside
 U.S. and Canada)

from:
 Solar Age
 Church Hill
 Harrisville, NH 03450

Solar Energy Digest

Though I still consider this newsletter to be a bit skinny for the money, it is where you often hear of new developments first. Also, the editor puts the money to good use in his research and lobbying efforts. It's been coming our way since 1973, and I always look forward to the new issue. I must have sent away for dozens of things I first saw here.

—JB

Solar Energy Digest
\$28.50/yr. U.S. and
 Canada
\$29.55/yr. Mexico

from:
 Solar Energy Digest
 P.O. Box 17776
 San Diego, CA 92117

Inflated Solar Energy Concentrator FOR HIGH EFFICIENCY POWER GENERATION

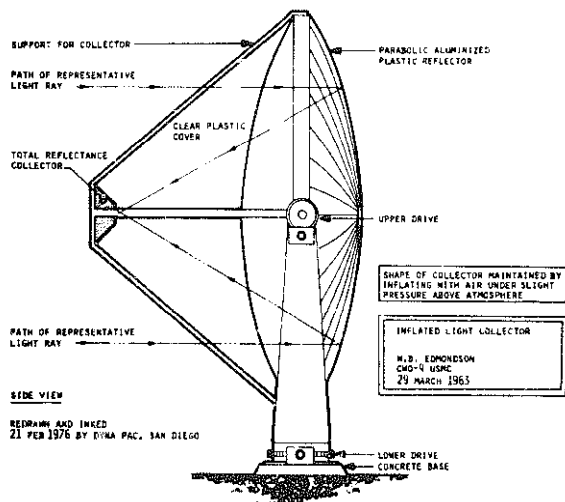

Little arctic solar trackers

CoEvolutionary Game: Many arctic flowers, especially buttercups, are shaped quite similar to a parabolic mirror and in fact have the same function. By focusing all the available heat in the center of the flower, a pollinating insect is warmed. This allows the insect to react quickly to predators and to fly further to spread the flower pollen. Thus the flower helps the insect's chance of survival and the insect has a better chance of pollinating another flower.

—Rob Roach
 Olympia, Washington

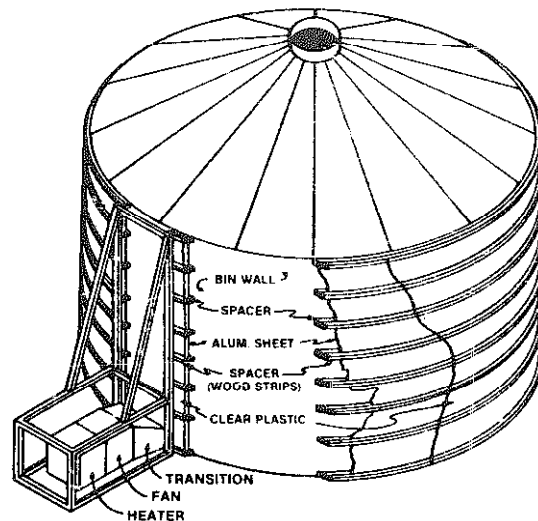

Solar Heat Drying Bin tested by the University of South Dakota.

Alternative Sources of Energy

For a good overview of what's going on in all departments of "alternative" energy, ASE remains a good magazine to have coming in six times a year. There has been a steady improvement in quality of reporting, especially in the articles concerned with experimental projects. They are often just plain exciting!

—JB

Alternative Sources of Energy

\$10/6 issues
\$18/12 issues
 (Foreign airmail
\$24/6 issues)

from:
 Alternative Sources
 of Energy
 Route 2, Box 90A
 Milaca, MN 56353

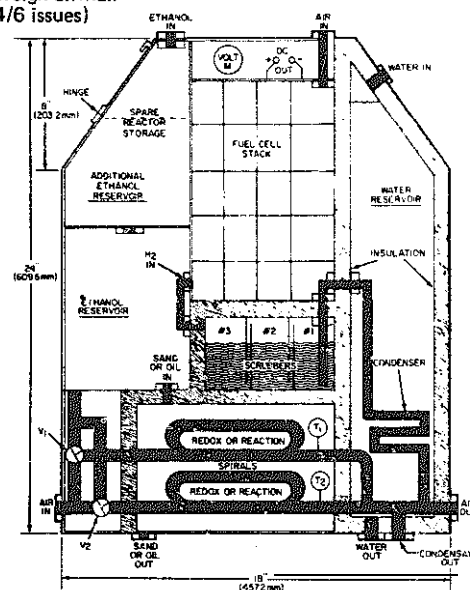

Proposed portable ethanol-electricity system.

Charles Ross is an artist who works with light — specifically, sun and starlight. In the '60s he was known for his arrays of giant prisms that spattered brilliantly-colored shards of rainbow across nearby surfaces and spectators with de-lightful abandon. Since then, he has shifted his attention to the unravelling of evidence — contained in the light itself — of the large-scale spatio-temporal relationships that govern our reception of celestial light here on earth. His Equinoctial Year project, briefly summarized on these four pages, marked the beginning of the shift.

Flat photo-images, like the one on the facing page, can barely suggest the vivid sensuality of the burns. They are etched deep into the wood, charred and fissured

canyons, rimmed in places with delicate halos and wisps of soot. They are graphic demonstrations of solar power and the vicissitudes of weather, and the effect of seeing the whole year's worth at once is quite spectacular.

*The material presented here is adapted from Ross's elegant, large-format book, **Sunlight Convergence/Solar Burn**, which was published last year by the University of Utah Press (40 pp., available from the University of Utah Press, 1400 East 2nd South, Salt Lake City, Utah 84112, or the John Weber Gallery, 420 West Broadway, New York, NY 10012; price \$20.)*

Ross, 40, lives half the year in New Mexico and the other half in New York City. —Robert Horvitz

SUNLIGHT CONVERGENCE/ SOLAR BURN

A Solar Narrative Drawn Across 366 Wooden Planks by a Focused Point of Sunlight

BY CHARLES ROSS

**The Equinoctial Year:
September 23, 1971 through September 22, 1972**

Each day for one year, I placed a wooden plank at the focus of a large stationary lens. As the sun passed across the sky, the concentrated power of its rays burned the day's signature along the plank. In the evening the burn was collected and a new plank was set in place. As the cycle continued, it became ritual: the evening harvest of solar forms.

Varying cloud conditions punctuate each burn. Bright sunlight leaves a broad smoke flare. Passing clouds cause unburned interruptions. Overcast days produce blank boards. The length, width, and depth of each burn is affected by atmospheric conditions such as haze and smog.

White light to charred matter. Primal forces captured by the primal camera. Energy to image; regulated thru the fluctuating iris of weather, drawn along the board by the rotation of the earth, segmented by the alternation of day and night. The work could not be made. It had to be derived directly from the source. A window was built so that cosmic elements would reveal themselves.

The artist as catalyst — precipitating form without interference or interpretation. The burns are not information about, but rather a point of contact with their source. They look beyond the notion of art as a closed system to propose art as a point of contact with the universe energy matrix.

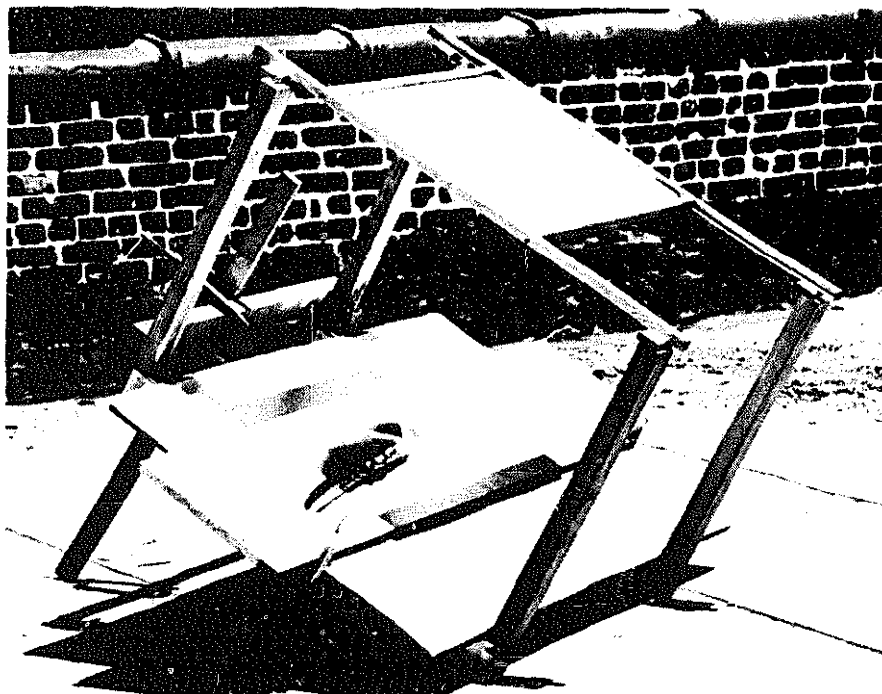

The tools: A flat Fresnell lens measuring 19 X 25 inches with a focal length of 24 inches. Each night a wooden plank was centered under the lens in exactly the same position. The plank measured 1 X 5 feet and was 3/4 of an inch thick. The wood was fireproofed so that it would burn at the focused point of light but would not flame or "catch fire." It was coated with a special white paint that would hold traces of the smoke plume. The apparatus was attached by hinges to the roof of 80 Wooster St., Manhattan, New York, so that the lens faced south and could not be turned in an east-west direction. Occasionally, as necessitated by the seasonal change in the sun's altitude, the lens assembly was tilted (at night) so that the burn would remain centered on the board. The setup was not moved or touched during the course of a single day's burn.

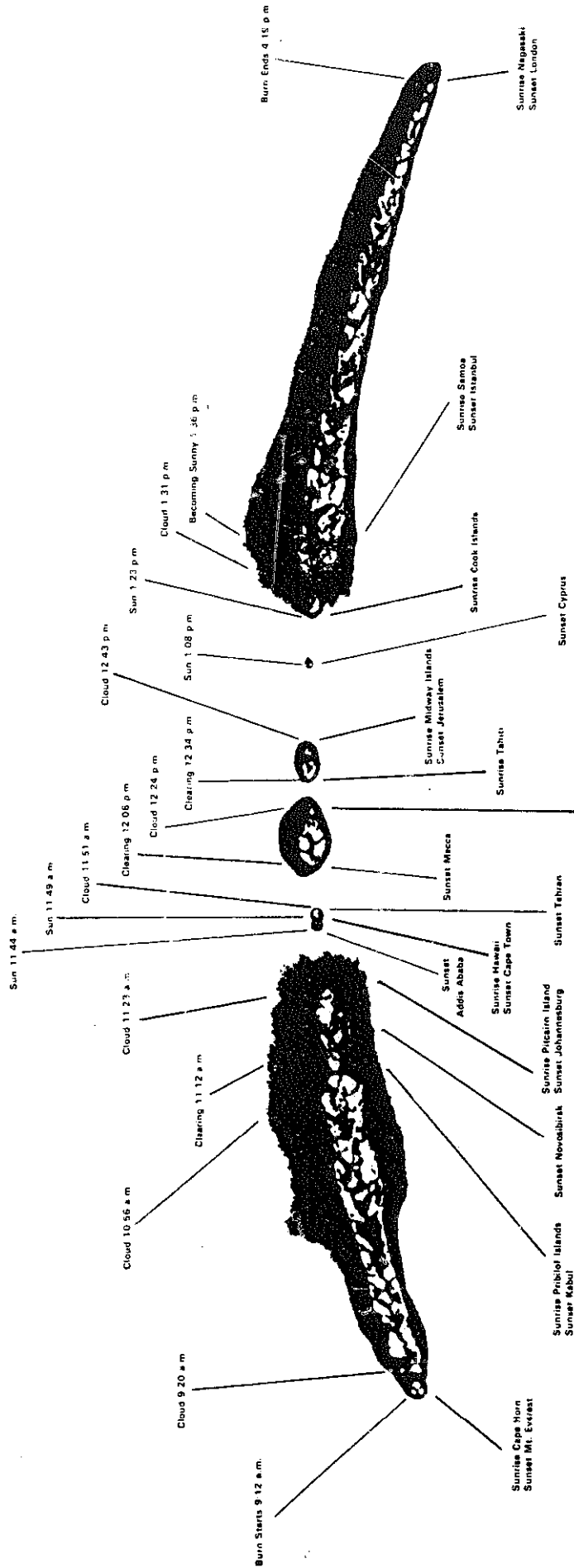

July 1, 1972, New York City

[more →]

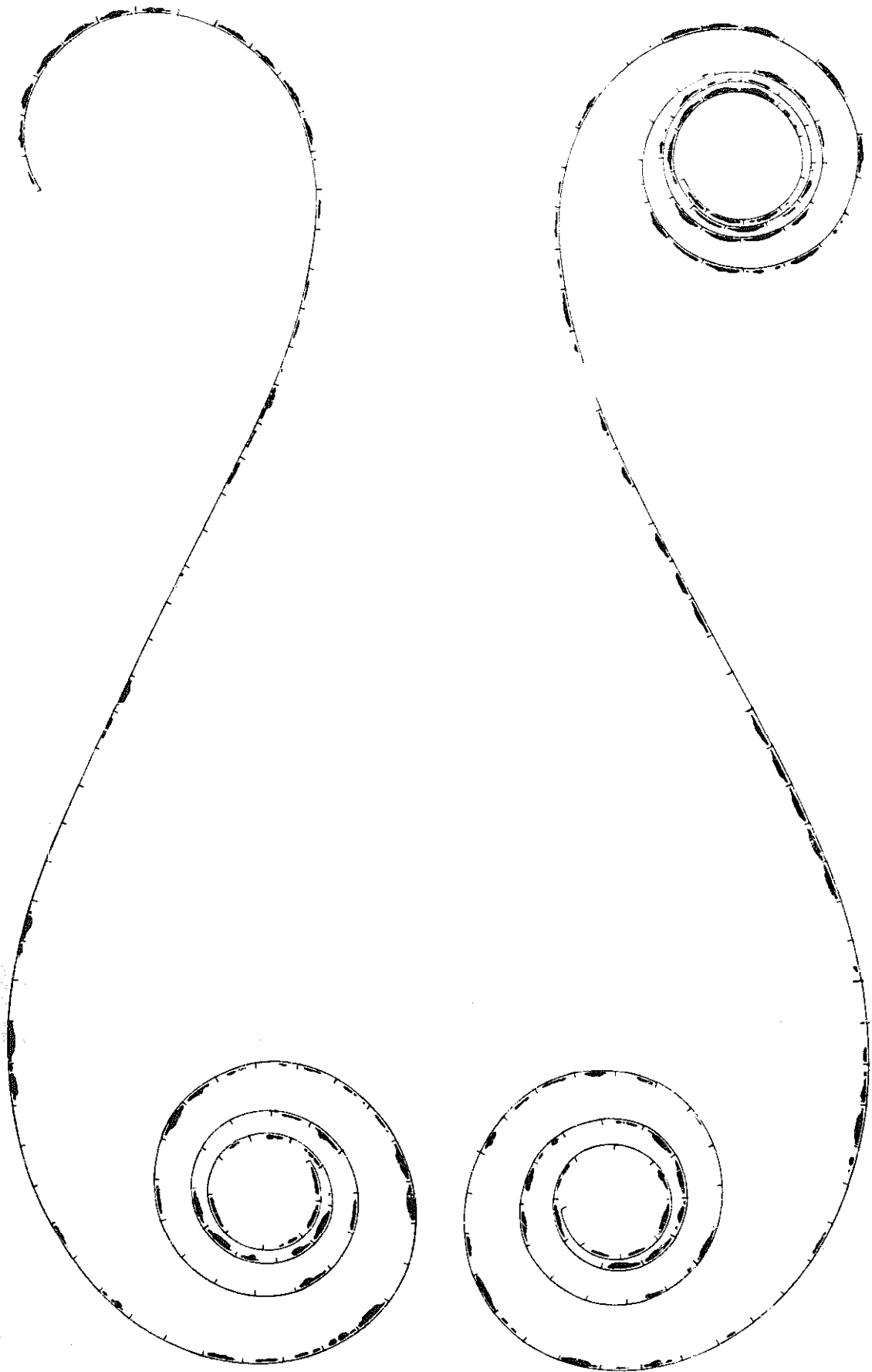

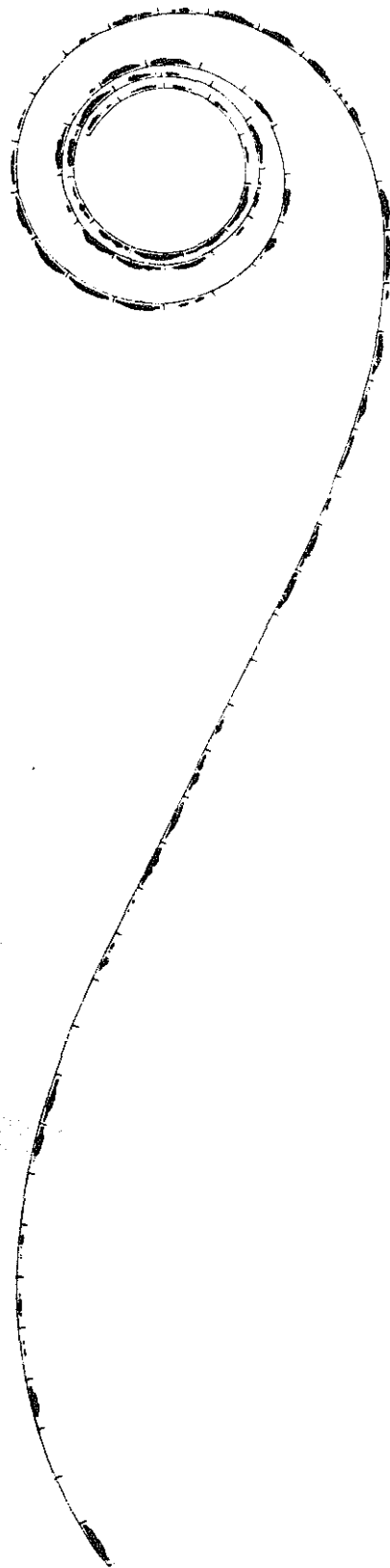

The Year Shape

The curvature of the burns varies with the seasons, reversing from winter to summer and straightening near the beginning of spring and fall. I first noticed the changing curvature toward winter; the burns were becoming concave and seemed to contradict the daily arc of the sun across the sky, which is always convex. However, the curvature of the burns is not drawn by the rotation of the earth on its axis, but rather by the motion of the earth around the sun. It seemed that if the 366 burns were placed end to end following their actual curvature, they should form an S shaped curve similar to a plane projection of the ecliptic, the S shaped path of the sun seen on many star maps.

I had noticed that the burn curvature was not always exactly aligned with the ecliptic, but attributed this divergence to a lack of precision in the lens set-up and I was curious to know how it would affect the shape of the year. Since the burns would cover over a third of a mile if laid end to end, they were scaled down in photographs and I began constructing the curve using a length of spring steel wire to follow their day to day continuity. The resulting shape was a complete surprise.

The year shape is a double spiral which rapidly closes down to a circle around the winter solstice and then spirals open, straightening into spring. Curving more slowly in the opposite direction, it curls around the summer solstice, then spirals open again to straighten into fall.

Far from being imprecise, the burns had captured subtle and ordinarily imperceptible elements of the earth/sun system. The "quality" of the curvature in the burns — concave, convex, or straight — belongs to the ecliptic. But the specific degree of curvature, and the amount it changes from day to day, belongs to the position and speed of the earth in its orbit. During New York's winter, the earth is closer to the sun and consequently is traveling faster through space than it is in summer. This change in speed is reflected in the winter burn spiral which closes more rapidly and tightens into a smaller circle than the summer spiral.

Through the medium of a lens, sun light and earth element were brought together and a previously unknown solar form materialized. The image was contained in the light, not in the materialization process. Drawn by the sun itself, the burns reflect the forms, forces, dimension, and time scales of the energy that made them. ▽

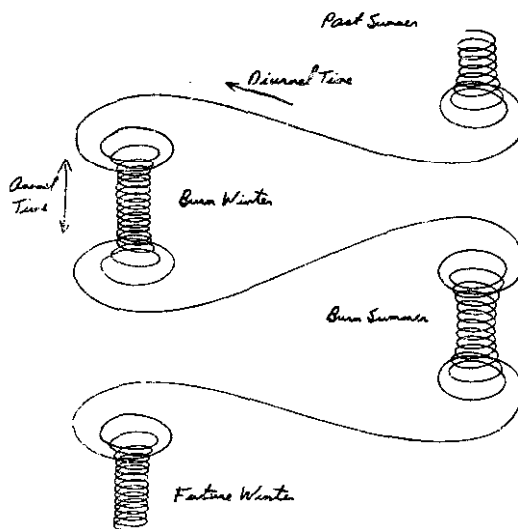

The year shape in three dimensions. This may be viewed as a materialization of two different kinds of time: diurnal time, the succession of days winding across the horizontal plane, and annual time, the vertical stacking of the seasons.

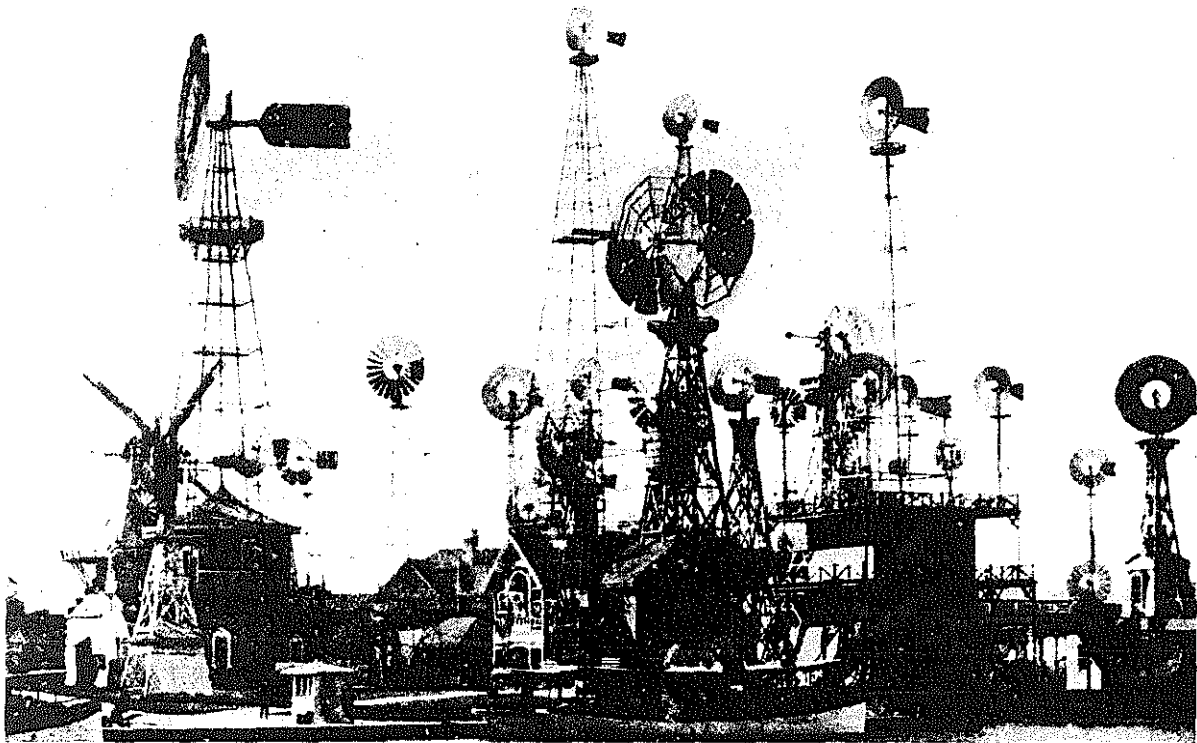

Windmills competed at the World's Columbian Exposition, Chicago, 1893.

Wind-catchers

Well, I still don't like books written for a 12-year-old mind, but I have to admit I learned a lot about windmills that I didn't know before. Guess that'll do for now. . . .

— JB

Wind-Catchers
(American Windmills of
Yesterday and Tomorrow)
Volta Torrey
1976; 226 pp.

\$12.95 postpaid

from:
The Stephen Greene Press
P.O. Box 1000
Fessenden Rd.
Brattleboro, VT 05301
or Whole Earth

Wind Workshop 2

This huge document is the record of the second Workshop on Wind Energy Conversion Systems held in June, 1975. Since that time, the popular press has extracted many of the highlights, so you may not find too much new here if you've been following the scene. What might interest you, though, is the monstrous bureaucracy being hatched, and the manipulations of the large corporations as they dance the profit gavotte. It is also interesting to compare the rhetoric with the miserable performance of the NASA machine at Plum Brook. Not only has that machine suffered from problems predictable by any amateur who has actually built a windplant, it represents another expensive example of a new phenomenon in our society: the money grab evolved to the point where the artifact is not delivered in the specified form. (California's BART transit system is another example of this.) In the old days after all the graft and corruption was paid, the public at least got something that worked. (In this case, it's Lockheed again. . . .) Anyway, the book is a good information mine both for wind people and social scientists.

— JB

Wind Workshop 2
No. 038-000-00258-9
1975; 536 pp.

\$7.45 postpaid

from:
Superintendent Of
Documents
Govt. Printing Office
Washington, D.C. 20402

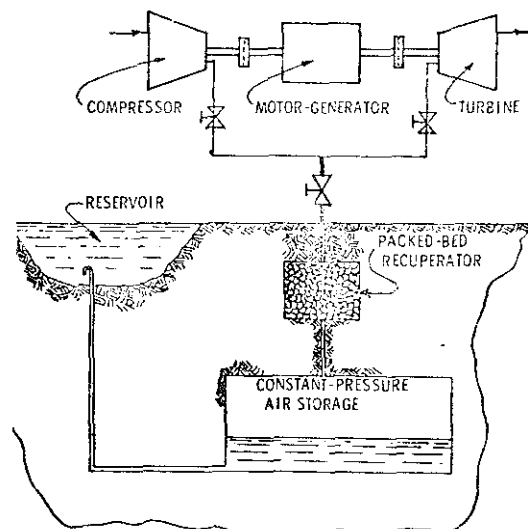

Constant-pressure, near-adiabatic compressed air energy storage scheme

Wind Power Access Catalog

The Fall issue of the ever-better Wind Power Digest (CQ Fall '75), includes a fine catalog of wind machines and related hardware. The publisher eagerly offers this only as the first issue of a new subscription and it will not be available as a back issue. If you were waiting for a good reason to subscribe, you have no excuse now.

- JB

Wind Power
Access Catalog
A supplement included
in the Fall 1977 issue of
Wind Power Digest)

\$6.00/yr (4 issues)

from:
Wind Power Digest
54468 CR 31
Bristol, IN 46507



Wind Energy Utilization

Yup. Who, when and where, plus energy-saving abstracts. If you're serious about wind energy and want to know more, this is where to find more.

-- JB

Wind Energy Utilization
(A Bibliography -- 1944-1974)
Technology Application Center
University of New Mexico
1975; 496 pp.

from:
TAC, University
of New Mexico
Albuquerque, NM 87131

\$10.00 postpaid

Here's an interesting bit of news from our Department of Energy (DOE)

U.S. to Help Refurbish and Test
Twenty-Year-Old Wind Turbine in Denmark

After a decade of generating electricity and a decade of standing idle, a large wind machine in the town of Gedser, Denmark has been refurbished and is being tested with help from the U.S. Department of Energy (DOE).

DOE has entered into a cooperative agreement with the Research Association of Danish Electricity Supply Undertakings (DEFU) to refurbish and test the only survivor of the "older generation" of large experimental wind turbines. DEFU's Research Association is much like the United States' Electric Power Research Institute, but in addition directs the Danish wind energy program for the Danish government.

Because the "Gedsermill" has withstood 20 years of exposure to the elements, including 10 years of operations and 10 years without any maintenance, it provides U.S. and Danish researchers with a unique opportunity to study the lifetime of wind turbines and their components. Of a number of large experimental wind turbines tested in Europe during the 1940s and 1950s, the Gedser is the only one that still exists.

"A wind turbine has to last a long time, perhaps twenty or thirty years, to amortize its cost and thus provide economical electric power," said Louis Divone, chief of DOE's wind systems program. "Because the Gedsermill is the only existing large wind turbine in the world with a long operating history, it can provide us with insight as to how to design our new wind turbines for long life."

Wooden wind-generator blades

For those of you interested in making or restoring wind machines, here's a place that makes blades, and at a reasonable price too. Your choice of Douglas Fir or Sitka Spruce (for harsh conditions); one piece 2 blade, or separate blades for multiblade set ups. All balanced and with a one-year guarantee. A way to save much hassle.

- JB

Information from:
Aero Power Systems, Inc.
2398 Fourth Street
Berkeley, CA 94710

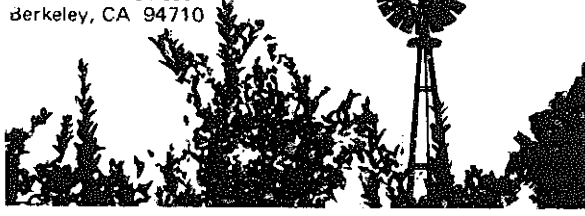

North Wind Power Co.

At this writing, the Jacobs wind machines remain the best available despite the 40-year old design. Finding a used one is not easy, and restoring it requires special knowledge and skill. This outfit offers reconditioned used machines and related equipment, and also offers parts for restorers. Their prices reflect the demand for this equipment, and the fact that they are apparently able to get the prices asked is something of an indicator of the quality of the more "modern" competitive machines. If you need really good hardware, this might be a good place to look.

- JB



North Wind Power Co.
Catalog

\$2.55 postpaid

from:
North Wind Power CO.
Box 315
Warren, VT 05674

WIND GENERATORS

Reconditioned Jacobs Wind Electric Plants FOB Warren, VT

Cat. No.	Capacity	Voltage	Price
apc-J-47	3000 watts	120 volt	\$5250.00
apc-J-45	2500 watts	120 volt	3750.00
apc-J-46	2800 watts	32 volt	3050.00
apc-J-49	2500 watts	32 volt	2750.00
apc-J-50	2000 watts	32 volt	2250.00
apc-J-51	1800 watts	32 volt	2050.00

Accessories for Jacobs Wind Electric Plants

Propellers

apc-GK-12	for fly-ball governor	400.00
apc-GK-14	for blade-actuated governor	400.00

Blade Actuated Governor

apc-GP-11	Governor & new props when purchased with wind plant	800.00
apc-GP-12	Governor and new props when purchased separately	1050.00
apc-GP-13	Governor alone	600.00

Solid State Controls

apc-SS-1	for 110 volt plants	300.00
apc-SS-2	for 32 volt plants	300.00
apc-DLS-2	Dynamic Loading Switches	120.00

Energy from the Wind (Annotated Bibliography)

This hefty number is just what you'd expect: complete right down to the last zephyr. "Annotated" means you get a very brief whiff of what the paper is about. The latest supplement is as up to date as you're likely to get unless you're writing it up this afternoon.

— JB

Energy from the Wind
(Annotated Bibliography)
Barbara L. Burke and
Robert N. Meroney
(About 2 inches thick total)
1975, 1977

Basic volume
\$7.50 (\$8.00 foreign)

First supplement
\$10.00 (\$11.00 foreign)

Both
\$15.00 (\$16.00 foreign)
from:
Publications
Engineering Research Center
Foothills Campus
Colorado State University
Fort Collins, CO 80523

Wind Technology Journal

The long awaited publication of the American Wind Energy Association (AWEA) consists of technical papers that will interest the "serious" wind experimenter. It looks good. No fluff at all.

— JB

Wind Technology Journal
\$15.00 /year (4 issues)
for AWEA members
\$20.00 /non members
from:
Wind Technology Journal
P.O. Box 7
Marston Mills, MA 02648

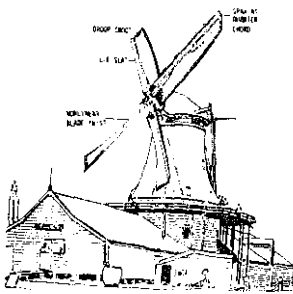

A typical Dutch windmill as developed by the end of the 17th century.

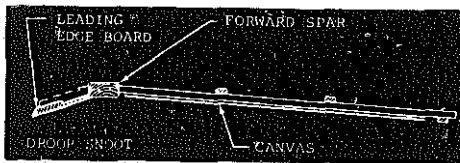

This Is How You Can Heat Your Home With A Little Windmill

One of the most efficient ways to use windpower is to heat water. Electric heaters are more than 90% efficient, and you can just dump the generated electricity into the heater without the expense of a voltage regulator. Even better, you can allow the generator to put out more and more as the wind goes to higher speeds that would cause a battery charging system to either burn out or have to waste a lot of the available power. This can be important; wind often comes in short, high velocity bursts that a conventional set-up is unable to fully utilize. A water-heating windmill need only be governed at a speed short of it flying apart, and so can get much more energy from a given site. (Energy in wind rises as the cube of the speed.) An added advantage is that an insulated water tank is simpler, longer lived and cheaper than a big battery string.

Simplified Wind Power Systems for Experimenters

Here's a how-to-design-it book for wind machine neophytes that looks like it's organized logically and not too heavy mathematically. Written by an engineer accustomed to teaching inexperienced aerospace technicians, it relies heavily on simple graphs and example problems. In addition to the usual power required/power available calculations, it covers airfoil, mechanical, and structural design, the latter particularly well. Battery storage technology and electronic controls are not treated well.

This is not a design cook book full of plans, but rather a simple, graphic engineering text for those thinking about building their first windplant.

—Chuck Missar

Simplified Wind Power Systems for Experimenters

Jack Park
1974; 72 pp.
\$6.00

from:
Jack Park
Box 445
Brownsville, CA 95919

or Whole Earth

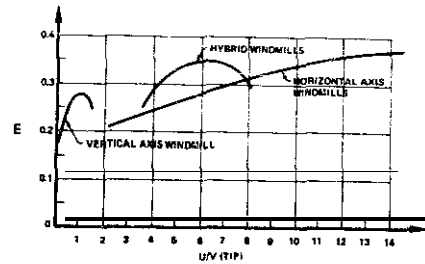
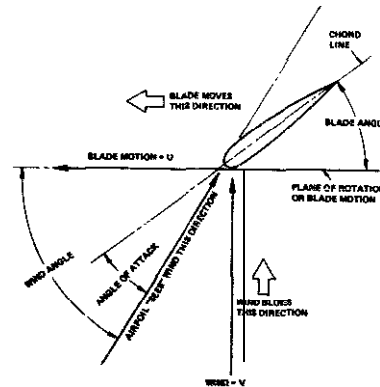

FIGURE 7 RELATIVE EFFICIENCY OF THREE WINDMILL TYPES



This oversimplified booklet is a translation of a Swedish study showing the feasibility of wind-heating small houses on the Swedish coastline. Conclusion is that it is feasible and would just barely pay for itself if commercially done. If the excessive price of the booklet is too much for you, it isn't too difficult to calculate the figures necessary for your location if you know what wind is available.

— JB

This Is How You Can Heat Your Home With A Little Windmill

N.A.S.A.
author unknown
NTIS # N74-21681
1974; 11pp.

\$4.00
from:
NTIS
U.S. Dept. of Commerce
5285 Port Royal Rd.
Springfield, VA 22151

Gemini Synchronous Inverter

The Gemini takes power from a varying, intermittent DC power source such as a wind generator, and inverts it into household 120/240 volts AC. A Gemini system has no batteries. If the wind machine is making more power than you need, the Gemini feeds the excess back into the power company's "grid" (the network of wires). The power company sees this as a reduced demand on their generators, but it is not necessarily true that energy is saved. This is because the huge commercial equipment can't respond quickly to small load differences. Also, the extra power sent to them by your Gemini system may arrive at a time when it is not needed.

If the wind machine isn't making enough electricity for your needs, the Gemini automatically switches on commercial power to make up the difference. The power company sees this as an intermittent load that may occur at a time when demand is already high, so they must build and maintain equipment ready to deliver that power if required. They must also build and maintain the grid. For these reasons, the power companies are not anxious to pay Gemini owners for the power fed back into the grid; certainly not at the rates that you pay them for their power. Nonetheless, Hans Meyer and the crew at Windworks report that power companies have on the whole been cooperative in arranging for the installation of Gemini units (including suitable rates) in their territories.

There is a precedent for this cooperation. For many years there has been what is termed "regeneration". An example of this is an elevator that requires a large surge of power to rise, and by means of a relatively simple circuit, returns power to the grid as it descends. There are many instances where it is reasonable to regenerate, though the practice is not widespread. With cheap energy, it has been cheaper to ignore the possibilities of savings. For example, manufacturers of large diesel engines commonly run them for many hours as a test. The power is dumped without use. With a Gemini, this power could be used to run machinery and lights in the factory as well as feeding surrounding homes. A Gemini system also can be used in "co-generation" schemes where waste process heat is used to run generators that can power other industries or homes. (That steam you see rising from factories is often usable energy being dumped.)

It is easy to think of uses for the Gemini, and this thought-

provoking aspect may be as important as the device itself. You would think that with today's high electric bills, people would be thinking about saving energy, but it is surprising how many are not. Apparently, habit is stronger than economic incentive. In any case, a Gemini has the potential of saving large quantities of fuel and other resources.

Windworks now has more than 10 Gemini systems on line, including several interfacing with solar cells and hydro turbines. Gemini units can also be used to interface an intermittent power source with an auxiliary; a wind machine with a diesel generator, for instance. Gemini systems are available in large sizes and 3 phase too.

Windworks is concerned with things other than the Gemini. Recently they were awarded a DOE (Department of Energy) contract to develop an 8 KW machine for homestead use. They also sell nice history-of-windpower posters, and plans for a variety of wind machines and towers. Another case of a small outfit showing the way. — JB

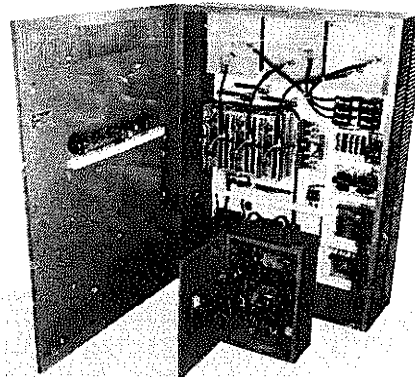

Gemini Synchronous Inverter

4KW-1 phase \$780.00

8 KW - 1 phase \$1,450.00

(write for prices of bigger ones, 3 phase equipment, and quantity discounts)

from:
Windworks, Inc.
Route 3, Box 44A
Mukwonago, WI 83148
(414) 363-4088

Technical Information Package \$3.00

Design With Wind

The idea of integrating wind generators into the structure of buildings is of new, but on the other hand it hasn't been done yet. This MIT Master's Thesis gets things started with some sharp research conducted with wind tunnel models. Mr. Coonley finds that wind velocity can be raised as much as 4 times by conducting it through a properly shaped and located hole, and that such a hole can use wind approaching from as much as 70° to the side. Power in wind rises as the cube of the speed, so there is a nice advantage in combining architecture and windpower devices. More advantages appear as windload on the building is reduced as is wind blast at street level. The paper is less rigorous discussing other aspects of windpower such as advantages and disadvantages of the several types of wind machines; apparently the author has not had much experience outside the wind tunnel. Nonetheless, this is a good start towards what is likely to be a practical use of wind. The book includes lots of graphs and diagrams.

— JB

Design With Wind
Douglas R. Coonley
1974; 140 pp.

\$8.00 postpaid

from:
Solar Bookshop
Total Environmental Action
Church Hill
Harrisville, N H 03450

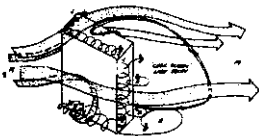

Storage Batteries

This highly technical text is the complete Word on batteries. Though not directly aimed at wind generator system storage problems, you can find the information you need by combining information from various chapters. Considering the subject matter, it's surprisingly easy to understand. One of the oldies-but-goodies.

— JB

[Suggested and actually read
all the way through by Jim Bukey]

Storage Batteries
George Wood Vinal
1924, 1955; 446 pp.
\$23.75 postpaid

from:
John Wiley & Sons, Inc.
One Wiley Drive
Somerset, NJ 08873
or Whole Earth

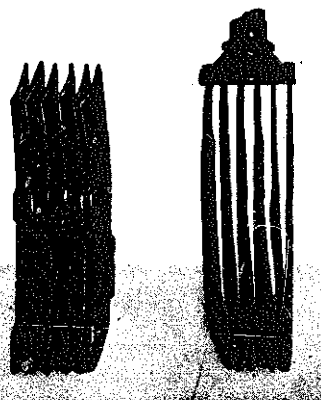

Buckled plates. There are a number of causes for this, but perhaps the most common is undercharging.

Homemade Windmills of Nebraska

Handcarved blades tipped with stainless steel? Ball bearings? Gears? Feathering mechanisms? Nope. A few boards and lots of "American Ingenuity" (for which this country is justly famed) make practical working machines that pump, saw, and in later times generate electricity. This paper was originally published in the 1890s and it's a real eye-opener. Funky, yes. Down-home, for sure. And it may well cause more people to make working machines than any wind-power book yet published. Interesting sociologically, too.

-JB

Homemade Windmills

of Nebraska
Erwin Berbour
1898; 78pp.

\$3.00 postpaid
from:

Farallones Institute
15290 Coleman Valley Rd.
Occidental, CA 95465

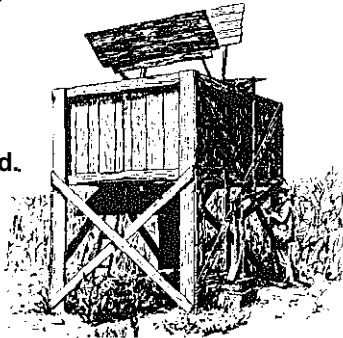

A six fan Jumbo windmill on the farm of W. W. Goodrich, Bethany, Nebraska, used in watering a six acre patch of egg-plants for the Lincoln market. The fans are each nine feet long with arms five and one-half feet long. Jumbo box nine by eleven by six feet high, with door below for the escape of dead air. Extra well built. Axis of Damascus steel. Total cost, \$8.00.

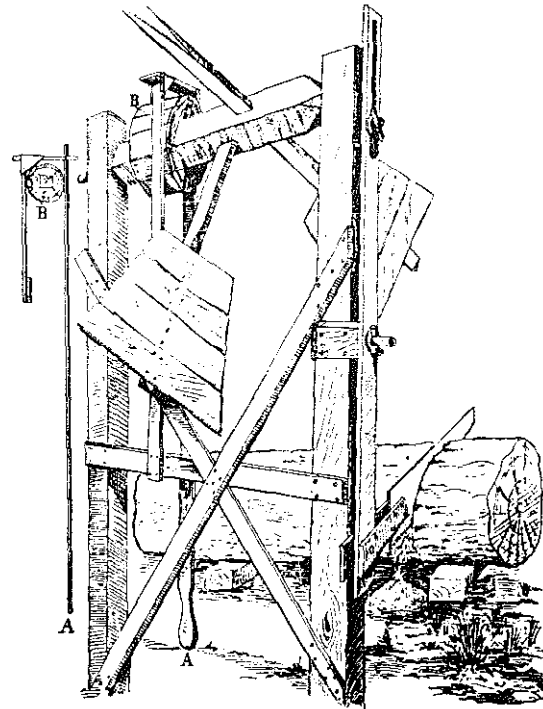

The Battle-ax windmill of Mr. A. G. Tingley, Verdon, Nebraska, as seen sawing a thirty-inch log. Diameter of wheel ten feet. The wooden drum and brake is self explanatory. This mill saws the wood for the family, and requires but little superintendence. To the left is seen a plan of the brake. The handle A cramps upon the wooden drum B. It is a cheap, simple, and satisfactory device.

The battle axe

We were among the original eight to purchase the Farallones pamphlet telling of Nebraska's home made windmills [above]. The designs seemed so simple, they worked, there were the drawings, the documents to prove it, that we soon believed we would be able to sprout windmills as easily as our central Wisconsin sand sprouts jackpines. It is now time for the inevitable "but" and here it is.

Construction began in April 1977, the builders full of hope that the kinks would all be out of the mill by the time the annual summer dry spell began to burn up the garden. Perhaps our first mistake occurred when we chose a spot to drive the well. The garden, and the mill, is situated near the center of a tongue-shaped three-acre clearing in the woods. Consequently, the mill is only one hundred and fifty feet away from the tall trees on both the west and south sides. A thirty foot, 1-1/4" diameter well was hand driven into the sand.

Next, the mill tower was built. Throughout the whole windmill project we tried to retain the homemade spirit of the pamphlet. Thus, logs, "cut from the place" were used. It took two men half a day to build it.

The mill itself, although it took more care, was also easy to build. We were very careful to maintain the balance of the mill. It was one of the few things we did right from the very beginning. It turned out that our care was worth the effort. When spinning freely, the mill stops when the wind does, and does not back up. Fully assembled and installed on the tower, the mill's axle is about 17' above ground.

The length of the arm of the crank was determined by measuring the distance of rise of the pump handle. Obviously it is one half that amount. The pushrod connecting the crank to the pump handle is a straight sapling. In order to provide more leverage, thereby making pumping easier, a wooden extension was attached to the original iron pump handle. The very first mill had only eight foot arms. It was too small to pump anything. The mill now pumping is the third attempt from scratch.

Since the whole windmill was only a "temporary" experiment, we never fastened the tower to the ground. Yes a stray freak of a breeze, a mere puff that barely stirred the

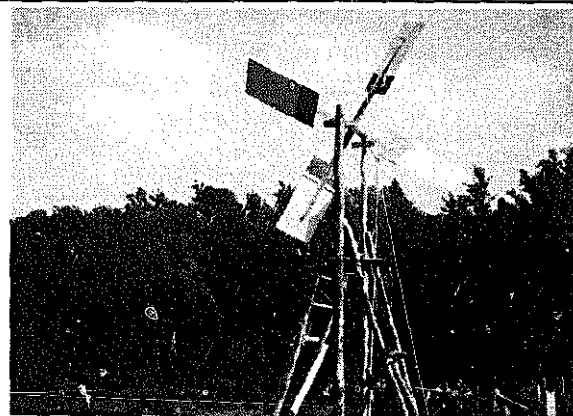

trees in the forest, caught the mill squarely one night and toppled it, tower, mill, pushrod, and pump.

We thought we could reduce some of the inevitable friction between axle and upright by letting that axle ride on large washers attached to the upright. That way the axle would not brush the rough wood. It worked, all the weight of the mill was concentrated on two wafer-like washers. They acted exactly like pipecutters, slicing through the axle, dropping the mill.

Lined up to Wisconsin's prevailing northwest wind, the mill turns perhaps every other day. On a good day, perhaps twice a week, it will pump two hundred gallons. This might be an adequate supply of water for a conservation-minded household, but it would not have carried our quarter acre garden through a drought such as that of 1976.

Consequently this winter will find us working on different designs but still using the **Homemade Windmills of Nebraska** as our guide. For although it snaps, topples, cracks, collapses, refuses to turn all the time, rubs, creaks, and groans, the homemade battle axe works.

Mike Goc
Adam, Wisconsin

Food From Windmills

ITDG (Intermediate Technology Development Group) has published an exciting book describing how a programme of simple sailwing windmill waterpumps has considerably raised the food production of a bit of Ethiopia. Though no actual dimensioned plans are given, enough details of the laboriously evolved machines are given so that you could make one that would work. Mr. Fraenkel claims that their sailwings will greatly outpump a Savonius Rotor, especially in low wind. Cost less too. The machines look pretty funky, but those of you that actually have made windmills will appreciate the excellence of the work done by Mr. Fraenkel and his associates. It is often more difficult to develop a reliable simple machine than to do it super-slick with an NSF grant.

And for the sailwing or other simple machinery, you can make bearings from wood. This is a skill well worth learning, as it enables you to make and service equipment that would otherwise be entirely dependent upon the supply of industrial bearings. I can think of circumstances where this could be critical. How to do it is nicely shown in the Feb. '76 issue of the ITDG quarterly "Appropriate Technology."

-JB

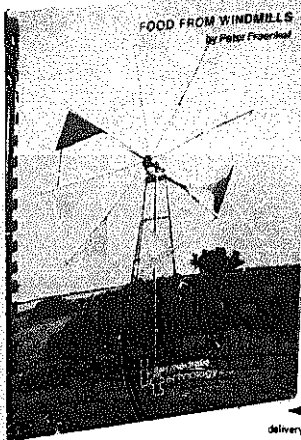

Food From Windmills

Peter Fraenkel
1977; 75 pp.

\$7.50 postpaid

from:
International Scholarly
Book Services, Inc.
P.O. Box 555
Forest Grove, OR 97116
or Whole Earth

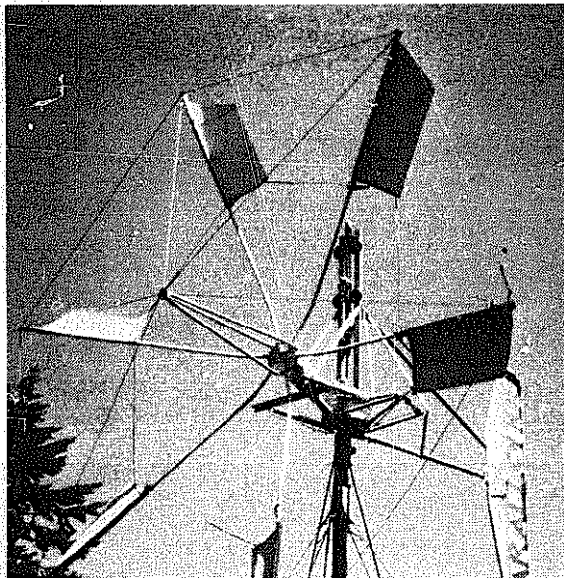
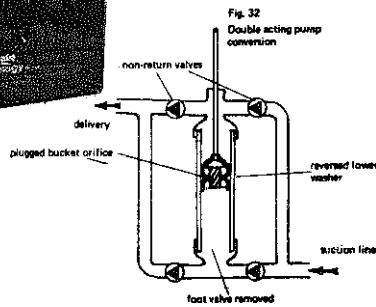

A 16 foot sailwing machine constructed by students at Farallones Institute using ideas from this book.



Windmills

People have asked me if Stewart lets the reviewer/evaluators take the books as payment for their work. He doesn't, dammit, or this book would for sure be one I'd cop. It's just beautiful, and it goes way beyond the usual historical-esthetic presentation typical of expensive coffee table pretties. You actually get the complete explanation of how they work! Complete enough, in fact, to make one... (guess I'll just borrow it awhile, heh heh) and I'd like to extend a sincere compliment for the reasonable price too.

-JB

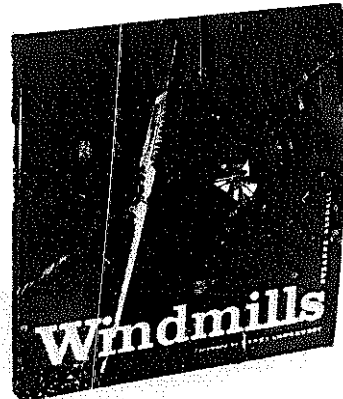

Windmills
Suzanne Beedell
1975; 143 pp.

\$12.00 postpaid

from:
Charles Scribner's Sons
Vreeland Ave.
Totowa, NJ 07512
or Whole Earth

There are tales that, in areas where smuggling went on, windmills were frequently used to convey warning signals. On a prearranged code, the sails would quietly be turned to a certain position at the approach of the revenue men, for instance, thus passing a message very quickly over miles of countryside.

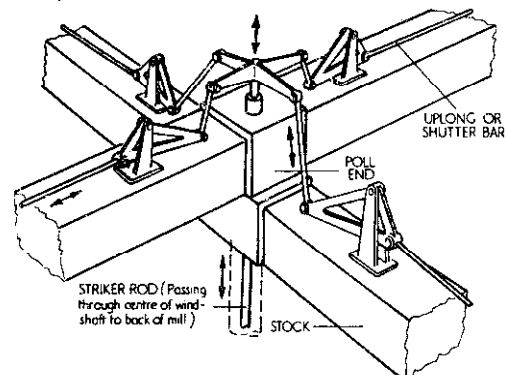

CARS

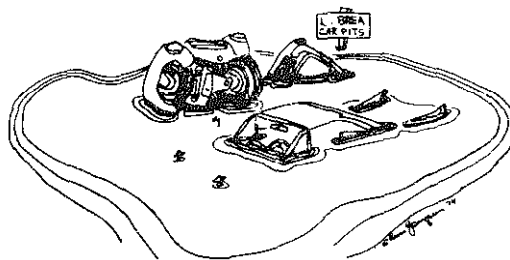

LAST YEAR, we Americans made about 3 million babies and 9 million automobiles. I don't know how to handle such figures. I suspect that even the horror statistics (we have killed more of our citizens in automobiles than in wars) have about as much effect on people's actions as the warning on a cigarette pack. Yet it is clear that we can't continue much longer without some drastic changes. The changes are in progress now. Cars are getting smaller, lighter, safer, cleaner, and more efficient. They are also getting more numerous and more expensive.

The cost of running and owning a car is already higher than many people think. Advertising subtly deflects thought from long term expense. My own car, a Citroen DS, has cost me a very low 8 cents a mile to own for 1 1/2 years and 260,000 miles. (Recent estimates show that a full size American car costs the average owner about 28 cents a mile). That includes fuel, lube, parts, service, insurance, depreciation, tolls, parking, right down to the sponge I wash it with. But that adds up to \$22,000.00!! Egad!

I can hear some of you saying, "Yes but my 1954 Chevy pickup has cost me practically nothing to run." I suggest that a hardassed analysis will show that it cost rather more than that. And the analysis doesn't include the old-car unreliability that reduces you to being the slave of the car rather than the other way around. Of course, a well restored older vehicle can be the cheapest way to go.

Best for the purpose are the mechanically simple compact cars from the mid 60s before smog equipment was mandatory. Later cars with smog hardware are difficult to tune, and the orneriness tends to get worse as the car gets older. Many people think that '65 Valiants and Darts are the best bets. Unlike their peers, they have reasonably good handling qualities. The automatics tend to be better than stick shifts because they have proven to be more sturdy. What they waste in fuel, they make up for by avoiding clutch and transmission jobs. Miles per dollar is more important than miles per gallon. For

similar reasons, a Dodge Van actually costs less to run than a VW bus. The difference in gas mileage (12 vs. 22) is only about \$200 a year in average use, but the VW gets poor miles per valve job and more than cancels the fuel economy. The Dodge van is also safer, quieter, roomier and more comfortable. Parts are cheaper too. As an ideal carpool machine, a van can offer added economy.

UNFORTUNATELY, the statistics show us tending away from car pools. The average car trip is less than 5 miles, carrying less than 2 people, a statistic which might be used to justify rearranging communities for bicycle access. The trend is towards the average load being one person. (One wag predicts that by 1985 the average load will be .7 person, thus indicating the evolution of a new breed of legless drivers.) Recent studies show that car pooling is likely to be cheaper and more energy efficient than any mass transit system yet devised, so we may see more people pooling soon. We may also see more people claiming that they have "given up their car," but in a nation that has been physically designed and built to require auto transport, such people actually use other people's cars instead of their own. Pious hitchhikers.

For many of us, an unreliable old car isn't the answer, and a new car is. What is a "good car" these days? First the bad news: the vast majority of manufacturers still make smoggy engines and then add a whole mess of expensive, finicky equipment to clean up the exhaust. This is

especially true in California. Most new cars cannot be tuned at home without complex specialized instruments. This puts you at the mercy of your friendly mechanic who may charge as much as \$35 per hour. Most of the new cars are still too heavy, fat, and hungry.

The good news is that there is a whole new breed of cars on the scene, and more on the way. These machines are epitomized by the Honda and the Rabbit. Both cars are front wheel drive, with the engine mounted crossways between the headlights. This arrangement results in absolutely extraordinary interior space. The Rabbit has more room in it for 4 people and their luggage than many cars weighing twice as much. Front drive gives superior mud and snow traction, excellent wind stability, and remarkable handling abilities. The crossways engine has also proven safer in a crash. If you have not tried one of these cars yet, you should. In my opinion, they thoroughly obsolete most other family type cars. It's quite a kick to see a Honda Civic calmly whizzing through the snow past a stuck \$20,000 Mercedes!

Hondas have turned out to be excellent cars, with the more recent Accord model being more refined than the rather crude Civic. Their reliability is legendary. Their waiting list is legendary too, and some dealers are showing signs of greed by posting a \$400 "dealer prep" charge. The best thing about Honda is that they have no smog equipment other than a few minor carburetor widgets. The



The Honda Accord is subject to a year-long waiting list in many regions of the U.S. for good reason. For the money it has no competition. Front wheel drive gives it extraordinary interior space, yet it is the same size as a VW beetle outside. On the road it feels like a big car, but gets about 35 mpg. Rumour has a 4-door coming next year.

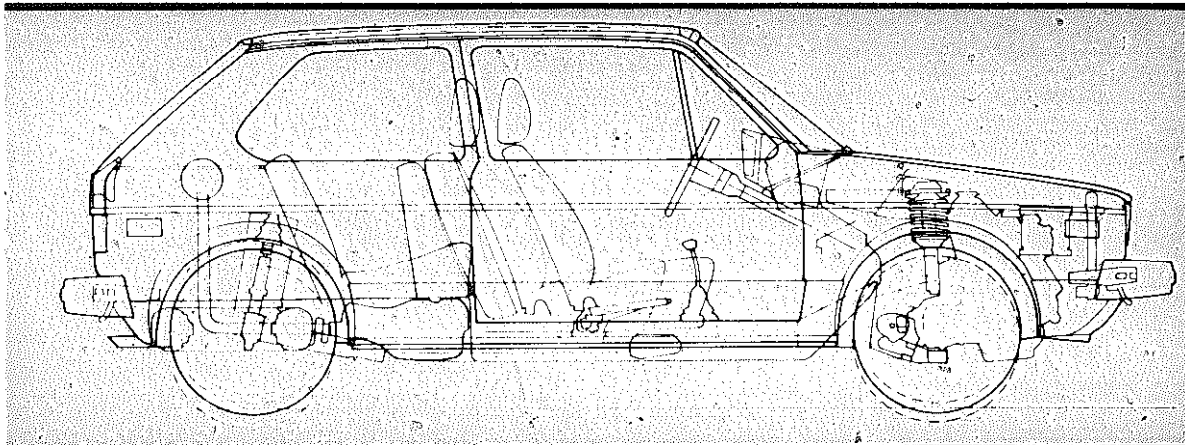

Cutaway of a VW Rabbit Diesel. I personally know a man who's Rabbit Diesel averages 45 mpg and has done as well as 52 mpg on long trips. Though a bit smaller than a Beetle, the Rabbit is nearly 40% bigger inside! Its road manners are impeccable. A wagon and pickup will allegedly appear in the near future. Rabbits are now made in the U.S.A.

CVCC Honda engine makes so little smog in the first place that it doesn't need fancy stuff to handle the nasties. The only real Honda flaw is a tendency to rust out badly and fast. This can be dealt with by having the car rust-proofed inside the hollow body parts at the time of purchase. (This is NOT the same as "undercoating.") Hondas are also available as a very handy 4-door wagon.

Rabbits, alas, have a well-deserved reputation for unreliability, though apparently things are getting better. Whether the Rabbits made in Pennsylvania will be good ones remains

to be seen. (The Plymouth Horizon and Dodge Omni are also largely Rabbit under the skin.) The gas Rabbits are fuel injected, which makes home tuning a no-no. Repairs can be expensive. But the Rabbit also comes as a Diesel, and this is definitely worth a look. Diesel engines get much better mileage than comparable gas engines. They do not require tuneups at all. They reputedly live a lot longer, though the Rabbit Diesel is mostly made up from gas engine parts which may prove too light for the job. Rabbit Diesels will soon be available as a wagon and pickup if we may believe rumor, and

this makes them even more desirable. There may be a Rabbit van soon too.

Another good feature is a shoulder harness that automatically puts itself on as you shut the door. Studies show that not one person in this country has been killed in a Rabbit so equipped! These belts are part of an expensive option package, an indication of corporate amorality. Nonetheless, assuming that the quality control problems are solved, the Rabbit is the best all-around family car available. VW has to be commended for switching from the almost unbelievably stupid Beetle design to such an intelligent one. Cars of this general configuration are surely the wave of the near future. What happens when the oil runs out is not yet clear. Probably some sort of electric cars will serve us.



One of the largest station wagons available anywhere, the Citroen CX Diesel can carry 3/4 ton and gets 35 miles per gallon. The CX is the first high production safety car, and has the lowest air resistance of any. Despite slick appearance, it has bad-road abilities nearly as good as 4-wheel drive machines. Americans are not allowed to import them.

SO WHAT will one of these new wave cars cost? Most of them go home for about \$5,500. Though that is a lot of money, you will be better off than with many other cars that are already comparatively obsolete. (Incidentally, some of the very best cars can't be legally imported into this "democracy.") The advanced design means that you can hold off on the financially disastrous trade-in because the newer cars won't offer much you don't already have. Good care and cutting down on unessential trips will save still more money. It will also save you. (Remember where that cents-per-mile comes from.) And, it will reduce pollution and conserve resources, which is where we came in. As with many things these days, the hopeful strategies depend partly upon intelligently designed hardware, and partly on an enlightened attitude.

—J. Baldwin

Pedal Power

This collection of pedal powered devices and proposals for a wide variety of untried applications will fascinate anyone who has nibbled at the idea of people-powered machinery. Frankly, I'm not too sure where all this is headed. Some of the ideas seem to have the sweating off of middle class guilt as the main function. Other contraptions will soon have their overworked human energy source hotfooting it down to the local Briggs & Stratton store. And a good many of the machines are not very well designed; provision for chain tension and operator cooling are inadequate. Overall, though, this book is representative of a healthy shift in attitudes, and is certainly moving in a good direction. At the very least, such concerns tend to force users of technology to take a closer look at what they are actually doing. Serious experimenters will probably also wish to consult *Bicycling Science* (see p. 82). Rodale is also marketing several pedal powered machines.

— JB

Pedal Power

(In Work, Leisure, and Transportation)
James C. McCullagh, Ed.
1977; 133 pp.

\$4.95 postpaid

from:
Rodale Press
33 East Minor
Emmaus, PA 18049
or Whole Earth

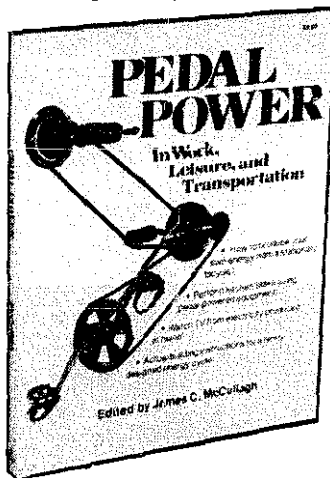

EASES THE TRANSITION
FROM CAR TO CYCLE

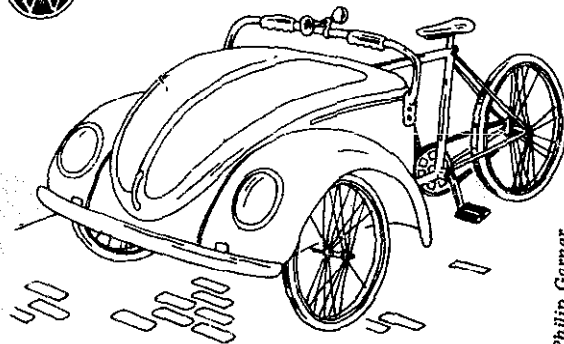

Philip Garner

Le Truck

On Tahiti, most public transportation is effected by vehicles known as "Le Truck." These are flatbed trucks with park benches running down each side and a roof covering the whole kaboodle. Entry is up the rear bumper. Side curtains can be let down in case of driving rain. Le Trucks have no set schedule. You wait until one appears and then get on it for about 40 cents (US) and ride until you get about where you want to be. Some just cruise around the city. Others go all the way around the island. Many seem to be owned by individuals much as taxis are here. It seems to work pretty well. No big bureaucracy with huge capital outlay for garages, mechanics, insurance, union contracts, vehicle fleets and retirement funds. Just a bunch of modest machines going where people want to go. They do it in Mexico too. Would it work here? I'll bet it would.

— JB

Without Wheels

Sooner or later, the internal combustion engine, and the car as we know it, have got to go. The question is, how and when? The wreckage of our cities must be reversed and the car's parasitism on the social bloodstream somehow ended. This book by a British writer amasses a large amount of modestly relevant information, and proposes a mixed approach, assuming the auto will never be killed through some blinding single stroke of invention, but rather through a slow process of slow attrition and transformation — i.e., the same way it achieved its present dominance. The central techno-social problem is, of course, that the auto-highway combine has passed the enormous costs of car-based transportation on the public in largely hidden and diffused ways, while any new alternative always has to be presented with more or less open figures — and losses.

But from Bendixson's worldwide survey we learn that we are not alone: many ingenious and workable schemes to combat the Curse of the Car are being hatched everywhere. Traffic control zones to make it harder, not easier, to drive into central areas where cars are already too numerous; dial-a-ride and similar systems that are halfway between taxi and bus service; the ancient and honorable jitney; train and bus service designed to help turn cities back into compact, walkable, sociable places instead of catering to suburban sprawl; tax and licensing policies that end subsidization of cars at the expense of other modes; experiments with computer-billed individual-driven taxis in downtown areas; all-day tickets for frequent riders. And so on — in Britain, Sweden, France, Saskatchewan, even the USA. "It is no longer a foregone conclusion," writes Bendixson, "that cars will inherit the earth." Since our alternatives to cars are about the most underdeveloped among industrial nations, American readers have a lot to learn from him — as we continue what is bound to be a struggle on many fronts.

— Ernest Callenbach

Without Wheels

(Alternatives to
The Private Car)
Terence Bendixson
1974; 256pp.

\$7.95 postpaid

from:
Indiana University Press
10th & Morton Sts.
Bloomington, IN 47401
or Whole Earth

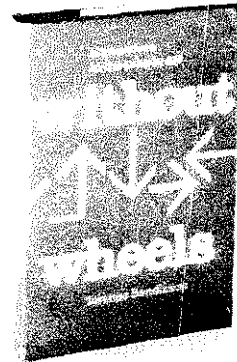

Dial-a-Ride

The prospective traveller rings a dispatching office, places an order for a trip, gives his name and address and at the time appointed a minibus with a radio telephone on board is waiting at the door. Some riders will already be in their seats and others will be picked up in turn at their front doors, on the way to the shops, the works, the hospital, the station or whatever. . . . Dial-a-ride is a bus and taxi hybrid. It gives a better quality of service than a bus but undercuts taxis in cost. Naturally, it attracts the antagonism of both. In Ann Arbor, Michigan, both the transportation authority and the Ford Motor Company were taken to court in 1971 by local taxi operators for having the effrontery to announce a dial-a-ride service. Fortunately for the people of the town, first Washtenaw County Circuit Court and then the Michigan Court of Appeals found against the taxi men.

. . . a Morris Mini doing forty miles to the gallon and carrying four people will be more economical than a twelve-miles-to-the-gallon coach carrying twelve. Less fuel would be burned if the coach party was sent off in three minis.

A Model Used Oil Recycling Act

If you were my congressperson and I came up to you and started bitching about all the used oil that was being thrown away into our water supply instead of being recycled so we wouldn't have to import oil from all those Arabs etc. & etc. you'd be on the spot, wouldn't you? Because you wouldn't know what to do to get a bill going that would get recycling going. You'd have to hem and haw instead. But if someone waved a well-worked-out model bill in your face and asked you to get one like it passed, things would be easier, right? Right. Let's get on it.

— JB

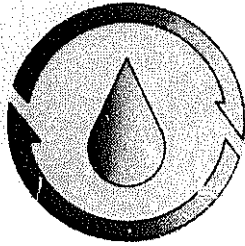

A Model Used Oil Recycling Act

William A. Irwin

Free

from:
Environmental Law Institute
Suite 620
1346 Connecticut Ave. NW
Washington, D.C. 20036

On January 1, 1978, California became the first state to pass an oil recycling act. Among its provisions is the requirement that stores selling oil must also accept used oil (though they do not have to pay for it). The law is similar to the model above.

— JB

Auto Enthusiast Directory

Many owners of old cars and trucks want to keep them running. This is especially true abroad. (How do you think that '39 Ford schoolbus to Tamazunchale keeps it up?) Parts for old cars are available used, of course, and many of them are available new: there are small manufacturers making them mostly for the foreign trade. This catalog tells who and where.

— JB

Autp Enthusiast Directory

\$3.95 postpaid

from:
Carl Hungness & Associates
Box 24508
Speedway, IN 46224

We're not inferring there are dis-reputable characters within the hobby of old cars, we guarantee it.

Mopeds

A number of people have sent me Moped brochures lately, so I'd better say a few words about 'em. There are many people who use Mopeds and like them. I don't. It seems to me that for all but heavy loads on hilly terrain, a good bicycle will do. The bicycle attitude seems healthier to me: do we have to motorize everything? Some say that a Moped is at its best: in the rain because you can keep a lot drier if your legs aren't flapping up and down. This may be true, but I consider it folly to mix any two wheeler with traffic in slippery weather. Mopeds don't mix with traffic very well anyway; they're too slow. You're always being hounded from behind. On the other hand, they're legal on bike trails, and in that case they are much too fast for the bicycles. (About 10 mph faster.) Yet the Moped's 25 mph speed is far from slow and safe if you hit something or lose control. Even in a car, a 25 mph hit can be lethal. (Actually pedalling a Moped is strictly for Godzilla.) My opinion, based on many miles on both Moped and motorcycle is that there are few things a Moped can do that a good small motorcycle (not scooter) can't do safer, sturdier, and with a wider range of usefulness. By small motorcycle, I mean a top speed of at least 60 mph. Personally, I vote for a good small car with a bicycle ready in the trunk.

— JB

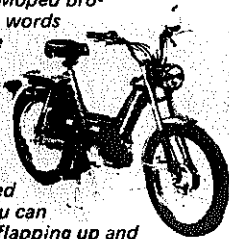

EcoDog

(Full size)

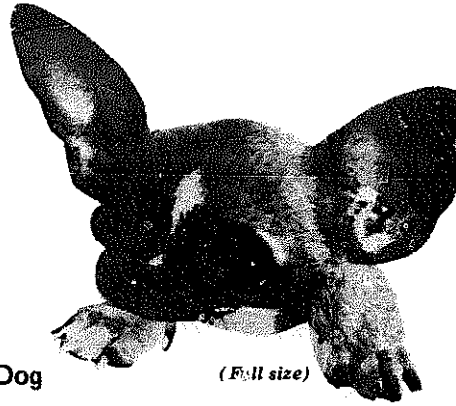

Dear CQ

We thought we'd let you know that you are not the only ones interested in Ecology! We here at EcoDog have noted the trend towards smaller, less environmentally degrading, motor homes, and have responded with a smaller Chihuahua. Only 2 1/2" long full grown, it's the perfect match for your Mini-Winnie! (Negotiations are under way to have them included as standard equipment.) The 168 decibel bark in the 15-18000 Hz range should satisfy even the most discriminating fancier of small canines, while the insignificant appetite will aid in conserving valuable resources. A guard-dog version is a badger cross, and though slightly larger at 4"x4" it is only 1 inch tall, making it an ideal watchdog for toolchest drawers containing valuable wrenches. To increase efficiency and to reduce weight (got to remember gas mileage, Ha, Ha) these dogs have only three teeth, which is all most Chihuahuas use to bite with anyway. Both versions can be equipped with exhaust gas recirculators which add but another 1/2 inch to their length and reduce emissions to a small "poot" of septic dust every 24 hours.

Let us know if you'd like a review demonstrator! We'd be glad to furnish you with one at dealer's cost (\$367.00) as our way of helping us environmentalists to stick together.

Ecologically yours

Hernando Schwartz
Avenida de los Brujos
Ninguna, TX 00100

Economy Driving

Most books making claims of this sort merely tell you not to jab the gas pedal so hard. This one, which is certainly the best we've seen, covers virtually every money-eating aspect of owning a car. Buying it in the first place is included. With the Average American Car costing its owner about 18 cents a mile to run these days (!) every little thing counts. The book is exceptionally well detailed and illustrated, and covers just about every little thing you could think of. The cover immodestly claims that you'll save the cost of the book in a week. You probably will, plus a lot more.

— JB

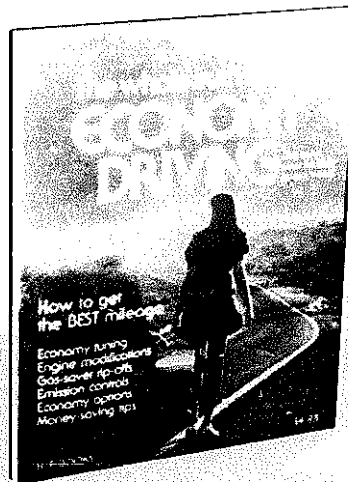

The Whole Truth About Economy Driving

Doug Roe
1975; 174pp.

\$4.95 postpaid

from:
H.P. Books
Box 5367
Tucson, AZ 85703
or Whole Earth

Homestead Bicycle Technology

BY JIM BURGEL

1) Railroad bicycle. Designed and built several seasons ago by my brother and his wife for extended trips through the Michigan country side (Bill & Linda Burgel). The idea grew out of a romantic obsession with railroads. Freight hopping/camping trips to northern Lake Michigan beaches led to tinkering with bicycle-powered railway transport. The US of A is crisscrossed with thousands of miles of abandoned railway track. Why not cruise these back routes?

A) Construction notes: *Tandem frame* assembled from scrapped bicycle frames. Suspension members constructed from light weight conduit welded together. *Wheels* fashioned from old bicycle rims bolted to 3 1/2" wide galvanized steel band. Rubber (a padded ride?) glued onto band to dampen vibration and noise. Welded flange wire bolted onto wheel proper. Wheel base width: 56 1/2" standard American railway gauge. These wheels as described and shown represent any shortcoming or pitfall that could be attributable to this present design. Brainstormed alternatives: 1) the use of two bicycle rims per wheel and galvanized band width increased to 5"; 2) the use of junked motorcycle wheel rims with 5" band and welded flange bead.

Gearing is standard 5-speed with a 14-28 rear cluster. The single front chainwheel sprocket attaches to the 40T (smaller diameter) rear chainwheel. The rear main chainwheel (52T) is attached to the standard 14-28 freewheel cluster. This rear freewheel cluster is mounted on a 1" diameter cold rolled scrap steel rod held in four places by four pillow block mounted roller bearings: two at frame members and two at outer suspension points.

Braking: One single caliber-type brake added to front wheel [not shown in photos]. Foot actuated.

Bell: procured from a boat at Woods Hole, MA.

B) Experience: The railroad bicycle as shown took three weeks to build, most time devoted towards material procurement (as always) Another 1 1/2 weeks for trials before loading up gear for a northern trip. Sleeping bags, tent and other provisions lashed on before leaving for an autumnal color tour. Left from SW Michigan area heading for Traverse City. Many sites and varied experiences along the way. Almost everyone asks: "What do you do when a train comes?" Answer: "Stop, pick up the bike and get off the track." With the deafening silence of rural bicycle travel, one can hear trains far off before any danger presents itself. The trick is not to get hung up on a long trestle near a busy yard. Close calls could be the result. Be careful.



Cruising the deserted railways in S.W. Michigan

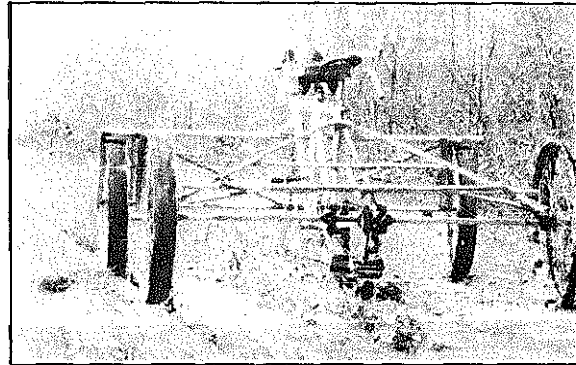

Rear view of bicycle: constructed from lightweight welded conduit. Gearing: 5 speed.

Other incidences: While rolling through Reed City, Michigan one bright, crisp October morn - the entourage was stopped at a railroad crossing by a local policeman: "Well, I do say that looks mighty ILLEGAL," and before a reply could be offered, continued with: "Mind if I had a ride?" Ah--!

C) Conclusions: If railroads and/or bicycles are your bent, give it a try, keeping safety utmost in your mind. Junked bicycles are to be found everywhere with parts and repairs easily obtainable along the way if needs be. Happy cruising!

1) Bicycle Wheat Grinders/Adaptable Power Train. Described below are two successful, working wheat grinders with the latter flywheel arrangement adaptable for a number of homestead tasks: wheat gleaners, pumps, churns, generators, corn shellers, etc., constructed by Jim Burgel.



Stripped bicycle wheat grinder. Wheat hopper shown feeding into attrition mill (Corona in this case).

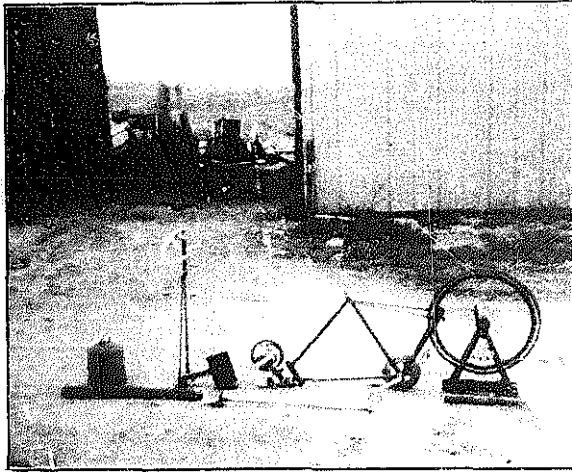

Bicycle wheat grinder: exploded view before assembly

A) Bicycle Wheat Grinder Prototype I: need grew out of bread rationing steps taken in light of unwanted/tiring hand grinding task of standard Corona mill.

1) **Construction materials:** Scrap bicycle frames, pipe lengths, timber scraps, chicken waterer (wheat hopper) and Corona mill. 8" sprocket attached to mill shaft by brazing on make-shift piece to gear, then attaching to triangular tapered Corona mill shaft. By finding old mill handles in the junk yard, one can cut off the end — the triangular taper piece and braze to sprocket, thus assuring a snug fit. A steel plate is brazed to grinder base to increase stability.

2) **Experiences/results:** Appetites swelled with increased "exercise" and bread availability. No trouble with chain nor grinder slippage after one week of bugs. Wheat/flour batch is run through twice to achieve adequate flour consistency. Grinder arrangement has been in use one year (Oct. '74 '75) and still going strong.

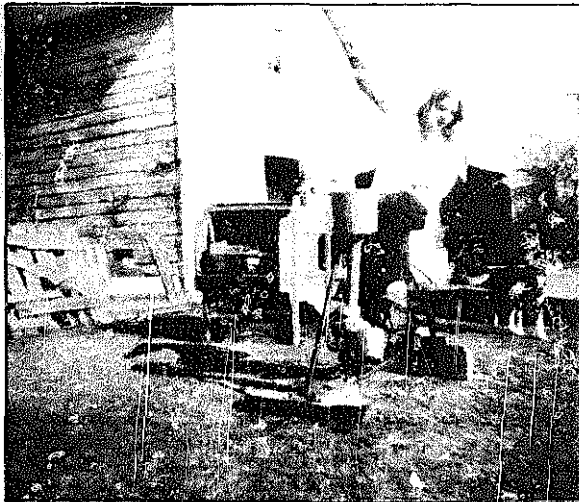

Prototype I. Note wheat cleaner in background, and lack of floor pan underneath funnel.

3) **Conclusions:** Successful operation with the following improvements to be made: a) inefficient position of human body during grinding caused by layout of handle bars, seat and pedals. Remedy: install heightened saddle, dropped handlebars and toe clips on pedals. b) Jerking of pedal action due to dead spots on the crank arm's throw. Remedy: flywheel.

B) Bicycle Wheat Grinder/Flywheel Phase II of Lumpy Gravy Incorporating Design Changes and Ideas learned from Prototype I. Similar grinder mount, wheat hopper and forward placement of assembly. Changes included: dropped handle bars, narrow saddle, toe clip pedals and flywheel.

1) **Construction: Flywheel arrangement:** When one is engaged in a pleasant bicycle ride, the mass of the rider is the flywheel. His/her weight sustains the momentum of bicycle travel. During stationary pedal operations, this momentum is lost; thus, the incorporation of a flywheel to smooth out the jerkiness incurred when pedalling a bucket of wheat into flour.

Double chainwheel used: Inner (38T) sprocket aligned with forward mounted grinder & gear. The outer ring of chain wheel accepts a chain which runs back to the flywheel's sprocket. Rear sprocket (on flywheel) and hub *must* be welded or otherwise secured else the flywheel will freewheel, negating any useful work.

Flywheel is an old 24" balloon tire filled with water/anti-freeze solution designed to get the greatest amount of weight inexpensively to the outer circumference of the flywheel. To fill tire with water and anti-freeze solution, an additional valve and stem must be added. It is affixed opposite the present valve to vent air as tire fills with water. (See diagram)

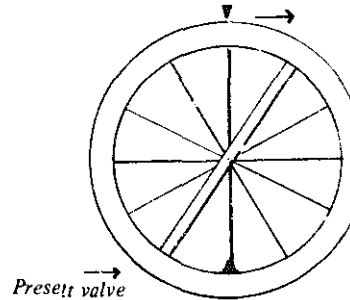

Pre-set valve

Additional valve: made by removing tube, cutting and glueing new valve (remove inner seam). Check for leaks. Punch small hole at top of tire for valve insertion. Reassemble, fill water at original valve; air will vent out at top valve. Replace cap when filled.

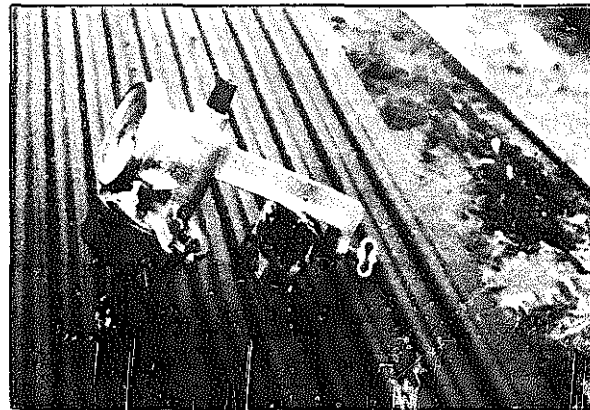

Quaker City mill showing steel plate brazed onto cast-iron grinder base to extend stability and support. Shown resting on trailer plate coil.

Flywheel arrangement is suspended off ground by twin angle iron brackets mounted to a wood base.

2) **Experience:** Good. Had several days of bugs before everything settled down and "felt right." Once the flywheel is put in motion, the jerky grinding action smooths out. Better rider angle for longer and more efficient periods of work. Any inquiries: please include a self-addressed, stamped envelope.

—Jim Burgel
331 E. Kinseley
Ann Arbor, MI 48104 ■

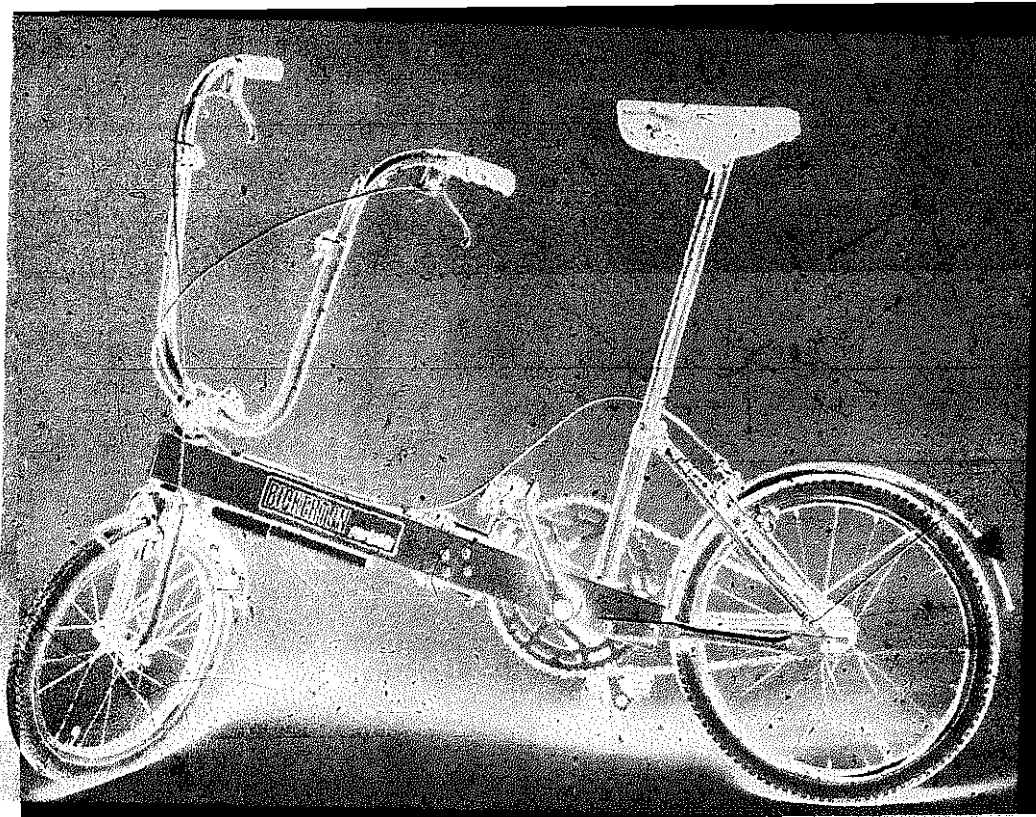

Bickerton Bicycle revisited

That most portable of the portable bikes (we remarked on it in Summer '75 CQ) looked good enough to buy, so we did, and we're glad. Actual city use shows that it really can solve the problems of theft (wad it up and take it in with you) and portability. On public transportation you stuff it into the canvas bag supplied and the conductor will never know it's there. It's light enough at 18 lbs. to stow in the overhead luggage racks in buses! In your car, just flip it into the trunk. Yes, even in a Honda.

The folding-unfolding ritual, which takes about 30 seconds with practice, is a rather fiddly and undignified procedure. The riding, however, is beautiful. The little guy is unusually resilient as it eels its way over bumps, and the super-high (3-speed) gearing lets you fly down the road with the effortless ease of a good 10-speed. Mr. Bickerton's background as an aircraft designer shows in the all-aluminium construction which seems sturdy and clever though "not for apes" as he says. Nice job.

— JB

Bickerton Portable Bicycle U.S.

soon to be available in
for about
\$325.00

Inquire from:
Mr. R.S. Oakes,
Managing Director
Vulcan Ltd.
Moorsom Street
Birmingham B6 4NX
England

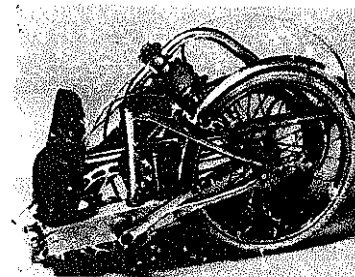

Bicycling Science

The human being used as an engine may not be the way you look at a bicycle, but that's how nature looks at it. This exceptional book analyzes, compares and judges the measurable aspects of people-power and the bicycle being ridden. Did you know that a loosely flapping shirt can add 30% to your air drag?; that the radical designs featuring a rider low down with a backrest aren't as efficient as traditional frames?; that until a grade is 15% you use less energy riding up than pushing the bike? The authors are engineers and have performed exhaustive tests to back their graphs and conclusions. Happily, they haven't hidden the findings in a mass of jargon. The chapter on bicycle physics will get most readers to a useful level of understanding. The chapter on people-powered devices other than bicycles is fascinating; there's even a lawnmower!

Sharp editing and careful research have made this book expensive, but it's likely worth it to those bicyclists wishing

to know what they are talking about. It's sure to stir controversy, and equally sure to result in better bicycles.

— JB

Bicycling Science
(Ergonomics and Mechanics)
Frank Rowland Whitt &
David Gordon Wilson
1974; 247pp.

\$12.95 postpaid
from:
MIT Press
28 Carleton Street
Cambridge, MA 02142
or Whole Earth



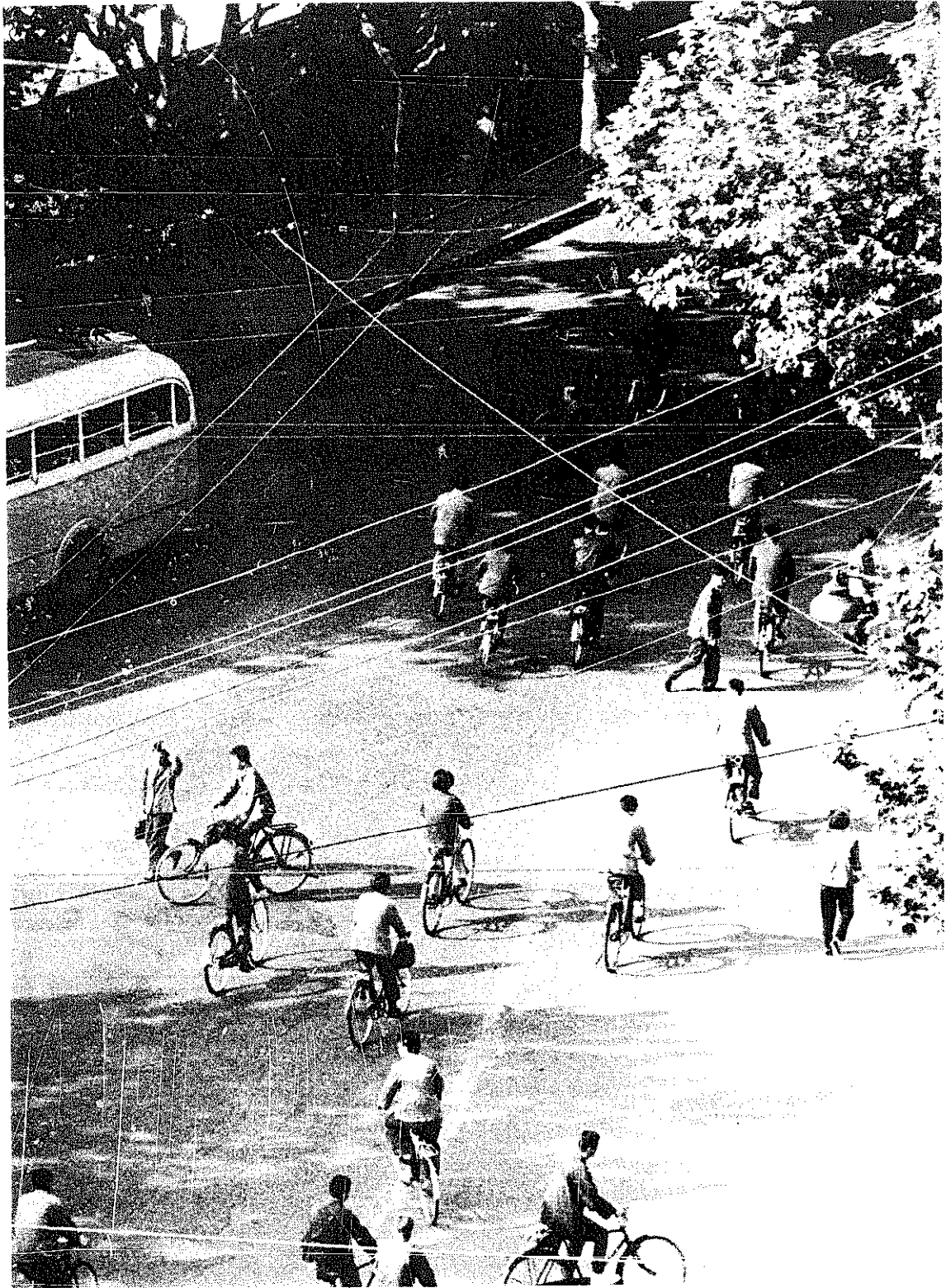

Orrulle Schell

Bicycles in Shanghai Street

There are no private cars in China.

Geothermal Technoecosystems and Water Cycles in Arid Lands

Geothermal energy certainly is one of the important fields under development these days, but what makes this paper interesting is more than its academic competence. The author is a specialist with a generalist's wide vision. He introduces us to the concept of "technoecology" and presents his geothermal analysis in those terms. The result is a report quite unlike anything I've ever read before. It's worth checking out just for the viewpoint.

— JB

Geothermal Technoecosystems and Water Cycles in Add Lands

Christopher Duffield
1976; 202 pp.

\$10.00 postpaid

from:

University Of Arizona
Office Of Arid Lands Studies
845 N. Park Ave.
Tucson, AZ 85719

"Technoecology" can probably be defined in as many ways as "ecology" is. Perhaps it is least limiting to define "technoecology" as the study of large, complex industrial systems by analogy to biological systems, particularly at the ecosystem level. Technoecology, though, is not solely a passive study, for the technoecosystem is under collective human control, and our changing perception of it will alter our management of it. Thus technoecology also involves active evolution of macroscale technoecosystem strategies.

SIDECYCLE

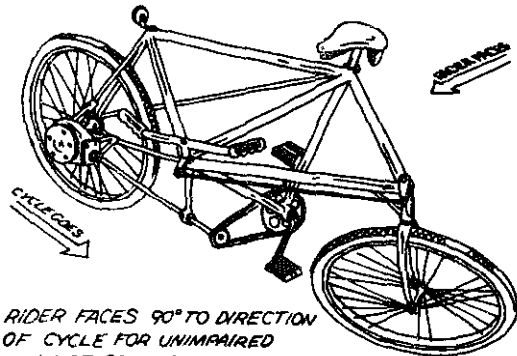

RIDER FACES 90° TO DIRECTION
OF CYCLE FOR UNIMPAIRED
VIEW OF SCENERY

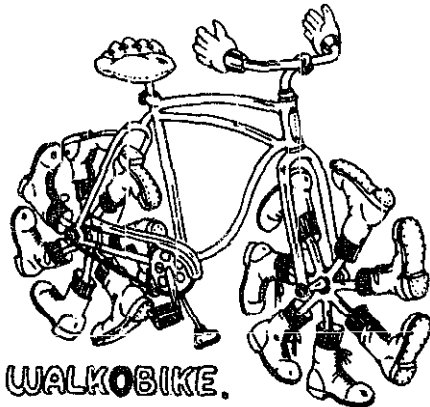

Philip Garner

Coles' Power Models

Here's an interesting catalog of model steam engines and parts.

— JB [Suggested by Chris Ward, Folsom Prison]

Coles' Power Models

Catalog No. 22

\$2.25 postpaid

from:

Coles' Power Models
Box 788
Ventura, CA 93001

"Vesuvius," a steam powered bicycle. (Bore: 1-3/8", stroke: 1-1/2", boiler fuel: gasoline, working pressure: 100 psi, top speed: 16 mph.) This steam bicycle power unit may be attached to any bicycle or tri-wheeler with a 24-27 wheel diameter. No modification required. The front wheel mounting allows the rider to view the pulsating engine and keep an eye on the water level. The unit does not interfere with pedals, which may be used when extra power is needed. \$70.00 25 page folder: plans, parts lists, instructions, history. \$18.00.

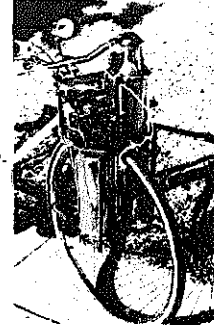

Day-Land steam engines

In case any of you would like to make a 20 horsepower steam engine, Mr. Moore sells plans and castings ready to machine. It's an old proven design similar to the one used in Stanley Steamer automobiles, but it has been updated with more modern materials and details. He also sent us the following steam power source list. Lotsa people talkin' about it but few doin' it. Now there's no excuse.

— JB

Day-Land Steam Engine

Catalog of castings, plans, and brochure.

Send self-addressed, stamped envelope to:

C. William Moore, ME
Box 174
Pleasanton, CA 94566

Cole's Power Models

Box 788
Ventura, CA 93002

Model engines, boilers, etc.

Light Steam Power

Kirk Michael
Isle of Man, U.K.

Engine castings, plans for
engines, boilers, and
books on steam

Paul R. Breisch

187 Ridge Pike
Royersford, PA 19468

Model engine, pump,
etc., castings

William T. Blake

Box 54
Canandaigua, NY 14424

Model supplies

Live Steam

... Basically oriented to building working replicas of steam locomotives and traction engines (steam tractors) due to the technical background of many of Live Steam's readers, the steam technology remains alive. Coupled with more modern materials for bearings and sealants, reliability engineering, and electronic control, more efficient prime movers could be developed to utilize coal or wood. With GM and GE in control of the loco industry, GM in control of the bus and much of the truck industry, they won't change. As fuel oil goes up, the field will be open.

— J. Garwood

Live Steam

William C. Fitt, Ed.

\$14/yr

\$16/Foreign
& Canada

from:

Live Steam
P.O. Box 581
Traverse City, MI 49684



Energy: The Solar-Hydrogen Alternative

If you wish to attend to where the possibilities of hydrogen are these days, this book will give you all but the very latest developments. There's a long way to go yet. This is a very scholarly presentation. At your library.

- JB

Energy: The Solar-Hydrogen Alternative

J. O'M. Bockris
1976; 365pp.

\$27.50 postpaid

from:
Halsted Press
John Wiley & Sons, Inc.
One Wiley Drive
Somerset, NJ 08873
or Whole Earth

PROPERTIES OF HYDROGEN WHICH MAKE IT MORE DANGEROUS TO HANDLE THAN NATURAL GAS

The reference substances in discussions of hydrogen safety are CH_4 and C_2H_6 .

(1) The inflammability limits of hydrogen with oxygen are wider. Thus, hydrogen combines explosively with oxygen when the limits are between 4 and 75% hydrogen. Methane combines explosively with oxygen when the limits are between 5 and 15%.

(2) The ignition energy is lower, hence an explosion is more easily set off.

(3) Leakage is easier. The escape velocity of hydrogen is three times that of methane upon a volume basis. If hydrogen escapes to a closed space, it will exceed the explosion limit at 4% by volume in 0.26 of the time which natural gas needs to exceed its 5% threshold. On the upper side, it takes 1.6 times longer for hydrogen to pass the upper limit of 75% than for methane to pass its upper limit of 15%.

(4) The propagation velocity of a flame is 6 to 100 times more (dependent upon the amount of air present) for hydrogen than for methane.

(5) A hydrogen-oxygen flame is invisible.

(6) There is no Joule-Thompson cooling on expansion of hydrogen at normal temperature. When hydrogen escapes from an orifice, therefore, it gets hotter and may spontaneously ignite.

WAYS IN WHICH HYDROGEN IS LESS DANGEROUS THAN NATURAL GAS

There is a better side to hydrogen, in respect of safety, which reduces the weight of some of the negative points made above.

(1) The escape velocity: On a volume basis, the escape velocity of hydrogen is greater than that of methane. However, because hydrogen contains per unit volume three times less energy than does methane, escaping hydrogen brings with it only 0.93 as much energy per unit time as does methane.

(2) The energy of a hydrogen-oxygen explosion, which occurs at 1% by volume of a hydrogen-oxygen mixture, is one-quarter that of the corresponding methane mixture when it reaches its threshold at 5%. A hydrogen-oxygen explosion is hence less violent than that of a hydrogen-methane one.

(3) When hydrogen is released from a container into air, it rises, not only because it diffuses faster than methane, but because of its smaller density.

Propane and petrol are heavier than air. Their vapours remain near the site at which they are accidentally vented. In practice, then, the likelihood of an explosion after an accidental venting of hydrogen into an open space is less than for propane. The hydrogen dissipates itself much more quickly than petroleum.

Methanol & Other Ways Around the Gas Pump

The possibility of making auto fuel from agricultural products, and why this technology is not being sufficiently supported, is explored in some detail. If you haven't read up on this subject, this will get you on the way. If you need detailed technical expertise, you'll need more than is offered here.

- JB

Methanol & Other Ways Around the Gas Pump

John Ware Lincoln
1976; 134pp.

\$4.95 postpaid

from:
Garden Way Publishing
Charlotte, VT 05445
or Whole Earth

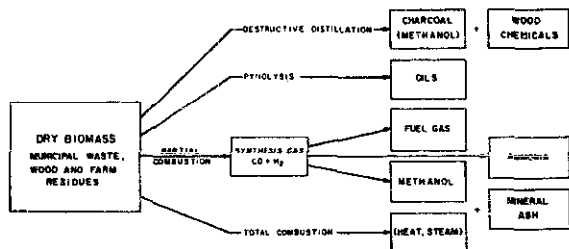
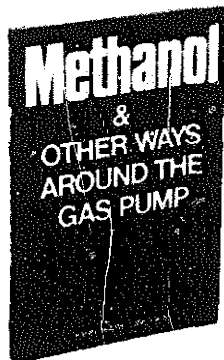

Methanol is one of many products obtainable from dry biomass.

Methanol: Its Synthesis, Use As a Fuel, Economics, and Hazards

There's a lot of loose talk these days concerning the use of Methanol as a substitute for gasoline. Interest was added earlier this year when Brazil officially announced a large scale program to develop methanol as a vehicle fuel. There have been many scholarly papers in addition to the rumours, but they have been difficult to track down and compare in a useful way. Until now. If your interest is in Methanol, you should check this comprehensive bringing-together of major papers.

- JB

Methanol: Its Synthesis,

Use as a Fuel, Economics,

and Hazards
(Order No. NP-21727)
David LeRoy Hagen
1976; 220 pp.

\$7.50 postpaid

from:
NTIS
5285 Port Royal Rd.
Springfield, VA 22161

Methanol has many advantages over gasoline with regards to pollution. It burns at a lower temperature. This reduces the nitrogen oxides formed during combustion in air because the reactions and equilibria are exponentially dependent on the temperature. Methanol can be mixed with water and burned at lean stoichiometric air fuel ratios to further reduce the nitrogen oxides formed far below that possible with gasoline.

Noticeable corrosion has occurred with methanol in contact with terneplated (lead plated) fuel tanks, magnesium, copper, lead, zinc and aluminum parts, and some synthetic gaskets. These need to be avoided or protected. The water present in conventional petroleum handling facilities would have to be removed, as this would cause dilution, contamination and rust problems. Otherwise methanol can be stored in regular steel tanks.

The Pegasus Unit

During World War 2 many Europeans circumvented the fuel shortage by equipping their vehicles with charcoal devices that made a crude gas. They were not very good devices and caused plenty of trouble with fire, asphyxiation, and mechanical failure, but the people did drive. A professor and some students at Evergreen State College have been working on a modern version which hopefully will burn garbage or other waste materials such as the wood scraps that are now burnt in those "Tipi" furnaces at sawmills. Their investigations so far have resulted in this book, which offers a documented history and theory of the device. Lots of pictures and diagrams explain the principles and technical details. I personally doubt if it's a practical idea, but Pegasus is certainly interesting. (A complete set of engineering drawings and operating instructions is available to allow the construction of a Pegasus unit suitable for operation with present gasoline and diesel engines and may be ordered from: Pegasus, Inc., P.O. Box 121, Olympia, WA 98507; \$22.50.)

- JB

The Pegasus Unit (The Lost Art of Driving Without Gasoline)

Neils A. Skov and
Mark L. Papworth
1974; 133 pp.

\$7.30 postpaid

from:

Bookstore
The Evergreen
State College
Olympia, WA 98505
or Whole Earth

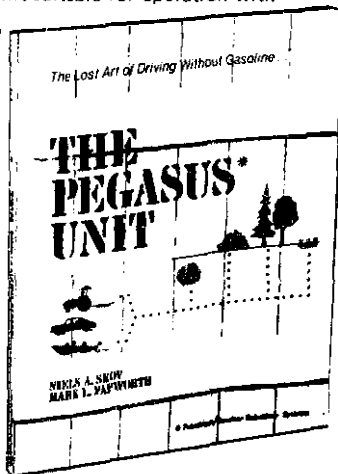

Pegasus revisited

I've never pretended to have read everything on a subject before making an evaluation for the CQ. Sometimes we print stuff uncritically just to show that people are thinking along promising lines. That occasionally will get a reviewer into hot water (or worse, in this case). Here's two barrels of 12 gauge Magnum Goose Loads, right in the heart:

- JB

Dear J.:

I would like to comment upon your evaluation of the book Pegasus in the fall issue of CQ, inform you of some of the overwhelming mass of information which has been generated concerning gas producers or generators, and by my short critique of Pegasus and the inclusion of a bibliography which I compiled to tell you something of my approach to evaluating literature.

Pegasus is but one step above being shit, and that only because it might teach some people something in spite of itself and has less than an outrageous price. I judge it to be perhaps even lower than the typical Mother Earth/Rodale technical schlock. Even to a person untutored in the history of design and use of gas producers a few items in the book might seem immediately suspicious. What good use is served by erroneously claiming that a word should be coined to describe gas producers? Such devices are commonly referred to and indexed as gas producers, gas generators, and the product as generator or producer gas in literature which extends past the turn of the century. The Swedish Royal Academy of Engineers hefty book describing their wartime experience with gas producers is aptly titled Gengas, from generator gas.

Next, beware the diagrams and sketches in the book. You will note different styles among them and an occasional foreign word (if I remember correctly, I wouldn't walk to the next room to look at it unless it was to point out how to

produce a shuck, and as it is the nearest copy is 20 miles away), leading you to believe that the illustrations were stolen without credit. As your experience with the literature increases you will indeed soon see the originals. By God, it's a loathsome practice to use others' materials without credit because it denies the producer of the original proper due, places the reproducer in an improper light, and fails to give the reader proper and sufficient information about the background and history of the topic. To the eager and perceptive reader such information is a blessing in tracing the development and changes in a technical (or literary or philosophical) scheme.

I remember the text as being poor, unclear, and overstated in its own right, let alone in comparison to most of the rest of the literature. And concluding the masterful book is a paltry, flawed, inaccurate, anemic, and bullshit bibliography.

If you would like to see some of the real stuff allow me to give you a few references.

A bib. - Try U.S. Dept. Agr., Agricultural Research Administration. Bureau of Agricultural and Industrial chemistry paper AIC-103, Bibliography on Construction, Design, Economics, performance, and Theory of Portable and Small Stationary Gas Producers, Oct. 1946. 96 pages. It is international, multilingual, and annotated. The date of publication denies it coverage of the postwar retrospective analysis of the gas producers.

Or try the November 5, 1942 special number of the Automobile Engineer. It is a good mid-war introduction to gas producer use in a large variety of vehicles. 45 pages.

If you can handle Swedish you should try to find a copy of Gengas. It is one hell of an impressive evaluation of their experiences with predominantly wood- or charcoal-fired producers during WW II; something around 400 pages with illustrations and diagrams, charts, figures.

And if anyone really wants to get into it they should start looking at WW II era Forestry Abstracts and Engineering Index. There is Australian, Canadian, British, French, German, Swedish, Finnish and other literature up the kazoo.

Right now the whole thing looks like a dream by someone who has been smoking back issues of Alternative Sources of Energy. I guess that the price of fuels for transport would have to triple or quadruple before we could think about using producers for transport purposes.

John Mitchel was once preparing to do an issue of Alternative Sources of Energy devoted to wood, with a hefty section on gas producers. I don't know what became of the project.

The enclosed bibliography: Everything is pretty clear concerning how I approached the subject, where I looked, what I came up with, and annotations of something like 35% of the entries. The availability is unclear; send \$2.00 (no money making there) in check or money order to Dept. Agricultural Engineering, University of Minnesota, St. Paul, MN 55108. Don't tempt Jim Moore by making them payable to him.

I hope that you find my comments and the bib. of interest and use. I'm looking forward to future copies of CQ.

Sincerely,
Gregg Shaddock
Eagan, Minnesota

Mr. Shaddock's book is listed below. It's just what it says in the title. The abstracts make it particularly useful, and it should be on top of the book pile of any serious biogas experimenter.

- JB

The Anaerobic Digestion of Livestock Wastes to Produce Methane

(1946-June 1975: A Bibliography with Abstracts)
Gregg Shaddock and James A. Moore
1975; 103pp.

\$2.00 postpaid

from:

James A. Moore
Dept. of Agricultural Engineering
University of Minnesota
St. Paul, MN 55108

Producer Gas from Davis

Professor Brian Horsfield and Dr. R.O. Williams of University of California, Davis have been working hard to develop the hardware needed to convert crop residues into flammable gas, hence useful power. The crop residues are not converted into methane in a digester. Instead, they are burned in a controlled atmosphere and converted into what is called "producer gas" which is rather like Propane in its potential uses. These papers explain what is probably the state of the art.

-JB

General Conclusions

- 1) In a down-draught gas producer, the grate/firebox configuration is of paramount importance in providing for the continuous supply of good quality gas.
- 2) Different designs of grate/firebox are likely to be used with different fuels.
- 3) Conversion efficiencies in excess of 70% can be readily achieved and 80% is possible with an ideally sized material.
- 4) As the size of the fuel decreases, gasification in down-draught mode becomes increasingly more difficult.
- 5) Mixing fuels of different sizes could alleviate problems caused by the high resistance to air/gas flow which occur with granular fuels.

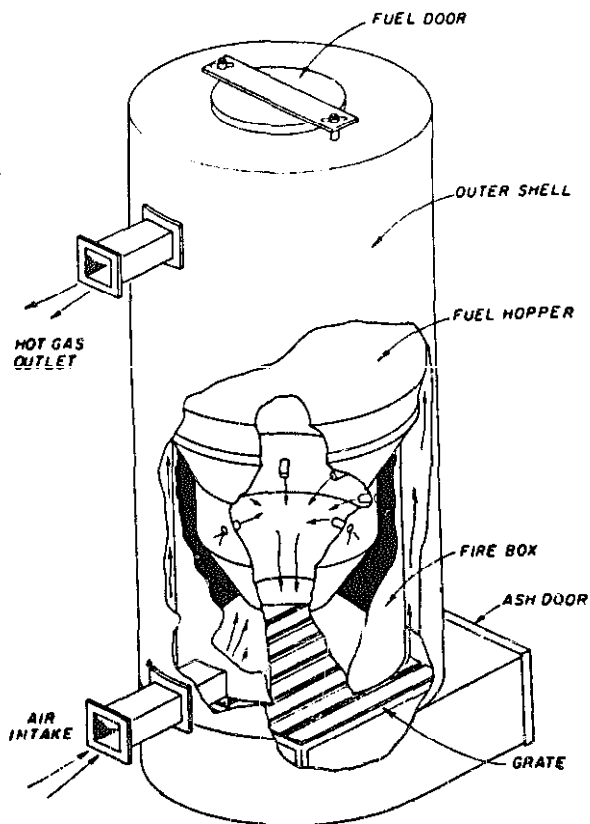

Experiment down-draught gas producer using crop residue as fuel

A 10 KW signal corps motor/generator was operated successfully for periods up to 8 hours on producer gas. A 3-way valve, mounted between the carburetor and induction manifold, enabled the engine to be run either on gasoline or producer gas.

It was apparent from the limited experimentation described above and from an extensive literature survey (1) that no serious problems were likely to be encountered when running a gasoline engine on producer gas. A reduction in output power relative to that normally obtained with gasoline, was to be expected; however, output power could have been

increased by installing a turbo charger and/or by increasing the engine's compression ratio.

GASIFICATION PUBLICATIONS

1. University of California, Davis, Department of Agricultural Engineering. 1977. *Research Report — Agricultural Residues as an Alternative Source of Energy for the Pacific Gas and Electric Company*. 279 pp. \$15.00. Economic and technical feasibility study of the potential for utilizing agricultural and forest residues as fuel for California Utility Power Companies, especially PG&E. Discusses collection systems, transportation systems, and energy conversion systems for such residues as field crop residues, fruit and nut tree prunings, animal manures, and forest residues.
2. Horsfield, Brian, Howard Doster and Robert Peart. 1976. *Drying Energy from Corn Cobs: A Total System*. 25 pp. \$1.00. Describes and analyzes a total system for using the energy in corn cobs for drying corn cobs. Sketches of seven low-BTU Gasifiers are presented.
3. Horsfield, Brian and R.O. Williams. 1976. *Energy for Agriculture and the Gasification of Crop Residues*. 20 pp. \$.85. Description and performance of the Laboratory Gas Producer model converting rice hulls, cotton gin trash, wood chips, walnut shells and corn cobs to low-BTU gas.
4. Williams, R.O. and Brian Horsfield. 1977. *Generation of Low-BTU Fuel Gas from Agricultural Residues and Experiments with a Laboratory Scale Gas Producer*. 28 pp. \$1.10. Detail description of a Laboratory Gas Producer and experiments primarily with nut shells to assess ash removal designs.
5. Williams, R.O. and John R. Goss. 1977. *An Assessment of the Gasification Characteristics of some Agricultural and Forest Industry Residues*. 25 pp. \$1.00. A follow-up report to Report No. 4. Discussing the gasification characteristics in more detail.
6. Horsfield, Brian. 1976. *Current European Activities in Gasification*. 7 pp. \$.35. Describes a visit by Dr. Horsfield in April 1976 to assess the development of gas producers in France, England and Sweden.
7. Goss, J.R. and R.O. Williams. 1977. *Walnut Shells: Replacement for Natural Gas?* (Published in *Chilton's Food Engineering Magazine* — September 1977 Issue) 5 pp. \$.35. A report on the Pilot Plant Gas Producer installed at Diamond/Sunsweet, Stockton, CA. Based on the Preliminary Report which is the next item.
8. Goss, J.R. and R.O. Williams. 1977. *Preliminary Report, To the State of California Energy Resources Conservation and Development Commission. On-Site Extraction of Low-BTU Gas from Agricultural Residues for the Replacement of Natural Gas in Agricultural Processing*. 28 pp. \$1.20. The preliminary report on the Pilot Plant Gas Producer at Diamond/Sunsweet, Stockton, California. Also, contains a brief history of gasification, cost analysis for Diamond/Sunsweet's gas and electric power needs and plans for other applications of the Pilot Plant Producer through December 1978.
9. Williams, R.O., John R. Goss, Brian C. Horsfield and Robert Hodam. 1977. *Steam Raising with Low-BTU Gas Generators and Potential for Other Applications*. 9 pp. \$.40. Similar to the preliminary report. Includes an introductory section on natural gas usage in California.
10. Goss, John R. 1977. *Experimental Pilot Plant Gas Producer for Walnut Shells*. 4 pp. \$.30. A brief description on the Pilot Plant Gas Producer as installed at Diamond/Sunsweet, Stockton, California.
11. Horsfield, Brian C. 1976. *Firms Involved with Gas Producers and Consultants Involved with Gas Producers*. 2 pp. \$.25. A listing with addresses.
12. Horsfield, Brian and R.O. Williams. 1976. *Technological and Economic Assessment of the Utilization of Rice Straw Residue from the California Sacramento Valley for On-Farm Power Generation*. 83 pp. \$2.75. A study of alternative uses for rice straw and collection methods. Limited discussion on gas producers as one of the possible utilization systems.

All of the above: \$24.55. Order by number. Add \$1.00 to each complete order for postage and handling. Make checks payable to Regents of the University of California.

Order from: University of California, Davis
University Extension Office
4455 Chemistry Annex
Davis, CA 95616

The great methane bubble

This is the kind of detailed skepticism we like to see accompanying our criticisms. (Another good one is Margaret Mead's remark that current American romanticism about China reminds her of the 30's, when we felt the same way about Russia.)

We mean by printing this no slight on John Fry's excellent methane book, or on Mother Earth News, a damned useful magazine. They had a go at these devices. That's more than we've done.

Furthermore, experiments are not for perfection, they're for learning. And learning requires acknowledging the distance from perfection. Hence the following.

- SB

DEAR Mr. J. BALDWIN,
SOFT TECHNOLOGY,
Whole Earth Epilogue,

Spring 1975

I'VE JUST FINISHED READING THE ALTERNATIVE ENERGY SOURCE SECTION IN THE EPILOGUE - SPECIFICALLY THE METHANE SECTION. I FOUND YOUR REMARKS ACCURATE & REFRESHINGLY FRANK AS COMPARED TO ALL THE GUNG-HO MOTHER EARTH NEWS ATTITUDE (among others). WELL, I'VE BEEN MORE THAN INTERESTED IN ANAEROBIC DIGESTION FOR THE PAST YEAR, HAVING HITCHIKED AROUND TO EXISTING FARM-SIZED (AND EXPERIMENTAL) DIGESTER SITES - THEY INCLUDE: L. JOHN FRY - SANTA BARBARA, Fry's 3 110 gal. DIGESTERS NEVER REALLY worked - YET UNDYINGLY PROMOTED THEM IN HIS \$12.00 BOOK: Methane Power Plants (The Practical Building of), RICHARD SHUTTLEWORTH (John 'Mother Earth News' Shuttleworth), DIGESTER IN RED KEY, INDIANA . . . THEIR DIGESTER COST: \$15,000.00 (can you believe that?) AND CONSUMED MORE UNITS OF ENERGY (BY KEEPING IT WARMED VIA ELECTRIC HEATING ELEMENT IN WATER BATH) than it PRODUCED IN METHANE FORM. Please make more accurate inquiries to the NET ENERGY GAIN OF A DIGESTER - I VISITED LES AUERBACH IN MADISON AROUND MAY 30th THIS PAST SPRING & HE WAS TENTATIVELY PLANNING ON BUILDING ANOTHER DIGESTER (STARTING AROUND NOW). YES, HIS booklet IS CONCISE FOR AN "EXPERIMENTAL SIZED" DIGESTER. Also, I visited The Rodale Press & a fellow named Alton Eliason (Northampton, Conn.) WHO HAVE BUILT 275 gal. Digesters.

All agreed upon basic principles - NONE OF THEM WORKED w/o A NET ENERGY LOSS! Only one produced gas! HOW CAN THESE THINGS EVER AMORTIZE THEMSELVES?

STILL, FEELING UNDAUNTED - I RETURNED TO MICHIGAN IN JUNE & BUILT A 275 gal. Digester TO GET THE BASICS DOWN & MY HANDS GOING IN THE RIGHT PLACES - THEN, EMBARKED UPON A 1,000 gal. digester designed for 10-15 cattle. I INCORPORATED DESIGN CHANGES ALL ALONG THE WAY WHERE I FELT OTHERS HAD MISSED: (SOLAR PANELS FOR ADDITIONAL HEAT SOURCE, 3 inches of Polyurethane insulation to minimize heat loss, an 18' x 15' GREENHOUSE - A 275 gal. TANK mounted on a chassis TO HAUL Digested sludge to the garden - A 1,000 gal. Floating gas storage tank) etc. etc. etc.

Now as I'm finishing up on this project - of my own financing (costs run between \$500-\$600 everything including welding supplies, greenhouse, etc. I have several things to ASK & ADDITIONAL COMMENTS TO MAKE -:

1) Any possibility of OBTAINING FUNDS MENTIONED on pages 752-753 of EPILOGUE? OR leads to write stor(ies) - articles on this project? How Does one go about it? Maybe OGF, ASE, or TMEN - Guess I'll write them.

2) Continue your pessimism towards Homestead sized Digesters FOR the Following Reason(s):

a) poor rate of return for amount of time/money & energy invested.

b) WHERE DOES REALLY METHANE ENERGY ORIGINATE? NO ONE (to my knowledge) HAS REALISTICALLY ASKED NOR ANSWERED THIS QUESTION. CATTLE/ LIVESTOCK Manure IS NOTHING MORE THAN UNUTILIZED CEREAL/grain ENERGY FROM THE sun/soil. BUT - WE MUST clearly ask & see HOW EFFICIENTLY DO LIVESTOCK TRANSFORM Animal PROTEIN FROM Grain/Cereal protein? Well - as aptly put in Diet For a Small Planet - IT TAKES 21 lbs. of Grain Protein to produce 1 lb. of Animal protein! The balance of which (in the form of MANURE) FINDS ITS WAY TO THE KITCHEN STOVE AFTER Anaerobically Decomposing IN A DIGESTER. VERY ENERGY INTENSIVE - PITFALL LIES OVER Western MAN'S INFATUATION OVER GADGETRY . . . I guess & Americans INSATIABLE DEMAND FOR MEAT.

Another Point -

IF YOU WISH TO PURSUE IT IN ANOTHER "Epilogue" or Co-Evolution Quarterly is: WHY A DIGESTER? THE MOST PIERCING/AWAKENING WAY OF STATING IT: ONCE CONDITIONS ARE RIPE FOR AN "Adequate sized Digester" (ABOUT 20,000 gal. & on up before any thought is given to lifting up a shovel or pipe wrench) - then - there should never be that condition in the first place . . . that is, are we going to deal with the symptoms or the root of faulty/inefficient energy cycles?

This line of logic all leads to several questions we must searchingly answer for our children's children:

1) Can we afford the "luxury" of poor energy transformers & try to rationalize the effort by building Digesters?

2) Once cattle are confined (which - incidentally is the biggest pain in the ass* with digesters - notice that everyone avoids this point in their quick-buck publications) - their confinement leads to a whole host of problems & diseases (foot rot, Flies - everything is exacerbated problem-wise the same as humans in high urban density population centers. It just doesn't make sense on a small scale.

3) Once you have enough cattle to supply A Digester to do something . . . you are now agribiz & must go big time to grow the energy (GRAIN) to feed the cattle to get the shit to fill your Digester. (All very Catch 22-ish.)

However - on a large scale (municipal) - where you have 10's of thousands of people flushing their toilets (with all that water!) to bring the solids down the line to a central Digester - All this manure will make a digester feasible in regards to stabilizing the volatile solids (raw shit) - this aspect is the most important in regard to digesters on a whole (nutrients broken down - ready for field application).

Let me rattle on for a bit on a case history of sewage treatment at the closest good-sized CITY: Kalamazoo, Michigan (pop. 1970: 110,000+) (Twice selected as an "All-American City")

In 1954, several sewage works engineers had the foresight & resourcefulness to plan, build & hire a company to build anaerobic digesters for their treatment plant. Fine. There were two 100,000 FT.³ (750,000 gal.) Anaerobic Digesters built & ran fine until the late 60's. The gas produced was burned in a heat exchanger and the hot water was then circulated w/i pipes throughout the walls & Floor of digester to keep sewage slop at optimum 95°F Temp. [THIS SYSTEM IS WHAT I modeled mine after - I used an old 'side arm heater' They use to use them here in old USA or in Europe, especially Spain - They call 'em "FLASH HEATERS" - HOT water then circulates through 48' of 1" pipe w/in Digester.]

Anyway - The Kalamazoo Digester gas was used to heat all the sewage works buildings, run the generators to produce power to run all the equipment plus have enough to burn off. A fine set-up till 1967 when the sewage works decided that fateful step of combining industrial, domestic, & pharmaceutical wastes in one big show - well, the town of Kalamazoo centers on is the UPJOHN CO. - makers of our vitamins & endless "miracle" drugs - So - good ole' UPJOHN IN 1967 - after putting in a line to the main

*The pain in the ass I'm referring to is manure collection & not the actual cattle confining.

sewage pipe – began pumping their pharmaceutical wastes down the line – AND WHAM! WITHIN HOURS, The Kalamazoo sewage works had 1,500,000 gal. of putrefying/messy/non-digesting sewage slop. The Reason? As UPJOHNS skimmed off the foam & dumped residues from their ANTI-BIOTIC Fermentation tanks & vats, it was a matter of minutes/hours before all the sensitive, 2nd stage – “Methane Fermenters” were knocked out of production.

So ended the presence of anaerobic Digestion in Kalamazoo.

Continuing – to alleviate this problem – Kalamazoo sewage works trucked/pumped all this putrefying shit out to LAGOONS to Aerobically decompose the ‘problem.’ Needless to say – the population went crazy & effigies burned etc. at the horrendous stench. (All this to buy time to build the “ultimate in sewage disposal”)

SO – after about 2 years – the Zimpro units were finished to a fantastic tune of sewage costs. (with the Digesters, price/cost per ton of sewage disposal was \$4.50/ton - FIXED COST TOO – since power companies couldn’t regulate SHIT – He! NOW, WITH Zimpro – the price/cost per ton of sewage treatment is \$25.00+/ton and is still rising [due to increased fossil fuel costs].

Little Back History – Zimpro is short for THE “Zimmerman Process” developed/perfected by a sewage works engineer in the early 60’s. The Zimpro process is basically known as “WET-AIR OXIDATION” And consists quite simply of compressing the incoming solids (they’ve Already been

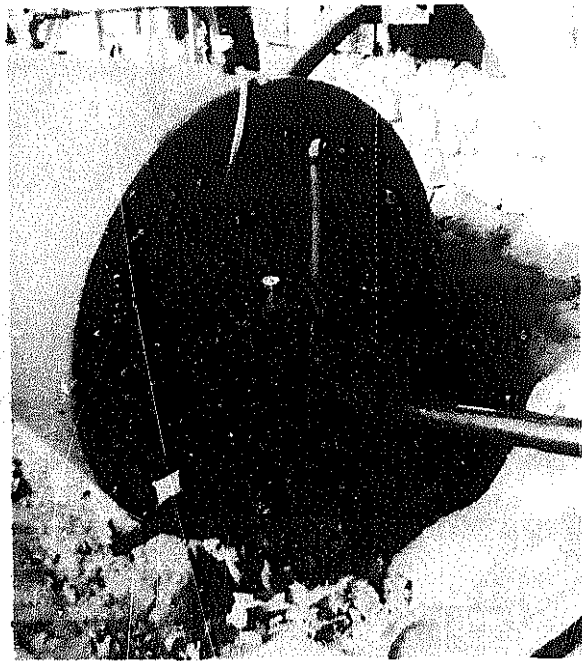

Jim Burgel's digester. He doesn't say how well it works.

- EAST END of Digester (1,000 gal. 130+ ft³)
- Flexible, spiraling tube is level indicator before final hook up.
 - Gate valve is for supernatant sampling & getting greenhouse sludge for inside plants.
 - CH^A draw off at extreme upper left.
 - 4" pipe leading off to the right is for slurry/sludge removal to sludge “honey wagon” buggy.
 - Access hatch for inside construction & manual clean – if necessary.
 - At bottom of photo: top 1½-inch pipe comes from side arm heater at the extreme right. CH^A is used intermittently to heat water (connection system) & circulate inside digester. Lower 1½" pipe is the cold (cooled) return.

dewatered) And heating them up – then running them through a “REACTOR” or “cooking area” which – quite literally, cooks the shit out of excrement.

I.E. At the HIGH Temps. of 350°F+ the nutrients & organic matter oxidize (Flamelessly) and render them sterile. IT KILLS THEM, AFTER COOLING DOWN A BIT, THE HOT SHIT IS RUN THROUGH A Blower/VACUUM Dip-Roller type arrangement – The result being a DRIED inert cake – looking, feeling, smelling, & having as much nutrient value as:

WET CARDBOARD.

THIS CAKE IS THEN TRUCKED OUT TO LANDFILL. The Zimpro Process is BURNING OUR FERTILIZING nutrients!!! How Long can we expect to go on living on this planet if we burn our shit wastefully and take oodles of fossil fuels to do it? The Zimpro process is a patent/trademark of: ZIMPRO, Inc. Address: Rothschild, Wisconsin. [Send for info. it'll blow your mind.] These folks are a division of Sterling Drug, Inc.

THIS IS WHERE SEWAGE Treatment in Kalamazoo stands today. Disheartening.

REVIEWING THIS LETTER . . . SEEMS AS THOUGH SOME BITTERNESS comes THROUGH IN PLACES. THE MAIN INTENT IS TO PUNCTURE some Holes IN THE EXAGGERATIONS & HUNKY-DORINESS OF THE SUPER-OUTPUT OF ANAEROBIC Digesters, and to produce more reliable information.

TRUE, IN THE EARLY STAGES OF DIGESTERS – THERE WAS A LOT OF KNOWLEDGE IN THE FORM OF PRACTICAL RESEARCH TO BE ACCOMPLISHED IN REGARDS TO Home/Homestead – small, decentralized SET-UPS.

However, after visiting existing Digester sites in the US of A (plus many abandoned BATCH-TYPE Digesters in So. France) And reading the available, current literature, old sewage works journals, long discussions with sewage works operators – etc. [SEWAGE WORKS OPERATORS ARE THE BEST FOR inexpensive reliable INFO.]

THAT, Anaerobic Digesters are impractical for anything BUT LARGE Scale - manure intensive set-ups. This very fact precludes a widespread, decentralized, small-scale acceptance of anaerobic Digesters as a viable alternative energy source for the future.

SOME FURTHER CONCLUSIONS & ODDS & ENDS: In regards to SOME LOW-COST, LOW-Tech, scrounged, universal, easily made – highly applicable excrement compost – is this little set-up that I cut & welded up quickly as a take-off on the hideously expensive (\$1,600.00+) “Clivus” (meaning inclination & THUS, THE NATURAL VENTING) Composting Toilet:

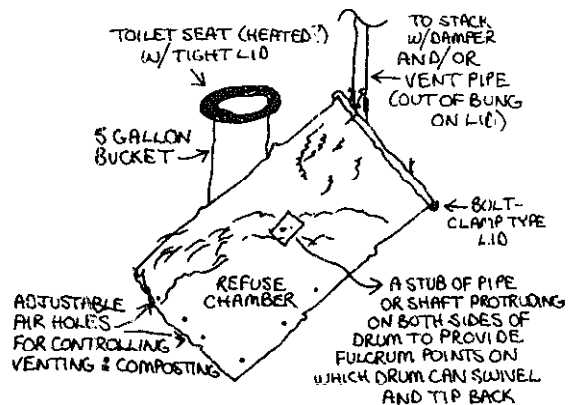

Jim Burgel
Bangor, Michigan

BURNING WOOD

BY J. BALDWIN

Shortages and high cost of conventional fuels have encouraged many people to turn to wood. Too many, probably, for this country's wood supply to service over the long haul unless disciplined forest management is practiced. This seems to be an unlikely prospect until there are shortages of wood too; cord-cutting is a quick profit business. It obviously takes a lot less time to cut and burn a tree than it takes to grow one. How many of you who burn wood plant trees? Of course, you can justify using "downed wood," but that is taking needed soil nutrients and it deprives certain wildlife of necessary shelter and food. You can burn "slash" cuttings and stumps left over from lumbering — but this is definitely a limited resource and it smacks a bit of secretly condoning the awful lumbering methods that result in slash. *Father like not thinking about where your hamburger really comes from. A great many wood-burning civilizations have completely destroyed their forests (India and many South American countries.) In this country we plant*

approximately one tree for each ten cot, so we aren't safe either. Wood may be renewable but it isn't inexhaustible unless managed. Even that holds a possibility of soil depletion over a long period of time.

Whether you are going to be honest about it and manage a woodlot (or buy from a managed lot), or whether you are going to transfer a fossil fuel attitude to wood burning and ignore the real issues as long as you are warm today, it will pay to use as little wood as possible. This means good insulation and a weather-tight building (rarely seen in a rural setting) and good equipment. Tradition isn't always a good indicator of efficiency either. Our forefathers saw the forests as inexhaustible and if their high-ceilinged houses leaked a lot of heat, they just put on another log. Look at the gigantic size of many colonial fireplaces! Even the famous "Franklin Stove" is an energy hog. (Though Ben Franklin's original was not. What we have today are cheap imitations of the cheap imitations of his day.) In any case, an in-

Wood Heat

All those little things that other books assume you know, but probably don't, are worked at here, and probably illustrated too. There's a particularly good section on wood range cooking. Also very good is the discussion of procedures such as lighting up. There's even a plan for a flue fire alarm! I learned more from this very personal account than from anything else I've read on the subject.

Wood Heat

John Vivian
1976; 320 pp.

\$4.95 postpaid

from:
Rodale Press, Inc.
33 East Minor
Emmaus, PA 18049
or Whole Earth



The older (and costlier) the stove, the more primitive was the casting technology of the time and the more likely you are to have warped plates. For really serious daily use, I just wouldn't buy an antique, warped or not. Any stove manufactured much earlier than 1860 belongs in a museum, I'd say. Too, I feel that most stoves built prior to 1900 just shouldn't be asked to go back to daily work. A lot of folks will disagree, including Richard "Stove Black" Richardson who runs the Good Time Stove Company on Route 112 in Goshen, MA and who knows more about old ranges and most other kinds of old stoves than anyone I know of, myself included by a long shot.

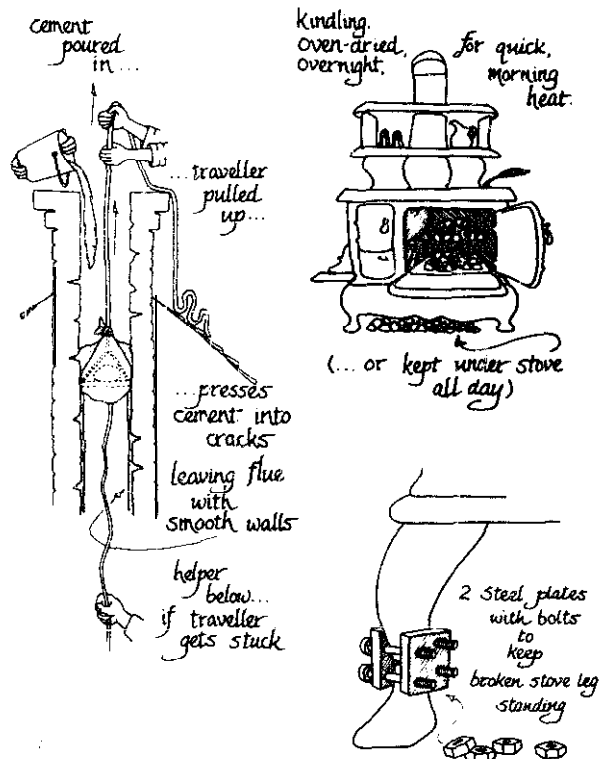

creased "se of wood as fuel is going to add pressure to an already overloaded environment as the demand for trees increases and as air pollution is increased from the burning. Such concerns make wood burning not quite a simple fire in the fireplace on a rainy night.

In the hardware department, a/s/o there is controversy. "My Ashley is better than your Trolla!" and every other possible combination of brand loyalty, myth, and unfounded claim is heard these days. Professor



The lady is an Austrian stove. Sent by Dave Lyle.

Jay Shelton, one of the authors of The Woodburner's Encyclopedia, has actually run tests on many stoves under laboratory conditions in an effort to settle some of the arguments. I don't know whether he has settled them or not. Mow I hear. "Yes, but his lab is different than my adobe," and like that. It's clear that there will have to be a lot more research if we are really going to know what we are doing. I'll guess that certain stoves are best for certain structures, weather, and wood type. Best is probably to ask around, as there are many local problems. For instance, did you know that burning driftwood just eats the hell out of steel stoves? The salt. (I can hear it now. "But our stove has been fed driftwood right here in Coos Bay for 35 years and it's just like new!") Ah well. Here are some books on the subject, and some stoves that our readers seem to like. We haven't had any letters on what readers dislike, probably because it's too embarrassing to spend \$300 on a turkey. For sure you should shop around. Many stoves are heavily discounted. And keep in mind what you're doing to our trees.

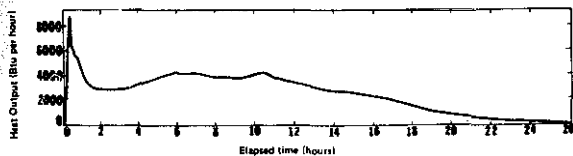

Figure 7-5. The heat output of a Jatal 802 in a very low-power burn during a particular run. The initial sharp peak is due to the burning of kindling to generate some coals. After 20 minutes the stove was filled with about 18 pounds of red oak. The air inlet damper was then nearly shut, and no adjustments or wood additions were made for the rest of the burn. With so little air, the burn was a flameless smolder with a very low and steady heat output of about 3,000 Btu per hour; this is equivalent to about a third of the heat output of a top burner in a cooking range.

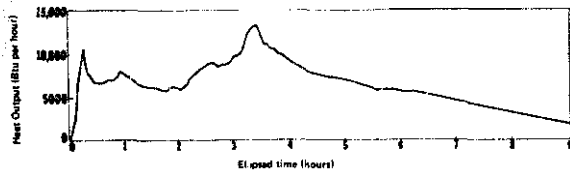

Figure 7-6. The heat output of a Jatal 802 without its baffle plate during a particular run with one full load of fuel at the beginning and no subsequent adjustments of dampers. The heat output is fairly steady, but less so than in Figure 7-5, probably due to the existence of some flames at this higher heating rate, and due to the absence of the baffle plate.

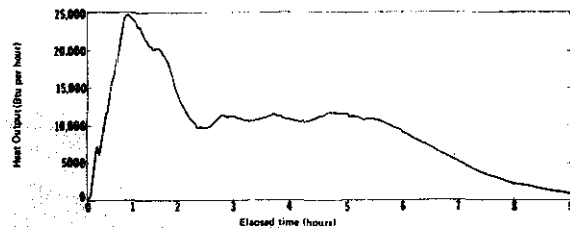

Figure 7-7. The heat output of a Morel 2B stove during a particular run involving one full loading with fuel at the beginning and no subsequent adjustments. The surge at the beginning is typical when non-automatic stoves are operated at medium power, and probably corresponds to the burning of combustible gases, which are most abundant in the early portions of a fire.

The Woodburner's Encyclopedia

All things considered, this is likely the most useful book if you're just going to look at one. Jay Shelton's test findings are summarized here, which should help you decide at least what type stove to try. (His list of stove manufacturers and distributors is comprehensive.) Just about everything else you need to know about wood burning is covered too, including what little is known about environmental impact.

The Woodburner's Encyclopedia

Jay Shelton and Andrew B. Shapiro
1976; 155 pp.

\$6.95 postpaid

from:
Vermont Crossroads Press
Box 333
Waitsfield, VT 05673
or Whole Earth

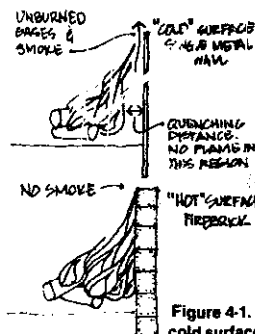
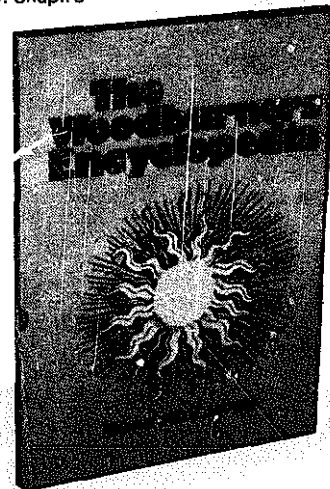

Figure 4-1. Effect of a cold surface on a flame.

The Complete Book of Heating With Wood

A more modest but quite complete book that has some coverage of older models not found elsewhere.

The Complete Book of Heating With Wood

Larry Gay
1974; 128 pp.

\$3.95 postpaid

from:
Garden Way Publishing Co
Charlotte, VT 05445
or Whole Earth

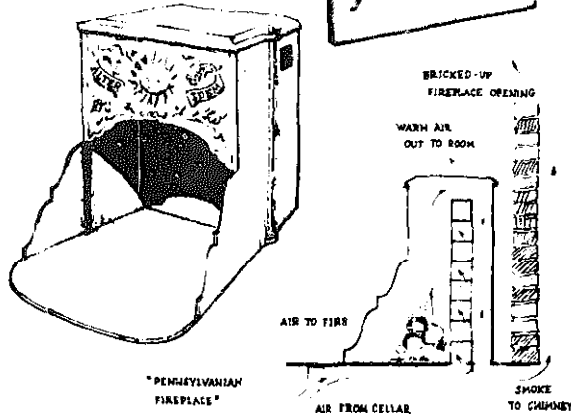
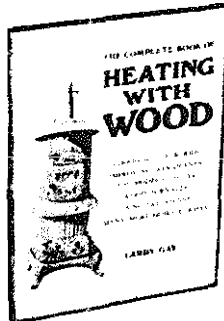

Franklin's "PENNSYLVANIAN FIREPLACE"

"In common chimneys, the strongest heat from the fire, which is upwards, goes directly up the chimney, and is lost; and there is such a strong draft into the chimney, that not only the upright heat, but also the back, sides, and downward heats are carried up the chimney by that draft of air; and the warmth given before the fire, by the rays that strike out towards the room, is continually driven back, crowded into the chimney, and carried up by the same draft of air. But here the upright heat strikes and heats the top plate, which warms the air above it, and that comes into the room. The heat likewise, which the fire communicates to the sides, back, bottom, and air-box, is all brought into the room; for you will find a constant current of warm air coming out of the chimney corner into the room." —Benjamin Franklin

Modern and Classic Woodburning Stoves

Another thorough good one with nice drawings. Best coverage of naggy details that have to be right. Traditional types are shown too, as are homes specially designed to be heated with wood.

Modern and Classic Woodburning Stoves

(and the Grassroots Energy Revival)
Bob and Carol Ross
1977; 143 pp.

\$10.00 postpaid

from:
The Overlook Press
The Viking Press, Inc.
625 Madison Ave.
New York city
NY 10022
or Whole Earth

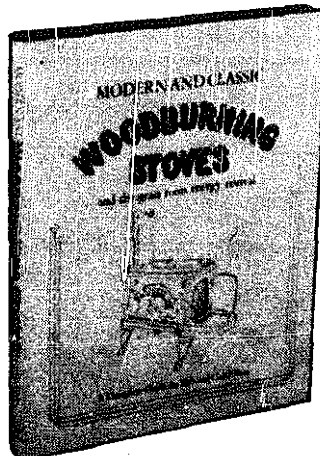

Stove Book

Woodburning aesthetes will marvel at this collection of color photographs of some remarkable examples of stove craftsmanship. They really don't make 'em like they used to, alas. The photos are super.

Stove Book

Jo Reid and John Peck
1977; 111 pp.

\$5.95 postpaid

from:
St. Martin's Press, Inc.
176 Fifth Ave.
New York, NY 10010

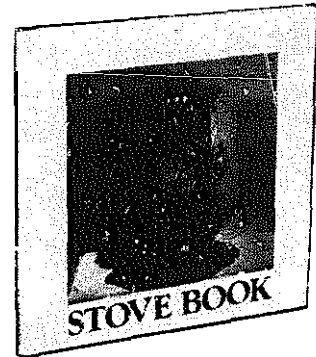

How to Install a Fireplace

Another good one is:

How to Install a Fireplace (Radiant Heat, Circulating Hot Air, Free Standing, Masonry) Donald R. Brann 1974; 242 pp.

\$3.50 postpaid

from:
Directions Simplified, Inc.
Division of Easi-Bild Pattern Co., Inc.
P.O. Box 215
Briarcliff Manor, NY 10510
or Whole Earth

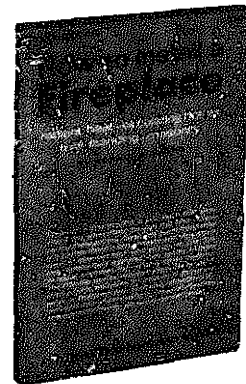

Planning and Building Your Fireplace

Everything you need to know to do just that. Fireplaces built by guesswork are nearly always dreadful. If you don't know the rules, you had better learn. Here's where.

Planning and Building Your Fireplace

Margaret and Wilbur F. Eastman
1976; 124 pp.

\$4.95

from:
Garden Way Publishing Co.
Charlotte, VT 05445
or Whole Earth

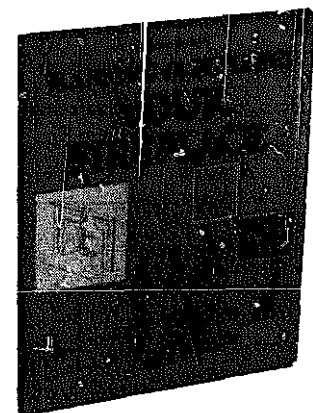



Wood 'N Energy

The (at least) quarterly of the Society For The Protection of New Hampshire Forests, and the Wood Energy Institute. You have to be a member to receive it. This is where you find the Latest Developments.

Wood 'N Energy

Information free from:
Wood 'N Energy
SPNHF
5 South State Street
Concord, NH 03301

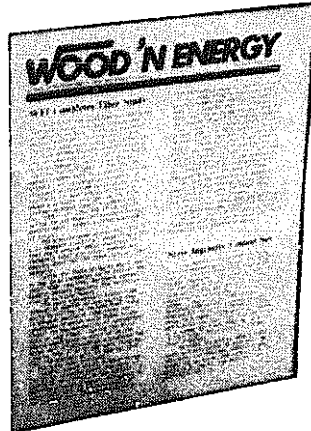

Ron and Gerri King have a new home in Loudon which they heat with wood.

After considering the problem of harvesting and handling fire wood the Kings came up with an interesting idea: A series of small mobile bins filled with split wood in the forest, loaded on a sleigh or wagon and drawn to the house. The bins are rolled from their dry storage place under the eaves and parked next to the stoves. Wood will always be available — and with no mess. What's more, once the wood is split it doesn't have to be handled again until it's actually thrown into the fire.

Wood Burning Quarterly

A very interesting collection of myths revisited, new products and techniques, and stories. Lots of ads too. The issue I have on my desk is 78 pages, mostly of good solid stuff.

Wood Burning Quarterly \$6.00/yr.

from:
Wood Burning Quarterly
8009 34th Ave. South
Minneapolis, MN 55420

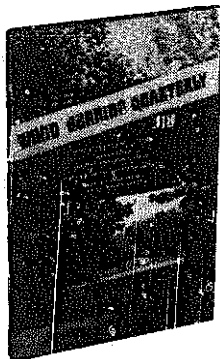

Wood Burning Brick Stoves

By Jaan Jaakson

The basic principle of such a stove is the property of clay brick to store heat and release it over a longer period of time. The most primitive form is the Russian stove, originating in 17th century Russia . . .

This writer grew up with a stove like this in rural Estonia, and the same type is still in wide use in that country and Russia. In normal winter weather a good armful of logs about 2 feet long, or a bundle or two of twigs was burned every afternoon and the stove remained warm until the next midday. In severe temperatures of up to 40° below, two firings in a 24 hour period were required.

Wood Stove Buyer's Guide

A handsome, big poster with a large variety of woodstoves (Lange, Jøtul, Down Drafter, Fisher, Morsø, Riteway, etc., etc.) shown in very clear drawings flanked with specifications. The reverse side covers much of what is in the books on the subject. Looks great! Invaluable shopper's guide. Prices are out of date though.

Wood Stove Buyer's
Guide Poster
\$2.50

from:
Northeast Carry
110 Water Street
Hallowell, ME 04347

TEMPWOOD V

Mohawk Industries,
Adams, Mass.

\$219.00
24" x 24" x 14"
11" diameter top lid
100 lb
35,000 BTU
steel, with steel liner and
cast lid
16" x 18"

Handsome and reasonably priced. Mfr. claims very little ash buildup. Easily controlled for steady long burn. Steel liners may need eventual replacing; they are cooled, however, which will reduce stress. Excellent for fireplace hearth set-up.

A good stove to watch. Design shows considerable innovations. Top loader does not smoke if properly loaded. Maximum air delivered to gas combustion zone.

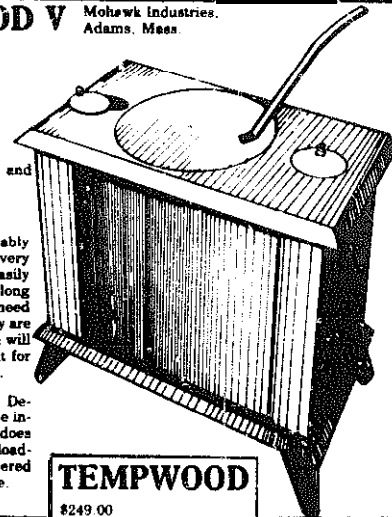

TEMPWOOD

\$249.00
28" x 28" x 18"
11" diameter lid
132 lb
60,000 BTU
steel body, steel liner, cast
iron lid
20" x 24"
cf Tempwood V notes
cf Tempwood V notes
flue: 6"

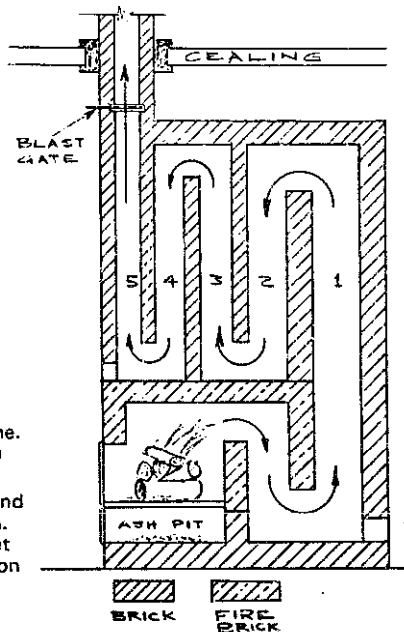

Wood Stoves

Yes, you can make a stove if you're reasonably adept with tools. You'll likely save quite a bit of money too, considering the inflated price of the better grade of commercial jobs. Stovemaking might also be a good way for woodbutchers to get into metalworking, as the proper attitude will be familiar even if the materials are not. Very fine diagrams and photographs back a chatty, experienced text in this comprehensive manual. Many proven designs are shown, including cookstoves. The author is a warm Alaskan.

— JB

Wood Stoves
(How to Make and Use Them)
Ole Wik
1977; 194 pp.

\$5.95 postpaid

from:
Alaska Northwest
Publishing Co.
Box 4-EEE
Anchorage, AK 99509
or Whole Earth

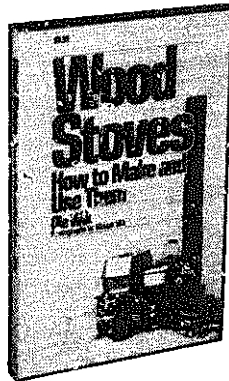

Blazing Showers

Those heat ruffles going into a woodstove pipe can be turned into hot water using this manual of design and construction of a coil element stovepipe — installed water heating system. The company sells a kit for \$59, but you can buy the manual separate, and it tells you how to build your own without the kit. That shows me the company has its heart in the right place.

— J.D. Smith

Blazing Showers Manual

\$2.50 postpaid

from:
Blazing Showers
P.O. Box 327
Point Arena, CA 95468

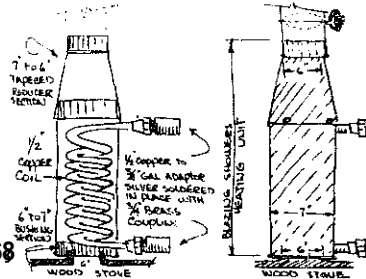

Mexican water heater

Dear Folks,

I am looking for some information about a particular method of heating water with wood. Thought you might know something about it or maybe how I can find out more. I'm referring to water heaters that I used while living in Mexico — and I assume that they are manufactured there (I'd love to know the name and address of the company!) — anyway the water heater worked something like this:



The whole thing sat off the floor on three legs (or four) and consisted of a small fire bed with a tall cylindrical flue to the outside, surrounded by a cylindrical, water-filled jacket/chamber with the expected inflow pipes in the bottom and hot water outflow at the top. By building a small, hot fire we could heat 15-20 gallons of water in as many minutes, and warm the bathroom in the process. It took up very little space in the bathroom and worked beautifully for a couple of showers per fire — and no energy was used keeping water hot when it wasn't needed.

— Sue Hibbert, Silver Spring, Maryland

The Lorena Cookstove

The massive adobe cookstoves you see in Mexico and Guatemala can be built by you with the help of these comprehensive plans. The great mass holds the heat for a long time, thus helping to heat the house if you have it indoors. The people at Estacion Experimental Choqui are working to bring energy conserving technology to Guatemala. They offer this booklet free and even encourage you to reproduce it (with appropriate credit of course), but I'd certainly send them a couple of dollars.

— JB

[Suggested by Larry Jacobs]

The Lorena Cookstove
Plans

Free (but I'd send them at least \$2.00 to be fair)

from:
Estacion Experimental Choqui
Apartado Postal 159
Guzaltenango, Guatemala

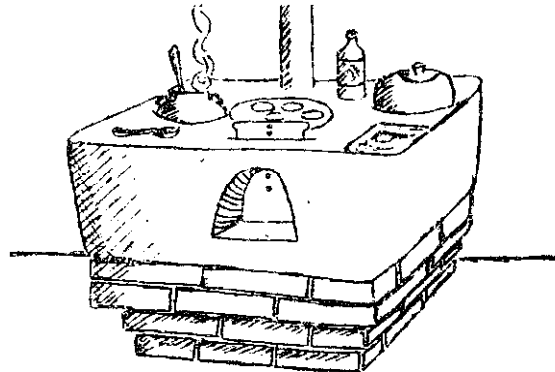

A beautiful woodburning boiler

Anyone contemplating wood heat ought to know about the HS boiler. It's made in Denmark and imported by Tekton Design Corp., Conway, Mass. 01341. The HS burns wood or oil to fire a hot water heating system. It heats the house and provides domestic hot water, all for a very reasonable price. For example, quality wood furnaces that I know of run \$2000 to \$3000. The HS is available in three sizes for \$1200 to \$1675, including oil burner. And it's a very well-made piece of equipment. The idea is this: Most people buying it would want to use wood for the major part of their heat. But if you go away for the weekend and the wood fire goes out, the oil burner automatically cuts in to keep your pipes from freezing. An elegant device, easing the transition to a less-affluent age.

— David Lyle

Woodburning gossip has it that the HS boiler is twice as efficient as the Riteway, which is the only other woodburning boiler in America.

— SB

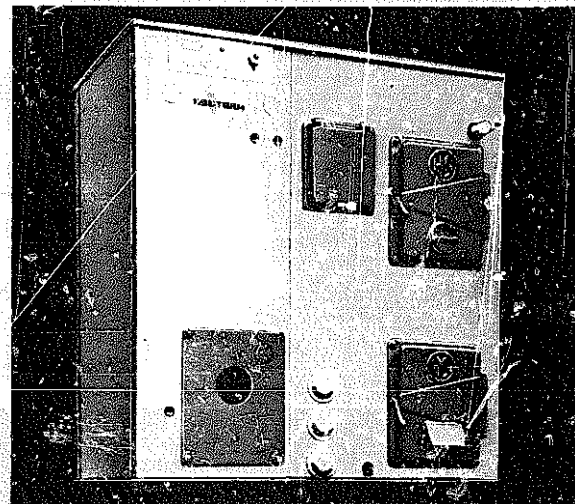

Pioneer Lamps and Stoves Co.

This is to me the most fascinating stove catalog available. They also have restored, incredibly beautiful stoves at museum prices. (Well at least you can drool.) Their production stoves cover a wide range (so to speak) of types and sizes not often seen. — JB

Pioneer Lamps and stoves Catalog

\$4.00 postpaid

from:
Pioneer Lamps and Stoves
71A Yesler Way
Seattle, WA 98104

Another long-forgotten design, the B&M No. 5 is the largest and most efficient potbelly on the market today. It's tear-drop shape, three-legged stance, and exaggerated heat dame make modern folks pause and ponder. Although available in three sizes, the doors and fireboxes of the larger models are better for wood. In cannonballs, wood over six inches long burns best in blocks rather than lengths. Blocks settle together while burning in the bowl-shaped firebox, thus maintaining combustion until everything is burned. All cast iron/all American made, allow four weeks for delivery, \$900.00.

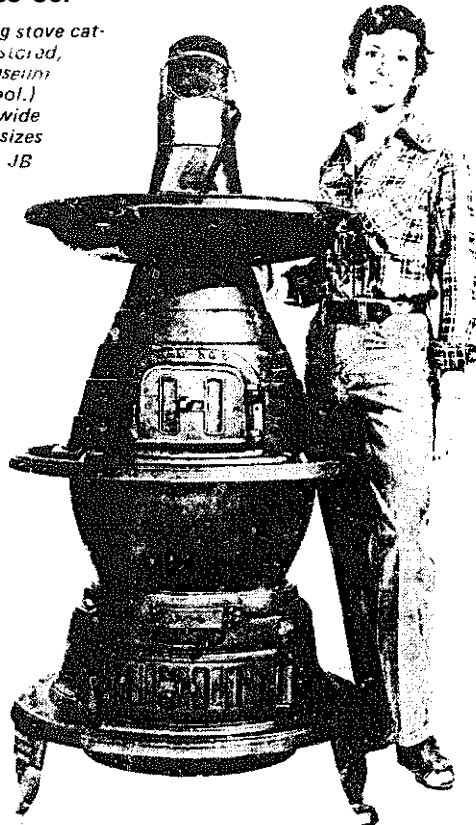

Sotz Splitting Maul

For hand-powered splitting, there's the Sotz, a monster of a maul with a wide-wedge (non-sticking) 20(!) pound head and a steel handle. You probably could split most anything in one smite with this thing, but doing in a cord all at one standing would likely be quite a workout. Too bad you couldn't pipe the operator's heat into the living room. . .

— JB

Sotz Wood Splitting Maul

\$19.95 east Of Mississippi

\$21.70 west of Mississippi

from:
Sotz Corporation
23797 Sprague Road
Columbia station, OH 44028



August West Chimney Sweep

Here's how to get started as a chimney sweep. The handbook is remarkably complete in showing how to set up a business (any business, actually), but the sweeping instructions are intended only for those in possession of the special brushes and dust vacuum they sell.

— JB

August West Chimney Sweep Handbook

\$9.50 postpaid

Complete sweep Equipment Kit

\$1385.00 (includes Top Hat)

from:
August West International
33 Rae Lane
Norwalk, CT 06850



The market is huge and growing — what it takes is education. The advertising I've used here in Connecticut does two things. one. It tells people they have a serious problem in their home and unless they have their chimney cleaned they face the real danger of chimney fire. I use outside, authoritative sources for this message — people like the National Fire Protection Association. And two, my advertising makes them smile. I've heard of chimney sweeps working in coveralls and trying to present themselves as servicemen. Well they're right, it's a service. But it's a much more attractive service when the guy doing it looks like a 19th Century tradesman, with all that that implies: honesty, simplicity, a high degree of dedication, and a sense of humor. Al, these qualities are sadly lacking in the business world, but I felt that as a chimney sweep, I had a golden opportunity to bring some of them back. I think I can say it's paid off — in the form of happy customers and a healthy bank account.

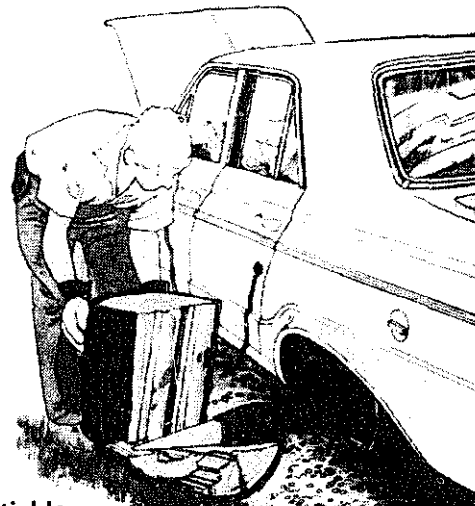

The Stickler

I'll admit to being very suspicious of this device when I first saw their advertisements. Well sir, if you see one work, you're more likely to be suspicious of your own eyes. The thing is absolutely amazing! They claim you can split a cord an hour. It does take gasoline to run it, but you get many more BTU than you spend. It's priced for what the market will bear, but I'd say it is the best power splitter made at any price. Even stumps! You wouldn't believe it. . .

— JB

The Stickler
\$200.00 (approx.)

from:
Taos Equipment Manufacturers, Inc.
P.O. Box 1565
Taos, NM 87571

A quiet chainsaw!

Contrary to public belief, the Stihl 045 is not the best chainsaw going. At least according to those who make a living out of cutting wood in this part of the world (British Columbia). The saw that people are trading their Stihls in for? The Husqvarna 250/380 or 1100. Also Swedish made, Husqvarna is sturdy, dependable and QUIET. They pioneered the quiet chainsaw; it sounds like one of those two cycle motorbikes would, were it properly muffled. The best feature to my mind is the vibration damping. The three main parts of the saw (engine, front handle and rear handle) are joined together by special rubber mountings which wipe out engine and chain vibrations. The engine looks like it's floating on the rest of the framework. After 8 hours of cutting with the Husqvarna, you don't feel like you've been riding a horse with the gait of a jackrabbit. The Husqvarna outclasses the Stihl

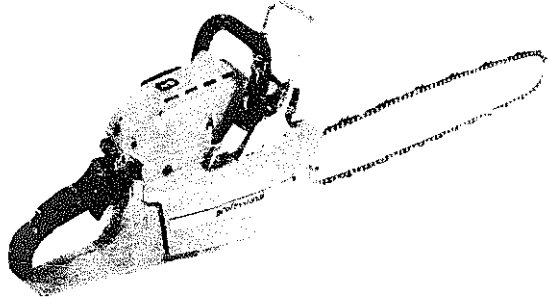

for chain oiling qualities as well. The smaller Stihls (031, 041, etc.) don't have a manual override, so when the diaphragm pump goes, (as it does) you burn out your blade and bar. The Husqvarnas don't have the override either . . . but then they have a cam-activated pump which doesn't give up like the Stihl-type. Mechanics tell me that you can't leave a Stihl sitting around for any length of time (six months or more) without draining the chain oil because it leaks into the crankcase and then you have problems. Not so with the Husqvarna. What hasn't the Husqvarna got going for it? Well, around these parts it is a little more expensive than other comparably powered saws and a might bit heavier.

— Vic Marks

Husqvarna also makes the excellent Viking sewing machine, winning competition motorcycles, and firearms. Their rifles are highly regarded in Arctic climates.

—JB

Husqvarna 280

\$350.00 approx.
with 22" blade

from:

Bee Tee Engine & Equip. Sale:
2424 Teagarden Street
San Leandro, CA 94577
(415) 483-4470

R.L. Gould & Co.
3711 Lexington Ave. North
St. Paul, MN 55112
(612) 484-8411

Sachs Dolmar Chainsaw

What makes this machine unique is the Wankel engine. That means hmmm instead of putt-putt, plus extraordinary power (8!), no vibration, and very quiet operation. Sachs has a good reputation, having made more than 100,000 Wankels for snowmobiles, saws, etc. The warranty is a full year, which shows faith. You can get a replacement airmail too. I haven't actually tried one, but you can, free, for a week by contacting the dealer. If you must chainsaw, this looks good to me.

—JB

[Suggested by Paul Sternfels]

Sachs Dolmar Chainsaw

from:
The Derby Log Splitter Co.
P.O. Box 21
Rumson, NJ 07760

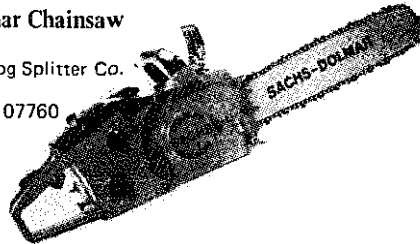

Crosscut Saw Manual

This manual of big-saw sharpening and care is unusual for a government document; it names brand names and has a lot of rather personalized detail. Perhaps that's because it is published for the use of Forest Service employees. I recently hand sharpened a tired saw using the techniques shown, and enjoyed dramatically improved cutting. Nice.

—JB

[Suggested by David Nimick]

Crosscut Saw Manual

(No. 7771 2508)
Warren Miller
1977; 27 pp.

from:

USDA Forest Service
Equipment Development
Center
Bldg. 1, Fort Missoula
Missoula, MT 59801

Free

Now, I know of only one company manufacturing crosscut saws in the United States: Jemco Tool Corp., Saw Division, 60 State St., Seneca Falls, NY 13148. The company distributes a catalog of its saws.

A toolkit for crosscut saw reconditioning is available from the Century Tool Co., Inc., Ginkgo Industrial Park, 102 Richard Road, Ivyland, PA 18974.

Crosscut

And, of course, you can cut it by hand. I do. Hand cutting is quiet, and tends to keep one realistic about being a wood hog. Tends to keep your canoe arm in shape over winter, too. It's also cheap. (And reliable, though I'll admit occasionally hard to start in the cold.)

—JB

Two-man crosscut saw

\$49.05 postpaid

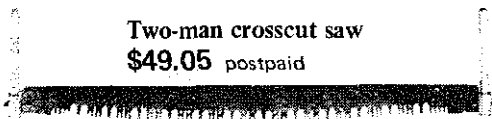

One-man Crosscut saw

\$26.40 postpaid

Bucksaw

\$17.85 postpaid

from:

Woodcraft Supply Corp.
313 Montvale Ave.
Woburn, MA 01801

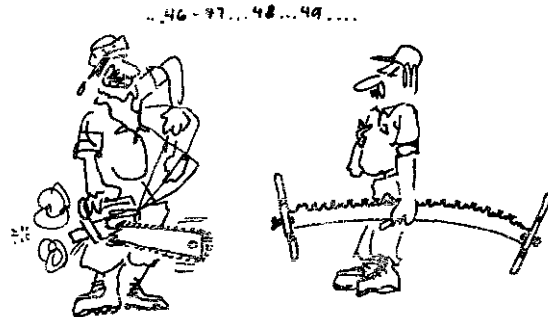

Losing Ground

Desperate news. Firewood is disappearing in the world. So are mountain environments, irrigation systems, fisheries, rain forests, and soil. Chapters from this book have appeared as major articles in Science, Natural History, and elsewhere because of Eckholm's uniquely detailed perspective on environmental degradation in the Third and "Fourth" (impoverished) World. From there the planetary picture is stark.

-SB

Losing Ground
(Environmental Stress
and World Food Prospects)
Erik P. Eckholm
1976; 219pp.

\$3.95 postpaid
from:
W. W. Norton & Co., Inc.
500 Fifth Ave.
New York, NY 10036
or Whole Earth

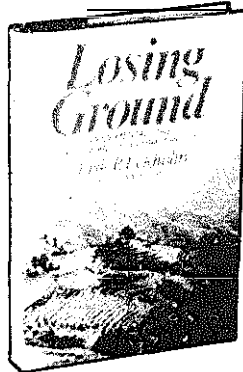

By the mid-twentieth century, said the Chinese minister of forestry in 1956, the country had "the greatest number of barren hills in the world." Throughout much of the country only temple groves remained as a reminder of the original tree-covered landscape.

With life untenable for so many residents of the Andes, largescale migration to other areas is inevitable. As usually occurs when human populations are forced to flee an impossible situation, the movement out of the mountains has given rise to many new social problems.

Ecologically sound planning requires concern for the next decade, the next generation and beyond; only the strong and vocal support — or insistence — of an informed citizenry can allow — or force — leaders to depart from their usual fixation on the next month or year. A widespread public understanding of the ecological danger is ultimately the prime weapon for fighting any commercial interests — whether highly placed timber concessionaires in Indonesia or Pakistan or corporate farmers in Central America — threatened by environmental protection measures. If powerful economic and political interests oppose necessary reforms, then a stronger political force is necessary to override them, and information about the nature of the threats to well-being is essential for building such a coalition. This is broadly true of virtually all political systems — not just democracies.

Experience has proven that sound treatment of the land cannot be decreed by officials — particularly those viewed as alien or oppressive — and then forced upon people who do not understand why changes in their habits are necessary. Faced with serious soil erosion in their African colonies, the British in the 1940s and 1950s tried the coercive approach, and by any account the ultimate results were abysmal.

The trends charted in this book do not point toward a sudden, cataclysmic global famine. What appears most likely, if current patterns prevail, is chronic depression conditions for the share of humankind, perhaps a fourth, that might be termed economically and politically marginal. Marginal people on marginal lands will slowly sink into the slough of hopeless poverty. Some will continue to wrest from the earth what fruits they can, others will turn up in the dead-end urban slums of Africa, Asia, and Latin America. Whether the deterioration of their prospects will be a quiet one is quite another question.

Plant a Tree

Johnny Appleseed realized that planting trees is political; the Datsun company realized that planting a tree for each test drive would sell cars. This book could create a tree planting movement, simply by being such a good manual. It describes, state by state, city street tree planting programs; urban tree maintenance and the brand new practice of controlling street tree pests by releasing predator insects. There is equal discussion of planting and maintenance for various rural conditions, and a fine encyclopedia of many American, European and Oriental trees, with beautiful black and white photographs. These pictures for me are like fairy tales, recalling visions of trees in my childhood.

-Rosemary Menninger

Plant a Tree
(A Working Guide to
Regreening America)
Michael Weiner
1975; 277pp.

\$6.95 postpaid
from:
Macmillan Pub. Co., Inc.
Order Department
Front and Brown Streets
Riverside, NJ 08075
or Whole Earth



Key Questions Important to the Survival of the Tree

1. Can the tree survive the minimum temperature of your locale for prolonged periods of time?
2. Can the tree tolerate the fumes, dust, smoke, and road salt it may be subject to?
3. Will it be able to thrive in the soil it is planted in?
4. Is the rainfall adequate for optimum growth, or will watering be required?
5. How resistant is the tree to diseases common to the area?

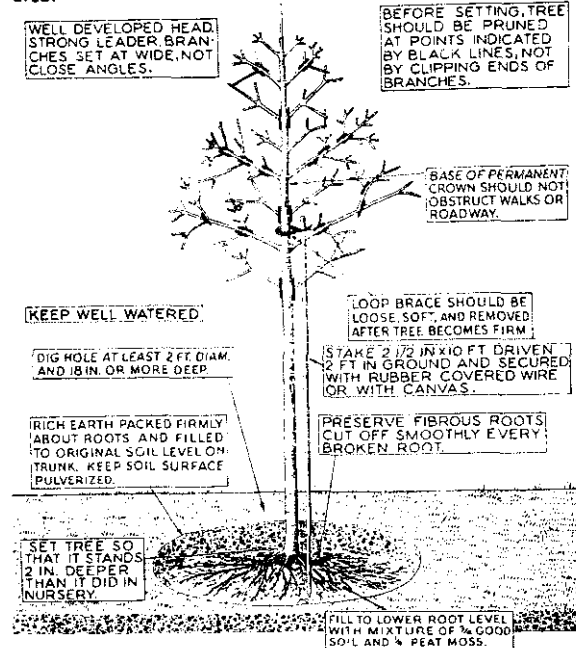

PLANTING A TREE
OBSERVE EVERY POINT

The Underground World

BY JOSEPH TORCHIA

Photos by Paul Glines

Some people called him "The Underground Man." Some people called him "The Human Mole." Some people laughed at him and called him names and said he was crazy. His parents in Sicily thought all of America was laughing at him. One woman refused to marry him unless he built her a house above ground. He never got married.

His name was Baldasare Forestiere and he came to this country in 1902. He was 21 years old, the son of a wealthy Sicilian fruit grower, a man seeking his own fortune and personal independence in a new land. Little did he know that literally it would be "in" the land.

Fresno, California, in the southern middle of the Big Valley, is famous for being undistinguished. So was Watts in Los Angeles before the genius of Simon Rodia's backyard towers was recognized. Maybe it is only in such places that eccentricity can fully flower. There are lone arts and social arts. This is lone art — way out there.

"The Underground World" first appeared in the San Francisco Examiner on Sunday, December 5, 1976, and is reprinted with permission.

—SB

tie didn't speak a word of English and the only work he could get was digging the New York subway system. That was the beginning of his underground life. It didn't take him long to realize all the money he made went for food and rent and the only land he dug belonged to the city of New York.

He wanted his own land. He wanted vineyards and orchards. He wanted to plant his own roots. In 1904 Baldasare Forestiere moved to Fresno, where he bought 700 acres of land only to discover that beneath the surface was a layer of hardpan, the third hardest natural rock in the earth. He cursed his luck almost as violently as he cursed the hot California climate he wasn't used to.

Then he got an idea: Why not live in this hard ground? It wouldn't support fruit, but maybe it would support him — protect him from the harsh California sun.

So he started digging. Forty years later he was still digging.

When he died of pneumonia in 1946, he had completed more than 90 underground rooms.

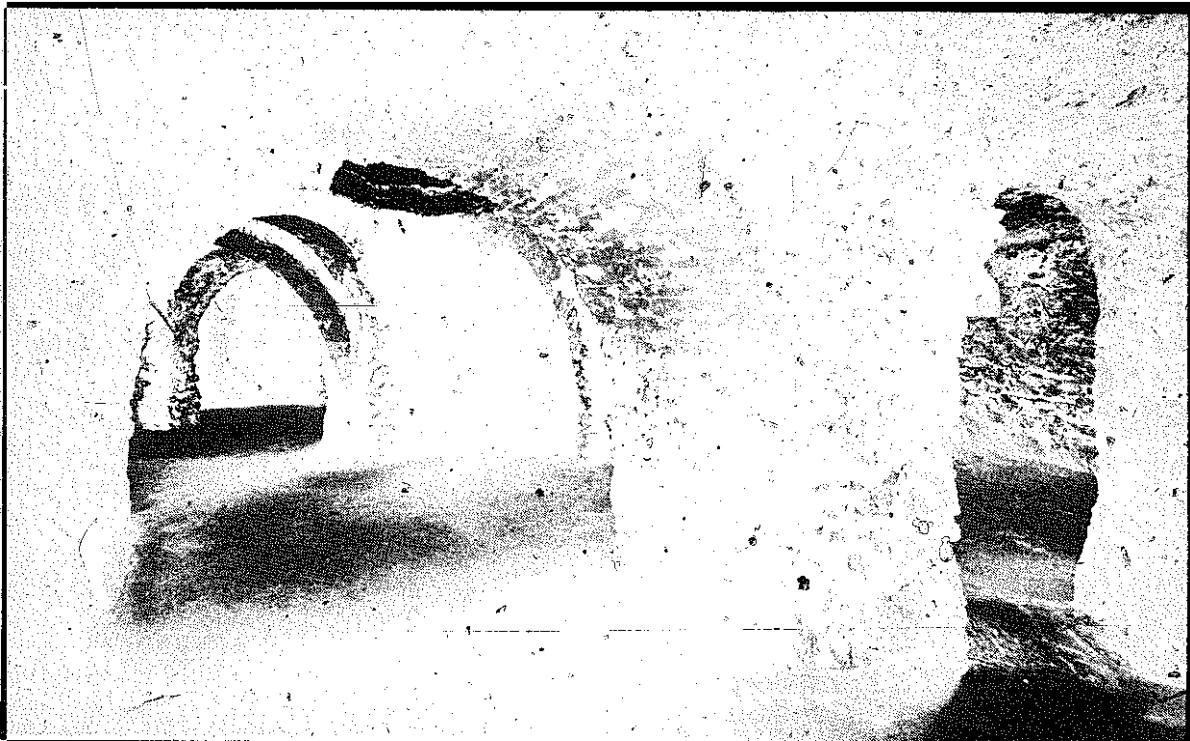

For 40 years, Baldasare Forestiere carved more than 90 underground rooms out of the hard earth near Fresno.

of Baldasare Forestiere

passages and courts covering seven acres of land. He dug a chapel, an 800-foot automobile tunnel and a huge, 5,000-square-foot room — a., underground.

"All that I have done is for nothing, for it required very little money, perhaps \$300," he told a reporter for the Fresno Bee in 1924. At first he supported himself by working for other farmers. But in time he had his own fertile land and other people working for him, so he could spend most of his time digging.

And dig he did. He dug most rooms 10 feet underground, each with an open hole to the surface for light and water, and each with a fruit tree in a planter immediately below. He had one level 23 feet below and another few rooms 35 feet below the surface.

His main tools were hand tools: A pick, a shovel, a wheelbarrow. A horse and smell scraper were used to move large rocks. Sometimes he would allow his brother Giuseppe to help with the cement work, but as soon as Giuseppe left he would completely redo his brother's work.

"I have been doing this for fun," Baldasare once told a reporter. "Money? What do I want With money? If I had a million dollars I couldn't spend it. Neither could you. Nobody could. I am broke but the cavern and all the work it represents are worth more than a million dollars to me."



Baldasare Forestiere: "It required very little money — perhaps \$300."

Today it's called the "Forestiere Underground Gardens," located just seven miles north of downtown Fresno, two blocks east of Freeway 99 on West Shaw Avenue.

At first all you see are a bunch of "bushes" growing out of the dirt. Look closer, however, and you'll notice these "bushes" are actually the tops of trees growing from deep underground. There's one citrus tree 22 feet below the surface — just one tree growing seven different fruits: Navel oranges, Valencia oranges, cedrons, tangerines, sweet lemons, sour lemons and grapefruit.

There are also pomegranate trees and pear trees and persimmon trees and almond trees and palm date trees and mulberry trees and strawberry trees. Yes — Baldasare Forestiere grew strawberries on trees!

There are red grapes and green grapes and rosemary and myrtle, all growing underground, all growing toward the skylights that Forestiere planned, shaped, controlled, designed to give incredible life to his underground world.

There are fireplaces and benches and shelves etched out of the stone walls. There are arches and tunnels and grottos and patios and gardens everywhere. There's a pond where Forestiere used to store fresh

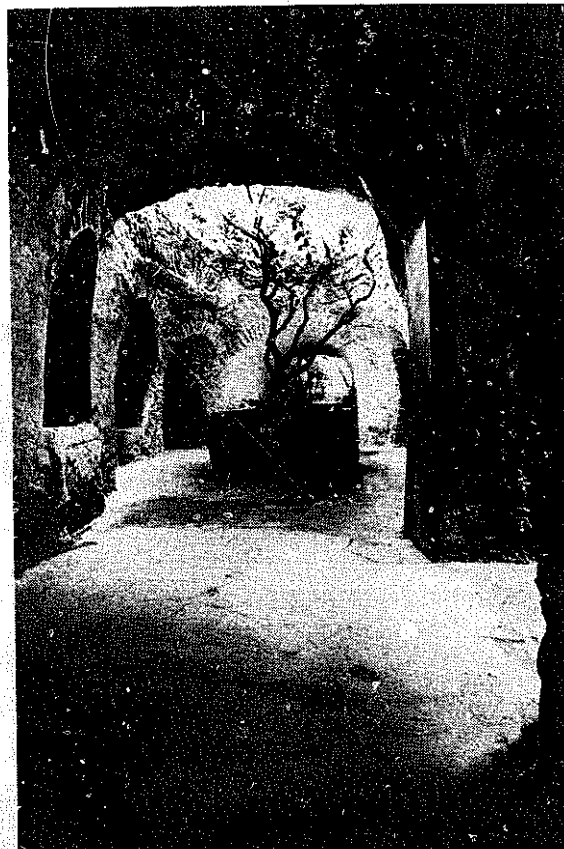

Grafting several fruits onto the same tree, Forestiere turned his underground home into a lush garden.

fish he caught in the San Joaquin River until he was ready to eat them.

There's another pond — a glass-bottom pond 15 feet below ground where he used to keep exotic fish. And 10 feet below that is another area where he could sit and look up at the fish and the skylight above them.

There's a well for water and "sump pits" to drain the winter rains and an underground bathtub with a hose leading to a metal tank above ground where the sun would heat his bathwater. And there's one huge room, 35 by 100 feet, which Forestiere dreamed of turning into an underground restaurant, but he died before it was completed.

"There's a whole lifetime down here," said Rosario ("Hick") Forestiere, now 48, who used to play hide-and-seek in "Uncle Baldie's" caverns. "There's one hell of a lifetime down here."

Rosario remembers his uncle well. He remembers how Uncle Baldie would bless and kiss each plant he put into the soil — each branch he grafted onto his citrus trees. He remembers his uncle making his own wine and calling it "Sangre di Cristo" — "the blood of Christ." He remembers Baldasare in front of him; old radio listening to Lowell Thomas. Or sitting in his underground study reading Eleanor Roosevelt and Booth Tarkington in McCall's Magazine. "He was never at a loss for words," Rosario said. "He read a lot and used a lot of big words I never understood."

During World War II Baldasare violently criticized the American government for putting his Japanese neighbors in detention camps. "Everyone thought he was unpatriotic," Rosario said. "I remember

how ashamed I was of him. 'How can you respect a government like this!' he used to say. 'How can you respect a government that puts its own people behind fences!' " Because of that, Baldasare refused his American citizenship and died an alien.

"I used to love being with him," Rosario said. "I used to love watching him work. I remember once I criticized him for not making his underground rooms perfectly round. 'Any fool can take a piece of string and make it round!' he shouted. 'To make it crooked and have it look nice — that's the real work' "

Today Rosario and his wife Lorraine keep five of Baldasare's original seven acres open to the public. But because of financial problems and the hard rains of the winter of 1977-78, the Underground Gardens will not be open daily until the summer of 1978. Contact Underground Gardens, 5021 W. Shaw Avenue, Fresno, CA 93711 (209 485-3281) for more information.

"God, you'll never know how much I regret never meeting Uncle Baldie," said Lorraine, who married into the Forestiere family long after Baldasare had died. "And yet I feel like I *have* met him," she says. "I keep looking at these walls and seeing his life all around me. I keep saying: Hey, Baldasare — thank you! Thank you for opening something up in me!

"I can't help it," she says. "You can feel it. You can sense it. Look around. Look at these walls and arches and gardens. Look at this world down here. You can see how much he loved people — you can see how much he loved life!" ■



The bedroom: Arch leads to outdoor bathtub

Malcolm Wells comments

Re: Forestiere's Underground Gardens

Dear Mr. Brand:

Your request for a technical analysis and "how-to" evaluation of Forestiere's work gives me a perfect opportunity to use one of my three¹ favorite architectural quotations,

Buildings should speak for themselves²

Are Forestiere's Underground Gardens actually buildings, though? Bernard Rudofsky calls such spaces architecture by subtraction. Well, whether they're buildings or not, they do speak for themselves -- eloquently -- if what I see and read in the *Examiner* are to be believed. Here is space so simple a glance is all anyone needs to understand it completely.

We architects spend from five to eight years in college, and another three to five years in apprenticeship, before the state considers us ready to offer our gems to the waiting public -- and look what we give it! Thirteen years of training and the best we can produce are metal and glass boxes standing in parking lots! Forestiere demolishes us with a wheelbarrow and a dream.

You want a technical analysis of his work? I'll give you one: there it stands. The Gardens exist; what more can I say? Do we need computer studies to prove these fantastic spaces successful? How many others, covering thousands of square feet and costing only \$300, can you name?

How to do it? Easy: dig.

No, it's not as easy as that. Only a Forestiere could do such things. I might try, and get nothing but cave-ins. Or tap an underground river. You see, he knew. You

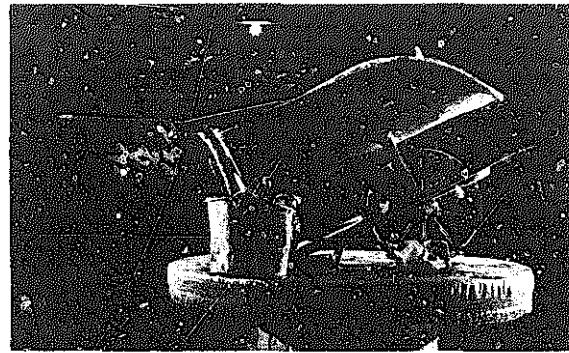

The tools: All the work was done by hand

look at those gardens and it's obvious. They almost seem to have existed before Forestiere arrived. He simply set them free. The trees that grow there, the love of life you feel, and the strange attraction of the Gardens, all indicate that this was not your average ditch-digger. Not by a long shot.

I'm fascinated by the untutored genius that appears now and then, even in the humblest of people, driving its host against all odds to do what he must. Rodia of Watts. Gaudi of Barcelona. Forestiere. Speculation about the source of such gifts inevitably leads to a confrontation with the unanswerable, but it also gives us, I think, our best reason for hope.

Malcolm Wells
Cherry Hill, New Jersey

1. The other two: Thoreau's "... all work passes out of the hands of the architect into the hands of nature, to be perfected." And now this gem from Forestiere: "To make it crooked and make it look nice -- that's the real work."

2. Was it Wright who said this? I forget, but it's right on target.



The underground gourmet: Forestiere's simple kitchen



WELLS' OFFICE – BACK DOOR

The hillside exitway is barely seen in this shot from across the dirty stream, but not one dime was spent on this landscaping. We spread mulch on barren subsoil after we covered the building, went away, and returned to find the work all done.

Underground Architecture

BY MALCOLM WELLS

Invariably, after each of my lectures, there will be among the people who come forward to touch the hem of my garment someone who with great pride will divulge the information that he lives underground. Knowing the odds involved, I find it no risk to ask, "Underground, eh? Hey, that's great. How many feet of earth do you have on the roof?"

I know pretty well what the answer is going to be: "On the roof? Oh. No. It's not that kind of an underground house. I just live in a basement apartment."

Other people tell me about "underground" buildings that are in fact merely bermed (banked with earth on one or more sides), or set deep into the ground and covered with fountains and plazas instead of plants and animals. A lot of new university buildings are built this way. Their designers try to soften the effect by adding little planter-beds, or hard rectangles of grass, to the dead planes of paving materials on the roofs.

Don't get me wrong, though; basement apartments, or bermed houses, or sunken libraries aren't all bad; they tend to go easy on energy, and they cast very few shadows. But *under ground* they are not.

And then there are the other people among the after-lecture crowds, the people who ask what they think are subtle questions about the need for psychological studies of a typical person's reaction to underground living. I know what they're picturing: damp dark slimy suffocating mouldy crawly slithery spidery Dracula coffin death in eternal utter darkness.

They weren't listening to me, in other words.

Malcolm Wells is an architect, writer, and solar consultant. His response to the 6000 inquiries generated by this CQ article is a fine book:

Underground Designs

Malcolm Wells
1977; 87 pp.

\$6.00 postpaid
(10 or more, 40% off)

— JB

from:
Malcolm Wells
Box 1149
Brewster, MA 02631

There I stood, describing in the most eloquent of words and showing in the most brilliant of colors a hundred pictures of bright, sunshine-filled buildings with their windows opening from the sides of hills, or into sunny, sunken gardens -- buildings covered with the most luxurious and beautiful kinds of plant growth -- and half my audience went home thinking I was talking about tunnels and basements. It's what you call hardening of the brain, and it affects us all, young and old alike. Once that trigger-word, "underground," is spoken it hardly matters what kind of pictures I show; half the people are going to sit there re-living childhood horrors no matter what.

All underground architects have to deal with this phenomenon. Most deal with it by changing the name of what they do. You should hear some of the word constructions they're trying to float . . . terrasolatrium architecture . . . terratecture . . . geotecture . . . topotectonic platforms (cross my heart!, to be designed, I suppose, by registered topotectonitects) . . . earth-sheltered architecture . . . earth-integrated architecture . . . anything but that awful word that makes little shivers run down human spines.

I even tell lies myself. I hear myself telling people the main reason to build underground is energy conservation, and I talk a lot about all the money and natural resources you can save. Or that underground buildings are so quiet. Or that I build them to reduce the rainwater run-off invariably associated with impervious roofs. Or because all the sea and land surfaces of the earth were meant to be home to green plants and not to asphalt and concrete.

All those reasons are true -- and terribly important -- but none is my main reason for going under. I'm always afraid to mention the real reason for fear it will seem frivolous and drive people away. So I wait until I know I'm among friends before I admit I do it primarily because it is so beautiful. *Please do not tell anyone this secret reason!*

Architecture, even the good stuff, has always seemed somehow brittle and naked to me. Unfinished. Like prosthetic devices scattered across the land. For ten wasted years I cranked out that sort of junk for one of the big

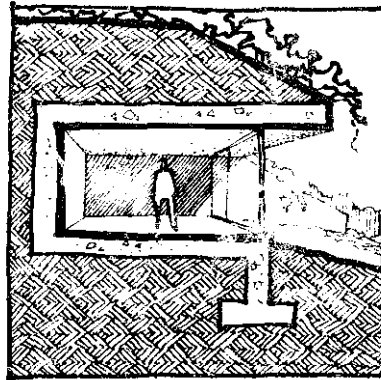
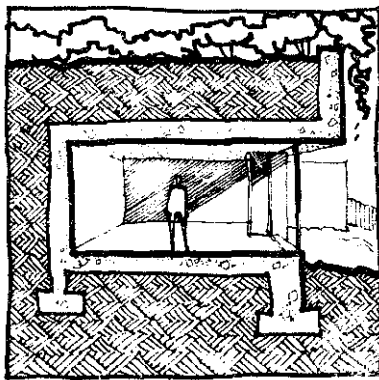

BETTER, BUT STILL WRONG

Overhangs and indoor-outdoor walls look great but they give buildings what Warren Steizel calls "energy nosebleeds". Frank Lloyd Wright, where are you? We may need you. Sometimes we've got to find new ways to create horizontal emphasis and continuous planes, those two great attributes of a human architecture.

THE WRONG APPROACH

Don't try to retain earth with big structural parapet walls. That's only asking for trouble. Expansion and contraction, plus ice damage, can take all the fun out of a building like this. And that massive structure can bleed a lot of heat out of it, too.

multinationals, scattering offices and factories all over the western world. But doing them gave me a chance to see some very old and very beautiful cities, and that made all the difference. Only in the most ancient and overgrown of them did the buildings begin to take on that vine-and-wildflower kind of adornment you might call planetary appropriateness. The less people interfered, the more the living world moved in and took over. "All work," said Henry Thoreau, "passes out of the hands of the architect into the hands of nature, to be perfected."

You might think the wildflowers were trying to tell us something.

When I finally got the message it didn't take me long to imagine how beautiful underground architecture could be. Living rooftops! Buildings back in the earth again, where they belonged. And, to my surprise and delight, underground architecture turned out to be even more cheerful and beautiful than I'd dreamed.

I don't know what color my office roof will be this fall. Last fall it was a solid yellow, done in masses of wild sunflowers. It was so intense it seemed almost to pulsate. Then, a few weeks later, it turned a hundred shades of gold as frost after frost went to work on it. Right now (the first week of true solar summer, mid-May), everything on the

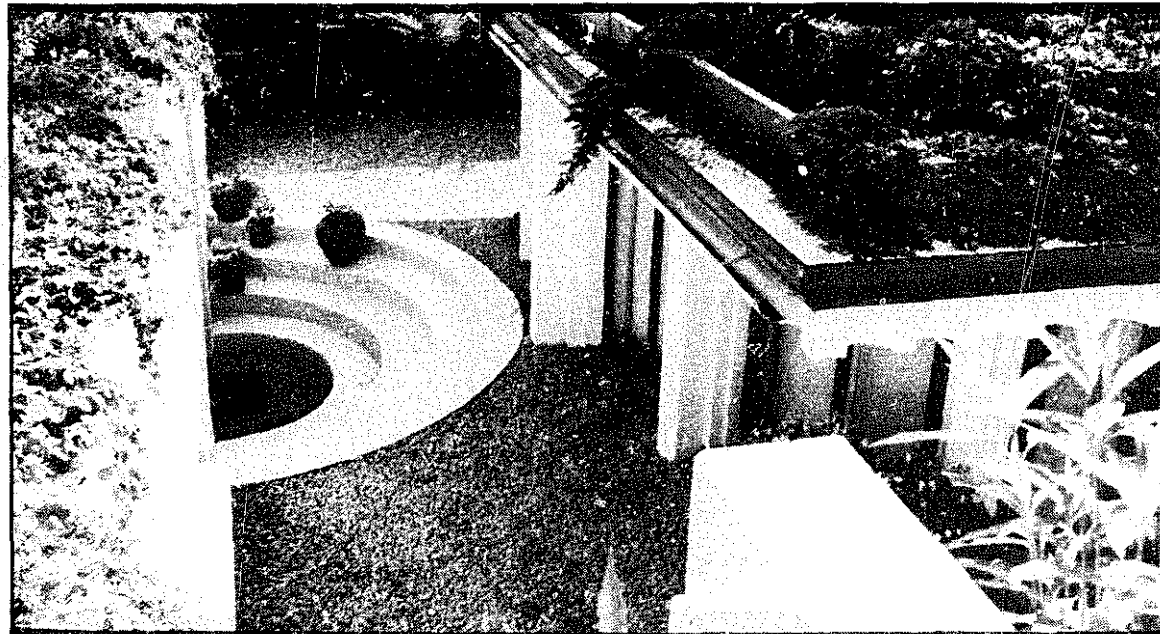

ANOTHER WORLD

Wells' office courtyard: light-years away from the freeway twenty feet from its wall. Earth-covered houses in the city can have silence and privacy in spite of great population density.

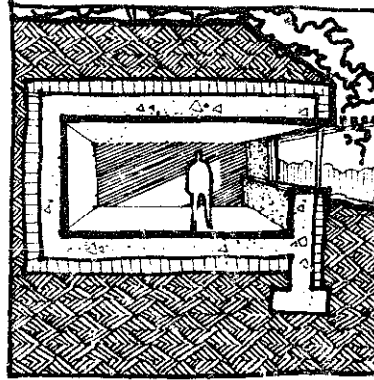
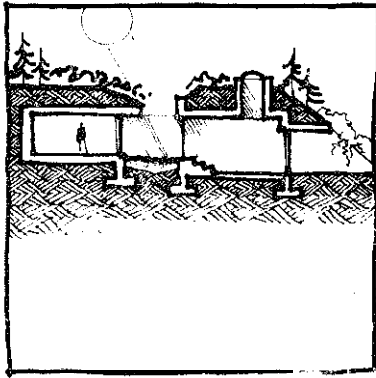

THE RIGHT APPROACH

An externally insulated structure, smaller windows (with easily-moved insulation panels to protect them), and freestanding trellises or canopies instead of covered eyebrows. Wrapped in insulation and protected by the very slow-changing mass of the surrounding earth, a building of this type exists in an almost steady-state condition. The more massive the structure, the more stable and long-lasting its energy storage capacity.

THE WELLS OFFICE AT CHERRY HILL

Unknowingly, I built a heat-bleeder. The parapets and overhangs taught me a lot about earth-covered buildings that first winter (1972). I had to do a lot of retrofit insulating before the heat bills shrank. But the silence . . . ! Even in the open courtyard the roar of the next-door freeway is muted. Birds and sunlight and wildflowers; a tiny oasis in a plastic city.

roof has been tinted with the tenderest and at the same time the most intense shades of green imaginable. We've had a lot of rain, and the roof looks very happy indeed. So does the wildlife. And not one weed has ever appeared.

Cherry Hill, New Jersey, is a lavishly rich, trashy suburb of nearby Philadelphia. My office is a tiny place on a tiny lot, wedged between a freeway and a sewer. When I bought the property (for \$700!) all I could see were a few scabs of old asphalt on a patch of barren subsoil. It was dead; all the way down the scale from forest to woods to farm to suburb to abandoned highway construction yard.

Now, five years later, it's almost a jungle, even though it's topsoil and no fertilizer have ever been used, and a building now underlies almost half the root space. The secrets: plenty of mulch and a few key starter-plants. (And, well, maybe we did do just a little weeding, if I must tell the truth, but only enough to establish a" artificial diversity until a more natural diversity could reestablish itself.) Now, when we tell our clients how to find choice building sites we always urge them to pick the worst ones, not the best, as we were always taught to do. Now people can see for themselves how easy and how gratifying it is to restore a bit of this trampled continent.

The biggest surprise here was the wildlife. How some of it managed the trip I hate to imagine, with that godawful six-lane highway to cross, but get here if did. We have squirrels, rabbits, a groundhog, snapping turtles, box tortoises, possums, rats, mice, moles (speaking of appropriateness), insects, and 23 squadrons of birds. One visitor even claimed to have spotted a Yeti, but that particular sighting is still not considered official.

We feed the birds, of course, but we fed them at the old office next door, too, and they "ever came in such profusion. Cardinals, redwings, mockers, doves, tits, grackles, starlings, chickadees, juncos, sparrows, pheasants, robins, and jays. I'd heard that all you had to do was provide a habitat in order for wildlife to reappear, but I never really believed it, not until I saw it for myself. Now, after only a few years, many of these animals think our sunken courtyard is their rightful home, and a lot of human visitors have been startled to see a rapidly departing rabbit going up the very steps that they were ping down — "I to



SUNLIT INTERIORS

Four feet of earth lie atop this roof slab, but with sunlight pouring in from above, and through the hillside windows, no basement mood is sensed.



TWO SIDES OF A HIGHWAY - EAST

The conventional way - concrete, glass, asphalt, and grass. We may not be able to afford this much longer.

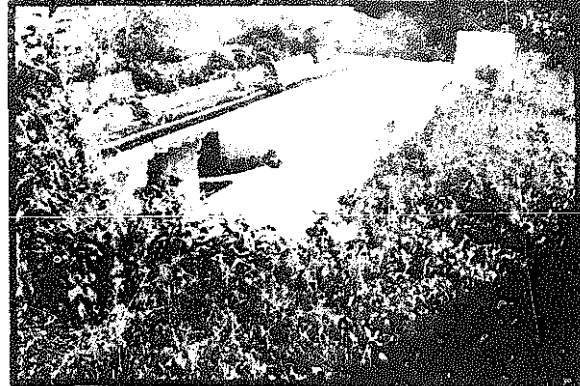

TWO SIDES OF A HIGHWAY - WEST

Architecture at peace with nature - and saving energy like mad.

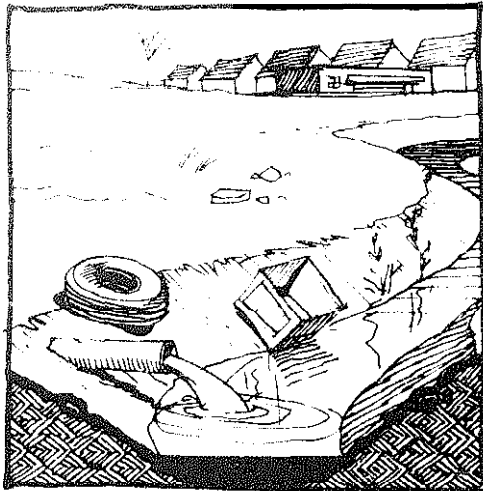

IDEAL BUILDING SITE

Dying land waiting to be restored to life. The price low. The prospects: silence, privacy, wildlife, clean water, wildflowers, more and more topsoil, less and less erosion, lower and lower fuel bills.



IN THE ROARING TRAFFIC'S BOOM

In the silence of my lonely room I smile sometimes at how lucky I am to have stumbled onto an architecture that does all those good things and turns out to be silent as well. My silent office is just 22 feet from the spot where this picture was taken.



SUN AND SHADE

No two minutes are ever alike down in our sunny courtyard. The offices facing this open space change moods with every passing cloud, every passing hour, every passing season. We went into the earth - and found ourselves more in tune with the sky!

Wilderness

+1500

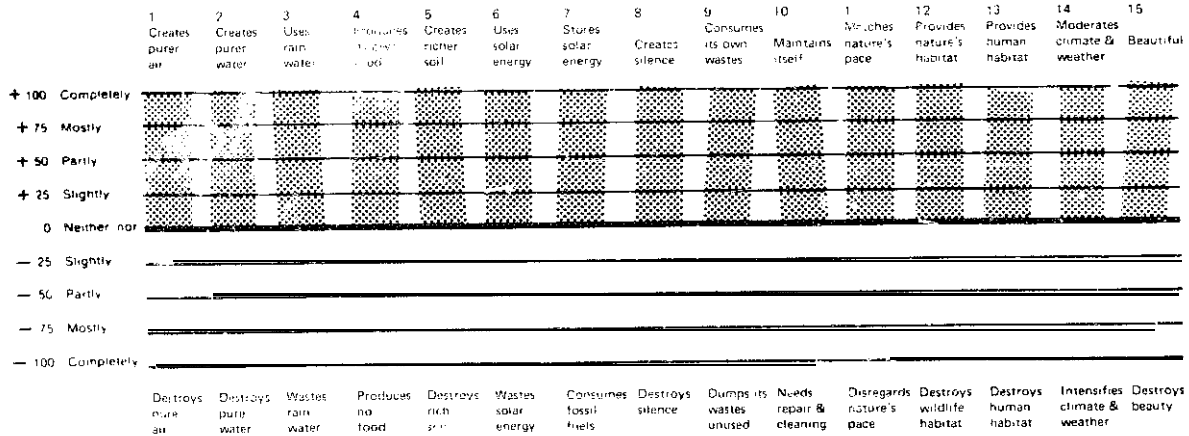

A Typical Modern Building

(minus) -1150

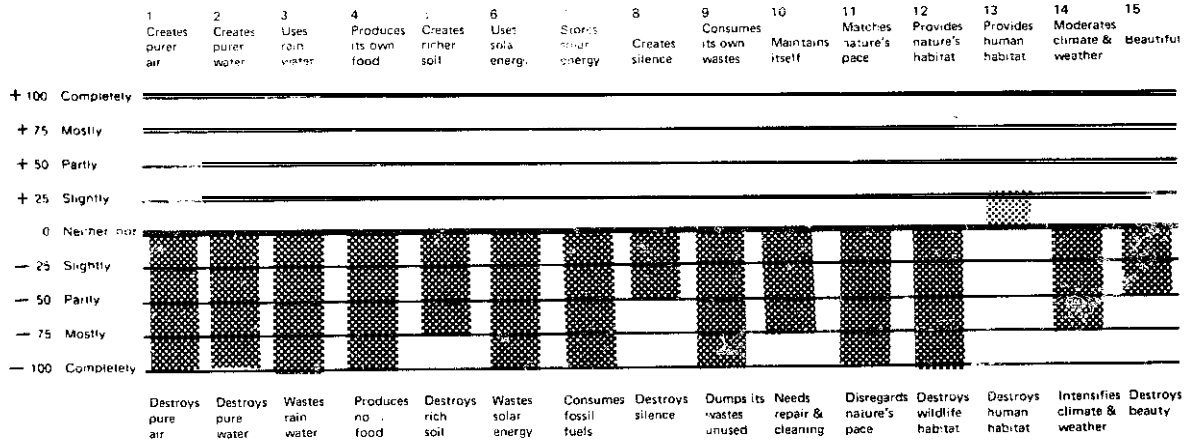

Wells' Underground Office

+125

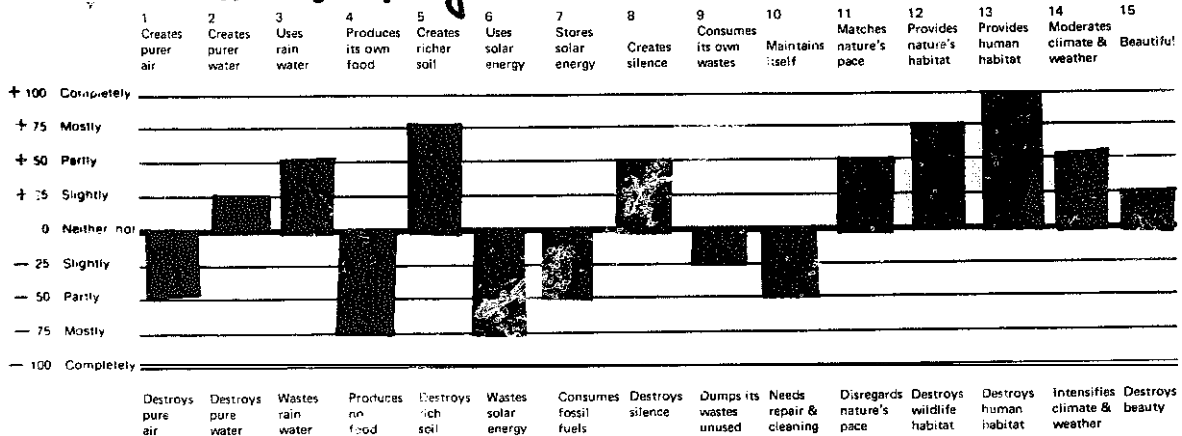

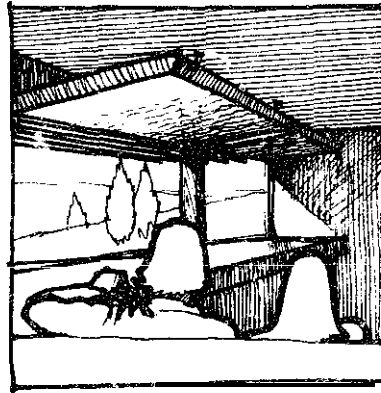

THE WHITEHEADS AT HOME

Dick likes windows. So does Jane. But they know how much heat windows lose. That's why they told their builder to make the windows small, and to provide thick insulation panels they can close on winter nights and other times when they want to stabilize interior conditions.

WHERE'D THE HOUSE GO?

Under the hills. The freestanding trellis shades the window band in summer, lets sun through in winter. Indoors: silent, snug rooms overlooking a reemerging native landscape.

see a flock of birds doing Kamikaze dives into solid earth (the open courtyard is out of sight as you approach the building). The place is jumping.

I could get just as excited, I suppose, about living in a cabin in the hills, or on a seaside cliff, but there isn't room for us all out there anymore. And besides, we've got to heal the city-wounds.

Underground buildings can help. They offer so much silence and privacy they can provide high density accommodations with no less of their inherent greenness. I see no reason at all why high-density, solar heated low income housing can't be as green and as beautiful as parkland — right in the middle of the city — with far lower energy and maintenance bills than now seem possible. There's still a lot to learn about this ancient way of building, but even at this stage all the signs say "do it!"

Earth is a lousy insulator. Urethane foam is perhaps 10 to 20 times as good. And earth is heavy, half again as heavy as water. My roof has to carry 3 or 4 hundred pounds on each of its square feet. Your roof, on the other hand,

usually carries no load at all, although building codes require that it be prepared to carry 30 or 40 pounds, just in case.

Earth is a lousy insulator, but it's a great moderator of temperature change. Warm it up and it stays warm a long time. Some people call this the thermal flywheel effect. Eight or ten feet below the earth's surface the rate of temperature change is such that most of the summer heat doesn't start getting through until about November, just when you start to need it. And the winter cold arrives around May. We energy-cheapskates here at this office are wearing sweaters in the middle of this freak (for May) 95° heat wave, luxuriating in the 61° temperature-of-the-week while people swelter outside, and race their air conditioners inside. It's that flywheel effect that's so nice. Combine it with the right kind of insulation and you can create a very stable situation. The main thing is that you be sure to do it right, taking all kinds of soil tests beforehand, and getting good advice, from people who know your climate, on insulation, vaporproofing and waterproofing.

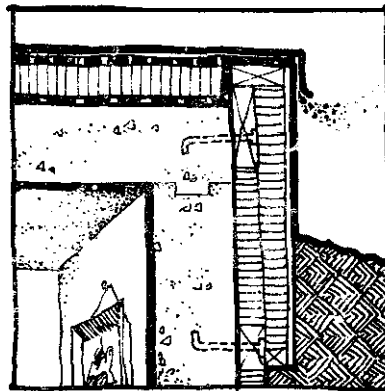
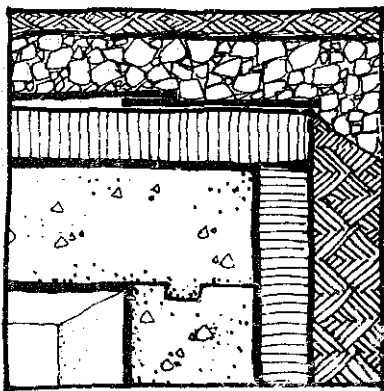

THE UNDERGROUND ROOF

From the top: mulch on earth on fibrous mat on drainage pebbles on protective boards on permeable, closed-cell insulation board on vapor-proof waterproofing on the structure itself. It's one of the systems that seem to have a lot of promise.

We've had good results from 1/16" butyl sheets, but other people like the liquid-applied materials.

A TRICKY DETAILING JOB

If part of your roof IS exposed to the weather you may want to put the roofing materials — the waterproofing — on the outer surface. Just be sure to provide vents for the water vapor that builds up over and under the insulation. Another problem: protecting the exterior wall insulation from things like baseballs. We often use cement plaster on metal lath nailed to treated wood members bolted to the structural wall. Notice that the wall insulation can be thinner as it gets away from the outside, temperature extremes.

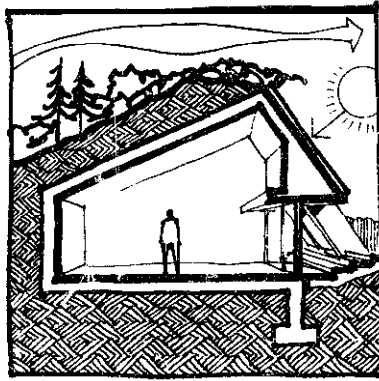

SUN-WARMTH AND EARTH-SHELTER

Cold north winds get rebuffed by the earth barrier, and sunlight is soaked up by southside windows and solar collectors. (Architecture, responding to the environmental imperatives.)

A MORE PRACTICAL WINDOW COVER

Hinged panels can be a problem, of course. That's why the Whiteheads decided to use tight-fitting sliding panels to insulate their windows when house-alteration time came around.

Underground temperatures are not, as I believed for so long, a constant 55° all over the world. I don't know what happens at 50, 100, or 1000 foot depths, but at the shallow architectural depths of a story or two the yearly average underground temperature is about the same as the yearly average air temperature at the place in question. Where I live, it is about 55°, which sounds like low heating, and zero air conditioning bills, until you remember what anyone who sits on the ground in early spring soon learns: 55° earth can bleed a lot of heat out of an otherwise warm behind. That's why we've learned to insulate against what now seems to be an endless heatsink, against all those tons of almost-but-never-quite-warm-enough earth outside the walls.

I could go on and on, of course, but sooner or later I'd begin to talk about the wonderful psychic equilibrium you can attain by having all these friendly masses of earth both above and below you, and if I do that you'll start to wonder if the old boy's mind hasn't begun to slide off the edge, down there in his sunlit paradise, so I think I'll stop right here. ■

Some of the most frequently asked UNDERGROUND QUESTIONS..

1. What about tree roots; won't they damage the structure?

In my four years of experience so far I've seen no indication of this. The horticultural experts I know explain it this way: roots seek water; if no water gets into, or through, the roofing sheet then the roots will have no motive for trying to do so.

2. How much do underground buildings cost?

I could hedge on this and talk about life-cycle costs, but if you want to know about initial costs the indications are that the total construction budget must be increased by about ten per cent. The payback in energy savings, of course, can offset the initial cost increase in as few as ten years if conditions are right.

3. What about earthquakes; are underground buildings safe?

Being a New Jersey architect, I can't say from direct experience, but underground buildings, being inherently stranger than conventional buildings,

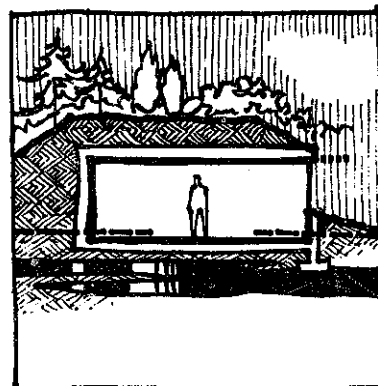
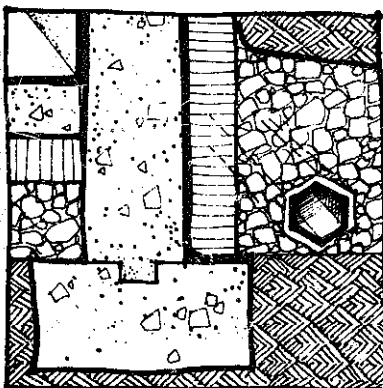

DON'T RELY ON PUMPS!

If the water table is high, build an artificial hill. When you see the way it bursts into life you'll know it's far less artificial than the stuff we've been throwing up all our lives in the name of architecture.

KEEP THE FLOOR DRY!

Inside the well-drained, waterproofed, insulated wall, the floor layers, from the top, should go something like this: slab on vapor barrier on rigid insulation on pebbled drainage bed on earth.

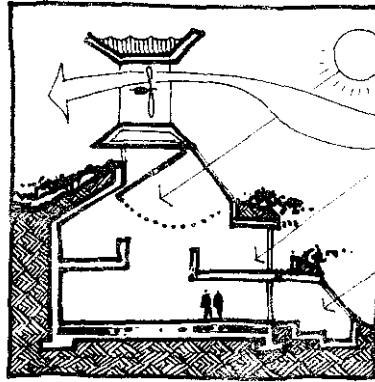
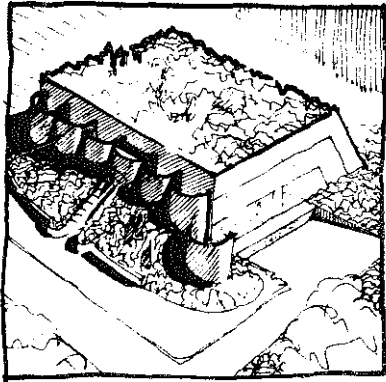

THE RAVEN ROCKS HOUSE IN OHIO

Electricity from the wind (top), heat from the sun - stored in the massive concrete structure itself, sunlighted interiors deep inside the hill, more heat stored in underfloor stone beads, green-houses for winter food, sewerless toilets, and a water storage reservoir above the high wind funnel for fire protection and irrigation of the big summer garden.

THE CAMDEN COUNTY LIBRARY

Completed in mid-1976, this new library is already stopping traffic. Because of a very high water table, all three floors stand above ground level, but roof-top earth cover, and a three-story high earth berm on the cold north side, give it many of the advantages of in-the-earth construction. Solar equipment on the sloped south wall will supplement the building's more conventional systems.

Architect: Louis H. Goettelmann II. Consultant: Malcolm Wells

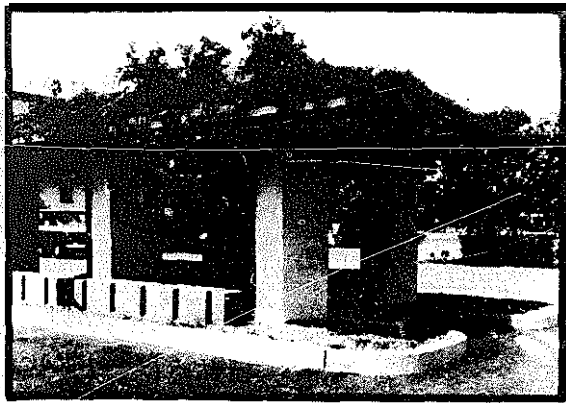

SHELTER PAVILION

Earth-covered bike shelter and walkway pavilion in this New Jersey parking lot hints at future parking structures.

and being based on better-than-usual earth studies, should be much safer than above-ground ones. Fires and tornadoes, of course, are much less menacing to these buildings.

4. Aren't underground buildings depressing?

Go back and read the accompanying article. You weren't paying attention.

5. Don't underground building destroy the very sites they're intended to save? Aren't underground streams affected, too?

First of all, we refuse to build in mature forests, on prime agricultural land, or on wetlands and flood plains. Our goal is to restore dying land. And, as for subsurface conditions, the underground movement in architecture is so miniscule it hardly poses a threat, but the day may come when it could. No building should be attempted without rather detailed studies of the subsoil conditions. Such studies can help prevent most subsurface damage. And it seems likely that by the time underground buildings become even a minor force on the construction scene the body of knowledge being built up around them should be adequate to prevent underground damage of the kind we've inflicted above ground.

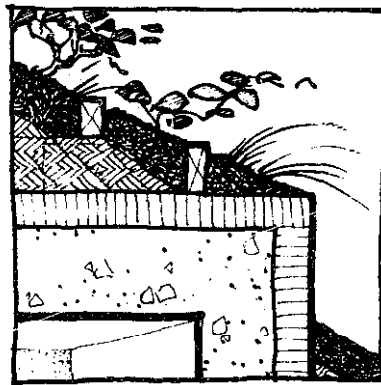
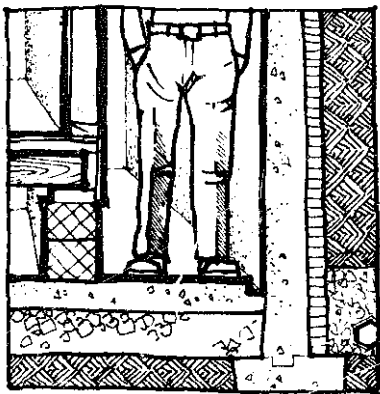

EROSION CONTROL

We've found that deep mulch, combined with temporary rattable step-curbs made of waste lumber from the building's construction, prevent all erosion, even in the heaviest downpours. Later on, deep root-mats take over the job the step-curbs started.

THE HOUSE-IN-A-VAULT APPROACH

Jay Swayze, of Hereford, Texas, has built a lot of underground houses. His approach: build a waterproof structural vault. His sunsets may be electronic but when World War III begins he'll have the laugh on all us windows-in-the-hillside people.

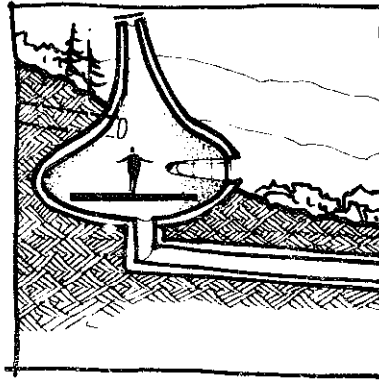

THE INSULATED EARTH POD (PROPOSAL)

We haven't had a chance to build one yet but all the indications say these cement onions, properly insulated and with earth pipes to temper both summer and winter air, can be tremendously successful. Cheap, too, if you build them yourself.

ANOTHER KIND OF MEGALOPOLIS (PROPOSAL)

Sun terrace housing, a garden outside every door, cars and warehouses tucked away inside the hill where they belong. Powered by the sun and wind, recycling their wastes, such cities will give us brilliant skies and sparkling rivers again.

6. How much earth do you put on the roof?

Plant experts told me that I could expect to grow any native New Jersey tree on my roof if I used about three feet of earth. My office has 6" of mulch on about three feet of subsoil. It is a rare winter here that drives the frost as deep as 18". Having tried different soil mixes and depths, I now favor lighter-weight gardens with more mulch. Generally, about 12" of mulch on, say, 18" of light-weight (earth + vermiculite?) soil seems to be a good compromise. But in any case you must remember to replenish the mulch, at least until luscious growth occurs. Mulch tends to decompose and disappear. (Ah, if only shredded paper didn't look so much like litter on the roof!)

7. Doesn't all this take a lot of land? If you can't build high-rise buildings where will you put all the people?

Earth-covered buildings are so quiet and so appealing they offer us a chance to build very dense housing. Some of the most densely-populated parts of the world (The Netherlands, Greenwich Village, etc.) are low-rise areas, for the most part. If this were just a new suburban fad we wouldn't be so enthusiastic about it. Gentle architecture has got to apply to city and suburb alike – and soon, too – if there is to be any hope of reversing this insanity we call architecture today.

8. Aren't underground building damp?

Yes, if their inherent characteristics are overlooked. Warm, moist summer air will drop its load of moisture on any cool surface, and underground buildings can have delightfully cool surfaces in the summertime. There are two choices: dry the air or warm the walls. The right answer depends upon too many factors to discuss here: building mass, local climate, type of occupancy, power sources, etc. – but that answer will almost certainly cost less in dollar and energy terms than any conventional architectural solution.

9. Isn't this a kind of non-architecture? Don't we need to have impressive and dramatic buildings?

If you want to see non-architecture, look around you. We've managed to pervert what was once a noble earth art. And as for impressive buildings, how would you rate a hillside ablaze with wildflowers – with windows looking out of it?

10. Isn't underground architecture more wasteful than above-ground architecture? Don't massive special structures use far more of our dwindling resources than light-weight structures do?

The subject at hand is life. To kill living land for 50 or 100 years by covering it with dead boxes and asphalt can in no way be favorably compared with building in such a way as to let the land not only survive but thrive for a century or two. And of course the energy comparison goes out of sight after ten or fifteen years. Don't be misled, the advantages of conventional architecture are just like the advantages of theft: large and immediate – if you disregard all moral considerations. Otherwise, there's no comparison. We've let a felony called conventional architecture go unpunished far too long. ■



Author Malcolm Wells

The Use of Earth Covered Buildings

This 1975 conference report is still the most comprehensive look at "underground" architecture. The various papers cover everything from history to legal aspects and insurance. There's a fine bibliography with a list of people working on underground structures. This and Malcolm Wells' book are required reading if you're tempted by the advantages of going below the surface.

—JB

The Use of Earth Covered Buildings
(No. 038-000-00286-4)
\$3.25 postpaid

from:
Govt. Printing Office
Washington, D.C. 20402



The list of the advantages of earth covered communities over suburbia is compelling: increased housing density (say 3 to 5 times most suburban developments), increased open space, increased green space, increased acoustic privacy, increased visual privacy, public facilities closer to most dwellings, shopping facilities closer to most dwellings, better opportunities for fully supported and convenient public transit, minimum maintenance to individuals and community, minimum operating expenses, conservation of resources, positive environmental impact relative to alternatives. I have learned that one always needs to add that one can also "see outside" of earth covered dwellings, indeed, such dwellings need not even be below grade.

IMPLICATIONS

I quote here from our "Abo Revisited" report.

Our original study concluded that the Abo Elementary School and Fallout Shelter was operating as an effective elementary school environment. Our present study confirms this finding.

1. The Abo School has been operating as an effective elementary school in Artesia, NM since it opened its doors in 1962. It continues to be an effective school and there is no evidence that the fact that it is underground and could serve as a fallout shelter and is so marked, designated, and named has had any detrimental effect on pupils attending that school.
2. Apparently other schools could be so constructed and if operated under similar conditions, would also serve as effective elementary schools.

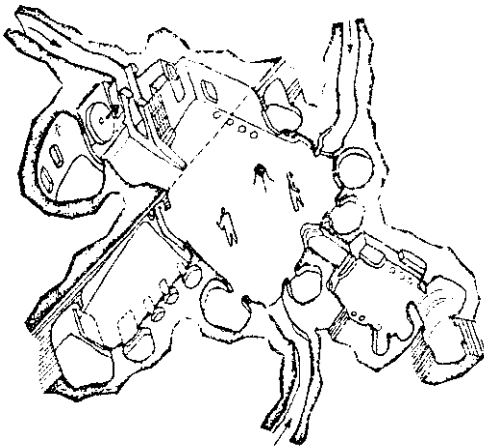

Axonometric section of the underground city in Cappadocia (Giovanni, 1971)

Underground building

There are two organizations concerned with "underground" building. If you are interested in keeping up with the latest developments and/or contributing your findings to the general knowledge, it might pay you to get involved.

American Underground Space Association puts out a publication for its members. It's called Underground Space Journal, runs about 50 pages, and is published bi-monthly. Membership and subscription is \$30.00 a year from:

*American Underground Space Association
112 Mines and Metallurgy
University of Minnesota
Minneapolis, MN 55455*

And there's the Clearinghouse for Earth Covered Buildings, an information exchange that publishes articles and books and promotes underground building. (Funded by the National Science Foundation [NSF]). You can get information from:

*Frank Moreland
School of Architecture and Environmental Design
University of Texas
Arlington, TX 76107
(817) 273-3083*

Development and Utilization of Underground Space

While some of us are exploring living underground, the heavies are looking at the possibilities of locating industrial activities there. This symposium specifically concentrated on utilizing exhausted limestone quarries underlying Kansas City, but of course much more general topics were discussed too. I suspect we are seeing the beginning of a trend. And I like reading about things I know nothing about.

—JB

Proceedings of the Symposium on the Development and Utilization of Underground Space

Truman Stauffer, Sr.,
Jerry O. Vineyard, Editors
1975; 196 pp.

\$7.75 postpaid

order:
No. PB252812
NTIS
5285 Port Royal Road
Springfield, "A 22161



IDEALIZED STRUCTURE SECTION SHOWING DIP OF BEDS OFF THE OZARK DOME.

There may be some medical surprises, such as the apparently low susceptibility of underground workers to the common cold and to other trivial ailments which account for so much loss of labor under normal working conditions. The seemingly small accident rate among underground workers (as distinct from the actual processes of mining) suggests that the subterranean location may provide some security from accident-proneness, by reason of the possible 'shielding' effects of the earth from general solar influences and sun-spot responses.

The Swedish experiences may be of the greatest value in providing comparative statistics between surface and sub-surface industrial operations, since I believe that their medical records are more extensive and more closely analyzed than those recorded in other countries.

The British medical records of wartime underground operations, both industrial and civilian should be reconsidered, together with those of certain spectacular conditions such as those which prevailed in the caves of Naples and in particular cities of Vietnam where whole populations were forced, suddenly, to maintain themselves as troglodyte communities.



The Skylight Book

There are a lot of nifty things you can do with a skylight, but if you don't wait to get wet, you'd better know what you are doing before you make the gaping hole in the roof. Absolutely everything you need to know is shown here, and very nicely too. Pass the saw, it's time we got some light into this dump!

—JB

The Skylight Book
(Capturing the Sun and the Moon, A Guide to creating Natural Light)
Al Burns
1976; 111 pp.

\$5.20 postpaid

from:
Running Press
38 S. 19th St.
Philadelphia, PA 19103
or Whole Earth

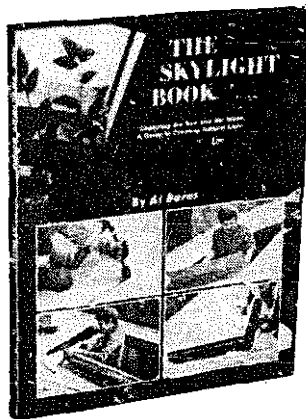

When you are working on your skylight, try to do as much as possible from the inside. If you are working above the attic you can build a work platform on the ceiling rafters. And if you are working in an open, high-ceilinging area within the house, you can build or rent a scaffold. Should you have to go over 10 feet high, I would recommend renting a scaffold. It is relatively inexpensive and makes the job much easier.

THE EXTERNAL MEASUREMENTS OF THE CURB SHOULD BE 1/4" LESS IN BOTH LENGTH AND WIDTH THAN THE INTERNAL LENGTH AND WIDTH OF THE PLEXIGLASS BO-1 SKYLIGHT

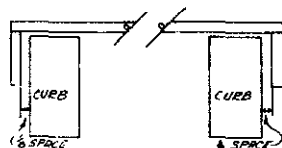

National Construction Estimator

The 1977 edition is \$7.50, and is well worth every penny to the owner-builder or carpenter/free-lance builder. The information provided allows estimating materials and labor costs. By using the wage rates table, labor costs can be converted to time estimates for skilled labor, thus, the owner-builder can calculate average time required for a specific job, he can use the information to decide whether to do the job himself or hire someone based on time/skill/cost/job desirability considerations. The materials list also provides a good survey of available alternatives. Information of this type is quite valuable to owner-builders as well as professionals. Quick cost comparisons of alternatives are quite easy.

—Hal Levin

National Construction Estimator

Twenty-Sixth Edition
Kirk Williams, Ed.
1977; 275 pp.

\$7.50 postpaid

from:
Craftsman Book Co
of America
542 Stevens Ave.
Solana Beach, CA 92075
or Whole Earth

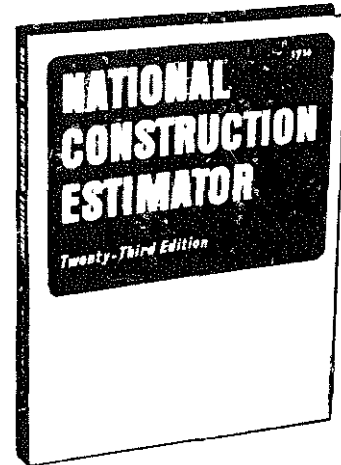

The percent saving in heat loss is five times greater if glass areas are reduced than would be achieved by increasing wall insulation.

Porous paving blocks

Providing hard surface paving yet still allowing natural water percolation to the soil below seems to be an impossible task. Yet porous paving blocks do just that. The porous paving at our office has been in use for three years now with no settling or water runoff headaches. Commercially, it's an expensive process to install, sometimes 6 times the cost of the typical bituminous asphalt, largely due to lots of labor. The technique is well adapted to cottage industry and do-it-yourself, so for many the costs could be slashed.

—David Deppen

Porous Paving Blocks

Information from:
Boiardi Products Corp.
211 East 43rd Street
New York, NY 10017
or
Hastings Pavement Co., Inc.
410 Lakeville Road
Lake Success, NY 11040

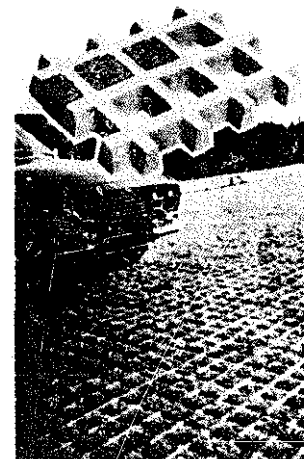

Ferrocement: Applications in Developing Countries

Though this book has been around for awhile, it has just come to our attention. Some of the most difficult technical problems for developing countries (or homesteaders) are solved using ferrocement technology. That technology is within the reach of many, as it is labor rather than capital intensive. The book is not a manual, but shows the possibilities as applied to food and water storage, boats and roofing. The food storage bins, for instance, can radically cut the 25% loss to rodents that is the general rule in many countries. Hollow ferrocement walls might be good solar storage?

— JB
[Suggested by Meredith Foyle]



Ferrocement: Applications in Developing Countries

National Academy of sciences
1973; 89pp.

Free

from:
Board on Science and Technology
for International Development
Office of the Foreign Secretary
National Academy of Sciences
2101 Constitution Avenue NW
Washington, D.C. 20418

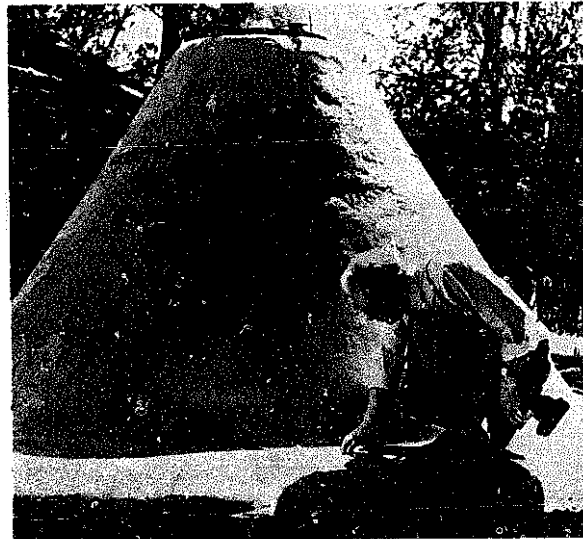

Severe floods on a village farm in Thailand floated this silo off its earth foundation, but it was reset, still dry inside and undamaged, when the floods subsided. This ability to resist vagaries of foundation conditions is an important characteristic.

In an airtight ferrocement bin, respiration of grain, or similar products, quickly removes oxygen from the atmosphere inside and replaces it with carbon dioxide. Any insects (adults, larvae, pupae, or eggs) or aerobic microorganisms present cannot survive to damage the stored product.

Inexpensive Evaporative Coolers

This is the kind of paper I like to see. The authors have done a really fine job of developing not only a cooler but the technique of making it and the technique of making the component dip-molded blocks as well. They note that the dip-molding process can be used to make water pipe too, which might be an answer to homesteaders faced with high pipe costs. They've also taken into account the weather, economic and social conditions that make an evaporative cooler practical or not. It's all worked out for very low-income situations and very unskilled labor. Good job! This report should be taken as a model of its kind.

— JB

Inexpensive Evaporative Coolers for Short Term Storage of Fruits and Vegetables

Bill Hutchinson and Roger Chuang
1976; 107 pp. (Xeroxed especially for CQ readers)

\$8.50 postpaid
from:
Bill Hutchinson
1004 Ruby
Arlington, TX 76010

The Dip-Molding Process for Block Manufacture

The procedure for making a block is straightforward. A wooden frame is made to support the block. The frame is smeared with grease, kerosene or used motor oil to prevent the block from sticking to the frame. Next, strips of burlap or a similar coarse cloth material are dipped into a watery mixture of wet cement and molded around the frame to the desired shape and thickness. Seams and irregularities are sealed by smoothing over with cement.

The molded block is then allowed to harden for several days. The block should be covered with large pieces of wet cloth or burlap. This will prevent cracking of the outer surface caused by rapid drying of the cement. After the block has set up, the frame is then knocked apart and the block is ready for use. The frame can be re-used.

The most promising block material was found to be Type I (general purpose) Portland cement.

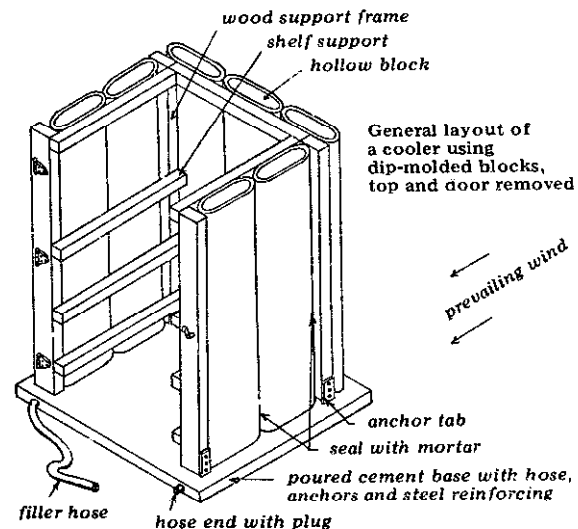

New Village Level Industries

The dip-molding process allows individuals to make their own blocks and coolers. More importantly, it enables unskilled people with little capital to start their own block and/or cooler manufacturing business.

In addition, the process can be used to make pipe. Pipe can be formed by wrapping burlap dipped in cement around a lubricated mandrel with a slight relief angle. If the relief angle and length of pipe are sufficient, the small end of one pipe can be fitted into the large end of another to act like a ball and socket joint.

Adobe News

Adobe is one of the best ways to build if you live where it is practical to do so. Not only is it esthetically pleasing, it makes use of local materials and is thus a fine example of resource-conservation. There's a bonus too: adobe lends itself well to "passive" solar heating and cooling schemes. (You use the house as both collector and storage instead of a mess of hardware.) Of course, there are books on the subject (CATALOG & EPILOG, pp. 102, 515) but the best way I know of to get a feel for the possibilities is to read this nifty paper. The articles treat both tradition and the experimental new with some of the most friendly real-people reporting I've seen.

— JB

[Suggested by Jon Davis]

Adobe News

\$8.00/year (6 issues)

\$1.50/single issue

from:
Adobe News
P.O. Box 702
Los Lunas, NM 87031

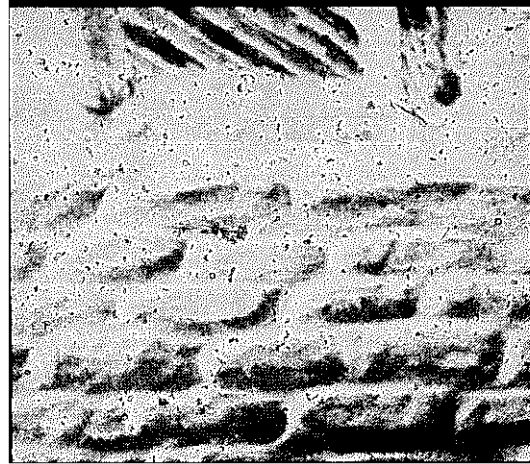
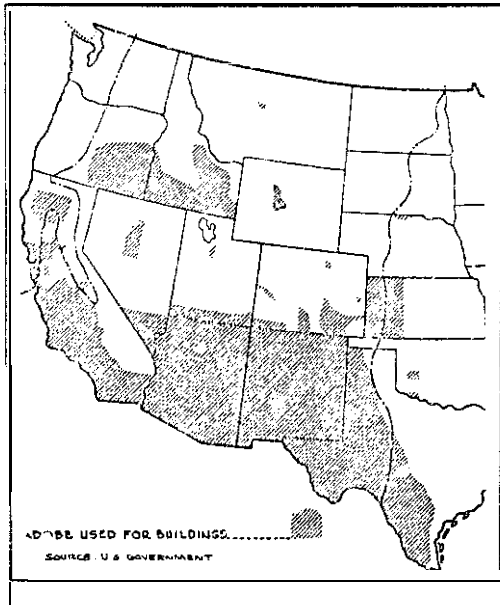

The warmth of adobe can be greatly enhanced by using a method of sealing interior walls which leaves the individual bricks visible while keeping them dust free. My husband devised an inexpensive easy method while building our house in Placitas. After laying the adobes one at a time ourselves we wanted to be able to see them on the inside instead of plastering over them.

The first step is to go over the walls with a claw hammer and define each brick by removing excess mortar. As you scrape, you also fill any gouges with mud. Then, go over the walls with a wet whitewash brush, brushing vigorously to smooth the surface and seal cracks and holes. On bricks which are sandy, this is all that need be done at first. However, our bricks had a high clay content and we found that they cracked badly after being brushed and dried. We found that adding a small amount of cement to the water being used to brush the walls cured the problem, while not enough cement need be used that it changed the natural color. The cement is not necessary if the bricks are sandy.

When the walls are thoroughly dry, we used a coat of an inexpensive logwood oil to seal them. The higher refined, more expensive oil will soak in rather than seal over the adobes and should not be used. We chose to leave the bricks their natural color, but should you prefer white or any other color walls, you can paint over them with any oil based paint.

Mud, Space & Spirit

There's a new book on Adobe too, a beautiful one involved with the idea of adobe. It's a good place to start if you're considering earthen construction.

— JB



Mud, Space & Spirit

Virginia Gray,
Alan Macrae and
Wayne McCall
1976; 95pp.

\$7.95 postpaid

from:
Capra Press
631 State Street
Santa Barbara,
CA 93101
or Whole Earth

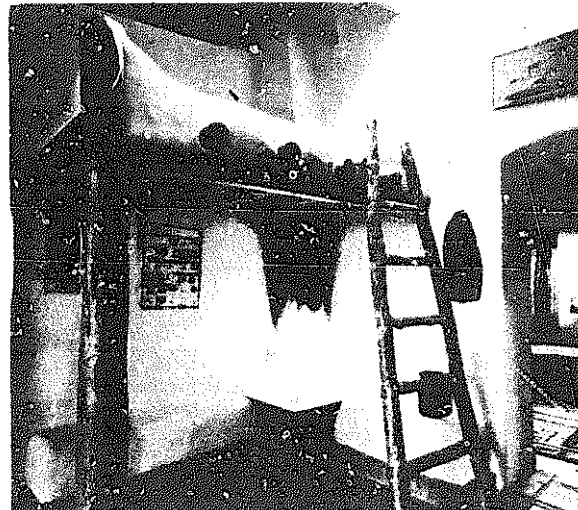

Homegrown Sundwellings

Peter Van Dresser is one of those men who have been telling us for decades that we must take care of our environment and be less wasteful. He's built one of the two oldest solar houses in this country. Age and frustration haven't slowed him down a bit, and he's fortunately outlived public indifference. This book chronicles some of his most recent explorations of the possibilities inherent in simple solar architecture fashioned from local materials. (In this case adobe.) It's not a manual, it's an attitude-adjuster. More good stuff from New Mexico.

— JB

Homegrown Sundwellings

Peter Van Dresser
1977; 135 pp.

\$5.95 postpaid

from:

The Lightning Tree
P.O. Box 1837
Santa Fe, NM 87501
or Whole Earth

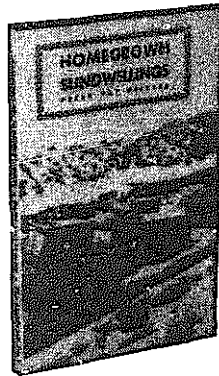

Over and above this generally accessible "book learning," however, there is — especially in rural and traditional New Mexico — an unusually widespread working familiarity with the realities of home construction using native materials at hand. There are many communities within which the building of a house is still very much a family affair, with several generations participating in the mixing and laying of adobe, the hauling in, barking and placing of vigas, and all the other steps in creating a habitation literally from the ground up. And this familiarity is being generously shared with new settlers in the region, many of whom have become skilled craftsmen and small building contractors in their own right.

The point should be insisted upon that domed, warped, hyperboloid and similar surfaces dear to avant-garde architects, which must at the same time be rain- and weather-tight, are very difficult to execute in low-energy indigenous materials. For their success they are dependent on the use of high-energy plastic membranes, sealers, foamed or sprayed fillers and coatings, aluminum extrusions, plywood and the like.

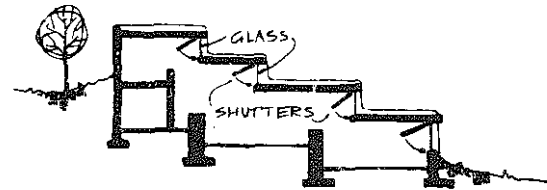

SECTION

North-South Oriented Direct Gain House

The Indian Tipi

There's only one book on Indian tipis because no one's had a hope of rivalling it. Here's its new edition, revised, expanded from 208 pages to 350 and welcome.

—SB

Indian Tipi

(Its History, Construction, & Use)

Second Edition

Reginald & Gladys Laubin
1977; 350 pp.

\$12.50 postpaid

from:

Univ. of Oklahoma Press
Sales Office
1005 Asp Ave.
Norman, OK 73019
or Whole Earth

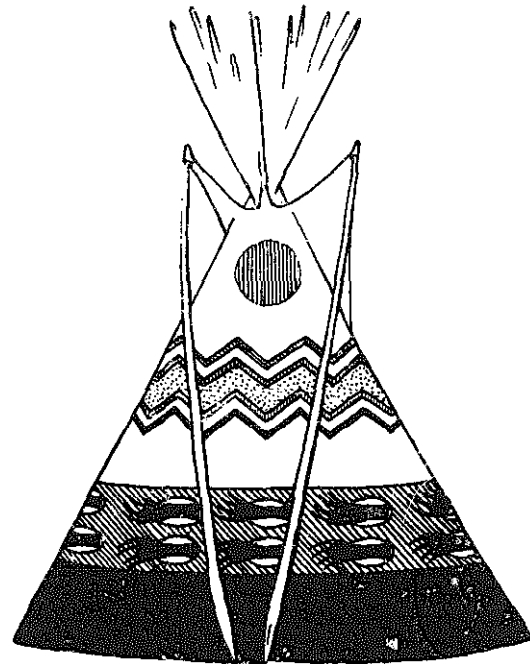
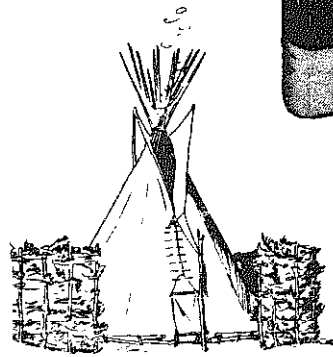
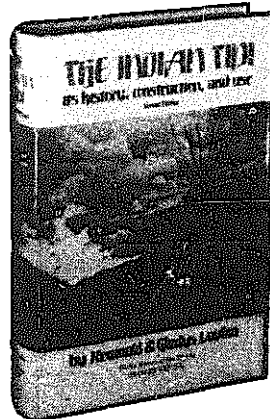

This is a bear medicine tipi. The red spot is the bear's den. Claws and tracks are on the trail at the bottom. The zigzags are lightning and storm, followed by the rainbow. The bear was the patron of wisdom, magic, and medicine. The Indians knew the bear kept well by eating certain herbs and roots. They followed him and watched him and learned much of their medicine from him. The Bear Spirit might be invisible, or he might appear as a huge bear or as an old man. Both the bear and the buffalo were patrons of courage, and Indians regarded it as high an honor to "count coup" on a grizzly as on an enemy. Big medicine, this tipi.

Living in One Room

Small is in fact Beautiful, or at least it can be if you're clever at using space. This happy collection of ingenuity shows what can be done. Some of the ideas border on being downright fiendish; disappearing kitchens and beds abound. Most rooms show that compact living need not mean lowered living standards. (We can vouch for that, we've been living in a 17-foot Airstream trailer, the Silver Turd, for 4 years now and like it fine.) It would be nice if the work shown here signifies the beginning of a trend away from Buick Architecture.

— JB and Kathleen Whitacre

Living In One Room

Jon Naar and Molly Siple
1976; 150 pp.

\$5.95 postpaid

from:
Vintage Books
455 Hahn Road
Westminster, MD 21157
or Whole Earth

Every component part in the London attic of consultant/designer Michael Wolff moves. The cotton-covered foam-rubber cushions that can be combined into a bed are also used to sit on around a low coffee table that moves on casters, as do the TV table, the hi-fi speakers (covered in white cotton for visual muting) and the cabinet to the right, which houses records and hi-fi equipment. The entire scene can be cleared in minutes for a party or a business meeting.

Painter Kas Zaphus created this ingenious dish drainer to drip water directly into the sink, via a shaped rubber mat, saving valuable space and eliminating the bother of sponging the counter.

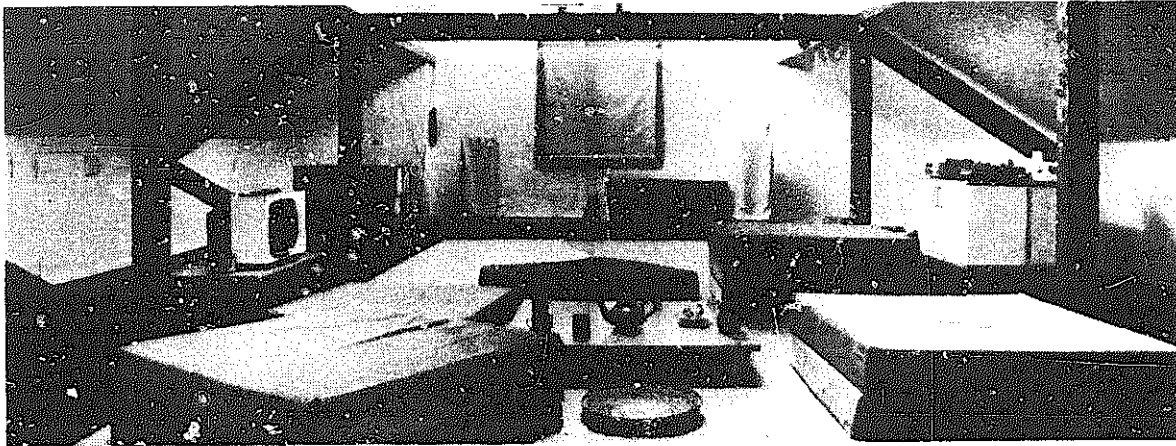
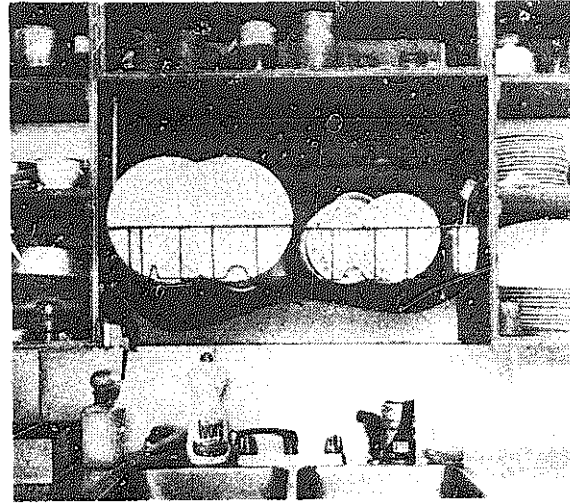

The Spacemaker Book

Another excellent collection of ideas intended to make living in relatively tight places seem less tight. The ideas here are less oriented towards one-room living than towards general canny-ness in space use and visual spaciousness. Most of this will be old hat to mobile home dwellers and to Europeans (especially Scandinavians) who have been doing this sort of thing for years. Replace expensive, resource-eating volume with compact cleverness. Exceptionally good drawings.

—JB

The Spacemaker Book

Ellen Liman
1977; 120 pp.

\$9.95 postpaid

from:
The Viking Press
299 Murray Hill Parkway
East Rutherford, NJ 07073
or Whole Earth

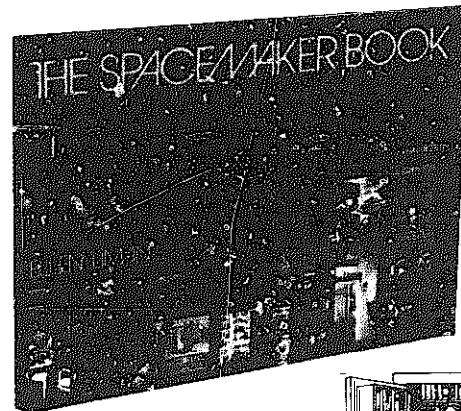

mirrored windows

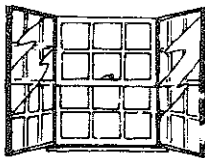

a hay effect

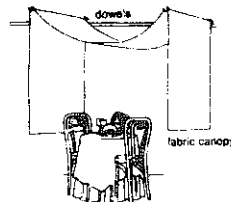

fabric canopy

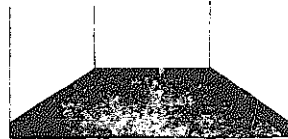

to enlarge floor, paint baseboard same color as floor

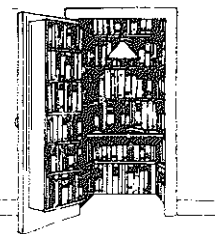

library closet

The Mariner's Catalog Volume 5

Mariner's Catalogs are most commonly referred to in an indignant howl, e.g., "Where the HELL is my Mariner's Catalog?!" (Matter of fact I can hear Stewart right now). About the only way you can keep one is to nail it to the table. Like its well-reputed predecessors, Volume 5 accompanies the items or phenomena with a fine, Maine-flavored personal commentary that's hard to resist. Though it tends to be expensive, yacht equipment is often more efficient and compact than landlubber hardware. Some items can be happily adapted to "living small" uses. As is their custom, there's no duplication of previous Mariner's Catalogs, which are still available at their original prices.

—JB

The Mariner's Catalog Volume 5

George Putz & Peter Spectre, Eds.
1977; 192 pp.

\$7.95 postpaid

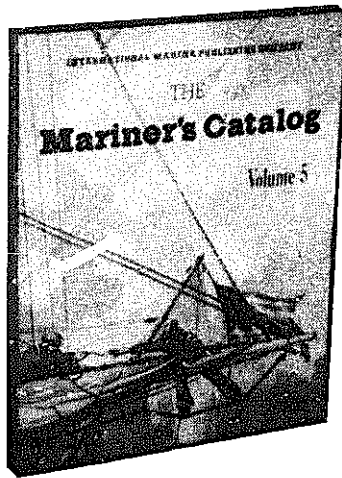

Volume 4

George Putz & Peter Spectre, Eds.
1976

\$5.95 postpaid

Volume 3

George Putz & Peter Spectre, Eds.
1975

\$5.95 postpaid

Volume 2

David R. Getchell, et al.
1974

\$4.95 postpaid

Volume 1

David R. Getchell, Ed.
1973

\$4.95 postpaid

All from:
International Marine
Publishing Company
21 Elm Street
Camden, ME 04843

And if ratcheting two feet of bit through oak from a location six inches off the floor or out from the wall is not your cup of kumquat extract, here's a handy item from Miller's Falls:



Miller's Falls Company
57 Wells St.
Greenfield, MA 01301

Going to sea has all the advantages of suicide without any of its inconveniences.

—William McFee

Dutch craft are reliable and forgiving. They sail and ground on their bottoms and provide tremendous room for their length. In all respects, leeboards are superior to centerboards. That is not an iconoclastic remark of "an inspired but controversial" designer in an "interesting if offbeat" publication; it is a fact. Leeboards do not compromise the strength or add to the cost of the keel. They slip and cavitate less. There are no trunks to collect rot, rocks, and sticking boards, and the cabin is not suddenly divided into his and hers. You can fix them without bringing catastrophe down on the season, and they can be built as strongly as desired — no thickness limits — and you can see the pennant and fittings entirely. So there!

Manufacturing many of the traditional models of Dutch craft in both steel and wood is:

Koojiman en de Vries
Deilsedijk 62 a
Deil a/d Linge
Holland

Anyway, we were jovially "filling" our canvas, as per instructions, with five coats of marine paint — two primers and three finish coats — when some clerical type in the company mentioned that by so doing we were doubling the *weight* of the boat and the *cost* of the boat. "Cripes almighty," somebody said reverently. "we're 'sposed to finish the boat, not the customer!"

And then some bright friend says something like, "Well yer such a dimwit, ya deserve it." He, not knowing that we are only in a dimwit disguise, was promptly cajoled into revealing this awful secret: AIRPLANE BUTYRATE DOPE!

Of course! What idiots we had been! Henceforth, we shall go to our local small-craft airport, locate the supplier of aircraft dope, and (Kapowee) a light, smooth, easy-to-apply, quick-drying, noncracking, tough, controlled-shrinkage surface for kayaks and canoes will be gained.

Colored dopes run about \$20 per gallon. Clear dope is less than half that. You can also get thinners, retarders, fungicides (fungus is always a problem on the canvas undersides in marine craft), and related materials. We received our information from:

Van Dusen Aircraft Supplies
P.O. Box 232
East Boston, MA 02128

Check your local airport. Can you imagine a two-seat bi-plane trying to get off the ground filled and sheathed with *marine paint*?

Fredson Trailer Supply

Working with owner-responsive power sources or attempting to "live small" can be frustrating when it comes to hardware: you either can't find any, or you are stuck with the outrageously expensive yacht equipment that is much over-designed for land use. A useful compromise can be found in recreational vehicle hardware, but it is often hard to find too, especially in an array that makes a choice possible. This catalog presents an array that makes a choice possible, to say the least. If you've "always wondered where to get one of those" . . . try here.

—JB

Fredson Trailer Supply
Recreational Vehicle
Parts & Accessories
(Catalog)
1977

\$1.00 postpaid

from:
Fredson Trailer Supply
815 N. Harbor Blvd.
Santa Ana, CA 92703

HELLSTAR HOT WATER HEATER

For Vans, Campers, Motor Homes, and Boats

The method used to heat the water is a quick recovery heat exchanger running off the vehicle's coolant system. Installation requires the insertion of two "T"s in the heater hose lines to the inlet and outlet fittings of the heat exchanger coil inside hot water tank. The inner tank is all aluminum. Surrounding this tank is 1 1/4" of fiberglass and foam insulation. The outer shell is of steel construction and has a beige, baked enamel finish. This heater may be installed in conjunction with any hand or electric water pump or selector valve that will withstand the temperature involved.

HW3V

GENERAL SPECIFICATIONS:

Capacity: 3 gallons either model

Heat exchanger output: 5000 plus BTU's/hr.

Recovery Time: 15 min. to heat from water
60 degrees F to 140 degrees F. Maximum
water temperature normally reached --
195 degrees F.

10-1103-00 HW3V Vertical Water Heater
(20.0 lbs) \$74.95

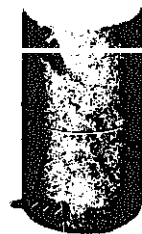

Home Is Where You Park It

What's it like to live only in an "RV" (recreational vehicle)? Thousands of people do these days. Some are retired, some are "boomers" who work here and there as they go. None have a home base. Their travel trailer or motor home (not mobile home) is IT. So what about mail, medical help, taxes, parking, schools for the kids, attack, banking, credit, appliance warranties, driver's license and insurance? What kind of RV is best for you? How much does living this way cost? Kay Peterson answers all the above questions and about 200 more as she describes life on the road. Having done this bit myself, I can vouch that her advice is pretty good. If you're thinking of living this way, giving her a listen will save you many hassles.

— JB

Home Is Where You Park It

(A Guide to RV Living as a Life-Style)
Kay Peterson
1977; 132 pp.

\$5.95 postpaid

from:

Follett Publishing Company
1010 W. Washington Blvd.
Chicago, IL 60607
c Whole Earth



Day-to-day living costs are much less when you live in an RV. Because a trailer occupies about one-tenth the interior space of a house, heating and electricity cost less. We use a small portable electric heater to supplement our propane furnace because we've found it is cheaper to heat with electricity than with propane gas. The cost of propane has soared since the energy crisis started in 1973. It is expected to continue to rise along with the cost of gasoline, electricity, and fuel oil. But one of the advantages of living in an RV is that you have wheels under your home. You don't have to stay in cold climates!

Living Aboard

If you want to keep your simplicity voluntary, there's nothing like a small mobile home on a large mobile environment to enforce it. This is a dense practical guide to boat living, the best of its kind.

— SB

Living Aboard
(The Cruising Sailboat as a Home)

Jan & Bill Moeller
1976; 299 pp.

\$12.50 postpaid

from:

International Marine Publishing Co.
21 Elm Street
Camden, ME 04843
or Whole Earth

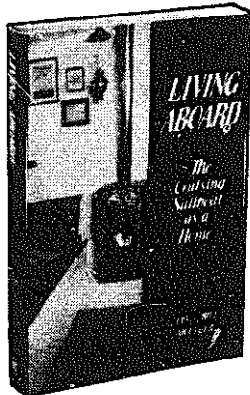

One of the best ways to save money is to try to avoid buying supplies and equipment in marine stores. There is much you can't get anywhere else, but there is more that you can. Stove alcohol is a good example. When we were new live-aboards, we asked the price of a gallon in a general hardware store that also handled a few marine supplies. The clerk consulted a list and said, "Marine alcohol is \$4 a gallon." We asked him if he had any alcohol that was not designated "marine." He said he had several brands. We chose the least expensive of all, which was then \$2 a gallon. The label listed its many uses, one of which was stove fuel. In all the years we had an alcohol stove, we never used "marine" alcohol and we never had any problems. Neither will you, if the label on the alcohol you buy lists stove fuel as one of its uses.

Houseboat

The fluidity (and difficulty, leading to attentiveness) of a water environment seems to encourage fluidity of house design and life design for water dwellers. I've been waiting years for a good book on the subject. This one partially satisfies the want with a bonus of careful history and evocative color photos, but no how-to. The book I want now is a years-of-research, world-wide, anthropologically and engineeringly serious VOLUME. Get on it.

—SB

Houseboat

Ben Dennis and Betsy Case
1977; 128 pp.

\$9.95 postpaid

from:

Smuggler's Cover Publishing
107 W. John St.
Seattle, WA
98119

or Whole Earth

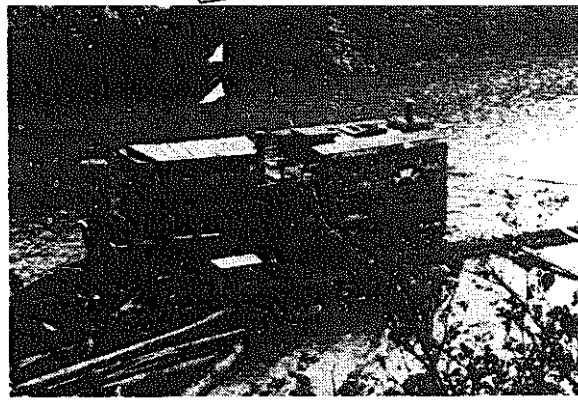
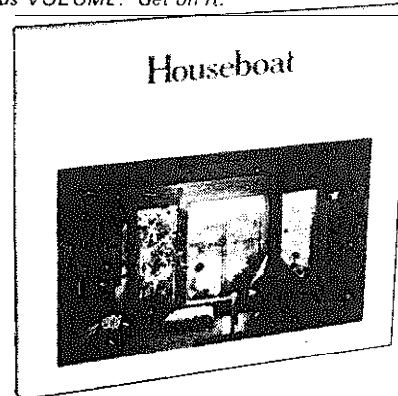

Wind Vane

"Seasteading?" Yup. That's living on your boat. This lively quarterly is written by seasteaders for seasteaders, with increasingly useful reader response being the most interesting feature. I harbor (so to speak) unrealistic dreams about living on a boat, and this sort of publication tends to encourage total derangement.

— JB

Wind Vane
(The Bulletin of Seasteading Self Sufficiency Afloat)
Jo Anna Brown, editor

\$6.00 /yr (4 issues)

\$7.00 /yr first class

from:

Wind Vane
241-K West 35th St.
National City, CA 92050

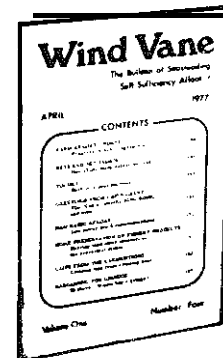

Bargaining is not the way of retail business everywhere . . . but it is the way in enough places so that you must be adept at it if you would go the seasteading route. . . . It isn't just a quaint way of doing business. It's the real thing and you spell it \$\$\$. . . money in your jeans when there might be none. The first thing you must get over is the idea that an object has one and only one fair price. That's not true anywhere. A fixed price means that someone has enough clout to fix it. Value, on the other hand, is a function of the situation.

Nets
Grid Shells
Adaptable Architecture

New books from the Institute for Lightweight Structures (directed by Frei Otto) are always cause for rejoicing. I continue to marvel at the competence shown by these people; they are certainly the model for hard work and disciplined investigation. These books are done in the highly detailed beautifully executed manner [and with the detailed biological inspiration —SB] we have come to expect from Herr Otto and crew. (CATALOG, p. 105, EPILOG, p. 524.)

Nets includes every kind of net you can think of, including anti-submarine nets and spiderwebs, with the theory, construction techniques, and architectural possibilities of nets. Otto's Montreal and Munich structures are shown in detail. Grid Shells explores the exciting potential of very thin stiff structures based upon the concept of dangling a net-like structure, locking it rigid, and then flipping it over for use as a building. Adaptable Architecture is a direct socially oriented discussion of non-monumental architecture that is able to change with the desires and needs of the people who must use it.

The entire group of IL books will noticeably dent your savings account, as well as feed and inspire your mind. Your local library might go for the whole set.

— JB

Nets (IL8)
 Klaus Bach, editor
 1975; 430 pp.
 11" English/German)
\$32.50 postpaid

Grid Shells (IL10)
 Jurgen Hennicke and
 Eda Schaur, editors
 1974; 346 pp.
 (In English/German/
 Japanese)
\$27.50 postpaid

**Adaptable
 Architecture (IL14)**
 Bernd Baier and Stefan
 Meyer-Miethke, editors
 1975; 335 pp.
 (In English/German)
\$20.00 postpaid

all from:
 Wittenborn Art Books & Co.
 1018 Madison Avenue
 New York, NY 10021
 or Whole Earth

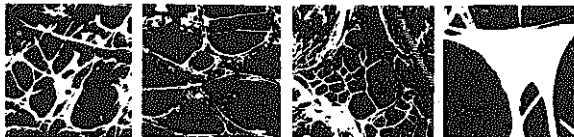

from Nets

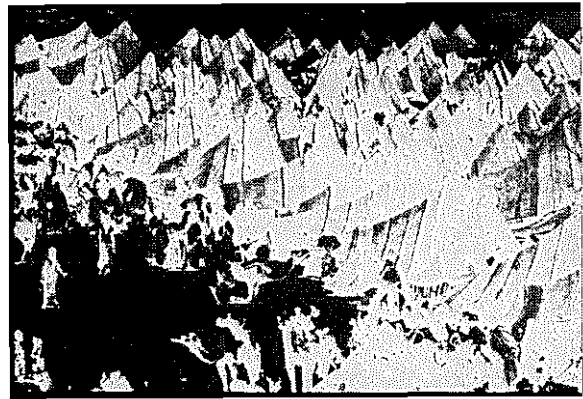

from Adaptable Architecture

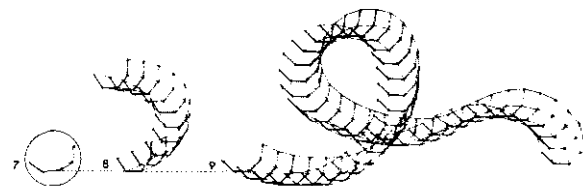

from Grid Shells

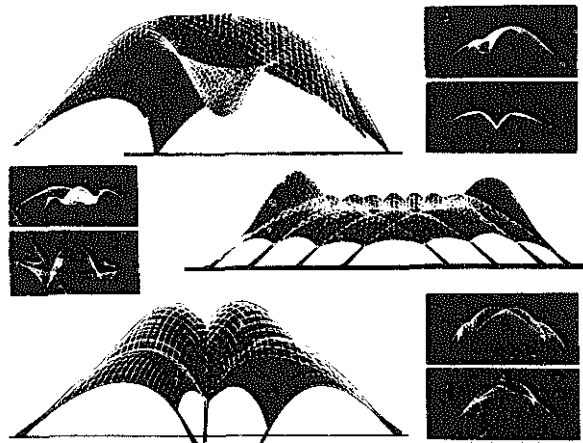

from Grid Shells

Pneumatic Structures

The modern Big Bad Wolf doesn't huff and puff, he pulls the plug on your blower or maybe takes a bite out of your dining room wall. It wouldn't be the house coming down that would get you, though. Pneumatic structures have advanced far beyond being threatened by simple failures. They've gone beyond the pool-cover shape too, as this exciting presentation shows. And the presentation goes beyond photographs (707 of them) by including pattern theory and an explanation of how to calculate stresses. This is the most thorough book on the subject I've seen. (Something pneu on every page, har har.)

— JB

Pneumatic Structures
 Thomas Herzog
 1976; 192 pp.
\$30.00 postpaid
 from:
 Oxford University Press
 16 - 00 Pollitt Dr.
 Fair Lawn, NJ 07410
 or Whole Earth

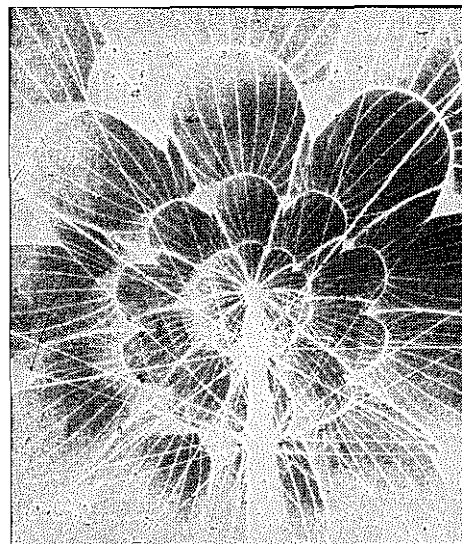

Tent Works

Bill Moss has been experimenting with tension structures on this side of the Atlantic for more than 20 years. He's most famous for the still-excellent Pop Tent (CATALOG, p. 263), but he has done many other designs as well. What interests me most are his recent efforts towards developing fabric structures that feel more like buildings than tents. The expertly patterned contours spill wind and give remarkable rigidity to the assembly as well as considerable beauty. I see a great potential in these: not only are they materials-efficient, they can be easily adapted to a wide variety of climates. They can be shaped to trap or repel solar energy, and can be made to serve as water-catchers. The portability is obvious. Hold-downs can be waterbags for thermal mass. Additions are easily made or subtracted.

Moss is showing the way with a series of commercially available designs ranging from backpackers' equipment to veritable cottages. I view these as the first of a new shelter form.

—JB

Tent Works

Catalog

Free

from:
Tent Works
Camden, ME 04843

Optimum 200
\$960.00
plus shipping

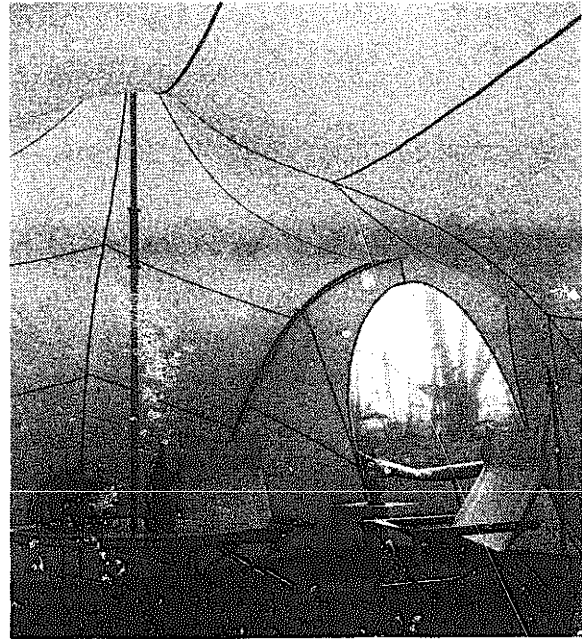

Tested in the Middle East for durability, the Optimum 200 withstands high winds. The optional liner adapts the shelter to a wide temperature range. The Op 200 is cotton, with a vinyl-coated nylon floor. Its three alcoves contain almost 200 square feet of floor space. An adjustable center pole provides ample standing room and increased stability. Two large windows and a door, covered in fine nylon mesh, make the Op interior light, airy and insect-proof.

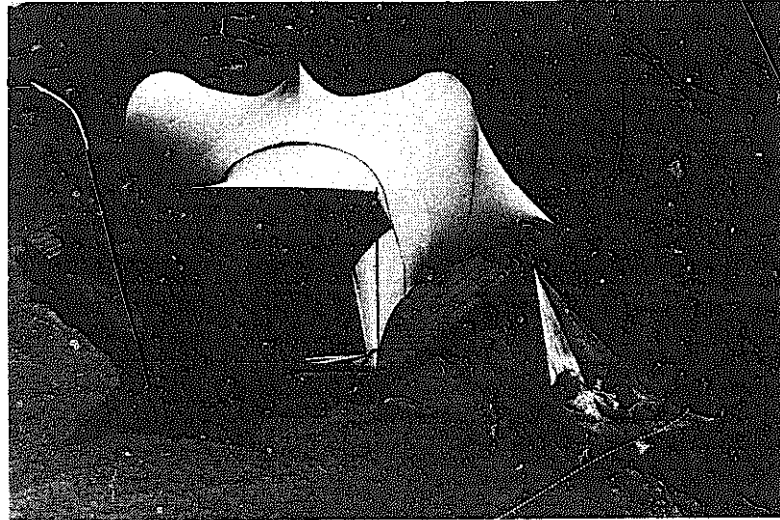

"We were experimenting with tents for Arab families to live in. Tents are part of the Arabic way of life. My tents are based on prehistoric Arab tent structures, wedded to American materials and my own engineering know-how."

"It's a very basic concept," Mr. Moss explained, that he borrowed from traditional Arab-style tents. "The two or three layers of loosely woven fabric traps the heat, thereby insulating the interiors."

Mr. Moss is using all-cotton duck fabric for the prototype desert tent because of the Arab preference for natural materials. "They call nylon plastic," he said, "which it is. Traditional Arabic tents were made of thickly woven wool, which expands and contracts with the weather." In rainy weather, the fabric contracts and becomes waterproof, in dry weather it loosens for air circulation, Mr. Moss said.



Barns, Sheds and Outbuildings

Old-timers to learn from are getting hard to find but they're not all dead. This one, born in 1881 is still alive and kicking. He knows about how to build an ice-house, a cool-room, and a Swiss birdhouse, among other things. Root cellars too. Though the book is intended as an instruction manual of basic designs, I found it reasonable to sit right down and read the whole thing through as if it were a novel, which it sort of is. The pay scales are a little off for today's labor market, though; a dollar a day is what they paid then.

—JB

Barns, Sheds and Outbuildings

Byron D. Halsted, Ed.
1881, 1977; 240 pp.

\$6.95 postpaid

from:
The Stephen Greene Press
P.O. Box 1000
Fessenden Road
Brattleboro, VT 05301
or Whole Earth

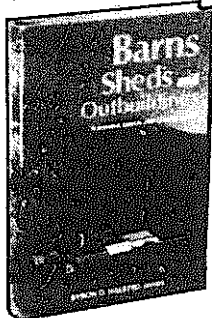

Ice should be cut with a saw, not with an axe, into blocks of regular size, so that they will pack into the ice house solidly and without leaving spaces between them. If cut in this manner, ice will keep perfectly well, if not more than three inches in thickness; but a thickness of six inches at least is preferable. It should be cut and packed in cold, freezing weather, and if, as it is packed, a pailful of water is thrown over each layer to fill the spaces between the blocks, and exclude the air, it will keep very much better than otherwise. For a day or two before the house is filled, it is well to throw it open in order that the ground beneath it may freeze, and it may be left open for a few days after it is filled, if the weather continues cold. The ice house should be finally closed during cold, dry weather.

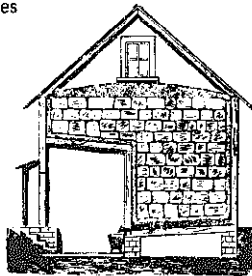
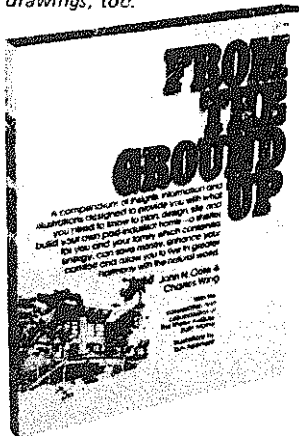

FIG. 100.—ICE HOUSE AND REFRIGERATOR.

From the Ground Up

After the first wave of books on a given subject a host of imitators usually appears offering little improvement other than an occasional gimmick. The gimmick in this book on post-industrial home-building is worth checking out: the authors have included a quickie course in structural principles. They are also good on frost heaving, selection of wood, and other arcana that is very good to know but that is usually left out of similar books. They want you to know why you're being told to do it that way. Nice drawings, too.

—JB



From the Ground Up

John N. Cole and Charles Wing
1976; 244 pp.

\$7.95 postpaid

from:
Little, Brown & Co., Inc.
200 West St.
Waltham, MA 02154
or Whole Earth

Farm Builder's Handbook

How far is it safe to span with 2 X 10 floor joists? Where do you find out stuff like that? Here. But be warned that this is not a build-your-own barn book. The author assumes that you already know how to build. This book sets safe standards for farm structures where usual city codes don't apply. Even if you don't follow his advice, his numbers will be an indicator of how far you can stray and still be safe. The book is particularly good for figuring pole type buildings.

JB

Farm Builder's Handbook

(Second Edition)
R. J. Lytle et al
1973; 264 pp.

\$20.00

from:
Structures Publishing Co.
Box 423
Farmington, MI 48024
or Whole Earth

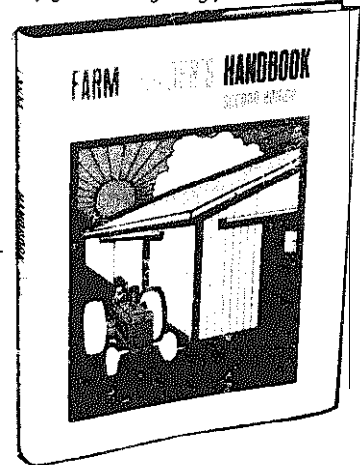

FINK



CAMBERED FINK



UMBRELLA



SCISSORS



FLAT TOP

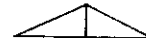

KINGPOST



WARREN



MONOPITCH



HOWE



GIRDER



SINGLE SLOPE

Ideas for All Around the Farm

What American farmers tinker with when they're not busy feeding the world. Successful Farming magazine collected these suggestions from farmers over the years. 1250 handy ideas and 540 illustrations showing down home engineering and "making it work right" creativity.

—Paul Kokesch

Ideas for All Around the Farm

(Second Edition)
Editors of
Successful Farming
1974; 98 pp.

\$2.00 postpaid

from:
Successful Farming
Box 384
Des Moines, IA 50336
or Whole Earth

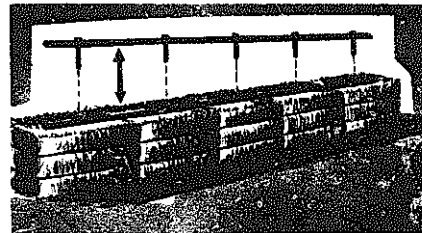

I make bale stacks stronger by using different lengths of pipe with holes drilled at intervals and long 1/4" bolts fastened in them. With these pipes at different levels in the stack, I can make bigger stacks. Bales are held tightly together keeping out rain and snow and there is less spoilage.

The Green Wood House

Unseasoned rough cut wood is available almost everywhere with a bit of searching, it is dirt cheap, and because you lose nothing to the planer it is stronger than dimensional lumber from the retail yard. This book tells you how to build with green oak for much less than you would ordinarily pay for spruce or fir. It contains specially formulated joist tables for hardwood, and clearly describes framing and construction techniques, which take advantage of oak's strength. Larry Hackenberg has also devised nailing methods and schedules that accommodate the natural shrinkage of unseasoned wood so that the lumber does not split or crack while drying and the wood draws together as it contracts.

Although some of the architectural drawings are not as clear as they might be (particularly the floor plans) the general approach to design seems to have been influenced by Ken Kern and features an open use of space with good convective patterns. The photographs illustrate an imaginative use of the texture and solidity of the building material. This is the only book I know of that even mentions the peculiarities of building with rough sawn green lumber. The perfect companion for an Alaskan mill.

—Len Gilday

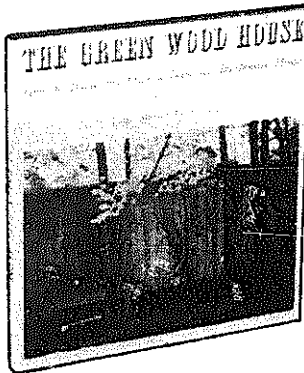

The Green Wood House
(How to Build and Own a Beautiful, Inexpensive House)
Larry Michael Hackenberg
1976; 135 pp.
\$4.95 postpaid
from:
The University Press of Virginia
Box 3608
University Station
Charlottesville, VA 22903
or Whole Earth

Always pay for your lumber with cash. Backyard sawmills, especially, often distrust checks. Never ask to have lumber on credit or make only a partial payment. These mills are not geared up for retail trade, and they often don't have the bookkeeping systems to keep up with small accounts. Remember this is not a retail operation — he is doing you a favour to sell you the lumber.

A house should be designed not for what your life is but, rather, for what you want it to become.

Golden Rule Number 1: Never use lumber that is wider than 6 inches. Obviously, the narrower the piece of wood, the less likelihood of finding extreme mixed graining. However, never use less than 1" thick lumber.

Golden Rule Number 3: If you are not sure how many nails to put in a board, always put in too many rather than not enough. Nail the hell out of everything. If it moves, kiss it, if it doesn't move, nail it, except larger pieces of wood: 4 X 4 and larger, especially if these members are columns which carry load. Nails in these situations will tend to encourage excessive checking. It is better to carriage-bolt heavy structural members together and to nail only as few times as absolutely necessary.

Each nail must be driven at an angle of 60° to 70° up from the face of the board and pointing toward the edge of the board. This is very important because it allows the board to shrink and pull the nail slightly without splitting the board in the center. If the nail is perpendicular to the face, the nail will hold so tightly that as the board shrinks it will pull itself apart in the middle and leave big ugly cracks.

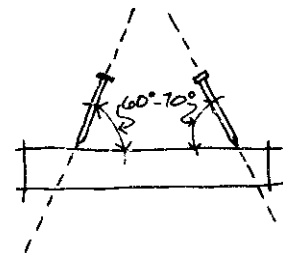

Wood Handbook

Do you really know the best way to "toe-nail"? (I didn't either.) What formula do you use to calculate the load-carrying ability of a stressed skin plywood floor? Is it safe to use dead wood for structural parts? Do you think you know it all? Well a quick look in this authoritative handbook will illuminate your ignorance and show you the stuff you need to know about wood and how to use it. Not an ego-book either; there's 60 years of Forest Service laboratory tests behind the recommendations. Everything, and I mean everything is covered right down to the last splinter.

— JB
(suggested by Carl Zipper)

Wood Handbook
(Wood As An Engineering Material)
U.S. Department of Agriculture Forest Service
1974 (updated & revised);
415 pp.
\$7.85 postpaid
from:
U.S. Government Printing Office
Superintendent of Documents
Public Documents Dept.
Washington, D.C. 20402
or Whole Earth

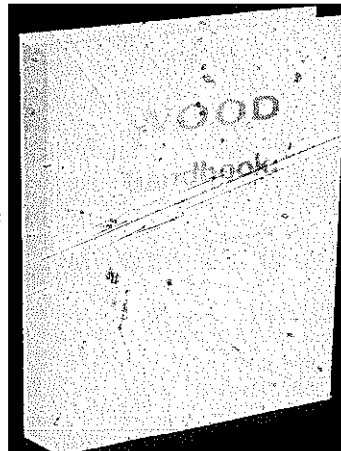

Tests show that the maximum strength of toenailed joints under lateral and uplift loads is obtained by (1) using the largest nail that will not cause excessive splitting, (2) allowing an end distance (distance from the end of the attached member to the point of initial nail entry) of approximately one-third the length of the nail, (3) driving the nail at a slope of 30° with the attached member, and (4) burying the full shank of the nail but avoiding excessive mutilation of the wood from hammer blows.

Recommended nailing methods for various types of wood siding.

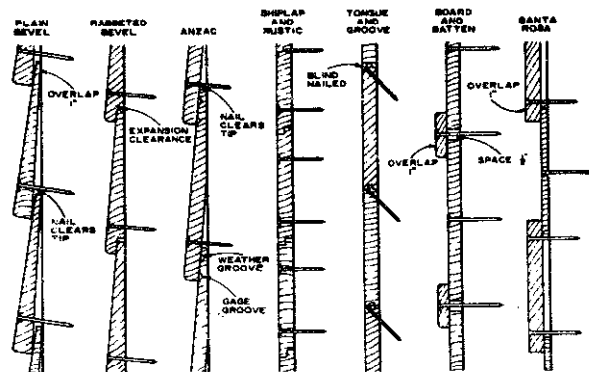

The Timber Framing Book

Timber framing is not the 2 X 4 bit, it's framing up with big stuff buttoned together with variously made joints such as mortise-and-tenon. It's a good way to make a building, and a good way to make the strong friendships that seem naturally to arise among those working together. . . timber work needs people power to erect the weighty parts. This book is extraordinarily good in every way. In fact, I can't recall ever seeing a book on any subject that was so easy to understand. The drawings by Linda Foss deserve special mention because after you see them, you really know how to get cuttin'. Last but not least, these fine people published the whole thing themselves, thus insuring that nothing got lost in the translation. And nothing did.

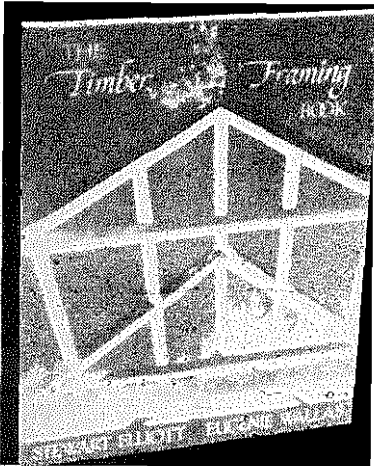

— JB

The Timber Framing Book
Stewart Elliott and Eugenie Wallas
1977; 170 pp.

\$9.95 postpaid
from:
Housesmiths Press
P.O. BOX 416
York, ME 03909
or Whole Earth

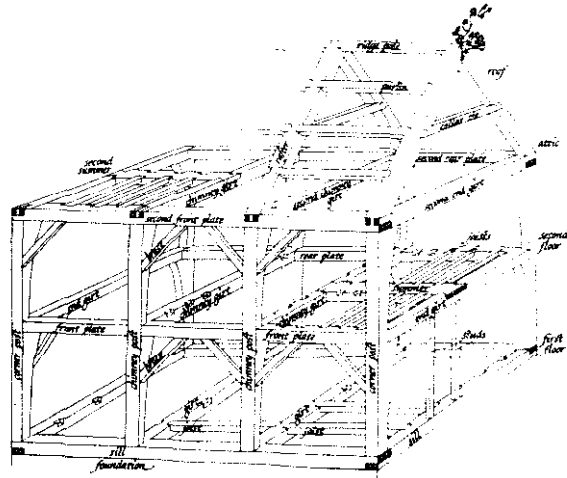

The final step for preparing any tenon to be inserted in a mortise is to chamfer, or shave off, the edges of the tenon. You should do this as a precautionary measure, since it is difficult to pull a joint apart once it is assembled. The tenon might not fit because of some small piece of wood left in the bottom of the mortise. It can be disheartening to see how much trouble one small piece of shaving, or a ragged edge can cause.

“Corners have been “knocked off”
CHAMFERED

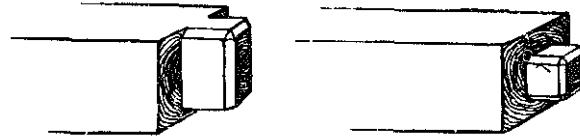

“All together girls ... Hup!”

Stone Masonry

Would you believe that the best most comprehensive book on building with stone would have Ken Kern (of The Owner-Built Home) involved in there someplace? Well, the old master is at it again (with worthy friends) and the result is a joy to behold. As you might expect, esthetics is held to be as important as structure. Also expected and delivered are chapters on both dry and mortared technique, facings, and formed work. With the renewed interest in building with natural materials, this is all just in time. With photographs of everything. And these guys have more books coming in this series.

— JB

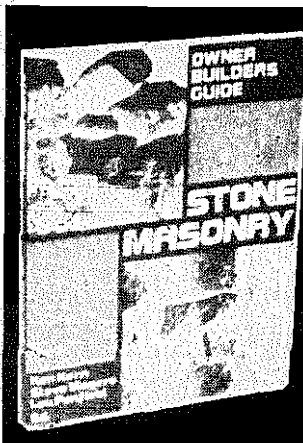

stone Masonry
Ken Kern, Steve Magers,
LO Penfield
1976; 192 pp.

\$6.00 postpaid
from:
Owner-Builder Publications
Box 550
Oakhurst, CA 93644
or Whole Earth

Modern Carpentry

This is the text that union carpenter apprentices use — a good book to go along with Ken Kern's The Owner Built Home and Rex Roberts' Your Engineered House (CATALOG, p. 94).

—David Rogers

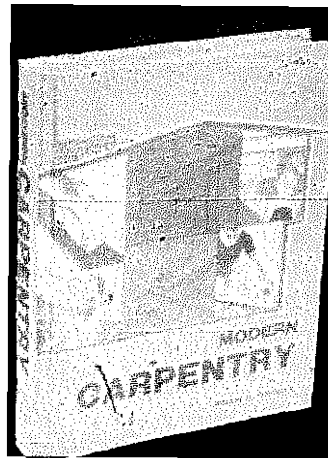

Modern Carpentry
(Building Construction details in easy-to-understand form, Willis H. Wagner 1969.1976; 492pp.

\$11.92 postpaid
from:
The Goodheart-Wilcox Co., Inc.
123 West Taft Drive
So. Holland, IL 60473



Preventing drip from gable. A length of beveled siding gives an inward tilt to the shingles.

Country Comforts

"Designs for the Homestead" is the subtitle of this very fine presentation of designs for a wide variety of homestead needs as diverse as outdoor hotweather cook stoves and augers for making wooden waterpipes from logs. The designs are exceptionally well described with text, clear drawings and (a flourish of French horns please) photographs! This means, folks, that we have here real live designs actually done and proven, at last. Not only that, but the work has obviously been done by people that it would be nice to know. The book has been done by them too. It would be possible to pick a nit here and there, but on the whole this book sets a new standard for its breed.

—JB

Country Comforts
(Designs for the Homestead)
Christian Bruyere and Robert Inwood
1976; 237 pp.

\$6.95 postpaid

from:
Drake Publishers
801 Second Avenue
New York, NY 10017
or Whole Earth

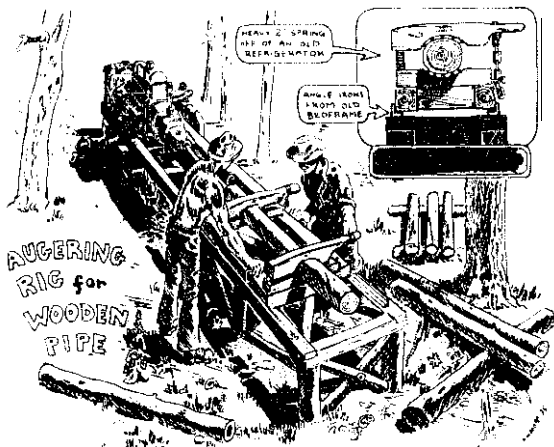
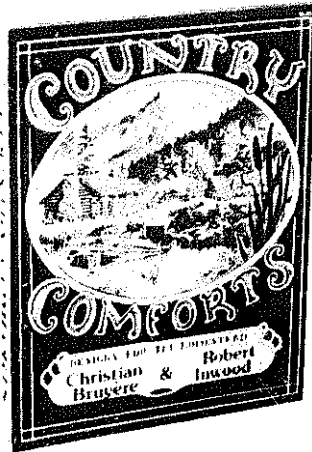

In Harmony With Nature

This is, by far, the best book on log house construction. It is new, long haired, beautifully detailed in its illustration, and applies both the use of the traditional tools (adze, axe, broad-axe, chisel) and the ever lovin' chainsaw. If you have a piece of land with some trees on it, I strongly recommend this book.

— J. D. Smith

In Harmony With Nature

(Creative Country Construction)
Christian Bruyere and Robert Inwood
1975; 213 pp.

\$6.95 postpaid

from:
Drake Publishers
801 Second Avenue
New York, NY 10017
or Whole Earth

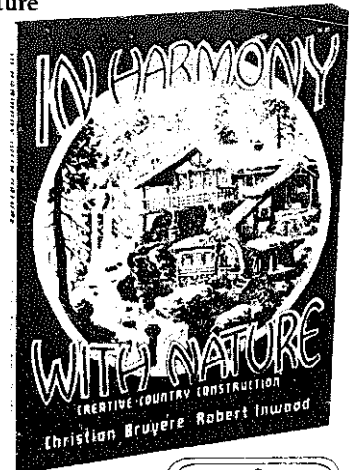

POSITIONING & HOLDING A LOG IN PLACE FOR MARKING

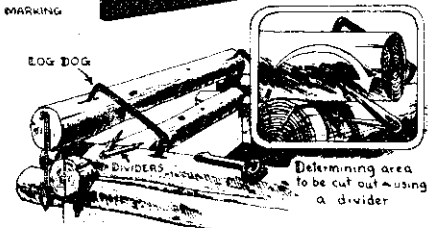

Long before we actually started construction, we put stakes around the proposed perimeter of the house. And every morning we came to the site from our nearby tent and inspected that area. Some mornings the area would seem very tiny, so we would enlarge the perimeter. Other mornings the area would seem huge. Those mornings we'd made it smaller. We soon began "playing house" in the area. We figured out where the various sections would be and how much space would be necessary for each. In the kitchen we measured areas for refrigerator, stove, sink, cabinets, and cupboards.

Then Janey would pretend to make a meal. I'd "go in the livingroom, stoke the fireplace, and sit down on the couch." I'd pretend to entertain friends. We'd pass each other in the hallway and sit down in the diningroom to eat. Though we didn't stick to plan for the finished product, we had a good idea of the space we needed. It turned out that 20' x 24' with an adequate loft area would be sufficient space for us — no immediate plans for enlarging our family.

Building With Logs

The most thorough manual on log house construction to date, as well as the only book which dwells on the Swedish Technique of building. The results achieved by the Swedish method are perfectly fitted wall logs without any intrusion on the natural character of the tree, no need for chinking and little insulation. The house produced has amazing durability and can last centuries if need be as well as having a strikingly dignified appearance.

—Neil

[Author also publishes a magazine, The Canadian Log Builder.]

Building With Logs
B. Allan Mackie
1974; 76pp.

\$8.00 postpaid

from:
B. Allan Mackie
P.O. Box 1205
Prince George, B.C. V2L 4V3
Canada

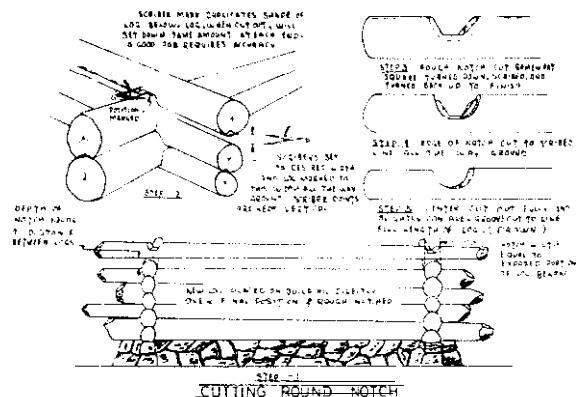

American Preservation

This magazine on neighborhood preservation is carefully and beautifully put together, has lots of great success stories, useful source information, and lots of shiny color pictures of before and after saving buildings. One recent lead article was "Preservation's Most Vexing Problem: The Displacement of Low-Income Persons" — a comprehensive description of what happens when poor people in run-down houses find their neighborhood becoming desirable, expensive, and they are forced out. This magazine's broad approach to the subject of preservation is a pleasant change from the usual one-sided interest. Combining historic preservation and neighborhood preservation is a better solution for both.

American Preservation

(The Magazine for Historic and Neighborhood Preservation)
Porter Briggs, Ed.

\$12.00 /yr
(bimonthly)

\$3.00 /single copy

from:
American Preservation
P.O. Box 2451
Little Rock, AR
72203

— Virginia Baker
Neighborhood Foundation
San Francisco



Old House Journal Buyers' Guide

The Old House Journal (EPILOG, 584) has published a catalog of house parts and equipment for you restorers. Looks Good.

The Old House Journal Buyer's Guide

1978; 72 pp.

\$6.95 postpaid

from:
The Old House Journal
199 Berkeley Pl.
Brooklyn, NY 11217



Tin Ceilings

24 different patterns, including 13 traditional designs. Especially appropriate for Victorian houses. Cornice mouldings available in 10 patterns. We ship anywhere.

Send for free brochure.

AA Abbingdon Ceiling Co.
2149 Utica Ave.
Brooklyn, N.Y. 11234
Tel. (212) BE 6-3251

How to Rehabilitate Abandoned Buildings

Some of it's basic (floors & toilets), some of it's cosmetic (molding & kitchen layout), but all of it is a big improvement over wreck-and-develop. My neighborhood in San Francisco is commencing to reconstruct itself this way.

— SB

How to Rehabilitate Abandoned Buildings

Donald R. Brann
1974; 258pp.

\$3.50 postpaid

from:
Directions Simplified, Inc.
Division of Easi-Bild Pattern,
Co. Inc.
P.O. Box 215
Briarcliff Manor, NY 10510
or Whole Earth

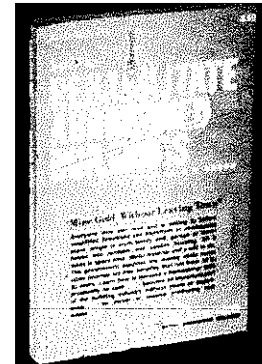

Assuming the house you buy is stripped of its facilities and you recognize the logic of moving in as soon as possible, the question of a workable toilet requires immediate attention. Your choice can range from an old-fashioned bedpan and plastic bags; a chemical toilet, available from lumber, farm supply and mail order houses; a propane gas fired unit, that can be used permanently; or a jet-powered john, that can be installed below the waste line in a basement. Since a basement floor is usually below frost level, even before you heat the basement chances of a freeze-up are nil.

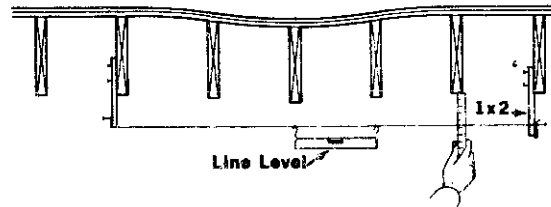

Back to the City

Back to the City is currently functioning as a clearinghouse for information on urban rehabilitation and preservation. As such, we are able to put local community groups and neighborhood workers from all parts of the country in touch with information and restoration projects aimed at preventing the further deterioration of urban neighborhoods. Our goal is to educate existing inner-city residents to the value of their homes and neighborhoods (both architectural and cultural value), and to encourage a return to the city of additionally stabilizing groups. Membership costs \$5 for individuals. \$25 for organizations.

Betty Fluegelman Kahn
Executive Director

The book is an encouraging collection of experience in restoring various cities. The restorers have broad advice to offer.

—SB

Back to the City Vol. I & Vol. II

(A Guide to
Urban Preservation)
1975; 80 pp.

\$5.00 each, postpaid

from:
Brownstone Revival committee
12 E. 41st St.
New York, NY 10017

The house tour is our most effective instrument for "selling" a community. Very few people are willing to be pioneers, but if you show them there are other settlers, you'll get buyers.

The Owner-Builder and the Code

When push comes to shove, the Big Problem with building your own home is usually something to do with getting the abode of your desires past the building inspector. This is even more of a problem if you are not quite the sort of folks the local folks are used to. What do you do? This handbook of case histories and strategy is by none other than that old master Ken Kern (*The Owner-Built Home*, CATALOG p.94) and friends. It's about as good a source of information as one could hope for. Whether your inclination is compliance or defiance, you'd best give this a look.

— JB

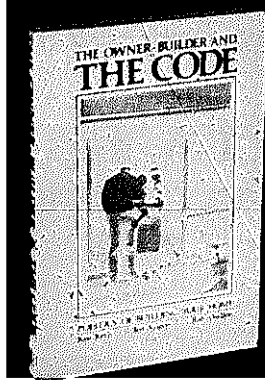

The Owner-Builder and The Code

(Politics of Building Your Home)
Ken Kern, Ted Kogon, Rob Thallon
1976; 182pp

\$5.00 postpaid

from:
Owner Built Publications
P.O. Box 550
Oakhurst, CA 93644

In these times of "energy crisis," the Uniform Building Code (Sec. 1410) and the Uniform Housing Code (Sec. H701a) require

"heating facilities capable of maintaining a room temperature of 70 degrees F. at a point 3 feet above the floor in all habitable rooms." This clause excludes wood heating as an adequate method because, in the words of one building official, "... a BTU rating cannot be established for wood heat."

Rural owner-builders employ wood heaters as their *only* source of heat, and for this they are often held in violation by building inspectors. Wood is a readily available fuel in many rural environments, and its utilization does not contribute to the depletion of fossil fuels. Indeed, much available country land has already been logged by timber companies and the remaining fire-hazardous slash provides fine wood heat. Instead of being commended for using a resourceful alternative to consumptive heating devices or for clearing slash, owner-builders may find abatement proceedings against their houses for "lack of adequate heating facilities."



Anon Forrest of United Stand frowns at a sign on the entrance door to the California State Capitol Building. A government building not up to code can get by with an "Enter at Your Own Risk" sign. Why not an owner-built home? California newspapers flippantly treated Jerry Brown's support of United Stand issues as "the governor coming out for outhouses." But, for the United Stand delegates, Brown's responsiveness helped restore their faith in government.

Housing By People

Quite simply, each and every Planner still at large in the several societies of this world should be made to sit out in the weather until he or she has read and acknowledged understanding the principles outlined in this little rapier of a book. The ideas are well illustrated with devastating examples of governmental inadequacy and beautiful examples of ordinary people at work on their own living accommodations. Mr. Turner is not alone in his views, and with more support such ideas will gain enough momentum to make a real difference for a lot of people. There was much talk along these lines at the United Nations Habitat Forum in Vancouver in June, 1976.

— JB

(Suggested by Ian Hogan)

Housing By People

(Towards Autonomy in Building Environments)
John F.C. Turner
1976; 162 pp.

\$3.95 postpaid

from:
Random House, Inc.
Pantheon Books
455 Hahn Rd.
Westminster, MD 21157

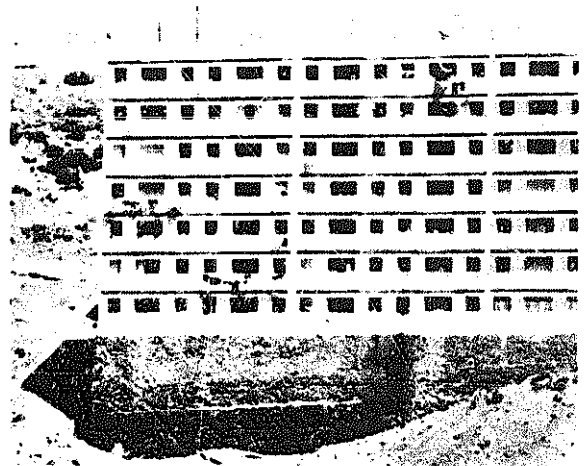

The block of flats above is a few hundred feet away from the houses below. This example from Las Palmas, Canary islands, supports the proposition that aesthetically hideous, socially alienating and technically incompetent architecture is bound to replace that with traditional values when fossil-fuelled heteronomy takes over.

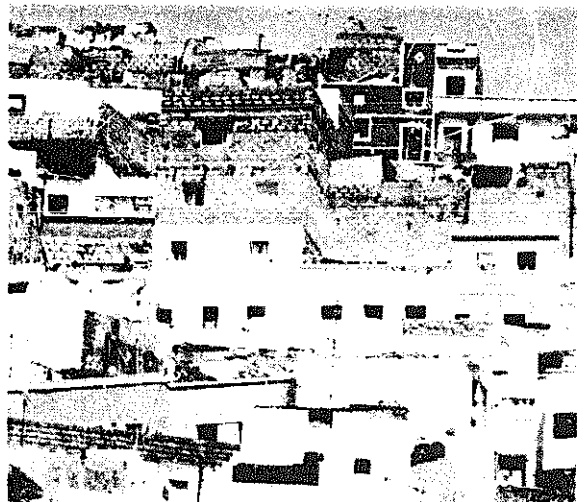

Energy and Form

This is not a casual environmentalist's workbook. Problems such as "how are we going to house our doubled population due in 35 years?" are dealt with. Mr. Knowles performs a remarkable analysis of the solar energy flows in Pueblos as a demonstration of what might be expected if such factors were considered in the design of buildings. He suggests that if the energy flows of an entire area were known, then it would be possible to design structures and urban layouts that would take advantage of them. He presents a detailed study of California's Owens Valley as an example. This amounts to a wider view of architecture and planning than has usually been the case. It seems to me that it is also a necessary view. Mr. Knowles is one of the forces pushing architecture into new territory.

— JB

Energy and Form
(An Ecological Approach
to Urban Growth)
Ralph L. Knowles
1974; 198pp.

\$27.50 postpaid

from:
The MIT Press
28 Carleton Street
Cambridge, MA 02142
or Whole Earth

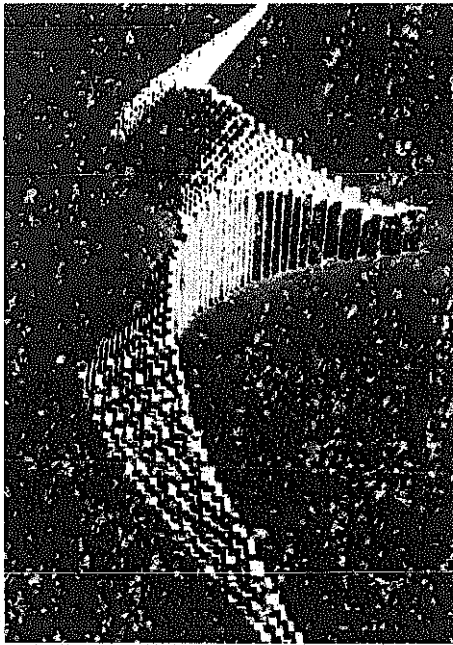

Pueblo Bonito in Chaco Canyon, New Mexico, as it was unearthed by N.M. Judd during seven National Geographic Society expeditions, 1921-1927.



The Glass House

"Greenhouse", that is. Plants generally require much more sophisticated control of their environment than do humans, and so it isn't surprising that horticulturists know more about artificial climate than do architects. This elegant book reveals that much of the knowledge needed for the design of solar houses and "biospheres" has been known for more than 1600 years! I was also quite surprised to find out how large some of the indoor agricultural projects were and are; for instance there are more than 17,000 acres of greenhouse in use today in the Netherlands. Mr. Hix doesn't furnish us with thermal performance figures, but he includes a juicy bibliography and a glittering collection of sharp photographs and drawings. A real find for indoor food-raisers and solar house designers.

— JB

[Suggested by Day Charoudi]

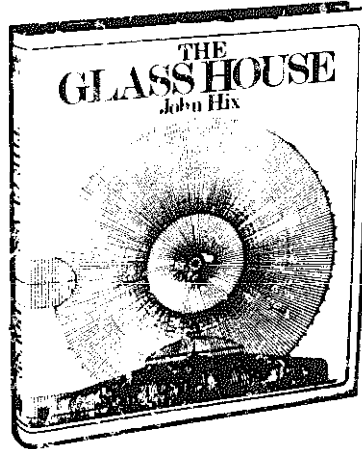

The Glass House

John Hix
1974; 208pp.

\$22.50 postpaid

from:
The MIT Press
28 Carleton Street
Cambridge, MA 02142
or Whole Earth

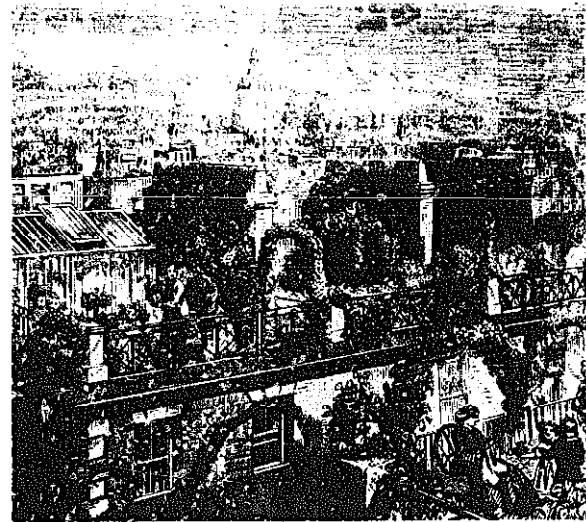

W. Bridges Adams, a major proponent of iron and glass construction and an urban visionary of the nineteenth century, proposed stripping off the existing roofs of London terraces and replacing them with roof gardens.

... Gardens of this kind would be as in the East, the resort of the family in fine weather and in bad weather a warm greenhouse on the roof would be a more pleasant thing than a dark parlour. Scarcely anything could be conceived more beautiful than the enormous expanse of London roofs covered with shrubs and flowers. And it would be a perfectly practicable thing so to construct the greenhouses that they might be opened or closed at pleasure.



INSULATION

HERESY

BY RICHARD NILSEN

Since virtually all the authorities — utilities, building codes and the Federal government — are agreed that in terms of energy conservation, the more insulation in a building the better, it is worth hearing from one of the only voices around saying that it simply ain't so. The voice belongs to Jay L. McGrew, civil, mechanical and chemical engineer, former space scientist (he worked on heating and cooling design for the moon shots), and currently president of his own R&D company, Applied Science and Engineering, near Denver.¹

McGrew does not deny that more insulation will cause less heat loss; he simply argues that beyond a certain point, there are other, simpler, cheaper things to do to heating systems that will conserve far more energy than can be achieved by stuffing more insulation into the walls. His data is not warmly received by the insulation manufacturers ("Johns-Mansville," says McGrew, "has lobbyists in every state in the union."); the gas companies are upset with his alternatives; and McGrew increasingly finds himself telling legislators drafting energy conservation codes that they simply don't know what they are talking about. All of which tends to make his arguments into something of a one-man crusade, albeit a crusade with hard data.

For the last year or so, McGrew's company has been monitoring the energy use and heat loss of existing housing in the Denver area.² The data gathered from this whole systems approach points to gas furnace design and operation as a prime area for improved energy conservation. McGrew adds, "In terms of having the greatest impact on national energy conservation, the two simplest things to do are to adjust gas furnaces so they operate more efficiently, and to install room air circulators." (See box.)

GAS FURNACES

Natural gas is used for more than half of the space heating in the U.S. The most common system is natural gas/forced air, in which the gas burns and warms a cast iron heat exchanger. Air blown through the heat exchanger is warmed and continues through ducts into the house. These systems are

cheap, safe and maintenance free, but their design criteria assumes natural gas to be cheap and plentiful, which has been the case until recently. But no longer and increasingly less in the future.

McGrew claims a gas/forced air system is "marginal as a heat transfer device because it does not maximize the overall efficiency of the furnace." For example, the American Gas Association (AGA), the industry's self-regulating body, rates the efficiencies of gas furnaces. A typical figure of 75% efficiency means 75% of the heat produced goes out of the furnace into the building and the other 25% is lost UP the gas vent stack.

The catch is that these ratings are for the furnace alone, not the whole system of furnace, blower, and duct-work throughout the house. Also, the rating considers a furnace that is on and warmed up, although in actual use of course the furnace cycles on and off repeatedly — when it is off the heat exchanger loses its heat up the stack. Taking the whole system's efficiency into account, as McGrew has done in his Denver study, results in average efficiencies for gas/forced air systems of 20.30%.

This kind of figure is what has the gas utilities up in arms with McGrew, but since they are a measure of BTUs burned versus BTUs delivered to a room as heat, they are much more meaningful than the AGA rating of an isolated furnace in a testing lab.³ Adds McGrew, "A furnace contractor can tell you the AGA rating, but none of them are able to tell you the actual efficiency when the furnace is hooked up to the air ducts of a house."⁴

What helps? Turning down your thermostat does not affect the size of the flame in the furnace, and neither does closing heat registers in empty rooms. McGrew's solution is to reduce the orifice size of the gas jet, which reduces the size of the flame. Turning down the gas flow would accomplish the same thing, hopefully getting more heat into the rooms than goes up the stack, but gas companies are — with some justification — horrified at the idea of Mr. or Mrs. Average Customer fiddling with the furnace.

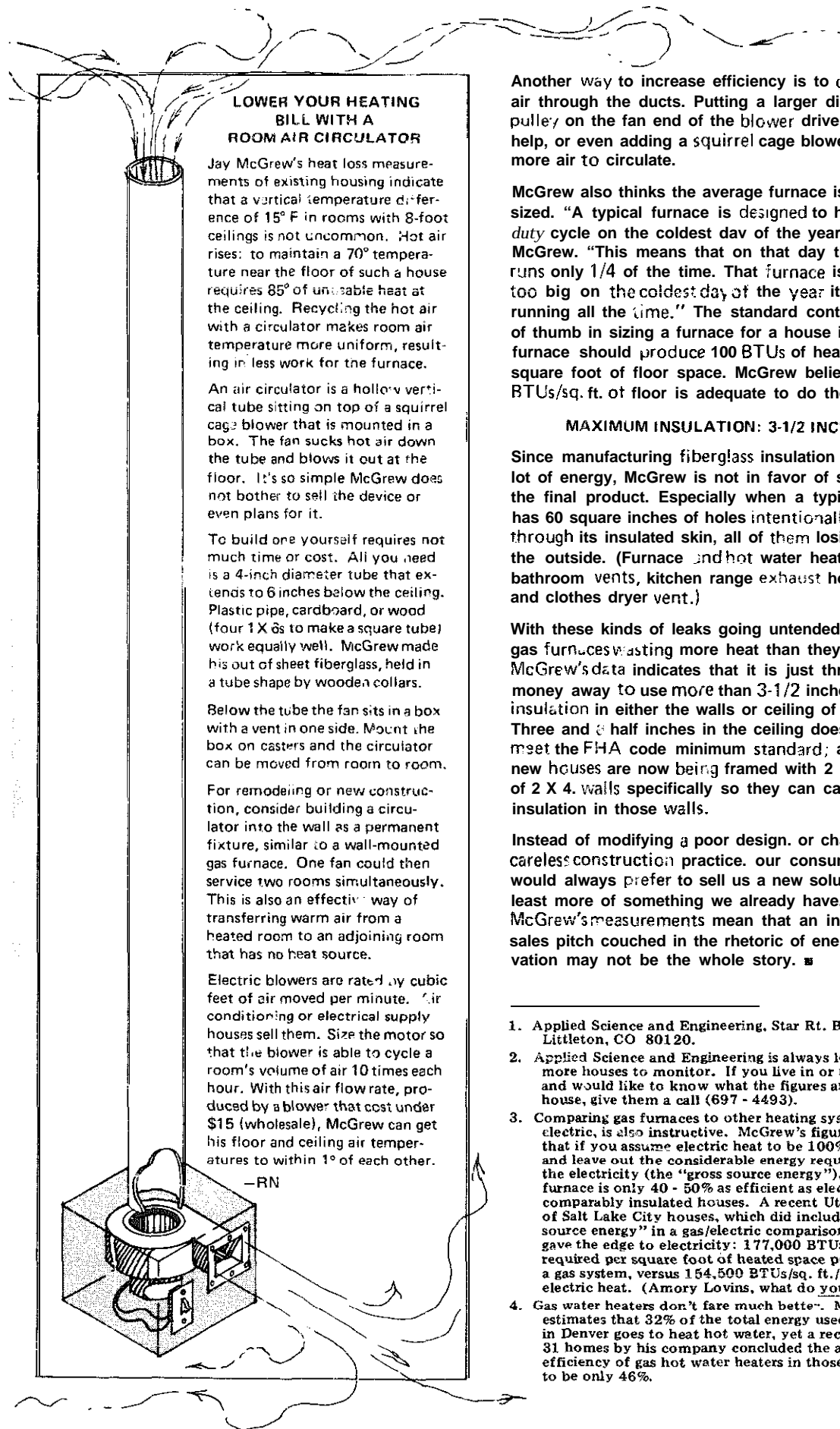

LOWER YOUR HEATING BILL WITH A ROOM AIR CIRCULATOR

Jay McGrew's heat loss measurements of existing housing indicate that a vertical temperature difference of 15° F in rooms with 8-foot ceilings is not uncommon. Hot air rises: to maintain a 70° temperature near the floor of such a house requires 85° of unusable heat at the ceiling. Recycling the hot air with a circulator makes room air temperature more uniform, resulting in less work for the furnace.

An air circulator is a hollow vertical tube sitting on top of a squirrel cage blower that is mounted in a box. The fan sucks hot air down the tube and blows it out at the floor. It's so simple McGrew does not bother to sell the device or even plans for it.

To build one yourself requires not much time or cost. All you need is a 4-inch diameter tube that extends to 6 inches below the ceiling. Plastic pipe, cardboard, or wood (four 1 X 6s to make a square tube) work equally well. McGrew made his out of sheet fiberglass, held in a tube shape by wooden collars.

Below the tube the fan sits in a box with a vent in one side. Mount the box on casters and the circulator can be moved from room to room.

For remodeling or new construction, consider building a circulator into the wall as a permanent fixture, similar to a wall-mounted gas furnace. One fan could then service two rooms simultaneously. This is also an effective way of transferring warm air from a heated room to an adjoining room that has no heat source.

Electric blowers are rated by cubic feet of air moved per minute. Air conditioning or electrical supply houses sell them. Size the motor so that the blower is able to cycle a room's volume of air 10 times each hour. With this air flow rate, produced by a blower that cost under \$15 (wholesale), McGrew can get his floor and ceiling air temperatures to within 1° of each other.

-RN

Another way to increase efficiency is to cycle more air through the ducts. Putting a larger diameter pulley on the fan end of the blower drive belt will help, or even adding a squirrel cage blower to force more air to circulate.

McGrew also thinks the average furnace is way oversized. "A typical furnace is designed to have a 1/4 duty cycle on the coldest day of the year," says McGrew. "This means that on that day the furnace runs only 1/4 of the time. That furnace is 4 times too big on the coldest day of the year it should be running all the time." The standard contractor's rule of thumb in sizing a furnace for a house is that the furnace should produce 100 BTUs of heat for each square foot of floor space. McGrew believes 20 - 25 BTUs/sq. ft. of floor is adequate to do the job.

MAXIMUM INSULATION: 3-1/2 INCHES

Since manufacturing fiberglass insulation requires a lot of energy, McGrew is not in favor of squandering the final product. Especially when a typical home has 60 square inches of holes intentionally poked through its insulated skin, all of them losing heat to the outside. (Furnace and hot water heater vents, bathroom vents, kitchen range exhaust hood vent, and clothes dryer vent.)

With these kinds of leaks going untended, and with gas furnaces wasting more heat than they deliver, McGrew's data indicates that it is just throwing money away to use more than 3-1/2 inches of insulation in either the walls or ceiling of a house. Three and a half inches in the ceiling doesn't even meet the FHA code minimum standard; and many new houses are now being framed with 2 X 6, instead of 2 X 4, walls specifically so they can carry thicker insulation in those walls.

Instead of modifying a poor design, or changing a careless construction practice, our consumer economy would always prefer to sell us a new solution, or at least more of something we already have. Jay McGrew's measurements mean that an insulation sales pitch couched in the rhetoric of energy conservation may not be the whole story. ■

1. Applied Science and Engineering, Star Rt. Box 96 A, Littleton, CO 80120.
2. Applied Science and Engineering is always looking for more houses to monitor. If you live in or near Denver and would like to know what the figures are for your house, give them a call (697 - 4493).
3. Comparing gas furnaces to other heating systems, such as electric, is also instructive. McGrew's figures indicate that if you assume electric heat to be 100% efficient, and leave out the considerable energy required to make the electricity (the "gross source energy"), then a gas furnace is only 40 - 50% as efficient as electric heat in comparably insulated houses. A recent Utah survey of Salt Lake City houses, which did include "gross source energy" in a gas/electric comparison study still gave the edge to electricity: 177,000 BTUs were required per square foot of heated space per year with a gas system, versus 154,500 BTUs/sq. ft./yr. for electric heat. (Amory Lovins, what do you say?)
4. Gas water heaters don't fare much better. McGrew estimates that 32% of the total energy used in a house in Denver goes to heat hot water, yet a recent study of 31 homes by his company concluded the average efficiency of gas hot water heaters in those homes to be only 46%.

The Solar Home Book

Most of the basic information on solar energy has been established and published in every imaginable nuance, but application of the basics surges ahead so fast that usually only the journals can keep up. Unfortunately, the journals can't afford to be highly detailed, and the hardcover publishers can't afford to bring out new titles. Once again Bruce Anderson and friends come to the rescue, and once again they are in front of the pack. This book is a thorough revision and update of the very fine and friendly *Solar Energy and Shelter Design* (Spring '75 CQ). There's a lot in it about "passive" systems (when the building itself rather than a fancy mechanism does the capturing and storing of energy). The whole book is rich in what-we-have-learned-by-trying-it, and gives examples from many different parts of the U.S.A. This is in marked contrast to most others. If you are dealing sun these days, the book is essential reading. (Incidentally, Bruce Anderson is also executive editor of the ever-better *Solar Age* magazine, page 64.

- JB

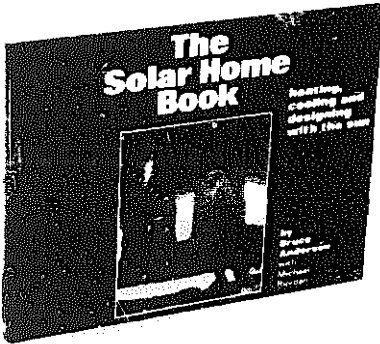

The Solar Home Book
Bruce Anderson
with Michael Riordan
1976; 256 pp.

\$8.50 postpaid
from:
Cheshire Books
Church Hill
Harrisville, NH
03450
or Whole Earth

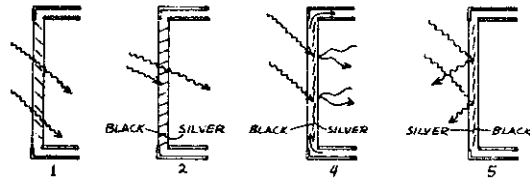
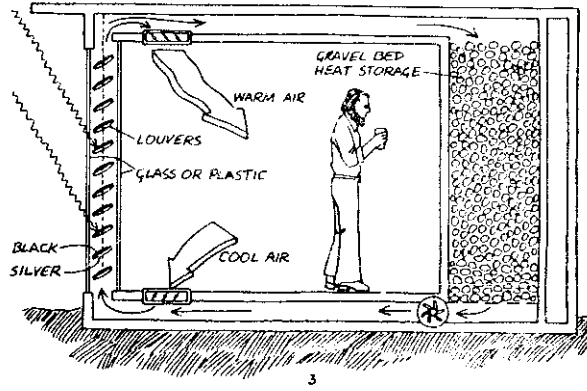

A "Venetian blind" solar collector and heat control device — various operating modes.

Solar Energy, Fundamentals in Building Design

This is the Professional Architect's version of the Solar Home Book. Fortunately, Bruce Anderson makes the principles useable and clear without the discouragingly complex math found in the typical engineering treatise. A very complete bibliography and index adds the final touch of excellence.

- JB

Solar Energy, Fundamentals in Building Design

Bruce Anderson
1977; 374 pp.
\$17.50 postpaid
from:
McGraw-Hill Book Co.
Princeton Road
Highstown, NJ 08520
or Whole Earth

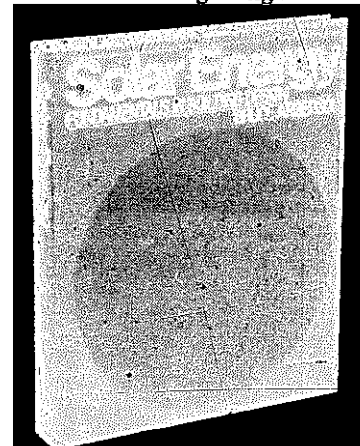

Various tube configurations for solar absorber surfaces.

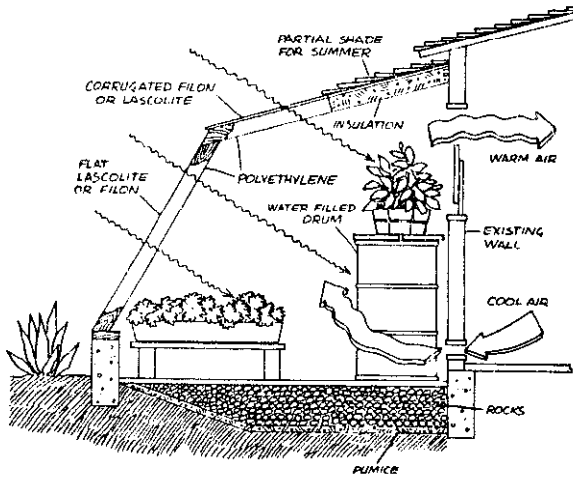
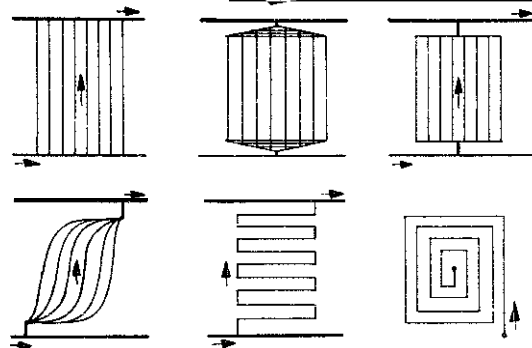

Cross section of Solar Sustenance Project greenhouse — daytime operation.

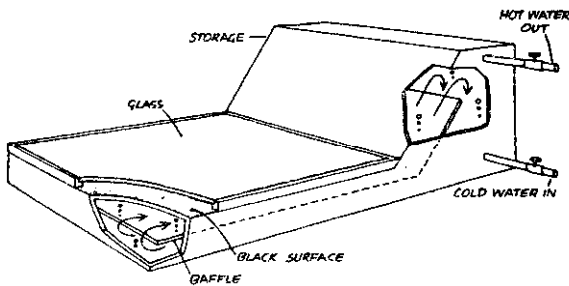

Thermosiphoning solar water heater developed in the West Indies.

An Introduction to Heat Pumps

The heat pump is a device that works on the same principle as a refrigerator. It can take heat from the ground, air, or water, and deliver it into your home. It can also take heat out of your home. It's one of those devices that seems too good to be true: you put in some energy, but you get more energy out than you put in. Or at least you should. Heat pumps are also eminently compatible with many solar heating/cooling systems. How they work and how to utilize them is neatly laid out here in easy language. The author makes so bold as to suggest that the auto industry should tool up to make heat pumps! In any case, we're going to see a lot of heat pump activity in the next few years, so it'd probably pay you to bone up a bit. You will have to translate from the British here and there, though.

— JB

An Introduction To Heat Pumps

John A. Summer
1976; 56 pp.

\$3.25 postpaid

from:
Book People
2940 7th Avenue
Berkeley, CA 94710
or Whole Earth

The most suitable form of solar heat to use with a heat pump is solar heat stored in the earth. It is strange that the use of this immense source of heat is so often decried. It is held that the average house plot does not contain sufficient land for the necessary buried pipes. Yet only 110 sq. yards is required, as a minimum, and the land remains available for normal use as a lawn or whatever. It is also held that the cost of installation is too high, i.e., £300, but, since the ground coil heat pump ensures a value of C.H. = 3 compared with a value of C.H. = 2 when using ambient air, there is an annual saving of one-third in electricity consumption. Further, the maintenance of a suction gas pressure and volume with practically no variation, in place of the 40-60 per cent variation when ambient air is used can result in a compressor life (worth more than £300) of 20 years instead of, perhaps, 5 years.

Air powered pump systems

Before city power and water, one of the ways to have a pressurized water system was to have an air compressor run by whatever machine (tractor?) you had around to charge a compressed air tank. Air from that was piped to the air-driven pumps submerged in the well or cistern. The result was pressure at the faucet on demand without the necessity of a water storage tank. These systems were well adapted to intermittent power sources and might be useful for some "alternative" energy powered outfits. You can still get the hardware! The catalog is the original 1923 edition and is an education in itself.

— JB

Air Operated Fresh Water pumps
\$281.00~ \$360.00

from:
Stauffer's Machine Shop
Pump Div.
R.D. #3
Ephrata, PA 17522

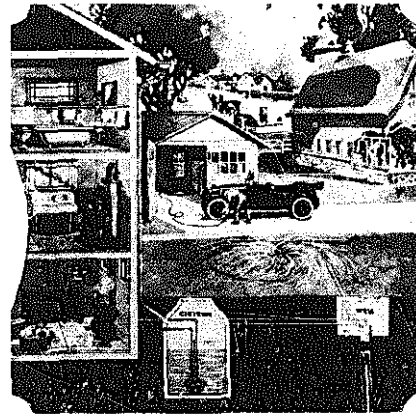

The Handbook of Moving Air

The ventilation professionals show how to control the air circulation in your humble abode. They cover both nature-powered methods and equipment as well as mechanical. An architect's office would probably wish for more engineering features, but this paper will do just fine for most of us. The material is not copyrighted; a commendable attitude.

— JB

The Handbook of Moving Air

(A Compilation by The American Ventilation Association)
Harrison A. Dunlavy, Ed.
1976; 55 pp.

\$2.00 postpaid

from:
American Ventilation Assn
P.O. Box 7464
Houston, TX 77008

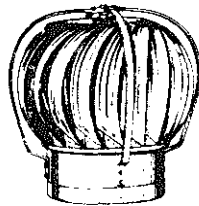

ROTATING TURBINE

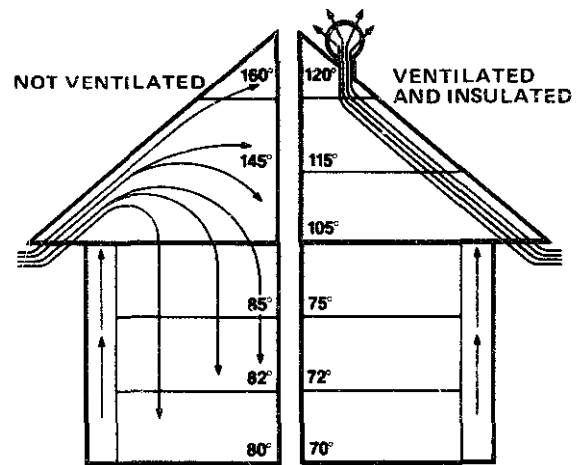

The important part of this sketch is that it shows a hot attic causes a hot ceiling which causes a hot living area.

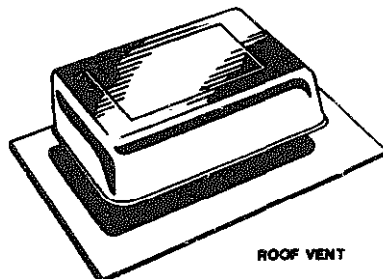

ROOF VENT



STANDARD S-CAP

The every day process of living in the home generates surprising quantities of water vapor. Cooking, bathing, washing clothes or dishes, all add water vapor to the air. Each member of the family contributes from 1-1/2 to 2 lbs. of water vapor each day. The total water vapor by a family of 4 living in a modern home adds up to 150 lbs. or 18 gallons per week.

Architecture and Energy

With the "authorities" telling us that not much more can be done towards energy conservation, it is refreshing to read this well-documented assertion that there is opportunity for dramatic energy savings in more thoughtful architecture, the many downright gleeful actual examples show that a reduced "standard of living" need not accompany the savings. There may be more technical books on the subject, but this one is the best I've seen for irrefutable, attitude-modifying argument.

—JB

Architecture and Energy
(Conserving Energy Through Rational Design)
Richard G. Stein
1977; 322 pp.

\$12.95 postpaid

from:
Doubleday & Co., Inc.
501 Franklin Ave.
Garden City, L.I., NY
11530
or Whole Earth

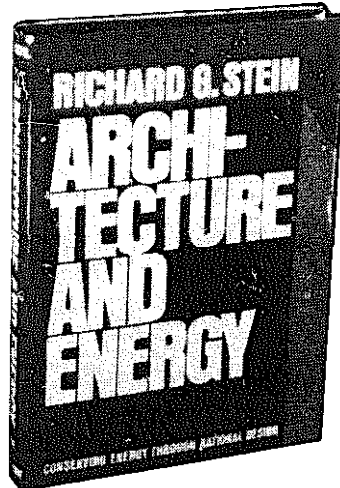

With no advertising lighting and no illuminated store signs, all merchandise looks attractive on the main shopping street in East Hampton, New York.



The canvas canopy provides shade, glowing diffused light, and controlled ventilation. Oaxaca, Mexico.

Winona — towards an energy conserving community

Not content with the success of the truly pioneering Ouroboros project (EPILOG, p. 534) Dennis Holloway leads his students in a study of what could be accomplished if the Ouroboros learnings were applied to a typical full-sized community. It's all proposal at this time, but it sure sounds exciting. Based on past performance, I'd say these people are among the few well worth watching as they test the fences of what's possible.

—JB

Winona
Dennis Holloway
and students
Huidah Curl, ed.
1975; 122pp.

\$5.00 postpaid

from:
Publications: Winona
University of Minnesota
2818 Como Ave. SE
Minneapolis, MN 55414

Building Value

California's State Architect, Sim Van der Ryn, has been shaking things up in Sacramento in a way not often seen. From his office has come an architectural philosophy that isn't mere political hoorah. Believe it or not, the state of California actually has an official energy-in-buildings policy. **Building Value** presents the guidelines and the reasoning behind them. The basic principles, of course, could apply in many other states. I find this demonstration of leadership encouraging.

—JB

Building Value
(Energy Design Guidelines for State Buildings)
Tom Bender and
Lane deMoll
1977; 99 pp.

\$3.25 (limited quantity left)

from:
Publication Section
Office of Procurement
Box 1015
North Highlands, CA 95660

A vacuum toilet saves water by using only 3 pints for each flush compared to up to six gallons in conventional systems. A savings in water costs and treatment costs due to 90% reduction in volume.

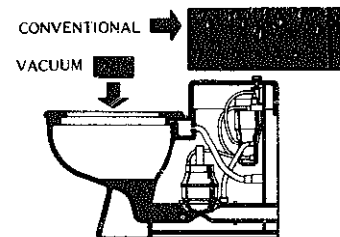

Concrete and Energy

The Portland Cement Association shows how concrete can save energy in just about every way you can think of except saving energy by not making concrete. Effect of window area on heat loss is shown and the "thermal flywheel" advantages of heavy construction are discussed. Lots of good things for builders to know about. Many comparisons of various construction methods.

—JB

The Concrete Approach to Energy Conservation
Portland Cement Association
1974; 49pp.

\$2.40 postpaid

from:
Portland cement AS".
5420 Old Orchard Rd.
Skokie, IL 60076

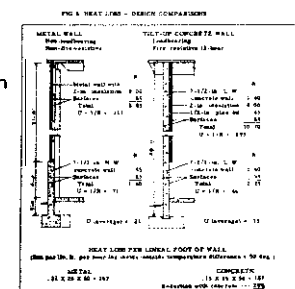

The Food and Heat Producing Solar Greenhouse

In the short time this book has been available, it has become the one where you look first. For good reason too — somebody or other has actually done what's shown, and there's a lot shown. More than shown really, because there's also lots of how and why too. And a good bibliography with comment. And good photographs of proven details. And step-by-step instruction on both building and operating. In fact, the book is a marvel. Lots of love in it.

— JB

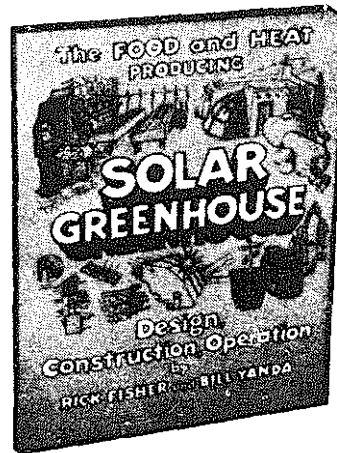

The Food and Heat Producing Solar Greenhouse

(Design, Construction, operation)
Rick Fisher and
Bill Yanda
1976; 161 pp.

\$6.50 postpaid

from:
John Muir Publications
P.O. Box 613
Santa Fe, NM 87501
or Whole Earth

The Otwell's greenhouse/home combination had an average low of 55 degrees and an average high of 75 degrees during the first winter in use. Corresponding outdoor temperatures were 10 degrees and 50 degrees respectively.

So there they sit, Katherine and Bill Otwell, in a beautiful low-cost completely passive solar home in the Arizona desert. They're eating fresh vegetables from their greenhouse when it's below freezing outdoors, burning a minimum of wood in very cold weather, designing other low-cost solar homes, and defying the notion that such dwellings don't exist yet. For further information write to: William Otwell, Arizona Sur.works, Star Route, Chino Valley, Arizona 86323.

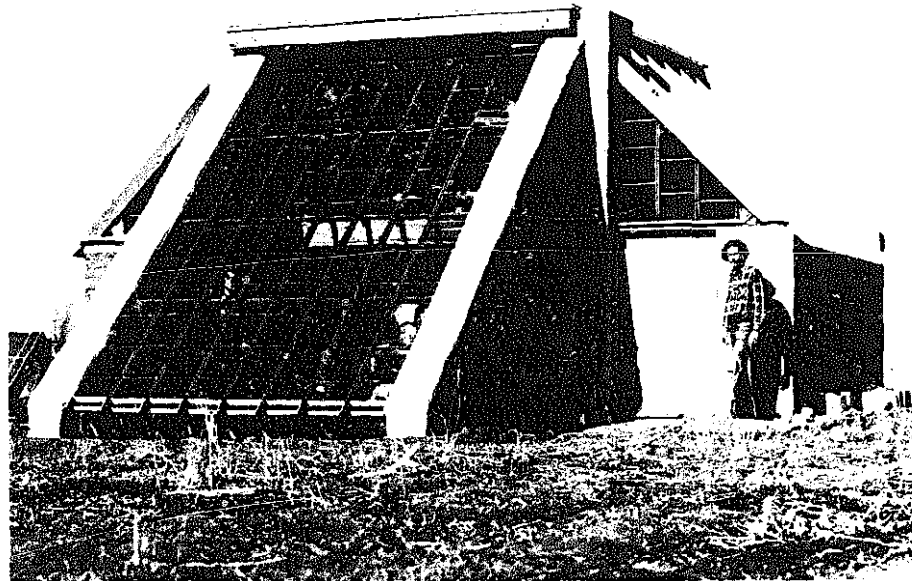

Dr. Voute has developed a rather intense personal relationship to his unit. To paraphrase him: "The damn thing's like a spoiled pet or child; it needs attention all the time. I think we'll skip December and January growing next year and take a vacation from it." This is said lovingly, believe it or not.

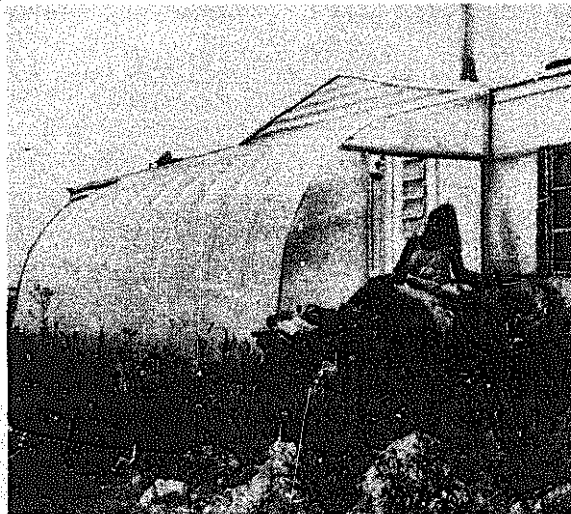

The inflatable polygreenhouse, naturally, doesn't have the durability of a rigid fiberglass or glass house. However, it definitely has an initial cost edge over any similarly sized pre-fab solar collector. If the owner takes good care of the material and stores it in the summer it might go as long as five heating seasons before replacement of the inexpensive polyethylene. That's far beyond the pay-off period. As a matter of fact, in some applications like mobile homes (see photo), the Solar Room could pay itself off in one heating period. (That's ignoring the food production capabilities of the unit.) Any home owner getting hit for \$150 to \$200 a month heating bills (common in many areas) should certainly investigate this system.

Besides the inflatable Solar Room, the company is also developing water heaters and thermally designed window box greenhouses.

Write them for more information at Box 1377, Taos, New Mexico 87571.

The Transformation of the Tract Home

This Davis, California, subdivision has solar heating, bike paths, crop land and room for goats and chickens

BY RICHARD NILSEN

Photographs by David Edwards

Low cost energy-conserving shelter has been around now for some time; it tends to be owner-built, innovative and rural. At the other end of the scale, the person with \$100,000 to spend on a custom home has an ever widening variety of soft tech hardware to choose from. But what about middle class home buyers, where or how do they get to take advantage of the recent advances in energy efficient home design?

One of the first, and so far only, developments to offer energy efficient middle income housing is Village Homes of Davis, California. Developer Mike Corbett spent three years working to get Village Homes off the ground, and to date has 55 single family homes finished out of a projected total of 240 on his 69 acre site.

Davis Performance Code

The development might still be on the drawing boards if it wasn't for the progressive attitudes of the Davis City government. Spurred by a group of university students, the city and the University of California at Davis funded a study* of energy efficient housing design in 1973. The Arab oil embargo that year proved fortuitous and helped legitimize the study, as millions of Americans were given time to meditate on the finite nature of world resources while waiting in gas lines all across the country.

Some interesting data resulted from the Davis study. In one apartment complex it was found that an east-facing top floor unit required six times as much energy for summer cooling as did a ground floor north-facing unit. The air conditioner was fighting the morning sun shining in the east-facing windows. That's simple enough, but the point is, no one had ever thought to raise these questions before.

* A Strategy for Energy Conservation, 51 pp., paperback, \$5.30 postpaid from Living Systems, Rt. 1, Box 170, Winters, CA 95694.

In October, 1975, Davis became the first city in the country to recognize these kinds of effects when it adopted the study's recommendations into its building code. Jon Hammond, one of the study leaders, and now with Living Systems in nearby Winters, California, puts it more bluntly "This is the first code which has ever recognized that there is a sun in the sky, and that its position affects the heating and cooling of buildings."

Most building codes are prescriptive, specifying the details of construction. The Davis energy standards are written as a performance code, allowing builders to choose their own methods and materials, so long as the finished building does not have a heat loss exceeding 150 BTU/sq. ft. of floor space for single family residences (the standards get tighter for larger buildings).

The Search for an Alternative

Mike Corbett's subdivision is unusual, his own story is not. The son of a home builder, he saw his share of typical American suburban life: His family moved several times in the rapidly expanding Sacramento suburbs; five years was the longest he lived in any one house. By the mid-1960s he was building custom homes on his own. In the late 1960s he returned to school at Davis, studying architecture and psychology. He was aware of the stigma attached to him as a builder by some of his more radical friends, and was also exposed in his studies to the social consequences of poorly planned suburban sprawl: loss of farm land, increased dependence on cars, unhappy teenagers, increased crime.

Tired of the status quo, Corbett set out in the early 1970s with thirty other families to look for a piece of land on which they could jointly build a community. After nine months of unsuccessful searching, the group fell apart, but Mike and his wife kept looking. They found the Village Homes site and bought it, with a small group of friends as investors.



This house will have a vegetable garden instead of a front lawn. You're looking at the southern side, with plenty of windows for passive solar heating in the winter. The higher summer sun will be blocked by the overhanging roof eaves. The carport/storage room is next to the parking bay and separate from the house, so as not to interfere with maximum heat gain from the winter sun. Notice the solar collectors for hot water on the roof, and the lack of east (and west) windows, which would collect a lot of unwanted heat from the morning and afternoon summer sun.

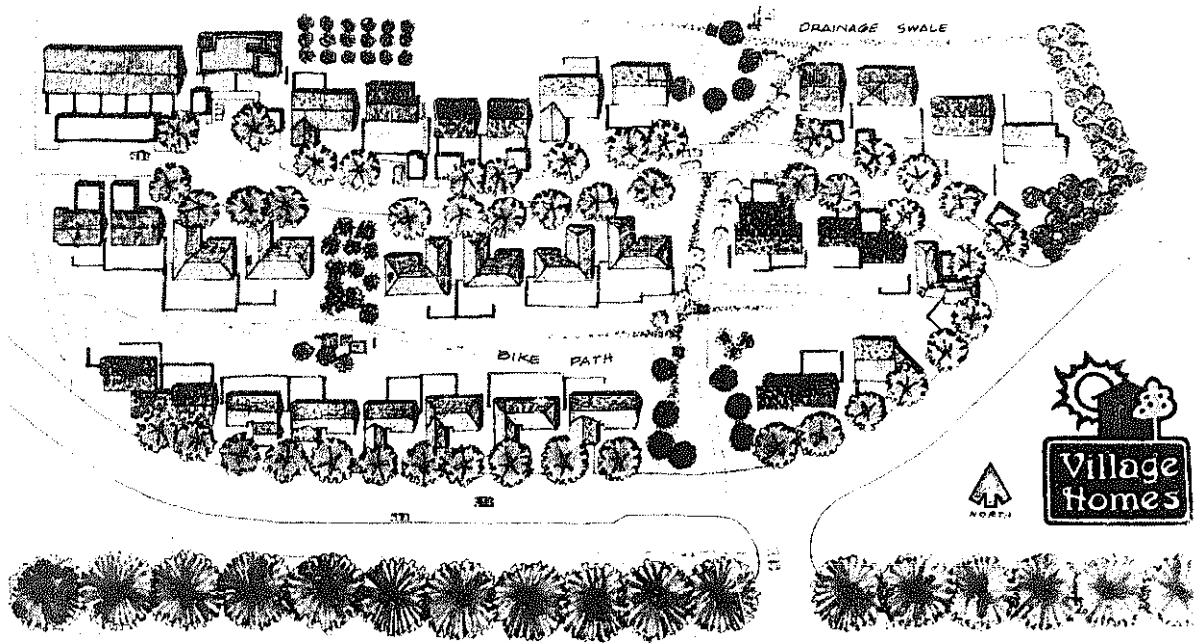

The streets and bike paths are gently curving, but the lots are on a strict North-South axis — every house receives equal sunlight. The bike paths are also fine for walking, and it's possible to go anywhere in the subdivision without using the streets. The paths traverse the common areas behind the houses. Car parking is in parking bays for each house. There is no street parking, which means streets are as narrow as 20 feet, instead of the usual 28 - 34 feet of a typical subdivision. Narrow streets require less asphalt, permit more of the total area to be in greenbelts, and ease the summer cooling problem in houses caused by the oven effect of re-radiated heat from wide black streets. Many of them are cul de sacs; all of which tends to de-emphasize the automobile. At Village homes, the hot-rodders are on bicycles.

The biggest single hurdle was convincing a bank to loan money for the front end improvements the development would need, like surveying, paved streets and water hook-ups. Although Corbett's basic idea was simple a development with larger greenbelts and fewer houses — bankers were leery of his innovations. Corbett tried no less than eight banks and savings and loans before he finally found anyone who would say yes. And along the way he had to scrap some of his innovations, most notably a plan to hook every eight houses into their own septic system instead of using the city sewers.

The lots are not large, averaging four to five thousand square feet, but this allows more land to be kept in greenbelts, both for the 1/3-acre common areas that are shared by every eight houses and for permanent agricultural lands within the development that are set aside for crops, pastures, orchards and vineyards. Fully 40% of the total area of Village Homes is in greenbelts, more than any conventionally developed subdivision in existence.

Corbett is building 2/3 of the houses himself; half of those are on speculation and half are custom homes. Other contractors are building the rest, with only about 10% of the homes owner-built. The houses are not large, varying in size from 900 to 2,100 square feet, with the average house about 1,400 square feet. They range in price from \$31,000 to \$75,000, and if this definition of middle income housing causer raised eyebrows, it must be realized

that these prices are competitive with other new housing in the Davis area, and that this whole venture was launched and is succeeding during some of the greatest inflation in building costs in history.

Houses over \$50,000 take three to four months to sell; for the ones under this amount there is a waiting list. But the profit margin on the lower priced houses is small, and in effect they are subsidized by the sale of the more expensive homes. Although Corbett is both developer and builder, he is very careful to keep the sale of lots separate from the sale of homes. Homes are financed by individual construction loans, but an occasional cost over-run on a house must not affect the balance sheet for the development. Says Corbett: "If this idea is ever going to be replicated elsewhere, it is absolutely essential that this first development be profitable."

Design Features

The alternative energy and conservation features of the houses are evolving as the building goes along. Not all of the early houses have solar hot water heating, but on the later ones it is now standard. Public acceptance had a lot to do with it, as Village Homes designer John Hofacre explained: "A year ago we could hardly sell solar hot water heating, but now there's a big demand." Hofacre attributes this change to higher utility bills, increased public awareness of the finite nature of natural resources (California's two year old drought has been a considerable consciousness raiser),



and plain old peer group pressure. "When you walk down the block and notice that every house on it has a solar collector, you want one too," said Hofacre.

Davis' climate makes it essential that building design and hardware work both for summer cooling and winter heating. Mild winters bring only occasional freezing and an average temperature during December and January of 45° F. The average summer temperature for the hottest month is only 75°, but this figure alone is misleading. Afternoon coastal breezes can easily cool a 95° high to a 55° low at night, but whenever these winds fail, the summer high can go to 110° and the low to only 70°. In other words, summer nights are cool, but the days are hot.

Because of design features that include tile roofs, good insulation, light colored exteriors, minimal east and west windows, and overhangs to keep the summer sun out of southern windows, Village Homes requires no energy for summer air conditioning. Because of the mild winters, passive solar space heating works well. A tile floor that soaks up winter sun through southern windows all day and then re-radiates that stored heat at night: is a good example. In Davis a properly designed and insulated house can provide 40 - 60% of the total winter heating needs. The more expensive active solar space heating systems using solar panels or other hardware are capable in Davis of providing 60 - 70% of the total winter heat.

The added cost of these energy saving and energy collecting extras for a 1,400 square foot house are shown below.

- \$1,500 for solar hot water
- 700 for double-pane glass in windows

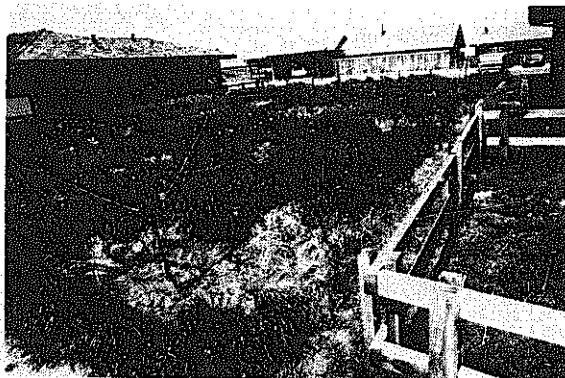

◀ One thing your typical subdivision doesn't require is a scale model of each house before it is built. Project designer John Hofacre uses the models to make sure the roof line or height of one house won't be shading the solar collector of the house next door.

- 50 for R-25 insulation in the roof (more than if the normal R-19 thickness was used)
- 500 for better quality aluminum sash window frames, which don't leak air at the joints
- 10 for insulation of the hot water lines in the concrete slab floor
- 2,400 for the tile floors or water-filled drum-walls of a passive solar space heating system. This figure also includes the cost of a natural gas forced air back-up heating system, although some of the newer houses are using wood stoves for back-up systems, which are considerably cheaper.

or

- 5,000 for an active solar space heating system.

There is no extra cost involved in using water-saving toilets and shower heads, or in properly aligning the house to face the south.

Solar Rights

One of the considerations still being worked out by the Homeowners Association at Village Homes, and by the city of Davis, is solar rights. You spend the extra money for solar collectors and double paned glass and six months later your new next door neighbor decides to plant a row of poplar trees. What, or who, gives?

The formulation under discussion in Davis would say that nothing can shade any of the south-facing glass or solar collectors on a house for more than 40% of the total hours each day that the sun could fall on them. This 40% figure is further broken down to 20% in the morning and 20% in the afternoon, and it can only be the early morning and late afternoon sunlight that is blocked, in other words, when the shadows are longest. These early and late rays hit any window or collector at quite an angle anyway, and many of them will be reflected away rather than penetrating. What is crucial to preserve are the midday hours of direct sunlight. With such a regulation in force, it is easy to visualize a lot of tree pruning and clock watching going on each year around the time of the winter solstice.

Village Homes has expanded the horizons of the Davis city government and regulatory bureaucracy, and has managed not to alienate them. The same is not true

◀ The notion of a vacant lot implies that if it is physically possible to build on it, then inevitably someday somebody will. This is a lot, but it is not vacant. It contains an orchard of apricot trees, and they belong to the community. You may not get to know your neighbors here when it is time to prune the trees, but when the fruit is ripe you're bound to.



Most subdivisions begin with land leveling and the installation of streets, sidewalks, gutters and storm drains. Rain that falls on the street is collected and carried away in expensive buried pipe. Here the lay of the land — the natural watershed system — is preserved. The gutter of this street dips to let runoff flow into this small creek, where it can soak back into the earth. These waterways are designed so that most of them will dry up every third day (during the rains' season) to discourage mosquitoes from breeding. Where this doesn't happen, fish will be used to control the larvae. Should all of the waterways fill, they will then flow into an emergency inlet into the existing city storm drain system before they can overflow. In a drought year like this, that would be a welcome sight indeed.

of the Federal government. Village Homes is not approved by the FHA for government supported low-interest housing loans. In seeking FHA approval from the Department of Housing and Urban Development, Mike Corbett ran into a bureaucratic stone wall.

In previous interactions with local governmental and lending regulations, Corbett has negotiated, educated and compromised. On rare occasions, he has ignored the rules. For example, the showers in his newer homes have two drains in the floor and a switching valve. One goes into the sewer; the other into a pipe and outside for grey water irrigation. It's strictly illegal, but the new owner won't have to jerry-rig a system or use buckets to keep his trees alive the way thousands of people throughout the west are doing this year. Changing the rules only after so many people have broken them that it has become a farce does not particularly enhance the integrity of government.

The FHA had lots of objections to the plans for Village Homes. They didn't like the parking bays and they

thought the lots should be laid out radially to the curving streets — the way it is normally done — which would have made the uniform south-facing alignment of all the lots impossible, in effect scuttling all of the energy-conserving design features with one single requirement. This quotation from a regional FHA official to Mike Corbett is typical: "... the maintenance of horses, poultry or other farm animals in the subdivision area is incompatible with the desires of typical homeowners and would exercise an adverse effect on the future marketability of properties."

Corbett smiles as he recounts the hassles. The irony is that his subdivision is not that revolutionary really; 90% of it is due to the premeditated application of common sense. He has buyers, and plenty of visitors stopping by for a look. And the housing industry has an example of how future suburbs might be done a little differently. ■

Instead of backyards with fences running the property lines, Village Homes provides a common area to be shared by every eight houses. The backyard of each house abuts this 1/3 acre space, which also contains the bike path. Neighbors decide how the common land will be used. If they opt for some chickens and goats, that's fine. Backyard sun-bathing in your birthday suit may also involve community consent. Notice the concrete tile roof. Initially it costs twice as much as asphalt shakes, but it is light colored (reflecting the summer sun and keeping the house cool), American made, and will last 100 years.



Solar building code

A proposal for adapting an energy-saving ordinance and solar building code for the city of Davis, California. This report has been well received by the city government and has been adopted with some modifications. A surprising result of the study is the finding that household energy use could be cut about 50% with little or no degradation of service and without resorting to bizarre architecture or sophisticated hardware. Merely installing good insulation and, for instance, shading windows in summer can cut energy use dramatically in conventional structures. The effect is much greater than had been supposed. Properly designed new buildings could show even better savings. Recent work of the authors indicates that if approximately half of the money needed for a proposed nuclear power plant was spent giving insulation to the homes it would serve, the energy saved each year would exceed that generated by the proposed plant, which would then not have to be built!

I consider this report to be very important. It is competently researched with actual measurements, and is well presented. With figures changed to fit local climate, it could well serve as a model for communities now considering similar ordinances.

— JB
[Suggested by David Bainbridge]

A Strategy For Energy Conservation
(Proposed Energy Conservation and Solar Utilization Ordinance for the City of Davis, Calif.)
Jonathan Hammond, Marshall Hunt, Richard Cramer, Loren Neubauer
1974; 51 pp.

\$ 5.00 postpaid
from:
Living Systems
Rt. 1, Box 170
Winters, CA 95694

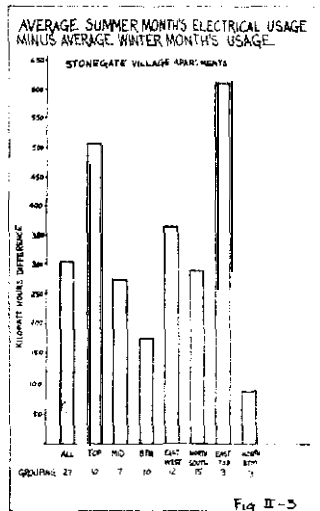

Energy use data for 27 apartments in another portion of the Stonegate Village complex was obtained and analyzed. (The data was provided by the Davis Office of the Pacific Gas and Electric Co.) Figure 1-3 shows the results obtained by subtracting the average winter month's electrical usage from the average summer month's usage. This was done to emphasize the energy consumption dictated by the architectural design of the units.

The top floor apartments were twice as energy consumptive as the middle floor apartments, and nearly three times that of the bottom floor apartments. The very high usage figure for the top floor apartments is due to inadequate roof design. The top east side apartments were the most energy consumptive because they not only had unsatisfactory roofs but also receive early morning direct solar heating through the large east facing windows. In these apartments the air conditioner must start early in the morning and run all day.

The Roof

When it is time to re-roof use a light colored material; it will be 60° cooler in the sun than a dark material. Aluminum roofing is also cool in the summer. Rigid insulation can be added on top of the roof deck.

Roofs should be shaded by trees located on the east and west.

Energy Conservation Code Workbook

The City of Davis, California actually voted in the "solar building code"! Though not especially radical to those interested in ecological righteousness, the code has brought screams of outrage (as well as code-meeting neighborhoods) from developers. This booklet is intended to facilitate application for building permits. The preparation of this information was sponsored by HUD as part of the work done under the grant that backed the studies resulting in the code. Give credit where it's due: this enterprise has largely been done right! Inevitably, this demonstration will be the model for many other community energy codes.

— JB
[Suggested and partially prepared by David Bainbridge]

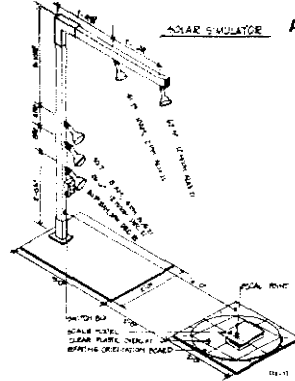

Energy Conservation Building Code Workbook
Marshall Hunt, Ed.
1876; 122 pp.
\$6.00 postpaid
from:
City Hall
Davis, CA 95616

Your Home's Solar Potential

If you already have a house, how do you go about figuring out if there is any sense in retrofitting a solar heating system? Hiring somebody to check out your place can be expensive, and doing it yourself is likely to prove difficult unless you have training. But with the help of this book, you don't need the training. What it amounts to is a list of things to check; things like roof angles, compass orientation, and local climate. By using an evaluation system given, you score the various categories. A final overall score is compared with a rating scale that tells you whether it makes sense to go solar with your house. This is a nifty way of getting at this sort of work, but I do wish the book had been published a little less slick at a little less price. Even so, it's a lot less than hiring someone, even assuming there is someone competent nearby to hire.

— JB
Your Home's Solar Potential
Irwin Spetgang and Malcolm Wells
1976; 60 pp.

\$9.95 postpaid
from:
Edmund Scientific Co.
100 Edscorp Building
Barrington, NJ 08007

Good Shelter

Face it, most of us are going to rent until we can build or buy. But with the cost of new homes being what it is these days, and the cost of interest on the mortgage being as high as 190% of the "cost" of the home, many who can buy or build will be involved with a mobile, modular or prefab home. If you're going to go that route, you'd better know what you are getting into. This is where to find out. Dome kits are covered too.

— JB
[Suggested by Paul Kokesch]

Good Shelter

(A Guide to Mobile, Modular, and Prefabricated Houses, Including Domes)
Judith and Bernard Rabb
1975; 171pp.

\$7.95 postpaid

from:
Quadrangle/The New York Times Book Co.
Harper & Row
Keystone Industrial Park
Scranton, PA 18512
or Whole Earth

Energy Basis for Man and Nature

Howard Odum's first presentation of these concepts in *Environment Power and Society* (CATALOG, p. 8) did not lend itself to easy perusal by laypersons. This book is much more clearly organized. Consequently, the information is more likely to be understood by persons who need to know it but who couldn't manage to slug their way through the previous book. Such as politicians. I've heard it said that making it all this clear also has illuminated flaws as well, flaws arising mostly from the broadness of the generalities. But I don't count this as a problem. There are so many important ideas here that a flaw or two only whets the mind and shows how much further the Odums' ideas might be carried. The book is set up to be used as a textbook, and I may well use it as that in the course I teach.

- JB

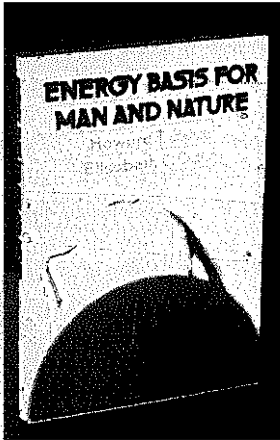

Energy Basis for Man and Nature
Howard T. Odum and Elizabeth C. Odum
1976; 297pp.

\$13.95 postpaid
from:
McGraw-Hill Book Co.
c/o Trade Order Service Dept.
Princeton Road
Highstown, NJ 08520
or Whole Earth

Solar heating of houses and water uses much fossil fuel indirectly in the installations. Solar heaters have been used for a long time in sunny climates. Figure a and b compares a solar water heater and a fossil-fuel water heater. In this case solar energy is being used to make low-quality heat energy. In sunny climates, using some sunlight along with fossil fuels, energy is saved by solar heaters as compared with electric and gas water heaters. However, solar heaters use much more fossil fuels than solar energy when they are compared on an equal-quality basis (fossil-fuel equivalents). No net energy is

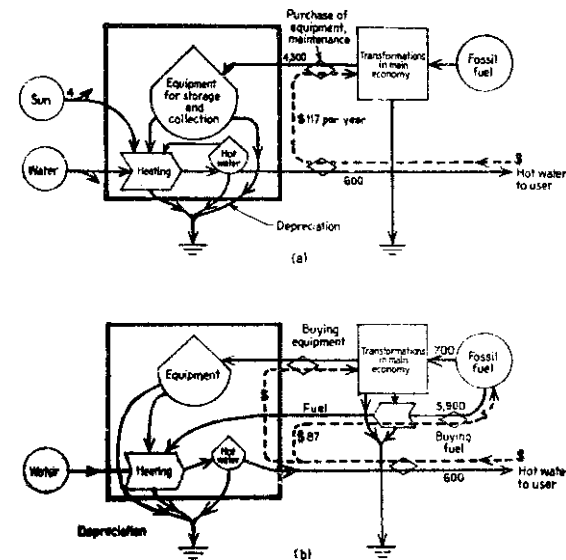

Energy flows in solar technology: comparison of (a) solar water heater and (b) fossil-fuel (gas) water heater. Numbers are thousands of Calories per year (fossil-fuel equivalents). (Zuchetto and Brown, 1975.) Both systems use fossil fuel indirectly to supply and maintain equipment. The solar heater takes more equipment but uses less fuel directly. The fossil-fuel heater involves less equipment and storage and less depreciation but requires the purchase of fuel.

Jobs & Energy

This deadly paper brilliantly illuminates (by natural means, of course) the realities underlying the conventional wisdom excuse that a clean healthy environment means loss of jobs. This is the stuff of the Next American Revolution, I'll bet, and ought to be required reading for just about anyone older than 12. The rapier of Hazel Henderson is involved here too; she's one of the directors of this outfit. (This price puts you on their mailing list for future papers which will include "Jobs and The Economics of Job Safety," and "A Guide to Employment Impact Statements." Tax-deductible, too.)

-JB
[Suggested by
James Edison Notestain]

Jobs & Energy

Richard Grossman and Gail Daneker
1977; 21 pp.

\$7.50 individual
\$15.00 institutional

from:
Environmentalists for Full Employment
Room 300
1785 Massachusetts Av. N.W.
Washington, D.C. 20036

The report stressed that employment associated with energy conservation techniques is local, low- to moderately-skilled, and concentrated in or near urbanized areas which are experiencing the most acute unemployment problems. In

contrast, centralized, expensive energy production complexes usually have to bring in highly-skilled labor from outside the construction area. (These transients create a large amount of disruption: temporary housing and many services must be supplied to meet the problems temporary workers create. In many of the energy "boom towns" of the Western United States, crime, alcoholism, family break-ups are well above average. Serving the needs of transient labor ends up being a drain on the local economies the transients were supposed to be stimulating.)

CAPITAL INVESTMENT PER JOB

Industry	Capital investment per employee
petroleum	\$108,000
public utilities	105,500
chemicals	41,000
primary metals	31,000
stone, clay, glass	24,000
all manufacturing (average)	19,500
food & kindred products	18,000
textile mill production	11,000
wholesale and retail trade	11,000
services	9,500
apparel and other fabricated textiles	5,000

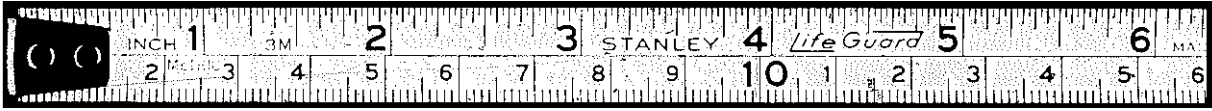

I take one of the central evils of our time to be the steady encroachment of universal liquidity, where everything is readily transferable into everything else, a relentless marketplace planet with everything for sale. Nothing remains truly native or isolate. It is all much too quick and connected and dangerously unstable.

Examine in this light the possibly healthful functions of difficult language translation, trade tariff, border official bribe, suspicion of strangers, or money exchange fee; of variant legal systems, ethical systems, measuring systems. Crossing each of those transitions involves a delay (good), a bringing to consciousness of otherwise unconsidered routines (good), a constant re-evaluation (good), another degree of complexity (good), a barrier to overspecialized efficiency, a "fringe" where life is always more abundantly diverse.

Universal liquidity is a barren sea.

Metricizing the world is a bad idea.

—SB

METRIC SYSTEM

PRO:

YOU can divide things by ten.

CON:

BY STEVE BAER

LET'S NOT SWITCH TO THE METRIC SYSTEM

The Decimal system and its sidekick, the Metric system, are a smug pair. Ready to count or measure anything in the universe, they appear almost bored with the task. The world is filled with puzzles, contradictions and irrational occurrences. Yet these two who appear on such occasions refuse to share in the embarrassment. A little rounding off— perhaps a new symbol— and they are on their way.

How does one go about registering a complaint about their manners? Even bringing up such an idea could lead to hours of patient explanation by mathematicians and engineers:

"Mr. Baer, I am afraid you don't understand the basic idea of counting or the purpose and usefulness of measuring things. Why, how do you think the rubber in the soles of your shoes was manufactured— how do you think the rivets in your Levis were made?"

And so on and so forth.

I am trying to learn how to reply. What is the matter after all? How can you object to numbers or meters or kilograms or degrees centigrade?

One problem is that the Metric system is foreign. We didn't grow up with it. How could Americans ever talk about a hot day being forty degrees or driving at one hundred kilometers per hour. That's not what we say. And this is reason enough not to change. So what if forty degrees centigrade is the same as 104°F. It doesn't sound the same. In fact it is actually somehow just a little different.

Measurements are used in both descriptions and calculations. Because the Metric system makes it easier for people to do calculations is no reason for us to throw out our old English system. Let those who want to calculate, calculate. Let them solve their own problems without persistently destroying our very language. A road sign reading in kilometers doesn't tell you any more than a road sign reading in miles. Perhaps you could sympathize with the shift to the Metric system if someone could lead you to an



enormous bureau where clerks were doing endless calculations-- inches to miles, ounces to tons. If you could see the victims of our outmoded English system you might finally relent. "Oh, all right-- I see the suffering-- we'll learn the new system, we'll go along with you."

Perhaps this was true in the past-- people did suffer. I suffered. It is hardly true today. Now we have the pocket calculators. They are cheap; they work well; they can convert anything to anything. You just press a few buttons.

There is absolutely no reason to bend for the conveniences of the engineers and the bureaucrats-- they don't need our help. They have already helped themselves. Any effort on their part to make us convert is simply cruel and stupid. They only want their stamp of rationality spread to where it has no business. They want all of us to bow a little more deeply to them.

You know where the English foot came from-- it is the length of your boot. Maybe not exactly, but close. And the inch-- it is the width of your thumb.

Where did the meter come from? It came from the North Pole, before anyone had even visited the North Pole. The meter was originally defined as 1/10,000,000 of the distance from the equator to the North Pole.

Let the astronomers and scientists have their Metric system, but let's protect our own English system.

Not only does the English system offer us nice hunks of space and weight as basic units. it also exercises different notions of divisions and symmetry. Two cups to a pint. two pints to a quart, four quarts to a gallon. And then in weights, sixteen ounces to a pound. Here is the binary system introduced to every school child -- used for life by every citizen. It is beautiful-- splitting things in half and then in half again. The Metric system, trotting along side the Decimal system, avoids such an approach by burdening simple fractions as 1/16 with lengthy decimal equivalents.

Twelve inches in a foot. How interesting it is to deal with twelve. How amenable it is to division compared to ten. the base of the Decimal system. Look at twelve's divisors-- 2, 3, 4, 6. What a generous disposition it has. We can be thankful that twelve and its multiples-- 24 and 60-- are holding on even in the Metric system which continues to use the same calendar and clock as the English system. But this may not last the century. Already the Canadian Metric Association recommends shifting to the Metric Day;

the chrona = 1/10 day;
 the centichrona = 1/100 day;
 and the rema = 11100 centichrona.

And then there is the argument of the industrialists.

The world needs common part sizes. Bolts and nuts should be the same the world over. The thread should be cut on the same pattern. I am not sure this is true. Why should a Belgian bolt fit a Canadian nut? If we do grant the industrialists their common bolt sizes, this still shouldn't threaten the English system. We can afford to exchange our 1/2" bolts for 12 centimeter bolts.

The great shame is that as systems of measure extend they cease to be simply measures. They become, instead, recommendations for the sizes of things. Unfortunately it takes a certain amount of nerve to make something an odd size. to pay no attention to these recommendations which reach us as a kind of background hum.

Le Corbusier realized the effect that measuring instruments have on the sizes of things. Not to be beaten by such an instinct, he sought to benefit from it by introducing his Modulor-- a scale of measurement having nothing whatsoever to do with the Metric system or the English system. In Le Corbusier's *The Modulor* and *Modulor 2* he describes in great detail his scale based on the dimensions of the human body and growing out into space not by multiples of ten or twelve, or two or three, but by the divine proportion,

$$\frac{1 + \sqrt{5}}{2}$$

Rectangles made with their sides in the divine proportion are especially pleasing. A scale of such dimensions has the nice property that the sum of two consecutive intervals equals the next larger interval. Einstein said of the Modulor, "It is a scale of proportions which makes the bad difficult and the good easy".

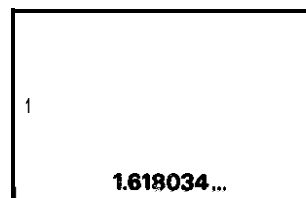

Golden rectangle

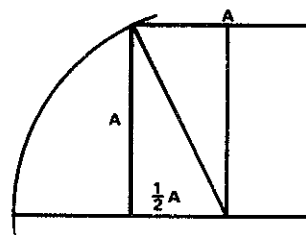

How to construct a golden rectangle



This seems to me to be one of the most enlightened and sensible efforts that a man has ever made. Here was someone really grappling with the promise of mathematics and uniformity; someone not discouraged by the fact that our number system seems almost to resent stating his proportions-- for how clumsy an expression

$$\frac{1+\sqrt{5}}{2}$$

or its decimal equivalent

1.618034. is. Today the divine proportion can appear among the keys of the pocket calculator along with pi. The Modulor divisions can be repeated on tape measures as different colored lines. Let's keep the English system and add the Modulor, and then be alert for still more useful measurements.

Let us beware of anyone trying to take the seven day week away from us. Primes such as SEVEN are so ungainly it is a comfort to have seven at hand metering out the days in a week. What a relief that the week isn't even; what a relief that it doesn't have ten days! We need variety.

WHO NEEDS SYSTEMS OF MEASUREMENT?

Nature builds deltas, clouds, and mountain ranges all without counting. There are birds, flowers, centipedes, and yet we never find any numbers-- no sheets of calculations.

Dead leaves, tail feathers, snake skins, but no calculations. We don't dig into a mountain range searching for the meter stick used in its construction. It isn't there. The parts themselves know what to do. The rocks tumble at the bottom of a flooding river-- the water evaporates into the air. As one thing follows its pattern it sets other patterns.

Nothing balks. The whole world talks and works at the same time.

Why is it that we need number systems, measuring systems, calculators? Don't you suppose the material we use in establishing such systems resents this? Who are we to place matter in such limbo?

Why make wood into a yardstick that only holds paint marks in place? What a boring task-- what a pompous thing to be occupied with. More and more of the world is relegated to remembering and ordering. Libraries full of cardboard, paper and ink; metal taken out of the ground for statues and historic markers; stone quarried from a mountain side to be chiseled into ungainly shapes and patterns. Any time that measuring and accounting can be forgotten and the materials handled spontaneously, I'm sure nature is more comfortable. A foot is a foot-- why have a painted piece of wood repeating what is already said at the end of your leg?

RECOMMENDED READING

For an excellent defense of the English system of measures see:

John Michell, *City of Revelation*, Abacus Books, page 112. also;
John Michell, *Traditionalist Manifestos*-- "In Defense of Population", an essay.

For more on the Modulor and the Divine Proportion see:
Steve Baer, *The Zome Primer*, Zomeworks Corporation.
Le Corbusier, *The Modulor and Modulor 2*, The MIT Press.
Anne Tyng, "Geometric Extensions of Consciousness"-- an article in *Zodiac* 19, Milan, Italy.

For the Metric system see:

H.F.R. Adams, *Metric Units*, McGraw Hill Paperback.
Helmer A Ronningen, *Metrics, Measurements for Tomorrow*, Collier Books.

Neither of the books on Metrics is very interesting, but they probably aren't meant to be.

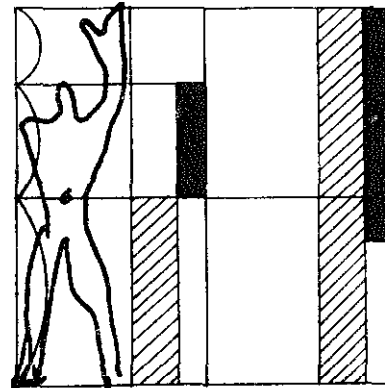

Le Corbusier's Modulor

"SCRAPS"

from *Investigations Comparing the Metric System and the English System of Measures*.

ABOUT MODULOR: I think one of the difficulties that people have had in using the Modulor is that the divine proportion does not appear as a simple expression in our number system. Those who wish to use it continuously translate back and forth between powers of the divine proportion and the decimal system. Almost as if they were speaking a new language and were able to use the nouns but not the verbs.

It is interesting to find that if you are dealing with geometrical systems with five fold symmetry such as the regular pentagon and star in two dimensions or the icosahedron and dodecahedron in three dimensions, the Modulor is the natural unit of measurement.

Strangely enough Le Corbusier was not interested in such geometries. In fact he especially detested the uses he had seen of the starred icosahedron and dodecahedron. (See *Le Modulor*--page 72.)

WHAT ABOUT NUMBERS? Are they all they are claimed to be? What do our numbers really tell us? Do they do any more than merely suggest something about the quantities we ignorantly presume they represent? What about the number 37,541,327,895,368,714,321,999,527? This is an enormous number. I expect that I am the first person to ever write it down. Should I notify Mr. Vapanek, my patent attorney? No! These are coordinates of a place I have not visited. We must demand



that the location be homesteaded before we express our awe and wonder.

Is my number the cube of another integer? Is it the cube of a cube? Is it, instead, a prime number? Is it, instead, an even number? Perhaps a number divisible by 21? The number isn't impressive until I know answers such as these.

The mathematicians will tell me I have missed the point—that I don't understand the meaning of numbers. But I suspect there are surprises in store for even the sober mathematician.

I would like to propose another way of counting. One that would make it a challenge to name even the number of weeks you had lived.

Prime numbers are numbers that can't be arranged in a rectangular array—single lines excepted.

Every number is either a prime or the product of smaller primes. I would like to suggest a number system where each prime would have its own name. . . .

1	2	3	4	5
lead	coal	silver	coal.coal	slate
6	7	8	9	10
coal.silver	iron	coal.coal.coal	silver.silver	coal.slate
11	12	13		
gold	coal.coal.silver	uranium	etc.	

Most simple equations would involve a fairly safe journey into the unknown of larger numbers since a product is safely bred from existing stock. But what about a product + another quantity? The question then arises, what is its name? How is it formed? There would be no simple answers. In the lengthy shuffling where construction by the rectangular array is attempted, a great deal would be discovered about the properties of the new quantity.

If we were on a ship without measuring instruments and we needed a unit of length, someone seeking harmony would want the unit to be 1/100 of the ship's length. To find what 1/100 of the ship's length was, the ship would likely be measured with some convenient stick marked off repeatedly on the deck.

I think the convenient stick chosen to measure the ship would probably be a better candidate for a unit of length than the divine 1/100 of the ship. On what other grounds would the stick have been chosen?

Systems of calculating and measuring are divine links between ourselves and our technology. They are part of the womb in which machines are created.

Animals produce other animals by breeding. Our equipment is made, altered or repaired while surrounded by measuring instruments and calculations.

Compare the breeding of animals or the propagation of plants with man's constructions. How in the tiny, tiny space of a seed are the construction instructions passed on? Nature is baffling. She must take an entirely different approach with matter than we do. Perhaps it is a kind of inspired leadership that the sprouting seed offers to the materials around it. The seed can't find the same reluctant dirt and water that we do. These same substances must in fact be swarms of molecules only too happy to enlist in the construction of a blade of grass or a tree.

One goal of measurements and calculations seems to be to get ahead of the world. A race to the inevitable. Fleas racing among themselves along the nose of a race horse racing across the finish line.

Some English conversions to remember:

1 gal. = exactly 231 in.³, 231 = 3·7·11

1 cubic foot of water at room temperature weighs 1000 ounces. (Linus Pauling mentions this somewhere.)

1 mile = 5280 ft., 5280 = 2·2·2·2·2·3·5·11

One reason 5280 is such a good unit of measure is that it has so many small primes as factors.

The same with 360 as 360° in a circle. 360 = 2·180 = 2·2·90 = 2·2·2·45 = 2·2·2·3·15 = 2·2·2·3·3·5

The Metric system never even recognizes any factors but 2 and 5.

Boycott the Metric System

The centimeter is unloveable, inhuman, and not even really convenient. It is the chill breath of a vicious Fascist conspiracy. We welcome, therefore, two towering allies in our fight against the Metric which begins with Steve Baer's diatribe "Metric System Con."

First, economist and behavioral scientist KENNETH BOULDING, writing in the December 1975 issue of Technology Review:

. . . The metric system is a preposterous historical accident, with very little to recommend it but popularity. Its units are arbitrary and it is not even consistently decimal: time is still measured in Babylonian sixties. What's more, the scale of ten is much inferior both to the scale of eight — which at least is binary — and the scale of 12 — which is both binary and ternary. What is so great about five times two? The metric system is the triumph of French revolutionary logic over good, sound folk measures that have psychological meaning. Measures such as the foot, the yard, the bushel, the furlong, and the acre all originate in human behavior. The Celsius scale is just as arbitrary as Fahrenheit and psychologically less satisfying. . . .

The rest of the world is probably right to bully us into adopting the metric system since it's convenient for everybody to tell the same lies. But let us not pretend that the metric system has any scientific foundation and let us not give it the benediction of the scientific community.

Next, the formidable historian EUGENE ROSENSTOCK-HUESSEY in the chapter on France in his opus Out of Revolution (suggested to us by Richard Baker):

THE TYRANNY OF THE DECIMAL SYSTEM

We can see this French use of mathematics very clearly in a question of world-wide interest: the decimal system. The fog of aovidupois and troy weight was dispersed. Water, Adam's ale, was made the cornerstone of the new natural system of weighing and measuring bodies and distances. A thousand grams of water are one litre, and a litre is a cubic-decimeter or 1000 cubic centimetres of water. The metre, again, is in connection with all nature, being the ten-millionth part of a quadrant (a quarter) of a meridian, from the Equator to the Pole. Its standard is a piece of platinum kept at Paris. The grand conception of "nature" could not be better expressed than by this new constitution for nature. The old measures, foot, yard, acre, rule, grain, pint, etc., were all taken from the near environment of man: his own body, his fruit, his soil, served as sources of his language. The French Revolution speaks in the name of nature. It starts from the Equator and brings home one forty-millionth of its circumference for practical use. The idea is universal, the adaptation is made by subdivisions. Man truly becomes a grain of dust on the globe in the same measure that he believes in the metre as one ten-millionth of the quadrant of his planet.

Decimal numeration and decimal systems are not "natural" in the way of common sense. Dozen, score, and hundred-weight contradict the hypothesis that ten and five are more natural than 4, 12, 20, and 112 or 120. They are not. Not even the natural logarithm can be based on ten-ten in the abstract. The decimal system ought rather to be called an abstract or reasonable system.

Furthermore, the decimal system reveals the real meaning of "nature" in the French language. "Nature" is not the noble savage, but the reasonable Robinson Crusoe, not the blushing Adam, but the reflecting Voltaire; it should not be called "nature" but "reason," and should be written in capitals: REASON.



An Index Of Possibilities (Energy and Power)

A catalog of ideas and beliefs, conjectures, "readable scientific apocrypha," and "did you realize that people are doing this?" At first I thought this was yet another hippy-dippy undocumented generalized turn-on. But it isn't. I keep reading it when I should be doing something else. I keep finding out about things that I have been wanting to find out more about. The information is admirably cross linked, enabling you to voyage through a number of disciplines as you follow a chosen theme. This tends to encourage you to synthesize unusual combinations; something that more formal books actively discourage or even prevent. They recommend you use the excellent index thus: "... stab blindly with pencil, machete, finger or letter opener; move to the page indicated." Universe, Earth, World, Body, Mind, God, and Fundamentals are the main chapter headings. The approach ranges from strict scientific (with appropriate technical formulas and definitions), to metaphysical and even utterly mad (probably). Fascinating! This is the first of a

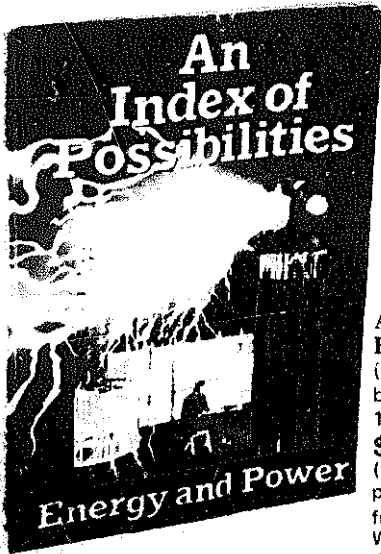

series too, which is good news indeed. A U.S. edition will be out later this year from Pantheon. Now, if you'll excuse me...

—JB

An Index of Possibilities (Energy and Power)
by "The Catalogue"
1974; 292 pp.
\$6.00
(2.50 pounds)
plus shipping
from:
Wildwood House Ltd.
#1 Wardour Street
London, W1, England

Ecodevelopment News

This new bulletin is the best way I know to see what's going on in "Appropriate Technology" and its political aspects in the rest of the world. It consists of brief articles (happily these are readable!), and a succinctly annotated bibliography as well as news. This service has been needed for a long time, and I am pleased to report that these people are doing it very well. They invite your input and (in my opinion) deserve your support. Available in English or French editions (specify).

—JB

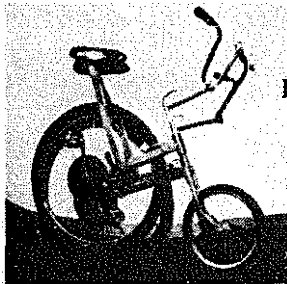

Ecodevelopment News
Write for information, price, etc., from:
International Research
center on Environment
and Development
54, Boulevard Raspail
Bureau 309
76270 Paris Cedex 06
France

The Secretary for Government Planning in the State of Sao Paulo launched a public contest in 1975. The photo above shows the prototype of the winning bicycle; its construction is better adapted to environmental conditions and more economical to produce than the classic model.

Appropriate Technology Sourcebook

The idea behind the Sourcebook is to provide access to practical plans and books on village technology, small community technology, and alternative technology — materials currently in print only. We wanted to enable a reader in Indonesia, for example, to find material of value and relevance, and know something about what he/she was going to get before laying out the rupiahs to get the pubs. In that country, for example, \$10 represents a month's salary for a field worker. You're careful what books you buy under the circumstances! Well, the book has been well received — it is being used in more than 80 countries and every state in the U.S."

—Ken Darrow

This is the best AT bibliography for those who are actually getting their hands dirty, and it's a fine bargain at the price, too.

—JB

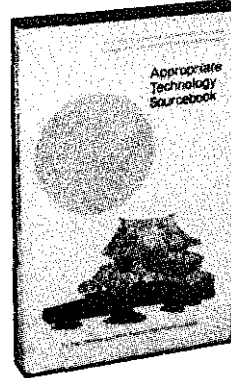

Appropriate Technology Sourcebook
Ken Darrow and Rick Pam
1976; 304 pp.
\$4.00 postpaid

from:
Appropriate Technology
Sourcebook
Volunteers In Asia
Box 4543
Stanford, CA 94305

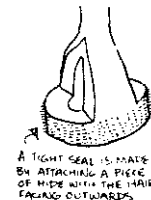
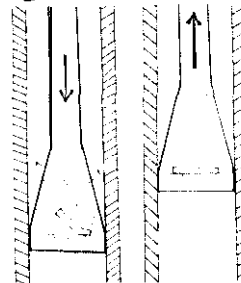

This is a water pump with a piston made entirely out of wood, except for a small piece of old rubber tire that serves as a flap valve.

The outer cylinder can be steel or iron pipe, bamboo, or a hollowed out log. This kind of pump is used on the small boats operated by the Bugis sailors of Sulawesi, Indonesia. The pumps are about four inches in diameter, and are used to pump water out of the hulls, a distance of 3 to 4 meters. We have no figures on the volume of water this kind of pump can lift in an hour, but they are surprisingly effective.

Economically Appropriate Technologies for Developing Countries

Bibliographies usually don't make Book-Of-The-Month, but this one is so well annotated I read it from cover to cover! The subject matter is one of those "coming things" that isn't quite in the everyday public eye yet Dr. Carr's fine work should help.

—JB

Economically Appropriate \$7.25 airmail
Technologies for Developing Countries

(An Annotated Bibliography)
Dr. Marilyn Carr, compiler
1976; 101 pp.

from:
Intermediate Technology
Publications
9 King St., London WC2 E
8HN England

Cabanos P., *Jeepney Manufacturing in the Philippines: A Model for Developing the Agricultural Machinery Industry, Agricultural Mechanization in Asia, Autumn 1971.*

Describes how the 'jeepney' industry started in the Philippines after World War II, based on a preponderance of cheap surplus material and a great need for public conveyance. The jeepney is a low cost, simple vehicle based on a re-conditioned engine (in 1971, a jeepney capable of carrying 12 persons cost \$1,600). As soon as the concept was developed, small shops producing crude versions cropped up almost overnight, and the industry has flourished to such an extent that annual sales in 1971 had reached 17 million dollars.

Other Homes and Garbage

This book is yet another overview of possibilities open to those interested in "self sufficient living," "alternative energy," and like that. But it's the best one. If you're not well informed in such matters, reading this through will fill your hopper, and there are enough numbers given to let you test the feasibility of your wildest fantasy. (For tight-standards work, though, you'll likely need more.) It's unusually well-researched and beautifully illustrated. No rehashed reprints here.

— JB

Other Homes and Garbage

Jim Leckie, Gil Masters,
Harry Whitehouse,
Lily Young
1975; 302pp.

\$9.95 postpaid

from:
Sierra Club Books
c/o Book Warehouse Inc.
Vreeland Ave.
Totowa, NJ 07512
or Whole Earth

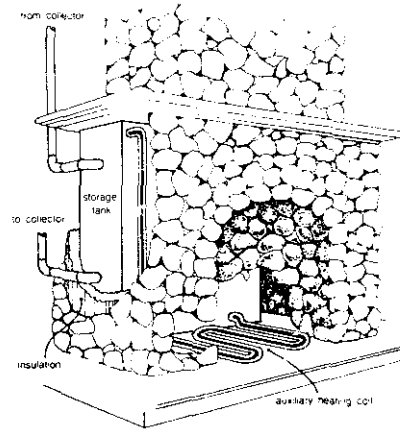
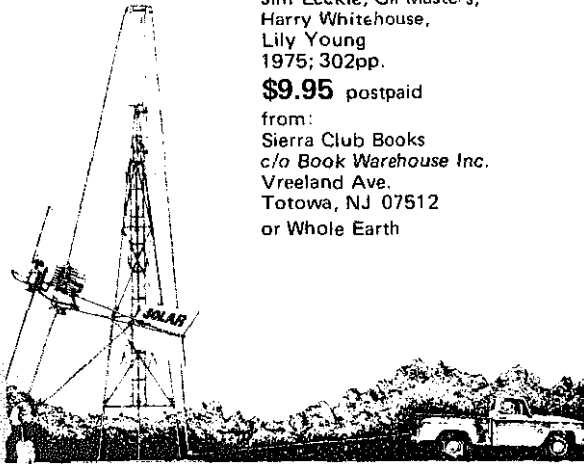

An integrated fireplace/storage-tank design (fireplace can be used as auxiliary heat source).

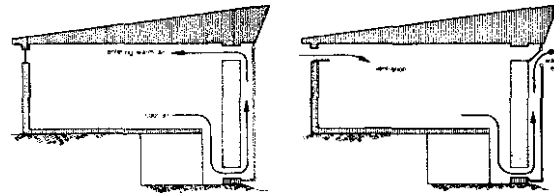

The Trombe-Michel house: winter and summer operation.

Radical Technology

Ah yes. Wind machines, poorly detailed solar collectors, goats, pyramids, and typical bourgeois schemes masquerading as environmentally OK because they are wearing the less-embarrassing pre-washed Levis which make them look like they've been working. You can find lots of books that look like this one in any "organic bookshop". But this book is different. It has sharp criticism of society and just about everything else you might think of (done in that sly British manner) and this is coupled with the best presentation of "Visions" of what may be done that I've seen. The emphasis is on changing social order by taking responsibility for your actions into your own hands. The publishers blurb calls it "the encyclopedia of a multifaceted quest". The only book in this part of the culture that I have personally found exciting and excited. It's by the Undercurrents people (EPILOG, p. 538).

— JB



Radical Technology

Godfrey Boyle and
Peter Harper, eds.
1976; 304pp.

\$5.95 postpaid

from:
Pantheon Books
Random House, Inc.
455 Hahn Road
Westminster, MD 21157
or Whole Earth

Ideological forces are just as much at work in academically influential studies of modern ecology. Howard Odum's *Environment, Power, and Society* (Wiley, New York, 1970) is a particularly obvious example, in which the author's views on "power and society" are dressed up as energy-flow diagrams and made to seem logically necessary.

"Radical Technology" is a very vague term we decided to use because, having rejected "Mutiny on Spaceship Earth", "Moulin Rouge", "Bicycles of the Gods" and other such gems, we couldn't think of a better title for the book. For a long time we referred to it as "The Alternative Technology Book" because "alternative technology" — or "AT" as it is known in the trade — is by far the most widely accepted umbrella term for wind-generators, methane-digestors, autonomous houses, solar stills, etc., etc. But this was exactly its problem. It was too much associated with pure gadgetry, especially of the merely environmental variety, for use by the affluent to soothe their consciences and amaze their friends at a safe distance from the cities.

We wanted to express an ideal of technological organization that was part of a total movement towards a new form of society; but at the same time to assert the belief that technology itself matters, not just who controls it — that, in other words, not only the relations of production, but the *means themselves* must be changed to permit the achievement of a just, stable and fulfilling society.



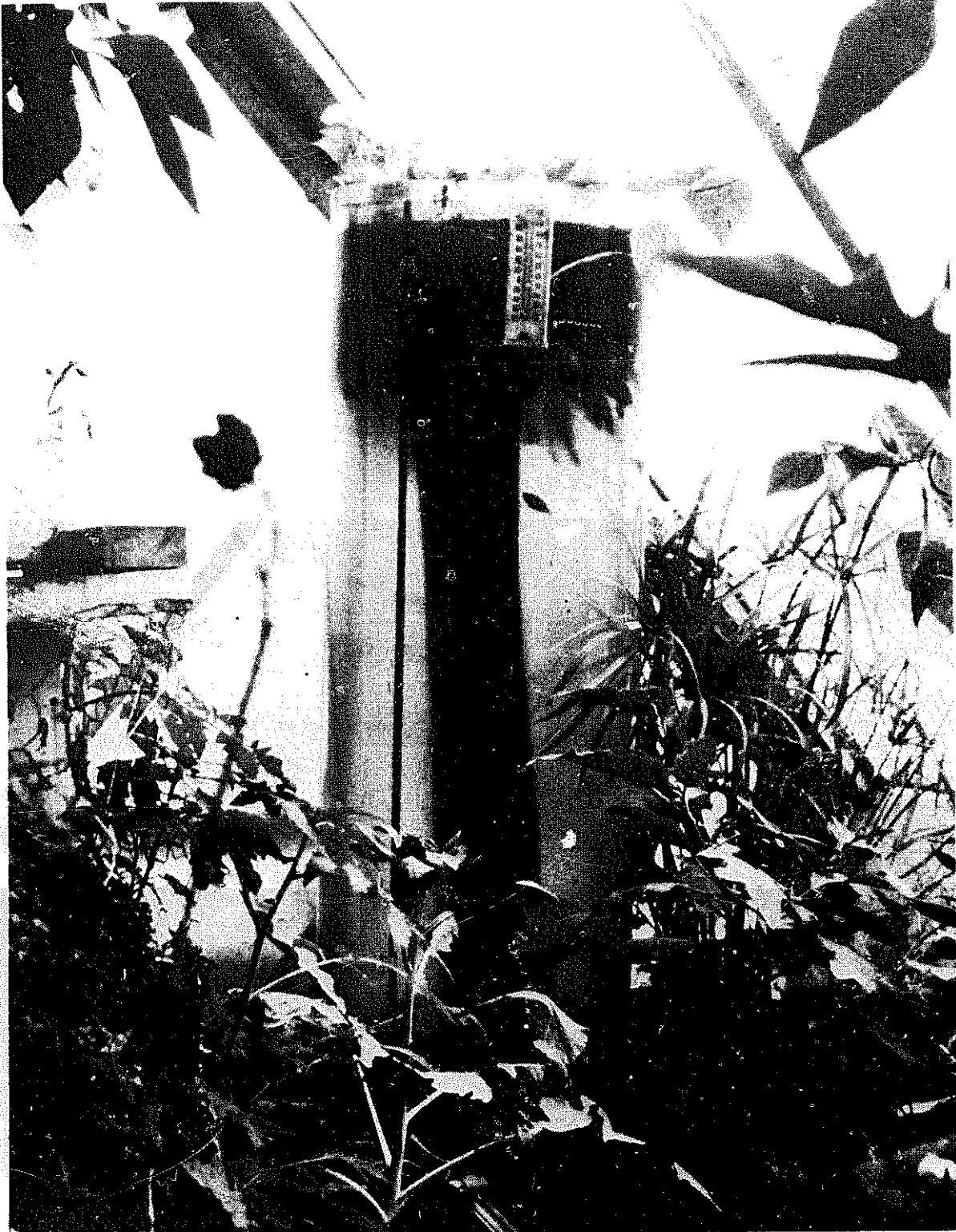

inside the test model for the Cape Cod ark. Amid a diversity of tropical and food plants, a "solar tube" traps and stores solar energy, while culturing algae and fish. Sunlight enters the building through one layer of Kalwall and three layers of the Suntek membrane developed by Day Charoudi and Sean Wellesley-Miller. The habitat remains tropical in mid-winter Massachusetts.

The New Alchemists

BY JOHN TODD

The Alkies have been much in the press in the last few years. Typical is this comment of Robin Clarke's in the Dec. '75 New Scientist: "It is one thing to talk about Alternative Technology but quite another to get down to brass tacks and produce anything. . . . First and foremost, in the United States the New Alchemy Institute are still going like the clappers. Not only do they produce luscious publications, but they are getting good results, and their plans become ever more ambitious — the latest including a new low technology centre in Canada which looks like becoming the first wonder of the Alternative Technology world."

But everything in the press has been about the New Alchemists rather than by them, and usually, the emphasis has been on their flexible lifestyle rather than their hard science. This article by co-founder John Todd began as a letter to The CQ, became a statement more definitive than anything they've done even in their own publication The Journal of the New Alchemists, and was used as the basis of John's lecture at that Texas Limits to Growth Conference, Fall '75.

At the last minute the Todds added news and diagrams of the then-imminent project at Prince Edward Island, Canada. Both John and Nancy Todd (who edits The Journal) were born Canadian. John was an Olympic skier and small-boat sailer in Canada before he became an agriculture scientist and marine biologist at McGill University, University of Michigan, and Woods Hole Oceanographic Institute.

The New Alchemy work in locally independent systems was begun to make grandiose projects like Space Colonies obsolete. If instead it makes them possible, as some of us are predicting, the Alkies are going to feel strange indeed. A fundamental principle may be at work here, the Hegelian, Marxian, co-evolutionary one:

History proceeds by ironies.

—SB

The New Alchemy Institute was established in 1969 to explore scientifically strategies that might prove adaptive for humanity in the future. This was undoubtedly a large perspective for a tiny organization, but in an age of compounded crises and patch-it-up perspectives, it was clear to us that some fundamental and independent scientific thinking and investigations were going to be required and that the interfaces between science, politics and society were of legitimate concern for scientists.

At the outset we were acutely aware that despite our aggregate training (mine was in such fields as agriculture, parasitology and tropical medicine, ethology and aquatic sciences) we were not able in any concrete sense to design or comprehend the vital systems of society in their interconnectedness and entirety. We reasoned further that without some kind of wholistic comprehension there could be no really significant science for the future. Piecemeal thinking had about run its course, and an appropriate alternative was needed.

For us the key to change was linked to scale. If an adaptive future meant working with tangible wholes rather than abstractions, then the scale of our scientific inquiry should be much reduced, yet involve, at the same time, the vital systems which sustain humanity. We felt it imperative to fuse science with the practical, scholarly and philosophic realms. There were traditions to guide us, including the Taoist (in China) and Hermetic (in Europe), which at one time embraced science. In our own era cybernetics and ecology have helped pave the way for the fusion of which I speak.

GUIDELINES

Over the years we have adopted a number of scientific guidelines which incorporate political, economic and ecological considerations. Since they are relevant in any discussion of the value of our work, I shall list them:



John Todd recording the weight of a tilapia corpse.

1. That N.A.I. begin to design and research on a micro level while maintaining a planetary perspective and a concern for linkages between levels of organization. By micro level, we meant the lowest functional units of society, the individual, or small group, and the elements which sustain them. The assumption was that larger units of organization can be no stronger than the elements of which they are comprised, and that the microcosm can be knowable in concrete terms, often representing a tiny image of the larger world of which it is a part. It can, if broadly conceived, act as a model of organization. This perspective, which is characteristic of alchemical philosophy in many ancient cultures, inspired our name.

2. That N.A.I. emphasize food producing and energy systems that do not require large amounts of capital so that its findings could be widely utilized by those without substantial fiscal resources. This would also make its work useful, although by no means exclusive, to third and fourth world countries.

3. That N.A.I. seek methods by which a gradual shift could be made from a hardware-intensive society to an informationally and biologically extensive one. We suspect that the next major human advance may prove to be the substitution of strategies gleaned from nature deriving their primary support from natural systems, for present day predominantly hardware strategies requiring high levels of energy to operate societies. The integration of these newly designed natural systems may be assisted by microcomputers and monitors which utilize minute amounts of power and, like humans, act as control elements. We believe that in societies organized into micro units, almost all the food, shelter and internal climates, power, and even transport can be transformed to

biologically and informationally derived support elements. Since it is more difficult to make a commodity out of living entities like an ecosystem, it seems possible that a future derived from this basis will be more egalitarian and considerate.

4. That in designing for the future N.A.I. emphasize participatory solutions which would be capable of involving large segments of society. We made the assumption that when the petroleum era wanes that the traditional ratio in which the great majority of humanity was involved in food raising would reassert itself. It has just been with the oil and gas based agriculture in the 20th century that it has been possible for a majority to shift to urban living. Since it seems likely at some future date that much of the population might have to return to culturing most of their own foods, we decided to research methods of food culture on a family level, which would be ecological and relatively inexpensive. The physical components would involve only part-time tending and be suitable for siting in such small spaces as suburban backyards. Further, they would have to be designed so as to be comprehensible and useful to large numbers of people.

5. That N.A.I. explore bioregional approaches to the future that would augment the more "universal" approaches outlined in 1 through 4. Towards this end, it would establish small centers or projects in several countries and climates. In the best of all possible worlds there should be a balance between the regional and the global. Each bioregion should be physically and culturally unique, reflecting a dialogue between society, climate, environment and resources. It seemed to us that self-reliance, price and independence could be restored in many regions if indigenous approaches to food production, energy, shelter and manufacture were given serious intellectual and scientific concern. At its fledgling centers the Institute has begun to identify and study bioregional directions in several areas as diverse as maritime Canada and the lowland tropics of Costa Rica.

6. That N.A.I. seek methods for incorporating in its designs renewable energy sources and durable material in lieu of finite substances and short-lived materials. Conserver societies will be predicated upon such shifts in energy production and use of materials.

In summary what we hoped to do was research methods for the fundamental redesigning of the vital systems which sustain human societies. We wanted to participate in creating a body of knowledge that could lead to the replacement of the fuel consuming engines and the hardware of present societies with equivalent support processes which would be derived from living systems coupled to sensitive technologies powered by the wind and sun. Nature in this context is our primary ally, the future must be nothing less than a transformation away from hardware intensive and exploitive societies to ones that are informationally rich, co-evolving in an intimate partnership with the living world.

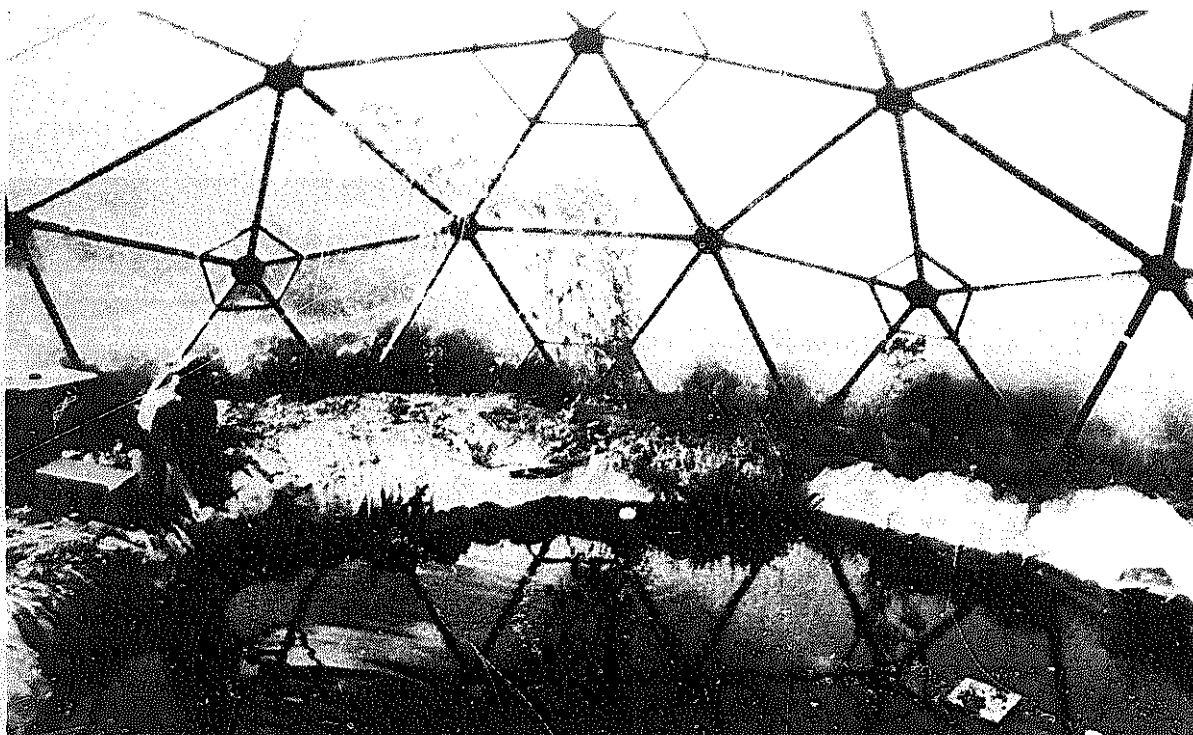

Backyard fish-farm greenhouse. Plastic above (double-walled Kalwall) holds heat in. Plastic below holds water in. The water circulates through a cohog-shell and bacteria natural filter which removes the chemical signals by which the fish population would normally stunt its own growth.

EXPERIMENTS

I should like to outline briefly a number of our key experiments which are at present underway and which reflect the above approaches.

1. BACKYARD FISH FARM-GREENHOUSE

A number of years ago we posed a question — namely, would it be possible utilizing ecological principles, internal food cycles, and renewable energy sources for power, to produce the protein needs of a small group of people on a year-round basis in an approximately 50' x 50' space? Theoretically, at least, such systems might function initially as micro food gardens or survival tools. Ultimately they could point the way to a new approach to agriculture. New Alchemy's Backyard Fish Farm-Greenhouses are an outgrowth of our attempts to answer this question.

Basically the backyard micro-farms are semi-tropical aquatic and terrestrial environments covered by solar trapping structures which maintain and regulate year-round growing conditions for fishes, vegetables and some fruits and grains. The aquaculture component is key to climate control, as the large volume of water provides heat storage for cold and sunless periods. Within the ponds, dense blooms of algae are cultured, providing the feeds for herbivorous fishes within. Tilapia, a herbivore from Africa, has been cultured on internal food chains to an edible size in as short a period as 3 months. The white amur,

another vegetarian fish prized in China, have grown to over a foot in length in less than a year. Overall productivity is dependent upon internal biopurification. This is carried out in two small ecosystems adjacent to the culture ponds. We have not sought record levels of fish production; our emphasis to date has been on the creation of healthy aquatic ecosystems which are almost autonomous, self-regulating and self-purifying, and which have incorporated into them a variety of food cycles, the end points of which are diverse foods suitable for human consumption. These include fishes and edible aquatic plants such as water chestnuts. Rice has been successfully cultured in small batches using pond water. Production in shallow 18' diameter dome-covered ponds has exceeded 50 lbs. per crop of tilapia which are cultured only during the summer months. White amur and mirror carp are raised year-round in the same system.

Adjacent to and dependent upon the aquaculture are experimental terrestrial growing beds. During summer they contain tropical seed grain crops such as amaranth, vine crops such as squash, cucumbers, and tomatoes, and tropical fruits. During the winter, traditional temperate climate foods such as spinach, lettuce, onions, parsley and chard are grown. Their overall value may exceed that of the fish. Pests upon the plants are controlled biologically; *Anolis carolinensis*, a lizard, has been found an effective predator for most insects. Biocides can not be used

within these terrestrial capsules as they disrupt the internal cycles, particularly the aquatic.

Although the original concept has been vindicated, there is yet much to be learned. Our growing structures are now at a stage where they are justified at the family level. Perhaps in some parts of the world, where food and water as well as fuels are scarce, adaptations of these micro-farms could prove extremely valuable.

2. THE MINIATURE ARK

The miniature ark, a solar-heated wind-powered food-growing complex was designed to study biological concepts which we hope will lead to highly productive and economically valuable ecosystems for the raising of aquatic foods. It has in addition a small amount of greenhouse capacity. The design was inspired by productive ecosystems in nature, in particular a river in Java, a Louisiana estuary and a mangrove lagoon in Florida. All three ecosystems were characterized by rapid exchange and flushing rates of water which we felt were key to their ability to sustain large animal populations. The river had high nutrient levels derived from animal and human sewage and was capable of sustaining immense populations of organisms suitable for fish feeds. The Javanese cage-cultured 80-90,000 lbs. per acre of fishes annually in the better sections of the river. Both the Louisiana estuary and the Florida mangrove lagoon were characterized not so much by high internal productivity as by accumulations of decaying detritus derived from surrounding terrestrial and aquatic environments. Because of the influx of oxygenated water from outside, large numbers of fish and crustacea were able to thrive in these zones to feed directly on the abundant detritus and associated organisms. In the absence of flushing, decomposing organic matter lowers oxygen to levels intolerable to desirable fish and crustacea species.

The miniature ark was designed to incorporate the best bioenergetic attributes of the tropical river, estuary and lagoon with respect to overall stability and productivity. Its aquaculture component is a circular "river" or closed loop, with solar heated water, high nutrient levels, a rapid flow with resulting high exchange rates, detritus, organic matter, and supplemental components for culturing additional feeds.

The flow is produced by a windmill which pumps water through the various subcomponents of the loop. Several high capacity sailing windmills have been developed by New Alchemy for water pumping in third world countries and for aquaculture systems. Presently the Institute is attempting to develop pumps equal to the power of the windmills. It is expected that, within a year, flow rates on the miniature ark will increase four fold with a concurrent rise in potential productivity.

Large fish populations are cultured in the largest pond of the loop or cycle. Bio-purification takes place, after the water has passed through the solar heater, in five small ecosystems. These variously

house bacterial filters comprised of shells, earthen filters, open pools and "forests" of aquatic plants arranged to induce alternating carbon dioxide and oxygen dominating pulses. The ability of the system to purify water laden with toxic fish wastes has exceeded our most optimistic estimates. Plants from the bio-purification elements are fed to fishes periodically. In this way the nutrients are continuously recycled within the system.

Although the aquaculture component of the miniature ark is small it has worked well and will be the model for larger systems. The design and early workings of the miniature ark and the backyard fish farm-greenhouses are described in the *Journal of the New Alchemists*, Volume Two.

3. SOLAR PONDS

The recently conceived solar pond concept is an attempt to utilize living systems so that they serve simultaneously a number of critical functions in an integrated way. In their design the emphasis has been to have biological entities, in combination with an appropriate technology, serve roles presently played by machines and fuels. The solar ponds are an attempt to create suitable climates in living and food growing bioshelters while at the same time they perform as aquaculture ecosystems. As such they are an example of guideline 3.

The solar ponds are translucent cylinders of water placed above the ground into which light can enter from the top and all sides. Their walls and tops are built from a Kalwall fiberglass material which permits a high percentage of available light to enter. Solar ponds act as both effective solar collectors and heat storage units. The planktonic algae absorb the sun's energy in much the same way as the black absorber surfaces of the plate collectors which are manufactured for houses and buildings. Within the ponds the energy from the sun is transformed by the plants into heat and plant growth. The water medium within which they exist is an appropriate storage material. A covered solar pond 5' high by 5' in diameter heats rapidly when the sun shines brightly. During the warmer months partial shading and venting is required even when they are outside.

In New Alchemy's "Ark for Prince Edward Island," which is a solar-heated and wind-powered bioshelter encompassing a house, laboratory, greenhouse and aquaculture facility, there will be forty solar ponds. These will contribute considerably to maintaining living and growing climates year round, as well as providing the backbone of the aquaculture systems. The Solsearch architects who are working with us on the structure predict that the ark will be able to function in the Canadian maritimes if the sun does not shine for a month. The complex will be one of Canada's contribution to the U.N. Human Settlements year.

The solar ponds represent a new approach to warm water fish culture. Because of their phenomenal light-receiving ability, algae production on a per unit volume basis is some ten times greater than in

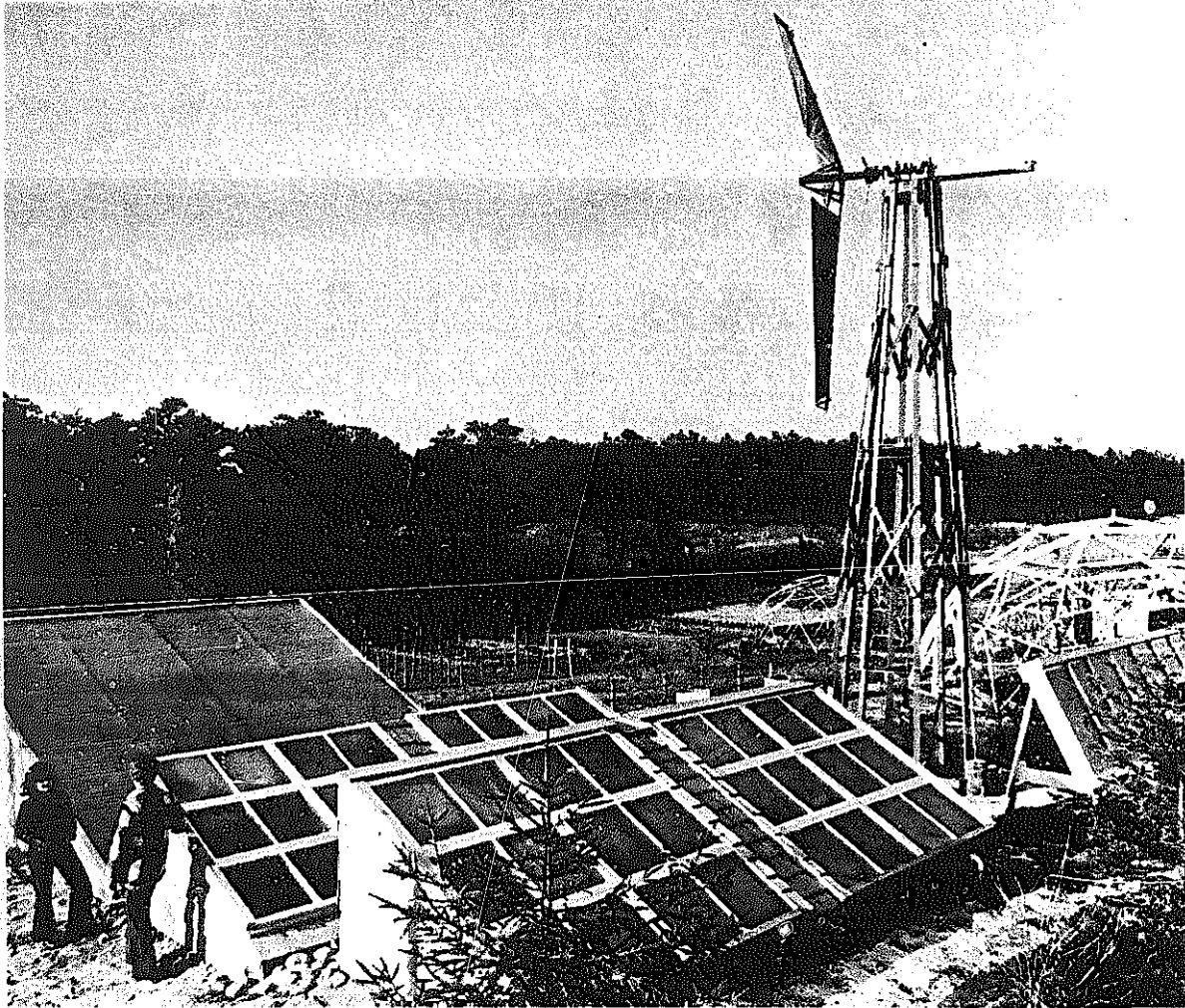

The Mini-Ark, a closed-loop stream. At right, the solar water heater. Foreground, the bio-purification unit and supplemental food sub-ecosystem. To the left, the polyculture fish pond and terrestrial plant greenhouse. The sailing windmill has a reciprocating rod leading downward to a wooden box pump (which outperforms and outlasts commercial plastic pumps). The windmill lifts the water in the "stream" to its highest point.

our other aquaculture systems. Consequently, proportionately larger grazing populations of tilapia are presently being cultured in them. Within the ponds, we are experimenting with passive vs. active bio-purification strategies. The "active" solar pond uses a small 5 watt air pump to turn over water within bacterial filters on the bottom of the pond. This has resulted in extraordinarily dense algae blooms. The "passive" solar pond seems to be able to function effectively as well by relying upon the movements of the fishes to affect bacterial-algae nutrient recycling. Both solar ponds have an exceptional ability to take up and eliminate toxic ammonia.

Since this is our first season working with solar ponds it would be premature to judge their worth as solar heaters and fish culture ecosystems. However this winter we have two solar ponds with double

transparent walls and lids sitting outside in an exposed position. Within these ponds we are culturing Israeli carp and silver and bighead carps from China. Already they have had to face howling winds and temperatures of 2° F. Water temperatures within have not dipped below 40° F., and as soon as the sun began to shine they started to heat up. Quite amazing. Right now we are building a mylar coated windbreak-reflector to optimize their solar trapping ability. With more study and refinement the solar panels may prove to be one of N.A.I.'s most valuable contributions to the vexing problems of heating and food production.

4. THE CAPE COD ARK

We intend to find out whether well-designed bio-shelters can be developed that will produce foods in such abundance to be economically viable, paying for themselves and providing a living income

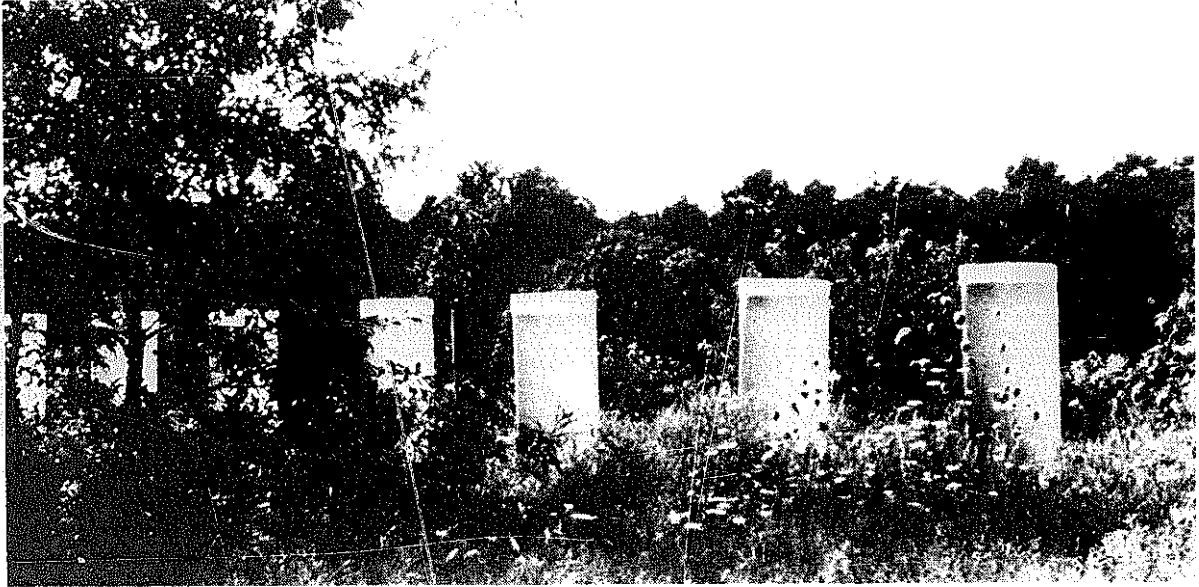

Solar tubes, 18" diameter, 5' high, housing algae and tilapia feeding experiments.

for their owners. An intensive garden/farm agriculture, based on small acreages and bioshelters which contain ecologically derived food networks powered by renewable energy sources, may be a most adaptive strategy for a future when fuels are dear and in short supply.

The Cape Cod ark, a solar-heated, wind-powered greenhouse and aquaculture structure, was designed in collaboration with Solsearch architects to explore the micro-economic basis of the bioshelter concept. It is to be built in 1976 if enough support for the project can be found. A small model, 25' by 15' in size, has already been built to test a number of concepts and materials. These include the insulating and heat-trapping properties of the potentially valuable solar membrane invented by Jean Wellesley-Miller and Day Charoudi of the Solar Lab at M.I.T. The model ark is the first test of the membrane within a growing structure. It is suspended in three layers under the south-facing fiberglass wall. The membrane may be an effective alternative to costly, difficult to manage shutter systems in solar heated growing structures.

It should be emphasized that the Cape Cod ark is a first attempt to design and build a commercial-size growing structure incorporating the principles described earlier in this letter. Much biological and bio-engineering research will be involved, including the evaluation of crops most suitable to conditions within, biological controls for pests and disease, and internal climate regulation. We are optimistic that such arks eventually will prove an important alternative to food scarcities when cheap fuels wane, but we are aware of the amount of work required to realize their potential. We also feel an obligation to design them so that they are not dependent upon experts and can be widely deployed through society.

5. AN ARK FOR PRINCE EDWARD ISLAND

The Canadian ark is a complete system for living, research and food production which is autonomous and self-contained. It uses the sun and the wind to create housing and growing climates under the rigorous climatic conditions of Prince Edward Island in the Gulf of St. Lawrence. Presently under construction, it is New Alchemy's first attempt to test the feasibility for future living structures which are not continuous energy drains on society. They would be long-lived structures that generate their own power, utilize their own wastes and provide food and even commercial crops for their inhabitants. Through the ark we are trying to evolve bioshelters which are, in many respects, miniature worlds and will through the tending of them teach their inhabitants how the larger world works. An earth ethic may well have to begin where we live. If this is so, our houses should emulate the workings of nature.

A brief description of the ark for Prince Edward Island appears in the third **Journal of the New Alchemists**. The artist's illustration shows what it will look like when viewed from the sea to the south. What makes the ark unique, apart from its self-sufficiency, is the careful integration and the linkages between components which have not been connected traditionally. The greenhouse element, the solar ponds and the solar collectors, for example, all trap and store the sun's heat in several subsystems which, in turn, will be used for a diversity of vital functions. The 25kw wind-driven power plant will provide the electricity for control functions and for air and water circulation. During critical periods in winter, its electricity will be degraded to provide heat to subelements that require it. The ark will be very much like an organism, with the structure acting as the exoskeleton. We shall study the various

interrelationships between such external inputs as sun, wind, length of day and temperatures, and internal biochemical, biological, climatic and storage variables. The emphasis will be on discovering the most appropriate ways of regulating the overall system and of optimizing on a sustained basis food production within.

During a period in history when, in temperate countries, fuel for heating and for food growing, transport and storage are rapidly consuming a high percentage of the world's finite energy sources, arks may represent a key step in integrating existing knowledge with indigenous, smaller scale approaches to the future.

6. HYDROWIND* – AN ADVANCED WIND-DRIVEN POWER PLANT

For many organizations a challenge may occasionally arise which seems sufficiently important that a change in course may be advised in order to meet it. On Prince Edward Island we have been confronted with just such a challenge. The Island province was planning to take part in a large nuclear project, but indicated to us that there was still time for other alternatives to be seriously considered. We proposed informally to the Premier and some of his cabinet and staff that a non-nuclear future might prove the wisest course both socially and economically. N.A.I. is opposed universally to nuclear power generation. In the case of Prince Edward Island, we recommended a gradual shift to a coal-wind-solar energy future. The wind is a renewable and plentiful island resource and coal is readily available in Nova Scotia.** With about 2,000 hours of bright sun annually, the Island could well integrate supplemental heating into its buildings and crop driers, thereby reducing its fuel and electricity needs. Unfortunately, our arguments were weakened by the fact that there was no commercially available electricity-producing windmill either large enough or suitable for determining the efficacy of wind as a supplemental power source. In order to keep alive the ideal of a non-nuclear future, the Institute, with promised support from the Canadian Government, brought together a team of engineers (Merrill Hall and Vince Dempsey) to develop a New Alchemy windplant. Several design criteria were drawn up for it:

1. That it be rugged enough to withstand fierce winds and salt spray along the Island's coast;
2. That it have the potential to be scaled upwards in size to 100kw systems and larger;
3. That the first plant produce enough electricity to power readily a sizeable farm or the ark (a 25kw mill size was chosen);
4. That the design permit it to be ultimately manufactured and assembled on the island;
5. That its economic future look promising.

*A trademark of The New Alchemy Institute.

**The Province of Prince Edward Island recently decided against a nuclear future for the Island. This represents the first political decision in North America against nuclear power. Hopefully the decision by Premier Alex Campbell and his cabinet represents the beginning of a new trend. New Alchemy's obligation to the province's energy future was much increased as a result of their decision.

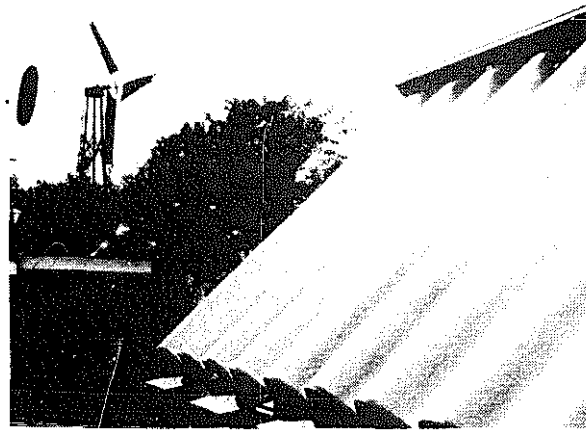

Exterior of Test Model for Cape Cod Ark. Panels of Kalwall are arched for more effective solar trapping. Design by Solsearch Architects.

The resulting design was the HYDROWIND windmill electric power system. It represents a break from orthodox windmill technology. A prototype is now under construction, to be tested on Cape Cod. The HYDROWIND uses hydraulics for power transfer, taking advantage of substantial improvements in hydraulics in recent years, where power transfer efficiencies are now higher than 90%. The New Alchemy system transfers power via hydraulic pumps from the blades to a hydraulic engine on the ground, at which point it is transformed into electricity. There are a number of advantages to be gained, including increased ruggedness, smaller towers and top gear, potentially better air shapes due to having generators on the ground, hydraulic tuning of the blade pitch and opportunities for a scaling of size. Perhaps most important, inherent in the design is the ability to couple a number of windmills into the same power plant and operate a single generator.

The first HYDROWIND power plant on Prince Edward Island will be comprised of four 20' blade diameter windmills linked together. The blade design is new, involving an integral core tension system and a light-weight aluminum skin.

The power plant will be connected to the ark and also to the Island's power network. We feel it will be valuable to test the mill on the grid in order to establish the feasibility of having windplants contribute to existing networks. It is our hope that an active debate will arise, on the Island and elsewhere, as a result of the ark system which will produce more power than it needs and sell the extra power to the utility.

7. RELATED STUDIES

There are a number of other studies and projects within the Institute including the culture of insect larvae as supplemental fish feeds, diet studies on fishes, the evaluation of plants and animals from around the world for use in bioshelter food chains, tree crops and food drying and preserving. Efforts are being made to learn more about biological methods for increasing soil fertility and managing

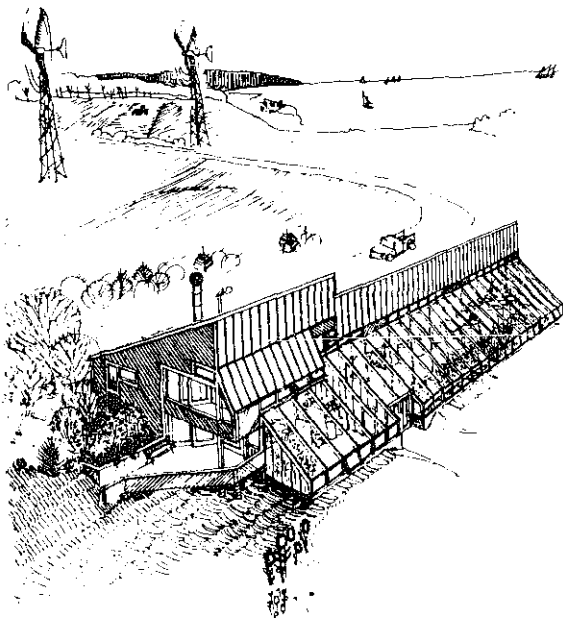

Prince Edward Island Ark. South view of solar and wind-powered bioshelter housing living facility, research laboratory, family garden area, and commercial fish culture and greenhouse facilities. 850 sq. ft. of solar collectors. 2,500 sq. ft. of greenhouse panel.

crops. Most of these studies are related and reflect a desire on the part of the staff to find more apt methods of managing living resources on a small scale. Central to our efforts is the testing of crop varieties for insect resistance and suitability to various climates.

8. DISSEMINATION OF INFORMATION

The Institute is unusual as a scientific and information gathering organization in that it publishes most of its materials in a form directly usable by the public. We have bypassed the usual course of allowing information to circulate through scholarly journals before passing slowly outward through various extension agencies to the public, in the main because of our feeling of the urgency of the work at a time when the future seems almost at hand. We are also interested in direct feedback from those utilizing concepts developed at the Institute. The fact that we communicate purposefully and directly with the public has caused resentment amongst some of our scientific peers, perhaps in part because we are trying to make the search for useful knowledge less sacrosanct, and in part because we are not usually involved in elaborate peer review processes that normally affect publications, invitations to conferences, promotions, grants and tenure. We do not hold, however, that scientific publishing is in any way invalid. On the contrary, without it much of our work would be severely hampered.

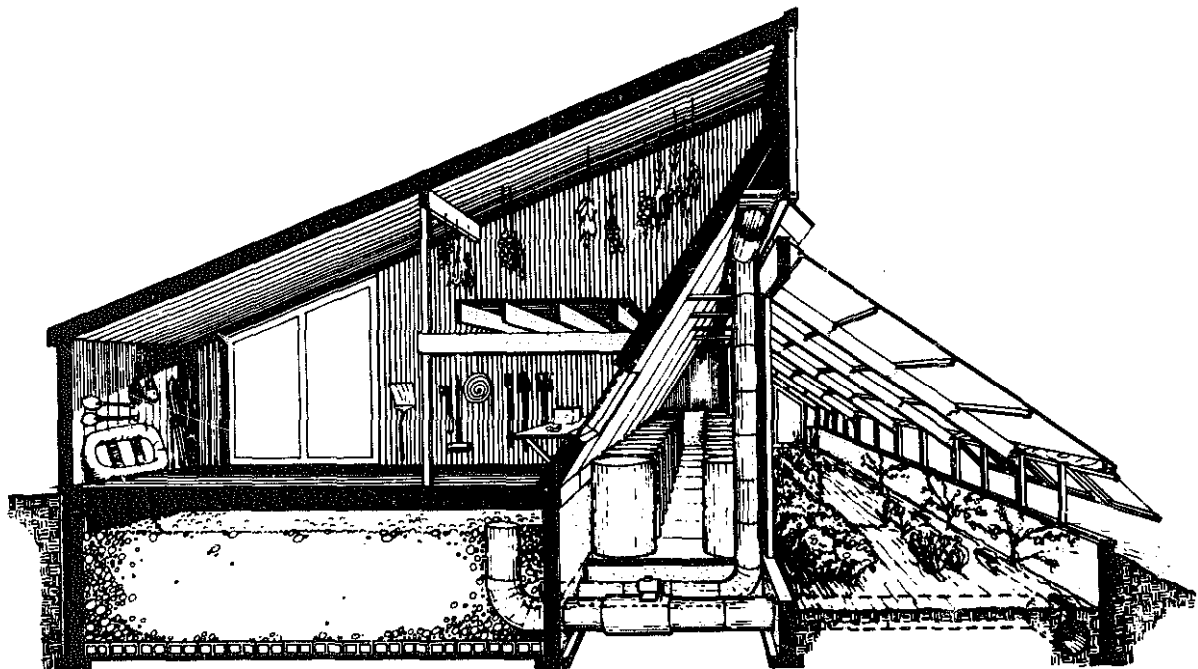

Prince Edward Island Ark, east end. Lower left, greenhouse rock heat storage. Above, barn for vehicles, machinery, and plant drying. Center, connected "river" of solar ponds for fish-raising. Right, greenhouse.

Prince Edward Island Ark, living area. Family garden, water heat storage, clivus multrum composting toilet. In attic, domestic water and solar heat storage system.

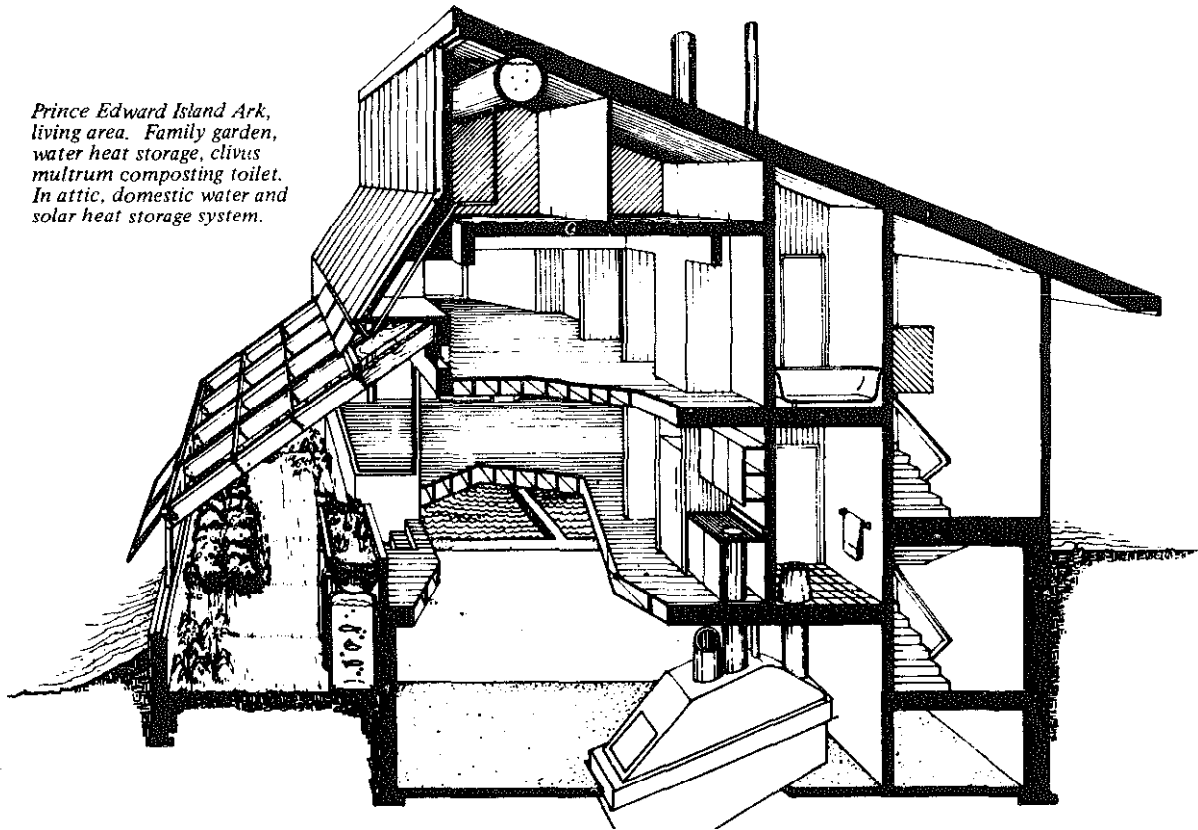

The New Alchemy Institute has become involved in a dialogue with staff members from a variety of field organizations including OXFAM, The Intermediate Technology Group in Britain, Save The Children Fund, V.I.T.A., Church World Service, Rural Development Fund, Brace Research Institute, and a number of less well-known organizations and communities throughout Canada and the U.S. We expect this list will increase as we gather more useful information. At the present, lack of funds and staff have limited our outreach efforts, but N.A.I. Costa Rica, under the small grant, works directly with farms on a study of native crops.

The Institute publishes an annual **Journal** which is a compendium of work that has been tested, along with scientific and social articles. In some of the writings there are attempts to grasp the larger picture and to see ourselves and others within the framework of the times. We plan each issue of the **Journal** to have a long period of usefulness. In the past, five thousand copies of each **Journal** have been printed and all but a few copies have been either sold or sent to Institute members. Requests for them comes from all parts of the world. (See page 167.)

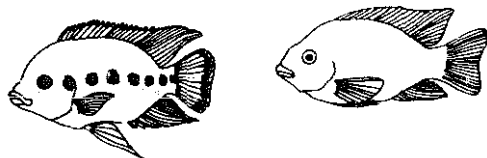

New Alchemy has also cooperated with a number of publications and film makers in explaining the work. The National Film Board of Canada has produced a film entitled "The New Alchemists" and has hired several people to show it to audiences throughout Canada. It is being distributed in many countries, including the U.S.

9. ORGANIZATION

While the Institute has a formal structure and a board of directors, decisions are made by all its staff members at a weekly meeting. It is well organized internally. Each staff member is expected to explain and coordinate his or her activities with others effectively, to optimize use of time, talent and money. Our growth has been purposefully slow mainly because we desire first to know well all new staff members. Several of us began collaboration as friends before the Institute was formed in the mid-sixties.

From the outset we did not wish New Alchemy to be dominated by scientists, though we were primarily a scientific organization. We wanted the Institute to reflect a balance between scientists and technical people, administrators, humanists and generalists. The sexes are balanced, and at the present such essential areas as publications, office management, agricultural research and garden studies are headed by women. About one fourth of the staff have Ph.D.'s and everybody is skilled in one or several aspects of

the organization. Mutual interdependence is stressed not only in decision making but in the salary policy. In 1975, we adopted a single salary policy (\$9,000 per year plus child allowance) for permanent members. Several of the younger and newer people do not receive this pay but are assisted with subsistence incomes, food and lodging until salaries can be found. They have proven themselves genuine assets to the organization.

New Alchemy's main center on Cape Cod has a staff of sixteen and several volunteers. There are also under contract with N.A.I. two full-time architects and one full-time member of the windmill group. The remaining four windmill people and several energy and materials experts assist on a part-time consulting basis. The architects and the windmill people are supported by New Alchemy in Canada. Partial salaries for a number of the full-time staff have come from the Canadian center as well.

10. SOURCES OF SUPPORT AND BUDGETS

In the U.S., N.A.I. is supported by individuals and private foundations. There are presently 2,000 associate members of New Alchemy, each contributing \$25 or more annually to assist us financially. In return they receive the annual *Journal*. Our long-range plan is to seek an increasing amount of help through members, but it is not yet clear whether or not this is a realistic aim.

Over the past few years, a number of private foundations have contributed grants, usually on a one-time basis. Without their support we should not have survived. Included among them are: the Stern Family Fund, the Rodale Soil and Health Foundation, POINT Foundation, LARAS, Septimus II, Haymarket Foundation, Jessie Smith Noyes Foundation, Rockefeller Brothers Fund and the ARCA Foundation. Grants have ranged in size from \$2,000 to \$50,000. As yet we have neither a long-range commitment from any foundation, nor an endowment. Only the Advanced Concepts Center of Environment Canada has discussed with us the possibility of long range support for biological research on the Ark for Prince Edward Island.

WHAT WE WOULD DO WITH MORE SUPPORT

Our continued survival and strength as an organization depends upon all of the staff receiving modest but livable salaries, and our continuing to have enough to rent and maintain the center's Cape Cod lands and facilities. For this reason, general Institute support is integral to our effectiveness and is considered our first priority. Beyond this there are several distinct areas in which we need help.

The Journal of the New Alchemists

The publishing, printing and distribution of the *Journal* costs in the neighbourhood of \$23,000 annually. With grant support it could be distributed more widely and at lower cost. It will remain our major medium of communication.

Library

N.A.I. has a small but useful library. We have permission to use the Marine Biological Laboratory and the Harvard libraries. We require several thousand dollars for inclusion in our library of the best standard references and texts in fields we consider part of our domain.

New Staff

Should our operating expenses be met and our facilities completed over the next few years, we should consider increasing the staff by one or two people. Positions being talked about are: i. a full-time electrical and mechanical person for repairing and upgrading physical components; ii. a competent terrestrial ecologist who might be available on sabbatical; iii. a replacement for one of our people so he or she could take some aspect of our work directly into an existing community. No new staff will be considered until the financial picture of the institute is stabilized and improved.

THE FUTURE

I should like to end by emphasizing that the various systems briefly chronicled here represent concepts in embryo. They are not end points, but new beginnings. They may seem simplistic, even quixotic upon first reading, as in some respects they are, but to see them only in this light might be akin to judging the worth of modern physics from a painting of Newton's laboratory. Within the next few decades many of these ideas will mature, particularly if the impetus can be maintained and others share some of the perspectives presented here. Several years ago I suggested that modern societies by nature would be in opposition to utilizing small scale, wholistically derived biotechnologies in designing communities of the future. At that time it was necessary to justify our research on the grounds that it behooves a mature society to explore diverse strategies for the future simultaneously so that when decisions are in order there are a variety of options to select from. This perspective, while central to our thinking, has been transcended recently by a growing awareness that new strategies for the future are required immediately and urgently. In part this realization is arising out of a waning confidence in the ability of science and technology to salvage an industrialized growth-oriented society in an ultimately finite world. It is becoming apparent that a science of steady states is needed to prepare us for the future. It will be different from the one we now know, having been created within a framework of ethical and moral considerations. There is emerging a widespread interest in building a future in which the majority of people are participants rather than spectators. New Alchemy's long-range survival as a viable and effective organization will depend in a large measure upon many people finding meaning in more tentative, small-scale approaches to the future of humanity. ■



The Prime Minister greets P.E.I. locals, press, and New Alchemy staff and friends, who greet him back. Trudeau-mania lives.

Launching the Ark

The New Alchemists
are neither magicians
nor geniuses.
They are hard workers.

by J. Baldwin

CQ Soft Tech editor J. Baldwin and Kathleen Whitacre were invited by the New Alchemists to come to Prince Edward Island to assist in the finishing of the Ark in time for the visit from the Prime Minister, and also to get acquainted after all the years of mutual hearsay.

-SB

September 11

After 20 hours on various aircraft, we land on Prince Edward Island (P.E.I. as the Canadians call it) and are informed only then that it will be a 2-1/2 hour bus ride to the airport where we were supposed to land. We hope the New Alchemists know that. They don't; when we get to Charlottetown airport there isn't anyone there to meet us and it's getting dark. Blowing up rain too. And we haven't had anything to eat all day because the several airline schedules neatly avoided the necessity of feeding us. We don't have a phone number for the Ark either. We trudge out to the road and commence hitchhiking in what we hope is the proper direction, but nobody is biting at night. We're just about to set up camp in a weedfield at the edge of the runway when a car stops. Old man going home from work. He hasn't heard of the Ark, but he says he'll take us to it, about 60 miles, for \$15.00. "Sold," we say, and we're off after picking up his wife for the ride.

At Souris, the Ark's mailing address, we ask some teenage boys where it is. They've heard of it, but suppose the police would have exact directions. Kathl tries the Mountie barracks and gets directions from a Mountie who has been there and who is very impressed by the place. We enter a 15-mile maze of back country roads at midnight. Our driver is disgruntled by the complications. We have to ask directions again but finally spot lights that just have to be the Ark, and we're there at last. But the place is locked up. Nobody answers our beating on the door. We pay our driver and he takes off leaving us standing there disconsolately in the rain. We jimmy a window and throw our stuff in along with ourselves and creep upstairs amidst an astounding array of pipes, tanks, ladders, scaffolds, plastic panels, wiring, wet

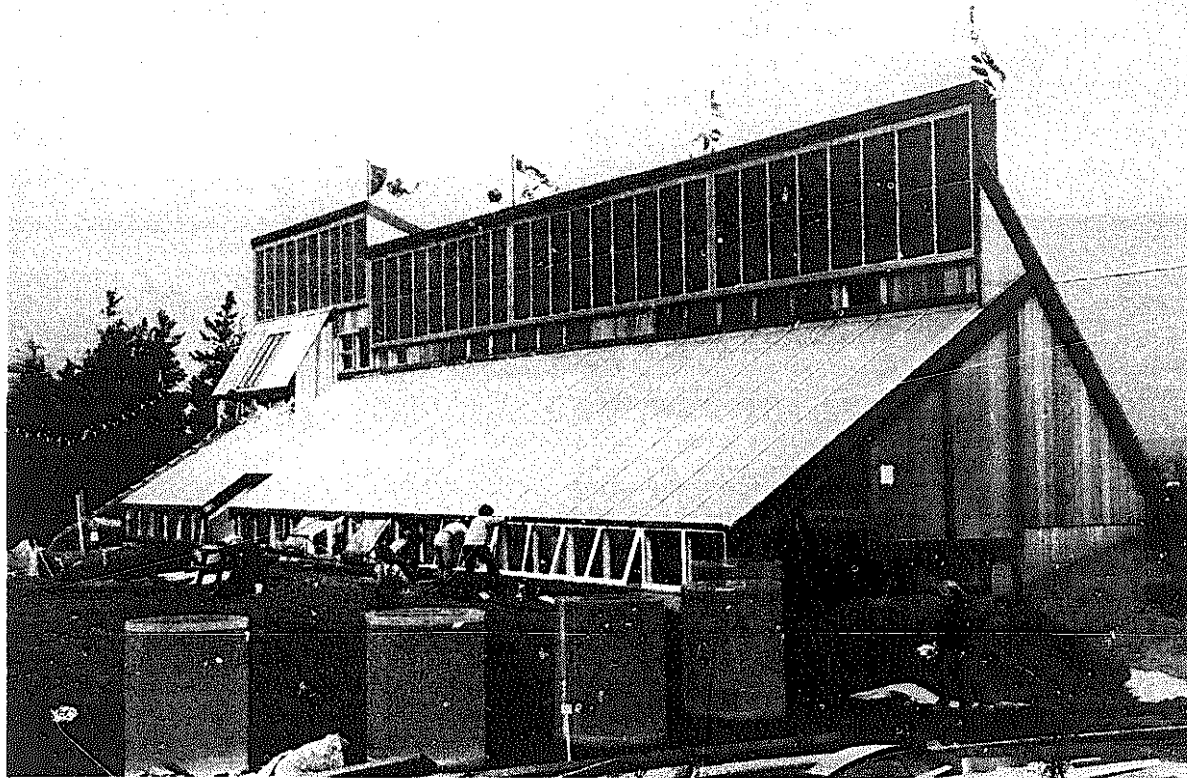

The Ark one day before opening — frantic painting, cleaning, finishing.

SOLAR COLLECTION — Three different kinds of solar collectors are being monitored, tested, and evaluated under rugged Prince Edward Island coastal conditions. The vertical panels are flat plate drain-down type, selective black absorber, solar heat collectors. Vertical position takes advantage of winter sun reflected off snow. The sun-warmed water is stored in chambers totalling 21,000 gallons under the living room for later use in a fan coil heating system. The angled solar panels at the far end are for domestic hot water heating. The wide slanting roof over the greenhouse is made of long-lived twin skin acrylic material which acts as transparent insulation — letting in light while retarding heat loss from the structure to the atmosphere.

paint, blowers, lumber and glass. It looks like a plane crash. As we climb an unfinished staircase, we see feet coming down the stairs above us. "Who's there?" "Jay and Kathleen." "We didn't expect you until tomorrow."

In minutes we're over at a neighboring house where everyone else is eating like hogs and washing it down with a variety of liquids including something called "Lambs" which turns out to be 151 proof rum. (Egad!) The room is packed with tired but happy people happily roaring at each other about what they've been doing that day and hope to do tomorrow. Names are exchanged, but it's hopeless. We eat two loaves of bread, a pound of cheese, some borscht, and join the exodus to "upstairs" where we all sleeping bag it up. 3:30 a.m.

September 12

We wake to find everyone gone to work. They've let us sleep in. We stuff in some breakfast and take John Todd's truck over to the Ark and are greeted by a swirling uproar of people all working like mad. In addition to the New Alchemists we'd met the night before, there are a number of local craftsmen, farmers, and passersby carrying things back and forth. I am a bit worried about fitting in, but John Todd soon settles the problem. I am put to work fitting lids onto fish tanks and Kathleen commences fitting shelving into closets —

much to the amazement of the local carpenters. We begin to see the picture: people are doing what has to be done. The organization is lateral. John is not in charge, despite the fact that he is most often the spokesman for the Alchemists. Ole Hammarlund and David Bergmark are in charge if anyone is. It turns out that they are the Ark's architects turned contractors — and carpenters when they feared (probably rightly) that the Ark might not get done right if contracted out to strangers. Their care shows in the detailing, and they know what has to be done.

I am frankly appalled at the amount of work that must be accomplished to meet the deadline of the Prime Minister's visit, which is a Big Deal. John is serving as a lubricator, whizzing around ordering materials and seeing to it that trips to town are arranged efficiently. He is also arranging for the P.M.'s visit. Lots of politics. It's a good thing John is Canadian. The P.E.I. people are an independent lot, and don't seem especially fond of Americans, though they are cordial enough. The local tradesmen work more deliberately than the Americans, but the total effect is still pandemonium because there are so many working. Few orders are passed. It's pretty obvious what isn't finished.

The ladies are mostly involved preparing the garden and painting things. There are overtones of male chauvinist job allotment, but generally things seem pretty good. There are



in the living area of the Ark, the kitchen has an herb garden and a family food garden where vegetables can be grown year-round for the residents. Its climate can be regulated independently from the commercial greenhouse component visible behind Michaela Walsh, who was on hand from the Rockefeller Brothers Foundation.

a lot of kids around, and you can tell a lot about people from the kids. These are all exceptionally beautiful. Five-year-old Eric can read with adult skill and is holding forth from *Lord of The Rings* in a loud voice. He also has a thing about water faucets and causes a 300 gallon flood by twiddling the wrong knob. Oh well. . .

September 13

Excitement. The hydrowind generator is going up today. Vince is beside himself with anxiety. It's his day. He quit a good job at Piper Aircraft to do this. A crane comes from a nearby church steeple job and preparations are made all day for the lift. At sundown it goes up easily though with a heart-stopping scare when the huge counterweight comes off the crane. Beautiful. These people work well together. It all has gone smoothly.

September 15

Things are now as routine 3s they are likely to be. Everyone is doing their specialty. I'm not making fish tank covers anymore. They didn't fit, embarrassingly enough for me, because the unevenness of the floor made the tanks sit oval instead of round. Higher priority is to get a., the tanks installed and tilled, a., 32 of them. I commence working on that and start a sideline "f untangling the undisciplined 450 lb. crate of greenhouse vent window opening devices that arrived without instructions for installation. Installing the mechanisms requires me t" work with some of the local pipefitters and electricians, which I have been looking forward to. They've been watching us to see if we work. When we do, they are more familiar. I kneel to suck on a hose to start a siphon into a fish tank. "Hey there, when you've done with that one, I have another up here for you," calls a local master carpenter. On-the-job humor is the same everywhere I think.

The Hydrowind won't start in considerable breezes and there is a lot of discussion as to why. The consensus is that Vince didn't want any disasters and so set the blade angle of attack too conservatively. He is preparing to make some adjustments. John says, "I want that thing roaring

for Trudeau." The machine looks good though. Kathleen has been making little housings for the controls and getting to know the wind machine crew a bit. The machine is several hundred yards from the house so we don't get to talk with them much. John Todd is making signs explaining everything about the Ark so visitors won't ask so many questions. There is a lot of local curiosity, and consequently a steady stream of visitors, all of whom must be treated politely. I am amazed at the high level of questions asked, and also by the hope and excitement showing in the eyes of many visitors. Many offer to help, and if they have something we can use, they are put to work. Tractors arrive to finish the landscaping. A hump rather like a wave is formed on the north side of the Ark both to hide the stark hugeness of the Ark and to deflect wind over it. The tractor operators confide that the pond formed by borrowing dirt to make the deflector hump "just happened to be official hockey rink size. . . ." The Canadian national pastime.

September 17

The days and nights have melted together. Many more Alchemists and friends have appeared and are put to work. After dark on the 19th shouts from the sea indicate that Stewart has arrived by tiny sailboat from Cape Breton, a feat of considerable seamanship. A tent colony is organized out near the Hydrowind which is now turning slowly in the endless breeze. The place is like a kicked-over anthill. P.E.I.'s Premier Alex Campbell (rather like a governor in the U.S.) comes by to make sure that all will be in readiness and not be an embarrassment. He accepts John's assurances, but you can tell that he isn't convinced. The entire Ark and surrounding area is getting worse-looking by the hour. Huge piles of junk appear as the interior is being finished up. Wet paint is everywhere. I see a woman with fresh paint yellow blotches on her bottom, and I know that somewhere there is a closet door that will have to be retouched. The entire plumbing crew packs up and leaves without a word and with much critical plumbing undone. Nobody knows if they're coming back or when. Cleanup crews are throwing out uninstalled (and irreplaceable) parts of things by mistake and I lose 35 brackets that hold windows open and shut. (Never found them either.) Temper: are frayed as there are more workers than there are tools to work with and everyone has a sense of responsibility to get their little part finished on time. "Where's that fucking hammer?" The local people seem unperturbed, but agree to work at night too. Their families show up to see what's keeping Daddy, adding to the mob scene.

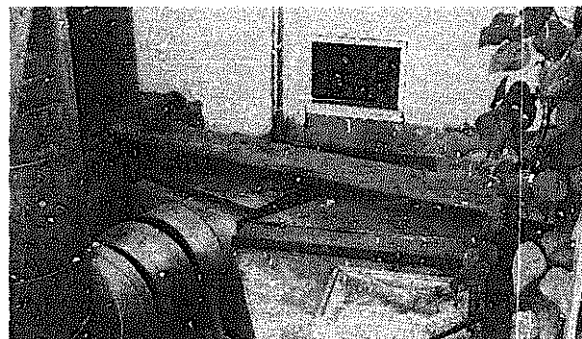

Photographs by Stewart Brand

HOT AIR ROCK STORAGE – Hot air is blown from the top of the greenhouse into a 118-cubic yard rock storage chamber. The rocks pick up heat and cooled air is exhausted. At night or during cloudy periods the rocks give up their heat and warm the greenhouse. Glassed opening in rockbin makes it easier to explain to visitors.

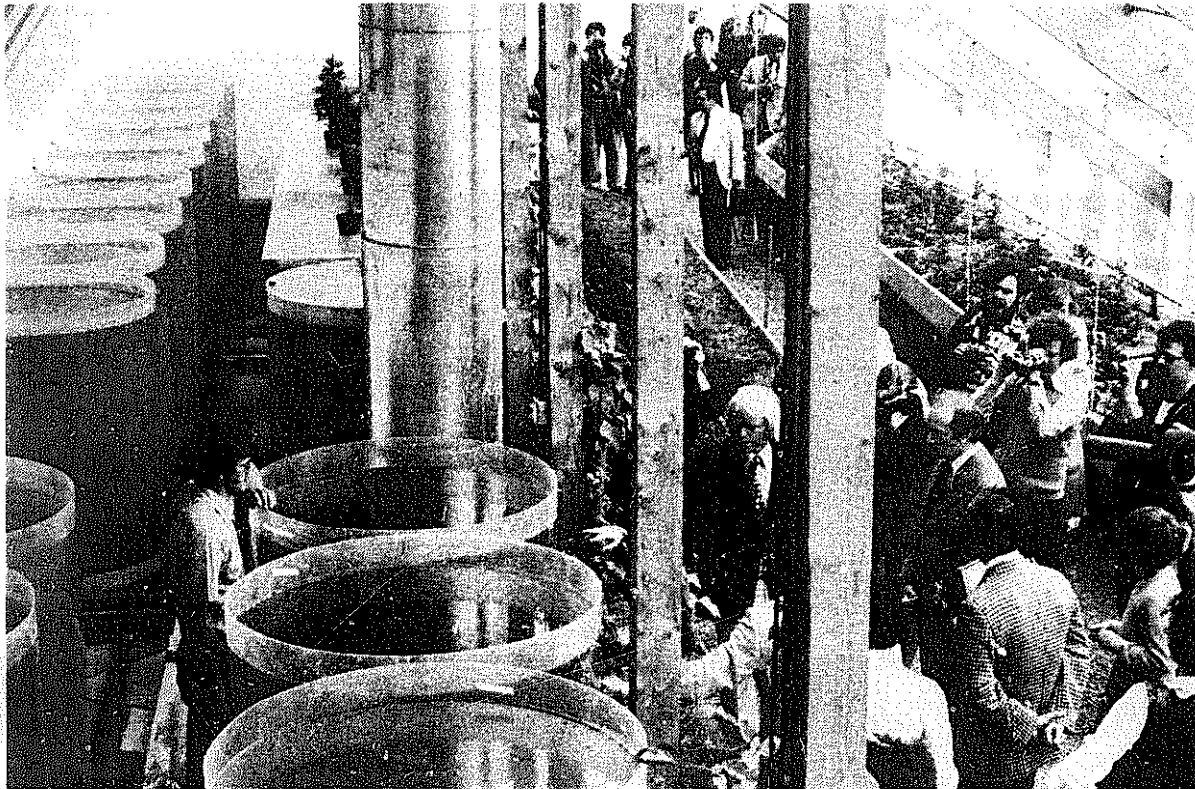

John Todd explaining the aquaculture ponds to Trudeau and press. This commercial greenhouse and aquaculture area is the heart of the Ark.

SOLAR-ALGAE PONDS – Made of thin fiberglass which allows more than 90% of the light to enter, they are ideal for growing algae and fish. Further, the algae act as absorbers of solar energy causing the tanks to warm and act as low temperature "furnaces" warming the greenhouse. They are an example of the value of integrating biotic and structural elements. Unlike most fish culture, the Ark's closed systems use light as their primary energy source providing both heat and oxygen. At night when oxygen sensors detect low oxygen levels in the water, additional oxygen will be added from an air compressor which also circulates water between tanks. Up to 20,000 fish – tilapia – can be raised within the Ark at a time. In the future fresh water fishes and crustaceans native to eastern North America and tolerant of sun-warmed water will be cultured along with the tilapia.

Kathi and I are working together now for a change and are really cracking along like old times. We're putting in the hot air vents at the top of the greenhouse, working balanced on a very sleazy scaffold, as are the electricians and carpenters. There are close calls. Those fish tanks are 20 feet below us and their rims are only 1/16 inch thick. We are careful but we are also tired. The food situation has deteriorated and nobody is eating well. The vents are sticking in their openings. We foresee that there will be trouble from that source as the Ark ages. Sealing all the windows and vents will be a major problem. We are installing vents with wet paint on them. No time to do otherwise. We haven't washed up in more than a week as the plumbing isn't in operation yet. At 10 p.m. we go off with a couple of other American volunteer workers to get a shower at a nearby campground. When the ranger finds out we're from the Ark he won't take our money.

September 20

One day to go, and the place looks worse than it has so far! John, Nancy Willits, Ole and David have been doing the

24-hour bit and look it. Wet paint everywhere. Nancy Jack Todd wants everyone out so she can decorate the place with her crew, but the rug men are in the way and the wiring isn't in yet. The place is absolute mayhem. Everyone is in a hurry. There are actual collisions. The kids are ordered from the building. I invade the shop with the final fish tanks and squeeze it down to a 15 foot square. One bursts. 500 gallons on the floor! Pumps are hurried to the scene. Visitors won't even come in the doorway because of the confusion and the very high energy vibe. We knock off for a few hours, but can't sleep and are soon back on the job. A helicopter fraps by to check the landing site. Locals appear with a huge tent and literally thousands of sandwiches made by neighbors so the reception will "speak well of the people from Little Pond." Frantic scrubbing and touchup going on inside the Ark. A farmer arrives with a tractor and proceeds to bury the huge pile of construction junk. One hour to go and we split to our tent to clean up a little.

When we return, the Ark looks like something from another planet. Spotless! Flowers everywhere inside. Fresh fruit. John and his crew have planted trees all over the place! Some crew has laid out hundreds of feet of neat gravel paths



J. Baldwin — the Kilroy of soft tech, who has been nearly everywhere — filling solar ponds.

in the mud. The Clivus Multrum toilets smell sweet as clover. The indoor farm-gardens are alive with little sprouts. There are Talapia swimming around in one of the tanks. The whole place glitters in the morning sun. A beautiful day in the midst of a rainy season. A fresh wind comes up and the Hydrowind whizzes, actually making power for the first time. The Prime Minister alights from his Huey. He has with him the Premier (whose cooperation made the Ark happen) and an aide, and the chopper pilot. No cops or secret service at all! Not a gun in sight. (There is a cop in the parking area to direct visitors away from the mud pits and keep all cars a quarter mile from the Ark.) Hundreds of P.E.I. people swarm across the field and gather to hear the speeches. The speeches actually have content! People nod. There's hope in all this crazy stuff. If it works, it'll be good for all of P.E.I., and that's not all of it either. . . .

Mr. Trudeau is shown around, and it is clear that he is impressed. He says that there is lots of money for such projects, but a great shortage of worthy projects and people able to run them to completion. He remarks casually if it is possible that the universities are not doing all they might?

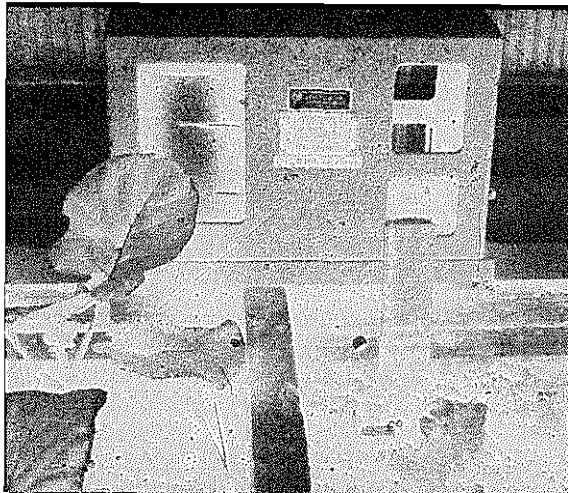

VEGETABLE CULTURE — Leaf crops, tomatoes, and cucumbers will be evaluated as commercial crops in the Ark. Straw bale, deep earth bed, and hydroponic techniques of raising foods will be researched and compared.

While he is getting the tour, an old man climbs up to the microphone and begins to sing a sea chanty in a thin quavering voice. He's good too. He's followed by a fiddler or two and a lady who sings of sailors lost at sea and terrible storms. "You gonna sing your song for us Ed?" "Why, I might at that," and he does. We've never seen anything like this. Anyone who wants to perform does. The sandwiches are devoured by one and all. The Prime Minister leaves and his Huey knocks the kids down with the wind blast. (They love it.) Everyone is exhausted, proud and happy and there is a very good feeling in the air. The local people refer to the project as "our Ark."

So the Ark is buttoned up for winter. The official opening was just an excuse to get it on line before the snows. The local people stay into the wee hours of the morning drinking and making music. The Premier returns and whoops it up too. Kathi and I just make it to the plane with an Alfa Romeo 90 mph in the rain with one minute to spare.

We didn't talk much on the way home. We were pretty tired and I had a tooth abscess acting up. But after things calmed down a bit we found that we'd noticed similar things. One is the remarkable harmony that people manage to achieve when they all want to see something happen. The New Alchemists also are probably wise in not living together. When there is high work pressure, people need to be by themselves to cool down. People also need to be able to take time for their own projects without feeling guilty.

We were very pleased to see the Canadian attitude towards the Ark. It was by no means unanimous (one newspaper reporter referred to the Ark as *American millionaires* spending a million dollars of Canadian money) but generally people saw it as a needed experiment and not as a political payoff scheme. Obviously, the Canadians responsible for getting the New Alchemists the money have good vision. No USA grants were forthcoming, though perhaps now there may be some. I was impressed that the Canadian officials could see that the Ark was not merely a building but rather was a way of raising food and trees. It's more of an attitude than an object. That attitude also shows that John Todd and the other front people for the New Alchemists have been doing a fine job of communication.

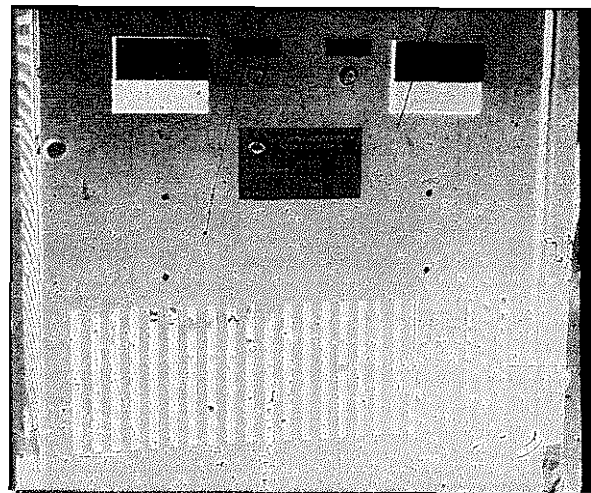

The Gemini inverter which took electricity from the Hydro-wind and fed it into the P.E.I. power net on opening day — "running the meter backwards." The man from the power company advised, "Let me know before you do that again. Your electricity has too much noise in it still."



Nancy Jack Todd in the living area, which has three bedrooms, kitchen, dining and living room, and a research laboratory office.

But the main thing we felt working with all those people was a feeling of potency. The Alchemists don't subscribe to being helpless and dependent. One way or another, the work they feel to be important gets done. In these days of doom and despair it's a real pleasure to see people putting everything they have into such projects. You're not going to see corporations or governments attempting Arks. Studies maybe, and possibly show-off hardware now and then. But not entire

integral schemes like the Ark. I guess we're writing this diary to try and explain that when you see photographs of the Ark all finished and shining, it was built by just plain folks who did their homework and then executed what they found was worth a try. No mystery, just a lot of hard work by people who are willing to take chances and set aside their personal concerns long enough to make something really good happen. We're glad we went. ■

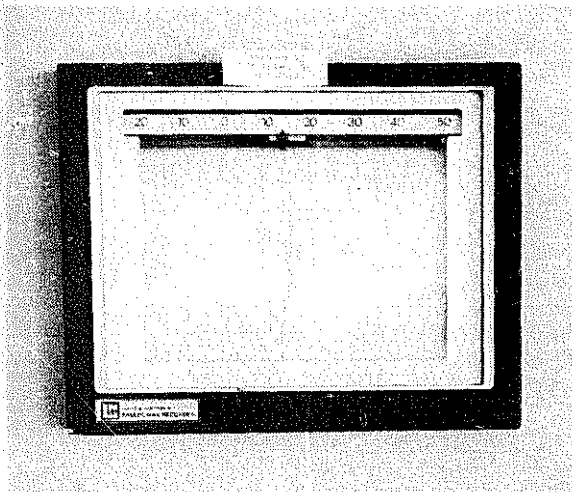

MONITORING – The metabolism and productivity of the solar algae ponds are continuously monitored and the data transmitted to the laboratory – oxygen, pH, ammonia, light, and temperature.



MIST PROPAGATION – The bench mist propagation system, which prevents cuttings from drying out and dying, will be used to root thousands of fruit and nut tree cuttings. The trees will be planted in New Alchemy's experimental food forests and made available to local farms for testing.



New Alchemy kids revelling in the take-off blast of a helicopter checking the landing site for the Prime Minister.



It seemed appropriate (that word!) to arrive at Spry Point by non-fossil-fuel means, so I sailed The Evening Star from Nova Scotia. She's an 18-foot gaff-rigged sloop with tarred canvas sails, manila lines, and sufficient seaworthiness to handle the 50-mile open ocean passage without trouble. She used to belong to John Todd.

--SB

PRINCE EDWARD ISLAND ARK

Overall Budget: \$354,000

Unofficial Estimated Expenses
1 December 1974 - 1 October 1976

Staff (5)	\$ 38,000
Preliminary design	1,500
Architects, engineers, consultants, and support science staff	57,000
Plant - all systems and labor	105,500
Hydrowind development and construction	64,000
Biological and climatological equipment (Province provided weather station)	3,400
Administration, phone, services	8,200
Travel	15,800
Total	\$293,400



FROM URGENCIES TO ESSENTIALS

CANADIAN PRIME MINISTER
PIERRE ELLIOT TRUDEAU

AT THE OPENING OF
THE NEW ALCHEMIST ARK
AT SPRY POINT, PRINCE EDWARD ISLAND



Prime Minister Trudeau

Photographs by Stewart Brand

"Distinguished guests, ladies and gentlemen. Those who are concerned about the future of mankind are haunted by three questions: will there be enough food, will we have enough energy, and can we produce both without destroying the environment; without making the earth a place which is not good to live upon? The Ark -- which I have the pleasure of declaring officially open this morning the Ark is answering "Yes!" to those three questions. And that is why I consider it a very exciting moment.

"Some of us in our jobs are trying to answer the questions of today and tomorrow, and very often, we find that the urgent is replacing the essential. Well, the essential is being talked about here, worked on here, and that is why I believe there is a sense of excitement that is shared by all those who are here today, all those who know about this work. The Indian Chief Seattle used to say that "whatever befalls the earth will befall the sons of the earth." And what is befalling the earth is known to all of us -- the high techniques, the high mechanistic civilization which we have developed has produced great abundance, great affluence, but it is also destroying the earth destroying the rivers and the streams, fouling the air and the land, destroying the landscape, and even the mighty oceans are endangered. And as we know, when the oceans are dead, the planet will be dead.

"On those questions -- the questions of how to build our techniques into a technology; how to insure that the machines we have created -- those wonderful machines; each one in itself, whether it be an automobile, helicopter, a modern house or a ship, or a

petroleum-burning machine all these things are great creations of the human brain. But we have not yet, as mankind, built a philosophy of those machines. And this is what is being done here in a practical way. As Dr. Todd reminded us, there is perhaps no more natural place to be doing that than Prince Edward Island -- where agriculture, where fisheries are so important to the livelihood of the people; where a sense of community prevails, and particularly, an island which has proven receptive to new ideas.

"More than one hundred years ago, the idea of confederation was developed here, and now I like to think that this island, which has shown hospitality to this political idea which created Canada, is now providing hospitality to a new commitment: a commitment that environmentalists refer to -- and I think it's a beautiful phrase -- as "living lightly on the earth." I like to think that Prince Edward Island, the experience of the Ark, and all those connected with it, will be at the birth of this new commitment, of the new philosophy which we will be able then to call a technology.

"I want to express my appreciation for having been invited here. I want to thank all those who are associated with the project: the Federal Department of the Environment, the Federal Department of Urban Affairs, the government of Prince Edward Island which has cooperated in so many ways, but especially Dr. Todd and all those who are working with him here. I think this is a very important moment in the history of our country, and I am very happy to be associated with it." □



Premier Alex Campbell



John Todd, New Alchemists' spokesman

Canada now leads the world in the encouragement of soft technology research. And Canada's smallest province, Prince Edward Island, leads the world in discouragement of nuclear energy. In 1976 P.E.I.'s young (40) premier Alex Campbell, with the citizenry concurring, simultaneously banned the development of nuclear energy in the province and gave to the New Alchemists 137 acres of prime coastal land — Spry Point — for research in energy and food-producing alternatives.

The participation by Trudeau in the opening of the Ark on September 21, 1976, was the climax of a year of building and weeks of frantic finishing (joined by CQ Soft Tech editor J. Baldwin). The Ark was completed on schedule. The Prime Minister spoke with far more than ceremonial perception.

After his talk I asked the PM if he had any measure of the governmental popularity of this sort of activity. Said

Trudeau, "I have no problem finding money for this sort of project. The problem is finding the people to use it well." He nodded at the Ark. "How many groups do you know who could do that?" I was shocked at the question and my answer — "Uh. Maybe four, maybe five groups." He went on, "I should ask you, where are people with the skills going to come from?"

Ever a sucker for politicians with questions, I shortly found myself urging The New Alchemists that they start a training program.

I'm not sure it needs to be said, but the opening of the Ark was in fact a moving — even triumphant — occasion. Such events usually aren't. This was. Like fiddle music for dancing.

— SB

About New Alchemy

Each year the New Alchemists publish a journal of their most recent work and thoughts. The latest one, No. 4, has details of the Cape Cod ARK. This ARK is a true jewel. Its scale feels more modest and human than the huge P.E.I. structure, and the whole thing has a remarkable feeling of "rightness" about it. As with previous journals (now out of print, alas), No. 4 is a happy blend of scientific data, humor, exciting probes, nice people and good photographs. — JB

The Journal of The New Alchemists No. 4

Nancy Jack Todd, Ed.
1977; 149 pp.

\$7.00 postpaid

from:
The New Alchemy Institute
P.O. Box 432
Woods Hole, MA 02543

If you'd like a stunning color photo of the Cape Cod ARK, with an explanation of its systems on the other side, there is one available.

ARK Poster **\$3.00** postpaid

You are also invited and encouraged to financially support the New Alchemists by joining as a member. Memberships include newsletters and a copy of the Journal in preparation. Associate members also receive the most recent Journal. If

you're looking for a cause to support that yields results you can see, here it is. Tax deductible, too.

Subscription membership

\$10.00/yr.

Associate member

\$25.00/yr.

Sustaining member

\$100.00/yr.

Patrons of the Institute

\$1000 or more

There is also a book about the New Alchemists. It has articles from all the Journals, and is printed in the same format, though by a commercial publisher. If you missed the past Journals, this is a good way to catch up.

The Book of The New Alchemists

Nancy Jack Todd, Ed.
1977; 174 pp.

\$6.95 postpaid
(\$8.50 in Canada)

from:
E.P. Dutton
2 Park Ave. South
New York, NY 10016
or Whole Earth

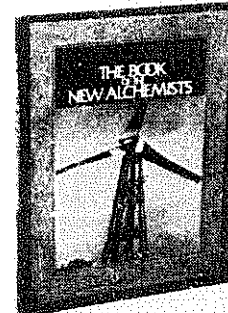

Ecotopia

This enjoyable work of fiction is listed here at the end of Soft Tech because it is the best integrated positive vision in print of how our civilization might fall into balance. It makes people mad enough to change their behavior. They see no reason why we can't live like Ecotopians NOW.

—SB

It doesn't really matter when things don't happen on time in Ecotopia. People grease and paint their bodies and cheer over spilled blood in the ritual war games. "The family" means some dozen or twenty folks coming and going and sharing the chores but no woman has a child unless she chooses the man. And it's not that things are sexually promiscuous at all... they're easy. (Organized promiscuity is limited to a few days on either side of the solstices and equinoxes, meaningful times of the year.) William Weston doesn't think of himself as the square reporter from New York, United States, the first foreigner to enter Ecotopia since the great war of succession in 1980, but as we develop a feel for Ecotopia, we the readers and Weston our narrator all begin to pick up vibes of our own squareness. What was once northern California, Oregon and Washington has become (by the year 2000) bucolic, calming, rhythmical and sensible. Climaxes (both sexual and violent) are there but they occur at reasonable, natural intervals. It is a question of values.

Ecotopia is an extrapolation. In retrospect the tendency towards its formation could be detected as early as the mid 1970's. The first step was rather inconspicuous: the publication of a small scientific journal, accessible and with style, called the CoEvolutionary Quarterly. [Reviewer's imagination taking over here. —SB] No one thought the banning of The CQ by the National Academy of Sciences, The National Science Foundation and the American Association for the Advancement of Science would ultimately lead to civil war and the successful secession of Ecotopia.

—Lynn Margulis



Ecotopia: The Notebooks and Reports of William Weston

Ernest Callenbach
1975, 1977; 167 pp.

\$2.50 postpaid

from:
Bantam Books, Inc.
414 E. Golf Rd.
Des Plaines, IL 60016
or Whole Earth

San Francisco, May 12. It is widely believed among Americans that the Ecotopians have become a shiftless and lazy people. This was the natural conclusion drawn after Independence, when the Ecotopians adopted a 20-hour work week.

Healdsburg, May 17. Wood is a major factor in the topsyturvy Ecotopian economy, as the source not only of lumber and paper but also of some of the remarkable plastics that Ecotopian scientists have developed. Ecotopians in the city and country alike take a deep and lasting interest in wood. They love to smell it, feel it, carve it, polish it. Inquiries about why they persist in using such an outdated material (which of course has been entirely obsolete by aluminum and plastics in the United States) receive heated replies. To ensure a stable long-term supply of wood, the Ecotopians early reforested enormous areas that had been cut over by logging companies before Independence. They also planted trees on many hundreds of thousands of acres that had once been cleared for orchards or fields, but had gone wild or lay unused because of the exodus of people from the country into the cities.

(May 18) *Marissa says I am squeamish about violence. Makes fun of American war technology, claims we had to develop it because we can no longer bear just to bayonet a man — have to spend \$50,000 to avoid guilt, by zapping him from the stratosphere. This because last night I expressed dismay at the ritual war games. "Listen, you'll love it," she said gaily, "you're just ripe for it!"*

Seriatim

A promising-looking quarterly of Ecotopian journalism (inspired by the novel Ecotopia, by Ernest Callenbach, who also is involved in Seriatim). The first issue has Frank Herbert (of Dune), Joel Schatz, reports on ecotopian logging, recycling, recent environmental conferences, and so forth. I hope this fledgling lives. Feeding it will help.

—SB

Seriatim
(Journal of Ecotopia)
\$9 /year (quarterly)
\$2.50 single issue
from:
Seriatim
Box 117
McMinnville, OR 97128



AGRITECTURE/ BIOSTRUCTURES

Agriticultural structures might be created out of green plants. Living enclosures could be shaped by nets, careful pruning, judicious use of nutrients, etc. With greater understanding of plant growth processes it may be possible to develop varieties of plants that will develop naturally into functional enclosures.

Biostructural designs may emerge in the next 20 years as the strongest single force in the architect's repertory. Inspired by the biological processes of growth, reproduction and cyclical change, builders and designers may emulate natural life forms in construction of buildings and villages.

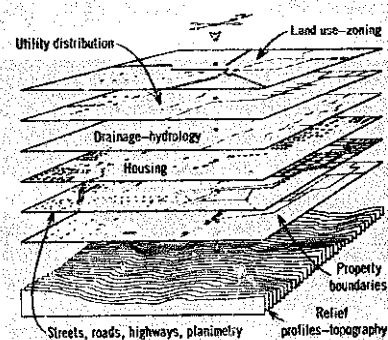

Graphic representation of a Digital Data Bank. Data banks are homogeneous sets of data which have been compiled and stored for later recall to produce maps for specific purposes. They are the building blocks of modern state-of-the-art mapping. They may be recalled randomly for CRT (cathode ray tube) viewing, singly or in combination, edited, changed and re-stored without physically drawing a map. Data bank versatility is unlimited. Any number can be selected to satisfy specific map requirements. The combinations which can be used are near infinity. Maps tailored to planimetric detail, topography, land use data, water resources, parcel boundaries, and forestry, just to name a few, may be produced from one aerial survey.

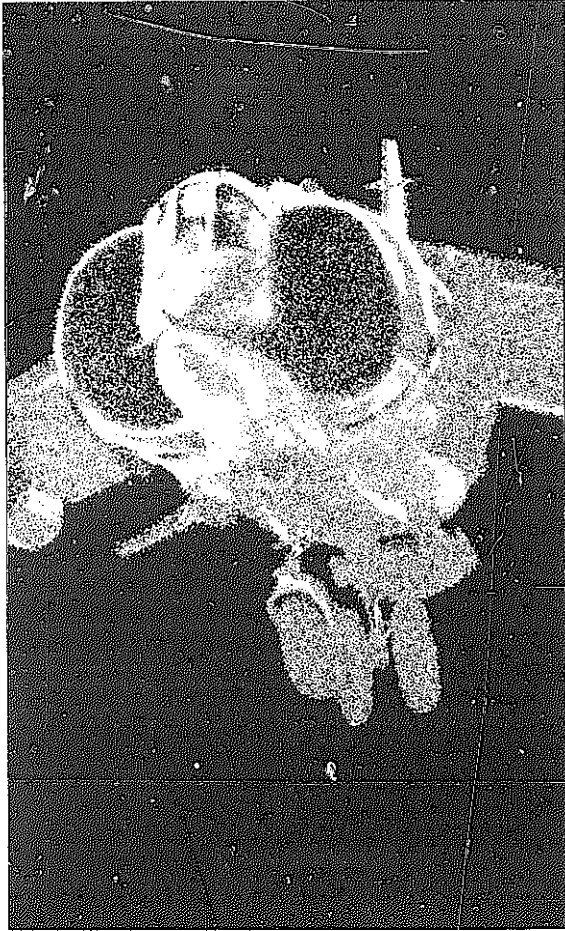

MBA ad in Electronic Warfare.



Amish, by John R. Zielinski.

End of the book

Not end of the process obviously.

I have no idea whether this civilization is in full decline or at last maturing toward some kind of sustainable balance.

Probably both, and which way it comes out is too early to know.

Either way, the sort of behavior this book is pushing is part of it. Is part of the widespread distrust of the "best" recent efforts of our institutions. As the ship of state churns gloriously on, crew members, no longer even bothering to insult the officers or jimmy the powerplant, are letting down boats a? night.

The ship, to its credit, lets them. And some of the officers listen closely for reports from the boats that survive and transmit. "How you boat people holding up?" "We!, it's tough but interesting. We're not ashamed any more." "YOU got room for company?" "Maybe, but why don't you see if you can do it where you are?"

For a change the country is not at war or in a depression. This is it, the Peace in Our Time that we fought for. The expectable cynicism and despair are indeed everywhere, but so is something else. You might call

it refinement. I call it attention to detail. Many call it a waste of time.

It is a form of caring. Caring to do things well—which often means doing it yourself. Caring for friends, neighborhood, people who can use help, and other organisms. E. F. Schumacher, rest his soul, commented that as the dominant species in our ecology we owe a noblesse oblige to the rest. That's accurate, I think, and people who are doing it find they enjoy it. Also it makes them humble.

I'm convinced that no one should ever try to inspire anyone else. It doesn't work anyway, and the opposite does. Soft Tech goes astray when it tries to proselytize. It's not a religion but a practice, and as such is easily imitated when it goes well. And an imitator, who can have his or her own ideas, is a far healthier creature to have in the world than a convert.

Marshall McLuhan's best line, I believe, is his remark somewhere that knowledge does not change behavior — experience does. This book is merely knowledge. Perhaps useful if you're doing something with it, worthless if you're not.

—SB

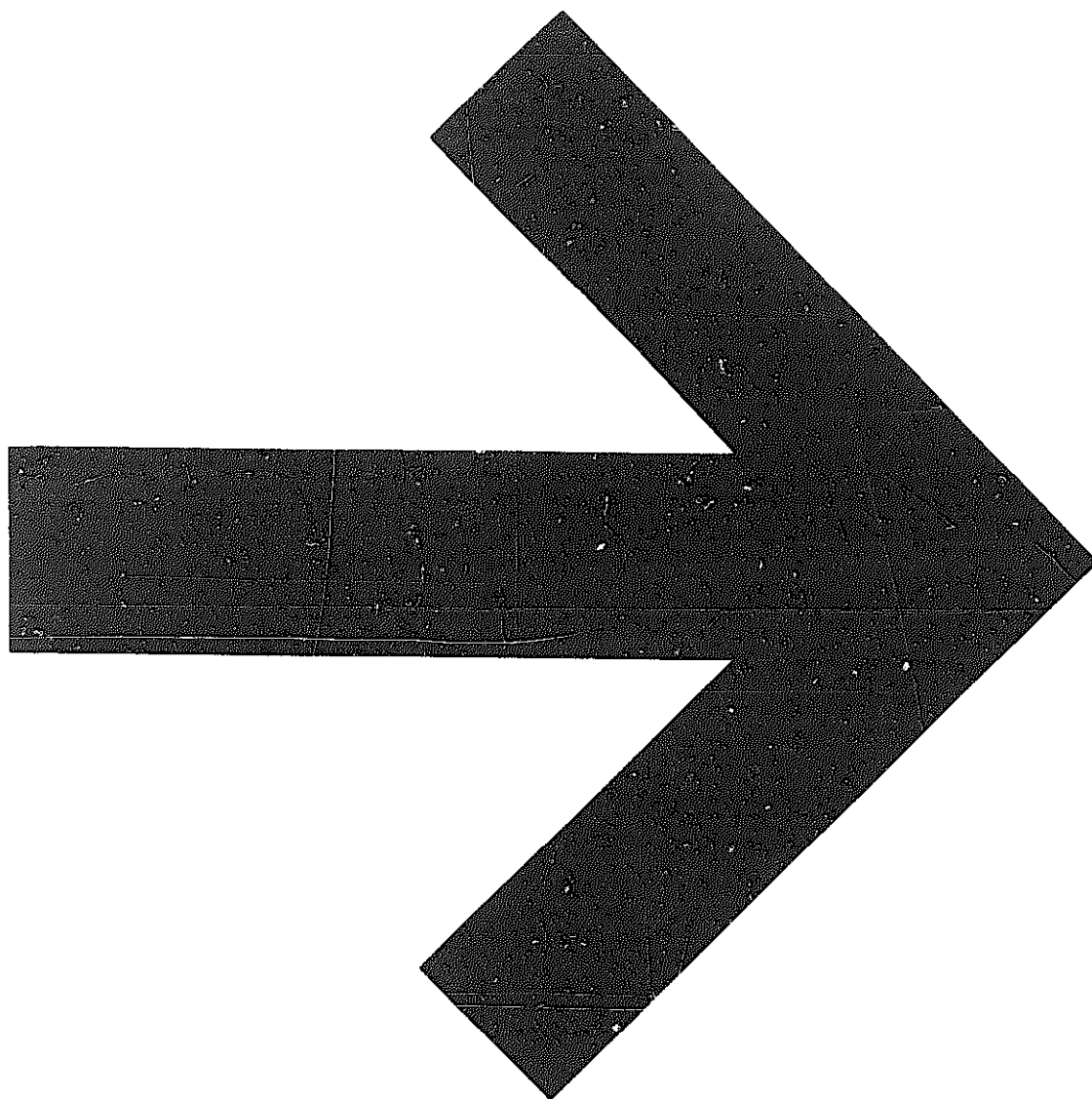

Index

A

Abandoned Buildings, How to Rehabilitate, 127
Aboriginal crafts, 29
Adams, W. Bridges
Adaptable Architecture, 120
Adhesives, 19, 21
Adobe cookstove, 94
Adobe houses, 115, 116
Adobe News, 115
Aero Power Research Co., 71
Agricultural Engineering, 86, 87
Agricultural Research Admin., USDA, 86
Agricultural residues, fuel from, 85-89
Agrimal (Malawi) Ltd., 27
Air circulators, 131
Air operated water pumps, 133
Airplane butyrate dope, 118
Alternative Sources of Energy, 28, 65
Alth, Max, 18
American Preservation, 127
American Sections, International Solar Energy Society, 49
American Underground Space Assn., 117
American Ventilating Assn., 133
American Wind Energy Assn., 72
Anaerobic digesters, 85-89
Anaerobic Digestion of Livestock Wastes to Produce Methane, 86
Anderson, Bruce, 65, 132
Animal-drawn farm equipment, 27
Ann Arbor, Mich., public transportation in, 78
Ann Arbor Science Publishers, 48
Appliance Service Handbook, 28
Appliances, 28
 kerosene, 28
 for mobile homes, 118
Appropriate Technology Sourcebook, 146
Aquaculture, 151-154, 162
Arc Welding, Procedure Handbook of The, 21
Architecture and Energy, 134
Arid Lands Studies, U. of Arizona, 84
Arizona, solar water heaters in, 62, 63
Arizona Sunworks, 135
Arks
 Cape Code, 148, 153-154, 155, 167
 miniature, 152, 153
 poster, 167
 Prince Edward Island, 152, 154-155, 156, 157; opening, 159-164, 166, 167
Armstrong, L. D., 29
Aspin, Terry, 20
Auerbach, Les, 88
August West Chimney Sweep Handbook, 95
Aushalser Kit, 19
Australian Traditional Bush Crafts, 29
Auto Enthusiast Directory, 79
Automobile Engineer, 86
Automobiles, *See* Cars
A-Z Solar Products, 46

B

Bach, Klaus, 120
Back to the City, 127
Backus, J. J., 59
Backyard fish-farm greenhouse, 151-152
Baer, Steve, 44-45
 anti metric system, 142-145
 on diving engine, 30-32
 on energy pie fallacies, 50-51
 on Nightwall, 33
 Sunspots, 34

Baier, Bernd, 120
Bailey, James, 58
Bailey, William J., 59-63
Bailey, William J., Jr., 63
Baker, Virginia, 127
Banks, Ridgway, 35-39
Barns, Sheds and Outbuildings, 122
Batteries, storage, 73
Battle-ax windmill, 74
Baumeister, Theodore, 29
Beadboard, 33
Beadwall, 34
Beckman, William A., 64
Bee Tee Engine & Equip. Sales, 96
Beedell, Suzanne, 75
Bender, Tom, 134
Bendixson, Terence, 78
Berstein Brothers, 24
Bibliography on . . . Portable and Small Stationary Gas Producers, 86
Bickerton portable bicycle, 82
Bicycles, 19, 80-83, 84
Bicycling Science, 82
"Big Bud 747," 22
Biofuels, 85-89; *see also* Wood, burning
Bioshelters, 41, 44-45, 135, 147
 New Alchemist: arks, 148, 152-155, 156, 157, 159-165, 166, 167;
 backyard fish-farm greenhouse, 151-152
 see also Village Homes
Biosphere, 44
Blackburn, Graham, 123
Blazing Showers Manual, 94
Boats
 living aboard, 119
 pump for, 146
 supplies and appliances, 118
Bockris, J. O'M., 85
Boardi Products Corp., 113
Boiler, woodburning, 94
Bonding compounds, 19
Book of the New Alchemists, The, 167
Bosch tools, 9
Boudreau, Eugene H., 27
Boulding, Kenneth, 145
Boyle, Godfrey, 147
Brann, Donald R., 92, 127
Breadbox Water Heater, 32
Breisch, Paul R., 84
Brookes, John, 45
Brooks, E. F., 55
Brookstone Tools, 8
Brown, Joe Eddy, 18, 123
Brownstone Revival Comm., 127
Bruyère, Christian, 126
Bubble wheel engine, 30-32
Buckley, B. Shawn, 64
Building code, Davis, Ca., 136, 140
Building code, Uniform, 128
Building with Logs, 126
Building Value: Energy Design Guidelines for State Buildings, 134
Buildings. *See* Homes
Burgel, Jim
 on anaerobic digesters, 88-89
 on bicycles, 80-81
Burke, Barbara L., 72
Burns, Al, 113
Butti, Ken, 52-63

C

Calder & Boyers Ltd., 128
California
 energy policy, 134; Davis, 136, 140
 oil recycling in, 79
 solar information packet, 64
 solar heaters in, 52-63

California Energy Comm., 64
Callenbach, Ernest, 78, 168
Campbell, Alex, 161, 163, 167
Campers, living in, 117, 118, 119
Canadian ark, 152, 154-155, 156, 157
 opening of the, 159-164, 166, 167
Canvas, coating, 118
Cape Cod ark, 148, 153-154, 155, 167
Cargo tricycle, 19
Carpentry, 123, 124, 125; *see also* Tools
Carr, Marilyn, 146
Carroll, R., 54, 63
Cars, 76-77, 79
 alternatives to, 78, 79; bicycles, 80-83, 84; steam engines, 84
Case, Betsy, 119
Central Tractor Parts Co., 24
Century Tool Co., 96
Chalroudi, Day, 40-45, 154
Chain saws, 96
Chimney Sweep Handbook, August West, 95
Chuang, Roger, 114
Citroen Dts., 76-77
City, Back to the, 127
Clarke, Robin, 149
Clearinghouse for Earth Covered Buildings, 112
Climatic Envelope, 41, 44
Clinax solar water heaters, 53-55, 56, 57
 Improved Climax, 58-59
Clivus Multrum toilet, 89, 157, 163
Cloud Gel, 40-45
Cloudburst 2, 28
Coggin, J. K., 29
Cole, John N., 122
Coles' Power Models, 84
Colorado State University, 72
Complete Book of Heating with Wood, The, 92
Components for Solar Energy Systems catalog, 46
Composting toilet, 89, 157, 163
Concrete, 114, 123, 134
Concrete Approach to Energy Conservation, 134
Concrete & Formwork, Construction Manuals, 123
Congers, W. H., 55
Construction Estimator, National, 113
Construction Manual: Concrete & Formwork, 123
 Finish Carpentry, 123
Continuous-band Nitinol engine, 37, 39
Coolers, 114
Coonley, Douglas R., 73
Coperthwaite, Bill, 18
Corbett, Mike, 136-139
Country Comforts, 126
Crandall, William W., 60-61
Crawther, Richard L., 48
Crop residues, fuel from, 85-89
Crosscut Saw Manual, 96
Crosscut saws, 96
Cumberland General Store, 26
Curl, Huldah, 134

D

Daneker, Gail, 141
Darrow, Ken, 146
Davis, Ca., energy standards, 136, 140
 subdivision, 136-139
Day-Land Steam Engines, 84
Day and Night solar water heaters, 59-63
Decimal system, 142-145
Denmark, wind turbine in, 71
Dennis, Ben, 119

Department of Energy, U.S., 71
Deppen, David, 113
Derby Log Splitter Co., 96
Design with Wind, 73
Designing Houses, 123
Devecon Corp., 19
Developing countries, appropriate technologies for, 73, 114, 146, 152
Dial-a-Ride, 78
Dictionary of Scientific and Technical Terms, McGraw-Hill, 29
Dictionary of Tools, 25
Diesel engines, 77
Dip molded blocks, 114
Diving engines, 30-32
Divone, Louis, 71
Do-It-Yourself Plumbing, 18
Dodge Products, 64
Drafting Technology and Practice, 20
Drill press, 28
Drumwall, 34
Drying bin, solar, 65
Duffie, John A., 64
Duffield, Christopher, 84
Dunlavy, Harrison A., 133

E

Earth covered buildings, 98-112
ecological benefits of, 104-108, 110
health benefits of, 112
industrial, 112
organizations for, 112
Earth houses, 115, 116
Eastman, Margaret and Wilbur F., 92
Eckholm, Erik P., 97
Ecodevelopment News, 146
EcoDog, 79
Ecology, 97
and suburban planning, 136-139
and underground homes, 104-108, 110
and urban planning, 129
see also Bioshelters
Economically Appropriate Technologies for Developing Countries, 146
Economy Driving, The Whole Truth about, 79
Ecosol Ltd., 47
Ecosol 101 Energy Recovery System, 47
Ecotopia, 168
Edmund Scientific Co., 18, 140
Edwards, Ron, 29
Eliason, Alton, 88
Elliott, Stewart, 125
Employment, and energy, 141
Energy, 7, 129, 141
alternative, sources of, 7, 28, 34, 46, 48, 65, 78, 146, 147; see also Solar energy; Wind energy
anaerobic digesters, 85-89
conserving, 7, 134, 140
by improving gas furnances, 130-131
by insulating windows, 33, 40, 43, 47
by solar energy. See Solar energy
by subdivision planning, 136-139
by wind power, 72, 73
see also Bioshelters
and employment, 141
geothermal, 84
hydrogen, 85
solar. See Solar energy
steam, 84
steam, 84
water, 28
wind, 70-75, 110, 152, 155, 161, 163
wood, 29, 90-95
see also Bioshelters; Diving engines;
Solar energy
Energy Basis for Man and Nature, 141
Energy Conservation, A Strategy for, 136, 140
Energy Conservation Building Code Workbook, 140

Energy and Form, 129
Energy pies, 50-51
Energy Primer, 7
Energy: The Solar-Hydrogen Alternative, 85
Energy, U.S. Dept. of, 71
Energy from the Wind, 72
Engineering Research Center, Colorado State U., 72
Engines
bubble wheel, 30-32
Nitinol, 35-39
peddle powered, 78, 80-81
VW, modified, 20
Enhanced Solar Energy Collection, . . .
Environmental Law Institute, 79
Environmentalists for Full Employment, 141
Equinoctial Year project, 66-69
Equipment Digest, New, 19
Estacion Experimental Choqui, 94
Evergreen State College, 86
Experiences in Visual Thinking, 18

F

Farallones Institute, 74, 75
Farm, Ideas for All Around the, 122
Farm Builder's Handbook, 122
Farm equipment, 24
hand-operated, 24, 27
tractors, 22-23, 24
Farming, 122
buildings, 122, 126
food preserving, 26
food storage, 114
ploughs, 22, 27
scythes, 24
tractors, 22-23, 24
supplies, 24
Fences, 24
Ferrari tractors, 23
Ferrocement: Applications in Developing Countries, 114
FHA, 139
Fireplaces, 92; see also, *Stone Masonry*;
Wood, burning
Fish culture, 151-154, 162
Fisher, Rick, 135
Flashlights, nonbattery, 18
Florida, solar water heaters in, 63
Food, growing. See Bioshelters;
Greenhouses; New Alchemists
Food and Agriculture Organization, UN, 26
Food and Heat Producing Solar Greenhouse, The, 135
Food storage, 65, 114; see also *Food Preservation*
Food from Windmills, 75
Forest Service publications, 96, 124
Forestiere, Baldasare, 98-101
Forestiere, Lorraine, 100
Forestiere Underground Gardens, 98-101
Foundry:ork for the Amateur, 20
Fraenkel, Peter, 75
Framing Book, The Timber, 125
Franklin, Benjamin, 92
Fredson Trailer Supply, 118
From the Ground Up, 122
Fry, L. John, 88
Furnances, heat loss through, 130-131

G

Gage, Tom, 7
Garden Way Cart, 27
Gardner, Fred, 35-39
Garrett Wade Co., 8, 19
Garwood, J., 84
Gas furnances, 130-131
Gas (methane and methanol) producers, 85-89
bibliographies on, 85, 86, 87

Gas water heaters, 54, 62-63
Gasification, 85-89
Gay, Larry, 92
Gearmore, Inc., 23
Gedsermill, 71
"Gem" tractor, 22
Gemini Synchronous Inverter, 73
Generator, gas, 85-89
Generators
water turbines, 28
wind, 70, 71, 73, 154, 155, 161, 163
Gengas, 86
Geothermal energy, 84
Geothermal Technoecosystems and Water Cycles in Arid Lands, 84
Gilday, Len, 124
Glass House, The, 129
Glues, 19, 21
Goc, Mike, 74
Goldoni tractors, 23
Good Neighbor Heritage Catalog, 25
Good Shelter, 140
Goodrich, W. W., 74
Good Time Stove Co., 90
Goodheart-Wilcox Co., The, 125
Goss, J. R., 87
Gould, R. L., & Co., 96
Grasshoppers, collector for, 24
Gray, Virginia, 115
Gravelly Corp., 22
Green Wood House, The, 124
Greenhouses, 129, 132, 135
arks, 152, 153, 154, 156, 160
backyard fish-farm, 151-152
Gria Shells, 120
Grossman, Richard, 141
Grumman Sunsteam solar hot water heater, 47
Gunn, Jack, 37

H

Hackenberg, Larry Michael, 124
Hagen, David Le Roy, 85
Hagopian, "Hap," 36, 38
Halsted, Byron D., 122
Hamilton, Blair, 45
Hammond, Jon, 136, 140
Hand cream, 21
Hand-operated farm equipment, 22, 27
Hand saws, 96
Handbook of Moving Air, The, 133
Harmony with Nature, In, 126
Harper, Pete, 147
Hartman, Pete, 25
Haskell, Charles, 58
Hastings Pavement Co., Inc., 113
Heat exchangers, 46
Heat Mirror, 40-45
Heat Pumps, An Introduction to, 133
Heating (homes)
by solar energy, 42-45, 47, 48, 64, 132, 133, 137-138
by wind energy, 72
by wood, 29, 90-95
see also Water heaters
Heating with Wood, The Complete Book of, 92
Hellstar Hot Water Heater, 118
Hennicke, Jurgen, 120
Hernandez, H. Paul, 36-37
Herzog, Thomas, 120
Hibbert, Sue, 94
Hix, John, 129
Hodge, Mel, 45
Hofacre, John, 137-138
Holloway, Dennis, 134
Home Is Where You Park It, 119
Home Techniques, 26
Homes
adobe, 115, 116
bioshelters, 41, 44-45, 110, 135, 147;
New Alchemist, 148, 150-155, 156, 157, 160-165

boats as, 118, 119
 building, 122, 123, 134
 and building codes, 128, 140
 estimating costs, 113
 log, 126
 heating
 by gas/forced air, 130-131
 by solar energy, 40-45, 47, 48, 64,
 110, 132, 133, 138, 141; see also
 New Alchemists
 by wind energy, 72, 73, 110
 by wood, 90-95, 128
 houseboats, 119
 insulating, 13,
 windows, 33, 40, 43, 47
 mobile, 118, 119, 140
 nets, 120
 one room, 117
 pneumatic, 120
 prefabricated, 140
 rehabilitating, 127
 roofs, 140
 self-sufficient: see bioshelters (above)
 solar, 40-45, 48, 64, 116, 132, 140
 subdivision, 136-139
 see also bioshelters (above): *Glass
 House*
 tension structures, 120-121
 tipis, 116
 trailers, 118, 119
 underground, 98-111, 112
 ventilating, 133
 Village Homes subdivision, 136-139
 see also Water heaters
Homegrown Sundwellings, 116
Homemade Windmills of Nebraska, 74
 Homesteading
 building structures, 122-126
 hand-operated equipment, 24, 27
 and small tractors, 22-23, 24
 supplies, 24
 water pipe, 24, 114, 116
 see also Bioshelters: *Wind power*
 Honda: Accord, 76-77; Civic, 76-77
 Hopperdozer, 24
 Horsfield, Brian, 87
 Horvitz, Robert, 66
 Hotchkiss, Theodore, 53
 Houseboat, 119
 Housebuilding. See Homes, building
 Houses. *Designing*, 123
Housing by People, 128
 Housing Code, Davis, Ca., 136, 140
 Housing Code, Uniform, 128
 How to Install a Fireplace, 92
 How to Rehabilitate Abandoned
 Buildings, 127
 How to Run a Lathe, 21
 HS boiler, 94
 Hungness, Carl, & Associates, 79
 Hunt, Marshall, 140
 Husqvarna chain saws, 96
 Hutchinson, Bill, 20, 114
 Hydrogen energy, 85
 Hydrowind, 154, 155, 161, 163

I

Ice house, 122
Ideas for All Around the Farm, 122
Illustrated Housebuilding, 123
 Improved Climax solar water heaters,
 58-59
In Harmony with Nature, 126
*Index of Possibilities, An: Energy and
 Power*, 146
Indian Tipi, The, 116
 Industrial Cycles, 19
*Inexpensive Evaporative Coolers for
 Short Term Storage of Fruits and
 Vegetables*, 114
 Inflatable bubble, 45
 Infrared absorbing enamel, 46
 Institute for Lightweight Structures, 120

Insulation, 131, 140
 alternatives to, 33, 130-131
 Heat Mirror, 40-45
 for windows, 33, 40, 43, 47
 Intermediate Technology Development
 Group, 27
 International Development, Board on
 Science and Technology for, 114
 International Research Center on
 Environment and Development,
 146
 International Solar Energy Society, 49
Introduction to Heat Pumps, An, 133
 Inwood, Robert, 126
 Iron Horse Antiques, Inc., 25
 Irrigation pipes, 24; see also Water pipe
 Irwin, William A., 79

J

Jaakson, Jaan, 93
 Jacobs Wind Electric Plants, 71
 Jari Division tractors, 22
 Jeepney, 146
 Jemco Tool Corp., 96
Jobs & Energy, 141
 Johnson, Dave, 37, 39
Journal of the New Alchemists, 149,
 152, 157, 158, 167
 Jun-bo windmill, 74

K

Kahn, Betty Fluegelman, 127
 Kalamazoo, Mich., sewage treatment
 in, 88-89
 Kalker, Alan, 20, 24
 Keleher, Steve, 21
 Kemp, Clarence M., 52, 54-55
 Kern, Ken, 124, 125, 128
 Kerodex, 21
 Kerosene appliances, 25
 Knowles, Ralph L., 129
 Kogon, Ted, 128
 Kokesch, Paul, 122
 Koojiman en de Vries, 118
 Kubota Tractor Corp., 23

L

Labor Saving Ideas, 26
 Lapedes, Daniel N., 29
Lathe, How to Run a, 21
 Laubin, Reginald and Gladys, 116
 Laughlin, Thomas, 26
 Lawrence Berkeley Laboratory Nitinol
 engines, 35-39
 Le Corbusier, 143-144
 Leckie, Jim, 147
 Lehman Hardware & Appliances, Inc.,
 25
 Light Steam Power, 84
 Lightweight structures, 120-121
 Liman, Ellen, 117
 Lincoln, John Ware, 85
 Lincoln Electric Company, 21
Live Steam, 84
Living Aboard, 119
Living in One Room, 117
 Living Systems, 136
 Local dependency, 5
 Log houses, 126
 Lombardini engines, 23
 Lorena cookstove plans, 94
 Los Angeles, solar heaters in, 55, 57,
 59-63
Losing Ground, 97
 Love, T. W., 123
 Lye, 26, 27
 Lyle, David, 94
 Lytle, R. J., et al., 122

M

McCall, Wayne, 115
 McCullagh, James C., 78
 McDaniels, D. K., 64

*McGraw-Hill Dictionary of Scientific
 and Technical Terms*, 29
 McGrew, Jay L., 130-131
 Mackie, B. Allan, 126
 McKim, Robert H., 18
 Macrae, Alan, 115
 Magers, Steve, 125
 Magnetic clips and strips, 33
*Manual on Sharpening Hand
 Woodworking Tools, A*, 29
 Manure, and anaerobic digesters, 86-89
 Margulis, Lynn, 168
 Marine Publishing Co., International,
 118
Mariner's Catalogs, The, 118
 Marks, Vic, 28, 96
*Marks' Standard Handbook for
 Mechanical Engineers*, 29
 Marugg Co., 24
 Masonry, 125
 Mathew, Henry, 64
 Maul, 95
 Measurement, systems of, 142-145
*Mechanical Engineers, Marks'
 Standard Handbook for*, 29
 Menninger, Rosemary, 27, 97
 Meroney, Robert N., 72
 Merrill, Richard, 7
 Methane, 86-89
Methane Power Plants, 88
 Methanol, 85-86
*Methanol: Its Synthesis, Use as a Fuel,
 Economics, and Hazards*, 85
*Methanol & Other Ways Around the
 Gas Pump*, 85
 Metric system, 142-145
 Mexican water heater, 94
 Meyer, Hans, 73
 Meyer-Miethke, Stefan, 120
 Meyerink, George, 28
 Michigan, U. of, Dept. of Agricultural
 Engineering, 86
 Miller, Warren, 96
 Milstein, Jeff, 123
 Miniature ark, 152, 153
 Missar, Chuck, 72
 MITRE Corp., The, 70
 Mobile homes, 140
 appliances for, 118
 boats, 118, 119
 houseboats, 119
 trailers, 117, 118, 119
Modern Carpentry, 125
*Modern and Classic Woodburning
 Stoves*, 92
 Modular system, 143-144
 Moeller, Jan and Bill, 119
 Molded blocks, 114
 Monarch mower, 22
 Mopeds, 79
 Moore, C. William, 84
 Moore, James A., 86
 Moreland, Frank, 112
 Moselle, Gary, 113
 Moss, Bill, 121
 Motor homes, 117, 118, 119, 140
Moving Air, The Handbook of, 133
 Mowers, 22
Mud, Space & Spirit, 115
 Mutual Hardware Corp., 20

N

Naar, Jon, 117
 National Academy of Sciences, 114
National Construction Estimator, 113
 National Equipment Distributors Assn.,
 23
 Naval Surface Weapons Center
 (Nitinol), 39
Nebraska, Homemade Windmills of, 74
 Neighborhood preservation, 127
 Nets, 120
 New Alchemy Institute, 149, 157-158,
 167

memberships, 167
 principles, 149-150
 projects, 155, 156
 arks, 148, 152, 153-155, 156, 157,
 165; opening of Prince Edward
 Island ark, 159-164, 166, 167
 backyard fish-farm greenhouse,
 151-152
 hydrowind, 154, 155, 161, 163
 solar ponds, 152-153, 154, 162
 publications, 156-157, 158, 165, 157
New Equipment Digest, 19
 New Mexico, U. of, 71
 Nextel optical paint, 46
 Nightwall, 33
 Nilsen, Richard
 on Australian bush crafts, 29
 on environmentally planned
 subdivision, 136-139
 on farm equipment, 22-23, 24
 on gas furnace heat loss, 130-131
 on insulation, 131
 Nitinol engines, 35-39
 North Wind Power Co., 71
 Northeast Carry, 93
 Northern Manufacturing Co., 22
 NTIS, 72, 85, 112

O

Odum, Howard T. and Elizabeth C., 141
 "Oil Recycling Act. A Model Used,"
 79
Old House Journal Buyers' Guide, The,
 127
One Room, Living In, 117
 Optimum 200 tent, 121
 Ossberger-Turbinenfabrik, 28
Other Homes and Garbage, 147
 Otto, Frei, 120
 Otwell, William, 135
 Owens Valley, Ca., 129
Owner-Builder and The Code, The, 128
 Owner Built Publications, 128
Oxy-Acetylene Handbook, i

P

Paint, optical black, 46
 Pam, Rick, 146
 Papworth, Mark L., 86
 Park, Jack, 72
 Paving blocks, porous, 113
 Peck, John, 92
Pedal Power, 78
 Pedal truck, 19
Pegasus Unit, The, 86
 Penfield, Lou, 125
 Pennsylvanian Fireplace, 92
 Perlin, John, 52-63
 Perlin, Luba, 53
 Pesko, Carolyn, 48
 Peterson, Kay, 119
 Philippines, jeepney industry in, 146
 Pilot Plant Gas Producer, 87
 Pioneer Lamps and Stoves, 95
 Pitcher pump, 24, 74
Planning and Building Your Fireplace,
 92
Plant a Tree, 97
 Ploughs, 22, 27
 Plumbing, 14, 18
Pneumatic Structures, 120
 Porous paving blocks, 113
 Portland Cement Assn., 134
 Power sources, 7, 28, 65, 146, 147
 diving engines as, 30-32
 peddle, 78, 80-81; *see also* Bicycles
 solar. *See* Solar energy
 steam, 84
 VW engine as, 20
 water, 28
 wind, 70-75, 110, 152, 155, 161, 163
see also Energy
 Prefabricated homes, 140
Preservation, American, 127

Prince Edward Island ark, 152, 154-155,
 156, 157; opening, 159-164, 166,
 167; *see also* New Alchemists
 Pro water heater, 33
Procedures Handbook of Arc Welding,
 The, 21
*Proceedings of the Symposium on the
 Development and Utilization of
 Underground Space*, 112
 Producer gas, 85-89
 Public transportation, 78, 146
 Pueblos, energy flows in, 129
 Pumps
 air operated, 133
 pitcher, 24
 windmill, 74, 75
 water (boat), 146

R

Rabb, Judith and Bernard, 140
Radical Technology, 147
 Railroad bicycle, 80
*Rain: Journal of Appropriate
 Technology*, 7
Rainbook, 7
 Ranch supplies, 24
 Recreational vehicles (RVs), as homes,
 117, 118, 119
 Recycling
 and anaerobic digesters, 85-89
 and composting toilets, 89, 157
 oil, 79
 Refrigeration Research, Inc., 46
 Refrigerators, 25, 28, 46
Rehabilitate Abandoned Buildings,
How to, 127
 Reid, Jo, 92
 Repairs, 19
 appliance, 28
 plumbing, 14, 18
 tools for, 8-17
 Richardson, Fred, 21
 Richardson, Richard, 90
 Riordan, Michael, 132
 Roach, Rob, 65
 Roe, Doug, 79
 Rohm & Haas, Plastics Dept., 47
 Rosenstock-Huessy, Eugene, 145
 Ross, Bob and Carol, 92
 Ross, Charles, 66-69
 Rotavator's, Howard, 22
 Rothenberger USA, 19
 Roto-tillers, 23
Rural Home Techniques, 26

S

Sachs, Beth, 45
 Sachs Dolmar Chainsaw, 96
 Sailboats, living on, 119
 Salaman, R. A., 25
 Satoh tractors, 23
 Saussure, Horace de, 52
 Saws, 96
 Schaur, Eda, 120
 Schwartz, Hernando, 79
 Scientific terms, dictionary of, 29
 Scythes, 24
 Sealing tape, 19
 Sears, 8, 9
 Seasteading, 118, 119
Seriatim, 168
 Serrande shutters, 47
 Sewage
 and anaerobic digesters, 85-89
 and composting toilets, 89, 157
 Zimpro process, 89
 Shadduck, Gregg, 86
 Shapiro, Andrew B., 91
 Sharpening, 29, 96
Sharpening Hand Woodworking Tools,
A Manual, 29
 Shelton, Jay, 91
 Sherson, Marc, 33
 Shurcliff, Wm. A., 48
 Shutters, 33, 47
 Shuttleworth, Richard, 88
Sierra Madre, Ways of the, 27
 Sili shutters, 33
 Silvo Hardware Co., 8
*Simplified Wind Power Systems for
 Experimenters*, 72
 Siple, Molly, 117
 Skov, Neils A., 86
 Skylids, 34
Skylight Book, The, 113
Skylight Water Heater, 34
 Smith, J. D., 24, 126
 Soap, making, 27
Solar Age, 46, 49, 65
Solar Age Catalog, 46
 Solar Bookshop, 73
 Solar burn project, 66-69
 Solar diode, 64
Solar Directory, 48
 Solar energy, 7, 141, 147
 bioshelters, 41, 44-45, 135, 147; New
 Alchemist, 148, 152-155, 156, 157,
 159-165, 166, 167
 as conserving other energy, 43-44,
 47, 134, 140; *see also* bioshelters
 (above), water heaters (below)
 costs, figuring, 64
 Davis, Ca., building code, 136, 140
 directory, 48; *see also* products,
 sources of (below)
 and energy pies, 50-51
 and energy subsidies, 141
 engines, potential, 30-32, 35-39
 enhancing, 64, 65
 and fish culture, 151-154
 and heat pumps, 133
 homes, 40-45, 47, 48, 64, 116, 132,
 133, 135
 checking potential, 140
 costs: figuring, 64; in Village Homes,
 138
 subdivision, 137-139
*see also Glass House, The: New
 Alchemists; water heaters* (below)
 information packet, 64; *see also*
 magazines (below)
 magazines, 7, 49, 65, 167
 measuring, 64
 products, sources of, 32, 33, 34, 46,
 48; *see also* magazines (above)
 societies, 49
 and solar burn project, 66-69
 and solar rights, 138
 water heaters, 32, 33, 34, 47, 64,
 132, 137-138; early Californian,
 52-63
 Solar Energy Assn. (ISES), 49
Solar Energy Digest, 65
*Solar Energy: Fundamentals in
 Building Design*, 132
 Solar energy societies, 49
 Solar Energy Systems, Components for,
 46
Solar Energy Thermal Processes, 64
 Solar Gravity Drivers, 34
*Solar Greenhouse, Food and Heat
 Producing, The*, 135
Solar Heated Buildings, 48
 Solar heating. *See* Solar energy, homes
 and hot water heaters
Solar Home Book, The, 132
 Solar homes. *See* Solar energy, homes
 Solar information packet, Ca., 64
 Solar Meter, Pocket, 64
 Solar ponds, 152-153, 154, 162
Solar Potential, Your Home's, 140
 Solar rights, 138
 Solar Room, 135
 Solar Sustenance Project greenhouse,
 132
 Solar water heaters. *See* Solar energy,
 water heaters

Sotz wood splitting maul, 95
 South Bend Lathe, 21
Spacemaker Book, The, 117
Spectrum, 28
 Spence, William P., 20
 Spetgand, Irwin, 140
 Splitting maul, 95
 Squibb, Paul, 61
 Stauffer, Truman, 112
 Stauffer's Machine Shop, 133
 Steam energy, 84
 Steam engines, 84
 Stein, Richard G., 134
 Stickler, The, 95
 Stihl chain saws, 96
Stone Masonry, 125
Storage Batteries, 73
 Storage, of food, 65, 114
Stove Book, 92
 Stoves, woodburning, 56, 90-95
 and water heaters, 53-54, 56, 94
Strategy for Energy Conservation, A,
 136, 140
 Subdivision, environmentally planned,
 136-139
Successful Farming, 122
 Sumner, John A., 133
 Sun calculator, 34
Sun Earth, 48
 Sunlight convergence project, 66-69
Sunspots, 34
 Sunstream, 47
 Suntek Research Associates, 40-45, 148,
 154
 Sweden, heating by wind power in, 72
 Swedish Royal Academy of Engineers,
 86

T

Tahiti, public transportation in, 78
 Taos Equipment Manufacturers, Inc., 95
 Technical illustrating, 20
 Technical terms, dictionary of, 29
 Technoecology, 84; *see also* New
 Alchemists
 Technology Application Center, U. of
 N.M., 71
 Tekton Design Corp., 94
 Tension structures, 120-121
 Tent Works, 121
 Tents, 121
 Thallon, Rob, 128
 Theatrical equipment and supplies, 20
 Thermal paint, 46
 Thermic diode solar panel, 64
 Thermocrete, 42-45
*This Is How You Can Heat Your Home
 with a Little Windmill*, 72
 Tilapia raising, 151-154, 162
 Tilford, Charles, 45
Tinber framing Book, The, 125
 Tin ceilings, 127
 Tingley, A. G., 74
 Tipis, 116
 Titanium Metals Corp. of America, 39
 Todd, John, 149-158, 160, 162, 167
 Todd, Nancy Jack, 149, 162, 164, 167
 Tool catalogs, 8, 19, 21, 25, 26
 Tool chest, 13-14, 16-17
 Tool dictionaries, 14, 25
 Tools, 8-17
 antique, 25
 buying, 8-11
 mail order sources of, 8, 25, 26
 sharpening, 29, 96
 storing, 11-14, 16-17, 18
 Torchia, Joseph, 98-100
 Torrey, Volta, 70
 Tract homes, environmentally planned,
 136-139
 Tractor Parts Co., Central, 24
 Tractors, 22-23, 24
 Trailers, 117, 118, 119, 140

Transportation
 bicycles, 79, 80, 82-83, 84
 cars, 76-77, 79
 alternatives to, 78, 79
 mopeds, 79
 public, 78, 146
Tree, Plant a, 97
 Truck, Le, 78
 Trudeau, Pierre Elliot, 159, 163, 166,
 167
 Trupin, Bob, 35, 39
 Tubes, joining, 19
 Tuffak-Twinwall, 47
 Turbines
 water, 28
 wind, 69; *see also* Wind energy
see also Nitinol engines
 Turner, John F. C., 128

U

UC, Davis, 87
Underground Designs, 103
 Underground buildings, 102-111, 112
 Baldasare Forestiere, 98-101
 ecological benefits of, 104-108, 110
 health benefits of, 112
 organizations for, 112
*Underground Space, Proceedings of the
 Symposium on the Development
 and Utilization of*, 112
 Underground Space Assn., American,
 112
Underground Space Journal, 112
 Union Carbide Corp., 21
 U.N. Home Techniques books, 26
 U.S. General Supply, 8
Use of Earth Covered Buildings, The,
 112
 Utah Press, U. of, 66

V

Van Dresser, Peter, 50, 116
 Van Rossem, Walter, 55, 56
 Ventilation, 133
 Vesuvius, 84
 Village Homes, 136-139
 Vinal, George Wood, 73
 Vineyard, Jerry D., 112
Visual Thinking, Experiences in, 18
 Vivian, John, 90
 Volkswagen of America, 20, 76-77
 Volkswagen engines, modified, 20
 Volkswagen Rabbit, 76-77

W

Wagner, Willis, H., 125
 Walker, Frank, 55, 58
 Walker, Les, 123
 Walker solar water heater, 55, 58
 Wallas, Eugenie, 125
 Ward, Chris, 84
 Wastes. *See* Recycling
 Water heaters, 28
 Blazing Showers, 94
 gas, 54, 62-63
 Mexican, 94
 for mobile homes, 118
 solar, 32, 33, 34, 47, 64, 132,
 137-138
 early Californian, 52-63
see also Solar energy, homes
 stove, 53-54, 59, 94
 wind, 72
 woodburning boiler, 94
 Water pipe
 dip molded process for, 114
 irrigation, 24
 wooden, 126
 Water pumps, 24, 74, 75, 133
 for boats, 146
 Water turbines, 28
 Wateryoke, 24
Ways of the Sierra Madre, 27

Weber Gallery, John, 66
 Weiner, Michael, 97
 Welding, 21
 Wellesley-Miller, Sean, 45, 154
 Wells, Malcolm
 on Forestiere's Underground Gardens,
 101
 on solar potential, 140
 on underground architecture, 102-111
 Wheat grinder bicycle, 80-81
 Wheelbarrows, 27
 Whitacre, Kathleen, 117, 159-164
 Whitt, Frank Rowland, 82
*Whole Truth about Economy Driving,
 The*, 79
 Wik, Ole, 94
 Wildwood House, Ltd., 146
 Williams, Linda, 18
 Williams, R. O., 87
 Wilson, David Gordon, 82
Wind-Catchers, 70
 Wind energy, 70-75, 110, 152, 154
 bibliographies of, 71, 72
 blades, wooden, for, 71
 generators, 70, 71, 73, 155, 161, 163
 for heating, 72
 hydrowind, 155, 161, 163
 turbines, 71
 Wind Energy Conversion Systems,
 Workshop on, 70
Wind Energy Utilization, 71
Wind Power Digest, 71
*Wind Power Systems for Experimenters,
 Simplified*, 72
Wind Technology Journal, 72
Wind Workshop 2, 70
Wind Vane, 119
 Windmills. *See* Wind energy
Windmills, 75
 Windows
 insulating, 33, 40, 43, 47
 shutters, 33, 47
 Windworks, Inc., 73
 Wing, Charles, 122
 Winona, 134
 Without Wheels, 78
 Wood
 burning: ethics of, 90-91
 fireplaces, 92
 heat values compared, 29
 heating, boiler, 9; and building
 code, 128; stoves, 90-95
 splitting for, 95
 carpentry, 123, 124, 125; *see also*
 Tools
 cutting, 96
 houses, building, 123-126
 sawing, 96
Wood Burning Quarterly, 93
Wood 'N Energy, 93
Wood Handbook:
Wood Heat, 90
 Wood Stove Buyer's Guide Poster, 93
Wood Stoves, 94
Woodburner's Encyclopedia, The, 91
 Woodburning stoves, 90-95
*Woodburning Stoves, Modern and
 Classic*, 92
 Woodcraft Supply Corp., 8, 25, 96
 Woodworking tools, 8, 19, 25
 sharpening, 29

Y

Yanda, Bill, 135
 Yanmar tractors, 23
 Year-A-Round Cab Corp., 22
 Year shape, 68-69
Your Home's Solar Potential, 140

Z

Zimmerman Sewage Process, 89
 Zimpro sewage treatment, 89
 Zomeworks, 30, 32-34

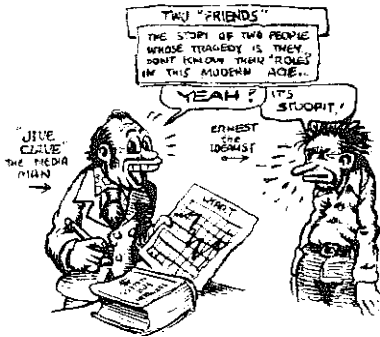

Business

Thanks to a generous and efficient arrangement with Penguin, these CoEvolution Books are helping keep us going. The deal is, Penguin buys finished books from us at 25% of cover price (\$1.25 each for this \$5 book) in orders of 15,000 copies or more. They're buying 30,000 copies of the first printing of Soft Tech (for \$37,500) to distribute in the U.S., Canada, and England. We're printing an additional 3,000 for direct mail order sale from us.

The \$5 you pay for Soft Tech at a bookstore goes in the following directions:

\$240 to the bookstore
 1.35 to Viking-Penguin
 1.25 to us (0.73 is profit)
 \$5.00

We're enabled to produce this dense a book this cheaply by virtue of the on-going accumulation of goodstuff for The CoEvolution Quarterly. The CQ does not make money (usually it loses), but the books do make a little, so it balances out.

The first CoEvolution Book Space Colonies (\$5) is doing splendidly — 37,000 copies in print, with a third updating and printing coming soon. This summer (July '78) we'll see the third CoEvolution book, Peter Warshall's Watersheds (\$61, which is mostly all-new material, some of it derived from Peter's much-praised Watershed Issue of the CQ.

Down the line, into 1979, we're scheming 1) Treelife — half of it new material, and 2) Good Stories — mostly reprint, as this book is. Our map Biogeographical Provinces of the World (\$3) is such a steady seller that we've done a 1978 update and second printing (6,000 now in print). Joining it this summer will be a computer-photo-map poster "1,000,000 Galaxies" (price not yet determined).

All the green goes into and comes out of the same purse — POINT, a non-profit educational foundation. Once upon a time POINT made over a million bucks from the Whole Earth Catalog and gave it away (to people like the New Alchemists).

Since those windfall monopoly days we've been joined by considerable and lively competition. And glad of it.

—SB

SOFTTECH

Editors J. Baldwin, Stewart Brand
 Office Manager Andrea Sharp
 Assistant Editor Anne Herbert
 Design Editor Randall Goodall
 Typesetting Evelyn Eldridge
 Production Manager Susan Goodrick
 Production Kathleen O'Neill, Andrew Main, Carol Kramer, Diana Fairbanks, Don Ryan
 Index Sara Betty Berenson
 Research Patty Phelan, Rosanne Kramer
 Illustrations Don Ryan, Carol Kramer, R. Crumb, Philip Garner
 cover S.N. Durkee
 Proofreading Peter Kunz, Pamela Cokeley, Kathleen Whitacre

Printing Warren's Waller Press, San Francisco
 A.L. Lemos Co., San Francisco (bindery)
 Marinstat, Mill Valley (stats and halftones)
 Ron Katsuranis (photo prints)

SOFT TECH production and manufacture costs

New contributors	\$ 1,000
Staff	7,000
Supplies	300
Index	850
Printing 133,000 copies)	27,850
TOTAL	\$37,000
"nit cost (33,000 copies)	\$1.12

By the way, this book is dedicated.

With affection to Marlon Brando
 —SB

'Or Whole Earth'

under the access of an item means you can mail order it from:

Whole Earth Truck Store
 558 Santa Cruz Ave.
 Menlo Park, CA 94025

Anything else — letters, articles, orders for The CoEvolution Quarterly — should be sent to us here at:

The CoEvolution Quarterly
 Box 428
 Sausalito, CA 94965

"DETAILS ARE VULGAR"

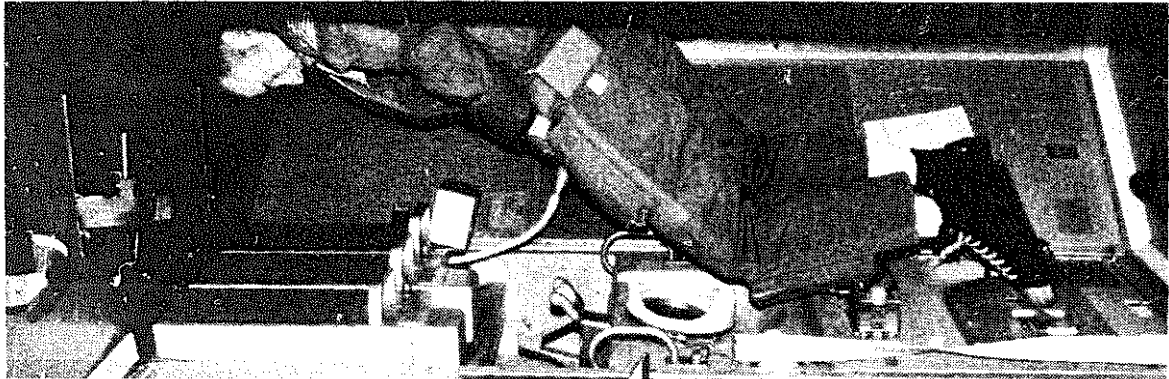

... said Oscar Wilde, and a lot of publications seem to agree. They tell you about moods, feelings, general trends. But they don't tell you the details you want to know.

They don't, for example, tell you how the astronauts use the bathroom in space.

The CoEvolution Quarterly does. It told the details of living in space that everyone wonders about most, in an article called "There Ain't No Graceful Way: Urination and Defecation in Zero G." (One detail: when the astronauts are in their space suits, a few-hours per flight, they wear tight, bermuda short shaped diapers. The whole story is available in the Space Colonies book on the order blank to your right.)

The CQ also tells you about the details of living responsibly on the Earth. Much of the material in this book about exactly how you can build and use soft technology to soften your impact on the environment first appeared in The CoEvolution Quarterly.

The CoEvolution Quarterly is a 144 page, advertising-free mass of details you can think about and use — and you can get it four times for \$12. CQ people know it's hard to understand something, to believe it, or to do it yourself without hearing about the small hassles and small joys that are part of anything real. So past CQ's have given readers:

- *Details on how to do it:* How to buy the best tools and how to use them (p. 8 in this book). How to burn wood responsibly (p. 90). How to build solar collectors, make wine, buy horse gear, store food, make a dirt bicycle, spin your own thread, build your own computer. All by people who have actually done it.

- *Details from people who were there:* Malcolm Wells, who has three feet of dirt on his office roof, on underground architecture (p. 102). John Todd on building the Ark (p. 148). Margaret Mead and Gregory Bateson arguing about how to use cameras in anthropology. Theodora Kroeber, who's 45 years older than her husband, on cross-generational marriage. Orville Schell on what it was like to work in a factory in China.

- *Details on what it really says:* All CQ book reviews have long quotes from the book itself so you can decide for yourself if you're interested. And there are 60-100 book reviews in each CQ.

The CoEvolution Quarterly reports first hand on the complicated, exciting, occasionally vulgar details that make up the real world. If you would like to hear about them, send us \$12 today.

—Anne Herbert
Assistant Editor

The **COEVOLUTION**
Quarterly

BOX 428, SALJSALITO, CA 94965

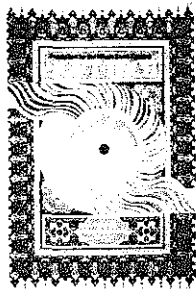

SOFT TECH

The best ideas we know about how to do almost anything worth doing. Tools . . . Building . . . Invention . . . Alternate energy sources . . .

Includes lots of illustrated examples — from people who are out in the field doing it . . . J. Baldwin's pithy "How to" and "Where to" articles . . . Stewart Brand's "Whether to" reviews . . . complete Whole Earth access information . . .

Plus latest dispatches from the New Alchemy Institute . . . the successful Davis, California solar building code . . . Steve Baer's inventive Albuquerque "Zomeworks" woodburning news . . . Malcolm Wells' underground architecture.

176 pages \$5

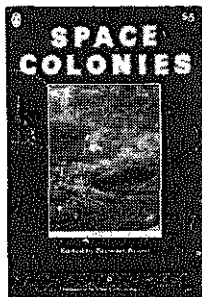

SPACE COLONIES

The best of CoEVOLUTION's popular space issues (Fall '75 and Spring '76, both out of print), and 32 pages of new material: solar sailing and the space Colony research group by Eric Drexler; California Gov. Jerry Brown's state "Space Day"; MIT's working mass driver; new interviews with Astronaut Russell Schweickart and space Colony designer Gerard O'Neill

Includes "There Ain't No Graceful Way" — Schweickart's unvarnished inside account of toilet time outside gravity.

160 pages — \$5

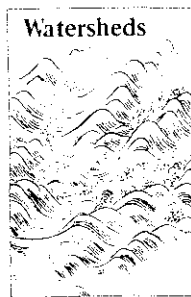

WATERSHEDS

Water — the medium of Earth's life and health: by observing where it comes from, what it does, where it goes, we gain a sense of our own role in the cycle.

Edited by CoEVOLUTION Land Use Editor Peter Warshall, WATERSHEDS includes photo essays, poetry, and interviews . . . new material on the human use of watersheds . . . geomancy, the Chinese "science of wind and water" . . . the whole water-soil cycle . . . and an ideal of 'living in place' which could help heal our soils and waters.

Available July 1978 — \$6

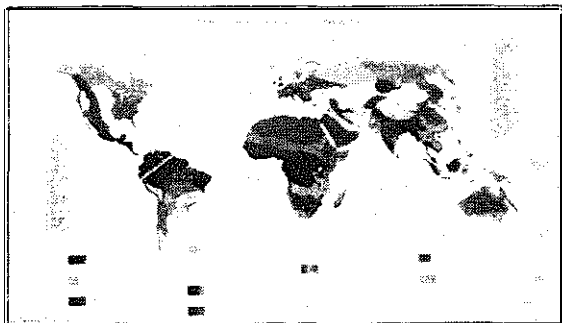

WORLD BIOGEOGRAPHICAL PROVINCES

Revised 1978. The latest data on world plant and animal distribution — displayed here clearly for the first time — shows true natural biotic regions which transcend any 'national' definitions.

A somewhat deeper politics is visible here — and humans commonly err by ignoring it.

Based on the work of international ecologist Raymond Dasmann — and sent with a copy of Dasmann's CQ writings.

22" X 39" — wall size, full color — \$3

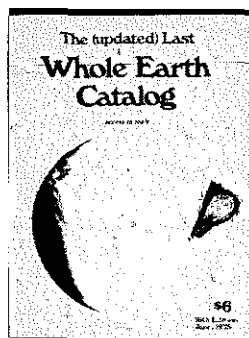

WHOLE EARTH CATALOG

Winner of the 1972 National Book Award: evaluation and access device for books and tools, updated in a., the original Whole Earth categories: Whole systems; community; Shelter; Craft; Nomadics; Communication; Land Use; and Learning.

448 pages — \$8

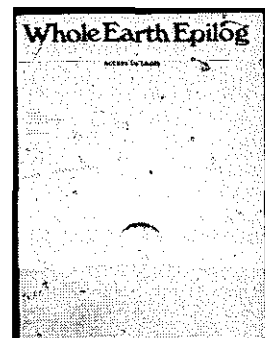

WHOLE EARTH EPILOG

Volume II of the Whole Earth Catalog — beginning with page 449, and containing 320 pages of all new material, cross-referenced and cross-indexed to the Catalog.

320 pages — \$4

Box 428, Sausalito, CA 94965

The **COEVOLUTION**
Quarterly

Box 428, Sausalito, CA 94965

Name _____

Address _____

Zip _____

Prices postpaid — sorry, we don't bill.
Please allow 4-6 weeks for delivery.

- Put me on the Whole Earth mailing list (No purchase at this time).
- One year of CoEVOLUTION (see overleaf) 4 issues — \$12
- Two years of CoEVOLUTION — \$21 (1/3 less than newsstand prices)
- CoEVOLUTION back issues, \$3

- SOFT TECH Book — \$5
- SPACE COLONIES Book — \$5
- WATERSHEDS Book — \$6
- 1978 WORLD BIOGEOGRAPHICAL MAP — \$3
- updated WHOLE EARTH CATALOG — \$8
- WHOLE EARTH EPILOG — \$4

Write for special foreign airmail rates.

\$ _____ Total this order.

(Specify issues — see overleaf)

No. 10, Summer 1976

Oibers' Paradox *Lawrence Ferlinghetti*
Jacques Cousteau at NASA Headquarters
Free Lunch Comix and Stories *Dan O'Neill*
On Observing Natural Systems *Francisco Varela in conversation with Donna Johnson*
Carl Ortwin Sauer 1889-1975 *James J. Parsons*
Theme of Plant and Animal Destruction in Economic History *Carl Sauer*
A Carl Sauer Checklist *Robert Callahan*
Trees *Jean Giono*
The Hoedads *J.D. Smith*
Environmental Impact Reports *Peter Warshall*

The B & G, The Bomb *Steve Baer*
Three Political Ideas *Paul Maag*
Theory of Game-Change *Stewart Brand*
Some Mice *Robert Horvitz*
Get Down Tonight *Deborah Haynes*
Sex Notes *Kay Weiss*
The Space Crone *Ursula Le Guin*
Memory One: Getting Started in Orygun *David Shetzline*
Winning *Ron Jones*
The Education of Jori Mitchell
Its our very effort to make reality repeatable which Buddhism calls suffering *Zentatsu Baker-Roshi*

No. 11, Fall 1976

From Present to Future *Herman Kahn with William Brown and Leon Martel*
The Shift from a Market Economy to a Household Economy *Scott Burns*
Future Primitive *Raymond Dasman*
Biogeographical Provinces *Raymond Dasman*
Controversy Is Rife on Mars *interviewing Carl Sagan and Lynn Margulis*
Odd Bodkins *Dan O'Neill*
Boone *Gurney Norman*
Mind/Body Dualism Conference Position Papers

Community Gardening *Rosemary Menninger*
The Foredads *Gary Rurkun*
Effects of Sublethal Exposure to 2,4,5-Trichlorophenoxy-Acetic Acid *J.R. Felix and Pierre Mortmain Sylvestre*
Underground Architecture *Malcolm Wells*
Cross-Generation Marriage *Theodora Kroeber-Quinn*
Earthshoes & Other Remarks *Ken Kesey*
May 12 *Louise Nussbaum*
A Street Man's Answer to Rape: Humiliate the Raper *Willie "Small Banana" Williams*
Animal Stories *J.D. Smith*

No. 14, Summer 1977

Voluntary Simplicity (3) *Duane Elgin and Arnold Mitchell*
Voluntary Simplicity (1) *Richard Gregg*
SRI Is Wrong About Voluntary Simplicity *Michael Phillips*
The Poverty of Power Reviewed *Kenneth Boulding*
Remarks on Recombinant DNA *James Watson*
There Ain't No Graceful Way *Astronaut Russell Schweickart talking to Peter Warshall*
Mushroom Hunting in Oregon *Andrew Weil*
Time Landscape *Alan Sonfist*
The Transformation of the Tract Home *Richard Nilsen*
Burning Wood *J. Baldwin*
The Ultimate City - Part 1 *J.G. Ballard*
Handspinning *Diana Sloat*

The Price of Marijuana Misinformation *Russell Falch*
Death Does Not Exist *Dr. Elisabeth Kubler-Ross*
Two by Rabindranath Tagore
Three by Anne Herbert
The Death of Ivan Ilych *Leo Tolstoy*
Hospice in America *Lynette Jordan*
Goethe in the Pea Patch *J.D. Smith*
Turkey Drop *Terrence Williams*
Dan O'Neill's Comes and Stories
Left Over in Your Heart *Will Davis*
Computer Hobbyist Publications *Marc Le Brun*
The Poem Is That Voice in Between *Acoma Poet Simon Ortiz talking with Lewis MacAdams*

No. 15, Fall 1977

Solar Water Heaters in California, 1891 - 1930 *Ken Butti and John Perlin*
The Wandervogel *John de Graaf*
The Ideas of Greenwich Village *Malcolm Cowley*
Sanctuary in Cuba *Huey P. Newton*
Havana Province, 1977 *Conn Nugent*
Valuable Deficiencies *John McKnight*
Neighborhood Preservation is an Ecology Issue *Stewart Brand*
Living Lease *Michael Phillips*
Notes for Things to Do in the Future *Donald Burgy*
Space Day Symposium *R. Crumb*
Voluntary Simplicity Followup and Comments: Response to the Voluntary Simplicity Questionnaire
Who Cut Down the Sacred Tree? *Michael W. Foley*

The Hawksbill Turtle *Kevin Stevenson*
Odd Bodkins *Dan O'Neill*
New Crops *Rosemary Menninger Talking with Richard Felger*
Insulation Heresy *Richard Nilsen*
The Ultimate City - Part 2 *J. G. Ballard*
Wilderness Plots *Scott Sanders*
Two Dangling Animal Stories and a Heavy Bear Story *J. D. Smith*
The Custer Wolf *Patrick Holland*
Broken Circuits, Smoke and Fire *Judy Melvoin*
If the Spirits of the Dead Do Walk Among Us, Where Do They Spend Their Summer Vacations?
Robert Goldman
Giraffe's Neck *Terry Lawhead*

No. 16, Winter 1977-78

But First, A Word from Our Guest Editors *Larry Lee and Scoop Nisler*
The Mass Media and the Future of Desire *Gene Youngblood*
The Earth Gods vs. the Sky Gods: Publisats against the Oligoposat *Sol Yurick and Wes Thomas*
Getting into THE ACT *interview with Harry M. Shoosan III and Andrew J. Margeson by Robert Horvitz*
World Television *Mary Jean Haley*
Four Arguments for the Elimination of Television *Jerry Mander*
Hypnotic Age Regression of a Television Addict *Paul Krassner*
Deprogramming the Media Mind or Turn Off, Tune Out and Drop On Over Some Time *Scoop Nisler*
Three Forefathers *Larry Lee and Jay Kinney*
Tesla *Bud Spurgeon*
A Disturbing Communique . . . *Ira Einhorn*
And a Hopeful One *Larry Lee*
From The Third Mind *William S. Burroughs*

The Priest, the Well, and the Pendulum *Jacques Vallee*
The Zapping of America *reviewed by Alvin Duskin*
Flip Points *Jerry Brown meets Marshall McLuhan*
Space Stations *Tom Parker*
The Greens (Les Verts) *Sylvie Crossman*
The Goose and the Gander Were Talking One Night *R. Crumb*
Sunlight Convergence/Solar Burn *Charles Ross*
Ethical Technology *Michael J. Goc*
Buildings as Organisms *Day Chahroudi*
Does Intercourse Cause Cancer? *Josephine Hill, M.P.H.*
Mr. Boney Parts *Dan O'Neill*
A New Wolf *Rodney Sirois talking to Lynn Franklin and Ron Poitras*
Celebrations *photos selected by Minor White and Jonathan Green*
Yellow Diamonds *Malcolm Wells*
Poor Man's Trampoline *K. Massie*
Ah, Firefighting *Randy Black*

No. 17, Spring 1978

A Defence of Sacred Measures *John Mitchell*
Ladle Rat Rotten Hut
Governor Brown at the Mental Hospitals *Orville Schell*
Cog *Dan O'Neill*
Cops Without Guns *Ken Kesey at Governor Brown's Office*
More Yellow Diamonds *Malcolm Wells*
Recombinant DNA, Paul Ehrlich, and Friends of The Earth
Environmental Mutagens/Carcinogens *Bruce N. Ames*
Language, Thought, & Disease *W.C. Ellerbroek, M.D.*
The Nerds *R. Crumb*
Number is Different from Quantity *Gregory Bateson*
Earl Butz versus Wendell Berry
Biological Agriculture in Europe *Gil Friend*
The Coming of Spring 1977 *Robert Horvitz*
Botanic Architecture *Mark Primack*

Solar Water Heaters in Florida 1923-1978 *Ken Butti and John Perlin*
I Was Armand Hammer *J. Baldwin*
Flo and the Sharks *Richard Baldasty*
Stranger than fiction true roach story *Stephen Finn*
Running for Running *Tom Ferguson*
The Mole Earth Joke Book *Mark Mitcham*
How to Use Road Kills *Douglas Elliot*
The Death and Resurrection of Old Blue *Charles Fox*
Clunker Bikes *Richard Nilsen*
On Story Telling *Carol Scott Van Strum*
Little Prigs & Sages *Irving Weiss*
What Do You See Out of the Window You Look Out of Most? *Anne Herbert*
The Hermit Joke Book *Mark Mitcham*

CROSS SECTIONS OF THE CAPE COD ARK

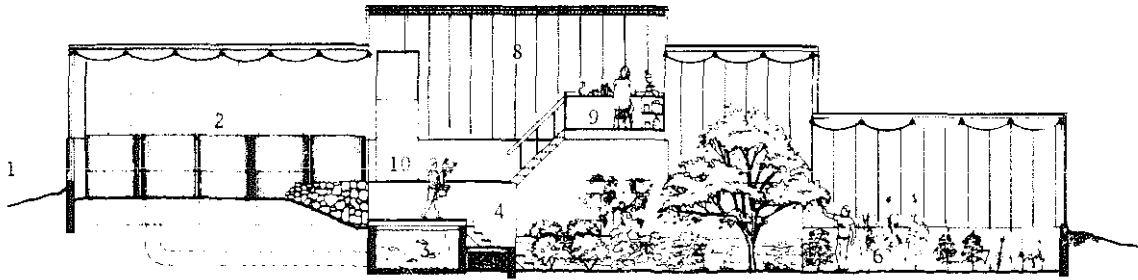

- | | | |
|--|--|---|
| 1 - Courtyards (Not Shown) Housing 33 Solar-Algae Ponds Connected to Interior Aquaculture Facility | 4 - Rock Hot Air Heat Storage | 8 - Insulated North Reflective Interior Surface |
| 2 - Solar Pond Aquaculture Elements - Warm Water Heat Storage | 5 - Experimental Economic Plant Culture Zone | 9 - Research Laboratory Pedestal |
| 3 - Demonstration Pool | 6 - Production Zone | 10 - Fan for Removing Hot Air to Rock Storage |
| | 7 - Food Crop | |

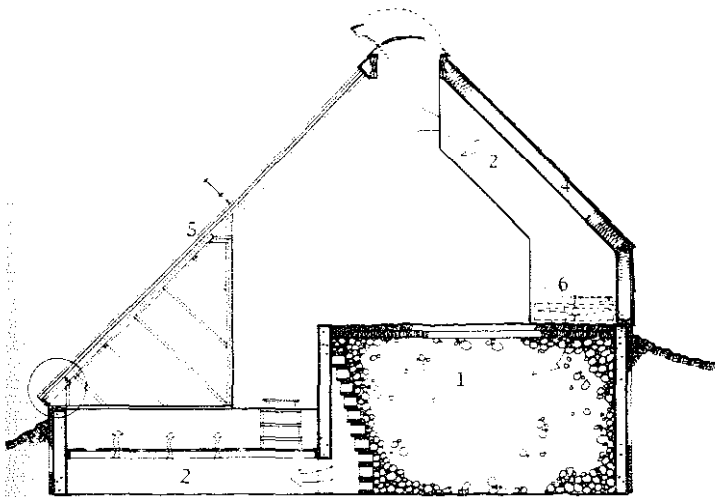

SECTION A A

- 1 - Rock Storage
- 2 - Air Flow
- 3 - Translucent Solar-Algae Pond for Intensive Fish Culture

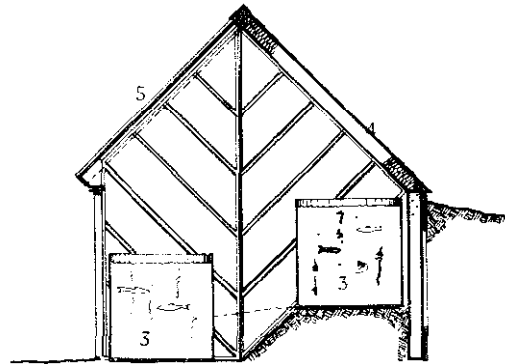

SECTION B B

- 4 - Insulated North Wall
- 5 - Fiberglass (Double Layer) Southern Exposure
- 6 - Fan

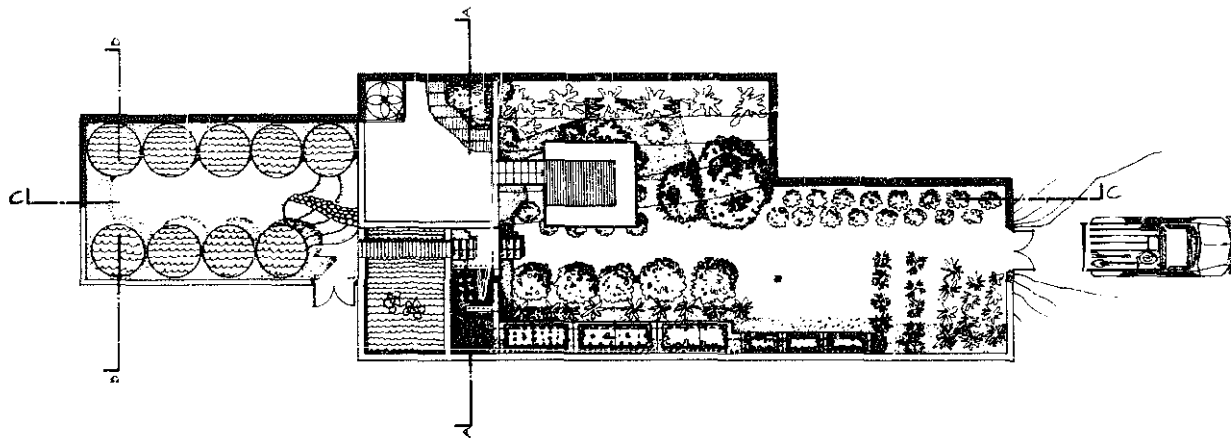



a Penguin Original — TECHNOLOGY/GENERAL

Published by the Whole Earth Catalog

SOFT-TECH

SOFT: Responsive, Pliable, Resilient, Mellow,
Flexible, Yielding, Sensitive, Relaxed, Giving.
TECH: Skill, Craft, Knack, Excellence, Ex-
perience, Versatility, Mastery, Imagination,
Competence, Ingenuity, Artistry, Know-How.