

## Chapter 2 Mobility

### THREAT DEFENSE

The Threat defense may be hasty or deliberate, with emphasis on mine employment. All obstacles are covered by director indirect fires.

#### Hasty Defense

The main obstacle employed is the Threat standard hasty minefield budding block (Figure 2-1).

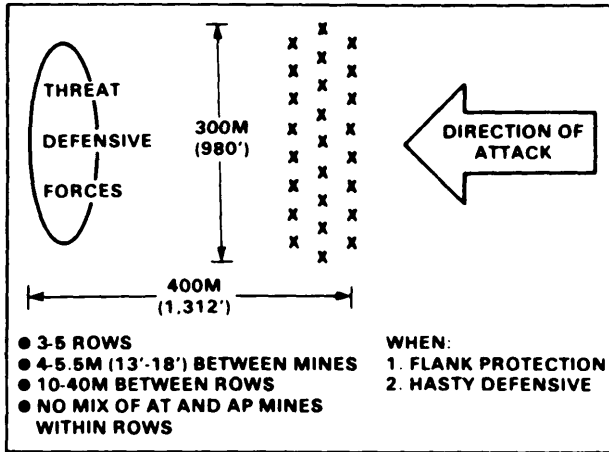

Figure 2-1. Threat hasty minefield

#### Deliberate Defense

The threat defensive obstacle system normally consists of three complex obstacles. Each complex obstacle contains a minefield, normally with three rows 10 to 40 meters apart, and other types of obstacles. Mines within each row are 3 to 5 meters (10 to 16 feet) apart and may be antitank (AT) or antipersonnel (AP). See Figures 2-2 and 2.3 for representative Threat obstacle systems.

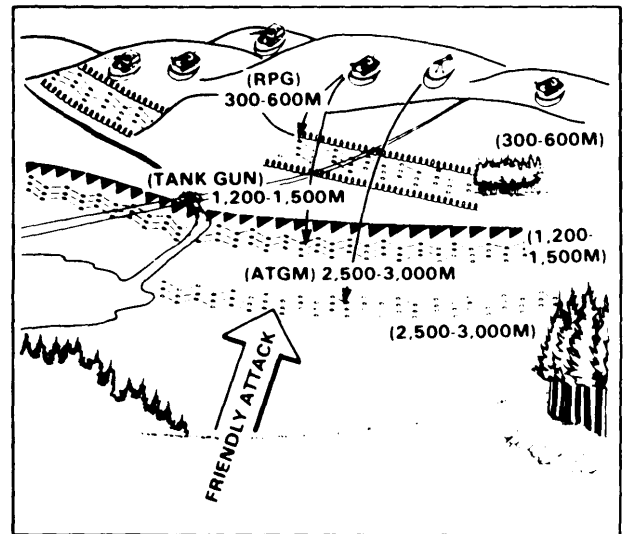

Figure 2-2. Enemy defensive positions and fully developed obstacle system

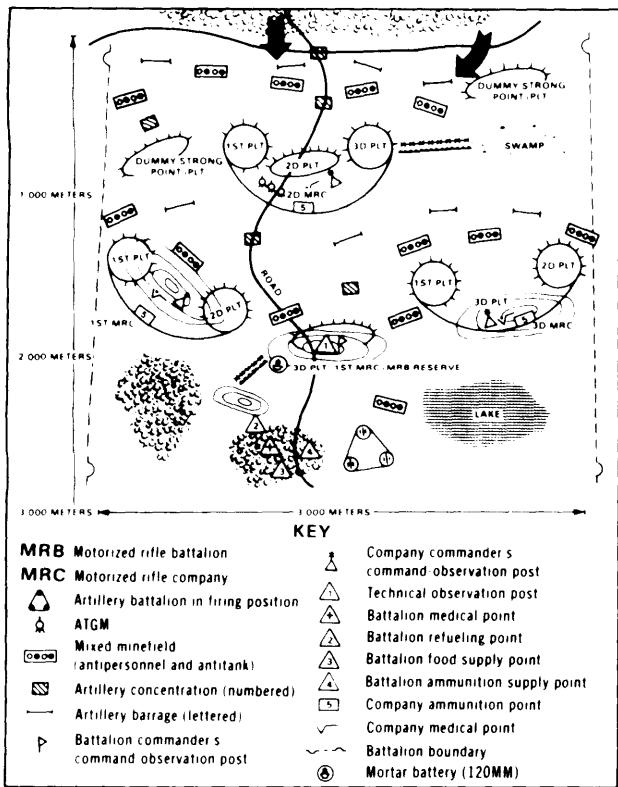

Figure 2-3. Typical motorized rifle battalion strong point

### Major Equipment

Equipment used to prepare the Threat defense is shown in Table 2-1.

Table 2-1. Threat defensive engineer equipment

MINE LAYING EQUIPMENT					
NOMENCLATURE	TYPE	WORKING SPEED KMPH	DISTANCE BETWEEN MINES METERS (FEET)	DEPTH OF MINES CENTIMETERS (INCHES)	ALLOCATION
PMR 2	Dual chute trailer	*	4 - 5.5 (13 - 18)	Surface	—
PMR 3/4	Single chute trailer	*	4 - 5.5 (13 - 18)	30 - 40 (12 - 16)	12 per MRD/TD 3 per MRR/TR
GMZ	Tracked minelayer	5 - 10	4 - 5 (13 - 16)	30 - 40 (12 - 16)	3 per MRD/TD
Mi4 Mi8 HIPC	Helicopter with chutes	—	—	Surface	6 per MRD/TD

\* Speed based on towing vehicle

Table 2-1. Threat defensive engineer equipment (continued)

DITCHING AND DIGGING EQUIPMENT					
NOMEN-CLATURE	TYPE	MAX DEPTH METERS (FEET)	DITCH WIDTH METERS (FEET)	WORKING SPEED (METERS/HOUR)	ALLOCATION
BTM/BTM 3	Track	1.5 (5)	.6 - 1.1 (2 - 3.5)	265 - 1120	6 per MRD 2 per TD 1 per MRR
MDK-2M	Track	4.4 (14.5)	3.4 - 4 (11 - 13)	Up to 400	2 per MRD 6 per TD 1 per TR
PZM/PZM2	Trench excavator	1.5 (5)	.8 (2.5)	300M <sup>3</sup> /HR	3 per MRR/TR
IMR	Engineer tractor	Variable	3.8 (12.5)	—	2 per MRD/TD
BAT/M	Track dozer	Used mainly for preparation of defensive position		350M <sup>3</sup> /HR	11 per MRD/TD

## COUNTERMINE

### Detection Methods

Conduct an analysis by reviewing the terrain enemy capabilities and past performances.

#### Visual

Check for ground disturbances, posted signs, tripwires, odd features on ground, and signs of road repairs.

#### Physical (probing)

Fasten and secure all equipment to the body, use nonmetallic probe, stay close to ground and use probe gently in 1 meter semicircle search and at a 45° angle with the ground.

### Electronic mine detector

Rotate operators at least every 20 minutes.

## Enemy Minefield Report

Table 2-2. Report of enemy minefield

ALFA	Map sheet designation
BRAVO	Date and time of collection of information
CHARLIE	Type of minefield
DELTA	Coordinates of minefield extremities
ECHO	Depth of minefield.
FOXTROT	Enemy weapons or surveillance
GOLF	Estimated time to breach minefield
HOTEL	Estimated material and equipment needed to breach minefield
INDIA	Routes for bypassing minefield
JULIET	Coordinates of lane entry
KILO	Coordinates of lane exit
LIMA	Width of lanes, in meters
ZULU	Other Types of mines, new mines, booby traps

**Breaching and Clearing Operations**  
Table 2. 3. Breaching methods

NOMENCLATURE	TYPE	MINES CLEARED	WEIGHT (LB)	LANE CLEARED		ASSEMBLY TIME	EMPLOYMENT TIME IN MINUTES (SPEED)
				WIDTH METERS (FEET)	LENGTH METERS (FEET)		
				REMARKS			
M583 (MCLIC) (Note 3)	trailer mounted	AT AP	3 100	8 (26)	100 (328)	crane and crew 35 min	4 (25 MPH)
M173 (projected charge demo kit) (Note 3)	towed	AT AP	3 000	8 (26)	70 (230)	crane and 2 soldiers 30 min	10 (15 MPH)
M157 (Diamond tilt)	pushed by tank	AT AP	11 000	8 (26)	100 (328)	2 squads 1 hour	20 (8 MPH)
M1E projected charge kit	portable	AP	63	6 (2)	50 (170)	2 soldiers 10 min	10
M1A1 (bangalore)	portable	AP	130 kit	6 (2)	15 (50)	1 squad 5 min	5
<b>MECHANICAL</b>							
NOMENCLATURE	TYPE	MINES CLEARED	WIDTH METERS (FEET)	WEIGHT (LB)	PREPARATION TIME	EMPLOYMENT TIME IN MINUTES (SPEED)	
Roller	tank mounted	AT/AP	2 @ 11 (36)	20 000	crane and crew 45 min	4 (5 MPH)	
Plow	tank mounted (Note 1)	AT/AP	2 @ 18 (6)	12 000	crane and crew 45 min	4 (3 MPH)	
<b>MANUAL</b>							
	LANE CLEARED WIDTH METERS	MAN-HOURS REQUIRED PER 100 METERS	REMARKS				
Location by probing	1 (footpath)	16 - 22	(Note 2)				
Removal by rope or explosives	1 (footpath)	38 - 44	(Note 2)				
Location by detector assisted by probing	8 (one way vehicle lane)	27 - 33	(Note 2)				
Removal by rope or explosives	8 (one way vehicle lane)	220 - 247	(Note 2)				
<p>NOTES 1. Plows issued to M1 units should be mounted prior to combat and remain permanently attached</p> <p>2. Based upon average conditions of visibility and moderate enemy activity and normal US countermeasures, such as screening of enemy observation and counterbattery fires against hostile artillery or other weapons covering the field</p> <p>3. Breaching vehicles should place one track/wheel in the line charge crater to ensure straddling the skip zone</p>							

### Manual breaching and clearing

Use grappling hooks to clear booby traps prior to starting operation and thereafter as needed. Figure 2-4 and Table 2-4 show team composition and equipment for a breaching/clearing operation.

Table 2-4. Sweep team equipment

PERSONNEL	*KEY	EQUIPMENT
Mine Detector Operator	1	Mine detector
Marker/Prober	2	Probe, mine markers, marking tape, or wire reel
NCOIC	3	Map and compass
Demolition Team	4	Safety pins, clips, smooth wires (18" long), 1-pound blocks of explosive, two nonelectric blasting caps, detonating cord, time fuze, two fuze igniters, and crimpers
Radio Operator	6	Radio
Relief Mine Detector Operator	7	Mine detector operator gear and weapon
Security	8	Weapon

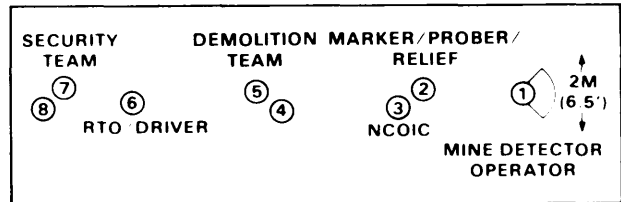

Figure 2-4. Sweep team composition

### Lanes and minefields clearing

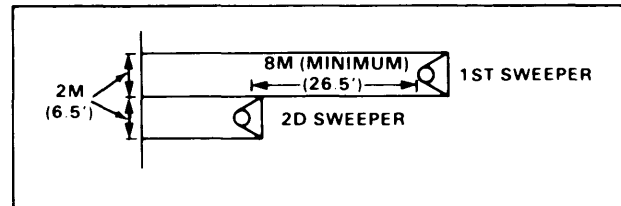

Figure 2-5. Breach lane clearance

### Route sweep

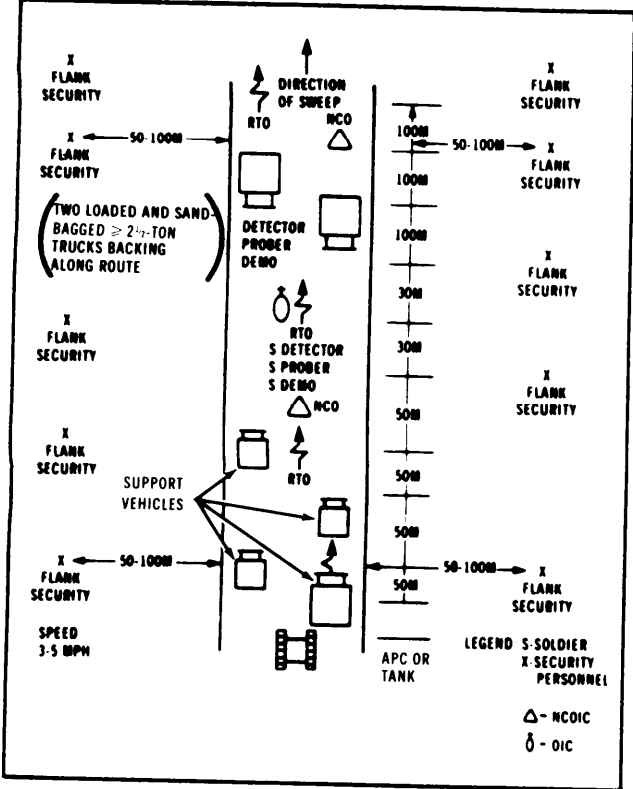

Figure 2-6. Route sweep formation

### Foreign Mines

UNLESS DIRECTED DIFFERENTLY, ALL FOREIGN MINES WILL BE DESTROYED IN PLACE RATHER THAN REMOVED/DISARMED.

Table 2-5. Foreign antitank mines





MINE	DESCRIPTION	SKETCH
<b>SOVIET UNION</b>		
TM 60	Plastic Total Wt: 11.4 kg Wt of explosive: 9.9 kg Fuze: Two available a. nonmetallic chemical b. mechanical pressure	Diameter 300MM 
TMS-B TMB1 TMB2	Tar impregnated cardboard, glass plug over fuze well Total Wt: 6.9 kg Wt of explosive: 5.0 kg Fuze: MV-5K	Diameter 275MM 
TM46 and TM46 TM41	Metal Total Wt: 8.7 kg Wt of explosive: 5.7 kg Fuze: MVM	Diameter 300MM 
TM57	Material (Metal) Total Wt: 9-12 kg Fuze: Pressure or tilt rod or pneumatic	Diameter 310MM 
LMG	Rocket Total Wt: 10 kg Wt of explosive: 3.2 kg Fuze: Pull (MUV)	

Table 2-5. Foreign antitank mines (continued)







MINE	DESCRIPTION	SOVIET UNION (continued)	SKETCH
MZD Series	Wood, field fabricated Total Wt: Variable Wt of explosive: 4-4.0 kg Fuze: Vibration, electric		
TMD B TMD44	Wood Total Wt: 7.7-10 kg Wt of explosive: 5-6.8 kg Fuze: Pressure (MV-5)		
YAM 5/10 TMD41	Wood Total Wt: 7.7 kg Wt of explosive: 5.8 kg Fuze: Pull (MUV)		
TMK2	Metal Total Wt: 12.5 kg Fuze: Tilt Rod (adjustable)		
<b>CZECHOSLOVAKIA</b>			
PT Mi Ba PT Mi Ba 53	Plastic Total Wt: 7.6 kg Wt of explosive: 5.6 kg Fuze: Pressure	Diameter 320MM	
PT Mi Ba II/III	Plastic Total Wt: 9.9 kg Wt of explosive: 6 kg Fuze: Pressure		
PT Mi K	Metal Total Wt: 7.1 kg Wt of explosive: 5 kg Fuze: Pressure		

Table 2-5. Foreign antitank mines (continued)







MINE	DESCRIPTION	CZECHOSLOVAKIA (continued)	SKETCH
PT Mi D/II/III	Wood Total Wt: 9 kg + Wt of Explosive: 6.2 kg		
<b>EAST GERMANY</b>			
PM 60	Similar to TM60 (Soviet)		
K1	Plastic Total Wt: 11 kg Wt of explosive: 7 kg Fuze: Pressure		
<b>HUNGARY</b>			
Shape Charge Mine	Cardboard and plywood Total Wt: 5.4 kg Fuze: Pressure		
<b>DENMARK</b>			
M/47-1	Metal Total Wt: 10 kg Wt of explosive: 6.3 kg Fuze: Pressure or anti-disturbance		
M/52	Plastic Total Wt: 10.7 kg Wt of explosive: 8.3 kg Fuze: Pressure-chemical		

Table 2-5. Foreign antitank mines (continued)





MINE	DESCRIPTION	SKETCH
<b>FRANCE</b>		
Model 1951 Nonmetallic	Has no case, cast TNT Total Wt: 7 kg Fuze: Pressure chemical 1950 or pressure friction 1952	Diameter 300MM 
Model 1947 Nonmetallic	Bakelite case Total Wt: 11 kg Fuze: Pressure chemical 1950 or pressure friction 1952	Diameter 330MM 
Model 1948	Metal Total Wt: 9 kg Fuze: Main and two secondary fuze wells	Diameter 310MM 
<b>ITALY</b>		
CS 42/2 CS 42/3	Wood Total Wt: 6.9 kg Wt of explosive: 5 kg Fuze: Pressure	
SH-55	Plastic Total Wt: 7.3 kg Fuze: Integral pneumatic pressure Diameter 265MM	
"Saci" 54/7	Plastic case but metal striker detectable Total Wt: Two models a. light — 6.2 kg b. heavy — 10.2 kg Fuze: Three pressure	Diameter 265MM 

Table 2-5. Foreign antitank mines (continued)





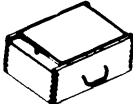

MINE	DESCRIPTION	SKETCH
<b>JAPAN</b>		
Type 63	Nonmetallic Total Wt: 35 lb (15 kg) Wt of explosive: 24.2 lb (11 kg)	
<b>NETHERLANDS</b>		
MIRJAM River Mine	Employs normal antitank mine, such as Model 26 (Serial 6) Total Wt: 18 kg Length 605MM	
Model 26 Undetectable	Plastic reinforced with glass wool. Total Wt: 9 kg Fuze: Pressure-friction with shear collar control. Two secondary fuze wells for anti- lift devices	Diameter 300MM 
Model 25	Metal Total Wt: 12.8 kg Fuze: Pressure with two secondary fuze wells for anti- handling devices	Diameter 309MM 
T40	Metal Total Wt: 6 kg Fuze: Pressure	Diameter 280MM 
<b>SPAIN</b>		
C. E. T. M. E.	Nonmetallic Total Wt: 9.9 kg Wt of explosive: 5.2 kg Fuze: Chemical or mechanical	



Table 2-5. Foreign antitank mines (continued)

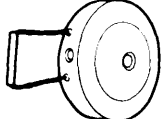





MINE	DESCRIPTION	SKETCH
<b>SWEDEN</b>		
Model 52	Wood and fabrics Total Wt: 8.9 kg Wt of explosive: 7.4 kg Fuze: Pressure	
M1 101	Nonmetallic Total Wt: 12.4 kg Wt of explosive: 11 kg Fuze: No data	
Model 41-47 and 47	Metallic Wt of explosive: 5 kg Fuze: Pressure	
<b>UNITED KINGDOM</b>		
L9A1	Nonmetallic Total Wt: 11 kg	Length 1.2M 
MK7	Metallic Total Wt: 14.7 kg Wt of explosive: 8.8 kg Fuze: Pressure	Diameter 330MM 
L3A1	Plastic w/removable detector ring Total Wt: 7.7 kg	Diameter 266MM 
L14A1	Off-road Total Wt: 13 kg Max Range: 80m Fuze: Actuated by break wire across kill zone	Height 330MM Length 260MM 

Table 2-5. Foreign antitank mines (continued)

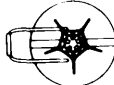

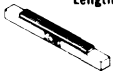
MINE	DESCRIPTION	SKETCH
<b>WEST GERMANY</b>		
DM 11	Plastic Total Wt: 7.4 kg Wt of explosive: 7 kg Fuze: DM 46 pressure	Diameter 300MM 
DM 39	Plastic Total Wt: 0.50 kg Wt of explosive: 0.31 kg Fuze: Antilift device with pressure release fuze	Diameter 118MM 
DM 49	Plastic Total Wt: 0.50 kg Wt of explosive: 0.20 kg Fuze: Antilift device with pressure release fuze	90MM 

Table 2-6. Foreign antipersonnel mines



MINE	DESCRIPTION	SKETCH
<b>SOVIET UNION</b>		
POM 2-2M	Cast iron case Total Wt: 1.7 kg Wt of explosive: 0.75 kg Fuze: MUV-2	Diameter 60MM 
OZM-3 OZM-4	Steel Total Wt: 4.54 kg Wt of explosive: 0.75 kg Fuze: MUV or MUV-2	Diameter 77MM 

Table 2-6. Foreign antipersonnel mines (continued)





MINE	DESCRIPTION	SOVIET UNION (continued)	SKETCH
MON 100 and MON 200	Metal Total Wt: MON 100 5 kg MON 200 25 kg Wt of explosive: MON 100 2 kg MON 200 12 kg Fuze: Electric command or tripwire	Diameter: MON 100 220MM MON 200 520MM	
PMN	Phenolic body with rubber cover Total Wt: 0.60 kg Wt of explosive: 0.216 kg Fuze: Integral with mine	Diameter 100MM	
PMD6 PMD7	Wood Total Wt: 398 gm Wt of explosive: 200 gm Fuze: Pull (MUV)		
<b>CZECHOSLOVAKIA</b>			
PP Mi S6	Concrete case Total Wt: 2.1 kg Wt of explosive: 0.075 kg Fuze: RO1 pull or RO8 pressure	Diameter 75MM	
PP Mi Sr	Steel Total Wt: 3.25 kg Wt of explosive: 0.325 kg Fuze: RO1 pull or RO8 pressure	Diameter 100MM	

Table 2-6. Foreign antipersonnel mines (continued)



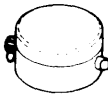

MINE	DESCRIPTION	CZECHOSLOVAKIA (continued)	SKETCH
PP Mi ST-46	Cast iron case		
<b>HUNGARY</b>			
Ramp Mine	Metal Total Wt: 1.4 kg Wt of explosive: .8 kg Fuze: Pull		
M62	Plastic Total Wt: 386 gm Wt of explosive: 74 gm Fuze: Pull (MUV)		
Bounding	Metal case Total Wt: 3.6 kg Wt of explosive: .8 kg Fuze: Pull		
<b>EAST GERMANY</b>			
K-2	Plastic w/metal Total Wt: 4 kg Wt of explosive: 3 kg Fuze: Pressure		
<b>FRANCE</b>			
Model 1948	Nonmetallic Total Wt: .56 kg Wt of explosive: 170 gm		

Table 2-6. Foreign antipersonnel mines (continued)





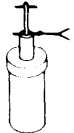

MINE	DESCRIPTION FRANCE (continued)	SKETCH
Model 1951 Nonmetallic	Plastic Total Wt: 0.85 kg Fuze: Integral pressure friction Diameter 70MM	
Model 1951/ 55 Bounding	Metal Total Wt: 4.5 kg Fuze: Model 1952 tilt rod Diameter 110MM	
DV 56 Nonmetallic Model 1956	Plastic Total Wt: 0.16 kg Fuze: Friction pressure Diameter 70MM	
ITALY		
Minelba Type A	Metal Total Wt: 0.17 kg Fuze: Integral pneumatic Diameter 110MM	
Minelba Type B	Similar in outer appearance to Type A but is made of plastic and has no safety pin hole, and no safety device Diameter 110MM	
AUS 50/5	Plastic Total Wt: 1.4 kg Fuze: Pressure/pull Diameter 125MM	
Type R	Wood Total Wt: .5 kg Fuze: Pressure/pull	

Table 2-6. Foreign antipersonnel mines (continued)







MINE	DESCRIPTION ITALY (continued)	SKETCH
Valmara	Metallic Total Wt: 3.2 kg Wt of explosive: .54 kg Fuze: Pressure/pull	
NETHERLANDS		
Model 22 Nonmetallic	Plastic Total Wt: 0.85 kg Fuze: Integral pressure friction with shear collar control	Diameter 71MM 
Model 15	Plastic Total Wt: 0.6 kg Fuze: Pressure igniter Length 114MM Width 100MM	
SPAIN		
FAMD	Plastic Total Wt: 97 gm Wt of explosive: 48 gm Fuze: Pressure	
SWEDEN		
M49 M49B	Cardboard Total Wt: .23 kg Fuze: Pressure	
M48	Fragmentation Total Wt: 2.9 kg Wt of explosive: .23 kg Fuze: Pull	

Table 2-6. Foreign antipersonnel mines (continued)







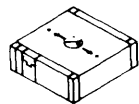

MINE	DESCRIPTION	SKETCH
<b>SWEDEN (continued)</b>		
Model 43 Model 43(T)	Concrete Total Wt: 5.8 kg Wt of explosive: .6 kg Fuze: Pull	
M/43 T	Cardboard Total Wt: .23 kg Wt of explosive: .14 kg Fuze: Pressure	
M41	Wood Total Wt: 0.35 kg Wt of explosive: 0.12 kg Fuze: Pressure pin withdrawal	
<b>SWITZERLAND</b>		
M3	Nonmetallic Total Wt: 93 gm Wt of explosive: 68 gm	
P59	Plastic Wt of explosive: 60 gm Fuze: None	

Table 2-6. Foreign antipersonnel mines (continued)

MINE	DESCRIPTION	SKETCH
<b>UNITED KINGDOM</b>		
Mine Antipersonnel No. 6 (i)	Plastic mine with metal detector ring	Length 203MM 
Mine Antipersonnel No. 7 (Dingbat)	Small metal mine, actuated by a load of 3.20 kg Total Wt: 0.11 kg	Diameter 63MM 
Mine Antipersonnel Nonmetallic C3 (Elsie)	Small plastic mine with removable detector ring Total Wt: 0.08 kg	Length 76MM 
<b>WEST GERMANY</b>		
DM 11	Plastic Total Wt: 200 gm Wt of explosive: 114 gm	Diameter 80MM 
DM 31	Steel Total Wt: 4 kg Wt of explosive: 0.53 kg Fuze: DM56	Diameter 102MM 

## OBSTACLE BREACHING

### Obstacle Report

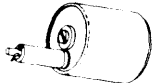
<b>ALFA</b>	Map sheet(s)
<b>BRAVO</b>	Date-time group of observation
<b>CHARLIE</b>	Location (grid reference).
<b>DELTA</b>	Type of obstacle
<b>ECHO</b>	Enemy weapons having coverage on the obstacle, if any
<b>FOXTROT</b>	Any other information which could impact on breaching or bypass, for example, terrain restricts bypass, work required (in personnel-hours) to breach obstacle

Figure 2-7. Obstacle report

### Obstacle Crossing Capabilities

See Table 2- 7 for selected US and foreign equipment obstacle crossing capabilities.

Table 2-7. Equipment obstacle crossing capabilities

COUNTRY/ VEHICLE	MIL CLASS	FORDING METERS (FEET)	HEIGHT	WIDTH	MAX	GROUND CLEARANCE METERS (INCHES)	MAX STEP METERS (INCHES)	MAX TILT (%)	MAX GRADIENT (%)	MAX STRATTLE METERS (FEET)
			TO CLEAR METERS (FEET)	TO CLEAR METERS (FEET)	GAP TRAVERSE METERS (FEET)					
US/M728 (CEV)	57	1 22 (4 0)	3 19 (10 5)	3 59 (11 8)	2 54 (8 3)	41 (16)	.75 (30)	30	60	2 21 (7 3)
US/M113	13	Unlimited	2 13 (7 0)	2 68 (8 8)	1 60 (5 2)	29 (11)	64 (25)	30	60	1 78 (5 8)
US/M 2 & M 3	24	Unlimited	2 92 (9 6)	3 04 (10 0)	2 54 (8 3)	45 (18)	91 (36)	40	60	1 87 (6 1)
US/M60	54	1 22 (4 0)	3 26 (10 7)	3 63 (12 0)	2 66 (8 7)	41 (16)	91 (36)	30	60	2 21 (7 3)
US/M48A5	53	1 22 (4 0)	3 12 (10 2)	3 63 (12 0)	2 59 (8 5)	41 (16)	91 (36)	30	60	2 21 (7 3)
US/M1	60	1 22 (4 0)	2 89 (9 5)	3 60 (11 8)	2 74 (9 0)	48 (19)	1 24 (49)	40	60	2 14 (7 0)
FRG/LEOPARD2	46	2 25 (7 4)	2 93 (9 6)	3 71 (12 2)	3 00 (10 0)	48 (19)	1 15 (45)	30	60	2 15 (7 1)
UK/Centurian	60	1 20 (3 9)	2 96 (9 7)	3 40 (11 2)	3 35 (11 0)	51 (20)	90 (35)	30	60	2 19 (7 2)
UK/Chieftian	45	1 07 (3 5)	2 90 (9 5)	3 66 (12 0)	3 15 (10 3)	51 (20)	91 (36)	30	60	2 44 (8 0)
FR/AMX30	38	2 00 (6 6)	2 86 (9 4)	3 10 (10 2)	2 90 (9 5)	45 (18)	93 (37)	30	60	1 96 (6 4)

## Nonexplosive Obstacle Breaching Equipment

Table 2-8. Nonexplosive obstacle breaching equipment

NONENCLATURE	LOAD CLASS	HEIGHT METERS (FEET)	WIDTH METERS (FEET)	SPEED KMPH (MPH)	ARMAMENT	MOBILITY EMPLOYMENT
M278 (CV)	57	3.25 (10.7)	3.7 (12)	48 (30)	165MM M85-50 (call M240 -7.62M)	Destroy bunkers and log obstacles Breach tank ditch and craters Remove road blocks trees and rubbles
M9 (ACE)	18	2.3 (7.5)	3.2 (10.5)	48 (30+)	None	Fill craters and ditches Remove road blocks trees and rubbles Prepare river and ford access Prepare and maintain routes
D7E (Dozer)	28	2.4 (7.9)	3.48 (11.4)	10 (6)	None	Cut tactical routes Fill craters and ditches Remove rubbles and trees
Loader (2 )	20	3.7 (12)	2.6 (8.5)	—	None	Fill craters and ditches Wire obstacle removal
AV18 w/ bridge w/o bridge	57 37	5 (16.4)	4 (13.1)	48 (30)	None	Bridge gaps 18 meters or less Bridge gaps 15 meters or less for Class 70

### Breaching Procedures

See Table 2.9 and Figures 2.8 through 2.12 (pages 2.16 and 2.17) for obstacle breaching procedures

Table 2.9 Obstacle breaching

LEGEND	OBSTACLE ENCOUNTERED										
	MINEFIELD — 4M LANE		WIRE	AT DITCH/ROAD CRATER	STEEL OBSTRUCTION	CONCRETE OBSTRUCTION	WALLS	ABATIS	LOG OBSTRUCTION	BUNKER	RUBBLE
	SURFACE	BURIED									
DESIRABILITY OF EMPLOYMENT											
SCALE: 1 = Most desirable 10 = Least desirable											
RESOURCES AVAILABLE											
Grapnel Hook	8	7	7					5	5		
Pioneer Kit			8	6				6	6		
Chain Saw								4	4		
Probe	.	.									
Mine Detector/Probe	.	.									
Blade (Dozer, CEV, ACE)				1	2	3		2	2		1
CEV 165MM	5			4	1	2	3	1	1	1	1
AV18					2		3				
Roller	4	4									
Mine (Plow) Blade				3	3						
Bangalore	3	3			6						
Explosives	7	6	9	5	1	2	2	3	3	3	2
M173	2	2	2								
M157	6	5	5								
MICLIC	1	1	1								
Direct Fire										2	
Soft Material			10								
Pipe				3							
Lumber				4			4				

\*Probe and/or mine detector/probe combination are used in conjunction with the grapnel hook for explosive minefield breaching.

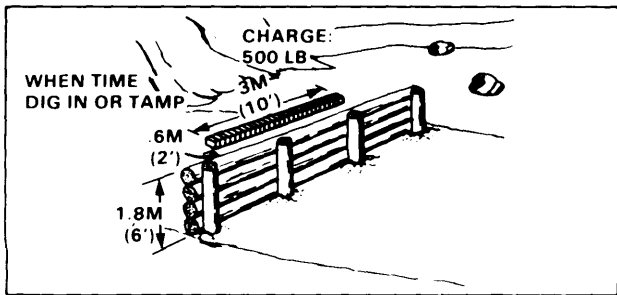

Figure 2-8. Backfilled log wall breaching

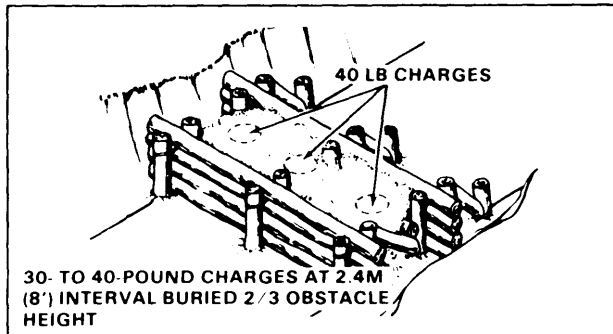

Figure 2-9. Log crib breaching

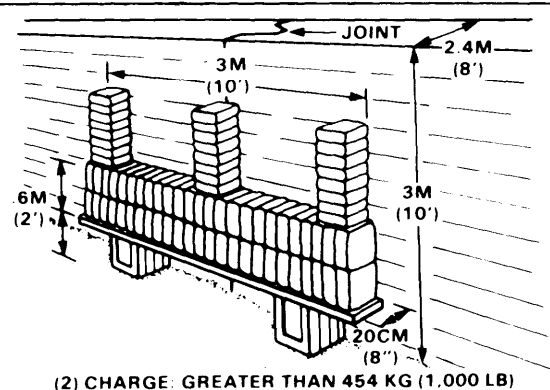
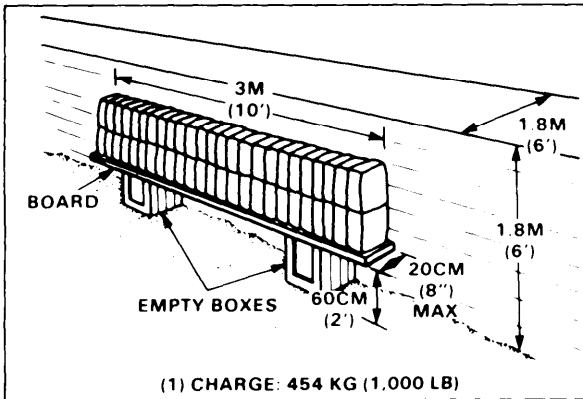

Figure 2-10. Placement of charges for a wall 6-feet thick (1)  
and for a wall over 6-feet thick (2)



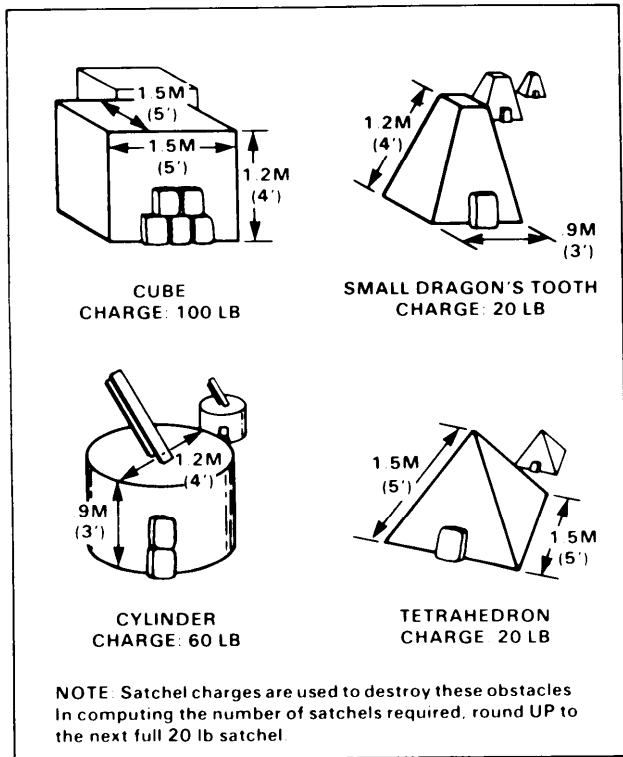

Figure 2-11. Explosive packs needed to destroy typical small concrete obstacles

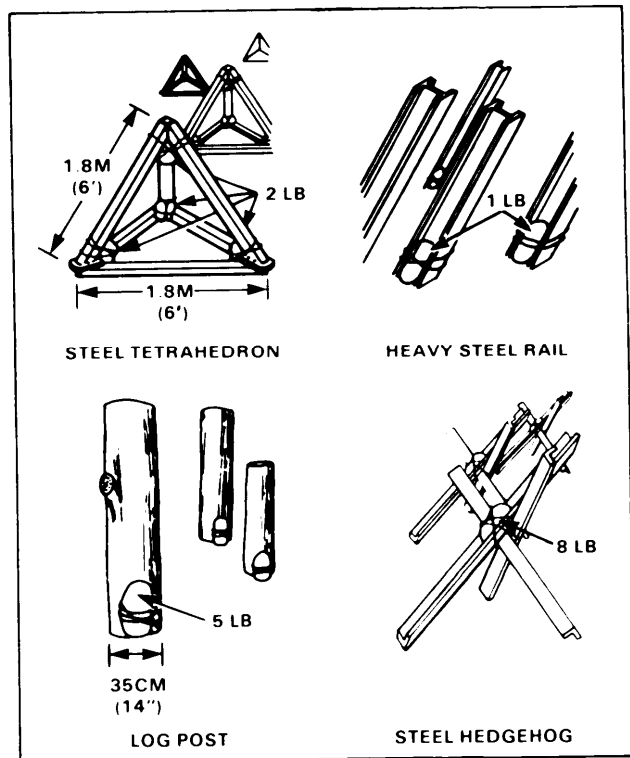

Figure 2-12. Placement of charges for destruction of steel and log obstacles

## COMBAT ROADS AND TRAILS

Typical Combat Roads and Trails Process and Characteristics  
See Figures 2-13 and 2-14.

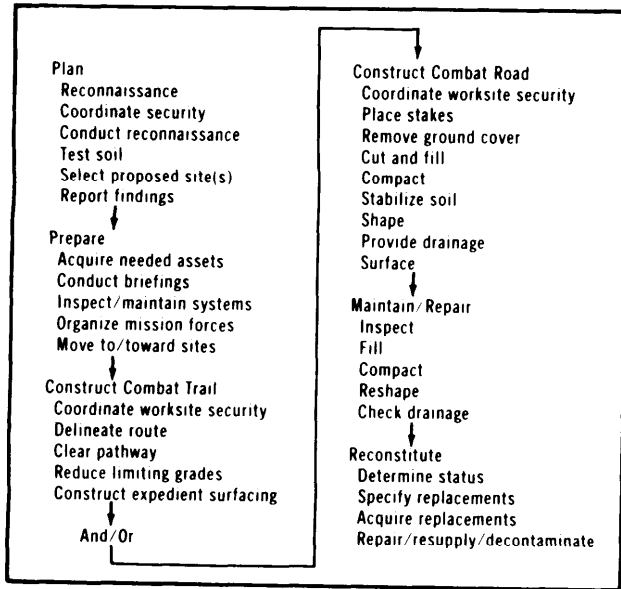

Figure 2-13. Combat roads and trails process

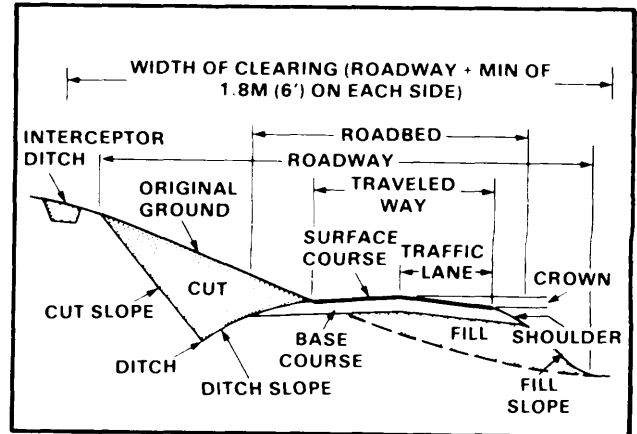

Figure 2-14. Typical cross-section illustrating road nomenclature

### Expedient Surfaces Over Mud

#### Chespalping mats

Chespalping mats are made by placing small saplings 6½ feet long and about 1½ inches in diameter side by side (Figure 2-15). Wire the saplings together with chicken wire mesh or strands of heavy smooth wire. A chespalping road is constructed by laying mats lengthwise with a 1-foot side overlap at the junction of the mats. The resulting surface is 12 feet wide. Unless mats are laid on wet ground, this type of road requires periodic wetting down to retain its springiness and to prevent splitting. Chespalping mats also require extensive maintenance.

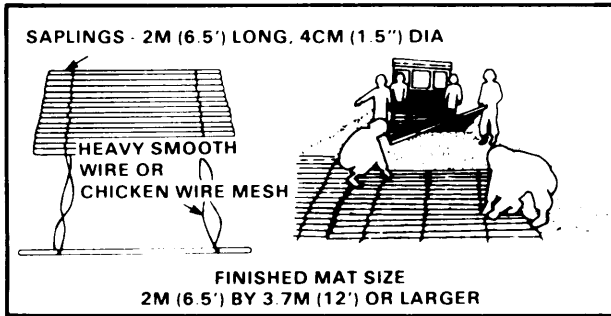

Figure 2-15. Chespaling surface road construction

### Corduroy

See Figures 2-16 and 2-17 (page 2-20).

- Standard corduroy. Logs 15 to 20 centimeters (6 to 8 inches) in diameter and about 4 meters (13 feet) long are placed adjacent to each other (butt to tip). Curbs are made by placing 6-inch-diameter logs along the edges of the roadway (draft-pinned in place). Pickets about 4 feet long are driven into the ground at regular intervals along the outside edge of the road to hold the road in place. To give this surface greater smoothness, the chinks between logs should be filled with brush, rubble, and twigs; then the whole surface is covered with a layer of gravel or dirt.
- Corduroy with stringer. The corduroy decking is securely pinned to stringers and then the surface is prepared as standard corduroy.
- Heavy corduroy. Heavy corduroy involves the use of sleepers, heavy logs 25 to 30 centimeters (10 to 12 inches) in diameter and long enough to cover the entire road, placed at right angles to the centerline on 1.2 meter (4-foot) centers.
- Fascine corduroy. Use fascine instead of logs for stringers.

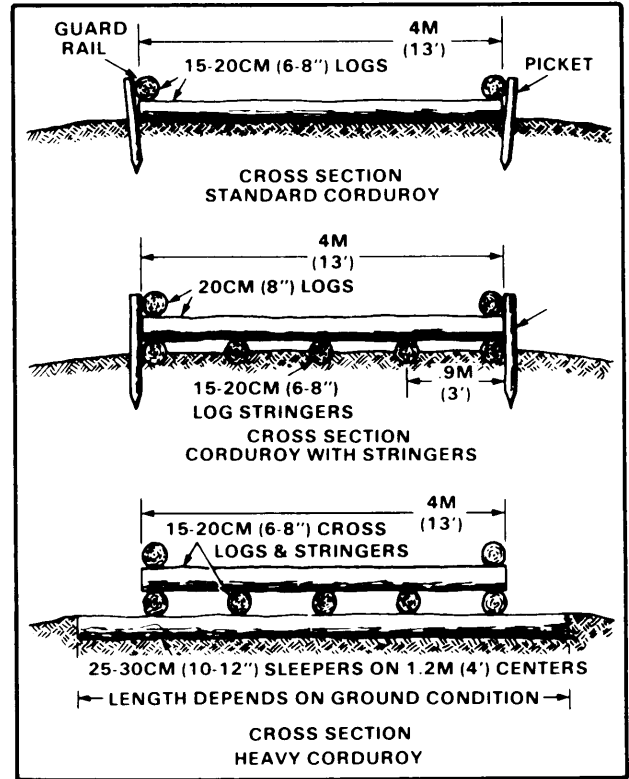

Figure 2-16. Corduroy road surfaces

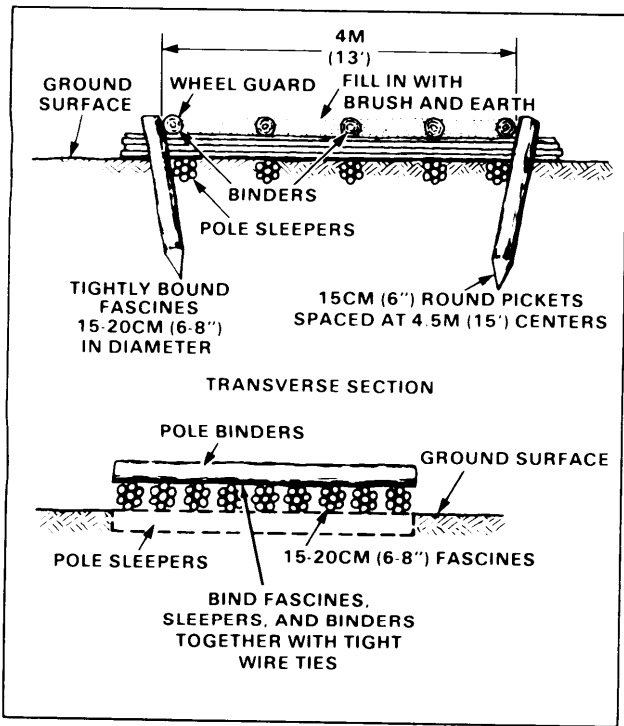

Figure 2-17. Fascine corduroy

### Tread roads

Tread roads are made by preparing two narrow parallel treadways of select material using anything from palm leaves to 4-inch planks. The most common tread road is the plank tread road (Figure 2-18).

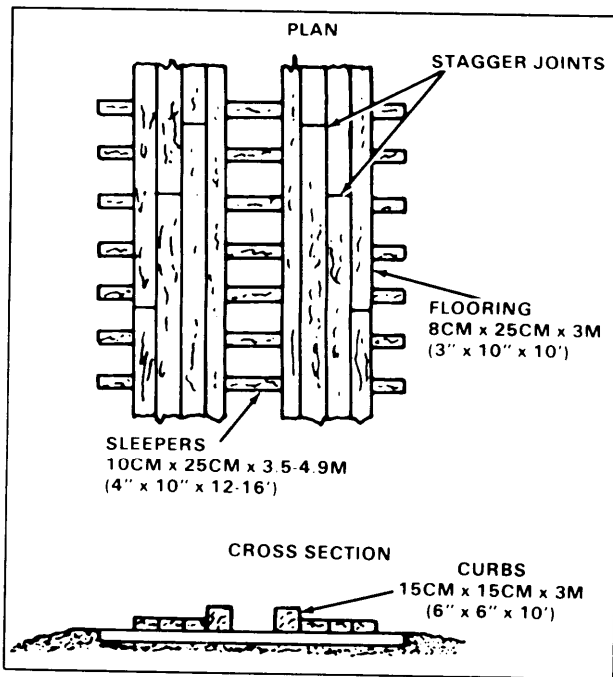

Figure 2-18. Plank tread road

**Army and Sommerfeld tracks**

See Figures 2-19 and 2-20 for details.

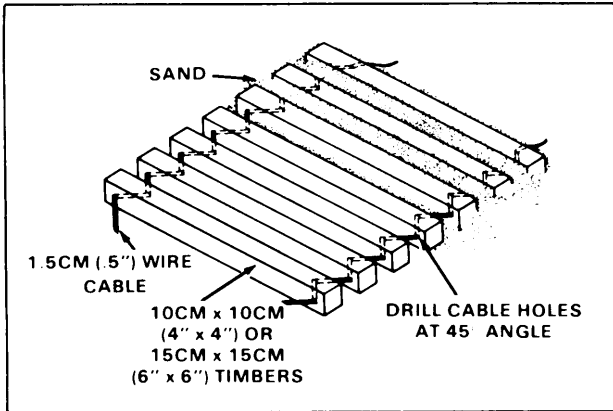

Figure 2-19. Army track

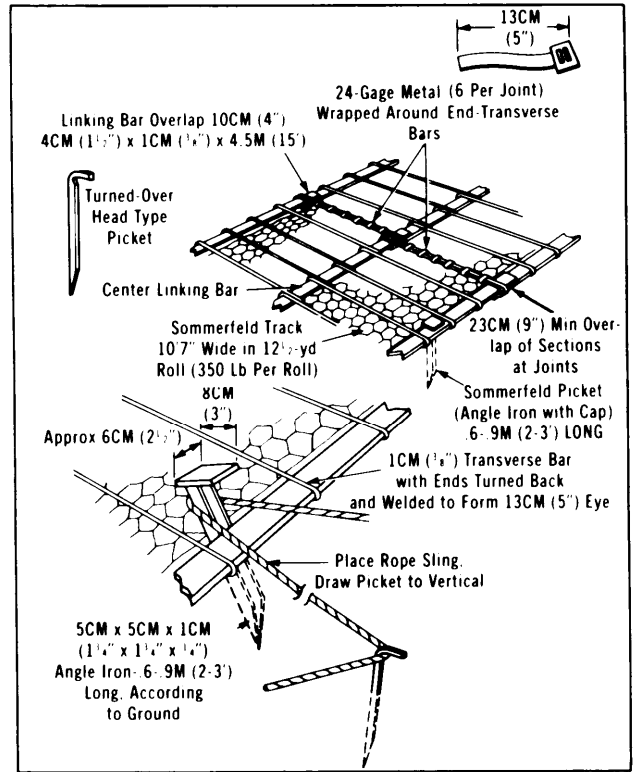

Figure 2-20. Component parts of Sommerfeld track

### Other types of surfaces

Surfaces can be constructed from rubble, bricks, concrete blocks, loose aggregate or gravel, and airfield matting (Figure 2-21).

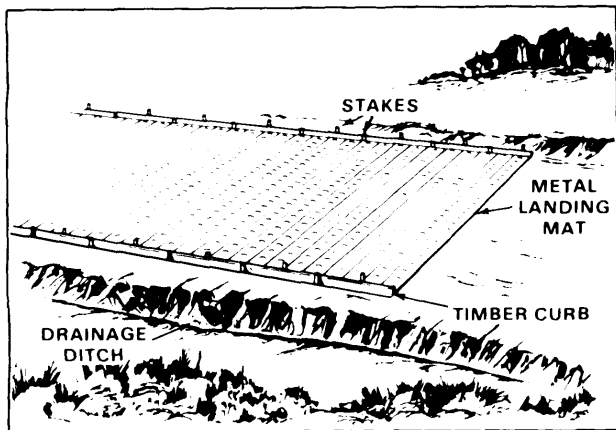

Figure 2-21. Other expedient surfaces

### Expedient Surfaces Over Sand

#### Wire mesh

Chicken wire, expanded metal lath, or chain-link wire mesh (cyclone fence) may be used for expedient surfaces over sand. The addition of a layer of burlap or similar material underneath the wire mesh helps to confine the sand. The edges of the wire mesh road must be picketed at .9 to 1.2 meters (3 to 4 feet) intervals. Diagonal wires crossing the centerline at 45° angles and securely attached to buried pickets fortify the lighter meshes. The more layers used the more durable the road will become (Figure 2-22).

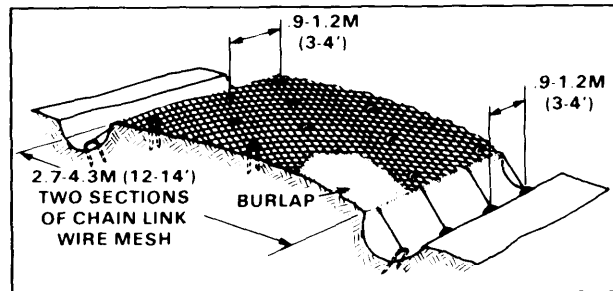

Figure 2-22. Construction details for a chain-link wire mesh road

#### Sand grid

See Figure 2-23 for a sand grid. Each grid section expands to cover an area 2.4 meters x 6 meters x 20 centimeters deep (8 feet x 20 feet x 8 inches). Use pickets or place sand on the corners and sides to maintain grid in place. A bucket loader may be used to fill in the grids. Use hand shovels to completely fill each grid. A full grid section will hold the weight of a bucket loader. This surface may be compacted using a rubber-tire or steel-wheel roller. A sand asphalt surface of about one gallon of RC-250 asphalt per square yard may be applied.

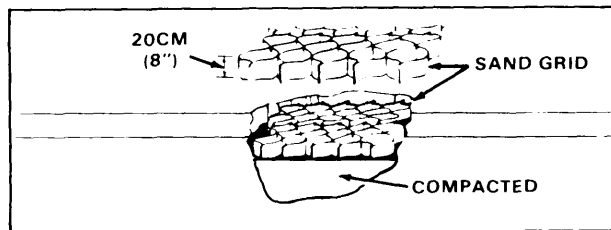

Figure 2-23. Sand grid

### Crater Repair

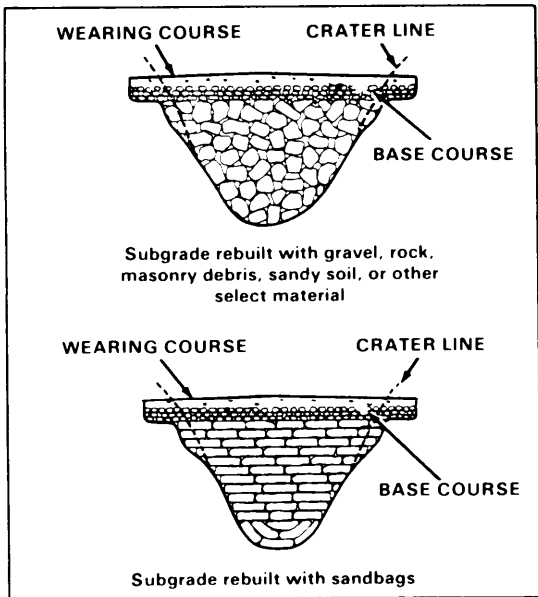

Figure 2-24. Crater repairs

FORWARD AVIATION

### Army Aircraft and Helicopter Characteristics

See Tables 2-10 and 2-11 (page 2-24).

Table 2-10. Army helicopter characteristics

NOMENCLATURE	NAME	LENGTH METERS (FEET)	ROTOR DIAMETER METERS (FEET)	HEIGHT METERS (FEET)	LOADED WEIGHT (1,000 LB)	EXTERNAL LOAD CAPACITY (1,000 LB) (NOTE)	CARGO WINCH CAPACITY (1,000 LB)
OH58 A/C	KIOWA	12.5 (41)	10.8 (35.4)	3.1 (10.2)	32*	—	—
CH47B	CHINOOK	30 (98)	18.3 (60)	5.7 (18.7)	40	20	3
CH47C	CHINOOK	30 (98)	18.3 (60)	5.7 (18.7)	46	20	3
CH47D	CHINOOK	30 (98)	18.3 (60)	5.7 (18.7)	50	28	3
CH54A/B	CRANE	27 (88.6)	22 (72.2)	7.5 (24.6)	47*	20/25	15/25
UH 1 B/C/M	IROQUOIS	16.1 (52.8)	13.4 (44)	3.9 (12.8)	9.5	3	—
UH 1 D/H/V	IROQUOIS	17.5 (57.4)	14.6 (48)	4.4 (14.4)	9.5	4	—
UH60A	Black Hawk	19.8 (65)	16.3 (53.5)	5.3 (17.4)	20.25	8	—
AH64	APACHE	17.4 (57.1)	14.6 (48)	3.8 (12.5)	17.4	6	—
AH15	COBRA	16.2 (53.1)	13.4 (44)	4.2 (13.8)	10	1	—

NOTE: Maximum lifting capability

\* Different for each model. Highest value represented.

**Table 2-11. Combat area airfield requirements**

AIRFIELD TYPE	ANTICIPATED SERVICE LIFE	POSSIBLE USING AIRCRAFT US TYPE (NOTE 1)	GROUND RUN AT SEA LEVEL AND 39° FEET (NOTE 2)	MINIMUM RUNWAY LENGTH FEET	MINIMUM RUNWAY WIDTH FEET
Battle area Light lift Medium lift	3 days	C-7A*	625	1,000	50
		C-130*	1,600	2,000	60
		C-123	1,600		
Forward area Liaison Surveillance Light lift Medium lift	2 weeks	O-1*	390	750	50
		OV-1*	2,000	2,500	60
		C-7A*	625	1,200	60
		C-130*	2,000	2,500	60
		C-7A	625		

**NOTES:**

1. Asterisk shows particular aircraft that is critical in load and/or ground run from which area requirements, geometrics, and expedient surfacing requirements were developed.
2. Ground run lengths indicated are for classification and can undergo changes depending on operating weight of aircraft, pressure altitude corrections, temperature corrections, and local conditions.

**General Construction of Forward Landing Zone or Airstrip**

Membrane or available timber may be used to construct an expedient hardened landing pad surface. Mark all obstacles in the landing zone or airstrip. Sprinkled water, lime, lime solutions, or oils will provide temporary dust control (Table 2-12). See Tables 2-13 and 2-14 and Figures 2-25 through 2-27 (pages 2-25 through 2-27) for landing zones and helipads geometric requirements.

**Table 2-12. Dust control requirements for heliports**

AREA	DIMENSION OF AREA REQUIRING DUST CONTROL (FEET)		
	UH-1D IROQUOIS	AH-1G HUEY COBRA	CH-47A CHINOOK
Taxi hoverlane and parking pads	75	80	150
Takeoff and landing areas	132	150	295

**NOTE:**

Measurements are taken from the center of rotation of the controlling aircraft and are approximately equal to the radius of the area affected by the rotor downwash.

**Table 2-13. Minimum geometric requirements for landing zones**

ITEM NO	DESCRIPTION	FORWARD AREA			
		OH-58	AH-1G	UH-1H	CH-47
<b>LANDING PAD AND LANDING AREA</b>					
1	Length, feet	15	20	20	50
2	Width, feet	15	20	20	25
3	Landing area length, feet	84	100	100	150
4	Landing area width, feet	84	100	100	125
5	Parking pad grade in any direction, maximum	3	3	3	3
6	Lateral clearance from rear and sides of parking pad to fixed and/or movable obstacles except other aircraft, feet	30	45	45	65
7	C-C spacing of parking pads, feet	50	75	75	150
8	Spacing from edge of taxi hoverlane to edge of parking pad, feet	30	45	45	65



**Table 2-13.** Minimum geometric requirements for landing zones (continued)

ITEM NO	DESCRIPTION	FORWARD AREA			
		OH 58	AH 1G	UH 1H	CH 47
<b>TAXI HOOVERLANE</b>					
9	Width, feet (Note 1)	90	140	140	180
10	Longitudinal grade of taxi Hooverlane, % maximum	10	10	10	10
11	Transverse grade of taxi Hooverlane, % maximum	5	5	5	5
<b>HELIPORT APPROACH AND DEPARTURE ZONE</b>					
12	Approach departure surface ratio	10:1	10:1	10:1	10:1
13	Length, feet	1,500	1,500	1,500	1,500
14	Width, feet				
	a At end of clear zone of taxi Hooverlane	90	140	140	180
	b At outer end	850	850	850	850
<b>HELIPORT TAKE-OFF SAFETY ZONE</b>					
15	Length, feet	500	500	500	500
16	Width, feet	SAME AS APPROACH DEPARTURE ZONE			
<b>SERVICE ROADS</b>					
17	Width, feet (Note 2)	115	115	115	115

NOTES: 1. Taxi Hooverlane is used for take-off and landing.  
 2. Roads should be located so as to require the least effort.

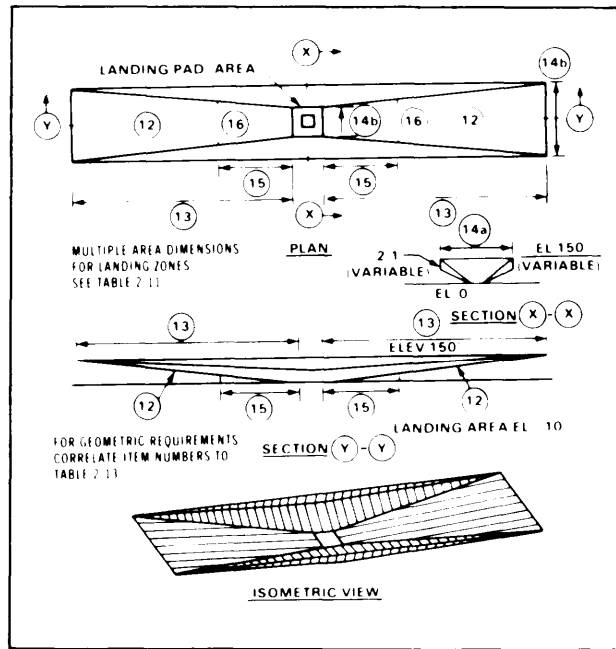

**Figure 2-25.** Geometric layout of landing zones

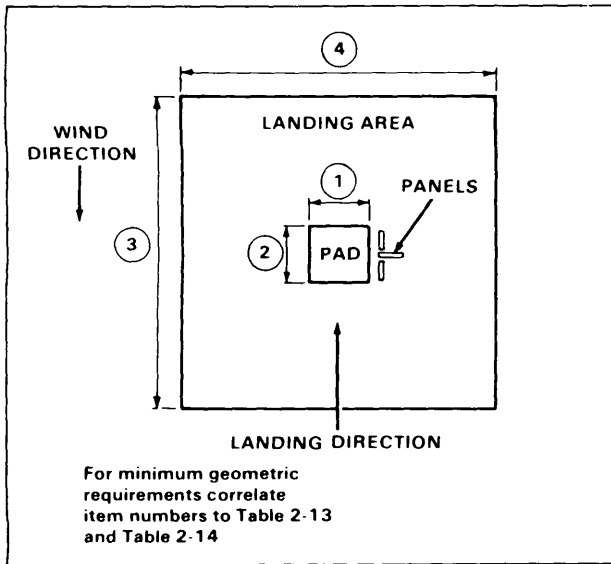

Figure 2-26. Panel layout of landing zones

Table 2-14. Minimum geometric requirements for multiple area landing zones

ITEM NO	DESCRIPTION	FORWARD AREA	
		UH-1	CH-47
1	One-ship landing zone		
	Length	100	150
	Width	100	125
2	Two-ship trail landing zone		
	Length	180	250
	Width	100	125
3	Two-ship side-by-side landing zone		
	Length	100	150
	Width	170	220
4	Three-ship trail landing zone		
	Length	260	375
	Width	100	125
5	Four-ship side-by-side trail		
	Length	180	250
	Width	170	220

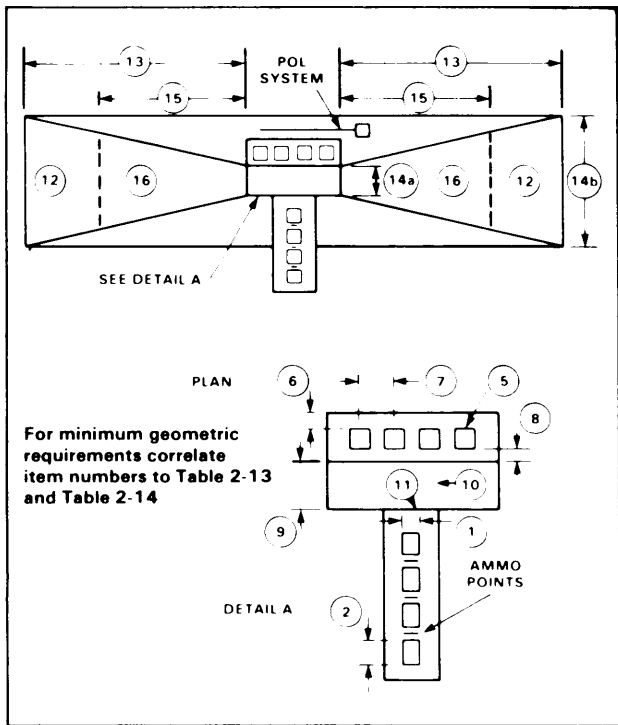

Figure 2-27. Geometric layout of forward area refueling and rearming heliports

### Maintenance and Repair

Maintenance and repair operations must be coordinated with tactical operations. Work should be done at night. Hazardous equipment must not be left on landing zone. Area under construction or repair must be clearly marked. Mud must be continuously removed. Remove all debris away from traffic and landing area for repair of all mats and membrane surfaces, see Chapter 8. Replace damaged timber and level accordingly.