

EDUCATIONAL SEISMOGRAPH

Lawrence W. Braile⁶

(February, 2001)

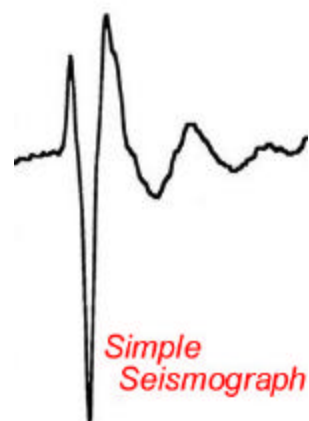

Objective: Construct a simple seismograph for use in educational activities and demonstrations. Use the seismograph to demonstrate how a seismograph works, for "make your own earthquake" activities, and to demonstrate, using weight drop experiments, the concepts of magnitude and intensity.

Introduction: A simple and inexpensive seismograph can be constructed from readily available parts and components. The seismograph has all of the components (sensor, amplifier, digitizer display) of more complex research-quality instruments except for accurate absolute time. Because of the limited data storage of the instrument and the lack of accurate absolute time, the seismograph is not intended for use in long-term monitoring of earthquakes. However, it can be used very effectively for educational purposes. Two of the required components (for the Vernier Serial Box Interface or LabPro Interface and LoggerPro software option) are also useful for other equipments and activities using a variety of sensors available from Vernier Software (www.vernier.com).

Constructing the Seismograph: The educational seismograph (Figure 1) is constructed from commercial components (geophone, Vernier Serial Box Interface, SBI; and LoggerPro software installed on a computer) and a homemade electronic circuit (Figures 2 and 3). The electronic circuit can be built from simple electronic parts (Table 2) as shown in the construction details illustrated in Figure 3. Because of its high frequency response and low cost, a commercial geophone (see information in Table 1) is a good choice for the sensor. The principles of the seismometer (including the geophone) can be illustrated with the handheld seismometer and magnet and coil activities (<http://www.eas.purdue.edu/~braile>). The circuit, SBI and LoggerPro software can also be used to record and display the output of the handheld seismometer. The SBI (or LabPro) interface, with an attached Vernier accelerometer, and the LoggerPro software are also useful in shake table and earthquake shaking simulation experiments. Other options for construction are described in Table 1. There are several "trade-offs" involved in the choice of the interface and recording software (Table 1). The Dataq option is the lowest priced option, but is not compatible with the many sensors (probes) that are available for use in other experiments. For the Vernier interfaces, the SBI is the least expensive option but the newer LabPro interface has significantly greater capability (higher sampling rate, accepts

plus and minus voltage input, USB interface, and the ability to record data when not attached to a computer).

Using the Seismograph: Once the seismograph is working properly, you can use it for a number of activities.

Stomp Test: For the "stomp test" (a good test to be sure that the instrument and recording software are working and a demonstration of the response of the seismograph to a simple input), place the geophone on the floor using a wood block with a hole to hold the geophone upright. Standing about a meter from the geophone, stomp on the floor with one foot to create a short vibration. An example of the output seismogram for a stomp test is shown in Figure 4.

Make Your Own Earthquake: Each person or small group can stand about 2-3 m from the geophone and jump up and down. If desired, one can save the "seismogram" from each make your own earthquake shaking experiment and print it out to document the "earthquake." To make a useful seismic record for this experiment, limit the record time to about 10-20 seconds. Using the LoggerPro software, it is also possible to zoom in on the signal to make the details of the seismogram more visible.

Weight Drop Experiments: Weight drop experiments can be used to illustrate wave propagation from the source to the seismograph and the concepts of magnitude (size) of an earthquake and intensity (degree of shaking) at a location. Both the magnitude of the source and the distance from the source influence the amplitude (intensity of shaking) of the seismogram. The weight drop experiments are best performed outside in a grassy area. A laptop computer will make recording outside of a building easier. (The SBI interface requires power, so a location near a power outlet is required. Alternatively, a battery power supply for the SBI is available from Vernier that will make the system, with laptop, independent of AC power. The LabPro interface also solves this problem.) The weight drop experiments can be conducted in a building, but the solid nature of concrete slab floors (if the first floor or basement) makes it difficult to generate seismic waves. On second and higher floors, oscillations of the entire floor can obscure the waves generated by the source that propagate to the geophone.

To make a weight for the weight drop experiment, obtain an old or inexpensive basketball. Cut a 5 cm diameter hole around the air valve of the basketball. Place a heavyweight plastic bag in the basketball so that the opening of the bag extends out the hole in the basketball. Fill the bag (and the basketball) with dry sand. Seal the plastic bag with a rubber band and stuff the excess plastic bag into the basketball. Using the sand-filled basketball, one can generate seismic waves by dropping the ball from various heights onto the ground or floor.

For the first weight drop experiment, place the geophone in the ground (spike inserted into ground) and position the source location about 5 m away. With the recorder on, drop the sand-filled basketball from three different heights. An example using heights of 0.1, 0.6 and 2.0 m is shown in Figure 5. Because the source is of relatively high frequency (about 10-30 Hz or cycles per second) and the SBI interface has a fairly low sampling rate (maximum of 50 samples per second, sps), there is some distortion in the recorded signals. However, it is clear that the amplitude of the seismogram is larger for

a larger source (weight dropped from larger heights). The height of the weight drop (energy released) is analogous to earthquake magnitude. From this experiment one can see that the amplitude of a seismogram depends on the magnitude (size, or amount of energy) of the source.

For the second weight drop experiment, measure out three distances from the geophone. Drop the sand-filled basketball from the same height at each of these distances. An example for a drop height of 2 m and distances of 5, 10 and 20 m is shown in Figure 6. Notice that the amplitude of the signals from the three weight drops is very dependent on the distance of the sensor (geophone) from the source. In terms of intensity, one can see that the intensity of shaking (amplitude of the seismogram) for the same size earthquake is controlled by how far away the sensor (or a person) is from the source. The two weight drop experiments demonstrate that both amplitude of the signal and distance from the source for a recorded seismogram must be considered when determining the magnitude of an earthquake. Magnitude and intensity are two measures commonly used to describe earthquakes. However, they are measures of different effects. It is possible to have small intensity (of shaking) for a large earthquake if the distance from the source is large. It is also possible to have fairly large intensity, even for a small earthquake, if one is very close to the epicenter. The only situation in which magnitude and intensity data are directly comparable (for use in measuring the size of the source) is comparing magnitude and maximum intensity (or intensity near the epicenter). In this case, the maximum intensity is a measure of size of the earthquake and can be used to estimate magnitude.

Handheld Seismometer: The educational seismograph can be used with the handheld seismometer as the sensor to record the shaking of the handheld seismometer (or the magnet and coil assembly) to illustrate how a seismometer works and the response of the instrument to motions of the ground. An example of a seismogram using the educational seismograph and the handheld seismometer (<http://www.eas.purdue.edu/~braile>) is shown in Figure 7.

Table 1. Options for Simple and Inexpensive (less than \$500) Educational Seismographs

Number	Sensor ² (Input)	Interface ⁵ (Amplifier/ Digitizer)	Software ⁵ (Output)	Comments on Interface and Software
1	Handheld Seismometer (www.eas.purdue.edu/~braile)	Vernier Serial Box Interface (~ \$100) and Homemade Circuit (~ \$20)	Vernier LoggerPro (~ \$65, WIN or MAC)	2 Channel, 12 bit A/D (Analog to Digital converter), inexpensive, SBI and LoggerPro can also be used with many Vernier probes for additional experiments and educational activities, requires homemade circuit for use with seismic sensors, maximum sample rate is 50 sps, serial interface.
2	Homemade Seismographs ³	Vernier LabPro Interface (~ \$220)	Vernier LoggerPro (~ \$65, WIN or MAC)	4 Channel, 12 bit A/D, LabPro and LoggerPro can also be used with many Vernier probes for additional experiments and educational activities, does not require homemade circuit, maximum sample rate is 50,000 sps, serial or USB interface, also allow data collection without being connected to a computer.
3	Commercial Geophone ⁴ (~ \$50)	Dataq DI- 15ORS Data Acquisition System (~ \$100)	Dataq WinDaq/Lite (Free)	2 Channel, 12 bit A/D, maximum sample rate is 240 sps, software is free, interface is available online or at Radio Shack.

¹Commercial, "turnkey" educational seismographs (these seismographs, and the Dataq interface and software, can be used for long term monitoring of earthquakes) can be obtained from:

KMIdirect, Earthscope PC-based seismograph, \$495, with 4.5 Hz geophone,
<http://www.kmidirect.com/>

Amateur Seismologist, AS-1 seismograph, ~ \$500, 1 Hz seismometer,
<http://www.primenet.com/~seismo/>

Personal Seismograph Station, 1-Channel, ~ \$300, 3-Channel, ~ \$600, with 4.5 Hz geophones,
<http://www.geotool.com/geoiseis.htm>

(All of the seismographs and interfaces and software mentioned in this table use the computer's clock to determine time. Computer clocks can be synchronized daily to monitor drift by listening to WWV radio broadcasts at 5, 10 , or 15 MHz, or by periodic, automatic synchronization of the computer clock through an internet connection using the software AboutTime from <http://www.arachnoid.com/abouttime/>.)

²Any sensors can be used with the three interface and software options.

³See the following websites for information on building your own seismograph:

<http://lasker.princeton.edu/BuildSeismos.html>

http://www.eas.purdue.edu/k-12/seismology_resources.html

<http://cse.ssl.berkeley.edu/lessons/indiv/davis/hs/Seismograph.html>

<http://psn.quake.net>

⁴Information on commercial geophones:

<http://www.giscogeo.com/pages/seixgph.html> (10 Hz geophone, SDJ7V10, \$37)

<http://www.geoseismic.com/geophones.htm>

<http://www.geospacelp.com/g20dx.htm> (8 Hz, vertical component geophone)

Used, surplus geophones may be available by contacting your local university.

⁵Interface and software information can be found at:

Vernier: <http://www.vernier.com>

Dataq: <http://www.dataq.com>

Table 2. Parts List for Amplifier Interface Circuit to Connect to SBI (Figure 1).**Parts for Interface Circuit:** (most parts available from Radio Shack or other electronics suppliers)

1 – ICL 7660	Integrated Circuit (IC), voltage control (if you can't find the ICL 7660 locally, order from Digikey, part ICL766-CSA-ND, \$2.86, www.digikey.com , or from Mouser Electronics, www.mouser.com , 800-346-6873)
1- IC 741	IC – Op Amp, general purpose operational amplifier
3 – 10 F	Capacitors
1 – 47k Ohm	resistor (yellow-violet-orange)
1 – 180k Ohm	resistor (brown-grey-yellow)
1 – 2.2k Ohm	resistor (red-red-red)
1 – 1 Meg Ohm	potentiometer (variable resistor; use to adjust zero line of output)
9 – wire leads	[2 input wires (~ 15 cm), 3 wires (~ 6 cm) from DIN plug (solder to black, red and white stranded wire from DIN patch cord), 4 short (6 cm) jumper wires; #22 insulated, solid copper wire, stripped (~ 1 cm) at both ends]
1 – plastic box, 6 cm x 11 cm (three holes drilled)	(Radio Shack Part #270-221)
1 – experimenter's board	(Radio Shack Part #276-175)
1 – geophone with alligator clips from the two output wires	(attach to input wires of Interface Circuit Box), (see Table 1)
1 – DIN plug and cord (black; ground, red: + 5V (pin 7 on 741IC, white: out to SBI pin 6 on 741IC)	(Radio Shack Part #42-2151, ~ 2 meter patch cord with 5-pin DIN plug on each end, cut in half, use one end)

Other Parts (also, see Table 1):

- 1 – Vernier SBI interface (MAC or WIN)
- 1 – Vernier LoggerPro Software (MAC or WIN)
- 1 – Wood block (2" x 4" x 6") with hole for spike for geophone (for use in laboratory or classroom, use spike in ground outside)

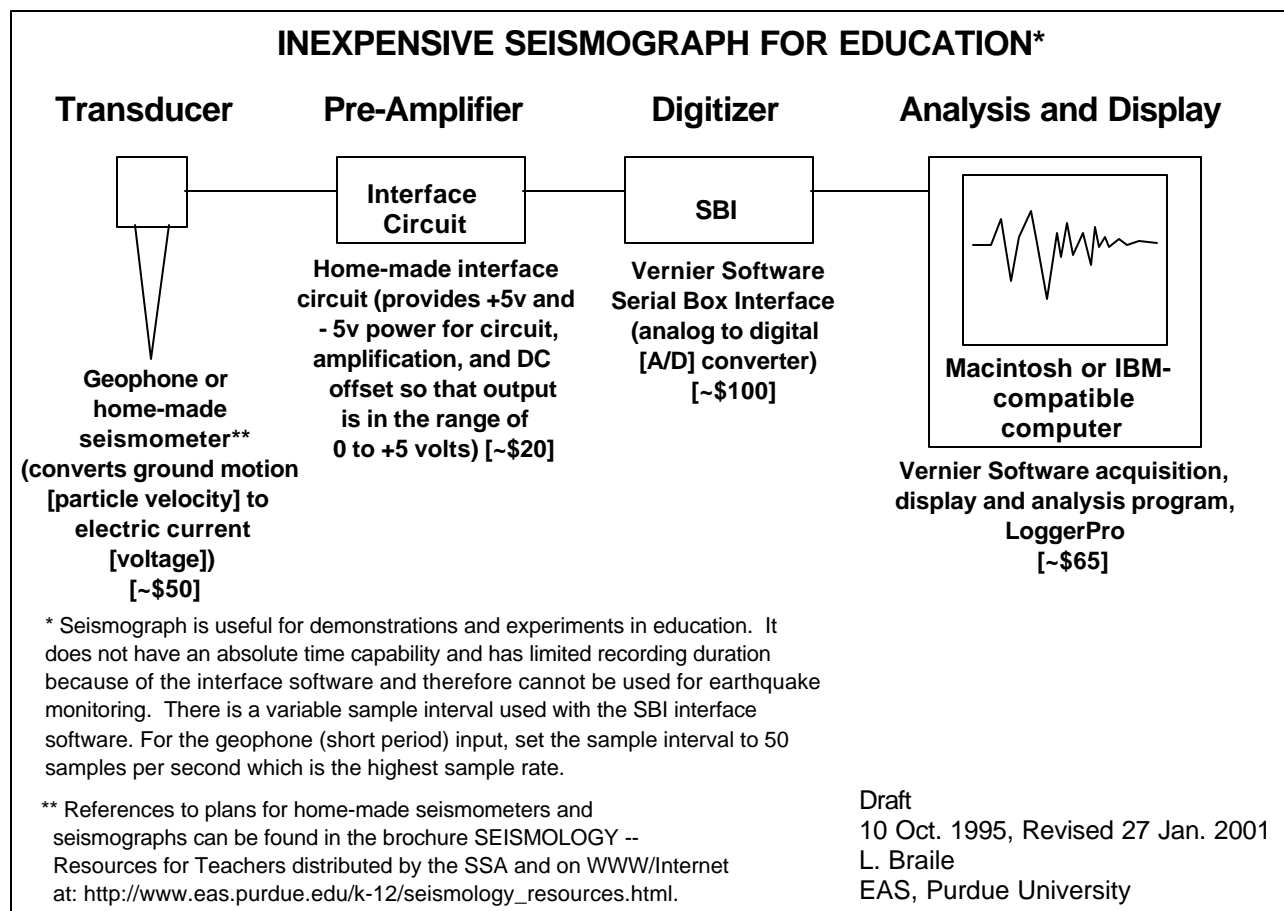

Figure 1. Schematic diagram illustrating the components of an inexpensive seismograph for educational purposes. The system that is illustrated here utilizes a commercial geophone sensor, a homemade amplifier circuit and the Vernier Serial Box Interface (SBI). The system has the advantages of being relatively inexpensive, providing the opportunity to build a working circuit for one component of the system, and using the SBI interface and LoggerPro software which can also be used for a wide variety of other experiments and educational activities using sensors and probes ("probeware") available from Vernier (www.vernier.com). Other options are described in Table 1.

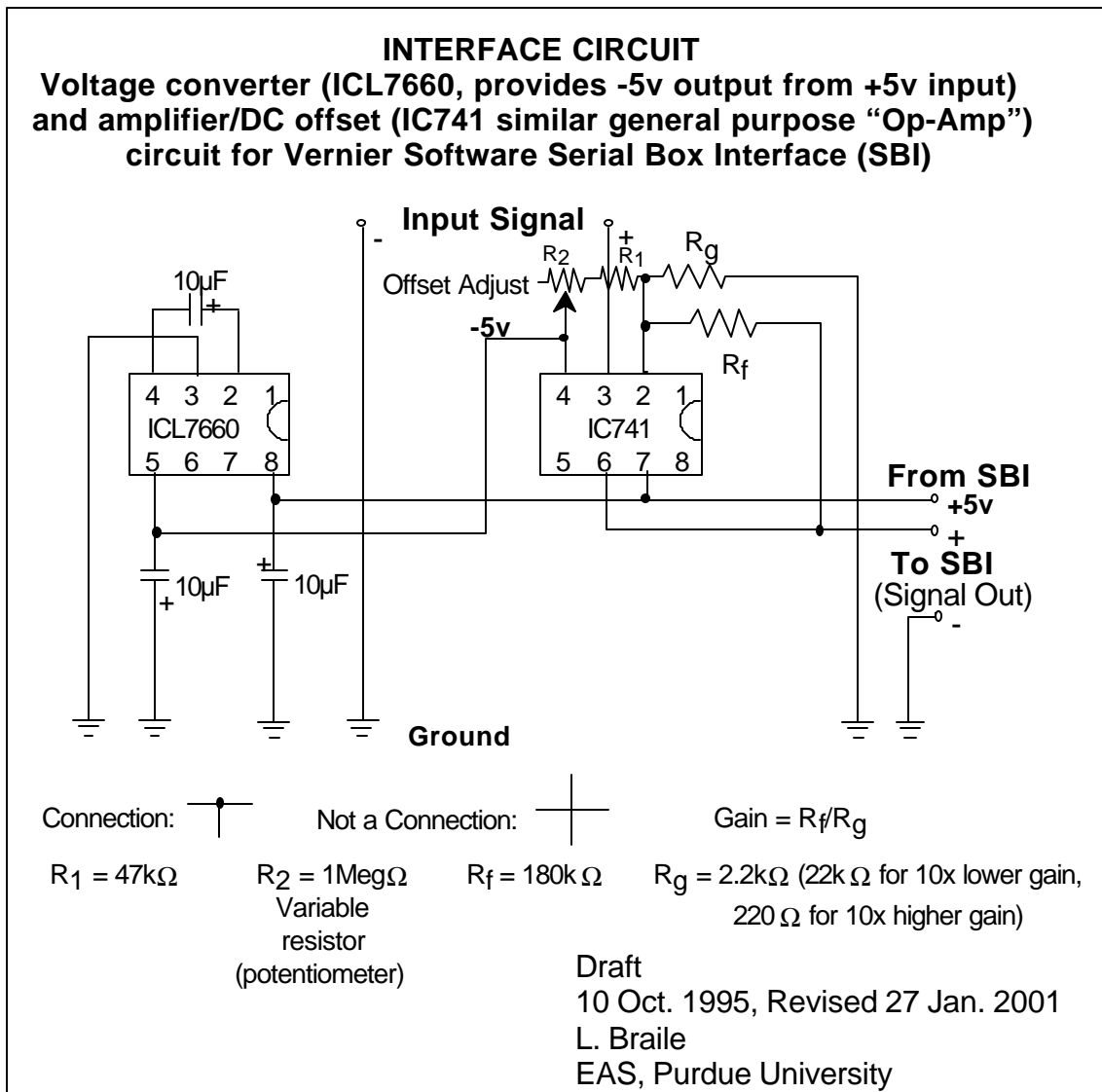

Figure 2. Interface circuit that provides amplification of the sensor output and a DC offset of the signal for input to the SBI interface. Construction information is provided in Figure 3 and a parts list is given in Table 2.

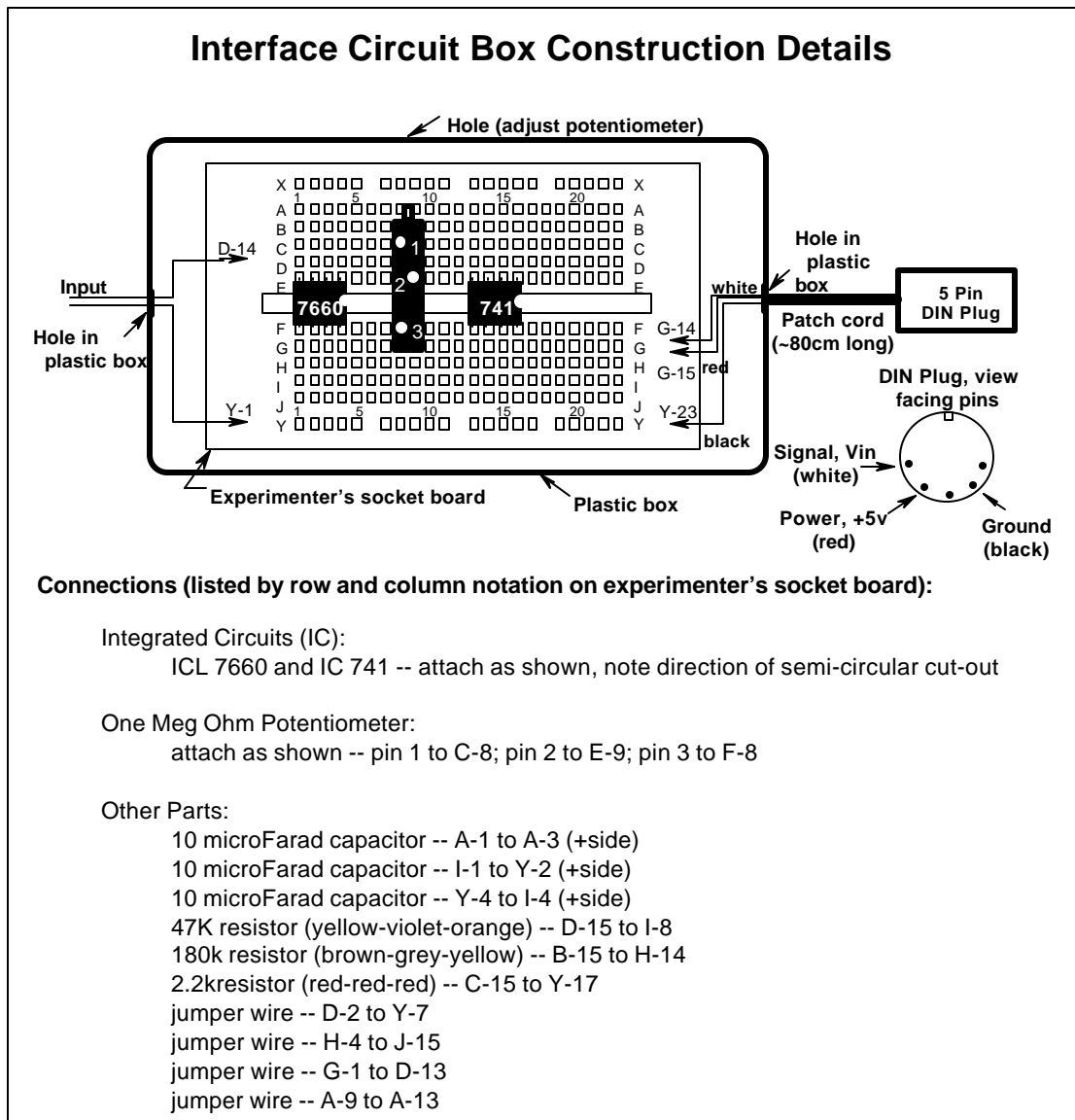

Figure 3. Interface circuit box construction details. Parts list is given in Table 2. Care must be taken to attach components and wires to the socket board exactly as shown.

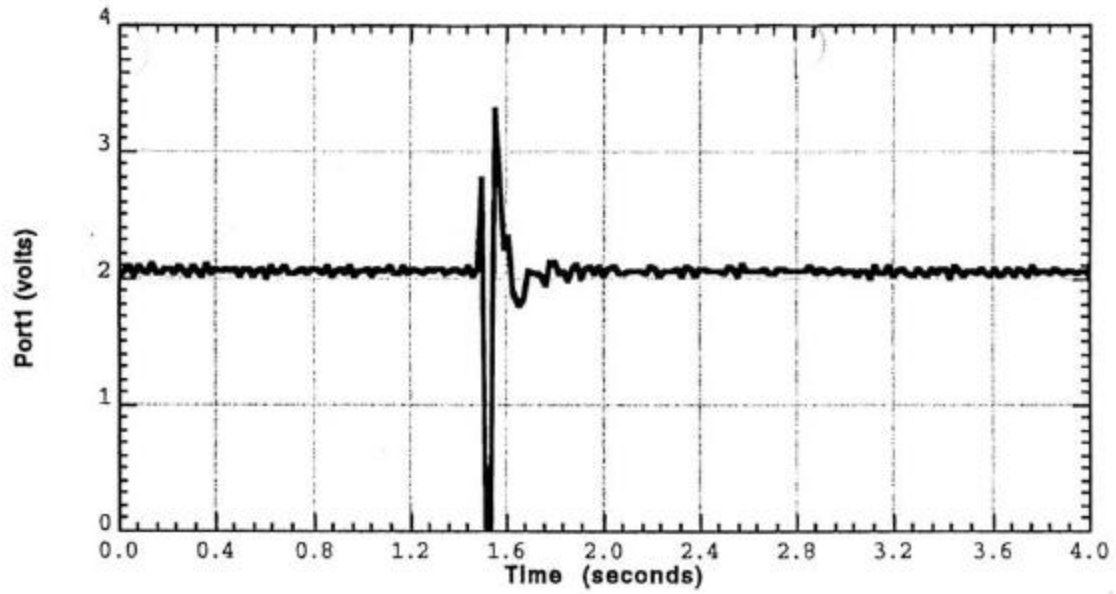

Figure 4. Output of the seismograph (using a 4.5 Hz geophone and the LoggerPro software) for a "stomp" test.

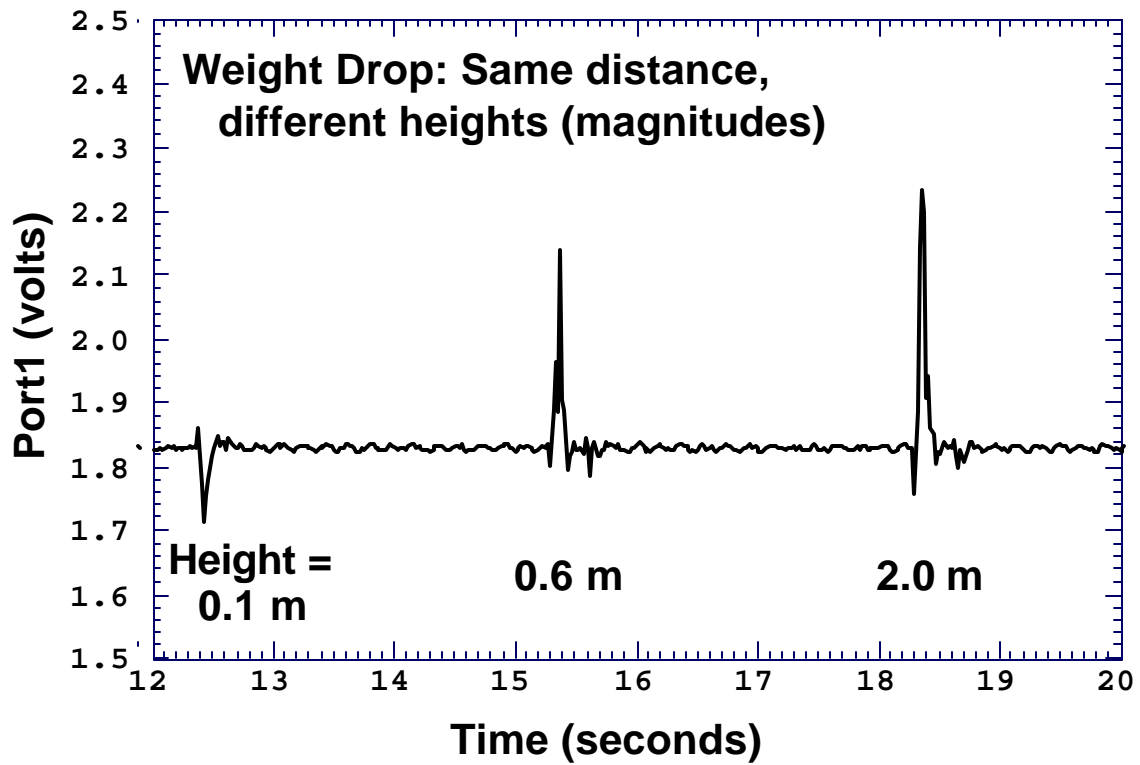

Figure 5. Output seismograms for a weight drop experiment in which the weight is dropped from different heights (same distance from the sensor).

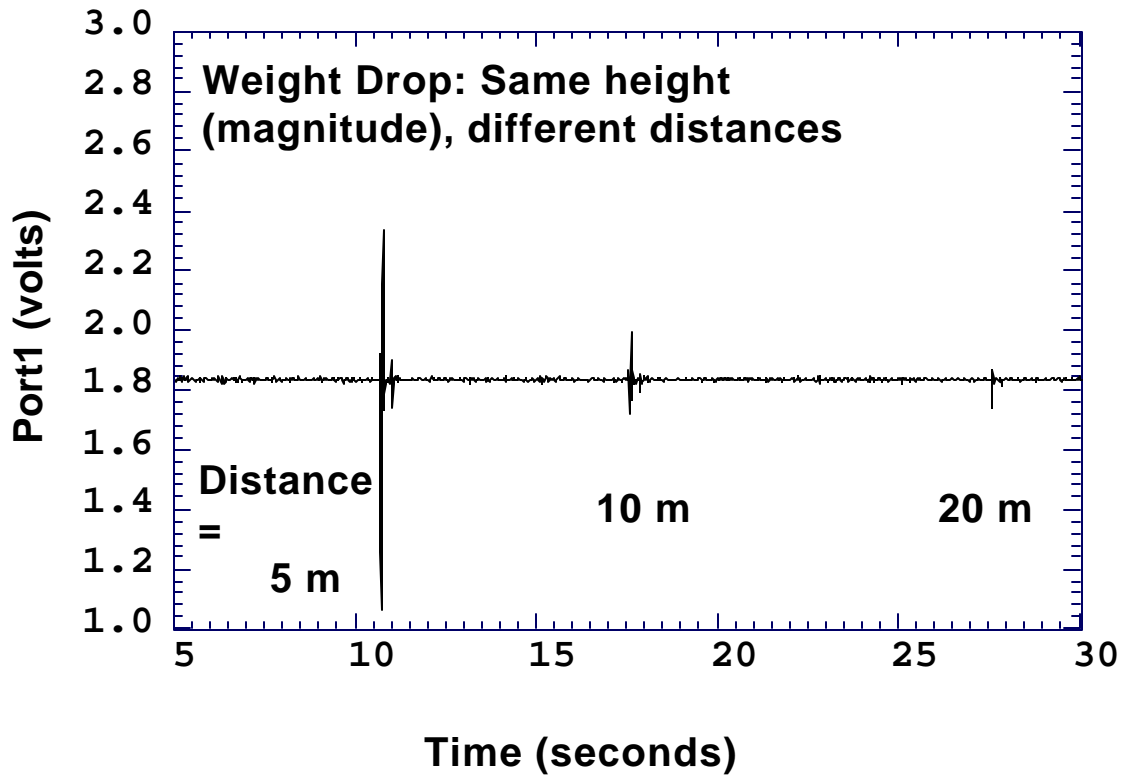

Figure 6. Output seismograms for a weight drop experiment in which the weight is dropped from the same height but at different distances (5, 10, 20 m) from the sensor.

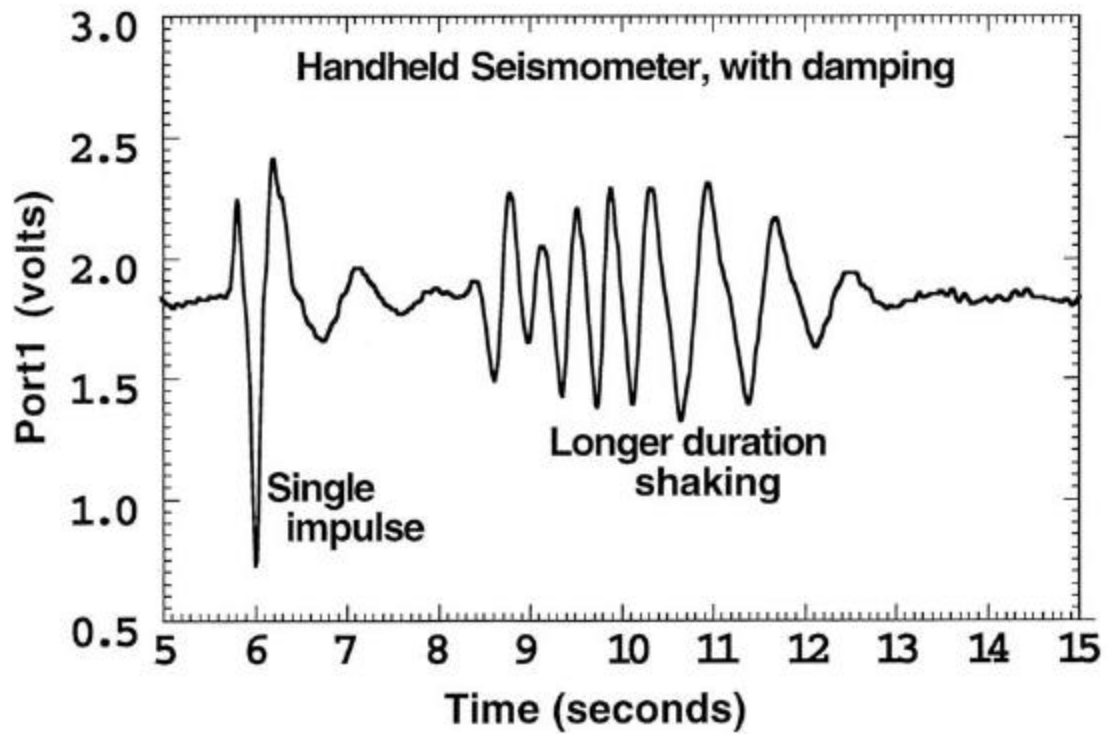

Figure 7. Seismogram produced by shaking the handheld seismometer (connected to the circuit and SBI interface as illustrated in Figure 1 and recorded on the LoggerPro software) with a simple impulse (with an initial "up" motion) followed by several cycles of up and down motion.